



ENCYCLOPEDIA

OF

MAGIC

Copyright 1978  
Magic, Inc.  
Chicago, Ill., 60625

Second Printing, 1985  
Third Printing, 1991

Martin Gardner



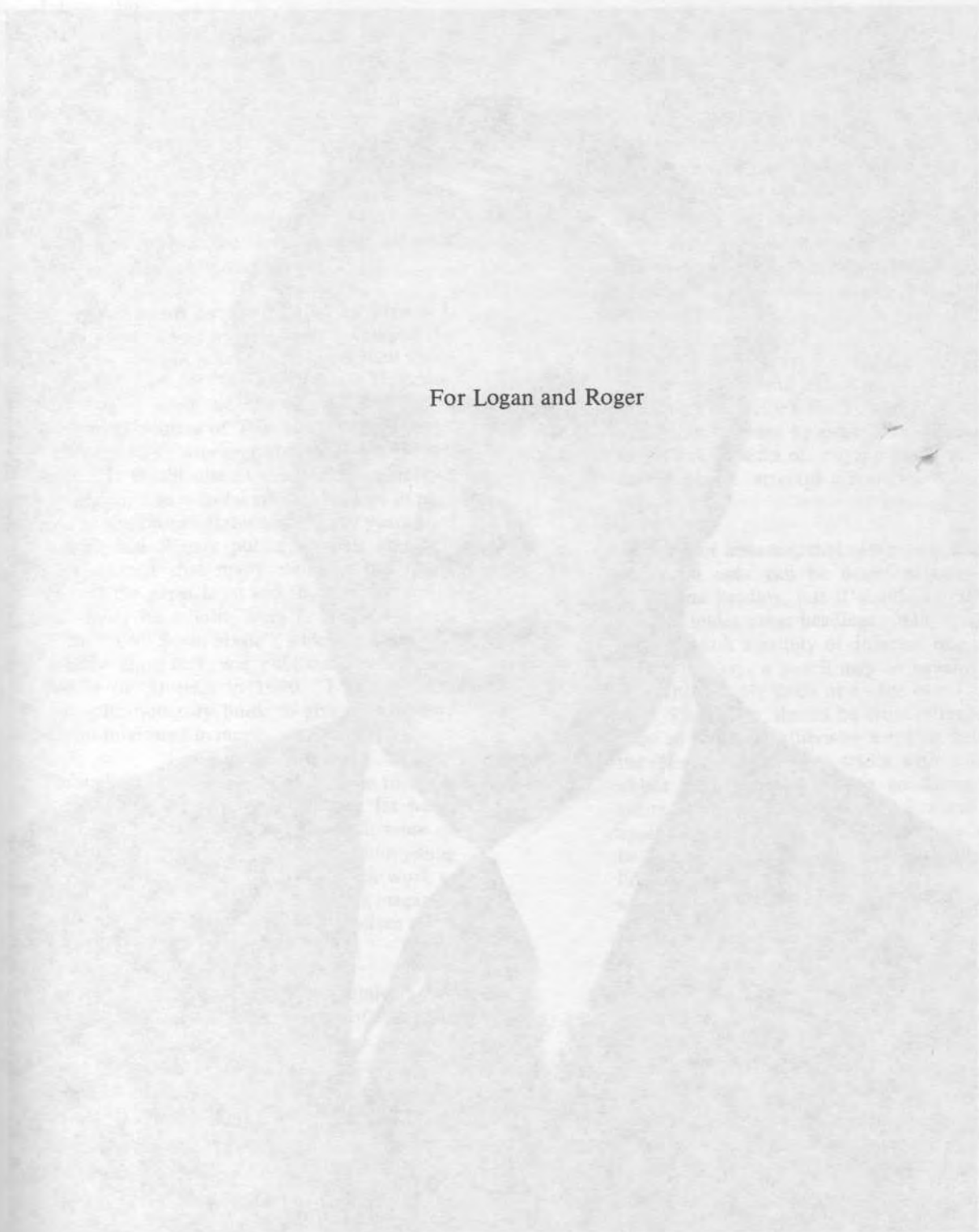

For Logan and Roger

MARTIN GARDNER

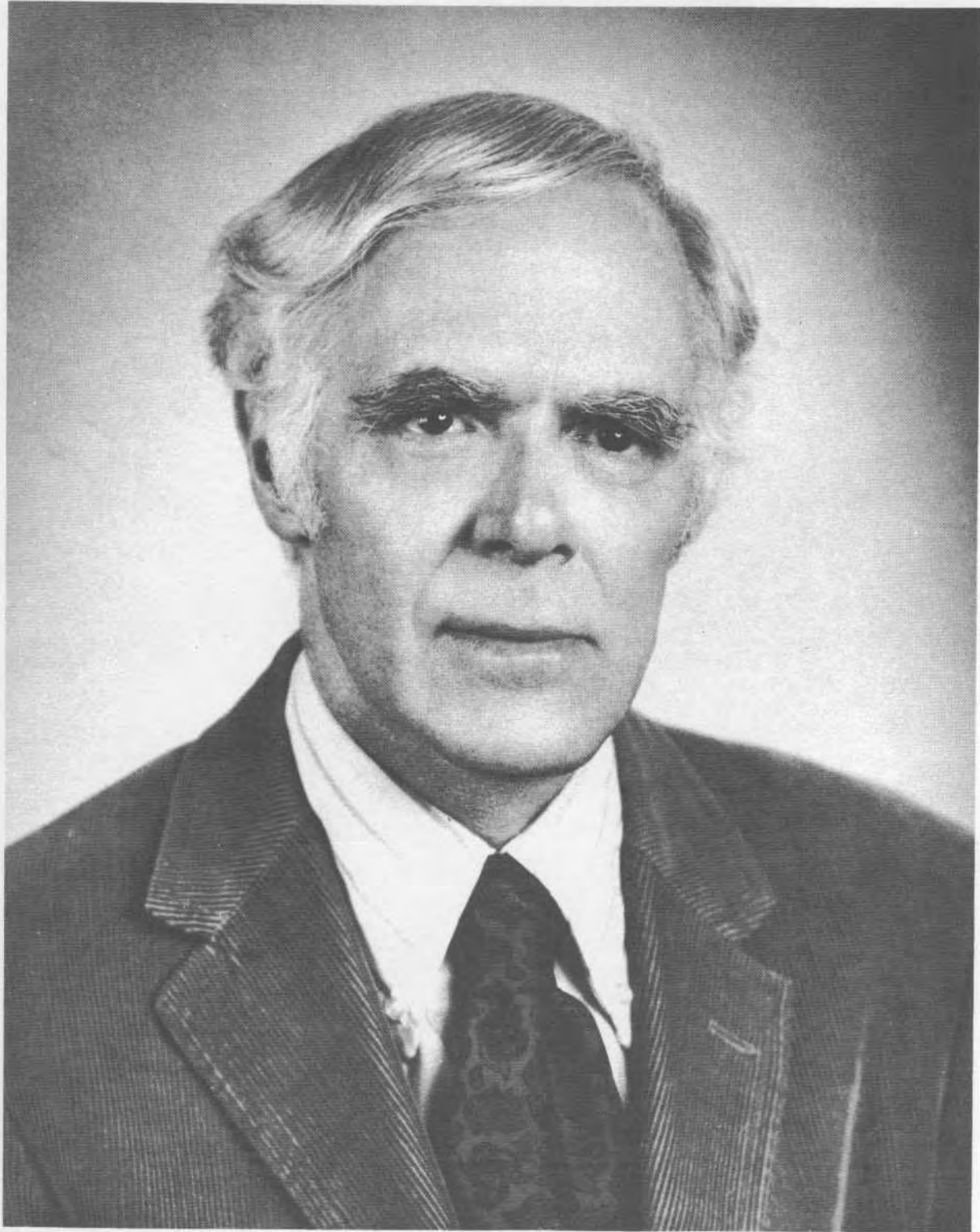

MARTIN GARDNER



## Introduction

The "Encyclopedia of Impromptu Magic" first appeared as installments in "Hugard's Magic Monthly" from Vol. 8, No. 10, March 1951 through Vol. 15, No. 11, April 1958. I had started a regular column in HMM a few years earlier (October 1948) but those previous columns were not limited to impromptu tricks and many of them dealt with card effects which were omitted entirely (for obvious reasons) from the "Encyclopedia."

All the columns were illustrated by Francis J. Rigney. As a boy in Oklahoma, I enjoyed the monthly pages of jokes which Frank then wrote and illustrated for "American Boy's Magazine, and I also knew of him as co-author with William D. Murray of "Fun with Paper Folding" (Revell, 1928), later reprinted as a Dover paperback. It is still one of the best introductions to origami, the oriental art that became so popular in the United States some thirty years after Murray and Rigney published their book. I later learned that many items in this book, such as the paper horn and the fish that opens and shuts its mouth, were Frank's own creations. "Cub Scout Magic", which he wrote and lavishly illustrated, was published by the Boy Scouts of America in 1960. I know of no better introductory book to give a young boy who is interested in magic.

Through my column in HMM I came to know Frank and his charming wife, Ella. He was a whimsical, gentle man, with an Irish sense of humor and a love of magic that kept him young throughout his life. His long years of work as the sole illustrator for Jean Hugard's magazine was surely a labor of love that deserves to be remembered.

I, too wrote my "Encyclopedia" mainly for the fun of it, and to get into some sort of shape the thousands of notes I had scribbled over the years on three-by-five file cards which I kept in the ladies' shoe boxes until I could afford sturdier files. It was written quickly and carelessly, in an annoying telegraphic style intended to compress as much as possible into the allotted space, and with almost no attempt to research the magic literature. I gave sources and credits only if I happened to know them, making little effort to seek for information beyond what I found on my file cards.

Even the word "impromptu" was used loosely. By and large the material was limited to tricks with ordinary objects calling for no special apparatus, gimmicks or advanced preparation. In many cases, however, if the required preparation was minor and a trick appeared impromptu, it was included. Card tricks were left out, as well as rope tricks, nor was it possible to cover the vast fields of sleights involving such objects as coins, cigarettes and thimbles, although tricks with those objects were included.

I hoped that someday I might find time for extensive revisions and additions. I would obtain entry to a collector's library and plow through all his books, page by page. I would spend at least a few months on major periodicals. After that, I would attempt a comprehensive cross index.

A trick, for instance, that uses a glass, handkerchief and coin can be described only once, under one heading, but it should be cross referenced under other headings. Many tricks can be done with a variety of different objects. A trick with, say, a pencil may be equally effective with a table knife or a cane or a fountain pen. These, too, should be cross referenced as fully as possible; otherwise a reader searching the "Encyclopedia" for tricks with a certain object would be forced to go through the entire work if he wanted to run down all tricks applicable to that object. Also there should be cross indexing under such categories as Practical Jokes, Bethchas, Mental Effects, and so on, that would cut across listings by the object used.

After cross indexing I planned to send a copy of the manuscript to several well-informed magicians in the hope that they would look it over, correct errors, and supply new items. Stewart James, for example, to whom I occasionally wrote for help, always responded with such amazingly detailed information that I am sure his files on magic must be among the largest and best organized in the world.

None of those hopes could be fulfilled. The years sped by and I became sidetracked by other things.

When Jay Marshall asked if he could reproduce the "Encyclopedia" by photo-offset, the suggestion came as a huge relief. I have made no attempt to rewrite what was printed before except for making small corrections here and there. Much new material, some requiring new art, has been added; material that had accumulated in my files since the series in HMM ended. These new items have in most instances been inserted as a, -b, c, etc., to avoid the renumbering that would require costly type resetting. Some new suggestions have been appended to old items, here and there new references have been added, and some material, from my HMM column before the "Encyclopedia" began, has been wedged into appropriate crevices.

The work remains patchy and slovenly. It makes no pretense at completeness. Excellent impromptu tricks are missing because I happened not to come across them. Inventors are not mentioned because I did not know who they were; Some tricks, no doubt, are incorrectly credited. A number of items, how many I cannot say, are of my own devising, but I have made no effort to identify them.

The book contains many tricks and stunts that were first shown to me in my late teens by Werner ("Dorny") Dornfield. I then lived in Chicago where many happy hours were spent with the old "Round Table" crowd at a time when, under Dorny's aegis, it gathered late at night at the Nanking Chinese restaurant on Randolph Street. To be a friend of Dorny in those depression days was one of the great privileges of my youth, and I am proud to acknowledge my debt to him.

Here it is then, with all its glaring imperfections. I hope there are readers who will find it useful. Perhaps at some future time I or someone else can bring it a bit closer to that monumental reference work of which I originally dreamed.

Martin Gardner

Lord Loam: By the way, Brocklehurst, can you do anything?

Lord Brocklehurst: How do you mean?

Lord Loam: Can you do anything - with a penny or a handkerchief, make them disappear, for instance?

Lord Brocklehurst: Good Heavens, no.

Lord Loam: It's a pity. Everyone in our position ought to be able to do something - -

James M. Barrie



APPLES

COMMENTS AND ADDITIONS

1. Strength feat: to break apple in half with bare hands. Secretly run thumb nail around apple, breaking skin. Twist the halves in opposite directions.

Source:

Date:

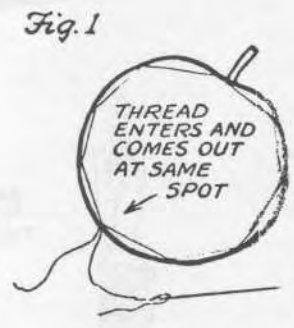

2. Apple is peeled and found to be cut in half. Prepare beforehand by stitching thread around apple (Fig. 1). Pulling out the thread will cut apple without damaging peel.

3. Party game. Two lines are formed, alternating boys and girls in each. Leader holds apple under chin. Apple is transferred along line from chin to chin, without using hands. Line to finish first wins.

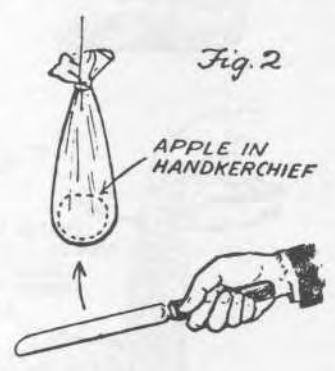

4. Magician extinguishes small burning candle, proceeds to eat entire candle. Candle is carved from apple. Wick is piece of almond.

5. Apple is suspended in handkerchief ( Fig. 2). A quick blow as shown, with sharp knife, will halve apple without injuring cloth.

6. A curious way of dividing an apple into two identical parts. The first vertical cut is made halfway down from top. The second vertical cut, at right angles to first, is halfway up from bottom. Horizontal cuts are then made for two opposite quarter sections. Fig. 3 shows one of the halves which results.

Fig. 3



## COMMENTS AND ADDITIONS

Source:

Date:

7. In ducking for Halloween apples, secret is not to bite apple, but place lips against side and hold by suction.

8. Problem: to halve apple without touching apple or knife. Suspend apple by string from lintel of doorway. On floor directly beneath (determine spot by letting water drip from apple) arrange knife, blade upward. Burn string. Apple falls on blade and is cut in half.

9. Party fortune telling. Apple is peeled spiral fashion, and peeling flung over shoulder. The initial peeling most resembles is initial of person one will marry.

10. Bouncing apple, orange, bread roll, etc. You must be seated at table. Pick up apple and pretend to throw it on floor at right of chair. Foot taps floor to simulate sound of apple hitting floor, then hand (hidden below table) turns quickly at the wrist and tosses apple upward into air where it is caught by either hand. With correct timing (foot tap must be made at instant right hand reaches lowest point) the bounce illusion is perfect.

## ARM

1. Left arm is held against front of body. Right hand pulls on left hand and appears to stretch left arm. Illusion is created by holding left arm sleeve motionless against body while the arm is pulled five or six inches out of sleeve. A series of short pulls is more effective than a steady pull.

The illusion is best with shirt sleeve previously rolled out of sight. Pretend to unscrew left arm, pull it out in series of jerks, push it back, screw it tight again. For other arm stretching bits and similar tomfoolery, see Tom Fitzgerald's routines in "My Best", edited by James G. Thompson, Jr. pages 234-239.



Fig. 4

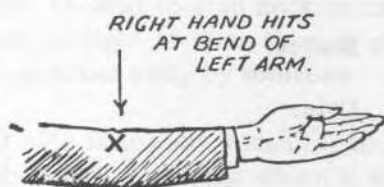

Fig. 5

FOREARM  
SNAPS UP  
TO A RIGHT  
ANGLE.



Fig. 6

HAND AT A  
RIGHT ANGLE  
TO FOREARM.



Fig. 7

TURN HAND  
AROUND AS FAR  
AS POSSIBLE  
WITH OTHER  
HAND.

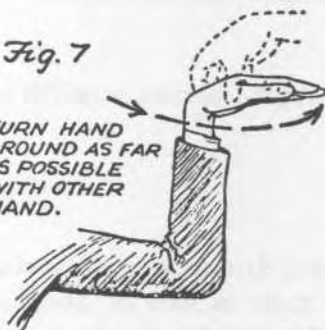

## COMMENTS AND ADDITIONS

Source:

Date:

2. Left arm is extended as in Fig. 4. Right hand taps at point X. At this instant the left arm flexes to Fig. 5. Tap back of wrist, flexing hand to Fig. 6. Right hand now twists hand to Fig. 7. Pretend this final twist is painful as though made in wrong direction.

3. Hold left arm as shown (Fig. 8). Arm is held loose. Right hand pushes it several times, causing it to swing like a pendulum, then a harder push sends it around in a complete circle (Fig. 9).

This has long been a favorite of Red Skelton, who

adds more bits of nonsense, such as pulling down on hand (in Fig. 8 position) then releasing it, allowing arm to bounce up and down like a spring; and after spinning arm around in a few circles, arm reverses and swats underside of chin.



4. An old vaudeville stunt. Two men stand side by side, inner arms interlocked. Each takes off his hat. Arms are extended and whirled so that arms make two complete revolutions, interlocking once more. The move is reversed, and hats returned to the heads. The pinwheel effect is startling.

5. Stand in doorway, arms extended at sides, and press back of each hand against side of door. After a minute, step out of door. Arms seem to float upward of their own accord.

6. To stop pulse. Tightly knotted handkerchief, or small ball, is under armpit. Pressure against it cuts off pulse. Similar effect obtained by hanging arm over back of chair, pressing armpit against chair back.

7. Ashes rubbed on arm reveal name of forced card, word, or number. Name is written beforehand with sharp piece of soap, or better, rubber cement.

8. Stand outside door and close to edge. The neck can be grabbed by both hands in such way that the edge of door hides arms and you seem to be

## COMMENTS AND ADDITIONS

Source:

Date:



in the grasp of a hidden assailant. Also, a single arm can be used to grab neck or collar. By jumping out of sight at same time, it gives appearance of being jerked away by someone.

If left side is toward audience, use right hand so thumb is at top of hand where it should be. Similar illusion is created by standing in dark doorway, back to audience, then crossing arms so hands appear to seize your waist and pull you forward.

9. Pull right arm back into sleeve as though handless when you extend arm to shake hands, take a proffered cigarette, etc.

10. Sight gag. Imitation of lost airplane. Extend arms like wings. Make sound of motor as you glide about with bank turns looking for a spot to land. Failing to find a spot, start to cry.

11. Party contortion stunt. Small object is placed on floor at left edge of left shoe. Right arm must go in front of left leg, then hand curls over top of left shoe to pick up object.

12. Old vaudeville bit. One person stands behind another, his arms under front man's armpits while front man puts arms back and out of sight. Front man makes speech with man behind providing arm gestures.

**BALL** (See Billiards, Marbles, Paper Ball, Ping Pong Ball)

## BALLOON

For methods of forming animals quickly with small colored balloons, as well as other balloon tricks, the following books may be consulted: Don Alan, "The Rubber Circus"; U. F. Grant and others, "Balloon Side Show"; Van Dyke, "Fun with Balloons"; Dwight Damon, "Balloonic" and "Balloonatrix"; Jim Sommers, "Blow by Blow"; Jimmy Davis, "One Balloon Zoo"; Jack Dennerlein, "New Twists for Balloon Workers".

1. Child's toy. Form a chain of rubber bands and attach to balloon.

Loop end of chain to middle finger and use as punching bag (Fig. 10). A few grains of rice in balloon add sound effects.

## COMMENTS AND ADDITIONS

Source:

Date:

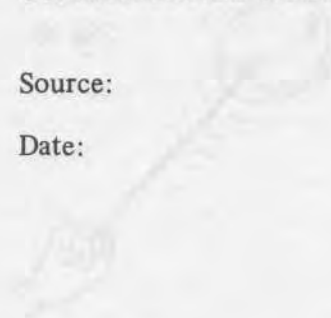

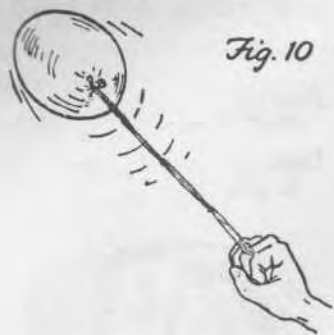

## COMMENTS AND ADDITIONS

Source:

Date:

2. Balloon of one color is inserted into balloon of contrasting color. Inflate by blowing into inner balloon. Tie inner balloon, then inflate outside balloon slightly so there is an air space between the two. When outside balloon is touched with cigarette, or pin fastened to finger, there is a loud pop and balloon seems to change color.

3. Children's party game. Room divided by string which serves as net. Balloon is batted back and forth by opposing sides. If balloon touches floor, opposing side scores.

There are dozens of other party stunts with balloons. I cite only one more. When balloon is tossed into air, everyone must burst into loud laughter. The instant balloon touches floor, dead silence. Anyone who fails to stop laughing is "out".

4. Practical joke. Fill a deflated large balloon half full of water, tie opening. Secretly drop in victim's pocket. Victim has odd sensation when hand encounters it for first time.

4a. Pin-cushion balloon. Inflated balloon is punctured with one or more large hatpins but does not break. See Jack Potter's "Master Index," Vol. I, for listing of magazine articles giving methods.

a. As Tom Ransom pointed out in "New Phoenix" (July 23, 1954), some cheap balloons have a small spot of thicker rubber opposite neck. If balloon is moderately inflated, a sharp pin can be pushed through this thick portion without balloon popping. Hold balloon in both hands in such way that tip of left ring finger, at lower end of balloon and hidden from view, can snap off balloon to make loud popping sound at the moment right hand plunges the pin. Remove pin, keeping finger

over hole to prevent air escaping. Let spectator try. When he punctures thin part of balloon, it explodes.

b. Inflated balloon is wrapped in tissue or transparent kitchen wrapping paper. Small squares of double-faced cellophane tape are at several spots on inside of paper. Ink dots on outside mark those spots. If tape is pressed firmly against balloon, pin can be shoved through tape and balloon without popping balloon. Remove pins quickly and before much air has escaped, pop balloon with a pin.

c. Sausage-shaped balloon is inserted in cardboard tube and inflated so tube circles center of balloon. A secret twist of end of balloon puts kink in center of balloon with enough space around the twist so hatpins can be pushed through tube in various directions without touching balloon.

#### Science Recreations

5. If fingers pull on opposite sides of balloon's mouth, the escaping air will produce musical note. By varying tension, it is possible to play simple tunes.



6. Sound effect. A small non-spherical object with no sharp points (or several beans) is inside an inflated balloon. Rolling it rapidly around inside (Fig. 11) produces loud noise like airplane motor.

7. A gas inflated balloon can be made to float motionless in mid-air (between air layers of slightly different temperature). Adjust weight carefully by tying piece of paper to string and tearing off bits of paper until balloon floats.

8. Does an inflated balloon weigh more, less, or the same as it does when deflated? More: the air inside is compressed.

#### COMMENTS AND ADDITIONS

Source:

Date:





9. Mouths of two balloons are connected by means of tube as shown (Fig. 12). The air from the smaller will enter larger, contrary to what might be expected. Reason: in early stages of inflation, the larger the balloon the less the tension.

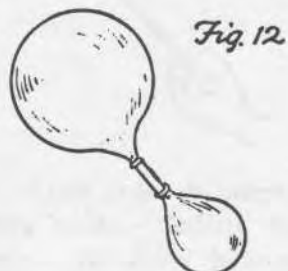

10. Problem: to pick up a bottle with inflated balloon. Drop burning match in bottle, then place tip of balloon into mouth (Fig. 13). Vacuum causes balloon to stick to bottle. This also works with drinking glass, but use tall glass so heat from match does not explode balloon.

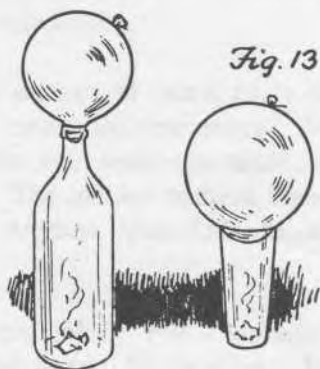

11. Mouth of balloon is attached to bottle containing pinch of bromo-seltzer. Small quantity of water in end of balloon. Lift balloon so water runs into bottle. The gas produced will inflate balloon. Carbonated beverage is not strong enough to inflate balloon any appreciable amount.

12. Comb hair to charge pocket comb with static electricity. It will attract balloon sufficiently to enable you to cause it to roll across floor without touching.

13. Rub balloon briskly on woolen suit to charge it with static electricity. Will stick to ceiling or wall, and often remain for days.

14. Problem: To inflate a balloon inside a small necked bottle. Put soda straw in bottle to allow air in bottle to escape as balloon inflates.

## COMMENTS AND ADDITIONS

Source:

Date:

15. Problem: To pick up two coffee cups with a balloon. Hold the cups with openings against opposite sides of balloon as you inflate it. Balloon expands into the cups, and when inflated, will hold them suspended on opposite sides.

16. Inflate balloon and wedge a dime in mouth to prevent air from escaping. Hold balloon in air, pinch mouth so dime rotates. Balloon takes off like a jet. (Ken Allen)

17. Ken Allen's "hippity-hop balloon". A small wooden ball (it must be of proper size and weight) is inside balloon. When balloon is inflated and held mouth down, ball wedges in mouth and prevents air from escaping. Balloon is dropped on floor. The ball bounces, allowing a bit of air to escape and send balloon up in air, then ball seals opening and balloon descends again. This keeps repeating. One can have several balloons hopping up and down around a floor. See Ken Allen, "Tips".

#### BANANA

1. Banana can be sliced into any desired number of sections without peeling, by pushing toothpick into side and working pick back and forth. Number of slices can be used for revelation of number.

2. Drop burning piece of paper into milk bottle, then place banana, partly peeled in opening (Fig. 14). Suction will cause banana to peel itself.



3. Party game: Two people are blindfolded. Each tries to feed banana to other, with ludicrous results.

4. Bending banana slowly will not break it in half, but a sudden snap will.

#### COMMENTS AND ADDITIONS

Source:

Date:

5. Toy boat for children. Slit a banana, remove fruit, prop sides of skin apart with horizontal matches at bow and stern to make a banana boat that floats in tub.

## BEANS

1. For a detailed description and routine of the classic four beans trick, in which a bean is apparently placed in each ear and each nostril (or each eye), only to reappear one by one from the mouth, see "Four Little Beans" by John Ramsay, a 19 page pamphlet published in England, no date. See Button, No. 4.

## BEER

1. To stop rising foam, place finger across top of glass. Foam stops when it reaches finger.

2. Form small pile of salt on table, place beer glass on top. Strike rim sharply with base of shaker (Fig. 15). Salt appears to stream upward from bottom of glass (actually bubbles).



3. It is possible to write on beer foam with fountain pen. Use for revelation of name, number, chosen card, etc. Indelible pencil also writes on beer foam.

4. Bar betcha. To put head of beer at bottom of glass. Put palm over glass and invert it.

5. Party acrobatic stunt. Stand with one foot on beer can, placed on its side, bend over and pick up cigarette and matches, light cigarette, without touching other foot to floor.

6. Dribble beer can. Open can with the standard

## COMMENTS AND ADDITIONS

Source:

Date:



opener but keep on going until the point punctures side of can, under the usual opening. Puncture is made from inside, the hole tiny and hardly visible. (Tommy Windsor, "New Phoenix", February 2, 1956.)

BEER BOTTLE (See Bottle)

BELT

1. Double belt, with one end slightly longer than other. Place finger in loop and twist into spiral shown in Fig. 16. Spectator tries to guess which of the two center loops will catch on his finger when finger is inserted and belt unrolled. Performer can make him win or loose at will by gathering ends from above or below as indicated by the arrows.

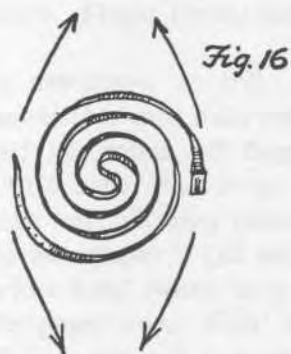

BILL

The following tricks and stunts do not include short-change methods, or ways of switching borrowed bills. Also not included are effects in which borrowed bills are caused to vanish (usually from under a handkerchief, burned in an envelope, or switched for flash bills which are ignited) and reappear in a lemon, borrowed cigarette, nest of boxes or envelopes, package of Life Savers, or other unlikely places. Although some of the methods of this effect are impromptu, the better ones are still featured by many professionals who prefer not to have their methods revealed. For standard versions of this effect the reader is referred to Jean Hugards' "Money Magic", 1937, a book dealing entirely with paper money, and to Jack Potter's "Master Index", Vol I, for a lengthy bibliography. Excellent

COMMENTS AND ADDITIONS

Source:

Date:

chapters on bill effects appear in "Greater Magic" and Volume 3 of the "Tarbell Course in Magic." See also Jack Lamonte, "Stunts with Stage Money".

1. Unknown to audience, an Ace, Nine, Seven & Six (in order) are on top of deck. False shuffle. Spectator cuts into four piles. Pick up first pile, deal three cards to table, then one card on each of remaining three piles. Replace pile on top of the three cards. Do exactly the same with the other three piles. Borrow a \$2.00 bill and have spectator read date in lower right corner. Turn over top cards of piles to reveal the date. Two dollar bills carry the date 1976.

2. Hold bill as shown (Fig. 17). Right hand pretends to rip bill in half, tossing the half to floor. Actually, right fingers hold bill loosely, and as hand makes tearing motion – diagonally downward and to the left as indicated by arrow—the fingernail of middle finger scrapes against bill to give the sound of tearing. (Fig. 18). Left thumb keeps bill folded as right hand makes throwing motion toward floor.

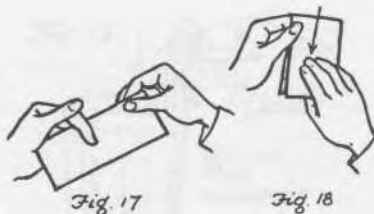

3. Unknown to spectators, a bill (rolled into ball) is fingerpalmed. Borrow a bill, roll it into a ball, adding the palmed one. Hold both as one. Pretend to rip in half, actually pulling the two bills apart. Unroll each to show the two complete bills.

4. Hold bill as shown (Fig. 19). Spectator's hand is in position to grab it, but his fingers and thumb do not touch bill. When you release bill, he tries to catch it. Looks easy, but is impossible. You can, however, demonstrate it on yourself because your brain times the grab with the release.

5. Place a dollar bill on top of a five as shown in Fig. 20. Starting at corner Z, form the bills into a small roll. When roll reaches the far ends of bills,

## COMMENTS AND ADDITIONS

Source:

Date:



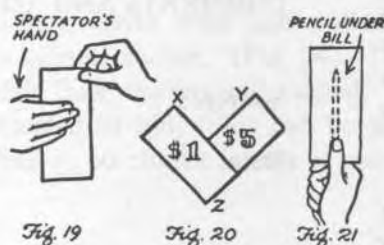

## COMMENTS AND ADDITIONS

Source:

Date:

ask spectator to place his fingers on corners X and Y. When unrolled, the five is found to be on top of the one. Secret: Make roll slightly on diagonal toward corner X. Under cover of right hand, allow corner of five to go once around the roll.

6. Spectator holds pencil firmly by each end. Fold bill lengthwise. Hold it at one end, strike pencil several times with bill. Make crease in bill sharper and repeat. This time extend index finger as hand comes down. Finger breaks pencil easily.

7. Christopher's newspaper to bill. Roll two small pieces of newspaper into balls and place on table. Right hand has rolled bill finger-palmed. Spectator points to a ball. Pick it up with right hand and drop into left, allowing palmed ball to fall and retaining newspaper. Let audience get glimpse of ball before hand closes, as it is indistinguishable from the paper one. Right hand picks up remaining ball and places it in pocket, leaving the palmed ball also. Open ball in left hand to show paper has changed into real money.

8. A bill is held as shown (Fig. 21) with a pencil or similar object beneath it. Toss imaginary grains of sand into air and pretend to catch them on the bill. The sound effect is obtained by pressing bill firmly against pencil with thumb, and sliding thumb slightly forward or back.

For a two-part torn and restored bill routine, using this and previous move (a borrowed bill is apparently torn three times and restored), see T. Nelson Downs, "The Art of Magic", pages 311-15.

9. Wrap a bill around creamer, then push top edges into creamer to form compact shell. Tap it against table. As left hand reaches into coat pocket for pencil, right brings shell to edge of table



and drops creamer in lap. Left hand pushes pencil through the shell, which is then unrolled to show creamer has vanished. Left hand retrieves creamer from lap, brings it up under coat and pretends to extract it from inner coat pocket.

10. Berland's vanishing bill. Two bills are folded and held by the corners. As right hand palms off one bill, left thumb adjusts the other (which has been folded in a special manner) so it appears to be two. When this bill is shaken open, the effect is an instantaneous vanish of a bill. Details on the ingenious fold, and handling of the trick, will be found in Samuel Berland's "Billtrix", Series No. 1 and on p. 5 of my "Over the Coffee Cups".

11. Crumpled bill can be soaked in whisky or gin and ignited. Will flare up and burn out without damage to bill.

12. A paper match can be ignited by striking on a bill. Left fingers keep bill flat as right drags match across it. The top of the middle finger presses head of match against bill. Repeat rapidly several times until heat of friction ignites match.

13. A bill can be made to shrink a surprising amount by crumpling it into a ball and rolling it several minutes between the palms. If you can procure an old type large bill, finish trick by switching shrunken bill for it and pretending to stretch it to a size even larger than ordinary.

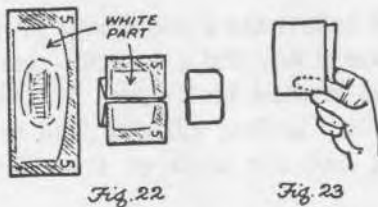

14. A five can be folded (Fig. 22) so that no green shows. Pretend to pick this from the floor. Place on table and offer to sell for a dollar. Since it looks like a wad of paper, there will be no offers. Unfold and show it to be a five.

15. Hold bill as shown (Fig. 23), the middle finger inside the fold. As you hand it to someone, snap middle finger, causing bill to shoot back several feet where it can be caught by left hand.

16. To thumbtack bill to ceiling. Push tack

## COMMENTS AND ADDITIONS

Source:

Date:

through center, cover with half dollar, fold bill around the coin as shown. (Fig. 24). Toss against ceiling. Half falls, leaving bill tacked. If tack is secretly inserted in bill, folds can be made without revealing it, so climax comes as complete surprise.

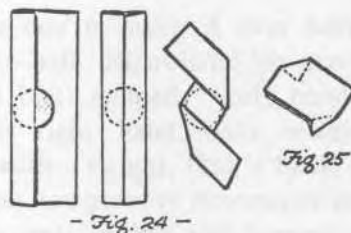

## COMMENTS AND ADDITIONS

Source:

Date:

17. Rubber stamp in big black letters the word SAMPLE on face of stage money. Amusing reactions on part of friends, cashiers, etc., when they receive bill of stamp MADE IN HONG KONG.

18. Prepare a check book with bills of varying denomination instead of blank checks. Cut off checks close to perforations, and rubber cement ends of bills to the stubs. When you pay a check, tear out bills of appropriate amount.

19. Party gag. Prepare a roll of bills, fastened end to end. Hand victim a pair of scissors and offer to let him clip off one bill himself. Scissors are missing one blade, or the novelty store type which will not open.

20. Ask a friend if he's seen the new bills now being issued. Show bill on which you have pasted a picture of the president (or his wife) over the face of Washington.

If picture is carefully cut from a newspaper, in the necessary oval shape, and rubber-cemented to bill, it looks like a genuine print job.

21. To "Double" your money — fold it. To make it increase—unfold and you find it "in-creases."

22. Paste cotton beard on Washington. "This has been in my wallet so long," you explain, "that George has grown a beard."

23. Give bill a slight lengthwise fold so you can stand it on end. Rub finger on sleeve to charge it

with static, point finger at bill, bill falls over.  
Secret: blow.

23a. Several bills are borrowed and serial number of one bill is jotted down. Bills are crumpled into balls, dropped in hat, you reach inside, find chosen bill. Ball bearing is loaded into bill as you form ball; you identify bill by weight.

23b. Spectator cuts deck, you mark spot with bill taken from wallet. In wallet, behind bill, is card to be forced.

23c. Tabor's silk (see HANDKERCHIEF No. 15) is effective with two bills rolled lengthwise.

23d. Three bills are held tightly at one end by spectator. Under handkerchief you remove one of them. Center bill has V-shaped opening cut at one end so it slides easily. With hands covered by hank, exchange gimmick bill for unprepared bill in sleeve. (Johnnie Murray)

23e. Remove tobacco from cigarette and insert bill, adding tobacco at one end to make end look okay. Take prepared cigarette from your pack (or pretend to take it from borrowed pack), drop in glass of water. Fish it out, rub between hands to produce bill. Paper rolls into tiny ball and drops on floor.

23f. Vanish of coin on top of head (see COINS, No. 10) was applied to bill by Gaylord E. Hill in "New Phoenix" (No. 316). Rolled-up bill is left behind right ear on count of three, and your extended forefinger strikes his palm. Quickly duck your fingers under his hand and into his sleeve so when he finds bill gone he thinks it went there.

23g. Many methods have been published for causing a transposition of two bills, of different denominations, between your hand and spectator's. Since they involve gimmicking of bills, they are not strictly impromptu and will not be discussed here. For typical method, see "Scarne's Magic Tricks", by John Scarne, page 73.

23h. A beautiful effect, which also must be omitted because of the complexity of moves in the many routines that have been worked out, is that of rolling bill into a tube then shaking a half or

## COMMENTS AND ADDITIONS

Source:

Date:





silver dollar from it. In some versions the coin is actually loaded inside tube, in others, a palmed coin appears to shake from a tube much too small to hold it. Milbourne Christopher's routine appeared in "New Phoenix", September, 1963. Jerry Andrus's routine is in his "Nameless Notes" (1964).

23i. Coffee cup is inverted over borrowed bill crumpled into ball. Right hand has newspaper ball (or flash-bill ball) palmed. Left hand takes bill from cup as right hand loads newspaper ball. Vanish ball with a sleight, find it back under cup, loading bill as you remove newspaper ball. Newspaper ball is put on cup and burned. Lift cup, return original bill. (Milbourne Christopher)

23j. Crease new bill in half lengthwise to make knife-edge fold, then fold bill in half to make a V. Place V on table, creased edge up, and put a quarter on corner of V. Seize each end of bill and slowly straighten it. Surprisingly, you can pull bill perfectly straight without coin falling off the creased edge.

23k. Crease a tiny mountain ridge that runs horizontally across bill just below Washington's eyes. Hold bill at each end and slowly tilt it away from you so you view Washington at more and more of angle. As bill tilts, the eyes seem to close slowly until George falls asleep. (Johnnie Murray)

23l. Spectator rolls bill into a ball, places it on table and covers it with hank. Touch bill with point of pencil, a duplicate bill ball palmed in hand holding pencil. Call out serial number on your bill. Pick up hank by center to uncover borrowed bill, but actually take the bill along with hank and allow palmed bill to fall behind hank. Serial number is verified.

24. Borrow a bill and hold it up so spectator sees the numbers and you can't. If there is a good light in front of bill, you can call off number by reading it backward through the bill.

25. Bet even money he cannot correctly name three figures all of which will appear in serial number of a borrowed bill. Odds greatly in your favor.

## COMMENTS AND ADDITIONS

Source:

Date:

26. Dollar bill poker. Two players each produce a bill and take turns calling pair or better, using figures on the serial number. No straights or full houses permitted, but groups may go beyond four. At each turn, player must better previous claim, or else call. Bluffs permitted. After calling, person who made the last claim must show his figures. In doing this he is permitted to use the serial number on both bills. Thus if he had claimed six nines, and there are two nines on his bill and four on his opponent's, he wins opponent's dollar. Otherwise, he loses his dollar. Cheaters carry bills with large number of duplicate figures.

27. Memorizing numbers. Without nemonics, memorization is facilitated by breaking number into two numbers of four digits each, and memorizing them as if they were two phone numbers. Useful in tricks involving switch of borrowed bill. Spectator writes down serial number for later identification. Switch occurs before performer has checked the number by reading it off. He reads, of course, the correct number, which he has memorized.

28. Royal Heath's bill trick. Spectator calls total of first and second figures, then total of second and third, etc. Finally, he gives the total of last and second. After some calculations, magician gives the number.

For details on this and other mathematical divination effects making use of bill's serial number see my Mathematical Games column in "Scientific American", April, 1968.

#### Puzzles

29. Find the key on dollar bill. It's in the lower part of the green seal to the right of Washington.

30. Find the names of more than twenty states on a five. They're in small print across top of Lincoln Memorial. Hold bill flat against glass of water, and look through water to magnify printing.

31. How many times does "one" (either the word or number) appear on the two sides of a dollar bill? At least 27, not counting the "ones" which may appear in the serial number. Don't overlook the word "unum".

#### COMMENTS AND ADDITIONS

Source:

Date:

32. Place a glass on the end of a bill, and balance coin on rim. Problem: to remove bill without touching the glass with anything not already touching it, without jerking on bill, and without dislodging coin. This is done by rolling bill until it touches the glass. Continue rolling. The center of roll pushes glass off bill.

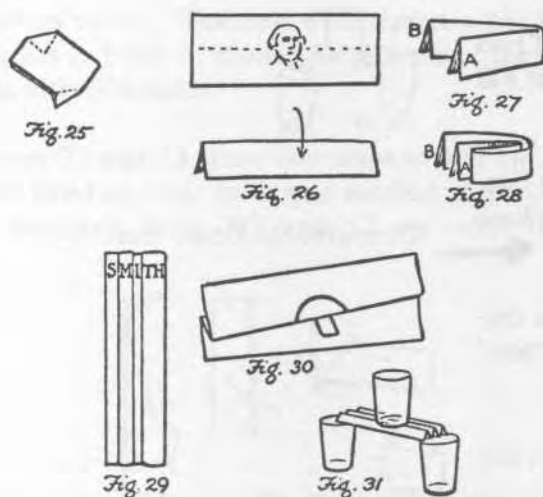

33. Fold a crisp bill in half, bend down opposite corners as shown (Fig. 25). Problem: to blow the bill on its back. Solution: blow it across the table until it projects over edge. Then get beneath and blow up.

34. Magician holds bill with Washington upright, folds it three times. When unfolded, Washington is upside down. Spectator is unable to duplicate. The first fold is down from above (Fig. 26). The second fold is to the back (Fig. 27). The left thumb and index finger hold end A. End B is clipped by first and second fingers. Third fold is made forward (Fig. 28). Unfold by taking end A with right hand and pull to right, left hand retaining end B. When remaining fold is opened, Washington should be inverted.

35. Problem: to fold bill so that letters in the phrase "The United States of America" on the face of bill are used to form the word "Smith." Use the "S" from "States", the "M" and "I" in "America," and then bring the "TH" in "The" around the back to the right side. Fig. 29 shows the result. This was circulated as a puzzle during Al Smith's presidential campaign. Similar word puzzles can be devised.

## COMMENTS AND ADDITIONS

Source:

Date:

36. Problem: fold bill to produce picture of a mushroom. Make two horizontal folds as in Fig. 30. Mushroom is formed by Washington's head and shirt front.

37. To make a "five" out of a one. Roll bill diagonally to form a tight, thin rope-like roll. Bend it into the shape of a figure 5.

38. Problem: to place a bill across the rims of two glasses and support third glass in center. Pleat bill as shown (Fig. 31).

39. Problem: to find the number 3172 on a five. It appears in black digits in the foliage at the base of Lincoln Memorial, left side.

40. How many times does "ten" appear on a ten-dollar bill? Answer: 12. Did you overlook "ten" in "tender"?

41. Find the date 1776 on dollar bill. It's in Roman numerals at base of pyramid.

42. In London's Soho section, ladies of the evening post advertising notices above their doorbell. One such lady, seeking American trade, tacked up an American dollar bill on which she had drawn in red ink a simple closed curve that surrounded four words of self-advertising. What were the words? Answer: "gal tender and private." The story has a topper. When a customer left the building he stopped at the doorbell, crossed out "gal" and "and".

## BILL FOLDS

A by-product of the recent interest in origami has been the development of many ingenious dollar bill folds: bow tie with Washington's face in center, finger ring, flapping bird, hopping frog, and so on. "Bill Folds", a mimeographed manuscript by Al O'Hagan (published by Snyder's Magic Shop in Cleveland), was the first collection of such items. Since then Magic, Inc., Chicago, has published Adolfo Cerceda's "The Folding Money Book" (1963) and Samuel and Jean Randlett's "The Folding Money Book Volume Two" (1968).

There are several methods of folding a bill so it appears to be of much smaller size and can be jerked open to full size.

## COMMENTS AND ADDITIONS

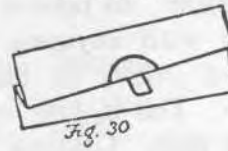

← Obsolete. No longer true.



In "Hugard's Magic Monthly", February 1949, I explained how to fold a fish that opens and shuts its mouth and apparently blows out a match flame. (The blowing is secretly done by you.)

The greatest of all bill folds for magicians is, of course, Robert Neale's rabbit that pops up out of the top hat, currently available as a manuscript. A second head can be folded with a flash bill and attached to hat. Touched with cigarette, the head vanishes in burst of flame. On command the head pops into view again.

Figures 32 and 33 show two ways to fold bill so it looks like two bills. In second method, AB and CD are mountain folds, WX and YZ are valley folds.

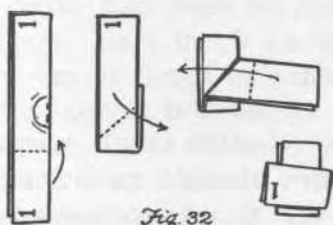

Fig. 32

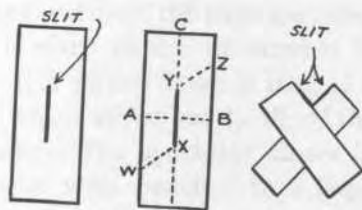

Fig. 33

## BOOK

1. A book can be used in place of coin tray. The extra coins are in the spine of book, in the opening between the cover and the cloth which binds the pages. Book is opened in center and coins are counted onto the pages. When coins are dumped into spectator's hands, the extra coins slide out of the spine (Fig. 34).



Fig. 34

## COMMENTS AND ADDITIONS

Source:

Date:

"Bunny Bill" sold by Magic, Inc.

2. Carbon paper on underside of book jacket, with paper beneath, offers a simple substitute for gimmicked clip board. Spectator is handed book to use as backing while he writes on slip of paper.

The carbon paper can be dispensed with by having spectator write with ballpoint pen. This leaves a faint impression on the jacket that can be seen by tipping book so that light strikes jacket at an angle.

3. All books are printed with even numbers on the left side when the book is opened. This fact makes possible the following trick. A book is opened at random while your back is turned. Ask a spectator to place his hand on either right or left page, without telling you which. A second spectator places his hand on the other page. Ask the first spectator to multiply his page number by ten. The second spectator is asked to multiply his number by five. The two products are added and you are told the total. You can now state who is touching the left page and who the right. If the total is even, the first spectator is touching the right page. If odd, he is touching the left. The trick can be repeated with different multipliers, the only requirements being that the first must be even and the second odd.

4. If it is necessary in any trick to force either an odd or even number, a book can be used for the force. Spectator opens at any spot, then is told either to look at number on left or right side.

5. Paper bound book can be used for secretly adding cards to a packet. Extra cards are under the cover. Cards are counted on top of book which is held as a tray. When cards are dumped into hat, or spectator's hands, the extra cards slide out from under cover.

6. A card can be exchanged for another by handling similar to above. Second card is under book's cover. Other card is held by thumb as book is turned over to drop card on table, spectator's hand, etc. (Frank Kelly).

7. To add a card or packet of cards to pack, have the extra cards projecting from back of book

## COMMENTS AND ADDITIONS

Source:

Date:



which is flat on table. Deck is placed on rear edge of book. When deck is later picked up, the fingers secure the card or cards to be added. Can also be used for adding envelope to a stack.

### BOOK TESTS

It is beyond the scope of this work to go into the hundreds of ingenious book tests which require the use of certain books, prepared or specially printed books, gimmicks, or keys for informing the performer which words are at what places. The following methods are impromptu in the sense that they require no more than a moment or two of preparation.

The chief problem is that of forcing the spectator to choose a certain page when his choice is apparently at random. Once this is accomplished, the desired word can be forced by various methods. The simplest, of course, is to use the first (or last) word on the page. Other methods: (a) The digits in the page number are added to obtain a number which indicates position of word. (b) The number of the word is forced by some other means. (c) The first ten words of the page are memorized, and spectator is given choice of number from one to ten. (d) If a phone book is used, a page can be forced on which all, or nearly all, of the last names are the same. The spectator closes his eyes and stabs a name with pencil. In a large city, such pages can be found with fairly uncommon names.

There are innumerable ways of forcing the desired page number by means of cards, dice, etc. Other methods employ nothing except a mathematical calculation which appears unpredictable but actually has only one result. Mathematical forces of numbers, however, are so contrived, and create such suspicion, that they should never be used in book tests.

1. Bill Nord's book test. Near center of book make an "X" with pencil so that crossing of X is at desired word. Book is handed to spectator with request that he open it behind back, make an "X" on a page. A mechanical pencil is used, but it is secretly prepared in the following simple manner.

Break off about a quarter of an inch of the lead, placing it back in pencil. You can use pencil for marking on paper to illustrate type of mark he is to

### COMMENTS AND ADDITIONS

Source:

Date:

make. Before handing him pencil, pretend to adjust the lead, but actually turn pencil in direction that draws lead back. The small piece of lead will remain in view, but when he uses pencil it will be pushed inside and pencil will leave no mark. It remains only to locate the previously made "X" at the desired word. Note: when you take back pencil, twist again to eject piece of lead. Pencil can now be examined.

2. Annemann's use of hair. Assistant goes into another room. Spectator opens book at random, picks either side, and counts to word indicated by total of figures in page number. You secretly drop a piece of hair on book before closing it. Hair projects either at top of book (indicating left page) or bottom (right page). This enables assistant to find word when book is taken to him.

3. Spectator inserts a playing card or business card into lower end of book. You have previously inserted another card at the desired page, and it is projecting at the end nearest you. Grasp spectator's card and apparently slide it around the book from one end to the other. On the way around, the card is pushed into book, but hand continues. Turn book around to reveal projecting card. There are other handlings, but this is perhaps the simplest.

4. Bend down upper corner of desired page of phone book before beginning. Book is extended for spectator to bend down corner. Your hand holds upper corners so he bends corner at lower end. Later, you hold lower corners while he finds bent corner at upper end and opens book to that page.

5. Dai Vernon's page force. Phone book is held with the right little finger secretly inserted at desired page. Spectator inserts card in front edge. Right hand moves around book to take card, the little finger remaining inside, and book is opened at the forced page, the right hand retaining the card. For exact moves see "The Tarbell Course", Vol. 5, p. 154.

6. A borrowed book is used. Numbers for page and word are freely chosen, but you secretly obtain them in some way. (For example, have cards chosen, adding zero to value of one card to obtain

## COMMENTS AND ADDITIONS

Source:

Date:



page number. Cards are glimpsed after returned to deck.) As you illustrate how they are to use the numbers to find the page and word, cite two numbers as examples and pretend to find the word indicated by them. Actually, you look up the word indicated by their numbers. Read off another word instead. A similar handling is to borrow a book, and in explaining how it is to be used, you find the page and position of a word. The desired numbers are then forced.

7. Any book is used. Glance through it rapidly pretending to memorize entire contents. Cards are chosen to indicate page and number of line. Spectator reads line and you tell him page number and position of line. The cards are either forced or glimpsed. Success depends on boldness and showmanship. If force is used, you can memorize many additional details about the page to throw out as further proof you have book memorized.

A similar handling is to borrow a book, and in explaining how it is to be used, you find the page and position of a word. The desired numbers are then forced.

8. Borrow book, riffle pages until he says stop. Hold book up so he can read top line. Close book but keep pinky break. Later, riffling through pages carelessly as though trying to get impression of his thoughts, you riffle to break, spot the line.

8a. Borrow book, memorize a top line, keep pinky break at that spot. Force the page by riffling until he says stop, but opening book at break.

8b. Similar to above force except paperback book has been gimmicked by pushing a pin into center of spine. When pages are riffling, pin functions in manner similar to short card in deck. (Milbourne Christopher)

9. Spectator opens book, copies top line in soft pencil on a blank card which is left projecting at chosen page. You take closed book, press firmly on covers as you withdraw card and give to spectator to concentrate on while book is taken to assistant in another room. A pencil smear on chosen page gives assistant the information he needs.

## COMMENTS AND ADDITIONS

Source:

Date:



10. The three edges of back flyleaf are folded along lines about one half-inch from the edges. Back cover of book is bent into slightly convex shape (Fig. 35). When back cover is tapped in center, book produces a Bronx cheer.



Fig. 35



Fig. 36



Fig. 37

11. Drawings are made in margins so that when pages are riffled, movie effect is obtained.

12. The pages are bent sharply in one direction, and words or phrases are printed with pencil on the front edges. Pages are bent in reverse direction, and different words are marked on the edges. By bending pages first one way, then the other, a transformation of words is obtained (Fig. 36).

13. The eyes of a portrait are carefully cut out. When the page is moved back and forth slightly, the printing on page beneath will make the eyes appear to move in various directions (Fig. 37).

14. Juggling stunt. Book is placed on desk, projecting slightly over edge. Back of fingers strike book from beneath, causing it to make a half-rotation in air, the hand catching book by opposite end.

15. On flyleaf is written, say, "See p. 27." On p. 27 is the note "See p. 108." This chain continues back and forth interminably, ending finally with an uncomplimentary or uncouth remark.

## BOTTLE

1. Put dime on mouth of coke or beer bottle, shortly after it has been emptied and is still cold. Place drops of water around rim to make opening air-tight. Pretend to squeeze bottle with hands. Heat from palms will expand air in bottle and cause dime to click up and down at intervals.

Source:

Date:

Will continue after hands are removed. Dime can be made to dance rapidly by secretly dropping into bottle (which has small amount of liquid left inside) a piece of alka seltzer.

Senor Mardo's "Routined Magic" (1945) gives the following presentation by Harry T. Hoffman. Instead of warming bottle with hands, he casually rests a hand, holding burning cigarette or cigar, near bottle. Attention is focused on dime by pretending to ask it questions; soon the dime clicks up and down as if replying. Hot cup of coffee near bottle also does the job.

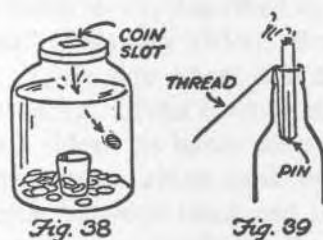

2. Novel bank for children can be made with large jar and drinking glass (Fig. 38). If coin falls into glass, pay child five to one. Also excellent concession for fund-raising carnival or party.

3. Blow into bottle to compress air. Hold thumb over end. Bring mouth of bottle close to match flame and remove thumb. Bottle will puff out flame.

4. Burning cigarette rises and falls in neck of bottle (Fig. 39). Black thread is attached to body. At other end is a pin, inserted into cigarette. As cigarette is handed forward for examination, pin comes out.

5. Make slit in lower side of cork (for a small pill bottle), and insert paper match as shown. (Fig.40) Match flame beneath will ignite match, blow cork across room. Handle with caution.)

6. To pour liquid rapidly out of bottle with small neck, move neck in circles while bottle is inverted.

7. To transfer label to inside of beer bottle. Moisten label and let stand until label can be peeled off. Roll into cylinder and push into bottle, which contains small amount of liquid. By holding bottle horizontally, and shaking back

## COMMENTS AND ADDITIONS

Source:

Date:

and forth, label can be made to unroll and stick fast to inside of bottle.

8. In pouring beer into glass, flow can be checked instantly by submerging neck, even though bottle remains inverted.

9. Beer and soft drink bottles can be opened easily with a spoon. Grasp neck firmly with left fist, immediately below bottle top. Rest bowl of spoon on top of curved index finger, and lever edge of spoon upward against edge of bottle top.

10. A dime can be driven neatly through side of milk bottle. Bottle is held vertically and shaken so dime slides back and forth rapidly. Dime hitting sides at same spots will soon weaken glass enough to cause dime to penetrate through a small slot.

11. Hard boiled egg or banana can be drawn inside milk bottle. (See EGG and BANANA).

12. Howie Schwartzman tells me that a Dutch tenth of a guilder looks like a dime but is just small enough to go into a coke bottle. Borrow dime, switch, push the Dutch coin into coke bottle. Fist with palmed dime goes around neck, invert bottle, shake out the coin, switching it back to the dime.

13. Problem: To lift upside-down milk bottle with thumb and middle finger as shown (Fig. 41). Fingers must be dry. (Ed Rock)

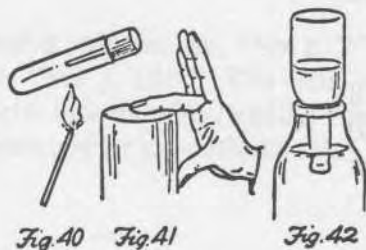

14. A small bottle inserted in neck of milk bottle as shown (Fig. 42) provides an excellent barometer. Level of water in small bottle rises and falls with changes in barometric pressure.

## COMMENTS AND ADDITIONS

Source:

Date:





14a. Sight gag from Bob Orben. Hold two beer bottles up to your eyes as if they are binoculars. Do a short horse-race call, moving head as though watching a race.

14b. Pretend-you're-drunk bits: Pour beer in glass and pour on table. Pretend to pick up glass, but leave glass behind and pour beer through curved fingers. Take swig of beer, keeping it in mouth, then put bottle to ear, tip it, spew beer from mouth.

14c Many methods have been worked out for producing bottle under a handkerchief. A simple impromptu method was described by Remo Inzani in "The Gen" (February 1958). Bottle is pushed under belt, to left side where it is hidden by left side of open jacket. Take hank from breast pocket, show both sides. As hands cross to show other side, right hand goes behind hank and to left, clips neck of bottle between third and fourth fingers. Breathing out causes bottle to tip forward and make pickup easier. Right hand is raised high with bottle under hank, then left hand whips away cloth.

14d. This weird effect was reported by Milton Tropp in "Hugard's Magic Monthly" (July 1959). He saw a pitchman perform it on a beach. Empty soda bottle is half-buried, neck down, in sand. One end of long length of cord is tied to neck of bottle, then wrapped five or six times around neck.

A trench is dug in sand, from bottle's neck to a spot some 20 feet away. Cord lies along trench which is then filled in with sand. When confederate, sitting 20 feet away, pulls end of cord, the half-buried bottle mysteriously rotates. Performer makes bottle twirl on his command or on command of spectators. When string is unwound, performer screws bottle more firmly into sand, rewinding for repeat of effect. At finish, loop is slipped off bottle as it is withdrawn from sand and confederate pulls away the string, leaving no clue to be discovered as spectators dig into sand for the mechanism.

## COMMENTS AND ADDITIONS

Source:

Date:



## Puzzles

## COMMENTS AND ADDITIONS

15. Wooden match, bent in form of "V" supports coin over neck of bottle. To get coin in bottle without touching anything: Let drop of water fall on vertex of "V". Will cause match to open to wider angle, releasing coin.

Source:

Date:

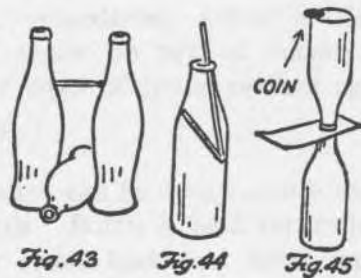

16. Three coke bottles are arranged as shown (Fig. 43). A match is supported between the two upright ones. Problem: To remove the horizontal bottle without dislodging match. Light match with another one, blow out quickly. Head will stick to glass, so bottles can be separated without match falling.

17. Bottle is on side, with small piece of cork resting inside neck. Problem: To blow cork into bottle. Solution: Blow gently through soda straw, otherwise cork blows back in your face.

18. To lift bottle with soda straw, bend straw as shown (Fig. 44).

19. To empty bottle without removing cork, push cork into bottle.

20. To remove piece of cork floating on liquid inside of bottle, blow into bottle.

21. To crawl into a bottle: Go out of room, then crawl in on hands and knees. You are crawling in — to the bottle!

22. To remove a cork that has been wedged into neck of bottle containing liquid. Wrap towel over bottom, and strike bottom (of bottle) repeatedly against wall.

23. Large neck bottle is upside down over a small ball or marble. Problem: To move bottle and ball from one table to another without touching any-

thing but bottle. Bottle is given circular motion, causing ball to roll around inside, and is transferred while ball is kept rolling.

24. To drink from a bottle without opening it. Bottle must be type with deep hollow at bottom. Invert, pour water in hollow, drink it.

25. Blow cigarette smoke into empty whisky bottle (using straw or rolled paper). Problem: To get smoke out of bottle in one second, without touching bottle. Drop burning match in bottle. Smoke vanishes with small explosion. Note: There must be small quantity of whisky remaining in bottle. Before trick, warm bottle with hands to create alcoholic fumes.

To conceal secret, Ted Bohmann suggests using coke bottle into which a bit of scotch has been secretly poured. For repeat, put thumb over bottle and invert. Small amount of scotch left in bottle will coat inner walls. This time, after bottle is filled with smoke, hold flame to neck of bottle. Smoke slowly vanishes from top down.

26. Bottle is upside down and balanced on a coin. To remove coin, strike it with flat blade of table knife, passing blade under bottle, or pound table until bottle slides off coin.

27. Bottle is upside down on end of dollar bill. Coin is placed on bottom of bottle. Problem: To remove bill without dislodging coin or touching bottle. There are three methods. (1) Jerk bill out quickly. (2) Roll bill against bottle, the roll pushing bottle off. (3) One hand pulls on bill while other pounds table near bottle.

28. Unperforated nipple for baby bottle is fastened over mouth of filled coke bottle. Problem: To get all the coke out of bottle without removing nipple. Shake bottle vigorously. Nipple will expand enough to hold the liquid. Perforated nipple can be used by plugging holes with pins. Nipple should be tied firmly to neck of bottle.

29. A bottle is balanced upside down on top of another (Fig. 45), with a bill between the mouths. Coin rests on top of upper bottle. Problem: To remove bill without dislodging coin. Hold end of

## COMMENTS AND ADDITIONS

Source:

Date:

bill with one hand, strike center of bill with index finger of other.

30. Wooden sewing hoop stands on neck of bottle. Pea is placed on top of hoop directly over top of bottle. Performer demonstrates how easily hoop can be knocked aside with forefinger, the pea falling into bottle, but when spectator tries, pea flies across room. Secret: Place extended forefinger against outside of hoop as though you intend to strike that spot, explaining that hoop must be struck exactly at midpoint of side, not too high, not too low. Swing arm in wide arc. As forefinger reaches hoop, secretly bend it so it misses edge of hoop, immediately straighten finger so that tip strikes other side of hoop on the inside. The illusion is that finger hit hoop on outside, but if this is done it sends pea flying. A string tied to hoop and held by spectator prevents hoop from sailing across room, makes it easy to retrieve.

#### BOTTLE CAP

1. Dime is secretly waxed to underside of cap. Second dime is held beneath first dime by tip of ring finger as cap is held between thumb and middle finger. Spectators notice this and suspect something. Place cap gently on table. Borrow dime, vanish it, bet a dollar it is under the cap. Fake a sneeze. As you turn away, stooge quickly lifts cap, steals dime, replaces cap with a tap that dislodges second dime. Feign innocence, take all bets, lift cap. There's the dime.

2. Five bottle caps work well for the classic chink-a-chink effect. One cap can even be left momentarily on top of another and the hand quickly shown empty without the double cap being noticed. (See SUGAR LUMP, No. 10.)

#### BOX

The reader who is interested in the construction of toys, games, etc. from wooden and paper boxes will find the subject adequately covered in Beard's "Jolly Book of Boxcraft", 1918; Showalter's "The Box Book", 1929; and Leeming's "Fun with Boxes" 1937. For stunts with match boxes, see MATCHES.

1. Small cardboard box is opened and shown to contain a human finger. It is performer's ring

#### COMMENTS AND ADDITIONS

Source:

Date:



finger, which goes through hole in bottom of box. Finger should rest on cotton, to hide hole. A rubber band tightened around base of finger will make it appear bloodless. Cotton can be stained with red ink.

2. Water in a cardboard box can be boiled over a flame without damage to the box.

3. Small square-shaped box can be used for divination effect. Spectator places a colored object in box while performer's back is turned. Magician correctly names color of object while holding box behind back. Secret: behind back, remove cover and replace on side of box. Bring box in front, open side facing you (Fig. 46) and shake to prove object still inside, taking care not to shake out of box. Place behind back once more. Restore box to original condition, and name color.

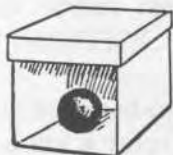

*Fig. 46*

A large die can be used and you name which side is on top. Small dots at certain corners of faces give you the die's orientation.

An alternative method is to open box behind back and place object on table behind you. Close box, turn around to show spectators how you "feel" the color (or position of die) through side of box, glimpse object on table. Face audience again, put object back in box.

#### BRACELET

See Ring, Rubber Band.

#### BREAD

1. A coin is secretly pushed through the bottom of a roll. Later, break open and find coin.

Or coin is finger palmed. Seize roll at opposite ends, thumbs on top, palmed coin beneath. Bend ends up to crack bottom of roll. Fingers slip coin into crack, then bend ends down to crack roll at top and reveal coin inside.

#### COMMENTS AND ADDITIONS

Source:

Date:



2. Bert Allerton occasionally startles table guests by suddenly pulling off a finger and starting to eat it. The "finger" is a piece of salt-stick bread, held as you would hold a false finger. Get it in place secretly, and pull it off while attention is on your face.

3. Tap roll against table top. At same time, left knuckles rap underside of table. If properly synchronized, the effect is highly amusing.

4. Bouncing a roll. See APPLE, No. 10.

5. The unalterable pellet. Old books of science recreations explain how to take a fresh loaf of bread and knead a small pellet into the shape of a child's jack. Place on table and smash flat with palm. Instead of flattening, pellet retains its shape no matter how hard the blows.

6. Zombie roll. Place hard roll on table beside plate and cover with cloth napkin so napkin also covers fork. Reach under cloth, stick fork into roll. Pick up napkin by the two corners near you, secretly grasping end of fork, and you can perform zombie ball effect, the roll apparently rising up and carrying napkin with it forcing you to rise from table and even standing on chair. It floats back down to table, you reach under, remove fork and leave by plate, then uncover roll. Or when roll is in mid-air you can remove cloth and expose fork for a laugh. (Karrell Fox, "Phoenix", Feb. 19, 1954.)

## BRICK

1. Problem: to lift five bricks with one hand. Stack bricks as shown (Fig. 47). Reach down center of stack and grab lowest brick.

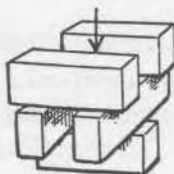

Fig. 47

2. Party race. Each contestant is given two bricks. Every step forward must be made on a brick.

## COMMENTS AND ADDITIONS

Source:

Date:

## COMMENTS AND ADDITIONS

Source:

Date:

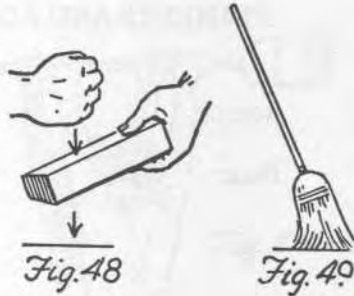

3. A brick held in the hand can be broken with a hammer without damage to the hand.

4. It is possible to break a brick with the bare hands by holding it a few inches above the sidewalk (Fig. 48) and striking it with the fist as shown.

## BROOM

For whisk broom stunts see WHISK BROOM.  
See also CANE, YARDSTICK.

1. A broom can be balanced on the floor as shown (Fig. 49). It is quite a surprise for someone to enter a room and find the broom standing by itself in center of floor.

2. Practical joke. Pan of water is held against ceiling (you stand on table or step-ladder) and victim asked to support it by pressing against ceiling with broom handle. Leave him trapped in this position.

3. Practical joke. Legs are crossed as shown (Fig. 50) and broom handle placed on toe of rear shoe. Take a step forward with other foot, then give broom a kick with rear leg. With practice you can send broom six feet or so across the lawn. When victim tried it, he usually kicks other foot out from under himself.





Fig. 51

4. Going "through" the broom. Broom is held in front of body. Right leg is inserted as shown (Fig. 51). It is possible to carry broom over the head, down in back, then step out of it on left side.

5. Going "under" the broom. Bristle end is placed on floor against wall. Handle is held in both hands. Feat consists in passing body under broom handle without letting go.

6. Grip test. Two people hold broom above heads (Fig. 52). Broom is lowered slowly, each side trying to keep it from turning in his hands. Loser is person who permits handle to turn.

7. Jump test. Broom is held horizontal in both hands and jumped over, without letting go. Second version: broom is on floor. Grip handle with both hands, letting it remain on floor, and jump over it.

8. Jugglery. Broom can be twirled like a baton, balanced on finger or on chin, etc.

9. Party game. Each contestant holds broom in one hand, at end of handle, and with arms outstretched. By twirling broom with the fingers, it is made to rise upward until hand touches the bristles. First to finish wins.

10. Lulu Hurst's balance test. Performer holds broom horizontally in front of body, the hands about a foot apart. Spectator grasps broom outside of performer's hands, tries to push performer off balance backward. Performer pushes up slightly on broom, forcing spectator to dissipate efforts into keeping broom level. (Fig.53)

11. Lulu Hurst's downward push test. Perfor-

## COMMENTS AND ADDITIONS

Source:

Date:





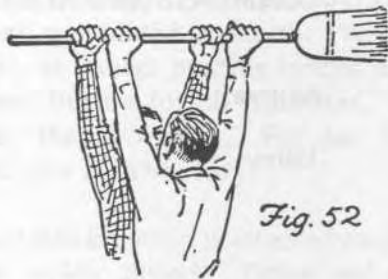

Fig. 52



Fig. 53



Fig. 54

mer holds broom as shown (Fig. 54). The hand does not grasp handle, but merely presses palm against it. Spectator tries to force broom downward until handle touches floor. Pressing palm against handle forces spectator to dissipate his energy in keeping broom in position. (A more complete description of this and the previous item will be found in "The Jinx", No. 93, an issue devoted to the feats of Lulu Hurst, the famous "Georgia Wonder.")

## BRUSH

See WHISK BROOM

1. Sight gag. Pick up hair brush, look at it as if it were hand mirror, feel chin, say, "Boy, do I need a shave!"

1. Table gag. Hold bread in left hand, knife (with butter on blade) in right. While talking, absent-

## COMMENTS AND ADDITIONS

Source:

Date:

mindedly spread butter on palm of hand instead of on bread. See H. Allen Smith, "The Compleat Practical Joker", page 221, for an account of Zero Mostel's insane elaboration of this gag.

## BUTTON

1. Button is dropped in carbonated drink. It seems to rise and fall in the liquid on command. If button is proper weight, this happens automatically, due to action of bubbles. Works with almost any small object, seed, raisin, etc.

2. Performer pulls off spectator's coat button, then replaces it. Buttons of various types, with threads attached, must be carried by performer. A button similar to spectator's is palmed. Left thumb covers real button, while duplicate is apparently pulled off. See "Tarbell Course", Vol. 3 p. 72. Max Malini's routine of biting off the buttons is given in Dai Vernon, "Malini and His Magic", p. 37.

3. Button spinner. Large button is threaded on double string as shown (Fig. 55). Ends of string are looped over thumbs. Revolving button in circles will twist string, then pulling on ends will cause button to spin rapidly, first in one direction, then the other. Excellent toy for small children.

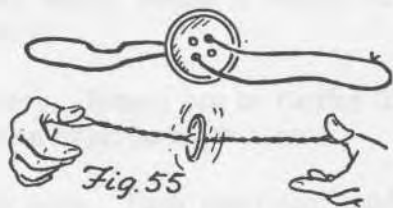

4. The five buttons. Left hand holds five small buttons. Pretend to pick one up between right thumb and forefinger, but secretly take two, the second concealed between finger and thumb. Moisten button with lips, secretly taking the exposed button in mouth. Second button is now placed on top of left fist. Right hand pretends to lift it from fist. Actually, button drops into left hand. Pretend to insert button in right ear. Show right hand empty, and open left to reveal four buttons. Same process is repeated with three more buttons, apparently inserting them into left ear,

## COMMENTS AND ADDITIONS

Source:

Date:

right eye, and left eye. Last button is handled same way, and placed in mouth. Press hand against right ear, as though pressing button into head, and allow one button to fall from lips. Repeat with left ear, the two eyes. For last button, push on nose. See BEANS, No. 1.

5. Small black button is attached to short piece of invisible nylon thread. Other end of thread is fastened to top of trouser near left pocket. Button can be carried in pocket. Place button on left palm, thread running forward between middle and ring fingers, then under hand. Cup right hand over left, move hands forward and ask spectator to grasp both wrists. Thread pulls button forward between fingers and it drops noiselessly down to hang near pocket, covered by left side of open jacket. Open cupped hands to show button has vanished.

#### CABBAGE

1. Stage gag. Performer walks on stage with sheet over head. Assistant plunges dagger through top of skull. Remove sheet to reveal fact that dagger was plunged into a cabbage carried on top of head.

#### CALENDAR

1. Children's game. Place large wall calendar flat on floor. Pennies are tossed on it and score obtained by adding squares on which coins fall.

2. Naming day of week for any date called. Manuscripts dealing with easy mnemonic methods have been published by Bernard Zufall and Wallace Lee. Lee's method is included in his recent (1950) book, "Math Miracles". See also my column in "Scientific American", May, 1967.

3. While performer's back is turned, spectator chooses any month with five weeks, and circles one date in each week. Magician asks, "How many Sundays did you mark? How many Mondays?" And so on, for the remaining days. He then correctly gives total of all circled numbers.

Method: Before turning your back, note what column the first day of month is in. Subtract one from the number of the column, multiply by five, and subtract result from 75. Thus if first

#### COMMENTS AND ADDITIONS

Source:

Date:

day falls on Tuesday, this will be the third column. One from three is two, two times five is ten, and ten from 75 is 65. Remember this final number. Begin asking the questions. Ignore the number of Sundays. The number of Mondays is multiplied by one and added to 65. Number of Tuesdays is multiplied by two and added to previous total. Wednesdays are three, and so on. Keep track of this on your fingers so you know quickly what number to multiply by after each question. Final total is the answer.

This is Royal V. Heath's handling. Gibson's original version may be found in "Annemann's Practical Mental Effects." An excellent stage presentation developed by Milbourne Christopher is explained in HMM, March, 1951.

4. While performer's back is turned, spectator draws on any calendar page a square that enclosed nine dates. Performer asks for smallest number in square and quickly gives sum of nine numbers. Add 8 to number called, then multiply by 9.

For this and similar calendar math tricks see "Annemann's Practical Mental Effects", p. 117f.

5. Mel Stover's calendar trick. Spectator draws a square on any calendar page, with a side of either three, four, or five dates. Magician writes prediction. Spectator now circles any number, then crosses out the horizontal and vertical rows in which number appears. A second number is circled, and process repeated. This continues until only one number remains. It is circled. The circled numbers are added. Magician has correctly predicted the total.

Method: for squares of three by three, multiply center number of the square by three. For squares of five, multiply center by five. For squares of four, add either of the two diagonally opposite corners and double the result.

6. Surprising as it may seem, in a group of 23 people the odds are slightly better than even that two people will have identical birthdays (considering month and day, not year). Odds increase rapidly for larger numbers. At a party of more than 23 guests you can make this unusual bet,

## COMMENTS AND ADDITIONS

Source:

Date:



have everyone write birthdate on piece of paper, collect slips, and determine from them whether you win or lose. For the mathematical basis see W. W. Rouse Ball's "Mathematical Recreations and Essays", American 1947 edition, p. 45.

## CANDLES

"Kandle Magik", by Joseph Ovette, deals exclusively with candles.

1. Blow out candle, hold match flame several inches above. Flame will travel down smoke and relight wick.
2. It is impossible to blow out candle by blowing through small end of a funnel.
3. A candle floating as shown (Fig.56) will burn all the way. As it burns, it becomes lighter and floats higher in the water.

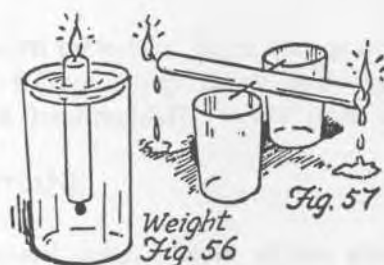

4. Candle see-saw. Push a long needle through center of candle (or use two pins – one for each side) and balance on brims of two glasses as shown (Fig. 57). As each end lowers, it drips tallow, making other end heavier. Will see-saw rapidly for hours.

5. Newspaper pictures, cartoons, etc. can be transferred to side of candle by wrapping picture around candle and running match flame back and forth along back of paper.

6. Old magic books tell how "to see the brain". Stand in pitch dark room or closet with burning candle in hand. Close one eye. Move the flame up and down near outer side of open eye so light enters on a slant (Fig. 57a). While flame is moving you will see what physiologists call "Purkinje's figures" – "like the black and bare arms of a tree." as one old science book describes them, "against a red sunset sky." They are shadows of minute blood vessels in retina.



## CANE

For tricks with prepared canes see Francis Martineau, "Walsh Cane Routines", and Hen Fetsch, "Magic with Canes". See BROOM, YARDSTICK.

1. A heavy cane can be held horizontally, with the first two fingers at one end (Fig. 58). Secret: turn hand so forefinger carries weight on the side rather than top.

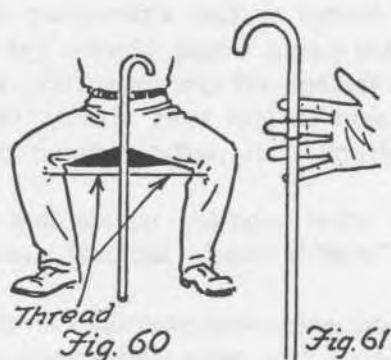
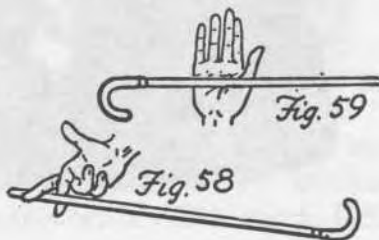

2. Cane can be balanced on flesh at base of thumb (Fig. 59) and hand held almost vertical. For Leipzig's use of this and other "grips", see "Dai Veron's Tribute to Nate Leipzig", p. 70.

3. When seated, cane is balanced on floor between legs. (Fig. 60). It is supported by thread fastened to back of each trouser leg as shown.

4. Cane appears to stick to fingers. Small loop of thread is carried over thumb and middle finger until cane is grasped, then thumb transfers loop to tip of finger (Fig. 61).

5. Revolving cane. Thread runs from hand to spot slightly off center of cane. When heavier end is released, cane makes half or full rotation. Other effects are possible with this hook-up.

6. An ancient parlor catch game. Guests are seated in a circle. A cane (yardstick, broom, etc.)

## COMMENTS AND ADDITIONS

Source:

Date:

is thumped on the floor three times while one says, "He can do little who can't do this," then cane is passed to person on left who is supposed to do exactly the same thing. The uninitiated are told they are doing it wrong and this continues until everyone catches on to the secret. The secret is to receive the cane in the left hand, then transfer it to the right for the thumping procedure. Most people of course accept cane with right hand.

## COMMENTS AND ADDITIONS

Source:

Date:

### CAPSULE

1. Paul Curry tells me he used to do this as a schoolboy. A number of capsules are pulled apart and the halves placed in a row in groove of desk, opening to left. A BB shot rolled into first capsule will turn over the capsule, roll out, enter next capsule, turn it over, and continue through all of them.

### CELERY

1. Uncouth table bit. Stick end of celery stalk in nose so foliage hangs down and say "Could I borrow a handkerchief? My nose is running."

### CELLOPHANE

1. Practical joke. Serve victim glass of warm water, with crumpled cellophane in it to resemble ice.

2. Tearing cellophane. Although you tear a strip of cellophane easily, spectator is unable to do so. An almost microscopic nick on edge enables you to begin tear. See "Phoenix" No. 23 for a subtle handling by John Scarne, or "Scarne's Magic Tricks", page 84.

Milbourne Christopher, in "Hugard's Magic Monthly", February, 1958, gave Paul Rosini's way of doing this with cellophane cigar wrapper. Before discarding wrapper in ash tray he would flatten it, secretly nick top edge in a couple of spots by pinching between nails of thumb and finger. Later, he would pick it up, easily tear it in half, hand a piece to someone to try. When they failed, he would tear his piece easily in half again.



Fig. 62

## CHAIR

1. Practical joke. Victim is directed into position shown in Fig. 62 and challenged to pick up handkerchief with teeth. When he leans forward, chair topples forward.

2. Children's party stunt. Hold chair upside down, top of chair's back resting on rug. Two children climb into chair and sit facing each other on underside of seat, their legs through the rungs. Lower chair to floor. First child to crawl free wins. Legs are so entangled that the struggle is very funny.

3. Person is seated, hands tied behind back of chair and to a rung. Purse is placed on head, and coin in mouth. Problem: to get coin in purse. Solution: let both fall to lap, spread legs so they drop to seat. Tilt backward, letting them slide off back of seat into hands.

4. Strength feat: to lift chair by grasping extreme end of one leg in one hand. Secret is to lift slightly, then push quickly forward, levering back with wrist so chair is balanced. Rest of lift is easy.

5. Strength feat. Lie horizontally on back, head resting on one chair, feet on second chair, and hips on chair between. Remain rigid, grasp center chair, lift it over body, replace under hips from other side.

6. By standing on chair, one leg on seat, other on the back, it is not hard to balance chair on the two back legs.

7. To jump suddenly from seated position (in armless chair) to erect standing position on seat, begin jump with legs on sides of chair, rather than in front. The jump is not difficult. If made suddenly, in response to some event in room which

## COMMENTS AND ADDITIONS

Source:

Date:



might cause shock or surprise, the effect on a gathering is highly amusing.

8. Chair is balanced on two legs and remains with no visible support. Small object under rug provides secret means of steadying one leg.

9. Two old chestnuts. How can you leave room with two legs and come back with six? (Come back with a chair.) How can you put three chairs together, take off your shoes, and jump over them? (You jump over your shoes.)

10. The hot seat. A spectator is asked to sit in a chair. Magician informs audience he has the power to make the chair's seat become hot merely by touching back of chair with his finger. Each time he touches chair the person seated in it jumps up. This is still a very funny stage bit, even though it goes back to previous century. The spectator is cued by a whisper to jump out of chair each time magician touches it.

11. The Irishman's wake. I quote from an old book called "What Shall We Do Tonight?"

"It is necessary for the effective performance of this trick, to curtain off a portion of the drawing-room, while the supposed "wake" is prepared. When the curtain is drawn, a long narrow coffin draped in black is disclosed, and upon each side near the head stands a man. These men are fighting fiercely, each apparently serving to annihilate the other's hat. They bang and batter each other for some moments, until they fall back exhausted upon the floor. After a moment one lifts his head very slowly and cautiously, sits up, and finally rises, and peeps over the coffin to see the condition of his prostrate foe. In a second the other springs to his feet, and deals a fierce blow at the already much-abused hat. Again the contest is renewed, and the curtain is drawn amidst the laughter of the audience.

"The stage-manager explains, either before or after the performance, that the combatants are disappointed heirs, fighting over a relative's coffin about the terms of the will.

"Going behind the curtain, we find two chairs

## COMMENTS AND ADDITIONS

Source:

Date:

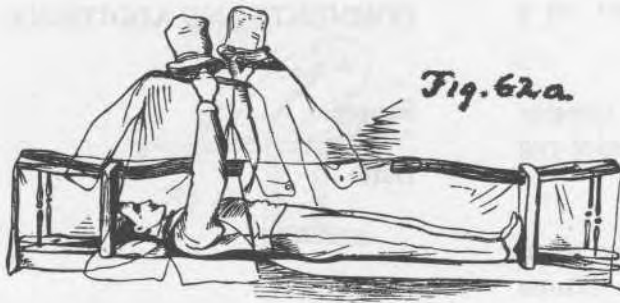

turned down, their backs uppermost, upon the floor (see Fig. 62a), and under them a tall man, whose head touches the seat of one chair, and his feet the other. Upon each arm he has another man, made in this way: in each hand he holds a stick crosswise, to make shoulders upon which to hang a coat (a coat-stretcher would be the best), which completely covers the arm, and is buttoned tight to the throat. The four fingers grasp the lining of a hat, the thumb reaching out to the edge of the rim, so as to get a firm hold. Thus the arms held out from the body appear like two men facing each other. The chairs are now covered with a large shawl, firmly pinned at the ends to the carpet.

"The dressed arms can now fight over the back of the chair which covers man's head, and by appropriate movements a most furious battle can rage, the hats especially crushing and striking each other. The exhaustion is perfectly represented by spreading out the arms upon the floor." Another description of this long-forgotten parlor stunt will be found in Professor Hoffmann's "Drawing Room Amusements", p. 167.

## CHALK

1. Left ring fingernail is secretly moistened and smeared with chalk. Show left palm, put hand under table, palm up. Right hand, holding chalk, makes chalk mark on table then rubs it out with palm. Under table, curl left hand into fist to put chalk mark at center of palm. Bring out left hand, palm up, to display mark. Rub mark off palm and repeat several times.

2. How to draw a chalk circle around someone so he can't jump out of it: draw it around his hips.

## COMMENTS AND ADDITIONS

Source:

Date:

3. Magician's joke. Do French drop with piece of chalk and ask spectator to guess which hand it's in. Each time he guesses, correctly say "That's one for you" and make a chalk mark on his lapel until he realizes it's all an excuse to mark up his coat.

#### CHECKERS

1. Problem: to remove one red checker from bottom of stack of ten or twelve black, without toppling stack. Place table knife flat on table and slide blade under stack, knocking out lower checker.

2. Problem: to remove one red checker which is third or fourth from bottom of stack of black, without knocking stack over. This is done by means of a free checker, placed on edge. Forefinger on top of checker presses down to shoot it forward, at same time giving it a backward spin. It will strike stack and rebound, knocking out one checker. Experiment to determine if checker goes third or fourth.

3. With a little practice it is possible to roll a dime in circles, figure-of-eight's, etc., around checkerboard by holding opposite sides of board and tilting it properly.

4. Eight checkers are placed in row. Problem: one at a time move a checker so it passes over two others, and is placed on next checker to form a king. In four moves, form four kings. Solution: assume checkers are numbered 1 to 8. Place 4 on 7, 6 on 2, 1 on 3, 5 on 8. When this has been solved, add two more checkers and challenge spectator to form five kings in five moves. He will probably groan at this, anticipating another long period of concentration. He seldom realizes all he has to do is jump one checker so it forms a king at either end. The remaining eight can then be solved as before!

This puzzle is included because it is the best of many counter puzzles applicable to checkers. For a listing of other puzzles of this type, see COINS.

#### COMMENTS AND ADDITIONS

Source:

Date:



## CHESS

1. While playing a game of chess, hold all the pawns you capture in your hand. At conclusion of game, they will be warmed from heat of hand. Toss into hat with equal number of pawns of opposite color. By feeling warmth, you can remove one at a time a pawn of any color called for.
2. Twenty chess pieces can often be balanced on one rook as shown in Fig. 63. This is possible only with pieces of certain design.

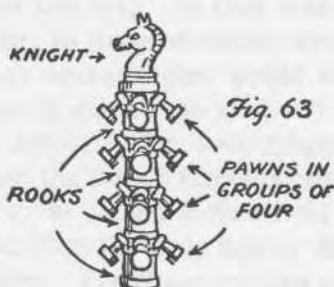

3. The three-tumbler puzzle adapts nicely to three rooks — two end rooks of one color, middle rook of another. see GLASSES.
4. A rook is held in each hand at the crotch between thumb and first finger. Each hand takes the other rook between tips of thumb and finger, and hands separate without interlocking. See CORK, No. 1.
5. A pawn placed on its side is made to roll mysteriously in a circle on the board as magician moves a hat in circles above it. Secretly blow against pawn each time it comes around. Hat is used to hide lips.

## CIGAR

The reader who is interested in sleight-of-hand with cigars is referred to Jack Chanin's "Cigar Manipulations", an 80-page booklet on the subject. Many cigarette tricks and moves will apply, of course, to cigars.

1. Grasp cigar between first and second fingers, palm facing audience and thumb on top of cigar. Remove cigar from lips and rotate hand forward.

## COMMENTS AND ADDITIONS

Source:

Date:



Position of thumb enables you to give cigar a full revolution, so that original end is returned to mouth. Gives a strong illusion of placing lighted end in mouth.

2. Present cigar to friend by pushing it into breast pocket of coat. Fingers clip end and take cigar out again, but it is allowed to drop into sleeve so that hand comes away empty. Later he fails to find cigar.

3. Magician places palm on cigar, raises hand. Cigar sticks to palm. Magicians with moist palms can do this at any time, without gimmicks. John Scarne likes to open one end of wrapper, pick cigar up in this manner, then tilt hand to the vertical. Cigar drops to table leaving wrapper still adhering to hand.

4. In this version of above effect, cigar sticks to fingers so firmly that hand can be shaken. A pin or piece of toothpick is secretly pushed into cigar and clipped between second and third fingers. Cigar can be passed from hand to hand by rolling it between fingers so pin rotates backward from one hand to other.

5. Large flames flare up from end of cigar while it is being lit. Draw in smoke first, then blow it through cigar into match flame.

6. With practice, cigar can be made to pop suddenly from mouth, going several feet before it is caught in mid-air. This is done by squeezing lips on rounded end, before it has become soggy, shooting cigar forward like a cherry seed (Roger Montandon).

7. Magician lights cigar by scratching it on match folder. End of wooden match previously pushed into top of cigar.

8. The following trick of mine is reprinted from "The Sphinx, December 1952. (See also "The Dai Vernon Book of Magic," page 96.)

If you smoke cigars, you'll find this an amusing impromptu bit, with strong elements of both surprise and humor. It also works out well as a

## COMMENTS AND ADDITIONS

Source:

Date:



comic interlude for an emcee, or comedy stage magician.

Take the cigar from your mouth, holding it with the tips of the right fingers just above the burning end, as shown in Fig. 1. The handkerchief is held by the left hand at the center of one hem. It should be chest high.

The right hand carries the cigar behind the handkerchief, then moves forward and upward. To the



audience it must appear as though the end of the cigar goes against the center of the cloth, lifting the handkerchief from the left hand in a tent-like formation.

Actually, what happens is this. As soon as the cigar is hidden behind the handkerchief, the index finger is extended. The remaining fingers retain their hold on the cigar, and move to a horizontal position, so that the cigar points directly toward your chest (Fig. 2).

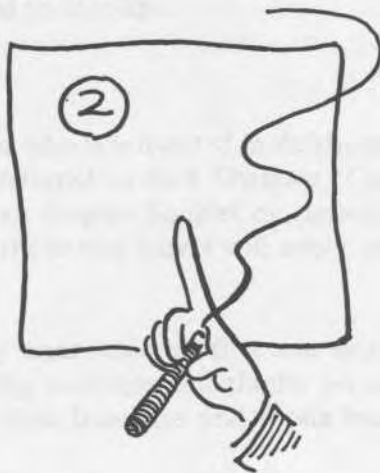

## COMMENTS AND ADDITIONS

Source:

Date:

The index fingertip is placed against the center of the cloth. The right hand now moves forward about six inches, then upward, lifting the cloth with it (Fig. 3). Throughout this entire operation, the left hand remains stationary. It is not a matter of covering the cigar with the cloth, rather the cloth is held still, and the cigar seems to lift it from the left hand. The reason for doing it this way is that it provides a natural reason for raising the cloth upward until it is directly in front of the face. The raising should be one continuous, sweeping, upward motion, which automatically brings the handkerchief to the level of your face.

It will now be found a simple matter to grasp the end of the cigar, which is pointing straight backward, with your mouth. This action is hidden by the cloth. There should be no sudden motion of your head forward when this is done. Instead, the right hand should be brought close enough to the face so that the end of the cigar can be grasped by the lips without a motion of your head.

At this point, raise the left hand and pretend to take the cigar through the cloth as shown (from the front) in Fig. 4. The left hand, apparently holding the cigar, carries the cloth to the left (Fig 5). This exposes your face, with the cigar in your mouth, but if you look intently at the handkerchief, the audience's attention will be directed there also. They will not immediately be aware of the cigar, even though it is in plain view.

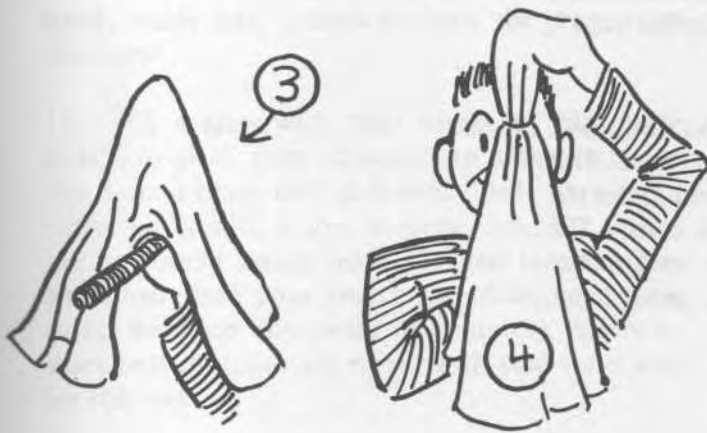

## COMMENTS AND ADDITIONS

Source:

Date:



Faint, illegible text, possibly bleed-through from the reverse side of the page.

Faint, illegible text, possibly bleed-through from the reverse side of the page.

Faint, illegible text, possibly bleed-through from the reverse side of the page.

Faint, illegible text, possibly bleed-through from the reverse side of the page.

## COMMENTS AND ADDITIONS



Source:

Date:

Seize a corner of the handkerchief with your right hand and whisk it from the left. Show both sides of the cloth to prove the cigar has disappeared, meanwhile puffing on it vigorously. At this moment most spectators do a double-take as they suddenly realize the cigar is mysteriously back in your mouth!

9. Jumping cigar band. Band is placed on tip of middle finger. Left arm is extended horizontally. Right hand rests first and second fingers against sleeve, in V formation. Hand is moved quickly to right, then back against sleeve. Band has jumped to other finger. This is done by lowering index finger and raising ring finger. For fuller details see HMM, July, 1945, or my "Over the Coffee Cups", p. 20.

10. Magician holds cigar at each end (Fig. 64). The band moves mysteriously back and forth. This works only with cigars which have band under the cellophane. Wrapper is open at both ends. The hidden thumbs squeeze ends of cigar so it moves slowly back and forth under the cellophane, making the band appear to move.

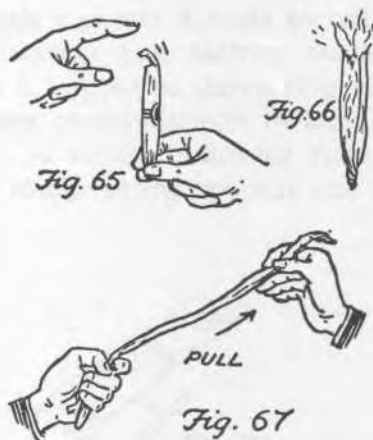

Fig. 64



11. Loosen the little flap of cellophane at one end of wrapper. Rub left finger on sleeve to generate "static," then hold it above cigar (Fig. 65). Flap rises mysteriously. Accomplished by squeezing slightly on lower end of cigar.

12. Remove wrapper by sliding cigar out of one end. Twist other end so it is tightly closed, and hold vertically (Fig. 66). When upper end is lit, smoke will travel downward filling the wrapper.



13. Magician pulls cellophane from borrowed cigar. It keeps coming, until five or six feet have been removed. The long cellophane in compressed form, can be obtained from florists who use it for covering stems of bouquets. This is held in hand back of cigar, and pulled upward out of fist (Fig. 67).

14. Cigar is balanced vertically on crown of hat; or balanced on side, given a spin, and made to revolve. Both feats employ a pin which the left hand, inside hat, pushes through the crown and into cigar.

15. Fill a glass with cigar smoke by blowing a puff into glass, then covering top with hand. Do this several times until it is well filled. In a room where air is still, if you exercise care, the smoke can be poured slowly from one glass into another, and finally into your mouth (by tilting head back so smoke pours downward into mouth). Seems to work best if glasses are rinsed with cold water and are still wet.

15a. For Leipzig's cigar-from-purse routine, see "Dai Vernon's Tribute to Nate Leipzig", p. 86.

## COMMENTS AND ADDITIONS

Source:

Date:

16. Gag ending for club act. Borrow cigar as though preparing to do final trick. Ask spectator if he is sure it is a good cigar. Light it, take several puffs, nod, and say, "You're right, it is a good cigar. Thank you very much." Then make exit.

17. Wipe palm downward over face, clipping cigar as hand goes by, and blowing smoke from mouth as soon as hand leaves face. Cigar seems to vanish. This calls for large hands.

18. In reaching up to clip cigar between first and second fingers, miss cigar and clip nose. Or left hand can be holding cigar. Reach up to take from mouth, clipping nose instead, then notice mistake and clip cigar.

19. In placing cigar in mouth "accidentally" miss mouth and poke end into eye. (Dorny).

20. While talking about how calm you are, and free from nervousness, raise cigar and flick ashes on head. Sentator Crandall remarks at this point, "Very bad for the hair, but good for dandruff". Ashes can also be flicked into breast pocket.

21. At table, salt end of cigar, remarking, "Very cheap tobacco." (Crandall)

22. Trim end of cigar with a giant pair of shears carried in coat pocket. (Crandall).

23. Drunk bit. Take cigar out of wrapper, toss away cigar, try to light end of wrapper.

24. Sight gag. Black mustache is taped to end of cigar. When you take cigar from mouth, your mustache comes with it.

## CIGARETTE

For cigarette tricks involving manipulation, tonguing, gimmicks, etc., the reader is referred to Keith Clark's well known "Encyclopedia of Cigarette Magic and Manipulation", other books on the subject, and the relevant sections of standard works of general magic.

1. Two cigarettes are on table, a few inches apart.

## COMMENTS AND ADDITIONS

Source:

Date:



Finger circles them a few times, then moves along table between them. Cigarettes roll apart. Secretly blow between cigarettes, or have stooge opposite you do the blowing.

2. Cigarette is placed crosswise over center of wooden match. When finger is held near one of the ends, the cigarette rotates on the match as though the end were attracted by finger. Same method as above.

3. A single cigarette is made to roll toward you in such manner that blowing seems precluded. Left arm is in position shown (Fig. 68). Blowing against arm causes cigarette to move in opposite direction, as though following finger. Another method: stooge sitting opposite you blows cigarette.



4. Seance effect. Burning cigarette is propped upright by wedging between drawer and cover of match box. In the dark the burning end flares up at intervals in response to questions. Secret: stooge sitting near cigarette blows on end. (George Schindler).

5. Cigarette apparently shoved up nose, then pulled out of mouth. Actually, it slides into hand, then mouth grips end, and hand slides back along it. Note: the move is more effective if cigarette is first drawn horizontally across upper lip until tip reaches nostril, then hand lowers and pretends to push upwards. Move fingertips immediately to lips. When pretending to withdraw from mouth, be sure to stop when fingers reach end of cigarette, then take cigarette from lips.

6. Cigarette apparently pushed through nose from one side to other. Two cigarettes used. One slides into the hand as fingers of other hand slide free to duplicate. Thumb keeps duplicate pressed against side of nose, as fingers move back to expose it.

## COMMENTS AND ADDITIONS

Source:

Date:

7. Lighting cigarette inside of mouth. Burning paper match is held against end of cigarette (Fig. 69). Place in mouth, match resting on lower lips. Blow. Smoke will issue from cigarette as end

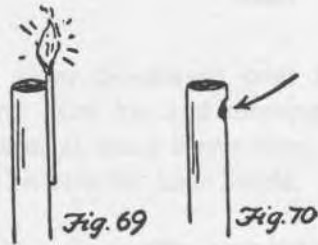

inside mouth lights. When cigarette is taken from mouth, paper match adheres to lower lip. Remove match and smoke cigarette.

8. Place lighted end of cigarette in mouth, the lips (which should be moistened first) grasping it at center. Light other end. Moisture from lips makes it easy to bite cigarette in half. Apparently remove cigarette and toss away. Actually, take outside half only. Other half remains on tongue in familiar reversed tonguing position. It can be turned over by tongue and pushed suddenly into view.

The bite-in-half principle can be worked into many routines. For example, with outer end of cigarette lit you can bite in half, right hand removes burning stub and pretends to put it in left hand, actually palming it. Slap top of head with left hand, simultaneously pushing unlit half from mouth. Seize it quickly, before anyone notices it is unlit, and toss to floor, step on it, then reproduce burning cigarette in right hand, puff on it, discard.

9. A cigarette can be put out on tongue without injury. Get plenty of saliva on tongue. Tap the burning tip gently on tongue, making each tap on different spot. Cigarette will go out quickly and you scarcely feel the heat. Have handkerchief handy to clean ashes from tongue.

10. Secretly touch burning end with saliva on finger. It will form an unnoticeable hard carbon tip. Cigarette can now be held with thumb and finger at each end, without burning finger. A few draws will remove carbon tip, so cigarette can be handed out in case someone else wants to try.

## COMMENTS AND ADDITIONS

Source:

Date:



11. Second method. Before showing, hold ice cube between thumb and finger. You can now borrow a lit cigarette, hold it for a moment with burning end against thumb, then turn it and hold a few seconds with burning end against forefinger.

12. Cigarette can be lit by holding match flame six inches or more directly below end. Draw on cigarette. Rising fumes will ignite end.

13. Flame rises several feet upward from match to ignite cigarette. A black thread hanging from tip is used. Experiment to find right type of thread. Piece of flash paper at end of cigarette is necessary to make cigarette light, and also adds to effect.

14. Cigarette is secretly lit at point shown (Fig. 70). Hold so this doesn't show, while other hand strikes match. Place in mouth, side of face toward spectators, and cigarette turned so it still appears unlit. Match is held several feet from mouth. Draw on cigarette. It appears to light from distant match.

15. Cigarette is placed on table edge with more than half projecting, but does not fall. Saliva on underside of end does it. Press against table to make stick.

16. Magician seems to inhale on cigarette, but when he exhales, no smoke appears. The inhale is faked by blowing through cigarette, causing end to glow brighter.

17. At any time, a tiny cloud of smoke can be made to issue from mouth. Keep mouth tightly closed, and by pressure of mouth and cheeks, compress the air inside mouth as much as possible. Open mouth and let air drift out. The sudden expansion of air causes it to condense and produce small cloud of vapor. Patter about bringing up smoke which has remained in lungs from last cigarette.

18. King size cigarette is carried diagonally in a half-full pack (Fig. 71). Remove two cigarettes, including the long one. Place both flat on table in T formation. Fig. 72 shows performer's view.

## COMMENTS AND ADDITIONS

Source:

Date:



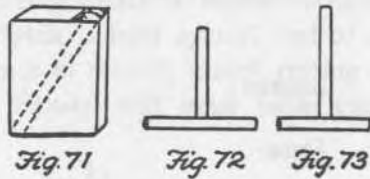

Fig. 71

Fig. 72

Fig. 73

The long cigarette is top of the T from spectator's side. Because of the familiar optical illusion, the cigarettes appear of same length. Right hand picks up long cigarette while left hand remains on table. As eyes follow the lifting, left hand casually changes other cigarette to horizontal position. Pretend to stretch cigarette in your fingers. Replace on table as shown in figure 73. The illusion now causes the "stretched" cigarette to appear a full inch or more longer than the other! (Based on suggestion of photographer David B. Eisendrath, Jr.)

19. Annemann's "Master Touch". Carry a cigarette that has been exposed several days to open air. Borrow or have someone purchase a fresh pack



Fig. 74

of same brand. Dump cigarettes in hat. The cigarettes in hat. The cigarette you have been carrying is secretly palmed into hat. Remove it, have it initialed, and drop back in hat with the others. Hat is shaken. Even though you wear a pair of gloves, you can find marked cigarette easily when hat is held above line of vision. Merely squeeze each cigarette. Marked cigarette will be noticeably harder than others.

19a. If a cigarette is pinched and rolled slightly, the softened spot can be felt with fingers. This permits effect similar to one above. Pack of filter tips is borrowed, three cigarettes initialed before all are dropped in hat. Initialed cigarettes are marked by pinching one just below filter, one in center, one near end.

20. Magician correctly names all brands in blind-fold test. One method: look down side of nose to

## COMMENTS AND ADDITIONS

Source:

Date:

read brand name. Second method: give out different brands, remembering who gets what, and memorize each person's shoes. As each spectator steps toward you to blow off smoke in your face, you spot shoes and name brand.

21. Cigarette rises from pack. It is held behind a half-empty pack (Fig. 74) and pushed upward with thumb. If desired, cigarette can be inserted between pack and cellophane. Pack can now be handled freely as both hands are shown, then made to rise as before. See also No. 60 below.

21a. Thread gimmick for rising cigarette. Thread is a trifle longer than cigarette, with pin at one end, tiny bead at other. Pin goes into end of cigarette and cigarette goes into pack, pin side down, with bead hanging over top edge. Remove two cigarettes from full pack so gimmicked cigarette can slide freely. As left thumb in back of pack slides bead downward, cigarette rises out of opening. Keep thumb on bead so right hand can lift cigarette free of pin. As you put cigarette in mouth, left hand lets thread fall unnoticed to floor and pack can be handed out for inspection. With razor blade and rubber cement, a pack can be prepared so it seems to be new. You then apparently open a new pack from which cigarette is caused to rise.

22. Rolling cigarette in mouth. Cigarette with waterproof paper is previously placed in lower part of cheek. Tobacco pouch contains bran. Spread bran on cigarette paper, then put both bran and paper in mouth. The bran is chewed and swallowed, the paper rolled into ball and concealed in cheek. Cigarette is pushed slowly out of mouth with tongue.

23. Magician goes out of room, returns and locates mentally selected object. Stooze uses cigarette in his mouth to point toward object. As you explore area, he signals correct object by tilting it upward.

24. Reading in dark. Burning cigarette is on ash tray near you when lights are turned out, or handed you by stooze. Keep cigarette concealed behind hand. By cupping hand over pages of a book, there will be sufficient light from burning

## COMMENTS AND ADDITIONS

Source:

Date:

end to enable you to read lines aloud. Crush out cigarette before lights are turned on.

25. A cigarette is struck like a match and used to light one in mouth. Match is pushed into head of cigarette used for striking.

26. Cigarette apparently tossed away, then reproduced from air. Hand secretly breaks it in half. Toss away unlit half, then take other half from air.

27. Scorch the end of a cigarette and secretly place it on chair, under thigh. Borrow a smoke, light it, lower hand, switch for prepared cigarette, leaving burning one on chair. Notice that your cigarette has gone out. Request a second light. "I don't know why I cause you all this trouble," you can say. "Being a magician, I could have produced a cigarette like this." Right hand has secured burning cigarette which is now produced from the air (Robert Parrish).

28. The familiar stunt with three paper balls, in which you keep tossing one away and it returns, adapts beautifully to pieces of a cork-tipped cigarette. Break cigarette into three parts. Place two pieces in left hand and pretend to toss part with tip under table. It keeps returning. An extra piece with the tip is, of course, used. If you wish, have several such pieces on chair between your legs. The cork tip can now be visibly tossed away, or even handed to someone to throw away.

As left hand rolls out three pieces, right hand lowers to chair and picks up extra piece again.

Bill Nord has an amusing finish. Prepare a cigarette in advance by cutting into three pieces and rubber cementing together, but with cork tip in center. This cigarette is in left sleeve. Routine apparently ends with familiar vanish of all three pieces (right hand retains first two, then picks up third and throws all three on floor or drops in pocket). Lower left hand (stand up if you wish) to secure cigarette from sleeve. Pretend to pick each piece one at a time from the air and push into left fist. Squeeze hand, then open to show restored cigarette. Apologize for putting it together wrong.

## COMMENTS AND ADDITIONS

Source:

Date:



Note: Vary the basic sleight by sometimes dropping extra piece with the second one, sometimes with first. In the latter case, left hand remains closed after first toss, and second piece is dropped into top of fist. Nord suggests a third variation. After left hand opens to show three pieces, adjust pieces so cork tip is in position to be clipped at base of second and third fingers. Left hand apparently dumps all three into right hand (which contains extra pieces), actually retaining cork tip. Right hand immediately hands the three pieces to spectator, who drops first two into your closed left fist, then tosses away cork tip. This is a good variation to use just before the vanish. Cigarettes without cork tips can also be used, of course, as well as smoked cigarette butts.

29. Jarrow's tobacco trick. A cigarette is in left sleeve. Borrow cigarette, break open, and dump tobacco in spectator's hand. The paper is wadded into small ball. Right hand is extended and spectator dumps tobacco into it. With left fingers, form it into compact lump. As spectator places ball of paper into center of tobacco, left hand lowers to secure cigarette from sleeve. Bring hand together, tossing tobacco up left sleeve. Reveal restored cigarette.

30. Slide cellophane off pack of Camels so it covers only the word CHOICE on side of pack. Explain that cellophane has peculiar refractive properties. Hold to mirror (or show reflection in polished table knife). The word QUALITY is reversed, but CHOICE (due to construction of letters) is unchanged. Another presentation: read the words through a glass swizzle stick held slightly above the printing. The effect is the same.

31. Slide cellophane partly off pack and touch burning end of cigarette to it to form a small hole. Take off cellophane, puff smoke into it, replace. Tapping back of cellophane will cause smoke rings to issue from hole (Fig. 75).



## COMMENTS AND ADDITIONS

Source:

Date:

Any small cardboard box with hole cut in side can also be used, and there is a way to fold edges of six playing cards, or business cards, to make a cubical box that works well.

32. Prepare cigarette by coating edges of each end with rubber cement. It can be cut in half, the prepared ends stuck together, and the "restored" cigarette smoked.

33. Rubber cement on middle fingernail and tip of cigarette (or piece of double-sided cellophane tape) permits you to take cigarette from pack and vanish it by the familiar sleight in which gimmick is used to attach it to back of middle finger. Can be used for continuous production of cigarettes from air, bending finger for the catch, straightening it as cigarette is apparently tossed in hat. (Dr. Ralph Hale.)

34. Publicity stunt. Prepare a pack by inserting rolled five dollar bill in place of one cigarette, and re-seal. Buy similar brand, and while clerk is getting change, secretly exchange packs. After taking change, ask clerk if he's aware of fact that company is putting bills inside some of the packs to stimulate trade. Open pack and remove bill.

35. Slydini's broken and restored cigarette. Burning cigarette is apparently broken in center and put together again. This modern masterpiece of impromptu table magic is available as "Cigarette Miracle" in the "Stars of Magic" series. A second method is in Lewis Ganson, "The Magic of Slydini", page 51f, a third in Leon Nathanson, "Slydini Encores", page 115f. Many other methods have been published for broken (or cut) and restored cigarettes, with varying degrees of advance preparation, but Slydini's three methods are hard to improve.

35a. Slydini's two cigarettes from one. A cigarette is broken in two halves, each of which is stretched into a full-size cigarette. Another Slydini masterpiece, the moves of which are given in the two Slydini books cited above.

35b. Certain cigarette boxes, such as Marlboro, are made with secret pockets in front between double layers of cardboard. Uses of the pocket are discussed by Milbourne Christopher in HMM,

## COMMENTS AND ADDITIONS

Source:

Date:

December 1956, and Larry Becker in "Genii", December 1956.

## COMMENTS AND ADDITIONS

Source:

Date:

35c. The plastic wrapping around a cigarette box will retain an impression of what is written on a slip of paper, held against the box, if writing is done with a sharp-pointed hard lead pencil or ball-point pen. Impression is read by viewing it in slanted light.

35d. Magnetized cigarettes. Two cigarettes are prepared by coating one end of each with rubber cement. Take from pack and pretend to magnetize a cigarette by pointing it toward north pole and tapping it. Touch unprepared end to prepared end of other cigarette. Nothing happens. Repeat, but this time touch prepared end to prepared end. One cigarette can now be suspended from the other. Hold vertically, then horizontally, and finally break apart and let one hang vertically at right angle to edge of other cigarette.

35e. If a tiny sliver of celluloid is rolled in cigarette paper it makes a tiny cigarette that can be inserted in the mouth of a face in a photograph or on a cigarette package and when lit, will puff smoke at intervals. The celluloid can be obtained from certain collar stays, teeth of combs, etc., or bought in magic stores. For various routines see HMM, June 1952, p. 947, March 1953, p.1051, 1055, April 1953, p. 1064, May 1953, p. 1077, 1080, June 1953, p. 5; and "The Phoenix", June 27, 1952.

35f. Filter tip is palmed in right hand. Shake a cigarette up from pack and pretend to take it, but let it fall back in pack and display tip projecting from right hand as though holding the cigarette. Put tip in mouth, cup hands around it, lean forward for a light. Tongue the tip, clap hands together, cigarette has vanished. (Perry Robinson).

35g. Cigarette from nowhere. In this classic effect the magician pretends to roll a cigarette, using invisible paper and tobacco, puts it in his mouth, strikes match, and when hands come away, he is seen smoking a cigarette. Numerous methods have been published using gimmicked match boxes and folder. For the standard prepared box method, see "Tarbell Course in Magic",

Vol. 2, p. 143. For George Sand's excellent impromptu method using unprepared match folder, see "Tarbell", Vol. 6, p. 353.

35h. Cigarettes are continually produced from air by right hand, taken by left hand and put in pocket, the routine ending with production of cigar or pipe. Various sleights have been devised, all based on the same principle of retaining cigarette in left hand and loading it back into right as the new cigarette, just produced, is taken. I know of no simpler or better handling than the one worked in HMM, March 1959, and which also can be found in "Tarbell", Vol. 6, p. 351.

35i. Jim Reneaux's vanish of burning cigarette. Hold vertically in left hand and cover with paper napkin formed into a cone. Right hand pinches off burning end, just below the light, and carries napkin forward as left hand laps rest of cigarette. Allow burning tip to burn a hole in napkin, then drop napkin on a plate and smash it flat with left palm. Cigarette has vanished except for bit of ash and tobacco. ("Phoenix", Feb. 20, 1953)

35j. Secretly get some ash on right thumb. Ask spectator to hold out both hands, gesturing with your palms up so he holds his hands, palms up. Seize each hand and turn it palm down, asking him to close his hands into fists. In doing this, your thumb adds smear of ash to his right palm. Give him magician's choice of fist, so regardless of choice, his left hand is dropped to side. Pretend to pick up pinch of ash and sprinkle it over his right fist. He opens hand, finds ash on palm.

35k. Small pile of ash is on white table cloth. Tap it about ten times with palm of hand. Raise hand and ash has vanished without a trace. (It works into the cloth.)

See PENCIL for a number of pencil through hank effects that can be done with burning cigarette, especially Nos. 8 and 10.

36. Burning end of cigarette is pushed against center of borrowed handkerchief, but does not damage it. Half dollar is secretly palmed in left hand. Cloth is draped over hand. Press burning end against coin, which absorbs the heat and prevents singeing. Coin can also be placed under

## COMMENTS AND ADDITIONS

Source:

Date:



table cloth, allowing you to rest burning cigarette on cloth and pick up later without damaging cloth.

37. Handkerchief penetration. Spectators hold four corners of handkerchief. Square of paper rests on center. Magician apparently pushes burning cigarette through cloth and paper. Best description in print of this classic is Jarrow's "Hanky Panky" in "Stars of Magic" Series. See also p. 750 of "Greater Magic".

A clever idea of U.F. Grant, in a manuscript on the trick titled "Dawn", is to break cigarette in half under hank, then as right hand shows unlit end at side of cloth, left hand, with burning end, takes edge of paper and moves it to center of hank. After cigarette has burned through paper, right hand pinches unlit end against lit end so edge of hank can be raised and it appears as if burning cigarette has gone halfway through cloth. Pretend to break off lower half, remove lit end, show cloth undamaged.

If you use the Jarrow handling it is best to break off the end of a freshly lit cigarette before starting trick. This not only shortens the cigarette, making it easier to conceal, it also does away with the saliva on the end which tends to leave a nicotine stain in center of borrowed handkerchief. Don't make mistake of pulling cigarette all the way through paper. Glowing ashes are likely to fall through the hole and burn the cloth. Pull it halfway through, then lift aside both paper and cigarette. If you do the trick for a sizeable audience, have your two assisting spectators hold hank so it slopes forward and everyone can see what is happening.

38. The familiar thumb tip method of vanishing short burning cigarette can be made impromptu by using any of a number of easily procured metal or plastic gadgets — thimble, top of lipstick container, etc. Can't show hand empty, of course, but as long as thumb can cop gimmick, the trick is effective. (Bill Nord).

A lipstick cylinder (or fountain pen cap) can also be used as follows. It is palmed in left hand. Left hand is covered with hank. Burning cigarette is placed under hank and into cylinder. As right hand slowly pulls hank off fist, its fingers clip the cylinder, drop it in hank pocket of jacket.

## COMMENTS AND ADDITIONS

Source:

Date:

39. A burning cigarette is placed under handkerchief and grasped through the cloth by left fist. The cigarette rises upward from fist as cloth is twisted by other hand. The best handling known to me of this beautiful effect is in Keith Clark's "Celebrated Cigarettes", 1943.

40. "Immovable cigarette." Handkerchief is draped over left fingers, which grasp lower end of a burning cigarette through the cloth. As cloth is pulled free of fingers, the cigarette remains motionless. For full description, see "Tarbell Course", Vol. 5, p. 53.

The move can also be used for a penetration. Simply turn left hand over, letting cloth fall downward. Right hand pulls hank downward, leaving cigarette in left fingers.

41. "Pop through cigarette." Burning cigarette is held vertically at finger tips and covered with handkerchief. It seems to pop suddenly upward through the cloth. Descriptions may be found in "Jinx", winter extra No. 40 (1937-38); "My Best", p. 166; and "Tarbell Course", Vol 5, p. 52.

41a. The move of CIGAR, No. 8 can be used for vanish of burning half-cigarette. It is simply tongued as left hand takes cloth from right.

41b. Penetration of unlit cigarette. Left hand holds hank at middle of an edge, clipping it between full depth of first two fingers. Cigarette vertical in right hand. As left hand covers cigarette with cloth, it is clipped by crotch of left thumb. Right first finger is extended upward to simulate cigarette under cloth. Left hand, adjusting cloth, leaves cigarette in back of hank. As right first and second fingers grip it through cloth, thumb pushes it slowly upward into view. (Art Lyle, HMM, April 1962.)

41c. Similar to above, but with burning cigarette. Hank is draped over left arm. Right hand, holding cigarette with burning end up, goes behind hank, leaves cigarette clipped by left ring finger and pinky. Right first finger simulates cigarette under cloth. Left hand leaves cigarette in back of hank as in above effect, burning end just out of sight, then right thumb quickly pushes it up into view.

## COMMENTS AND ADDITIONS

Source:

Date:

## Puzzles

## COMMENTS AND ADDITIONS

42. Place six cigarettes so each touches all the others. Fig. 76 shows the solution.



Fig. 76

For a newly discovered solution with seven cigarettes, see my "Scientific American Book of Mathematical Puzzles and Diversions", p. 115.

43. To tie a king size cigarette in knot without breaking. Remove cellophane from pack, tear it down the side and open it out to form a rectangle. Wrap cigarette tightly as shown in Fig. 77. Twist ends of cellophane, then tie in knot (Fig. 78). It can even be stamped on with the feet. Unroll, and smoke cigarette.



Fig. 77



Fig. 78

44. To bend cigarette double without breaking. Place in lips long enough for end to become slightly moist, then remove and gesture with cigarette as you request light. Under cover of gesture, reverse ends. Moistened end is lit. After a few drags the tobacco will be moist throughout, and you can bend the cigarette double, or even into "S" shape. Straighten it and continue smoking. No one else is able to duplicate feat. (Bill Nord's handling).

45. To "smoke" cigarette without placing in mouth. Cup hands, holding cigarette at crotch of thumbs. By squeezing hands you can make it "puff" smoke.

46. To form smoke rings without using mouth. Hold cigarette vertically and lower suddenly. A small smoke ring will float upward. Air must be still.

Source:

Date:

47. To make a "cigarette lighter." (a) Break off a piece of cigarette, making it "lighter." (b) Take one out of a friend's pack, making his pack a "cigarette lighter." Unsubtle method of bumming cigarettes.

48. How many times does "are" appear on Camel cigarette package? (The standard small size, not the king size, package.) Answer: Three. Once in the word "cigarette" twice in the word "cigarettes."

49. Is the camel male or female? Point inside and say, "Female. See all the little camels inside?"

50. Find the date 1914. The figures are the first four letters in lower left corner of paragraph on back, viewed upside down.

51. Without showing pack, ask if the man is in front or back of camel? Answer: there isn't any man.

52. Find the lion. Cover camel with match folder so only hump and back part, including tail, are visible. Appears to be upper part of a lion.

53. How many E's are on back of pack? Few will find all on first count. Answer is 14.

54. Show front of pack and ask, "If you had to spend the night on this desert, where would you sleep? Under the trees, by the pyramid, or somewhere else?" After the reply, turn pack around, and say, "Why don't you go over here and stay at the hotel?"

55. Find the word "equal." On the side that says "Choice Quality" cover the "Choic" with left thumb, and "ity" with right thumb. Between thumbs will be the word "equal."

56. What word on the back can't be covered by a quarter? "Prohibits" - it's hyphenated, the two parts widely separated.

57. Form an anagram from the letters in "Camel." There is only one, and only a geologist is likely to find it. "Macle" - a twin crystal, or a dark spot in a mineral.

## COMMENTS AND ADDITIONS

Source:

Date:



*Camel Cigarettes have changed package patterns from time to time, but this diversion is very interesting among smokers and should not be forgotten.*

*Using the material here as a guide-line, go carefully over current wrapping on cigarette packs and work out new ideas. Everyone gets interested - great ice breaker and conversation maker.*

*Don't forget liquor bottles, beer cans, etc.*



53



## Jokes and Gags

## COMMENTS AND ADDITIONS

58. Cigarette projects halfway from pack, held in place by pressure of fingers and thumb. Offer to friend. As he is about to grab, let cigarette drop into pack so his fingers close on empty space.

Source:

Date:

59. An inch-long piece of cigarette is held in place by thumb and fingers so it seems to be a cigarette projecting from pack. This is what friend takes when he is offered a smoke. (Johnnie Murray).



Fig. 79



Fig. 80

60. Secretly make a slit in pack and insert cigarette as shown (Fig. 79). Pretend to shake a cigarette upward, really pushing it upward an inch or so with thumb. Extend pack to friend, holding it so thumb side is concealed from his view. As he reaches for smoke, thumb jerks it back inside. You can now wave hand over pack and cause cigarette to rise upward by pushing it up with thumb.

61. Vanish a bill. Borrow a pack of cigarettes. Break open a cigarette, but fail to find bill. Break open another. Continue until friend grabs pack or slugs you.

62. A borrowed cigarette is smoked until there is plenty of ash. When no one is watching, take from mouth, hold burning end close to lips, then suddenly explode a puff of air at the end. Ashes will fly over table and sound of your puff will create a perfect simulation of exploding cigarette. Pretend that friend who gave you the smoke has played a prank on you. This will puzzle him considerably. (A favorite gag of Max Terhune).

63. Stick a couple of pieces of cigarette between lips (Fig. 80) to make imitation buck teeth, and grin.

64. Blow a smoke ring, reach out and grab, squeeze, then drop metal ring or washer on table. (Frank Lane).

65. Cigarette ash gets longer and longer as you flourish cigarette dangerously over people's laps, etc., while talking. If someone calls it to your attention ignore it, or remark that because you are a magician, the ash won't fall. The longer ash gets, the funnier. A wire pushed into cigarette does the trick. Toothpick will not work, but a two-inch piece of paper clip or hair pin works fine.

66. Draw a mouthful of smoke when no one is watching. Insert cigarette in ear. This should focus all eyes on you. Breathe in and out several times through nose, then take a deep and noisy inhale. Open mouth and let smoke drift out. Even funnier: have stooge pretend to inhale (See No. 16 above), then blow into your ear while you simultaneously blow out smoke.

67. Place two cigarettes under upper lip (Fig.81),



Fig.81



Fig.82

slap backs of hands together like flippers, say "Oink! Oink! I'm a walrus!"

67a. Take a long steel chain out of pack. Say, "I'm a chain smoker."

67b. If a small hole is made in middle of cigarette, you can light both ends and puff through the hole.

67c. Toss cigarette around room while you shout, "Live! Live! Live!" Then put one in your pocket and add, "I gotta live too!" (Francis Carlyle)

67d. Light cigarette, then toss it away and put fingers in your ears as if it were a bomb.

67e. Old stage bit. Someone asks you what you do for a living. As you light cigarette with shaking hand say, "I'm a brain surgeon," or "I fix watches."

## COMMENTS AND ADDITIONS

Source:

Date:



67f. Wrap one of those midget-size cigars in cigarette paper. Slit paper, remove it, light it and pretend to be smoking the tobacco.

67g. Take ashes from a tray and carefully form three piles of ash on the bar or table cloth, then say: "Will the real Joan of Arc please stand up."

67h. Cut off a filter tip, remove the inside material, slit it, put it around end of a nonfilter cigarette, fastening the slit edges with cellophane tape. The fake filter tip must slide along cigarette. Put in mouth with filter end out. When someone points out you have cigarette reversed, just slide the filter up to your mouth. Or slide it off the cigarette and say, "I can't stand filters." Or display cigarette with filter at center and say you've invented a filter cigarette one can smoke from either end. The sliding filter also has magic possibilities (see Jimmy Herpicks's cigarette and matchbox trick in "Phoenix", Feb. 19, 1954.)

### Jugglery

68. One cigarette can be balanced on top of another as shown (Fig. 82). Secret: place ends together and roll joint between thumb and finger. The tobacco mixes slightly and holds cigarettes in place. (Logan Wait).

69. Start with burning cigarette under nose (Fig. 83). Let fall to lower lip (Fig. 84). then



Fig. 83

Fig. 84

twist mouth so proper end goes between lips (Fig. 85). Fig. 86 shows the finish.



Fig. 85

Fig. 86

### COMMENTS AND ADDITIONS

Source:

Date:



Fig. 82

Fig. 81

70. Start with cigarette held beneath lower lip (Fig. 87). It is possible (for some people) to extend tongue and pick up cigarette, bringing it to the lips. Finish as above.

71. Cigarette rests crosswise on palm, fingers pointing to left. Toss upward so it rotates twice and is caught between first and second fingers in smoking position.

72. Cigarette is placed on back of left hand, resting between first and second fingers. Tap hand sharply near wrist, causing cigarette to flip into mouth.

73. Tip head back and hold cigarette on end of nose (Fig. 88). Let fall forward into mouth.



Fig. 87

Fig. 88

#### CIGARETTE LIGHTER

1. "Park" lighters have wind guard which makes possible a startling effect. Pretend to remove flame by pinching it with thumb and finger. Actually, flame continues to burn, but below guard where it is out of sight. Return flame to lighter by tapping guard lightly with thumb and finger, as though replacing flame. The tap will cause flame to spring back into view. Or you can pretend to put flame in mouth, then blow it back to the lighter. The blast of air will restore the flame. Or you can whistle it back by directing the air from lips toward the wind guard. (From "Conjuring with Christopher", effect credited to Eddie Roberts.)

2. "Rite-Point" Lighter. Place thumb on wick and turn lighter upside down. Thumb becomes smeared with lighter fluid. Produce flame, then pretend to pinch off flame and use it for lighting a cigarette. The flame is actually carried off by the thumb as the fluid on thumb burns. It is

#### COMMENTS AND ADDITIONS

Source:

Date:



a cool flame, and if done quickly will not injure thumb. (Bill Nord).

3. Magician holds cigarette over flame of lighter. Cigarette turns ebony black. The black cigarette is smoked while others try unsuccessfully to duplicate feat. Secret: gasoline is used in lighter instead of lighter fluid. Fumes from flame turn cigarette black.

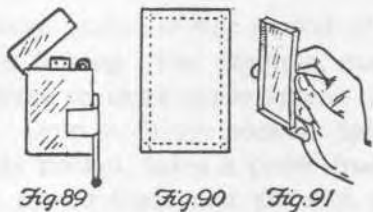

4. Gag. Scotch-tape match to lighter (Fig. 89). Hold so match is concealed by hand. After several unsuccessful attempts to make lighter work (it contains no fluid), proceed in disgust to strike it on sole of shoe, as though striking match. Lighter is secretly reversed in the hand as you do this, so match can be struck. Light cigarette, blow out match, drop lighter in pocket.

5. Have someone hold a cigarette lighter in one fist, a coin in the other fist. Ask him which fist is heavier. When he tells you, say "No, that's the lighter!"

6. At snap of fingers, top of Zippo lighter pops open. Another snap and it lights. For the handling see Gaylor Hill's "Snappy Zippo" in "The New Phoenix", October 22, 1955, and Hill's letter in December 12 issue.

#### CIGARETTE PAPER

See TISSUE PAPER. "The Blue Bug", by Sidney Fleischman and Robert Gunther, is on cigarette paper magic.

1. Paper is torn, rolled into tiny ball, and restored. Repeat with phony explanation, showing extra ball, switching balls, etc., and sucker finish as both balls are shown whole. The advantage of cigarette paper is that small size permits clean get-away of torn pieces in mouth. The ball is placed in mouth under cover of a gesture of moistening fingertip to facilitate opening the ball in view.

#### COMMENTS AND ADDITIONS

Source:

Date:

The trick was a favorite of Nate Leipzig, whose mouth method of disposing of torn pieces is given by Houdini, in "Paper Magic", as well as Harry Kellar's alternate method of using a waxed thumb-nail both for holding the duplicate ball at start and the torn ball at finish. (Ching Ling Foo is said to have disposed of torn ball by laughing loudly and thumb flipping the ball back into his mouth.) The trick is a masterpiece of intimate magic if done slowly, the hands cleanly shown empty at start and finish, and the tiny ball never out of sight. The best description in print is Dai Vernon's account of Leipzig's handling, first published as "Leipzig's Tear-up with a Twist" in the "Stars of Magic" series, more fully in Dai Vernon's Tribute to Nate Leipzig", p. 94. See also T. Nelson Downs, "The Art of Magic", pages 307-311 for classic discussion of the trick.

2. Edges of cigarette paper are creased along dotted lines as shown (Fig. 90) to form a miniature tray with sides about one-eighth inch wide. Hold with thumb and middle finger on opposite edges, and tip of index finger touching the center of back of tray. (Fig. 91). Walk forward, then remove thumb and middle finger from sides. Paper remains suspended against tip of forefinger by pressure of air, and will rotate rapidly like a propeller as long as you continue walking. When you stop moving, paper falls to floor. Hand can also be held stationary in front of electric fan and same propeller effect obtained. Takes a while to acquire knack.

3. Spectator calls out number, word, someone's name, etc. He tears cigarette paper from packet handed to him, rolls it into pellet. When unrolled, the name is found written on it. You do the writing in pocket or on lap, on sheet attached to back of package with rubber bands. It is rolled into pellet, switched for spectator's pellet. For details of handling, see "Dai Vernon's Tribute to Nate Leipzig", p. 141.

#### CLOTHES PIN

See "The Make-it Book", by Dixon and Hartwell, 1928, for section on toys made from wooden clothes pin.

#### COMMENTS AND ADDITIONS

Source:

Date:



1. Penny is clipped between ends of ordinary wooden clothespin by pressing sides together with thumb and forefinger. Bet someone he cannot hold clothespin vertically in this way, for one minute, without penny falling from the prongs. Surprisingly hard to do; fingers tire quickly and coin falls.

## COAT

1. Change pocket in side pocket of jacket can be used for forcing. For example, numbers 1 to 10 are written on small paper squares and rolled into pellets. Drop in change pocket. Spectator reaches into side pocket, takes a pellet from the ten previously placed there and all with same number.

1a. Jacket can be prepared in all sorts of ways that cannot be detailed here since the effects obtained are not strictly impromptu. For instance, rubber lining in breast pocket permits one to empty a drink into it, and a tube from that pocket to side pocket will drain drink into a glass placed in side pocket. Side pocket can be prepared so objects dropped into it will slide down to edge of jacket where they can be retrieved by hand held at side. Inside jacket pocket can be attached by a slide to side pocket, and so on. See COINS, No. 55f.

2. Bet you can put on your coat faster than anyone else. You win contest by secretly turning one of victim's coat sleeves inside out before contest begins. He does not know sleeve is inside out, of course, until he starts to put on coat.



Fig.92

## COMMENTS AND ADDITIONS

Source:

Date:



3. The midget standing on table. (Fig. 92). Legs are formed by putting pair of short trousers over your arms, and hands in shoes. Midget's arms belong to person standing behind you, his arms through a coat which midget has on backward. Amusing routines can be worked out with a little ingenuity and practice in synchronizing arm motions with facial expressions and movements of midget's legs.

Even without someone behind to provide arms, the effect is amusing. Empty jacket sleeves simply hang down at sides as you rest on hands and knees inside darkened doorway, your arms in trousers and hands in shoes so midget seems to stand on floor. A funny bit is to tip head so hat falls on floor, then take one hand out of shoe and put hat back on head. A good description of the dwarf, with suggestions for amusing gestures, will be found in Professor Hoffmann's "Drawing Room Amusements", p. 165.

#### Quickie Gags

4. An imitation of deaf mute telling risque story. Left hand holds out side of coat to screen right hand, as right hand goes through finger motions of telling story.

5. Say, "I've been itching all day." Left hand holds out side of coat, while right hand vigorously scratches the inside of cloth.

6. Toss coat high in air, bend forward with arms upraised behind you. With practice it is possible to catch coat so that sleeve holes drop over arms and coat falls neatly into wearing position.

#### COMMENTS AND ADDITIONS

Source:

Date:





7. Let left sleeve drop from arm, swing coat around back of body to front, keeping it low. Continue swing, putting left arm back into sleeve and bringing coat over the head and back again. Done rapidly, with smooth continuous motion as coat makes the full circle around body, the effect is amusing.

8. Stage bit. Take off coat, turning both sleeves inside out as you do so. Put coat on reversed. Second person restores coat to previous condition as follows. He seizes your left lapel and pulls jacket off your left arm, reversing sleeve, then he walks around behind you, pulls jacket from your right arm reversing sleeve. Without pausing he continues walking around you, putting jacket back on your left arm, then back on right arm. In other words, by circling you twice, he restores jacket.

9. Hook fingers under someone's lapel, your thumb and finger on outside. Rub thumb against finger and say "Very good material."

10. Imitation of two tailors meeting on street. Each says hello, extends arms as if to shake hands. Instead, each feels the other's lapel and says "Hmmm." (Robert Orben)

11. Pretend to turn button on someone's jacket as if it were a TV dial. Look up at his face and say, "Terrible picture. Very bad reception." (Robert Orben)

12. Call attention to fact that your breast pocket handkerchief matches your necktie, then open jacket to show how end of tie goes through slot and up into breast pocket.

#### COAT HANGER

1. A dime can be balanced on lower bar of wire hanger, the hanger spun rapidly around forefinger, and stopped without dime falling. Left hand balances dime by resting it on tips of first and second fingers, with thumb on top as shown (Fig. 93). Spin hanger in direction indicated by arrow. It is best to let hanger rock back and forth a few

#### COMMENTS AND ADDITIONS

Source:

Date:

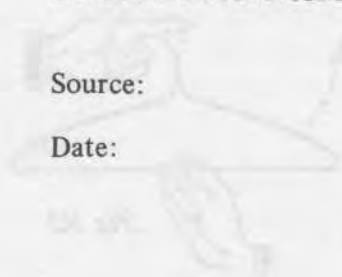

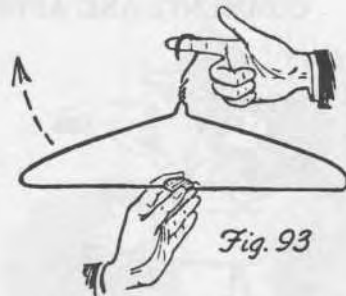

times first, then go into spin. Stop hanger by moving hand quickly to left just as hanger starts to descend on right side of hand. If properly timed, this will bring hanger to dead stop without dime falling off. Trick will not work with penny, or heavier coin.

The pressure of air exerts a balancing effect on dime that makes this work; it is much easier to master than one would think. One can even attach several feet of string to hanger's hook, hold end of string, and swing hanger around in a circle. It can even be twirled horizontally around head, like spinning a rope, and brought to stop without dime falling off. At finish, to prove no adhesive is used, tap bar of hanger so dime falls to floor, or jerk up on hanger so dime flips into left hand.

Walt Rollins has discovered that if hanger is pulled into shape shown in Fig. 93a, and dime balanced on end of hook as shown, the trick works just as well (if not better). Bend hook, of course, so dime rests on it horizontally. Since this looks even more difficult than older method, it makes a good encore.



## COMMENTS AND ADDITIONS

Source:

Date:

1a. The musical spoon (see SPOON, No. 12), I discovered years ago, works even better with a wire coat hanger.

2. Amusing profiles can be formed by twisting wire coat hanger with pair of pliers. See Fig. 94.

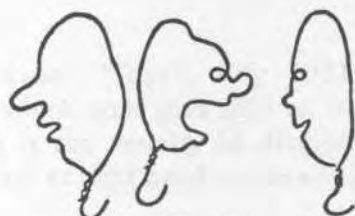

Fig. 94

## COINS

Unfortunately, space precludes listing of coin sleights as well as routines (such as the Miser's Dream) in which many sleights can be combined in endless ways. In a strict sense, most of these routines are stage or club effects, using a number of large size coins, and are therefore not in the impromptu category. Even in the realm of simple coin tricks the number is so large that the following list must be regarded as a selection.

The basic reference on coins is J. B. Bobo, "Modern Coin Magic", newly revised in 1966. Basic sleights are discussed in most books on general magic, and there are scores of small books and pamphlets dealing exclusively with coins: T. Nelson Downs, "Tricks with Coins"; Will Blyth, "Money Magic"; Jean Hugard, "Coin Magic"; Tom Osborn, "Coin Tricks"; Victor Farelli, "Convincing Coin Magic"; Laurie Ireland and Ed Marlo, "Bull's Eye Coin Tricks"; Ed Marlo, "Coining Magic"; and many many others. Special attention should also be called to the coin sections in Arthur Buckley, "Principles and Deceptions", and to the coin effects by Dai Vernon and Ross Bertram in the "Stars of Magic" series. Beautiful routines for classic coin effects will be found in Vernon's books and in books by Tony Slydini.

### Vanishes and Transpositions

Note: additional vanishes will be found in section ahead on "Coins and handkerchief."

## COMMENTS AND ADDITIONS

Source:

Date:



1. Right hand rubs coin against left sleeve near elbow. Let coin fall to table. Left hand picks it up, transfers it to right. Repeat, letting coin fall again. This time left hand retains coin as right pretends to take. As right hand rubs sleeve, left inserts coin in collar (or ear). Show coin vanished, produce from collar.



2. Right foot is placed on chair (Fig. 95), and coin vanished by rubbing it on top of thigh with right fingers. Actually, it slides down crease in trousers into left hand. Favorite of Nate Leipzig. See "The Dai Vernon Book of Magic", p. 94; Bruce Elliott, "The Best in Magic", p. 39; and "Dai Vernon's Tribute to Nate Leipzig", p. 120.

3. Coin is placed against thigh and cloth of trouser leg folded over it. Spectator pushes his finger against coin. When he removes finger, fold drops and coin has vanished. Right thumb steals coin from fold. Spectator feels another coin previously placed in trouser pocket. See Joe Berg's "Here's Magic", p. 24, for simplest handling.

Instead of making fold up over coin and stealing with right thumb, fold can be down over coin and steal made with right middle finger sliding coin to one side. Or coin can be allowed to roll by gravity into the hand, as explained in Bruce Elliott, "The Best in Magic", p. 37.

There are many ways to conclude. You can let spectator mark the coin. After it vanishes, pretend to take it from pocket, but take duplicate coin instead. Repeat the vanish, take marked coin from pocket and return to spectator. Or vanish marked coin in fold on left trouser leg, left hand takes duplicate coin from pocket, replaces it in pocket, a new fold is made, and right hand extracts marked coin from the fold.

## COMMENTS AND ADDITIONS

Source:

Date:





Horace Bennett, In HMM, August 1954, suggests using two coins. A bit of wax, when coins are pressed together, enables you to handle them as a single coin. Spectator feels two coins in pocket. As right hand pulls back edge of jacket to allow spectator to reach into trouser pocket for the two coins, right hand drops palmed coins in side coat pocket.

James Reneaux, "Tops", July 1951, gives his version in which coin goes into an oblique palm from which it can secretly be dropped into right trouser pocket as right hand moves away.

4. Similar to above, except coin is placed on tablecloth and cloth folded over it. After vanish, coin is found beneath cloth (Al Baker's "Ways and Means", p. 44).

5. Marked coin is apparently placed in left hand, but retained in right. Right takes pencil from shirt pocket, secretly dropping coin in sleeve hole. Pencil is pushed through left fist and hand shown empty. As right hand raises pencil to show empty palm, left lowers to retrieve coin from sleeve. Push pencil through left fist again, open to show coin. Invention of James Herpick and favorite of Paul Rosini. See "Tarbell 1", p. 94 for details.

6. Vanish marked coin by sleeving. If arm is raised high, in making a gesture, coin often drops into hip pocket. Pocket should be kept open by means of rolled-up handkerchief. Let spectator take coin from pocket.

7. A coin dropped on floor can be vanished by three methods. (a) Stand so toe of shoe is near coin. As you pretend to pick it up, fingers flip it under shoe. Vanish with upward toss, stepping back at same moment. Pretend to follow coin's flight with eyes as it goes high in air and falls to floor again. Point to coin on floor. (b) As coin is picked up it is secretly tossed in trouser cuff. (c) As coin is picked up it is tossed backward, under left thigh, and caught by left hand.

8. Joe Berg's sleeve vanish. Rest left elbow on table, with chin on left hand. Right hand extends marked coin with request that spectator push coin against table. As he reaches out, say, "No—the other hand, please." As this is said, draw back hand, let coin fall into left sleeve (Fig. 96). Im-

## COMMENTS AND ADDITIONS

Source:

Date:

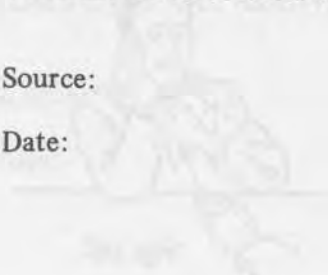



## COMMENTS AND ADDITIONS

Source:

Date:

mediately gesture with right hand (keeping fingers together as though still holding coin) toward spectator's "other" hand. As he puts this hand over your fingers and presses, lower left arm to retrieve coin. Left hand goes under table. As you open right fingers, left hand clicks coin against underside of table. Bring coin from beneath table for identification.

Before the vanish your right hand can pretend to scrape coin along top of table and tap table once or twice, the scraping and tapping sounds being produced by the coin held under the table in left hand. As a repeat, right hand pretends to pick coin up again, but laps it. Left hand goes under table with coin, a few more taps, and the penetration occurs a second time.

9. Coin is vanished by pushing mechanical pencil or fountain pen through fist. Coin goes into clip and is removed with pencil. Make same moves in reverse to bring coin back into hand.

10. Spectator holds out hand. On count of three he is to grab coin. Raise coin in air twice, bringing it down and touching his palm. Third time, coin is left on top of your head (or hat brim). Hit palm with empty fingers and quickly grab his fist with both hands asking if he has the coin. When he opens fist, coin is gone. Have him cup both hands together. Bend head, letting coin drop into his palms. Immediately look up pointing to ceiling as though coin dropped from above. Excellent trick for small children.

11. Place handful of coins on table. Pretend to pick up one, actually taking nothing, and place in left hand. Vanish. Similar method is to take handful of change from left pocket. Right hand pretends to pick up a small coin, actually sliding it under the others. Left returns change to pocket and right vanishes coin.

12. In giving coin to clerk behind counter, pretend to place in left hand but retain in right. As left seems to place coin forward on counter, right hand (resting near edge) allows its coin to fall. The sound seems to come from left hand. Or, if desired, right hand can snap coin against counter as the left hand pretends to make the snap. Raise left hand and coin has vanished.

After right hand is raised to show coin, Milt Kort repeats by pretending to push coin forward with right hand, actually leaving coin where it is but covered by right arm. Lift right hand and clerk (hopefully) is caught again.

13. Nelson Hahne's vanishing dime. Dime rests on back of left fist and is covered with half dollar. Dime vanishes and is found in fist. Right thumb does the work. See "Tarbell 3", p. 145, for the moves. Beautiful effect in hands of Cyril Endfield.

14. Coin vanishes as it is tossed toward trouser pocket. It is heard to fall inside pocket. Use any sleight for vanish. Loose change is in bottom of pocket, and a coin wedged in upper corner under belt. Draw in abdomen to let this coin drop.

15. Impromptu dime and penny (McCaffrey and Blodgett). Dime and penny are placed in left hand. Dime vanishes. The move involves stealing dime on tip of right thumb and dropping down left sleeve. See "Greater Magic", p. 678 for details.

When shown to a magician, the idea is to give the impression you are using fake dime and shell penny, then dumbfound him by letting him keep the penny. Many other sucker dime-and-penny handlings have been devised. Ed Balducci, in HMM, December 1956, suggests putting dime on top of penny, in left palm, then right middle finger snaps dime up right sleeve as left closes into a fist. Of course you must pretend to be pressing dime into the shell penny. Ross Bertram holds left fist at edge of table, drops dime into top of fist letting it fall straight through into lap just before the fist is moved forward across table and penny is dropped into fist in similar manner.

16. Coin is wrapped in piece of paper, and paper torn to bits. For the two standard methods of

## COMMENTS AND ADDITIONS

Source:

Date:

C	B	A
F	E	D
I	H	G

folding paper (so coin slides out into palm) see "Tarbell 1", p. 104. A good get-away for coin is to reach for a pencil, leaving coin in pocket. Pencil is now pushed through center of paper. If paper is pressed around edge of coin as you ask spectator to feel it is there, the circular impress will remain after coin is stolen, adding greatly to illusion it is still in the paper.

With a square sheet of paper creased along four lines as in Fig. 97, a variety of procedures immediately suggest themselves, most of which have been published many times. Coin is first placed on central square E and held there by left thumb. As lower flap is folded up, or right flap folded left, thumb slides coin from E to D so that when the four folds are completed, the left side folded last, coin will slide out. Instead of using left thumb to slide coin off center square, it can be done by gravity, either by tipping to make coin roll to one side, after bottom half is folded up, or by first folding right and left sides, then letting coin slide down to H before top and bottom are folded.

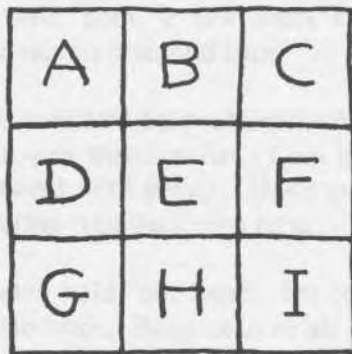

*Fig. 97*

Another technique is to move coin with tip of right forefinger. For example, left side is folded over coin which is held at the center by left thumb. As right hand folds lower flap upward, tip of right forefinger slides coin to H. Still another method is to fold up lower flap before coin is put in the paper. Coin is now apparently placed in the center of this fold but actually goes outside the flap where it is held by left thumb as right hand folds down the top, then the two sides.

A classic description of the standard fold in which the first crease is made off-center, so the edges do

## COMMENTS AND ADDITIONS

Source:

Date:



not meet, and the final fold is made the "wrong way," is in C. Lang Neil, "The Modern Conjuror", p. 168. Dai Vernon, in "Malini and His Magic", p. 45, describes the same fold, says it was the one preferred by Malini.

The nine-square sheet can be gimmicked in various ways. A simple way is given by J. H. Grossman in "M.U.M.", December, 1962. Newspaper is used. A three-square strip is pasted over, say ADG, but only A and G are pasted so that D becomes tunnel open at left and right. There are various ways to use the sheet. For example, coin goes on E and right side is folded over. Tipping paper sends coin into tunnel, and paper is held so spectators see left side folded over fairly. A spectator can now hold the coin through the paper as you cleanly complete the folding of two remaining sides. Such prepared sheets are designed, however, solely to fool magicians and merely gild the lily so far as laymen are concerned.

Al Baker, "Ways and Means", p. 55, has a bold handling of the fold. See also Farelli, "Convincing Coin Magic", for a version which permits a coin to be switched for another. Ed Marlo's clever coin fold, with its "flip move," and variety of off-beat routines, provides the first half of his book. "Coining Magic".

Jack Chanin invented a devilish angle to the nine-square fold which he gives in his instruction sheet for the coin in nest of boxes, and which is explained in "The Phoenix", January 25, 1952. The basic idea is secretly to load a dime or penny into the packet so that after the half is copped, the packet can be tapped on table or against side of glass to prove coin is still inside. Since the small coin occupies only a corner of the folded packet, the square packet can be torn into quarters to prove the half has vanished. There are many handlings, including waxing or rubber cementing dime to the sheet in advance, concealing dime behind the half as it is placed into the sheet, and so on.

Instead of paper one can use a dollar bill. The folded bill can be circled with a rubber band, covered with hand, and marked coin apparently extracted through bill and cloth. If flash paper is used a touch of cigarette effects the vanish.

## COMMENTS AND ADDITIONS

Source:

Date:





Ordinary paper is of course simply torn into small pieces or burned.

The coin can drop into your palm to be disposed of as desired, or allowed to drop down your sleeve. The packet can be tapped on table then brought to table edge and the coin lapped. Coin can be dropped into top pocket of jacket or shirt pocket as you pull up sleeve. You can seize spectator's lapel to pull him closer and let coin slide into his hank pocket.

17. While penny is spinning on a plate, a match box is brought forcibly down upon it. Penny vanishes and is found beneath plate. The blow drives penny through bottom of box. The penny beneath plate is a duplicate previously placed there. The match box should be empty, with drawer upside down to facilitate penetration of penny.

18. Two small whisky glasses are held, one in each hand. Glass on right has been recently emptied, so bottom is still wet. Spectator drops dime in dry glass on left. Pour dime into glass in right hand.

Left puts glass on table. Right hand appears to pour dime into left, but actually dime adheres to bottom of glass. (Note: an old dime, worn flat, works best). Right hand places its glass brim to brim on top of glass on table, and picks up both, palm of hand covering bottom of glass to hide dime. Vanish dime from left hand with a toss toward glass. Right hand gives glasses a shake, and dime appears inside. (James Herpick).

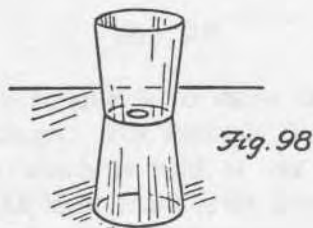

19. A glass is placed upside down on table, and dime (preferably a worn one) is placed on top. Second glass, the bottom of which has been secretly moistened or waxed, is placed on top of dime (Fig. 98). Sheet of newspaper is wrapped like a cylinder around both glasses. Remove

## COMMENTS AND ADDITIONS

Source:

Date:

upper glass from top of cylinder to fill it with water. The dime, which sticks to bottom of this glass, is stolen by right fingers. Replace glass in cylinder, remove paper, and dime has vanished.

20. Four similar coins are placed in a square formation on the table. Two are covered with playing cards. One at a time the two exposed coins are placed under the table and made to appear under one of the cards. When the second card is lifted, its coin has vanished. All four coins are now found assembled under first card. For descriptions of this classic see Down's "Art of Magic", p. 251; DeLawrence's "Impromptu Magic", p. 22; Hugard's "Coin Magic", p. 52; "Greater Magic", p. 705; Buckley's "Principles and Deceptions", p. 89; and "Ross Bertram on Coins" ("Stars of Magic" series). A brilliant simple handling developed by Dr. Daley can be found in "The Phoenix", February 22, 1952. For a routine in which corners of a hank are folded over coins, instead of covering with cards, see "Tarbell 6", p. 148.

21. A coin is secretly palmed in right hand. Borrow coin of same value and have it marked. Pretend to drop in trouser pocket, actually retaining it along with palmed coin. Reach into right trouser cuff and remove duplicate, allowing marked coin to fall into cuff. To prove to sceptics that coin was not palmed out of pocket, repeat, this time showing hand empty as it leaves pocket. Take marked coin from cuff. The basic principle involved here is subject to endless applications. For example, a marked coin can be vanished and apparently taken from a hat. Actually, a duplicate coin is removed and at same time the marked coin is left in hat. Vanish the duplicate. Spectator can now remove original coin from hat.

21a. Moisten back of left hand near crotch of thumb and first finger. A dime can be vanished from cupped hands by secretly maneuvering it to this position where it adheres as hands are shown empty, palms to audience, then tipped forward to show palms empty.

21b. A coin is flipped in air, caught by right hand, slapped on top of left hand, and spectator asked to call heads or tails. When hand is lifted, coin has vanished. There are many handlings. Coin can be sleeved by right hand. It can be thumb palmed

## COMMENTS AND ADDITIONS

Source:

Date:

as right fingers slap left hand, and by tipping hands slightly, allowed to fall into left fist between its thumb and forefinger. The flipped coin can be changed to a different coin (or folded dollar bill) by having second coin finger palmed to slap on left hand as flipped coin is thumb palmed.

#### Hand-to-hand Transpositions

22. Han Ping Chien trick. A group of four, six, or eight similar coins are on table, plus one odd coin of some other denomination ( or a small object such as a key). We will assume six similar coins are used. Left hand picks up three, and right takes remaining three plus the odd coin. Left hand slaps its coins on table, picks them up again. Right appears to do same, but actually slaps down only the odd coin (the three coins are palmed). At same instant, the coins are allowed to slide from left fist to the table in such manner that they seem to come from right hand. Right hand picks up these coins, also the odd coin. Left hand opens to show coins have gone. Right hand tosses all seven coins to table.

A second version of the effect (See Buckley's "Principles and Deceptions", p. 85) is presented as table penetration. After each hand has picked up coins for first time, explain you intend to pass coins from left hand through top of table into right. To illustrate what you intend to do, place right hand beneath table, secretly leaving its three coins on knee, but retaining the odd one. Left hand slaps coins on table, then picks them up again. Right hand now comes above table and appears to do same. Actually, the three coins come from left hand and are released as in previous version. Right hand can now be shown empty before it picks up the three coins plus the odd coin. It goes beneath table where it takes the other three from knee. Empty left hand slaps table, and right comes out with all seven coins.

The first manuscript on this trick, by Ladson Butler, sold in London in 1917, was reprinted in HMM, May 1952. Walter Gibson's manuscript (1957), "The Han Ping Chien Coin Trick", as performed by Paul Rosini, includes dodges by Frank Garcia and others. Vernon's routine is given in "The Dai Vernon Book of Magic", p. 41, and

#### COMMENTS AND ADDITIONS

Source:

Date:

Slydini's many methods are given in "The Magic of Slydini" and "Slydini Encores". See also Bobo's "Modern Coin Magic" for several versions.

23. One at a time, four coins are caused to penetrate the table from one hand to the other. Numerous variations of this effect have been devised, combining sleights with table lapping. See Vernon's "Kangaroo Coins" ("Stars of Magic" series); Al Baker's version in "Ways and Means", p. 37; and "Greater Magic", p. 694.



24. Four similar coins are used. Each hand takes one coin and closes into a fist. Spectator puts a coin on top of the fingers of each hand (Fig. 99). Fists are turned over quickly. The two exposed coins apparently fall to the table. Actually, the right hand opens slightly to catch its coin, while the left permits its coin to slide out of fist to join the coin previously resting on its fingers. Spectator places these two coins back on the magician's fists as before. The fists are turned over again. This time, both coins are caught. When left hand opens, it contains only one coin. Right hand is shown to contain three. For a good description of this old effect see DeLawrence's "Impromptu Magic", p. 26. Tom Osborne's "Coin Tricks", p. 18, gives a follow-up move for passing the remaining coin over.

25. The Tenkai pennies. A penny is shown on palm of each hand. Hands are closed into fists. When opened, both coins are in right hand. For full details of this beautiful close-up trick, see my description in HMM, November 1950. For some hands, holding the penny clipped between second and third fingers as right forefinger is moving the penny on left palm, then it is transferred to a clip behind first and second fingers as right hand turns palm up. Tenkai's method is given in Robert Parrish, "Six Tricks by Tenkai"; throughout the moves Tenkai clips penny behind third and fourth fingers.

## COMMENTS AND ADDITIONS

Source:

Date:





There are two quickie follow-ups. After both pennies are shown in right hand, slide one with thumb to tip of first finger and pretend to place in left hand, but retain it between thumb and finger so a second transposition from left to right is achieved. Repeat, but this time drop both pennies in left hand for a reverse transposition, right to left.

26. Two coins are at edge of table. Each hand pretends to pick up a coin. Actually, left hand lets coin fall into lap. Raise left fist, looking at it intently, as right hand lowers and picks up coin from lap. Left hand opens to show coin vanished. Right tosses both coins to table.

27. If your hands are naturally moist, you can place palm over penny or dime so that flesh at base of fingers press against it, and when hand is lifted, coin will adhere to it. This is the basis of a simple transposition.



Fig. 100

Place two pennies on table. Cover with each hand, then lift to show nothing has happened. Cross left arm over right (Fig. 100) and cover pennies again, then change mind and uncross arms so each hand covers pennies as before. As you uncross, right hand carries penny with it. The left hand must be removed from coin first, so that it is above right hand just as right moves off the vacant spot. This prevents spectators from seeing that penny on left is no longer there. Raise hands to show both pennies on the right.

28. Buckley's hand-to-hand transposition. Four coins, one at a time, pass from hand to hand. A fifth coin is secretly employed. See Buckley's "Principles and Deceptions", p. 96, for details on this excellent routine.

29. Show two coins, one in each hand. Left

## COMMENTS AND ADDITIONS

Source:

Date:

hand places coin in your lips. As eyes follow this move, right palms coin, then brings thumb and fingers together again as though still holding coin. Pretend to place coin in left hand. Give left fist a slight shake, to strengthen illusion it contains a coin. Right fingers now take coin from lips. Coin vanishes from left hand and both coins are shown in right. With proper rhythm and timing, a very pretty effect.

#### MISCELLANEOUS

30. "Crying half dollar." When squeezed, it drips water. Accomplished by sponge or wad of paper previously dipped in water and held back of half where thumb squeezes it against coin. Sponge can be kept behind right ear and secured while left hand rubs coin against right elbow. Jack Chanin suggests having the sponge sleeved. Red tissue paper can be used to produce red drops while you patter about "blood money."

31. For Malini's beautiful effect in which a borrowed coin is apparently broken to make two coins, then one of the coins broken again to make a third, see "The Dai Vernon Book of Magic", p. 105.

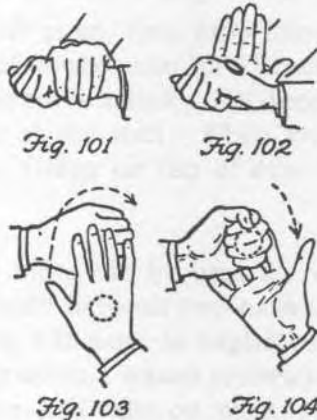

32. Coin is held in left fist. Right palm covers top of hand (Fig. 101). After a quick upward toss, right fingers are raised to reveal coin on top of fist, having apparently penetrated left hand. As toss is made, left fist turns slightly forward allowing coin to leave the fist. Coin strikes right palm and falls into position on top of left hand. In raising right fingers, keep base of palm tight against fist to strengthen illusion that coin could not have come up that way (Fig. 102). For details, see Bob Hummer's "Six More Hummers."

#### COMMENTS AND ADDITIONS

Source:

Date:

33. Left hand is closed into fist. Right fingers rub coin on back of fist. Coin vanishes and is found in left hand. There are two basic methods. One: stop rubbing coin and open left hand to show it still empty. As it closes, coin is allowed to drop from right fingertips into the hand. Two: coin is palmed in right hand before rubbing begins. Spread fingers to show coin has vanished (Fig. 103). Both hands now rotate forward to position of Fig. 104. Under cover of this rotation, coin drops from palm into left fist, the fingers opening slightly to catch it and immediately closing again. The two pictures are magician's view from above. With a duplicate coin, numerous variations are possible.

34. Penny or dime is balanced on tip of extended forefinger. Hand is turned over and coin apparently slapped against open palm of left hand. Yet when right hand returns to former position, coin is still balanced on tip of finger as though glued there. Secret: as right hand turns over, the thumb and finger hold coin and middle finger is extended. It is the middle finger which slaps left palm. These moves are reversed as right hand returns to former position. Done rapidly, the exchange of fingers cannot be seen. See HMM, June 1953, p.2.

35. A more elaborate effect, similar to above, involves wrapping a handkerchief about the hand and clinking the coin against another coin on spectator's palm. Details will be found on page 6 of Osborne's "Coin Tricks".

36. To drive a needle through coin, push needle into a cork of such size that point of needle reaches just to lower end of cork. Place cork on coin and strike with hammer. Needle will penetrate the metal. Cork can now be pulled free of needle.

37. A silver coin punctured as described above can be used for penetration effect. Push tiny piece of tinfoil into the hole making it invisible. Borrow coin of same denomination, switch it for prepared one, then proceed to push pin (or a feather) through its center. Remove pin, switch coins again.

#### COMMENTS AND ADDITIONS



Fig. 103

Fig. 104



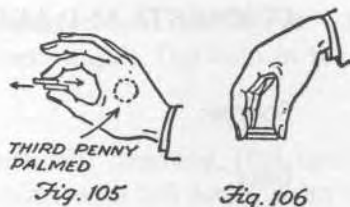

## COMMENTS AND ADDITIONS

Source:

Date:

38. A coin pulled off edge of table suddenly becomes two. Second coin is stuck by wax or gum to underside of table near edge. As fingers slide coin off edge, thumb takes coin from beneath. Toss the two coins to table.

39. If two pennies are held as shown (Fig. 105) and moved back and forth, it will produce optical illusion of third coin. Have a third penny secretly palmed in right hand. Show the illusion, then drop coins into spectator's hand, letting concealed penny fall also. He opens hand to find three pennies. Kirk Stiles like to have a penny palmed in each hand while showing the illusion. The two coins are dropped in left hand which then slaps three coins on table. Right picks up two, repeats illusion, drops all its coins in left (this time shown empty), and left again slaps three coins on table.

40. Two halves are placed together and held by right hand as shown (Fig. 106). Let lower half fall into left palm, then drop second half on top. Offer to sell lowest coin for 25 cents. The bottom coin proves to be a dime. The dime is between the two halves at the start. When lower half falls it turns over, falling on top of dime and concealing it.

This same move can be used for vanishing dime. Dime is placed between two halves, and the halves dropped on left palm as explained. Good sucker variation involves a waxed underside of upper half. When lower half falls on palm, spectator thinks dime is beneath. Actually, it is stuck to upper half. Flip this coin in the air, then place in pocket. When he lifts half on left palm, he is surprised to find no dime. Similar sucker effect is to vanish postage stamp (or small piece of paper) in above manner, using saliva on upper half. Stamp can be copped by right fingers while attention is on left palm.

41. Show quarter on left palm. Spectator is un-



aware that dime is beneath it. Cover it with a half and offer to sell coin beneath for 15 cents. When you remove half, take quarter with it, revealing dime on palm. Right fingers cop quarter as the half is tossed on table.

COMMENTS AND ADDITIONS

Source:

Date:

42. Galileo's famous discovery that bodies of different weights fall with same speed can be demonstrated by placing tiny piece of paper on top of half. When dropped, paper and coin fall together.

43. Spectator holds dime on palm of hand. Your right hand has a penny secretly palmed. Tap his palm lightly with right finger tips, tapping near base of his thumb. On third tap he is to grab dime. Your third tap is made with more force, causing dime to fly upward into your hand. At the same time, release palmed penny. He feels coin in fist and swears he still has dime. You insist you have it in your closed right fist. When he opens hand, he finds penny. See Down's "Art of Magic", p. 260. Incredible as it seems, Jarrow used to feature this effect in his stage show, with humorous patter and great effectiveness.

44. Show dime between thumb and first finger (Fig. 107). A half is concealed vertically behind it, edge toward spectator. Show left hand empty. Left fingers appear to take dime, but under cover of fingers, dime is pushed behind half by left

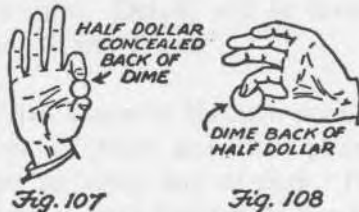

thumb. Left thumb and finger now hold half as in Fig. 108, the dime concealed behind it. If the move is made slowly, with light pressure on dime, the noise can be kept to minimum. The trick is even more effective with a life-saver instead of dime. The noise can be eliminated entirely, and from a short distance the edge of half is not noticeable through the hole. Hand can be held sidewise instead of vertical to avoid bad angles if there are several spectators.

Wax on dime, or rubber cement on dime and half, can be used to make dime stick to back of half.

After the change, hold half by its edge so both hands are seen empty, flip coin in the air, pocket it.

A totally different handling, that fools magicians, is to cover dime with left hand, palm toward you. Thumb clip the dime (at tip of thumb, not crotch), then as left hand moves left to expose the half, the front edge of half is pushed against left forefinger so it rotates 45 degrees and faces audience. The left hand must be kept completely rigid throughout, with no motion of thumb or fingers. The move is completely silent. Left hand merely moves right over the dime, then back again. The left hand, of course, must be shown empty before you make the move. After the change, flip the half in the air with right hand as left pockets the dime. The get-ready can be made in the pocket before you bring out the dime.

45. Magician names date of borrowed coin. Coin is switched for duplicate, date of which is known.

46. Spectator holds penny in one fist and nickel in other. Ask him to multiply value of coin in left hand by 14. He does same with coin in right. The two results are added and you are given total. You now announce which hand holds which. Secret: note which hand causes him to take longest time for the mental multiplication. It will hold, of course, the nickel. (Royal V. Heath).

47. Place a dozen or more coins on table in form of a number nine (Fig. 109). Spectator thinks of a number greater than number in tail of nine. He starts counting from lowest coin in tail, counting up and around the nine counter-clockwise. He continues to circle the nine until he reaches



Fig. 109



Fig. 110

his number. Then he starts counting from one again, beginning on the last coin touched and counting clockwise around the circle until he reaches his mentally selected number again.

## COMMENTS AND ADDITIONS

Source:

Date:



Although performer's back is turned while this is done, performer can always point to coin on which last count terminated. Simply experiment with any number first, remembering coin on which double count ends. Regardless of number, count will always end on this coin. Repeat the trick several times but vary it by adding additional coins to the tail for each repeat, so count will fall on different coins.

Johnnie Murray suggests dramatizing the disclosure by having spectator hide small piece of paper under selected coin. Or a mark can be made on tablecloth, beneath coin.

48. A number of pennies are shaken in a hat. Magician turns back. Spectator selects a coin, marks it, then holds it in his fist for several seconds while performer pretends to be getting "vibrations" from the coin, or similar nonsense. Coin is dropped back in hat, and hat shaken. Magician reaches into hat, held above his vision, and finds marked penny. It will, of course, be warmer than the others. Or coins can be placed in a row. You touch each with tip of nose to "smell" the chosen coin.

49. Hat is placed on glass and coin on side of hat (Fig. 110). When hat is knocked to side by the blow of a finger against the inside sweat band, coin falls into glass.



*Fig. 110*

50. Hat is placed upside down on glass (Fig. 111). When handful of coins are tossed into hat, one seems to penetrate brim and fall into glass. When hat is placed on glass, a coin is secretly wedged between crown of hat and brim of glass. Weight of hat prevents coin from dropping into glass. Force of coins thrown into hat dislodges it.



*Fig. 111*



*Fig. 112*

51. Hat is held upside down by left hand (Fig. 112). Right hand tosses coin into air. Coin vanishes. Pretend to catch coin in hat. It is heard to

## COMMENTS AND ADDITIONS

Source:

Date:

fall inside. Right hand removes it from hat. Method: The coin is palmed in right hand. The sound is made by snapping left ring finger off middle finger and against hat band. After repeating several times, pretend to take coin from hat as before, but actually let it fall from hand into hat. Right fingers appear to hold coin. Make toss again. Show hand unmistakably empty before it takes coin from hat. (See "Tarbell 3", p. 70). A good routine, with a number of unusual angles, is given by Gene Elmo in HMM, Sept., 1958, p. 37.

52. Push dime against forehead to show it sticks when hand is removed. Do this to spectator and have him dislodge dime by wrinkling forehead. Try another spectator, but this time keep dime in right fingers and press moistened thumb against his forehead. The cool spot gives him illusion dime is there and other spectator's are amused by his attempts to shake it off. Illusion can also be created by pressing nails of thumb and first finger against his forehead and twisting slightly. Gene Bernstein has two spectators face each other. Dime is apparently placed on both foreheads, but actually placed on only one. The idea is to see which spectator dislodges his dime first. This is a good throw-off for spectator who has nothing on forehead.

53. Marked coin is wrapped in paper and stolen as explained above (No. 16). Paper is placed on plate, and plate on brim of glass. Set fire to paper. As it burns, coin drops into glass. The stolen coin is pressed against bottom of plate where it is held by wax. Heat from burning paper melts wax and causes coin to drop into glass.

54. Dime is dropped down left sleeve then extracted from elbow. Duplicate dime is secretly wedged between two buttons on coat sleeve. Right fingers move down back of sleeve, picking up duplicate coin en route, and extract dime from elbow.

Many different methods have been published for the effect of dropping a coin down spectator's coat sleeve and extracting it from his elbow. This was a favorite impromptu trick of Carl Rosini, whose handling will be found in "Carl Rosini; His Life and Magic". For a different handling see

## COMMENTS AND ADDITIONS

Source:

Date:



Theodore Bamberg and Robert Parrish. "Okito on Magic", p. 98.

55. Innumerable vanishes, changes, productions, and transpositions can be effected by various methods of sleeving. Perhaps the simplest and most effective of such tricks is the following:

A coin is secretly palmed in left hand. Right hand shows a coin of another denomination on its palm. As hands are cupped together, the left palm covering the right, a quick but almost imperceptible toss by right hand sends its coin up left sleeve. The palmed coin is allowed to drop. Remove left hand to show the new coin. A change of coin to cigarette, made in same manner, is effective. The exchange can also be made by having first coin on back of right fingers instead of on palm.

Attention should be called to the currently fine series on coin sleeving by Ross Bertram, which began in HMM, August, 1951.

55a. The effect of No. 21b can be worked in reverse. Take invisible penny from pocket, flip it, pretend to catch, slap on back of right hand, ask spectator to call heads or tails. When you lift hand, there is a penny. It had previously been palmed in left. Right hand must, of course, be shown unmistakably empty before it flips the imaginary coin. Left hand closes into fist and the Hummer move (No. 32 above) puts coin on top of left fist as right palm slaps it.

55b. The bent penny. Not impromptu, but so easily made and such a great trick for children that I include it. Penny is bent with two pairs of pliers, using cloth around coin to prevent marring it. Borrow penny, switch for bent penny as you toss it into left hand, keeping borrowed penny finger-palmed in right. Seize the bent penny between the fingers and thumbs of both hands and pretend to exert all your strength as the thumbs bend it. The illusion of actually bending it can be very strong. Let spectator keep penny or take it back, switch again, and bend it straight. You can drop penny in spectator's hand, instructing him to close hand quickly into a fist, and let him bend the penny, but I find it more effective to present as a feat of your own superstrength.

## COMMENTS AND ADDITIONS

Source:

Date:

*"Magic and Methods of Ross Bertram" appeared on the magic market in the summer of 1978. This big book includes the material (updated) that originally was published elsewhere.*

55c. Peter Warlock published this excellent use of the "magician's choice" in "Pentagram", Nov. 1954. Penny, dime and quarter lie on table. You extend a clenched fist with a dime in it. Have spectator hold your wrist. Ask him to pick up quickly, at the instant you snap your left fingers, two of the coins. If he leaves dime on the table, put your fist by the dime, open it to show you have a matching coin. If the dime is one of the coins he picks up, tell him you will snap your fingers again and he is quickly to hand you one of the coins. If he hands you the dime, of course it matches dime in your right fist. If he hands you the non-dime, drop it on the table, put your fist alongside his hand that retains the dime and show that you have matched his coin. Of course it can't be repeated, so you should begin with very positive assertions that your prediction never fails.

55d. Spectator drops penny in glass of beer. On magician's command the coin rises slowly up and out of the glass. Not strictly impromptu, since it uses a piece of invisible nylon attached to penny with wax. A favorite bar trick of Leipzig, details of which are given in "Dai Vernon's Tribute to Nate Leipzig", p. 130.

55e. Twelve coins rest on a small tray, book, piece of cardboard, etc. Dump in spectator's hands and let him count them onto tray. He holds tray, hands you three coins. Vanish them any way you please. Right hand, with the three palmed, takes tray from spectator and dumps the nine coins into his cupped hands, adding the three palmed coins. He then counts the twelve coins back onto tray.

55f. A beautiful effect which I include because it appears impromptu, although it requires a slide from top pocket of jacket to right side pocket, is Glenn Harrison's trick, given in Bobo's "Modern Coin Magic", p. 168. A silver dollar is marked. Empty glass goes into right pocket of jacket. Right hand appears to put coin in left, but retains it. As right hand passes across top pocket (as you explain that coin is going to travel up left sleeve, across chest, and fall into glass), coin is secretly dropped into pocket. It rolls down slide and falls into glass with a clink just as right hand makes tossing motion toward pocket.

## COMMENTS AND ADDITIONS

Source:

Date:

## Control of Heads and Tails

56. Coin is caught on right palm and quickly noted before it is slapped on back of left hand. Normally, the side opposite one noted will now be uppermost. If desired, however, coin can be allowed to fall from the palm toward the fingers, making a half-turn in right hand, so when it is slapped on left, the side noted will still be showing. This permits control of heads or tails. (If preferred, coin can be caught on fingers instead of palm, the fingers turning it over before it is slapped on left hand).

The control has many uses. If you ask someone to call heads or tails, majority will call heads. Thus if you control coin to show tails, odds are in your favor even though he calls after coin is on left hand. If he calls while coin is in air, or before, you can control coin to show opposite. In matching coins, often you can observe how his coin falls before you flip yours. If three people are playing "odd man wins", two players in collusion can win easily. By signals, or agreed-upon sequences, they control their coins so they show opposite sides. Thus one of them will always be odd man.

57. Instead of noting coin as it falls, a piece of wax or gum stuck to side of coin tells you which side falls against palm. It must be stuck on side you do not wish to show, and coin is controlled accordingly.

58. Coin is given a rotary motion as it is flipped. With practice, it can be made to wobble like a dying top, giving the impression it is turning over rapidly. Actually, same side always remains up. The illusion can be made perfect.

59. In matching coins, right hand appears to slap coin on back of left. Actually, coin is held on edge, covered by the fingers. Opponent must uncover his coin first. As you remove hand, coin is allowed to fall one way or other.

60. Small nick on one side of the edge of coin enables you to tell, when back is turned, whether it falls heads or tails, after being spun on table. The sound of the settling coin is slightly different for the two sides.

## COMMENTS AND ADDITIONS

Source:

Date:

61. A handful of change is placed on table. Performer's back is turned. Spectator turns over coins at random, calling out "turn" each time a coin is reversed. He may do this as long as he wishes, and same coin may be turned as often as desired. Spectator then covers any coin with his hand. Performer turns around, glances at the coins, correctly guesses whether covered coin is heads or tails. Any number of coins can be used. Before turning your back, count number of heads showing. Each time spectator says "turn" add 1 to this number. If final total is even, there will be an even number of heads showing on all coins, including the one covered. If total is odd, there will be an odd number of heads. Hence it is a simple matter to determine what is uppermost on the hidden coin. On a hard surface you can hear each coin being reversed, so it is not necessary to have spectator call the turns.

61a. Ten pennies on the table are mixed around by someone while your back is toward the table. With your hands behind your back, you separate the coins into two groups of five each, in such a way that each group has the same number of heads and the same number of tails. This is an application of one of Bob Hummer's card principles. At the start, there must be five heads and five tails showing. You merely divide the coins in half and reverse all the coins in either half. Another presentation, to avoid the noise of reversing coins, is to remove five coins, one by one, reversing each as you bring it to front and hand to spectator. Spectator notes that, say, three of these coins are heads, two tails. This matches, of course, the five pennies that remain on table. Makes a good bar trick with ten circular cardboard coasters.

#### Coin and Handkerchief (A) Vanishes

62. Left hand has a rubber band over third and fourth fingers. Handkerchief is spread over left hand, coin placed in center. Left fingers slip rubber band over coin (Fig. 113). Spectator feels coin through cloth, your hand concealing band.



Fig. 113

Fig. 114

#### COMMENTS AND ADDITIONS

Source:

Date:



Fold a side of hank over coin to hide band letting spectator hold coin through two thicknesses of cloth. Take corner of hank and jerk from his hand to make coin vanish.

A similar vanish, using scotch tape instead of rubber band, is described by Christopher in HMM, Oct. 1951, p. 849.

63. Coin apparently placed under hank and held by spectator. Actually he holds duplicate in end of your necktie while you palm coin or drop it down a sleeve. Shake hank to vanish coin.

64. Left hand holds coin at fingertips. Right drapes hank over coin then draws cloth backward slowly until it pulls free of coin. Repeat, but this time right fingers clip coin as hank is placed over left fingers. As the cloth is drawn back, coin is dropped into breast pocket (Fig. 114).



Fig. 114

A similar version, with slightly different handling, is described by Jack Chanin on p. 160 of "My Best".

65. Hank is spread on table and dime (or penny) placed in center. All four corners are folded to center. Corner marked "A" has been previously waxed. It is folded first, and pressed against coin. Both hands now grasp cloth (Fig. 115), then move apart. This brings two corners into the hands, the waxed corner carrying dime into left hand. Audience supposed coin still at center of hank, covered by one of remaining two corners (Fig. 116).

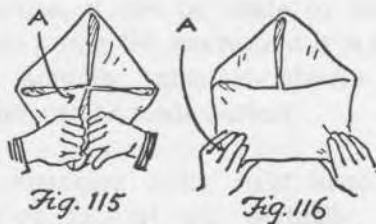

A slight shake of the cloth opens out handkerchief, and effect is that of instantaneous vanish. Hank is now lifted and both sides shown. Other methods of handling the vanish have been proposed, but the above (which is the oldest) seems to be the most effective. An impromptu method for fooling those who know about the waxed corner is described by Ross Bertram in "The Sphinx", February, 1948, but the moves are difficult.

## COMMENTS AND ADDITIONS

Source:

Date:

## COMMENTS AND ADDITIONS

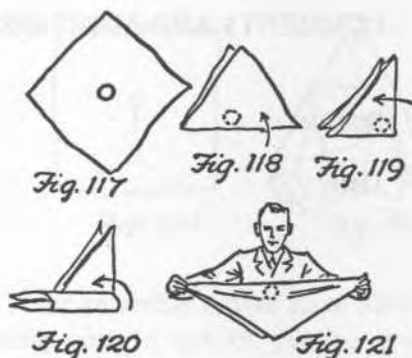

Source:

Date:

66. Penny or dime is placed in center of hank, which is folded twice (Figs. 117, 118, 119). The cloth is now rolled as shown in Fig. 120. Have spectator grasp the two corners exposed at one end of this cylinder, and pull them out horizontally. This causes hank to unroll, but coin remains trapped in the center by folds of cloth when hank is stretched out (Fig. 121). Take hank from him by grasping it at the center, where you can grip coin, and place it in your pocket.

67. Table glass is covered with handkerchief (or napkin). Magician apparently places coin under the cloth and drops it into glass, but when hank is removed, coin has vanished. Magicians suspect glass disk, but this is not used. Method: secretly have on your lap, held between thighs, another glass. Pretend to place coin in left hand, retaining it in right. As empty left hand seems to drop coin in glass, other hand lowers to lap and drops coin in hidden glass. Osborne, on p. 1 of "Coin Tricks", suggests having a duplicate coin already in glass. Instead of pretending to drop coin in glass, the hand makes a tossing motion toward it. Coin vanishes and is heard to fall inside. Remove cloth to expose duplicate.

68. Horowitz's vanish of coin in hank and glass. Coin is apparently placed in center of hank, and hank placed in glass. Actually, coin is palmed, but handling is such that as hank is lowered into glass, palmed coin clinks against edge, giving illusion coin is striking bottom of glass. Too complex to describe here, but details of this beautiful effect will be found described by Horowitz in "The Sphinx", December 1947.

69. Let fingers hold marked coin. The hand is



Fig. 122

Fig. 123

covered with handkerchief and spectator requested to place rubber band over fist so that band holds cloth tightly against wrist. As you explain how band is to be placed on wrist, right hand makes circular motion around left hand. As right hand passes below left, coin is allowed to drop into right hand. To make the drop easy, left hand should be held with fingertips pointing downward (Fig. 122). Later, when spectator removes hank from hand, coin has vanished. Can be reproduced any way desired.

Second method of making drop is to take lower edge of cloth (on audience side) and lift it back over left hand to show coin (Fig. 123). As right hand replaces this edge to former position, the drop is made.

70. Not strictly impromptu, but preparation is simple. A piece of white thread about six inches long is used. Scotchtape one end to center of handkerchief, other end to coin (Fig. 124). Borrow coin of same denomination, place it beneath hank, and apparently let spectator hold it through cloth. Actually, he holds duplicate while you palm off borrowed coin. Spectator allows coin to drop into glass of water. Remove hank by grasping it at center and lifting straight up. This removes coin silently. Hank can even be tossed in air as it is removed. Magicians suspect glass disk, but of course glass can now be examined.

71. Hank is spread over left palm. Coin is placed in center of cloth and grasped by left hand. As right waves a side of hank back and forth over left, the coin vanishes, reappears, and finally is found in left hand beneath the cloth. An effect created by Horowitz and described on p. 51 of Hugard's "Coin Magic".

## COMMENTS AND ADDITIONS

Source:

Date:

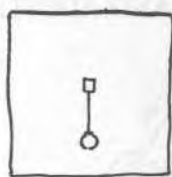

Fig. 124



Fig. 125

## COMMENTS AND ADDITIONS

Source:

Date:

71a. Innumerable moves have been published for sleeving coin in act of putting it under hank or covering it with hank. Most of them are weak, since the sleeve is such an obvious place for coin to go that unless a spectator can see or feel coin through center of cloth he may assume it went up the sleeve whether it did or not. Incidentally, when there is no coin in a hank, your right middle finger can make a casual snap against back of left thumbnail (as left hand holds center of cloth, thumb at back) to simulate sound of snapping the coin.

71b. E. Brian MacCarthy, in his manuscript "Sleights Supreme", has a way of folding hank into a bag, held by four corners, so that when coins are dropped into it they fall to an opening at bottom where they can be stolen by right hand as its palm jingles the coin. The fold is described by Bruce Elliott in "The Best in Magic", p. 49.

71c. Similar to No. 66 except coin rests outside hank in a trough at the top. It can be rolled into hand; or the two ends can be brought together in left hand as right slides down to center, palms coin, then the other two corners are pulled to open hank flat on table. Coin can also be lapped as the hank is pulled open. The basic idea is given by Eddie Joseph in "Original Tricks"; in more detail in "Tarbell 6", p. 123.

## B. Productions

72. Marked coin is vanished and found inside knot of hank. The move is too familiar to need detailed explanation. The cloth is twisted rope fashion, with coin secretly inside one corner. It is allowed to slide to center just before knot is tied. Al Baker liked to give ends to spectator and let him tie knot. Osborne, on p. 26 of "Coin Tricks", suggests placing knotted hank in side pocket with one end showing. Duplicate coin is apparently placed in



left, but retained in right. As right takes hank from pocket, it drops palmed coin inside. Left makes throwing motion toward pocket. Coin vanishes. Hank is removed from pocket, and coin found inside the knot.

73. Jack Chanin, p. 14 "Handle with Gloves", describes an excellent method of producing six coins, one at a time, from a handkerchief. Three coins are finger-palmed in each hand. Hank is thrown over left hand. Left thumb pushes a coin upward so its form is seen under the cloth. Right hand (with three coins finger-palmed) takes the coin through the cloth. Hank is now turned over so that it falls draped about right hand, exposing the single coin. The coin is allowed to drop to floor or into glass. Right hand now pushes up a coin under the cloth, and same moves are repeated as left takes coin through cloth, and hank is allowed to fall back over left hand. This continues, from hand to hand, until all six coins are produced.

Bruce Elliott has discovered that a similar effect can be obtained by having all coins palmed in left hand. Left thumb pushes up coin, right hand takes it through cloth, cloth is allowed to fall over right hand, exposing coin—all as before. At this point, left hand goes under cloth again, taking hold of coin through the cloth. Right hand, which can be shown freely, removes the coin and drops it in glass. The process is repeated until all coins have been produced. The left can hold a great many coins because it is in view only for brief moments, and an awkward palm will not be noticeable. Both methods are effective as club or stage routines.

### C. Penetrations

74. Coin is placed under hank and held by right hand through the cloth. The cloth covers a glass in left hand. Right allows coin to drop into glass. Actually, glass is tilted backward slightly (Fig. 125) and coin strikes side, then falls into left palm. Right hand grasps glass by the side and extends it forward with request that spectator form a well by pushing center of cloth down into glass. Left hand, with coin palmed, can indicate with gestures how well is to be formed. When this is done, remark that well must be deeper. Left hand pushes

### COMMENTS AND ADDITIONS

Source:

Date:





Fig. 126

cloth farther into glass, leaving coin. Left side of hank is now given a downward jerk (Fig. 126) while right keeps cloth firmly against side of glass. This causes coin to fly suddenly into the air. A slightly different handling will be found on p. 6 of Osborne's "Coin Tricks".

Bill Nord has an interesting version. Two coins of different sizes are used. In dropping them, one is permitted to fall into glass, the other strikes side and drops into left hand. Spectator is now given "magician's choice" of either coin. The coin named is caused to jump into the air, or it remains in glass while you magically extract other one.

75. The standard method of pulling coin through center of hank by means of preliminary move



Fig. 127

Fig. 127 A

which brings coin into a fold on outside of cloth, is too well known to require description. It will be found on page 167 of Hoffman's "Modern Magic", and p. 90 of "Tarbell 1". A grave defect of this move is that right fingers are seen to twist the coin so left fingers can grab its edge through the double thickness of cloth – a highly suspicious move.

There are several ways to eliminate this. Coin can be clipped between first and second fingers (Fig. 127). Left fingers release their hold, allowing right thumb to push a small fold of cloth up under coin as indicated. Left fingers immediately grasp edge of coin again, and you are set to proceed.

## COMMENTS AND ADDITIONS

Source:

Date:

Jack Miller has worked out a handling which eliminates use of right hand entirely. Coin is held by thumb and fingers of left hand, but as soon as hank covers it, it is clipped between tips of index and middle fingers. Thumb moves down to position of Fig. 127-A, then up again (Fig. 127-B), grasping coin through two thicknesses of cloth. This causes a large downward fold of cloth to form. If coin is held by thumb and index finger, the middle finger is free to bend down and pick up this fold with its tip, bringing the fold up on side of coin nearest audience. All this is under cover, of course.



If the cloth tends to slide along the thumb, preventing formation of the crease, right hand can assist by giving cloth a quick tap between thumb and coin. Blowing at this spot on the cloth will accomplish the same result.

Another defect of standard version is that when you lift front edge of cloth to show coin in center, the cloth drapes about hand in unnatural manner. This can be corrected by lowering hand so coin is pointing toward the floor (Fig. 128) but a better method (if no one is behind you) is suggested by Jack Miller. Raise hand to position of Fig. 129. The coin appears to be in the center, and cloth drapes naturally over hand. The hand is lowered, allowing both sides of cloth to fall forward, and trick proceeds in the usual manner.

Before removing coin, have spectator grasp cloth a few inches above coin. Or tie a knot above coin, letting spectator hold upper ends of hank while

## COMMENTS AND ADDITIONS

Source:

Date:

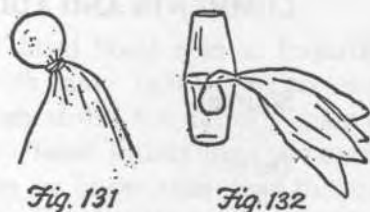

Fig. 131

Fig. 132

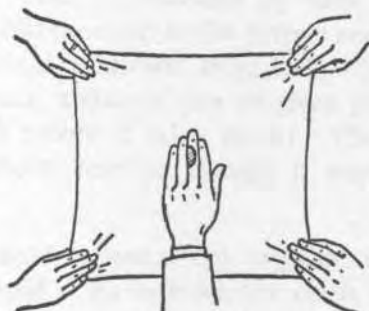

Fig. 132 A

you extract coin below knot (Fig. 130). Farelli, in "Convincing Coin Magic" suggests winding rubber band around the cloth (Fig. 131). Coin is secretly stolen, but cloth is kept flat so coin appears to be inside. To effect vanish, hank is jerked flat, the band flying into the air. Milbourne Christopher likes to have two spectators take the handkerchief by opposite corners, holding it horizontally. His right hand goes beneath, grasping the coin through the cloth, and left hand is placed on top. The coin, still covered with cloth, is pushed up between the fingers of the left hand, so spectators see the form of coin's edge under the cloth. Then slowly the coin is pushed into view through the fingers (Fig. 132-A). Senor Mardo, in one of his books, suggests placing coin between two glasses (Fig. 132). The glasses are shaken up and down until coin shakes out of the fold and is heard rattling in the glasses.

Osborne, on p. 20 of "Coin Tricks", maintains that a weak point of trick is showing coin still in center without a plausible reason. He suggests a sucker move. Right hand pretends to steal coin after it is first placed under hank. Right is then shown empty, and cloth is lifted to prove coin is still held by left hand. On pages 22 and 24 Osborne gives two transposition effects involving the fold move, in which one or more coins are made to pass from one handkerchief into another.

## COMMENTS AND ADDITIONS

Source:

Date:





Paul Morris brings the coin into the outside fold, then he places a second coin, of different size, under the handkerchief to join the first one. This second coin actually goes into the hank, and if the cloth is not too thick, you can rap the coin against the first one, producing a convincing sound even though a thickness of cloth is between the coins. The spectator is asked to name one of the two coins. It is a magician's choice. If he names the first coin, you announce that you will extract it, leaving the other coin inside the hank. If he names the second coin, say that you will remove the first one, leaving him (he is holding the hank above the coins) with the coin chosen.

75a. Numerous methods have been published in which a duplicate coin is used for achieving the effect of No. 75. The borrowed coin is usually marked, switched for unmarked coin which is placed under hank. The original coin is then extracted, or made to rise up from center of cloth, and the duplicate, still under hand, is palmed, lapped, sleeved, etc.

76. George Kaplan, in "Fine Art of Magic", p. 251, describes an ingenious variation in which two coins of different denominations are apparently placed in center of cloth. The handling is such that either coin can be extracted (no magician's choice) leaving the other inside the hank.



Fig. 133

Fig. 134

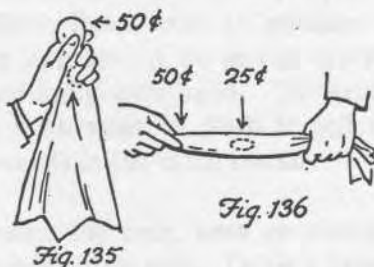

Fig. 135

Fig. 136

## COMMENTS AND ADDITIONS

Source:

Date:



77. Right hand holds coin at fingertips. Left covers it with hank. Left fingers pretend to take coin through cloth, but actually grasp only the cloth. Left hand whisks hank forward. Right retains coin in finger-palm near tips of fingers (Fig. 133), lowers, then turns palm toward audience. Coin is concealed by hank which is placed at this moment in the fingers and grasped by right hand as shown. (Fig. 134). (If coin is back palmed, audience can be given glimpse of right hand before it takes hank). The cloth is twisted about coin as though it were inside.

A quick, bold variant is not to palm coin at all in right hand. As left whisks cloth forward, right hand is screened by hank. It simply comes up behind, takes center of cloth, depositing coin behind hank. Can be used also for vanish. Either palm off coin (after twisting cloth to show coin apparently under hank), or drop coin in top pocket of jacket as you offer an end of hank to spectator so he can pull cloth while you release it from hand.

77a. Left hand holds center of edge of hank, clipping it between first and second fingers, thumb and forefinger on side nearest you. As cloth is pulled back over coin in right hand, coin is clipped by left thumb and finger. Right fingers simulate coin under cloth as left continues pulling its edge back. After coin is apparently at center of hank, left hand pretends to take coin through cloth, carrying coin in back of cloth where it is held by left thumb. Coin can now be extracted. Or left hand, under pretense of adjusting cloth, leaves coin behind cloth where it is held by right fingers, then made to rise slowly upward by right thumb. If coin is deposited in a trough between right thumb and fingers, hank can be shown on all sides before coin is made to rise.

77b. Hank covers left fist and well is made in center of cloth. Coin is inserted by first and second fingers of right hand, thumb palmed as fingers withdraw. Under cover of folding back edge of hank over left fist, coin is dropped into left hand, which then extracts coin through cloth.

## COMMENTS AND ADDITIONS



Fig. 133



Fig. 134

78. Two coins of different sizes are used – say a half and quarter. Right hand holds half at tips of thumb and first fingers with duplicate quarter secretly finger-palmed. Throw hank over the half. Left hand takes coin through cloth. As right starts to come out from hank, the thumb pushes palmed coin to left where it can be grasped as shown (Fig. 135) by curled fingers of left hand. Right hand now takes corners of hank, and the cloth is turned to horizontal position and given to spectator to hold as shown in Fig. 136. His left hand holds hank tightly in a fist, but right fingers hold extreme edge of the half. Make a pass with the other quarter, then strike the cloth in the center with the hand which presumably holds coin. This jerks the hank from spectator's right fingers. As it falls into vertical position, the duplicate quarter is heard to drop on top of the half, as though the coin had penetrated the cloth.

A slightly different handling will be found in Carlyle's "Wrist Watch Steal", in "Stars of Magic" series (the trick provides misdirection for stealing a watch). This effect is an excellent follow-up to No. 75 above. See "Bull's-Eye Coin Tricks", by Ireland and Marlo, p. 10, for a description of the two tricks in combination.

### C. Miscellaneous

79. "Copper and Silver". Not strictly impromptu because a British penny, which is same size as American half, is used. The penny is wrapped in handkerchief and held by one spectator. Another spectator holds a half in his closed fist. The two coins are caused to change places. Numerous methods have been devised which do not require double coins, and in which both coins can be marked. All these methods require, however, a duplicate coin. See "The Expansion of Texture" in Down's "Art of Magic", for a classic description of the effect. Dai Vernon's handling is given in "The Dai Vernon Book of Magic", p. 108. Several methods are given by J. B. Bobo in "Modern Coin Magic". For version in which no handkerchief is used see "Dai Vernon's Tribute to Nate Leipzig", p. 129, and John Scarne, "Copper and Silver", in "Stars of Magic" series.

### COMMENTS AND ADDITIONS

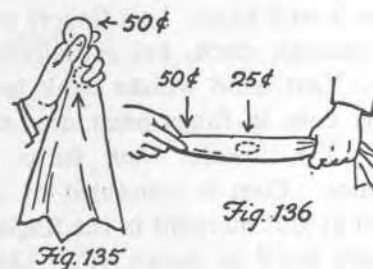



## COMMENTS AND ADDITIONS

Source:

Date:

80. Lou Tannen's immovable coin. Similar to immovable cigarette (See Cigarette, No. 40). As right hand drapes hank over left, it retains corner "A" until left thumb can be brought down and around edge nearest you, then up to grasp coin (Fig. 137). From front it appears as though fingers are holding coin through the cloth. Grasp corner "A" and jerk quickly from the hand. Left hand must have loose grip on coin. Coin will remain in left fingers, a feat no one can duplicate. If you wish, hank can be drawn slowly to right until it is free of left hand.

80a. Three coins of different denominations are placed under hank and given to spectator to hold through cloth. One of them is palmed out. Spectator covers glass of water with hank, drops coins into it. Hold glass on right palm, over palmed coin, remove cloth and let spectator look down into glass. He sees the three coins, apparently in glass. Cover with hank again, put glass on table, reproduce coin as you wish.

80b. Many methods have been published for the effect of covering glass with hank and apparently pushing a coin through the cloth into the glass. (The popularity of the rubber-dam trick, in 1966, created much interest in this type of effect.) Most of the methods involved gimmicked coins. For an excellent, almost-impromptu method, using a piece of double-sided cellophane tape to hold a duplicate dime under hank, and subtle moves, see J. W. Searles "Silver Ghost" in "Pallbearers Review", May 1967.

80c. Glass is covered with deck of cards (in the case) and then with hank. A marked coin is vanished, heard to fall in glass. Glass is uncovered and marked coin identified. For details of this beautiful effect, as performed by Leipzig, see "Vernon on Leipzig", by Dai Vernon, p. 124.



80d. At table, when no one is watching, slip a coin into an empty glass. Cover glass with cloth napkin. Duplicate coin apparently placed in left hand, retained in right. As left makes toss toward cloth-covered glass, right hand drops coin into a glass on lap, held by thighs. The sound seems to come from glass on table, which is uncovered to reveal coin.

#### Gags, Stunts, Betchas

81. On the back of a liberty head dime – if you turn it sidewise – you can find what looks like the top of a buggy showing above a fence. “Look closely”, you say, “and you’ll see the boy and girl”. When spectator fails to find them, say, “Well, what did you expect for ten cents?”

82. Bet victim he can’t lie flat on back, with a penny balanced on tip of nose, and make penny fall by wiggling nose. While his face is violently contorted, snap a candid photograph. Print picture with his face vertical. Penny appears glued to nose, and facial grimaces make it a rare snapshot. An amusing party contest is to have two people lie on floor, each with penny on nose. First to wiggle it off is winner. “Life”, Sept. 27, 1954, devoted three pages to pictures of all this.

83. Borrow several large coins. Balance one on edge, using a wet paper wad in back. Do it crudely, so he sees how you do it and claims he can do same. Say angrily, “I’ll give you ten cents for every coin you can balance.” After he’s balanced one, give him a dime for it – a good trade! More simply, tell someone you’ll give him a penny for every nickel he can balance on edge.

84. Victim is asked to sit on dime. What famous company does it remind him of? Woolworth – nothing over ten cents.

85. When Bert Allerton gives a penny to a waitress he remarks, “Now you have an odd scent.”

86. Announce that if anyone will place a coin on table and cover it with his hand, you will immediately name the date. What you name is the date of day on which you perpetrate this trick.

87. If a friend is holding a handful of change on his open palm, it is possible to tap back of your fingers on the tips of his fingers, then quickly scoop up the

#### COMMENTS AND ADDITIONS

Source:

Date:

entire handful of change in your fist before he knows what has happened. Be prepared to reimburse in case stunt fails on subway platform.

88. Take a quarter from pocket and borrow second quarter from friend. Wrap both in handkerchief (or piece of paper). Ask how many quarters are inside. When he's convinced the hank contains both coins say, "If you're so positive, would you give me 35 cents for the contents of the handkerchief?" If he says yes, accept the 35 cents and let him have both quarters. He may forget he's buying back his own quarter, and you make ten cents on deal!

89. Place two match folders on table. Borrow dime. Put dime under one folder. Announce it has vanished, and is now under second folder. If spectator is sceptical, say "Will you give me the dime if I'm wrong?" Not analyzing this statement he may say yes. You say, "Okay - I'm wrong." Lift folder and take dime.

89a. Offer to give someone a beautiful, sculptured, copper plaque, bas-relief head of Lincoln. Give him a Lincoln penny.

89b. Ask someone to take a coin from his pocket and hold in his fist. He gets one guess of date, you get two, but you offer three-to-one odds. Person who guesses closest to date wins. Guess the years just before and after the year he guesses; e.g., if he says 1964, you say 1963 and 1965.

89c. Tell someone to count the change in his pocket (while your back is turned), and that if he gives you a dime, you will tell him what he puts back in his pocket. Take dime and say, "You put back exactly ten cents less than the amount you counted."

90. Bend back arm and balance stack of coins on elbow. Bring hand forward in an arc and catch coins.

91. Three coins on back of hand. Toss in air and catch one at time with hand that tossed them.

92. One-handed faro shuffle of two stacks of half dollars. An old gambling flourish, also done with poker chips. See HMM, January, 1951, for detailed description.

## COMMENTS AND ADDITIONS

Source:

Date:

93. Playing card and coin balanced on tip of first finger. Other hand snaps away card, leaving coin on finger.

94. Balance a penny on tips of all four fingers. It is possible to assemble all four pennies on one finger (say the middle finger) without using thumb, but it is not easy.

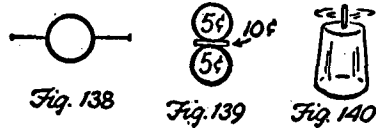

95. If half-dollar is held by pins (Fig. 138) blowing on it will make it revolve rapidly.

96. A large bowl, with penny inside, is held in the hands and given a circular motion. Coin can be made to roll on its edge around inside of bowl. Can also be done in coffee cup. A squeeze of coin, between thumb and forefinger, snaps it into its rotary action.

97. Two nickels and a dime can be balanced as shown (Fig. 139).

98. Half dollar is held in one eye like monocle. Let it fall from eye into lower vest pocket. Keep pocket open by wadding piece of cloth at bottom.

99. Hold drinking glass upside down, with half resting on bottom. Give glass a slight flip and blow vigorously on coin. It can be made to spin rapidly on the glass (Fig. 140).

100. A half resting flat on table can be made to spin by blowing against edge through a short piece of soda straw.

101. Coin can be bounced on concrete and caught again, if thrown with a spin so it hits on edge.

102. Hold coin loosely (Fig. 141). Strike edge sharply against table, sending coin forward, but with strong back spin. Will go out a foot or so, then return. Another method of getting same result is to hold coin between first and second fingers (Fig. 142). It is shot out to right, but

## COMMENTS AND ADDITIONS

Source:

Date:

## COMMENTS AND ADDITIONS

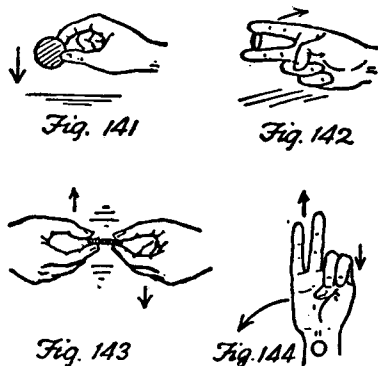

Source:

Date:

given back spin by downward pressure of index finger.

See "Dai Vernon's Tribute to Nate Leipzig", p. 108, for both methods.

103. Half is held at edges by tips of thumb and fingers of each hand (Fig. 143). Wiggle hands back and forth rapidly, giving audience an edge view of half. Gives illusion of rubber coin.

104. A dime on wrist can be made to turn over by snapping fingers.

105. Dime is placed on back of right hand, above knuckle of pinkie. Tell spectator you can make dime turn over by snapping pinkie off thumb (illustrate this with free left hand). You can do it, but he fails when he tries. Secret: the directions you give are false. Actually, thumb snaps off pinkie.

106. Dime is placed on wrist. If hand is twisted correctly, a tendon in wrist snaps dime several inches into the air. It is widely believed only certain people can do this, but it works with most everyone if properly done. The first two fingers must push the thumb forcibly toward you (Fig. 144) while third and fourth fingers are extended forward with as much force as possible. Hand is now bent slowly to the left until tension in wrist snaps. Experiment to determine exact spot where this occurs.

107. A half rests on flat palm. When tossed into air it spins rapidly. Others unable to duplicate. Secret: as toss is made, thumb moves so edge of coin hits tip of thumb, giving coin a spin. The toss makes this action invisible.



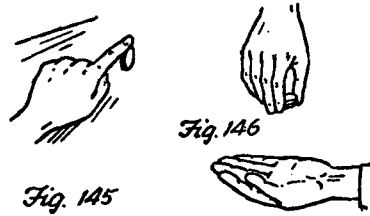

## COMMENTS AND ADDITIONS

Source:

Date:

108. Left forefinger holds coin on edge (Fig. 145). Right index strokes top of left finger several times. Suddenly coin begins spinning. Secret: on last stroke to right, tip of thumb hits edge of coin giving it a spin.

109. Two halves are held as shown (Fig. 146) with left palm beneath. Problem: drop lower half so it does not turn over before it lands on palm. Secret: give coins a slight rotary action before dropping lower half.

110. Two quarters are placed together and held between thumb and middle finger (Fig. 147) with tip of index finger resting on top edges.

The tip of the first finger appears to press edge of coin A, then draw back so quarter is pulled into position of Fig. 148. Index finger now brings coin A down behind B. Left fingers readjust coins, and this is repeated. When others try, they

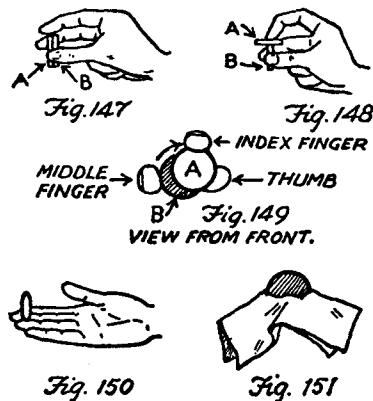

are unable to do it because coin B keeps turning in the fingers. Secret: tip of finger touches edge of coin A as close to tip of middle finger as possible. It then rotates coin slightly to left which raises it about quarter of inch above coin B (Fig. 149) and makes it possible to draw it over coin B. With practice, the rotary move blends into the drawing back move so that it is undetectable.

## COMMENTS AND ADDITIONS

Source:

Date:

111. Leipzig liked to balance a half dollar on the tips of two out-stretched fingers (Fig. 150). By gripping edge slightly with the flesh of the fingertips, it is not too difficult. If a piece of toothpick is secretly used behind coin, it is more effective to balance coin on backs of fingers. Moistening fingers slightly will make the Leipzig balance easier. See "Dai Vernon's Tribute to Nate Leipzig", p. 110.

## Puzzles

There are many "counter" puzzles applicable to coins — placing the counters in rows of various sorts, moving them about over diagrams drawn on paper, etc. These puzzles may be found in standard puzzle references, and cannot be adequately covered here. Only puzzles of special interest, easily adapted to coins, are listed below.

112. The camel and needle's eye. A piece of paper has a small circular hole. Problem: push a coin, much larger than the opening, through the hole. If paper is folded, coin can be forced through easily. (Fig. 151). Experiment to get hole as small as possible for the coin used.

113. Coin is covered with sheet of paper. Problem: to learn date of coin without removing paper. Rub pencil on the paper, above coin. This brings out impression of coin's face, and unless it is too worn, will reveal date.

114. Three coins are placed on table (Fig. 152). Place coin C between A and B, without touching A or moving B. This is done by placing tip of left forefinger on B and sliding coin C against B. The impact drives coin A several inches to left, making solution easy. C must be released from finger before it hits B to make it work well.

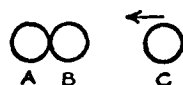
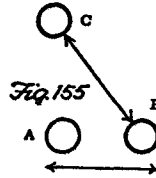
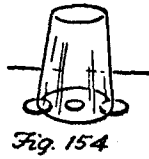

Fig. 152

115. Place three coins on table, adjusting them carefully. Ask which two are farthest apart. Answer: the two end ones!

116. Using same row of three coins, ask how center coin can be removed without touching it.

Answer: move an end coin from one side of row to other. Center coin is now no longer in center!



COMMENTS AND ADDITIONS

Source:

Date:

117. To make a square with four buffalo nickels (Fig. 153).

118. To make a cross with four pennies. Pick up one penny and with its edge mark a cross on tablecloth!

119. Inverted glass rests on two coins, with dime in center (Fig. 154). Problem: get dime out without touching glass. Can be done by scratching tablecloth in front of glass, which makes dime crawl forward, or raising cloth slightly in front of glass and tapping it, which scoots dime backward. The scratch method works on certain cloths only when weave is in certain direction. By setting the two coins along a different line, trick won't work when others try it.

120. Place two halves, A and B, on table (Fig. 155). Ask spectator to place third half, C, so distance between inside edges of C and B equals distance between outside edges of A and B. Measure to see how close he came. Usually he places C much too close.

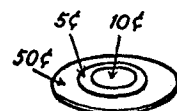
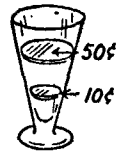
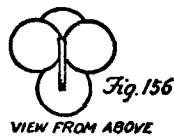

121. Place five pennies so each coin touches the other four. There are two solutions (Fig. 156 and 157).

122. A half and dime are placed in glass shaped as

shown (Fig. 158). Problem: remove dime without touching glass or half. Blow hard against half. It will rotate, and dime will be blown out.

123. Coins are placed as shown (Fig. 159). Problem: move one coin and have four in each row. Lowest coin is placed on top of corner one.

124. How many pennies can be placed flat on a dollar without over-hanging the edge? Answer is one. Most people guess more.

125. Spectator is asked to hold half as shown (Fig. 160) with nickel and dime on top. Problem: get nickel and dime side by side on coin without using other hand. If shaken sidewise, coins fall off. Secret is to shake up and down until coins separate.

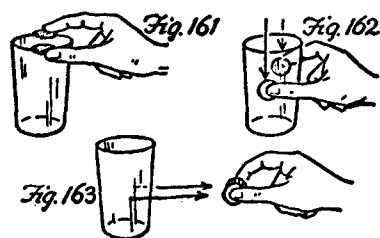

126. Two pennies are balanced on opposite sides of brim of drinking glass. Problem: get coins between thumb and finger, touching one coin with thumb only, and other with forefinger only. The thumb and finger are first placed on coins, then both are simultaneously slid down sides of glass. They can now be drawn off glass as shown. (Figs. 161, 162, 163). The puzzle can be presented in reverse — i.e., start with pennies between thumb and finger and try to place on brim of glass. Above moves are made in reverse.

127. Two coins rest on table as shown (Fig. 164). If upper coin is revolved around the other, the edges touching like two gear wheels, how many times will it have rotated when it returns to original position? Answer: two.

128. Eight pennies and eight nickels are arranged checkerboard fashion (Fig. 165). Problem: touch only two coins and rearrange square so each horizontal row contains four coins of same type. Place first and second fingers on coins A and B.

## COMMENTS AND ADDITIONS

Source:

Date:



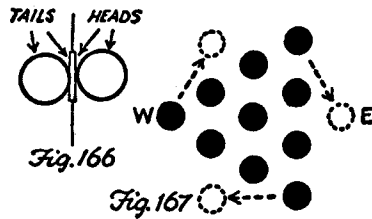
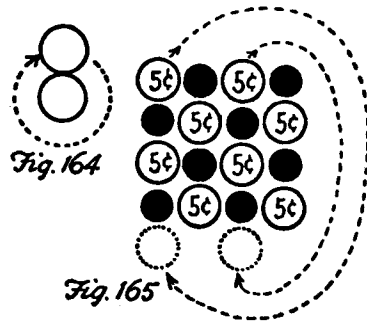

## COMMENTS AND ADDITIONS

Source:

Date:

Slide them to position immediately beneath 1st and 3rd vertical row. Push up , so those two rows are shoved upward. This will form new square, all horizontal rows alike.

129. Problem: drop dime from height of several inches so it lights and remains on edge. Moisten side of glass or bottle. Wet dime, place it against the glass, and drop. Will remain against glass after it hits table.

130. Hand a new penny to someone, with pocket magnifying lens, and ask him how many letters he can find on it. Usually he finds only 19. Three additional letters, however, are on left side of base of Lincoln's bust —initials of artist who made the engraving (David Eisendrath, Jr.)

130a. Can you find the snake on a penny? Copper-head.

131. Draw a line on tablecloth. Problem: place three coins so two heads are on one side of line and two tails on other. Fig. 166 shows how.

132. Ten pennies are arranged in triangular formation (Fig. 167). They represent airplanes flying west. Problem: move three pennies so the formation is flying east — that is, so triangle points to right. Each penny must be kept flat on table and moved in a straight line. Fig. 167 shows the only solution.

133. Draw a star of type shown (Fig. 168). Give a person seven pennies. Problem: place each penny, one at a time, on a point of the star, then slide penny along a line to another point. A penny can be placed only on unoccupied points, and after

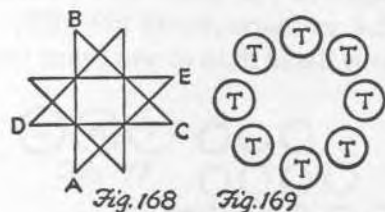

it is placed, it must be moved once. In this manner, place all seven coins on the star. Solution: second penny must be placed so it slides to the point previously occupied by first penny before it was moved. Same procedure is followed with remaining five coins.

To confuse onlookers you can vary procedure. After sliding first coin from A to B, inspection of star reveals that coin could have been moved to B from C as well as from A. Hence next coin can be slid from D to C. For third move you also have two choices, sliding to cover A or D. Two choices will be open to you for each remaining move, hence by varying procedure you better conceal method of placing.

134. Place eight coins in a circle (Fig. 169) all showing tails. Problem: change seven coins to heads by the following method. Place a finger on any coin, then count four in either direction. The fourth coin tapped is then reversed. This is repeated, but finger must start the count from a coin that shows tails. Continue until seven coins are turned. Solution: after the first count and turn, skip a coin and start second count on the next one. Continue in same direction. This will enable you to turn seven coins. Mathematically, this puzzle is identical with No. 133 above, but the presentation gives it a different appearance.

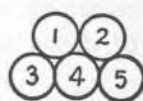

Fig. 170

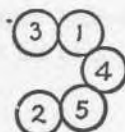

Fig. 171

135. Begin with five pennies as shown (Fig. 170). In four moves, arrange coins as in Fig. 171. Each

## COMMENTS AND ADDITIONS

Source:

Date:

move is made by sliding a penny so it touches two others. In this way the resulting formation becomes geometrically perfect. Solution: move 1 to touch 2 and 5; move 2 to touch 4 and 5 below; move 4 to touch 1 and 5 (on left); move 1 to touch 3 and 4. There are many puzzles of this type. See "Scripta Mathematica", March-June, 1951, p. 144, for analysis of one involving six pennies.

A simpler six-penny puzzle, with amusing twist, was shown me by Francis Rigney. Begin as Fig. 172. In three moves, form a circle as Fig. 173. Solution: move 4 to touch 5 and 6, move 5 to beneath 1 and 2, then 1 to touch 4 and 5. But

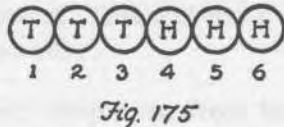

when you set up for spectator, place coins as in Fig. 174. Solution is now a mirror image of before, so if he follows your first move he will be unable to finish.

136. Six coins are arranged as in Fig. 175. Three are heads, three are tails. Move adjacent pairs by placing first and second fingers on top of the two and sliding them to new position in row. In three moves, end with row of coins, all touching, but alternating heads and tails. Solution: move 1 and 2 to extreme right of row; move 6 and 1 to extreme right; then move 3 and 4 into the open space.

136-A. Seven coins are held stacked in hand. Top coin is placed on table. Next coin goes to bottom of stack. Next coin is placed on table. Problem: arrange coins in stack so row on table will alternate heads and tails (Fig. 176). Solution: top down—1 head, 2 tails, 3 heads, 1 tail. Puzzles of this sort

COMMENTS AND ADDITIONS

Source:

Date:



*[Faint, illegible text and diagrams in the right margin, likely bleed-through from the reverse side of the page.]*



can be solved easily for any number of coins by forming row first, then working procedure in reverse until you are holding a stack.

137. Place three coins on table and count up to ten as follows. Pick them up, alternating hands, counting 1,2,3. Put down, counting 4,5, 6. Then pick up two only, one in each hand, counting 7, 8.



Replace, counting 9, 10. Call attention to fact that you finish count with all three on table. Pick up coins and hand to someone to try. Since he has them in his hands, he usually begins count by laying down three. The count is impossible if begun this way.

138. Place three coins in row, center showing head and outside coins tails (Fig. 177). Turn two coins at a time, and in three moves have all heads showing. There are many ways to do this, such as turning 1 and 2, then 1 and 3, then 1 and 2 again. Challenge someone to repeat this, but set up coins for him so center coin is tails, and outside coins are heads. With this altered beginning, which he is unlikely to notice, the puzzle is impossible in any number of moves. Whenever he accidentally gets coins in proper starting position, step in and "demonstrate" once again. Vary the demonstrations so moves are not the same each time, to further confuse spectator.

## COMB



1. Hitler imitation . Comb hair over forehead, hold black comb to upper lip (Fig. 181) and give Nazi salute.

2. Musical device — tissue paper over the comb's teeth. Hum through it.

## COMMENTS AND ADDITIONS

Source:

Date:

3. Imitation rod and reel. Hold comb with both hands as though it were handle of fishing rod. Pretend to cast, sliding thumb rapidly over teeth to give sound effect. As you pretend to wind reel, thumb moves over teeth to make the clicks.

4. Comb hair to charge comb with static electricity. Will pick up bits of paper, attract a floating balloon, etc. The following puzzles and stunts all make use of charged comb.

5. Pepper is sprinkled on top of some salt. To separate grains, hold charged comb over the mixture. Only the pepper jumps up to comb. A small comb can be palmed. Pass hand over pile. Pepper seems to vanish.

6. Tumbler is placed near small stream of faucet water (Fig. 182). To fill glass without moving it, hold charged comb so it diverts stream into glass.



7. Balance nickel on edge, and paper match on edge of nickel. Cover with inverted glass. To make match fall off nickel without touching glass, hold charged comb near it (Fig. 183). Thimble can be used instead of coin, or piece of paper instead of match.

8. Miniature Hindu rope trick. Hold one end of piece of thread (Fig. 184) with charged comb several inches above it as shown. Thread will remain rigid and follow movements of comb as it is moved back and forth, in circles, etc. Can also use small piece of tissue paper rolled into tiny cone.

9. If you're bald, take out comb with no teeth and pretend to comb your head with it.

## CORK

1. A cork is held in each hand at crotch of thumb. Problem: to put hands together and grasp each cork with thumb and finger of opposite hand in such manner that the hands can be separated. Unless fingers are properly placed, the hands lock.

## COMMENTS AND ADDITIONS

Source:

Date:



See C. Lang Neil, "The Modern Conjurer", p. 288.

2. Problem: to drop cork on table so it remains standing on end. Drop so cork falls on side. Cork bounces to upright position.

3. Corks normally float on sides. Problem: to make corks float upright. Wet corks and press sides together. Sides will stick and corks will float upright as a single mass.

4. Party stunt. Place cork on edge of table. Close one eye, turn around three times, and try to knock cork off table with index finger.



5. Place two large corks as shown (Fig. 185) with large ends down. Problem: to turn corks over by grasping them scissor-like between extended first and second fingers. Magician does it easily, but when spectator tries, the corks shoot forward. Secret: when explaining what to do, extend both fingers rigid. But when you demonstrate, fingers are curved slightly as indicated. Reverse corks quickly, and straighten fingers immediately after corks are turned. Momentary bend of fingers will not be noticed. Favorite of Ducrot's.

6. Cork toys. See "The Make-it Book", by Dixon and Hartwell, 1928, for section on boats, amusing animals, etc., to be made from corks. Novelty necklace can be made by stringing corks and pushing colored thumbtacks into them. Letters, tattoo designs, etc., can be cut into end of cork, and cork used with ink pad as a rubber stamp.

7. Problem: to make a small cork float in center of surface of glass of water. Solution: fill glass so full that surface is convex, rising slightly above rim. Otherwise, cork will not stay in center.

#### CRACKER

1. Hold opposite corners lightly between tips of thumb and middle finger. Blow. Cracker will spin rapidly.

#### COMMENTS AND ADDITIONS

Source:

Date:

2. State you intend to toss cracker on table. If it falls rough side up you'll buy him a beer. If smooth side – two beers. But if it falls so neither side is up (at this point hold edge of cracker against table) he owes you a beer. Crumble cracker in fist and toss crumbs over everybody. (Chic Schoke).

3. Party contest. Everyone is given a cracker to eat. Winner is person first able to whistle.

4. Make a heavy pencil line on cracker. Lift it by holding corners A and B with thumb and middle finger, place tip of left finger on corner X and

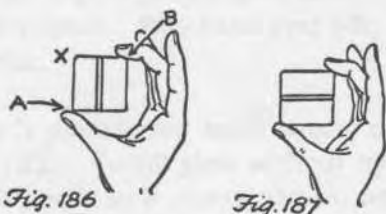

rotate cracker once (Fig. 186). Replace on table and draw second line like previous one. If cracker is held as shown and rotated by finger at corner X, the line appears to run north and south on both sides. Give cracker a quarter turn (Fig. 187). When rotated, line now appears to run east and west on both sides.

Reach beneath and pretend to twist lower line. Place cracker on table and with tip of finger raise edge so cracker somersaults forward. Lines are now at right angles! (Based on Val Evans' "Optogramma").

#### CRAYON

1. Spectator places a colored crayon in small box and gives to performer behind his back. Performer divines color of crayon. Method: face audience, open box behind back, scratch crayon with thumb nail. Bring closed box to front and pretend to look through sides with X-ray eyes. Color on nail tells you color of crayon.

2. Crayons are shaken in hat and hat held above performer's vision. Performer names color, then removes crayon of that color. This continues until all crayons are removed. Secret: before hat is shaken, push one crayon under hat band.

#### COMMENTS AND ADDITIONS

Source:

Date:

This is first crayon named. When you reach for it, scratch thumb on another crayon and push it under band. When you remove first crayon, the color on thumb tells you second one. Hat can be shaken again. Repeat procedure as you reach for second crayon. Thus you are always one-ahead until all crayons are removed.

3. Rainbow writing. Cover sheet of paper with vertical stripes of different colored crayon. If this is used as "carbon paper" it will produce script with rainbow color effect.

### CUP (COFFEE)

1. Wrist watch is set to any hour while performer is out of room. Watch is placed under inverted cup. Performer comes in, names the hour. Stooge places watch under cup and sets cup so position of handle indicates the hour, counting from an agreed-upon position of handle for twelve o'clock. Same principle can be used to key amount of money placed under cup, which one of a dozen of small objects, etc.

2. To push a plate through cup's handle. Insert pencil through opening and give plate a shove.

3. Three small pieces of bread are under inverted cup. Remove bread and eat. Announce you will make pieces return to beneath cup. Place cup on top of head.

4. Performer waves hand over hot cup of coffee, and the steam vanishes. Accomplished by performer (or stooge) secretly blowing gently on cup.

5. Problem: place ten pennies (or sugar cubes) in three cups so there is an odd number in each cup. Figure 188 shows one of 15 possible solutions made possible by putting one cup inside another.

Gag solution by Mel Stover. Put one sugar cube in one cup, one in another cup, eight in the third. Surely eight cubes is an "odd" number to put in one cup of coffee!

6. Pure cream can be floated on coffee by holding spoon at surface and pouring cream into spoon. It helps if several spoons of sugar are stirred into

### COMMENTS AND ADDITIONS

Source:

Date:

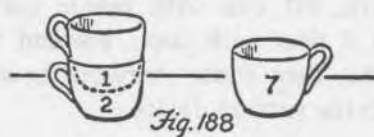

coffee before cream is poured. This increases the coffee's specific gravity and makes it easier to float the cream.

7. Restaurant gag. Patter about how absent-minded some people are, but one of your best qualittites is that you always have your mind on exactly what you're doing etc. Time patter so it occurs just as you are about to pour cream into coffee. Instead of pouring, allow entire creamer to drop into cup. Keep talking, stirring coffee with spoon as though oblivious to what has happened. If you wish, have pencil or fountain pen by cup and stir with it instead of spoon.

8. Stage or club effect. Begin with two cups, both filled with water. Hold one in each hand. Shake right hand cup slightly so audience sees some water spill out. Pretend to drink from this cup by tilting head back until cup is inverted at lips. Actually, keep water in mouth and as cup is lowered, let water run back into cup again. Repeat with left cup. Both cups are now believed empty. Shake right cup slightly so more water spills out. It seems to have become miraculously filled. Pretend to drink. Shake left cup. Pretend to drink. Continue producing water alternately in the two cups until only small amount is left in each. Now pretend to drink from right cup, but do not let water run back into cup. Drink from left cup, this time allowing all water in mouth to go back into it. Shake left cup and it seems filled to brim again. Pour water from left cup into right as finish.

9. While you are away from table, stooge pretends to put double suction cup under your coffee cup. You return, lift cup with pinkie curled beneath saucer so it rises with cup. Pretend to be angry at the joke, then show everyone how a magician can vanish the suction device.

10. Hold empty cup and saucer so right forefinger goes through handle and touches thumb to lock the cup to right hand. Saucer is held by clipping it between second and third fingers. As you pretend to serve cup of coffee to victim, let saucer tip and allow cup to slide off saucer with a clatter. Finger and thumb, of course, keep cup (which victim thinks is full of hot coffee) from falling into victim's lap. (Jack Chanin)

## COMMENTS AND ADDITIONS

Source:

Date:



11. Bob Hummer's three-cup trick. Magician turns back while spectator hides an object (say a folder of matches) under one of three identical coffee cups. Spectator is asked to switch the two empty cups without telling you which they are. He then switches pairs of cups, by sliding them on table, calling out each time the numbers of the switched pair. Magician turns around, immediately lifts cup that covers object. Secret: Identify one cup by some slight imperfection. Follow position of this key cup, as the switches are called out, by touching thumb to tips of first three fingers. When you turn around, check to see if key cup is at position indicated by thumb. If so, lift it. If not, lift the other cup that is not the key cup. For more details on this beautiful principle, see my "Mathematics, Magic and Mystery", p. 63, and my "Scientific American" column, August, 1964.

12. Practical joke on waitress. After obtaining second cup of coffee, look at watch, say "Holy smoke! I can't drink this now. I have to be back at the office in three minutes!" With straight face, pick up cup and slowly pour coffee into side pocket of jacket, and leave. A plastic bag in pocket does the trick.

#### CUP (PAPER)

For many excellent tricks involving prepared cups, see Samuel Berland's "Amazing Tricks with Paper Cups", 1942, and section on paper cups in Volume 4 of "Tarbell Course".

An ingenious kite made from conical paper cups is described on p.96 of Joseph Leeming's "Fun With Paper".

1. Paper cups (as well as coffee cups) can, of course, be used for impromptu cup and ball routines, using paper napkin pellets for balls.

2. Paper cups with those fold-out paper handles can be made into a face. Open out the handles to make them look like spectacles, pencil eyes on the cup, a nose, and poke a hole through cup to make the mouth. Cup is filled with liquid. Keep thumb over hole and ask "Who is it?" Remove thumb, say, "It's Wyatt Earp."

#### COMMENTS AND ADDITIONS

Source:

Date:





3. Imitation of Jimmy Durante. Put small paper cup over nose, hold with lower lip over lip of cup. (Robert Orben)

### DICE

A number of books deal with conjuring with dice – Eddie Marlo's "Shoot the Works", "Diversions with Dice", by the English magician, Treborix, and Audley Walsh, "Dice Dexterity",

Of the many books about methods of cheating with dice, the latest and best is, of course, "Scarne on Dice", 1945 by John Scarne and Clayton Rawson. An anonymous and undated 16-page pamphlet, "How to Control Fair Dice", distributed by the houses which supply crooked gambling equipment, is worth noting for its descriptions of several controlled cup shots not found elsewhere.

1. A die is placed on top of another one. When upper die is lifted, lower one clings to it mysteriously. Accomplished by secretly moistening a face of upper die with saliva. Hold between thumb and finger so moistened face is on side away from audience. Rub bottom of die on left sleeve, as though to charge it with static.

Place on top of second die and lift. Nothing happens. Repeat. This time fingers secretly rotate die (bringing moistened face to bottom) as it is carried from sleeve to table.

2. Die is handed magician behind his back. He is able to name upper-most side. Take die in both hands. Press tip of index finger firmly against upper face. Bring this hand to front to rub forehead. Imprint of die's spots will be visible on fingertip.



### COMMENTS AND ADDITIONS

Source:

Date:

3. Turn your back and ask spectator to hand you a pair of dice. Hold them between thumb and finger (Fig. 189). Ask spectator to take dice and add the two touching faces. While he does so, glance at impression of spots left on tips of finger and thumb. The total of these spots subtracted from 14 gives you spectator's total. Thumb and finger must squeeze dice tightly to get good impression.



Fig. 191      Fig. 192      Fig. 193

4. Dice force. Arrange two pairs of dice so each pair sevens all around. Fasten edges with cellophane tape (Fig. 190). Spectator shakes dice in cup, turns cup upside down on table, and lifts. Since dice are close together, joined edges are not apparent. Total of four faces will always be 14. (Gen Grant).

5. Two dice are held as in Fig. 191. The hand is apparently rotated to show opposite sides of dice, but as hand turns, dice are given extra quarter turn by thumb and finger. Fig. 192 shows position of hand after turn is made. The move is very old (see Sach's "Sleight of Hand", p. 74, and Hoffman's "Modern Magic", p. 268), and has provided the basis for many routines in which the spots seem to change mysteriously in various ways. The move is facilitated if dice are held at a slight angle, rather than parallel with thumb and finger (Fig. 193). In my opinion, the best routine is that of Dr. Theodore Sack, of Boston, which appeared in "Phoenix", June 18, 1948, and also in Bruce Elliott's fine book, "Classic Secrets of Magic". Other routines will be found in volumes 1 and 2 of Lewis Ganson's "Routined Manipulation".



Fig. 194      Fig. 195

## COMMENTS AND ADDITIONS

Source:

Date:

Some routines ring in misspotted dice. See, for example, Chapter 26 of James G. Thompson's "Top Secrets of Magic", Vol. 3.

6. A deceptive variation of the above move is to place two dice (they must be small) on back of left hand. Grip between first and second fingers as in Fig. 194. Rotate hand to right, keeping second finger against hand. Fig. 195 shows completion of move. Dice are apparently given a half turn, but if gripped originally with second finger high on dice and index low, the two fingers are able to give dice an imperceptible additional quarter turn. Practice with one die first. See "Dai Vernon's Tribute to Nate Leipzig", p. 145. Tenkai's variation, using three dice held in triangular formation, is given in Robert Parrish, "Six Tricks by Tenkai".

7. A pair of dice is rolled several times on table. Suddenly a third die appears. It is previously concealed behind right ear. Hand is raised near ear on each shake, making it simple matter to pick up third die when desired.

7a. Rolled die is covered with hank after top number is noted. You pick up die through cloth, hold to forehead, name the number. Cloth is squeezed tight around die and you see spots through it.

7b. A number of people each roll a die and remember the number while you watch. Later, you tell each person the number he rolled. The mnemonic device is to associate a type of clothing with each of the digits from 1 to 6 (e.g., woman's dress, soldier, tramp, cowboy, policeman, Indian) and mentally dress each spectator in the proper clothing.

#### Jugglery

8. Thumb holds die against side of dice cup or glass (Fig. 196), with second die resting on top. Problem: toss each die, one at a time, into glass. First die is easy, but second is hard to toss in without first die coming out. Instead of making upward toss for second die, release it, then lower cup suddenly to catch.

#### COMMENTS AND ADDITIONS

Source:

Date:



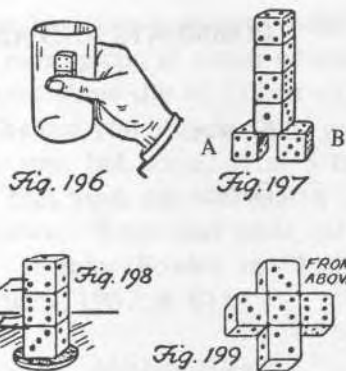

## COMMENTS AND ADDITIONS

Source:

Date:

9. Stack three or four dice on two dice as shown (Fig. 197). Problem: grasp die A in finger and thumb of left hand, and B in finger and thumb of right. Lift all six cubes and drop into dice cup or glass. Present as rest for steady nerves. You can do it, but when others try, stack topples. Secret: touch tips of thumbs in back of dice.

10. Three dice are stacked on coin, with two small bits of paper projecting from between dice (Fig. 198). Problem: remove the pieces, and the coin, without touching dice or toppling them. Bits of paper are snapped away by finger. Slide second coin across table to knock out coin beneath stack.

11. Five dice are placed as in Fig. 199. Problem: pick them up with one finger only. Turn hand palm up and lift by curling index finger and thumb around them. Thumb is not a "finger"!

12. One die can be balanced on another, if spots are of sunken type (Fig. 200). It is also possible to spin a die on one corner, like a top. Difficult to say which of these stunts is most unimpressive.

13. Problem: balance two dice on top of third as shown (Fig. 201). Secret: side of one of the upper dice is moistened with saliva. Dry sides with thumbs as you hand dice to spectator to see if he can duplicate feat.

14. Ask spectator to hold three dice as shown (Fig. 202). Problem: drop center die, keeping other two between thumb and finger. If he tries by letting center die slip down slowly, he is lost. Can be done by pressing hard with thumb and finger, to make outside cubes stick to the tips. Move thumb and finger apart slightly, allow-

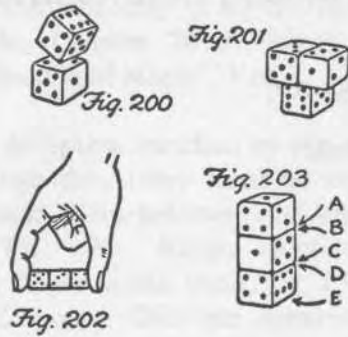

ing center die to fall, then quickly bring remaining two dice together again. Can also be done with four or more cubes, allowing all but two end ones to fall.

14a. There are numerous juggling flourishes, not difficult, with dice and cup. See "Phoenix", July 10, 1953, for Kirk Stiles' explanation of how to place die on bottom of inverted cup, toss both in air so that cup revolves and you catch it, the die falling into it. For similar jugglery, see Roger Montandon's letter to Stiles in January 8 issue.

#### Dice and Cup

15. Paul Rosini's dice trick. Spectator shakes single die in cup, turns cup upside down on table. Magician moves cup back and forth for a while, then names number uppermost. Before dropping die in cup, moisten one side liberally with saliva. As inverted cup is moved about over table, shake it occasionally so die turns over. Continue until a slight wet streak on table indicates moistened side is down. Upper side can now be named.

16. Same effect as above. Paper cup is used with small hole in side. Thumb covers hole. With hand on cup, turn face away while spectator places die beneath. Peek through hole to see which face is showing.

17. Dice stacking. Inverted cup, containing four or five dice, is given a few shakes. When lifted, dice are stacked in single column. Made famous in U.S. by Johnny Paul, of Chicago, whose routine includes stacking so top die shows number called (or even thought of) by spectator, a complete vanish of all dice, and final production of single huge die. The method of stacking is described in the Marlo and Treborix books. Senator Crandall's "Dice Stack" is available as a booklet.

#### COMMENTS AND ADDITIONS

Source:

Date:



17a. Die under a cup is secretly balanced on one point. By moving cup in either of three different directions you allow die to fall so either of three sides show before you lift cup. You place die each time under cup, bet someone at 5 to 1 odds in your favor that your die will match a second die that he throws. Your real odds, of course, are fifty-fifty. (Danny Fowler in "Pallbearer's Review", February, 1967, p. 81).

#### Mathematical

18. A number of dice tricks are based on positional notation of numbers. For example, three dice are thrown while magician's back is turned. Spectator multiplies number on first die by 2, adds 5, multiplies result by 5, adds face of second die, multiplies result by 10, adds number on third die. Final result is announced. Magician now names faces of all three dice. Secret: subtract 250 from final result. The three figures in answer are the three faces of dice, in order.

19. Magician turns his back while three dice are rolled. Spectator adds faces, then picks up any one die and adds bottom of that die to former total. This die is thrown again, and number showing is added to previous result. Magician now looks at the dice, emphasizing fact that he has no way of knowing which of the three was given the extra roll. Yet he correctly names final total. Secret: 7 is added to total of faces showing. This has many uses in connection with other tricks. See Dai Vernon's "Select Secrets" for application to a card effect.

20. Frank Dodd's dice and matches. Magician turns his back while spectator stacks three dice and covers with hat or dice cup. Magician turns around, hat is removed, and the five faces which are completely hidden (faces A to E in Fig. 203) are totaled. This total corresponds exactly with number of matches in a folder resting on table! Prepare six folders in advance so number of matches in each are 15, 16, 17, 18, 19, and 20. Folders go in different pockets which are mentally numbered so that the 20 folder is in pocket 1, the 19 folder in pocket 2, the 18 folder in pocket 3, and so on.

#### COMMENTS AND ADDITIONS

Source:

Date:



After dice are stacked, look over shoulder to direct spectator to place cup over dice. Notice top face of top die. This indicates number of pocket from which you remove folder. After you turn back to table, one hand leaves folder unobtrusively on table as other hand lifts cup. The rest is automatic. Audience will not recall either glance over shoulder, or placing of matches.

Instead of folders, Gerald Kaufman suggests having 21 loose matches in coat pocket. Reach into pocket, grab all 21, then count off and leave in pocket a number corresponding to top face of stack. The handful of matches is placed on table by cup, and will correspond to total on the dice. Note: in adding the five faces, total A and B first, then add remaining faces, to conceal the 7 principle on which trick is based.

21. There are only two different ways a die can be numbered so opposite sides total seven. One is a mirror image of other. Modern dice are all of "counter-clockwise" variety. This means that if die is viewed so 1,2,3 sides show, with 1 on top (Fig. 204), the numbers rotate counter-clockwise. Similarly for 4, 5, 6 (Fig. 205). By keeping these pictures in mind, it is not difficult to name uppermost faces of a number of stacked dice, topped by a coin (Fig. 206). For other ways of presenting this as a trick, see Bob Stull's article in HMM, Jan., 1949, p. 502, and comments on the piece, April, 1949, p. 532.

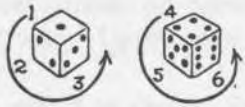

Fig. 204



Fig. 205

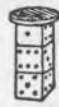

Fig. 206

22. Many paradoxical dice bets have odds quite different from what might be expected. For example, bet that before someone rolls two 7's he will roll both a 6 and 8. Since there are six ways to make a 7, and only five ways to make either a 6 or 8, a 7 is clearly easier to roll than either of the other two numbers. Hence the bet seems to be in his favor. Actually the odds are 6 to 5 in your favor. A similar paradox bet, slightly in your favor, is to bet even money that on every roll of a pair of dice an ace or 6 (or any two numbers you care to specify) will show. For other sucker bets

## COMMENTS AND ADDITIONS

Source:

Date:

with dice, see "Scarne on Dice", p. 161f., "Scarne's Complete Guide to Gambling", p. 664f., and Oswald Jacoby, "How to Figure the Odds", Chapter 11.

23. The "50 Game". Two persons each hold a die. They take turns showing it with any number uppermost they choose. With each showing, the number is added to previous total. First person to reach 50 is winner. To win, memorize the following keys - 1, 8, 15, 22, 29, 36, and 43. If your die reaches any of these, you can win by always showing a face which totals seven when added to face he last showed. Obviously, first player can always win by showing 1, and second player can always win if first person doesn't show 1. When playing with someone who doesn't know the method, however, you are likely to win regardless of what numbers are played first. Simply aim for one of the higher keys.

24. The "25 Game". First player calls a number from 1 to 6. Second player throws die and face is added to previous number. From now on, players take turns giving die a quarter rotation in any direction to show a new face. Each new face is added to previous total. Person who reaches 25 (or forces other player to go above 25) wins. First person has sure win if he calls 2 or 4, but the method of playing is complicated.

25. The "31 Game". First player places die on table with any number uppermost. Players take turns making quarter rotations, always adding the new face to previous total. Person who reaches 31 (or forces opponent above 31) wins. First player has sure win if he starts with 4 and plays correctly. See Kaplan's "Fine Art of Magic", p. 275 for an analysis, and a mnemonic aid in playing. Dr. Jacob Daley (who contributed two articles on the game to "Conjuror's Magazine" a few years ago) has recently developed a simple formula for playing correctly regardless of what number is adopted as the goal. The method is too complex to explain, but keys are determined by adding the digits in the goal number until only one digit remains. Thus, if goal is 79, 7 plus 9 equals 16, and 6 plus 1 equals 7. Seven is, then, the basic key. If this final digit is 9, the second player has a certain win. Otherwise, first player can always win.

## COMMENTS AND ADDITIONS

Source:

Date:

26. Dice can be used for forcing multiples of 7 which in turn can be used in other tricks, especially card tricks, in all sorts of clever ways. An excellent summary of possibilities is given by Ronald Wohl ("Ravelli") in "Ibidem", No. 30, Nov., 1964, pages 15-21. For example, to force 21 with two dice: they are thrown and total remembered. Either die is picked up, its bottom added to previous total, then it is thrown again and its top number added to running total. Finally, both dice are turned over and the two new faces added.

With three dice, Wohl proposes the following method using dice of three different colors. Each of three people is given a die. Each roll his die, notes top number. Each now picks up a die of different color and adds its bottom face to his previous number. The three numbers thus arrived at by each spectator naturally add to 21. With two dice the same procedure forces 14, with four dice, 28, and so on up the multiples of 7.

Karl Fulves, in his "Pallbearers Review", Jan., 1968, has a card trick exploiting a similar dice force, but with different twist. Dice of three different colors are thrown. Each of three people choose a different pair of colors. First spectator, say, recalls total showing on red and green dice. Second spectator then turns over the two dice of his color pair, say red and white, and remembers the total. Third person then turns over the green and white pair and remembers total. Again, the three totals add to 21.

27. Hummer's die mystery. Magician turns head to one side while someone places a die under magician's cupped hands. Spectator thinks of number from 1 through 6. Magician raises his hands so spectator sees three faces of die. Spectator says whether he sees his number. This is repeated two more times, then magician lifts hands and the thought-of number is on top of die. The method was first explained by Bob Hummer in his "Three Pets" (1952). See also my "Mathematics, Magic and Mystery" (p. 45), and Jack Yates, "Minds in Close-up", (p. 11).

28. The thirteenth turn. If three faces of a die are viewed from any angle, the sum of the faces will be odd or even. Each time die is given a quarter-turn

## COMMENTS AND ADDITIONS

Source:

Date:



in any of six ways — north, south, east, west, clockwise, counter-clockwise — the parity (odd or even) of the sum of the three faces changes. This suggests a variety of tricks, one of which, "The Thirteenth Turn", I first described in "The New Phoenix", Feb., 1964. A die is placed on sheet of paper and a square traced around its base with a pencil. Turn your back. Ask someone to give die twelve quarter-turns of any type. Then ask him either to give it a thirteenth turn or not, without telling you which decision he made. You turn around and immediately say whether he made a thirteenth turn.

The trick is repeated as often as desired. Simply view the die from same angle as before. If sum of the three faces has changed parity, a thirteenth turn was made. Hard to puzzle out because no single face or pair of faces provide a sufficient clue; only all three.

Instead of asking him to turn die a certain number of times you can give him a choice of spelling two words or names by turning the die once for each letter, then later tell him which word he used. The words, of course, must have opposite parity; for example, his own last name and another name.

Many routines with several dice suggest themselves. For instance, three opaque dice of three different colors are placed on three squares drawn on paper. Turn your back. Ask someone to pick a die, give it one quarter-turn, then mark the spot by putting a pencil dot in the center of the square on which die rests. He then turns dice at random, each time calling out color of die turned. He stops whenever he wishes. You turn around, lift the die that covers the dot. In this case, memorize the initial parities of each die. With back turned, keep track of their changes of parity by extending or bending three fingers of one hand. When you turn around to view dice from same angle as before, the die that fails to match the parity it should have, as indicated by a finger, is the die covering the spot. For ways of adapting these tricks to sugar cubes, see SUGAR, LUMP, No. 10a.

## DOMINOES

"Domino Deceptions", a 10-page booklet by Frederick F. Furman, was published in Los Angeles

## COMMENTS AND ADDITIONS

Source:

Date:



in 1919. Ball's "Mathematical Recreations", revised 1947 edition, describes several magic squares formed of dominoes, and also discusses some interesting domino puzzles. Other domino puzzles will be found in standard puzzle books.

1. Magician predicts in advance the two end numbers after spectator shuffles dominoes and forms them into chain. Before showing trick, palm off any domino except a double one. The two numbers on this domino will be the end numbers of the chain. Can be used as a force for two numbers.

2. Spectators are baffled to find two people playing dominoes by placing pieces face down to form the chain. When game is over, pieces are turned face up and found to match correctly. Each player keeps a foot on other person's toe. As each play is made, player presses toe to signal outside number of piece. Game begins with players signaling each other their highest double.



Fig. 207

3. Many mathematical card tricks are applicable to dominoes. One of the oldest and best, makes use of face down row of 13 dominoes, side by side. Unknown to audience, totals of spots on each are in sequence from 0 through 12, running left to right (Fig. 207). While magician turns back, spectator shifts any number of pieces from 1 to 12, from left to right end. Magician turns around, immediately turns over a domino. The spots correspond to number of pieces moved. Repeated as often as wished without rearranging dominoes.

Secret: remember total on domino at extreme left. Count to that position from right to find proper piece to turn over. If domino at left is the double blank, consider it as 13 when making count. If spectator tries to fool you by not moving any pieces, the double blank will be turned over.

4. Magician permits two players to play a game, but casts spell over it so players soon reach point at which no play can be made. Magician shuffles dominoes, removes spell. When players try again,

## COMMENTS AND ADDITIONS

Source:

Date:

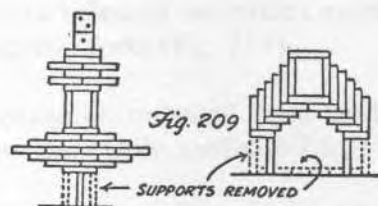
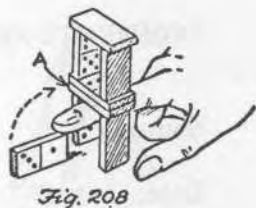

game proceeds to usual finish. Done by palming out two dominoes, bearing four different numbers.

5. Seven dominoes are formed as shown (Fig. 208). Problem: knock out domino A without disturbing others. Place a domino on its side edge, in position shown. Index finger goes through the "gate", presses on corner of domino to rotate it up and back, knocking out desired domino.

6. Precariously balanced structures, which seem impossible to build, can be formed by using dominoes to support the edifice while it is built, after which the supporting pieces are removed. Fig. 209 shows two such constructions. Dotted lines indicate positions of supporting dominoes.

## DOUGHNUT

1. Restaurant gag. Tell story of sailor who ordered two cups of coffee and one doughnut. He broke doughnut in half, placed a half on each saucer. (Illustrate by doing this with a doughnut). The waitress said, "Oh— I see you're a sailor!" How did she know this? Answer: he had on a sailor suit.

2. Doughnut is threaded on piece of rope, ends held by spectator. Under cover of napkin, magician removes doughnut. Duplicate doughnut is in sleeve. Under cover of cloth, break doughnut from rope, exchange it for duplicate in sleeve.

3. Gag version of above. Place head under napkin and eat doughnut. Whisk away napkin to show doughnut has been removed, while you patter

## COMMENTS AND ADDITIONS

Source:

Date:



Fig. 210

about it with mouth crammed so full you can hardly talk.

### EARS

1. Announce you can wiggle left ear without wiggling right. Grab left ear with hand. Wiggle it vigorously.

2. Both ears can be made to flap mysteriously by attaching thread to back of ears with tape (Fig. 210), then a single thread running down back and under coat. Pull thread with hand behind back.

3. Restaurant gag. Roll up check and insert one end into ear before approaching cashier. Tell cashier, as you search through pockets, that you can't find check. Not all cashiers think this is funny.

4. Subject is blindfolded. Click two coins (or make some similar noise) near his right ear and ask him to point to spot where sound came from. He will do so correctly. Repeat with left ear, and above head. Again, his guesses are correct. But when clicks are made near back of neck, or beneath his face in front, guesses are wildly off mark. Willane suggests calling "correct" after each bad guess, to make it more amusing to audience.

### EGG

1. To balance egg on end, form small pile of salt, balance egg on it, then gently blow salt away. A few invisible grains will remain and keep egg balanced, puzzling spectators who do not see preparation. According to legend, Columbus solved this problem by placing egg on end with such force that shell cracked slightly, enabling him to balance it. If egg is shaken vigorously to break yolk, it sometimes can be balanced on the broad end without cracking shell. See "Life", April 9, 1945, for pictures of a curious epidemic in China of standing eggs on end.

### COMMENTS AND ADDITIONS

Source:

Date:



## COMMENTS AND ADDITIONS

Source:

Date:

2. Egg can be balanced on bottle's mouth, with aid of cork and two forks (Fig. 211).

3. To distinguish unboiled from hardboiled egg, spin it on side. Only hardboiled eggs spin easily.

Charlie Miller suggests doing this with an egg previously blown so it is only a shell, but spectators do not know that. Explain that a hardboiled egg will spin on its side (spin the egg gently on its side), a fresh egg will spin only upright (spin it gently on its end), but only a magician can make the same egg do both. Spin it hard on its side. It will spin for a while on its side, then turn and continue spinning on its end. (For an explanation of why it does this, see John Perry's "Spinning Tops and Gyroscopic Motion", reprinted as a Dover paperback in 1957, pages 54-57).

4. Place unboiled egg on side, spin, then stop it suddenly by placing finger on top. At instant egg comes to dead stop, lift finger. Inertia of contents will start egg turning again.

5. Hardboiled egg can be spun on the small end with the fingers, then kept spinning like a top by whipping it with whip made of stout cord on end of stick.

6. Clasp hands, holding egg between palms, the two ends touching center of each palm. Surprisingly, it is impossible to break egg by squeezing hands.

7. Egg will float on water when salt is added. If tall glass is half filled with salty water, egg can be floated, then clear water carefully poured on top without disturbing the bottom solution. Egg now floats in center of filled glass.

8. Egg is allowed to sink to bottom of glass of water. If glass is held under running faucet, water currents cause egg to rise to surface.

9. Coat egg with soot by holding it over candle flame. When dropped in glass of water, looks like a silver egg.

10. Two shot glasses are placed side by side, with egg in one. By blowing down on egg, it can be made to hop over to other glass.

It is also possible, with right-size glass, to blow and cause egg in glass to jump up, reverse ends, and fall back again. Mark an X on end of egg, then bet you can reverse ends without touching egg or glass.

11. Hardboiled egg, with shell removed, cannot be pushed into milk bottle because of air pressure. Can be done, however, by dropping burning match into bottle, placing egg upright on neck. The vacuum formed will draw egg through neck. To remove, turn bottle upside down, allowing egg to fall into neck. Blow hard into bottle. When lips are removed, air pressure forces egg out through neck. Keep left hand near opening to catch egg as it emerges.

12. If hardboiled egg is soaked in vinegar overnight, shell becomes plastic. Follow directions given above to place egg into milk bottle. Run cold water into bottle to remove match, and restore shell to original condition. (An attempt to perform this stunt provides the sad climax to Sherwood Anderson's famous story. "The Triumph of the Egg.") Hide bottle somewhere in a side room. Show audience duplicate bottle and egg, and state you can place egg into bottle. Retire to side room return with previously prepared bottle.

13. Bet someone he can't place thumb and finger through crack of door (above top hinge) and hold an egg on other side of crack. As soon as egg is in place, place victim's hat on floor directly beneath, brim up, then walk away. He'll be trapped until you take egg from him.

14. A string wrapped around egg can't be burned (egg absorbs the heat).

15. Problem: place egg somewhere in room where it can't be smashed with circular wastebasket or tray. Egg is placed on floor in corner.

## COMMENTS AND ADDITIONS

Source:

Date:



16. Problem: place a person and egg on sheet of newspaper in such manner he can't kick egg off paper. Paper goes under door, with egg on one side, person on other.

17. To name color of Easter egg handed you behind back, push egg up sleeve, bring hand to front to rub forehead, glance into sleeve, note color, then return hand behind back and name color.

18. With practice, egg can be tossed into air and caught on a plate without breaking. Bill Talent has long featured this in his juggling act by placing egg on floor between heels, jumping with both feet sending egg into air behind him, then catching it on a plate held in one hand. Talent pretends to practice the feat twice, using rubber ball instead of egg. Each time, ball sails into audience while Talent apologizes for clumsiness. Then he tries egg and catches it successfully.

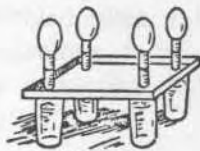

Fig. 212

19. Four glasses filled with water, a tray with slightly raised edge, four playing cards rolled into cylinders (held by rubber bands), and four eggs are balanced as shown (Fig. 212). Sharp blow with palm against edge of tray will knock tray and cards away, allowing the four eggs to drop neatly into the glasses.

20. Party stunt. Place half a dozen eggs in a line across rug, at intervals of foot or so. Ask victim to remove shoes. Let him practice walking several times across rug, stepping carefully over each egg. Victim now attempts to do this blindfolded. As soon as his eyes are covered, quickly remove eggs and substitute oyster crackers. Women victims, when they step on cracker, emit unusually violent screams.

21. Party game. Empty egg shell placed in center of table. Two players or two teams stand on opposite sides of table. Each tries to blow egg off opposite edge.

## COMMENTS AND ADDITIONS

Source:

Date:

22. Apparent production of endless number of eggs from handkerchief, each egg dropping from handkerchief into hat. Followed by vanish of eggs from hat. Makes use of single egg shell attached by thread to hem of handkerchief. Too well known to require description.

23. Party stunt. Newspaper is spread on floor and plate of eggs brought forward. Announce you will demonstrate ability to balance egg on point of pencil. First egg fails to balance and breaks on newspaper. Same thing happens to second and third attempts, while you pretend to get more and more angry, cursing audience under your breath for not maintaining "absolute silence." After fourth egg breaks, your temper explodes and you start heaving remaining eggs at audience. These eggs are, of course, blown shells, but for a moment you scare the devil out of the guests.



24. Obtain a piece of eggshell (from side of egg rather than end) about size of half-dollar (Fig. 213). Place it on edge of plate that has been held under faucet so surface is wet. If plate is held at angle (Fig. 214) the piece of shell will rotate with surprising rapidity, at same time moving precariously around extreme rim of plate as you keep turning it in the hands. Experiment with different pieces of shell until you obtain one that operates, as some pieces will not be properly balanced. Plate must be smooth around the edges.

25. Hold table knife (Fig. 215) with half of egg shell over end of blade. Problem: rap handle on table in such way that point of blade penetrates shell. When spectator tries, shell bounces off. Done by holding knife loosely in hand, letting it fall of own weight and bouncing. The bounce does it.

26. Bug-eyed monster. Pencil or ink a black spot on the end of each of two half-shells. Place over your eyes, holding each in place like a monocle.

## COMMENTS AND ADDITIONS

Source:

Date:

27. Name of forced card, number, etc., is found written on hardboiled egg after shell is removed. Writing is done beforehand with a brush dipped in solution of one ounce of alum to one pint of vinegar. When dry, writing is invisible. Boil egg. When shell is removed, the writing can be seen on the egg.

## ENVELOPE

Innumerable feats of mental magic make use of envelopes. Messages sealed inside are read by methods which include variations of the "one ahead," the use of alcohol or cleaning fluid to make the paper transparent, and use of strong light behind envelopes of thin paper. Prepared envelopes of various types (See "Tarbell Course", Vol. 5, p.172f for a description of several varieties), nested envelopes, slit envelopes, and envelopes with concealed carbon paper (black or colored). Opaque white paint can be used for painting a replica of a folded billet, dollar bill, coin, etc., on the inside of envelope, so when held up to light it casts a shadow suggesting that the object is inside when it really isn't.

Subtle methods have been devised for switching one envelope for another, as well as billet switches which use the envelope as a shield. Although some of this material might be regarded as impromptu in nature, it belongs more properly to the realm of club and stage mentalism, and therefore will not be further elaborated.

1. Envelope is sealed, and both ends trimmed away to form paper tube through which ribbon, rope, or string is passed. Unknown to audience, there is a slit in back of envelope. This enables magician to cut envelope in half with scissors, without damaging ribbon. The blade goes into slit, under ribbon, then out of slit. From front, scissors appear to be cutting both envelope and ribbon.

2. Self-opening envelope. Fold letter as shown (Fig. 216), then cut off corner of envelope so when letter is sealed inside it looks like Fig. 217. To open: hold right edge of envelope, pull projecting corner of letter to left. Folded edge will automatically cut open side of envelope.



Fig. 216

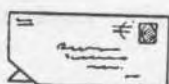

Fig. 217

## COMMENTS AND ADDITIONS

Source:

Date:

3. A used envelope can be steamed open at all seams, the folds reversed, then pasted together again to form a new envelope, blank on the outside. Why buy envelopes? Answer letters by using same envelopes in which letters come!

4. Bert Allerton's optical illusion. Obtain a calling card envelope of such size that a playing card exactly fits it. When envelope is placed on table beside a spread deck of cards, it seems impossible for a card to fit in such a small envelope. Spectators are astonished to find it does.

#### FACE

1. Upside down face. Cover small table with cloth large enough to reach floor on all sides. Someone lies flat on his back, under table, his head projecting beneath cloth (Fig. 218). Drape cloth so it covers his chin, mouth, nose. With lipstick paint a nose and mouth on his forehead. The result is weird – a head apparently severed from the body. His hair forms a beard, the eyebrows make grotesque tufts beneath the eyes. When eyes are winked, and rolled from side to side, effect is particularly amusing. Party guests brought into room for first time often have difficulty guessing how head is formed.

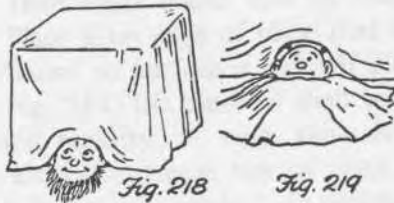

2. Same set-up as above, except cloth is draped over neck only, leaving entire head exposed. A towel is now placed over the face so only chin and mouth show. With lipstick or black grease pencil, make a nose and eyes on the chin (Fig. 219). Result – a terrifying, bald little pinhead, whose skull seems to pulsate when he talks!

This stunt was invented by the physicist Robert W. Wood (See "Dr. Wood", by William Seabrook, p. 135). Paul Winchell has made effective use of it on his T.V. show in the fifties, and in 1961 introduced it as a toy called "Ozwald" – a boxed set with a dummy figure to attach to chin and a

#### COMMENTS AND ADDITIONS

Source:

Date:



## COMMENTS AND ADDITIONS



Fig. 220



Fig. 221

special mirror for viewing your face upside down. See "Life", Sept. 29, 1952, pages 12 - 14, for pictures of Ozwald.

3. Construct cardboard collar high enough to cover face (Fig. 220). With grease pencil make the eyes, eyebrows, and nose on forehead as shown.

4. With grease pencil, make pair of eyes and eyebrows on forehead above your own (Fig. 221). Close eyes to produce one comic effect, open them for another.

5. Similar to No. 2 above except that eyes are painted on the neck instead of on tip of chin. The tip of chin, viewed upside down, makes the nose.

6. Another weirdy. Wig worn backward covers your eyes. Paint another pair of eyes beneath wig, on each side of nostrils. Or let wig come down over nose and paint tiny eyes and nose on upper lip.

7. Mind-reading parlor trick. You go out of room and someone thinks of a number. You return, feel temples of everyone in room. Stooze signals number by clenching his teeth. This causes a pulsation of his temples.

8. "Facies". According to "Life", June 17, 1957, page 14-15, this was a current teen-age craze similar to the earlier "handies" (see HANDS, No. 95). The idea is to do something to your face and ask people to guess. Samples: squeeze both sides of face with hands ("Please, Mr. Bus Driver, can I come in?"); poke index finger into mouth and against inside of one cheek ("Madam, please remove your umbrella,"); poke finger against tip of nose, look cross-eyed ("Johnny, come get your dart!"); pull up corners of both eyes ("Japanese man"), pull down the corners ("marry, Chinese girl"), pull one up, other down ("Result: crazy mixed up klid").

Source:

Date:





Fig. 222

## FEATHER

1. "X-ray" device. A bird feather is scotch-taped behind a hole in a piece of cardboard (Fig. 222). When a hand is viewed through the feather, bones of finger seem to be visible. Similarly, the lead inside a pencil. Only feathers of certain kinds work well. The illusion is caused by light diffraction which forms a smaller image of hand inside the large one, giving appearance of bones.

2. Party stunt. Contestants bend head back, and a feather (not too light) is placed on each forehead. Object: blow feather off without moving head or wrinkling brow.

3. Numerous party games involving feathers have been devised, such as races in which each group tries to blow their feather across room first, or contests in which each group tries to keep a feather in air longest by blowing.

## FIRE TONGS

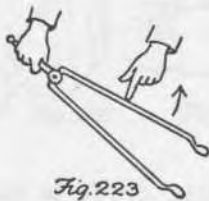

Fig. 223

1. One arm of pair of fire tongs is an extension of handle. Other arm is free. Rest fixed arm against floor (Fig. 223). Left hand lifts free arm and allows it to fall several times. While moistening tip of left index finger on tongue, right hand raises tongs to vertical position. Return them to former position, but with arms of tongs secretly reversed. Touch tip of left index finger to the upper arm as shown. As left hand rises, right hand levers up arm, giving impression that the arm is sticking to fingertip.

## COMMENTS AND ADDITIONS

Source:

Date:

## FORK

## COMMENTS AND ADDITIONS

1. Hold fork in left fingers, the hand resting on table so handle of fork is almost touching table top. Right hand uses blade of table knife to pluck one of the fork's inner prongs. Carry knife several feet away and hold blade over glass of water. At the instant blade is above the glass, left hand imperceptibly lowers fork handle so end of it touches top of table. Table picks up vibrations from prongs. An audible tone results. Due to misdirection, audience thinks tone comes from knife blade and glass. Before tone fades away, take knife from the glass, at same moment lifting fork handle to cut off tone. Similar effect can be obtained if left hand secretly contains empty wooden match box. Box will resonate when fork handle is brought against it.

Source:

Date:

2. Dinner table gag. While talking about your impeccable table manners, casually pick up fork and scratch head vigorously with the prongs.

## Balancing Feats

3. Place the prongs of two forks together, one set of prongs on top of other, and insert edge of half dollar between center prongs. The forks can be balanced on edge of glass as shown (Fig. 224).

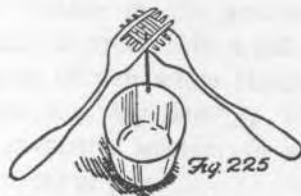

4. Push the prongs of one fork into the prongs of another, going above the two inner prongs and under the two outer ones. With a toothpick, they can be balanced on edge of glass (Fig. 225). Set fire to end of pick projecting inside the rim. It will burn until it reaches the glass, then go out, leaving pick precariously balanced on its extreme

tip. A spoon can be substituted for one of the forks. Instead of rim of glass, the toothpick can be balanced on the point of a second pick, inserted upright into top of a salt shaker. (Fig. 226).



Fig. 226

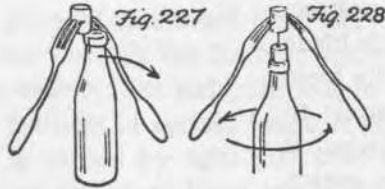

Fig. 227

Fig. 228



Fig. 229

5. Two forks are pushed into a large cork as shown in Fig. 227. Cork can be balanced on edge of bottle, and with care, contents of bottle can be emptied without dislodging cork. Bottle is tipped in direction indicated by arrow. If a needle is inserted into cork, it can be balanced on the head of a nail driven into another cork in the mouth of a bottle (Fig. 228). The forks can now be spun around the bottle.

6. With steady hands, it is possible to balance spoon on tip of table knife, and knife on the bowl of fork (Fig. 229). The spoon and fork are at right angles to each other. Handle of knife rests against hollow at base of fork's two center prongs.

#### FOUNTAIN PEN

1. Ask a friend to show you his fountain pen. Study it a moment, say "thanks," pretend to put it in inside coat pocket. Actually, drop it down sleeve, catching it in right fingers. When he protests, reach out and apparently extract pen from

#### COMMENTS AND ADDITIONS

Source:

Date:

behind his head. Or you can say, "It's a funny thing, but I have a pen exactly like yours." Reach into trouser or side coat pocket with right hand and appear to remove the pen. "Would you care to trade?" Hand him his pen.

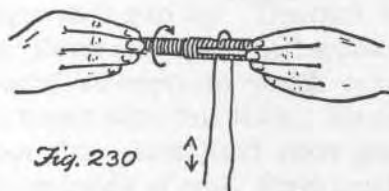

2. Spectator holds pen at opposite ends (Fig. 230) while you loop a string, about four feet long, around it. Slide loop under the clip as shown. Upper end of string, marked "A," must be a few inches shorter than other. Spectator rotates pen backward, winding string around it. Under cover of your hand, let short end pass once over the pen. Pull on both ends, while he holds pen loosely, permitting string to unroll. The loop will be found free of pen, and attached to clip only. Same moves can be repeated to put loop back on pen again. This is a variation, of course, of old garter trick.

3. Restaurant gag. Buy a cheap pen, fill it with milk. When coffee is served, take out pen, squirt milk into the cup. At bar, you can order soda, then squirt an alcoholic beverage into it.

4. Fountain pens can be used in various ways by mentalists to convey secret information to an assistant in another room. The pen is taken to assistant by a spectator, ostensibly to use for jotting down mental impressions. One method is to write the information in the pocket, on cigarette paper, which is rolled into a pill and secretly dropped into cap of pen while closing pen. See James Thompson Jr., "My Best", p. 197, for John Booth's code involving manner in which cap is placed on either end of pen.

5. Fountain pens with rounded ends can be used like the familiar wooden "snappers" sold in novelty stores. The pen appears to snap back into the cap (or the cap back on the pen, depending on which half you wish to operate) as though pulled by secret spring. Actually, tips of thumb and index finger shoot pen (or cap) as though it

## COMMENTS AND ADDITIONS

Source:

Date:



were a cherry seed. May be necessary to moisten fingertips to make it work smoothly.

6. Top of fountain pen can be used like a thumb tip for vanish of cigarette in hank, etc.

7. Seated at table, you drop fountain pen in envelope, then tear envelope into pieces. Pen has vanished. There is a slit at bottom corner of envelope through which pen falls as it is lapped. (Jerry Andrus)

## FUNNEL

1. Betchas. With end of funnel in mouth, you can't blow out match held at the large opening. Head tilted back, you can't blow a ping pong ball out of funnel. A dime dropped into funnel can't be blown out of funnel unless you put your finger over the lower end, then it blows out easily.

2. Ancient practical joke. Put funnel under belt, dime on forehead, then show how easy it is to lower head so dime falls into funnel. When victim tries it, and his head is tilted back so he can't see what's happening, pour water into the funnel. An old burlesque routine is based on this prank. To everyone's surprise, victim wins bet and his pants do not become soaked. He then produces a hot water bottle he had concealed in trousers and into which end of funnel was placed.

## GLASSES

1. Vanish of glass wrapped in paper. One of the classics of impromptu magic. May be performed when seated, or standing by table. Glass is first wrapped in paper, usually a single sheet of newspaper. A good method of wrapping is to fold paper as in Fig. 231, then wrap glass by rolling it in direction indicated. Tear away excess paper. Twist remaining paper above glass to form paper shell. (Fig. 232).

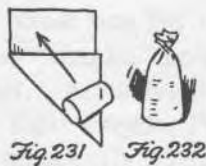

Fig. 231

Fig. 232

## COMMENTS AND ADDITIONS

Source:

Date:





If seated, simplest presentation is to place inverted glass over a coin. Announce you will cause coin to vanish. Wave hand over glass, then lift glass, bringing it back to edge of table. Attention is centered on coin while you permit glass to drop from paper shell into lap. The trick has apparently failed. Cover coin again. After one or two more unsuccessful attempts to vanish coin, state that you are bored with this trick. Smash paper flat with your fist. Left hand takes glass from lap, brings it up inside of coat. Right hand opens coat, and left pretends to remove glass from inside coat pocket. To strengthen the misdirection provided by coin, you can place match folder over coin so spectator has to lift folder to see if coin has vanished.

Dai Vernon, in his "Select Secrets", suggests having duplicate coin on one knee. Tell spectator you are able to reach beneath table and cause coin under the glass to turn over. Ask him to call heads or tails. If he calls correctly, reach under table and pretend you are turning coin to what he named. Lift glass to show coin, bringing it to edge of table and letting glass slide to lap. If he calls incorrectly, follow same procedure, remarking, "See - I can beat you every time!"

Place coin beneath what is now an empty shell, without letting spectator see which side is up. Have him call heads or tails again. If coin is not properly set for repeating what you did before, lift shell and state that table top is too thick, but you will try once more. After a few such attempts, whether you succeed or not, terminate trick by smashing the shell flat. Left hand now picks up coin from knee, drops it with a clink into glass on lap, then pretends to take glass from beneath table. Bring it out, says Vernon, with the coin jingling. As left hand sets glass on table, right hand sweeps the flattened paper backward, sending original coin to lap.

Instead of smashing paper with his fist, Bert Allerton cups his hands over the shell, asks spectator (preferably a woman), to place her hands on top of his. For the vanish, he suddenly removes his hands, puts them on top of hers, and pushes

## COMMENTS AND ADDITIONS

Source:

Date:

down. In this way, she herself smashes the shell, making effect much stronger.

Some performers prefer to have glass right-side-up inside paper shell, instead of inverted. Bob Reinhart holds glass near edge of table, raps coin against bottom of glass. As left hand places coin forward on table, right hand, without altering position, allows glass to drop to lap. Thus the steal occurs before trick begins. (See Bruce Elliott's description, in "Sphinx", Winter, 1952, for additional details). Instead of producing glass from coat, some magicians prefer to let glass slide down the extended legs and drop on floor just as paper is smashed. If glass is plastic, it can be dropped on floor from between the knees.

To present this effect standing, a stronger misdirection is needed. Doc Zola's handling is as follows. A crumpled dollar bill is carried, along with change, in left pocket. Left hand takes change from pocket. Right hand picks up one coin. Left returns change to pocket, comes out with crumpled bill fingerpalmed.

Place glass and shell over coin. Have a spectator stand at your left. Direct him to place one hand firmly on glass, while your left hand (with palmed bill) rests on his back. Command coin to vanish. Raise glass with right hand. Coin still there. Transfer glass to left hand, loading bill inside. Right picks up coin as left places glass (with bill beneath) on table. Vanish coin any way you wish.

Right hand raises glass, revealing bill, and transfers glass to left hand. Middle finger of left hand goes inside glass, the other fingers going outside of shell, on side facing you. Right hand places bill to one side, then picks up shell to replace on table. The left fingers, however, retain the glass, as right hand takes away only the empty paper shell. Left hand, still clipping glass with fingers, immediately goes behind spectator's back where it rests flat against his coat (Fig. 233). An alternative concealment is to grip inside edge of table with left hand, thumb on top of table. The fingers keep glass out of sight beneath table top.



## COMMENTS AND ADDITIONS

Source:

Date:

The glass can also be concealed by letting left arm hang normally at side, fingers curling around edge of coat so that glass is between the coat and body.

Ask spectator to place hand on shell again. As he does so, your right hand pushes his hand downward, flattening shell. Open his coat with right hand. At same time, reach inside his coat with left, and pretend to extract glass.

Other objects can be used, of course, instead of crumpled bill. A collapsible rubber lemon is effective.

Christopher's page in HMM, May, 1952, p. 931, describes the first printed version of this effect, in "Hocus Pocus Junior". Cupped hands cover glass, and no paper is used. Christopher also gives his own presentation, using shell penny and dime, as well as John Hilliard's use of prepared newspaper sheet. The sheet enabled him apparently to rap the glass with a knife, after steal has been made. Leipzig's handling will be found in "Dai Vernon's Tribute to Nate Leipzig", p. 143.

2. Production of glass under hat. Half-filled glass rests on chair between your legs, or is clipped between thighs. Coin on table is covered with playing card, then a felt hat placed over both. State you will make coin vanish. Grasp crown of hat with right hand. Lift hat, carrying it back to edge of table. Ask someone to raise the card. As attention is focused on card, left hand pushes glass up into hat where it is held through the brim by right fingers. Replace hat (and glass) on table. Vanish coin any way you please. State that coin will appear under hat. Spectator lifts hat, finds glass of water. Like previous trick, this also has endless variations. See George de Lawrence's "Impromptu Magic", p. 20, for method of presenting the effect while standing, the glass carried beneath vest.

3. Toss vanish. You must be seated at table. Place half-filled glass to lips, take sip of liquid, then lower hand to edge of table. Smack lips to get attention on face, at same time letting glass drop from right fingers to lap where it is clipped by the legs. Right hand now pretends to toss glass into the air. Look upward to give impression glass vanishes in mid-air. Left hand secures glass as you stand to

## COMMENTS AND ADDITIONS

Source:

Date:



prove nothing is on lap. Hand carries glass up inside of coat to produce glass from inside coat pocket.

4. Magician seems to push a wand or table knife through bottom of glass. Several different handlings have been published. A good method is to hold glass as in Fig. 234-A. Knife is actually behind glass, but as right hand moves it up and down,

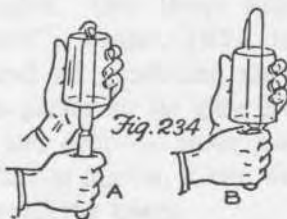

it sounds as if end of knife is hitting bottom of glass. This is done by jabbing rounded end of knife against base of index finger, at same time striking knife against glass. Gives strong illusion of knife being inside, and hitting tumbler's bottom. On final jab, raise index finger and push knife up into view, apparently having penetrated the glass (Fig. 234-B). Immediately withdraw knife, giving audience only a quick flash of the penetration.

5. Magician appears to measure the depth of a glass, using wand or knife blade, and finds it about two inches longer inside than outside! Fig. 235 shows how inside is measured. Thumb must be stretched upward from fist as far as possible. As knife is withdrawn, thumb slides downward about two inches along blade. Outside of glass is now measured (Fig. 236). Difference in thumb position relative to rest of hand is never noticed. The sliding of thumb can be done slowly, as hand slowly withdraws knife and applies it to outside of tumbler.

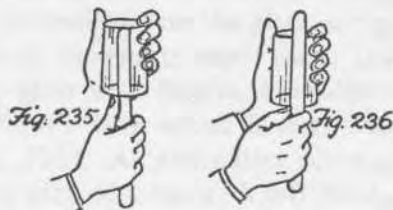

6. Cups and Balls. Literature dealing with this classic is voluminous. The trick is mentioned here because it can be presented impromptu by using opaque plastic tumblers, or glasses wrapped with

## COMMENTS AND ADDITIONS

Source:

Date:



newspaper in a manner such as suggested in No. 1 above. For balls, crumpled pieces of paper or dollar bills are used. See Dai Vernon's "Impromptu Cups and Balls", Stars of Magic Series, for excellent routine using paper-wrapped glasses.



7. Ghost glass. Tie one end of string around glass of water, and other to a pencil (Fig. 237). Everyone is quiet. By turning pencil imperceptibly in the hand, cord around pencil will slip slightly, producing audible spirit raps. Glass serves merely to provide weight, misdirection, and mysterious appearance.

8. Hold an unbreakable plastic tumbler upright in left hand, first finger and thumb gripping it at extreme edge of brim. Right hand drops second tumbler into it from above. If first tumbler is held loosely, force of second tumbler, as the two nest, will cause first tumbler to drop to table, while second tumbler remains in left hand. Gives illusion of one tumbler penetrating other. With practice, can be done with glass tumblers, the right hand catching bottom glass while it is falling. Old fashioned glasses are ideal for this.

9. Vanish of any small object. Glass is held in left hand. Drop object inside, and while covering glass with handkerchief, secretly invert tumbler so it rests upside down on left palm. Shake left hand, causing object to rattle against sides of glass. Right hand takes tumbler through the cloth, places it on table, the object remaining palmed in left hand. Later, when glass is shown empty, it must be turned right side up as handkerchief is removed.

9a. The secret inversion of glass as explained above can be used for a silk penetration effect. Put red silk in glass, cover with hank, secretly inverting glass as you do so. Elastic band goes around what appears to be top of glass. Reach beneath and apparently pull red silk through bottom of glass. Tan

## COMMENTS AND ADDITIONS

Source:

Date:



Hock Chuan's more elaborate version, in which two silks are placed in glass and the lower one is apparently pulled through the bottom, is explained in "Tarbell", Vol. 6, p. 129. (It requires a small piece of thread attached to corner of one silk.)

### Stunts

10. Magician pretends to bite edge of glass. Loud cracking sound is heard. This is produced by a half dollar concealed in the fingers as shown in Fig. 238.



Top edge of coin is clipped between first and second fingers. Press middle finger against coin, then let edge slip off first finger so coin raps against glass. Immediately lower glass and pretend to adjust front teeth with free hand. If you have previously obtained a piece of ice in your mouth, start chewing it audibly as though it were glass.

11. If rim of glass is moistened, and tip of finger moved around it, a loud, clear musical note can be produced. Pitch varies with amount of water in glass. Successful stage acts have been built around a xylophone made up of many glasses played in this manner. The principle was also the basis of a musical instrument called the "armonica," invented by Benjamin Franklin.

12. Moisten rim of glass. Place paper napkin on top, tear off outside of napkin to leave a disk of paper covering tumbler's opening. With burning end of cigarette, one can burn letters, designs, etc. in the paper. An unusual game is played by placing a penny in center of paper. Players take turns touching tip of cigarette to paper, each time forming a small hole. Person who causes penny to fall into glass is the loser. For a practical joke, play game once, then use flash paper, instead of napkin for the next game. The victim of course, goes first.

13. Cure for hiccups. Drink glass of water by placing mouth over rim at point opposite that from which you normally drink. Head must bend forward and down to drain glass.

### COMMENTS AND ADDITIONS

Source:

Date:



14. If glass is filled to top, a surprising number of pennies can be slipped into glass without water overflowing. Surface becomes convex, but cohesion prevents overflow. If common pins are used, instead of pennies, it takes hundreds to make water spill over. Brim of glass should be dry. An enormous amount of cotton will also go into full glass of water.

15. When glass of water is placed on top of half dollar, and glass covered with a saucer, coin seems to vanish. Due to refraction of light, coin is invisible from every angle.

16. Pick up glass as in Fig. 239, with burning match in fingers. Blow against glass as shown. Flame will go out, as though you blew through the glass.



Fig. 239



Fig. 240

17. Tumbler half-filled with water is covered with sheet of paper, then turned upside down on hand. If hand is removed, paper remains suspended (Fig. 240). Weight of water is countered by outside air pressure, which is much greater than air pressure inside glass.

17a. If hank is substituted for paper in above trick, the cloth will also be held in place by air pressure, the center of hank bulging upward into glass. If cloth is stretched, air is forced through fibers of cloth and bubbles up into glass giving the appearance of boiling water. Hold inverted glass in left hand so thumb in back can secretly slide the cloth upward to create the boiling effect. Right hand holds a burning match below inverted glass. The effect is that match flame causes water in glass to boil.

18. Moisten brim of glass and turn it upside down on a hard surface set at an incline (Fig. 241). If flame of match or candle is brought near glass as shown, glass begins to slide down incline. Remove flame, and tumbler stops moving. The heat ex-

## COMMENTS AND ADDITIONS

Source:

Date:



Fig. 241

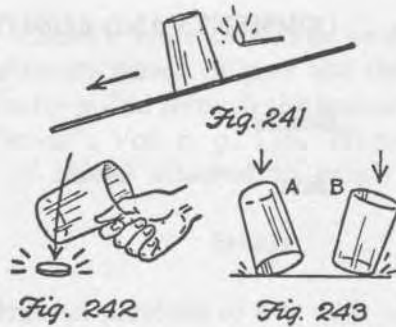

pands air inside glass, lifting it slightly. This reduces friction on brim, permitting glass to slide.

19. Hold a thick glass loosely, as in Fig. 242. If a half dollar is pounded vigorously with lower edge of glass, it makes a loud racket, but glass will not break. State that this is a test for counterfeit money. Pound coin a few times. Put glass aside and pick up coin, remarking, "And if the coin doesn't break, you know it's good."

20. If a heavy, cheap glass is dropped on a hard floor so it lights in either of the positions shown in Fig. 243, it is not likely to break. With practice, an upright tumbler can be pushed off edge of table so it lands in position A and does not break. Johnny Paul, in his magic bar near Chicago, likes to auction off an "unbreakable" glass. He asks for bid of \$1.00, and as no one responds, he keeps lowering price. While this goes on, he continually drops glass on the hard floor behind the bar, letting it fall as in B, to prove its unbreakable quality. When price is down to ten cents, and still no bidders, Johnny exclaims "To heck with it!" and throws glass on floor so it hits on the side, smashing into bits.

21. Pouring air upward. See Fig. 244. One hand holds inverted glass A beneath water. Other hand plunges inverted glass B below surface, trapping air inside. If B is tilted as shown, air bubbles emerge from B and "pour" upward into A.



## COMMENTS AND ADDITIONS

Source:

Date:

Balance glass of water on back of each, without explaining what you intend to do. This leaves him trapped – unable to move without spilling water. Best way to escape is to place chin against top of one glass to steady it while the hand removes other glass.

30. One wine glass is placed in another (Fig. 246). If upper glass is filled from bottle, and you continue to pour, the wine flows over edge, then down sides and stem to fill lower glass. This stunt provided a symbolic scene in Hedy Lamar's famous film, "Ectasy".



Fig. 246

31. Two short glasses are placed brim to brim (Fig. 247), with playing or visiting card between. Upper glass contains water, lower glass whisky. If card is pulled out, the whisky and water rapidly change places, due to greater specific gravity of water. Favorite bar stunt of Max Malini.



Fig. 247

#### Puzzles and Betchas

32. Two glasses are placed brim to brim (Fig. 248), the lower filled with water. Problem: take drink of water without touching either glass with the hands. Upper glass is removed, by grasping it between the chin and neck, and set on table. Place mouth to rim of other glass, tip it toward you until you can sip the water.



Fig. 248



Fig. 249

33. Two glasses are placed brim to brim as above, except both glasses are filled (this is done by dunking the glasses beneath water, placing them together, and lifting out.) Lower glass rests in a bowl. Problem: put dime inside the glasses without touching them. Tap glasses gently with dime until tiny crack appears somewhere between the brims. Surface tension prevents water from flowing out. Dime is slipped through crack.

34. Same set-up as above. Problem: remove water from upper glass without touching glasses. Using a piece of soda straw, blow at spot where brims touch. Experiment until you find spot where

#### COMMENTS AND ADDITIONS

Source:

Date:



brims are not quite touching. Air will bubble up into upper glass, forcing water out between the brims.

35. Problem: pour contents of one glass into an empty one and leave less than before. Dash the water vigorously into empty glass, so that some slops out.

36. Place piece of cardboard (in a restaurant, menu can be used) over glass of water, invert it on hard surface table, then pull out cardboard, leaving glass upside down. Problem: right the glass without spilling water over table. Slide glass along table until it projects slightly over edge, permitting water to drain into second glass held below.

37. Two small glasses are brim to brim as No. 32 (Fig. 248) Problem: drink the water from upper glass without touching it with the hands. Grasp upper glass in mouth, tip back head until glass is upright, then pour water from other glass into it. Bring empty glass close to mouth and carefully slide the full glass into it, so the glasses nest. Drink water from the inner glass.

38. Invert an empty glass. Place a small object (coin sugar cube, etc.) on it. Challenge someone to "lift it from the top of the tumbler," in three seconds, by means of two matches which you give him. After he has apparently succeeded, point out that he lifted object from "bottom" of tumbler.

39. Place sheet of paper over brim of empty glass, with small object resting in center of paper. Problem: get object into glass without touching paper. Set fire to paper.

40. To lift six glasses with one hand, arrange them as in Fig. 249. Fingers and thumb go in the five outside glasses.

41. Empty glass is upside down on table. To put object beneath glass, without touching glass, hold object under the table.

42. Problem: pick up inverted glass with thumb and forefinger as shown (Fig. 250). Tip glass toward you and lift. Some can do it, some can't.

## COMMENTS AND ADDITIONS

Source:

Date:



Fig. 250





Fig. 250

Fig. 251

## COMMENTS AND ADDITIONS

Source:

Date:

43. Problem: pick up filled glass of water by grasping base, scissor fashion, with first and second fingers. Secret: turn hand palm up.

44. Announce you can drink a ten-cent drink and leave enough in glass to fill five more glasses. Half dollar is concealed in mouth. After drinking, let coin slide into glass.

45. Bet ten cents you can drink a friend's fifty-cent cocktail without touching glass with lips or using straw. Pick up glass, drink it, say "I lose," and pay him ten cents.

46. Problem: arrange four glasses so their tops are an equal distance from one another, and likewise their bottoms. Fig. 251 shows solution.

47. Three empty glasses are placed in row, center glass upright and two end ones inverted (Fig. 252)

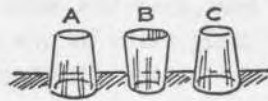

Fig. 252

Problem: by turning glasses two at a time (one with each hand), have all glasses upright in exactly three moves. Although you demonstrate again and again, spectators are unable to duplicate, usually ending with all three glasses inverted. You can demonstrate in many different ways (e.g. turn A and B, then A and C, then A and B again). Vary your demonstrations each time, if you wish, to confuse spectators. By crossing arms as you make some of the turns additional confusion is added.

After each demonstration, arrange glasses for spectator to try, but arrange them with center glass inverted and two end glasses upright. Few spectators notice difference in set-up. Following your demonstrations will turn all glasses upside down at finish. In fact, you can safely offer spectator fifty dollars if he can solve puzzle in 100 moves, as solution is impossible in any number

of turns. As spectator tries to solve it, he may occasionally set glasses correctly for himself, in which case you step in quickly with another "demonstration". An amusing way to finish, if spectator hasn't caught on after ten or fifteen minutes, is to demonstrate solution in one move (by turning A and C), then letting him try it with the false set-up.

For a simple sleight that enables you to demonstrate a solution even when glasses are placed the wrong way, see my description in "Ibidem", No. 18, (Oct., 1959). If someone tries the trick on you, feign ignorance and solve it no matter how he sets the glasses!



Fig. 253

48. Six glasses are arranged as in Fig. 253, three filled and three empty. By picking up glasses in pairs and shifting the position, arrange glasses alternately full and empty, in three moves. Solution: 1 and 2 to extreme right, 6 and 1 to extreme right, then 3 and 4 into open space.

49. Same set-up as above. Problem: move one glass to produce the alternate arrangement. Pick up 2 and pour contents into 5.

50. Place hat over glass of water. Go beneath table and make sounds of drinking. Emerge and bet that when hat is lifted, there will be "no more water." After hat is removed, point out that there is "no more water" than had been there previously.

51. Same set-up as above. Bet that you can drink the water without lifting hat. Go beneath table as before. After spectator lifts hat to see, pick up glass and drink. You didn't lift hat, he did!

52. A switch on above. If you are a spectator when someone else pulls the stunt, quickly lift hat and replace glass of water with empty glass while performer is still beneath table. Later, when you lift hat, you and other onlookers express vast astonishment at success of the feat - to the surprise and confusion of performer.

## COMMENTS AND ADDITIONS

Source:

Date:

53. A shallow dish is filled with water. A penny is dropped into the water, near edge of dish. Problem: to pick up penny without wetting the fingers, moving plate, or removing water from dish. Set fire to piece of cuppled paper. Drop it into tumbler. Quickly invert tumbler and place it upside down in center of dish. The vacuum created will draw the water into tumbler, leaving edge of plate dry.

53a. Empty glass is set on top of filled glass upright. Problem: drink contents of bottom glass without using hands and without lowering upper glass. Drop burning match in top glass and let it burn until it goes out. This heats air in glass. Place your cheek over brim of glass. As air cools, suction is created and glass sticks to cheek. Bend over, pick up lower glass between lips, drink contents.

53b. Lean empty glass toward you by resting it against edge of an object. Inverted smaller glass goes inside larger one. Problem: remove small glass without touching it. Blow. Smaller glass will be tossed back into your hands or lap.

#### Balancing and Juggling

54. Turn hand palm up and grasp glass of water. The hand can be swung in a large full circle, vertically, without spilling water. (Fig. 254.)

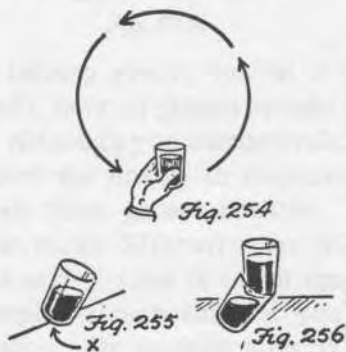

55. Half-filled glass can be balanced as shown (Fig. 255) by secretly having a match beneath table cloth at point marked "X". If done near edge of table, you can knock match to lap or floor as you remove glass. With care, a second glass can be balanced on top of first (Fig. 256).

56. Glass can be balanced as above, on the head of a buffalo nickel. Edge of glass rests between Indian's nose and rim of coin.

#### COMMENTS AND ADDITIONS

Source:

Date:

57. Glass is balanced on edge of plate (Fig. 257). It is secretly supported behind plate by tip of right thumb.

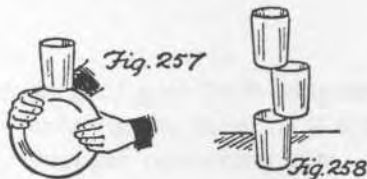

58. Towers of glasses can be formed in manner of Fig. 258. More complicated towers can be formed with wine glasses, the type of structure depending on shapes of the glasses and ways in which they can be balanced and interlocked.

59. Six glasses, each half filled, are formed into a pyramid (Fig. 259) at edge of table. The pyramid rests on one end of cloth napkin, and two other napkins are between the glasses as shown. Napkins must have at least one hemless edge, placed as indicated. One at a time, beginning at the top, each napkin is removed by a quick horizontal jerk.



60. Performer says, "To your health," and clinks his wine glass against edge of friend's glass, which is resting on table. The clink apparently upsets

friend's glass, but performer's glass catches it as shown (Fig. 260). If friend's glass is only partly filled, the feat can be executed without spilling a drop.

61. Two tapering rimless glasses are placed with sides together in manner of Fig. 261. If thumb and fingers squeeze the sides, they can be made to spin forward without separating. The glasses will travel several feet before they come to rest, still upright and together.

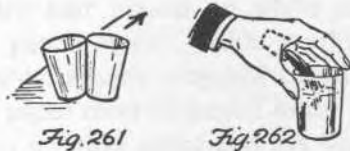

## COMMENTS AND ADDITIONS

Source:

Date:

62. Bartender stunt. Shot glass is gripped at crotch of thumb. Glass of soda is picked up by brim and placed in front of customer. Then, still holding brim, the hand tips forward to pour contents from shot glass into the soda. (Fig. 262).

### GLOVES

1. Right hand goes into glove with one finger bent down over palm. Left hand wiggles empty glove finger back and forth. Pretend to look about for missing finger. Pull off glove, count fingers, and register great relief.

2. Hands are extended forward, each wearing a heavy glove or mitten. Both hands are apparently palm down. Left fingers bend down as shown (Fig. 263), but right fingers bend up! Right hand has been inserted reversed into glove, so actually it is palm up.



### GRAPE

1. One grape is secretly concealed in mouth. Show second grape. Pretend to drop it into left hand, secretly retaining it in right. Left hand slaps top of head. At same time, mouth opens and second grape drops out. It is caught by left hand. Believe it or not, one of the most effective quickies in impromptu magic.

2. Bill Simon has a more elaborate version of above. Instead of letting grape fall from mouth, it is merely exposed at lips. Right hand appears to take it from mouth. Actually, grape is brought back into mouth and the palmed grape in right hand is shown. Trick is immediately repeated.

### GRASS

1. A blade of grass, held between thumbs, acts like

### COMMENTS AND ADDITIONS

Source:

Date:



a reed to produce musical note when you blow between thumbs.

2. Hum grass. Pick a stem of grass with any sort of foliage or tassel at end. Clench stem between teeth, vibrate the grass with finger, say "What a beautiful hum!" When victim tries it, pull the stem to one side so his teeth scrape the foliage into his mouth.

## GUM

1. Remove stick of gum from wrapper, carefully folding and replacing the paper so it appears to be an ordinary wrapper containing gum. Left hand holds full package of gum with fake wrapper beneath it, but flush with sides, so not noticeable. Pull out a stick of gum and offer it to spectator with left hand. Take stick from him with right hand. Right hand casually picks up package from left, leaving prepared wrapper in left, while right hand places package and the stick of gum in coat pocket. Hold up empty wrapper, wave hand over it, then tear it to bits. Immediately begin chewing on piece of gum previously held in side of mouth.

2. Bert Allerton gag. Ask someone to hand you a newspaper. Open it, remove a large double sheet. Take gum from mouth, stick it in center of sheet, crumple up the newspaper into large ball. Toss in wastebasket as though this were your usual method for disposing of gum.

## HAIR

1. A tight knot is tied in a piece of human hair. Problem: untie it. Moisten upper crease of palm, at spot below pinkie. Place hair so that knot goes into moistened part of crease. Close hand into fist. Pound fist on other palm. If pounding is continued a while, the knot will open enough to permit you to pass one end of hair through it, thus untying it.

2. Francis Rigney discovered that two or three pieces of dark hair placed on white paper, look exactly like pencil lines. While working over a drawing board, Rigney enjoyed placing several hairs on the paper next to pencil lines. He would then call over a fellow artist and ask him the best

## COMMENTS AND ADDITIONS

Source:

Date:



way to remove the lines. When told to erase them, Rigney would say he preferred to do it another way — then he would either blow away the hairs, or carefully pick them off the paper.

The drafting board, of course, must be flat otherwise hairs might roll off.

3. A fine needle is inserted just below the skin, through the flesh at base of middle finger of left hand (Fig. 264A) to form two small holes. A long piece of horse hair is pushed through the holes so a tiny portion of hair projects as in Fig. 264B. The hair emerges from other hole, goes between the fingers, then under the hand and into the sleeve (Fig. 264B). This fact is concealed by the tip of right forefinger which is placed on left palm as shown. Show hand in this fashion to a friend, asking him to remove the "splinter" which seems to be projecting. When he pulls on it, it proves to be a foot long!

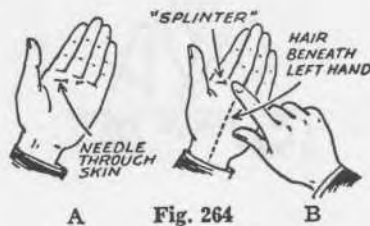

A Fig. 264 B

## HANDS

No previous comprehensive attempt has been made to bring together the many tricks and stunts which involve nothing more than a pair of hands. Only one branch of this field has an adequate literature — the branch usually called "finger play". It deals with simple finger movements which illustrate a story or rhyme for pre-school children. For some reason, European countries have a wide variety of finger rhymes in their folklore; particularly Germany, Austria and Switzerland. The rhymes are less common in England and France, and extremely rare in the United States. "This is the church, this is the steeple, open the door and see all the people," and "This little pig went to market, etc.," are the only two which are universally known in America, and the latter is usually done with the child's toes.

Curiously, most of the European finger rhymes

## COMMENTS AND ADDITIONS

Source:

Date:

deal with eating episodes, often with the pinkie taking the role of a "tattle tale" finger which tells on the others (see "Finger Rhymes" by Sam M. Shiver, "Southern Folklore Quarterly", Dec., 1941.)

Froebel the German educator and inventor of the kindergarten, placed a great stress on finger play. His stunts are described in Emilie Poulsson's "Finger Play for Nursery and Kindergarten", 1893, and Susan Blow's "Mottoe and Commentaries of Friedrich Froebel's Mother Play", 1903.

Other works in English which cover the field include Florence G. Sumner's "Let's Play with Fingers", 1938, and Frances E. Jacobs "Finger Plays and Action Rhymes", 1941. Collections may also be found in "The Bookshelf for Boys and Girls", 1948, Vol. 1; "Recreation for Girls", by Beard and Beard, 1908; E. O. Harbins "Fun Encyclopedia", 1940, and similar works. Interesting historical material on some British finger rhymes is in the "Oxford Dictionary of Mother Goose Rhymes", 1951.

No book collection of hand tricks and stunts for older children and adults has yet been made, although short sections on the topic may be found in Thurston's "Two Hundred More Tricks You Can Do", 1927, and A. Frederick Collins' "Mirth and Mystery", 1931.

The related field of shadowgraphy, in which the fingers are used for forming shadow pictures on a wall, has been treated in a number of books —

Harry Bursill. "Hand Shadows". London, 1859. Dover reprint, 1967.

Anonymous. "Ombromanie: First Series". "Ombromanie: Second Series". Paris, 1860.

Anonymous. "Lustige Schattentheater. Muhlhausen.

Victor Bertrand. "Les Silhouettes Animees a la Main". Paris 1893.

Ellis Stanyon. "Hand Shadows". London, 1898.

Felicias Trewey. "Shadowgraphy". London, 1893.

Bernard Miller "Hand Shadows", in "The Strand Magazine", Vol. 14, 1897, pages 625-32. (Description of Devant's shadow act.)

## COMMENTS AND ADDITIONS

Source:

Date:



David Devant. "Hand Shadows". London, 1901.

A. Patterson. "Shadow Entertainments". London, 1896.

Imro Fox. "Shadowgraphs". New York.

Ortleb. "Die Schwartz Kunst". Muhleim.

Silhouette. "Modern Shadowgraphy". London.

Nikola. "Hand Shadows".

Max Holden. "Modern Hand Shadows", 1935.

Bill Severn. "The Story of Shadow Play", 1959: "You and Your Shadow".

Theodore Bamberg "Okito on Hand Shadows", 1959.

## COMMENTS AND ADDITIONS

Source:

Date:

### Finger Removals, Stretches, etc.

1. Removing thumb. The left hand should be held in front of you, back to the audience, fingers pointing to your right. Grasp the knuckle of the thumb between the tips of your right thumb and index finger, Fig. 1. The right hand wiggles the

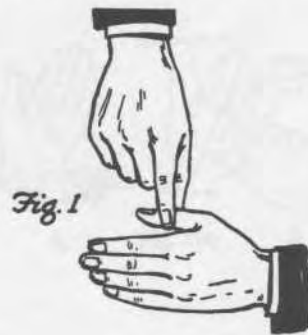

SPECTATOR'S VIEW



thumb vigorously as though trying to pull it off. Take the hand away, raise the left hand and inspect your thumb, making appropriate comments. Repeat the attempt once more. On the third try, the right fingers are placed over the thumb as shown in Fig. 2. Behind the fingers, the left thumb bends back and the right thumb is also bent and



## COMMENTS AND ADDITIONS



Source:

Date:

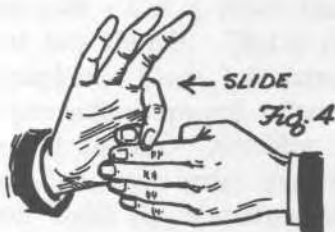

placed in position. Then the middle, ring and little fingers of the right hand are raised to expose what appears to be the left thumb, Fig. 3.

Slide the right thumb slowly along the top of the left index finger to the position of Fig. 4, then slowly back. As soon as the thumb knuckles touch, the hands make a sudden up and down motion. During this motion the position of the fingers of both hands do not change, but the right thumb is drawn back, the left thumb extended, and the knuckle of the left thumb grasped by the right index finger and thumb exactly as it appears in Fig. 3. This time, however, the visible thumb is the real thumb, not a composite one.

If the up and down motion is made quickly (the hands should not move more than six or eight inches) the shift of thumbs will be invisible. Take away the right hand, snap the thumb a few times with the middle finger to show it restored.

Paul Stadelman has been performing the trick in this manner for many years, except that he prefers to remove the tip of his index finger instead of the thumb. His switch at the finish is undetectable.

When Jarrow does the trick he first pretends to unscrew the thumb by putting his right fist around it and twisting. At first the thumb is tight and refuses to unscrew. After several unsuccessful attempts, Jarrow takes out his handkerchief, wraps it around his thumb so he can get a firmer grip.



This time a sudden jerk of the fist loosens the thumb. The handkerchief goes back into the pocket and the thumb is unscrewed by twisting the fist counter-clockwise around the thumb. Jarrow then performs the removal, after which he screws the thumb back tight again.

Bill Simon has a novel angle. Have a spectator pencil a cross on your left thumbnail for later identification. He doesn't know you have marked a similar cross on your right thumbnail. After the trick, while you extend your left thumb for examination, the right hand drops to the side and the fingers wipe the nail clean.

Al Wheatley obtains a novel effect by putting a thimble on the thumb to be removed, secretly having duplicate thimble on other thumb.

2. Gene Gordon's routine (shown to me by Charlie Miller). Use above move for pretending to remove tip of left middle finger. Pretend to put this tip in your pocket. With left middle finger still bent back, to simulate missing tip, remove your left thumb (in usual manner), then transfer tip of thumb to left middle finger, extending the finger as you do so. Now reach into pocket as though you are picking up the previously removed tip of middle finger and pretend to put it back on left thumb.

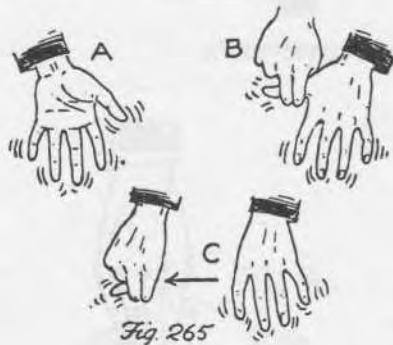

3. Wiggling thumb. First described by Kendell R. Jones, in "Sphinx", about twelve years ago. Left hand is held in front of thigh (Fig. 265-A). Wiggle all fingers and thumb. The hand is now turned so its back is to audience. At same time, right hand seems to grab thumb (Fig. 265-B.) Actually, left thumb is bent back behind hand, and right thumb projects between second and third fingers. Left fingers continue wiggling, and right thumb is also

## COMMENTS AND ADDITIONS

Source:

Date:



wiggled. Separate the hands (Fig. 265-C.) Continue wiggling finger and thumb. The fact that right thumb keeps on wiggling gives a strong illusion that it came from left hand. Keep hands apart only an instant, then pretend to replace thumb.

4. Joe Berg's amputated thumb. Let a carrot remain out of ice box for several days, until it becomes soft. Cut a piece from it to resemble shape of left thumb. This is concealed under a paper napkin. Close left hand into fist, with thumb projecting upward. Pretend to wrap napkin around thumb. Actually, thumb goes into fist, and left hand grips base of carrot thumb. Spectator holds tip of carrot through the napkin (Fig. 266) which feels exactly like thumb. Right hand proceeds to cut off tip of thumb with scissors, leaving tip in spectator's hands!



Fig. 266



Fig. 267

5. Removing little finger. The invention of Robert Nelson, of Chicago. Double the right hand into a fist, but with the little finger extended, and hold up the hand as in Fig. 1. Meanwhile the left hand works the little finger into position shown. This is done while the hand is at the side. It is necessary for the thumb and index finger to grasp the tip of the pinkie and pull it into this position where it is held in place by the firm pressure of all three fingers.

It is necessary to have fairly thin, flexible fingers in order to get the little finger twisted high enough into the hand. If you find it impossible to push the finger into such an awkward position, then this stunt is not for you. It is not necessary, however, for the finger to be twisted quite as far as shown.

## COMMENTS AND ADDITIONS

Source:

Date:

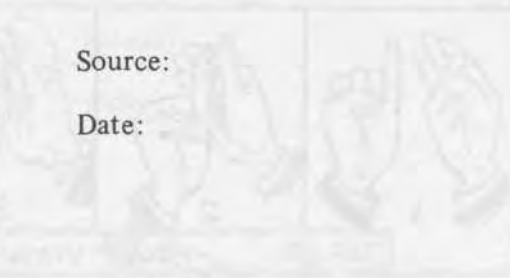



All this is required is that the finger be twisted far enough so the tip extends slightly above the middle fingers.

Assuming that you can get your left hand into a reasonable facsimile of Figure 1, bring the left hand up to the right and place the little finger flat against the right pinkie, exactly as shown in Fig. 2.

The left index finger now leaves its former position, bends toward you, and the tip is inserted into the crotch formed by the left thumb and little finger. Fig. 3 shows how this looks to you.

Bending the index finger reveals the tip of the left pinkie to the audience but it will be taken for the tip of your right little finger, which is immediately behind the left. Fig. 5 is the mirror view.

The right hand is now quickly lowered to your side. At the same time the left hand moves forward toward the spectator as you pretend to show him the detached finger. It is a good idea to tilt the hand forwards slightly to expose the finger better and to hide the lower part of the hand where the finger bends inward. Fig. 4 shows how the hand appears to you and Fig. 6 the mirror view. It is important that the left thumb be pressed against the little finger tip to convey the impression that the pinkie is gripped firmly by the thumb and fingers.

The effect is startling. It appears as if the fingers were lifted suddenly from the hand. The finger can now be replaced by a reversal of the moves.

The removal is so convincing that many will suspect a gimmick finger. I've had some fun suggesting this by casually going into my pocket with my left hand before starting, as though picking up something.

Then at the finish, pretend to take the gimmick into the right hand and vanish it with a flourish.

6. Removing middle finger. Fig. 267 shows how this appears. See Clayton Rawson's description, in which the stunt is part of a routine of several finger tricks, HMM, March 1950, p. 643.

7. Removing thumbnail. Give thumbnail a thin coating of melted candle wax, applying it with a brush. If this coating is peeled off, with aid of a pocket knife and appropriate grimaces, the effect can be made gruesomely realistic.



Fig. 268      Fig. 269      Fig. 270

8. Stretching index finger. Fig. 268 shows how it appears. See Thurston's "Four Hundred Tricks You Can Do". (Chapt. 9, No. 2) and Clayton Rawson's routine of finger tricks (HMM, March, 1950) for two methods of presentation.

9. Optical illusion stretch. Right index is extended and held against thigh, with left index curled over it (Fig. 269). If right hand is moved rapidly up and down, for a distance of an inch or so, it creates an optical illusion of an elongated finger (Fig. 270).

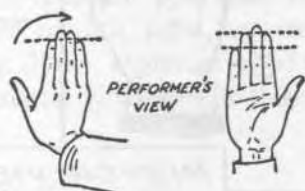

Fig. 271      Fig. 272

10. George Starke's index and pinkie trick. Hold right palm toward audience (Fig. 271), keeping arm almost horizontal, and twisting hand as far as possible in direction indicated by arrow. Call

## COMMENTS AND ADDITIONS

Source:

Date:



Fig. 267



attention to fact that first and fourth finger are of almost equal height. "But," you say, "on the other side of the hand, there's quite a difference." Turn back of hand to audience (Fig. 272), the arm vertical. In this position, the index finger will be over an inch taller than the pinkie! See HMM, March, 1950, p. 643, for Clayton Rawson's slightly different handling.

11. Compressing the little finger. From HMM, July, 1949. Hold up the right hand, palm facing you as in Fig. 1. The left thumb and index finger grasp the tip of the right little finger. The other fingers of the left hand are extended to hide all of the little finger except the tip, which projects above the hand. Fig. 3 shows how this looks when you stand in front of a mirror.

Relax the right little finger. The left hand moves down about an inch, sliding the tip of the little finger along the ring finger. This causes the little finger to bend, Fig. 2, but the bend is hidden by the left fingers. Fig. 4 shows how it looks in the mirror.

If you move the left hand up and down rapidly it will appear to the audience as if the little finger is being compressed and lengthened.

This was shown to me by Morris Fox. It makes a good prelude to No. 5 above. First you limber up the pinkie, then you remove it completely.

## COMMENTS AND ADDITIONS

Source:

Date:

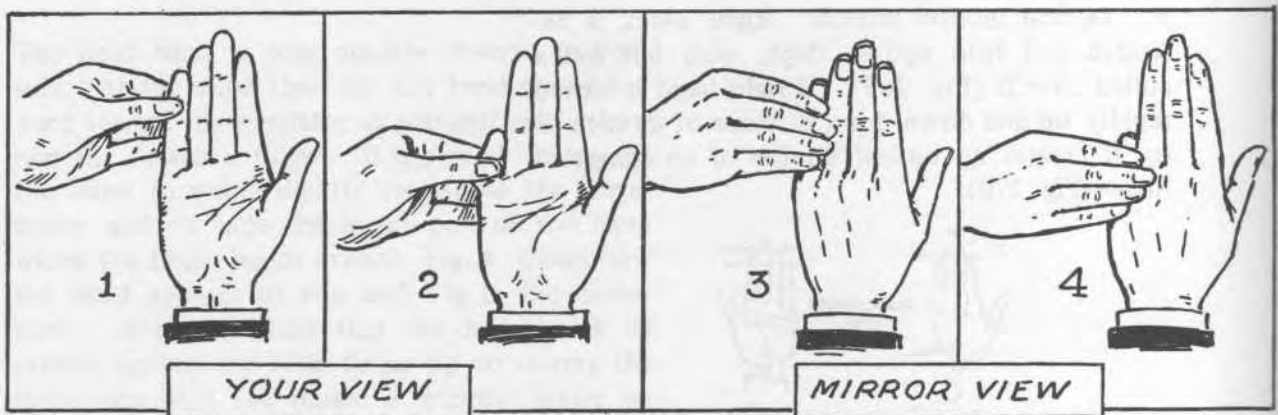



12. Stretching thumb. Begin as Fig. 273. What appears to be tip of left thumb, projecting from fist, is actually tip of right thumb. Seize this tip with your teeth, and pretend to stretch thumb by pulling it upward with the teeth. At same time, draw left thumb partially out of left fist (Fig. 274.) Reverse the move to push thumb back to normal. Before showing trick, bite tip of left thumb vigorously. After trick is over, you can show these bite marks to spectators to prove it was this thumb you were stretching! (Alan Barnert's presentation) See Thurston's "Four Hundred Tricks You Can Do", Chapt. 9, No. 5, for another presentation.



#### Miscellaneous Magic

13. Ghost tap. Place tips of each index finger on spectator's forehead. Gently brush them down over his eyes and cheeks. Repeat several times. Now ask him to close his eyes. As soon as he does so, place tips of left first and second fingers on his forehead (Fig. 275). Spectator thinks he is feeling the tips of your two first fingers. Brush the fingers downward until the tips press lightly against each eye. With your free right hand, reach around and tap him on the back of his head. Immediately bring right hand in front of his face, so when he opens his eyes he sees only your two extended index fingers, a few inches from his face. (George Starke's presentation.)

14. With a fountain pen (ball points are best), make a line on left palm, crossing the crease as shown (Fig. 276.) Under cover of turning over the hand, momentarily close the fingers, immediately



#### COMMENTS AND ADDITIONS

Source:

Date:

extending them again, so hand is flat and palm down. Make a small ink line on the back of hand. Remove it by moistening right fingers and rubbing it away. Turn left hand over. The mark appears to have imprinted itself on left palm, crossing the other mark (Fig. 277.) It is formed, of course, by the wet ink of first mark, when fingers were momentarily closed.

15. Spectator is given a small object to hold in either hand, while magician is out of room. He is told to raise the hand holding the object, for a specified length of time, or while he recites an appropriate rhyme or repeats a given phrase. He then lowers the hand, magician returns to room, studies spectator's two closed fists, and correctly guesses which hand contains the object. It will be slightly whiter than other hand, due to the fact that its blood vessels are less dilated. You can roll up a sheet of paper, pretend tube is x-ray device, as you study his hands.

16. Joe Berg's "double cross." Before showing, make two small crosses with soft chalk on first and second fingernails of left hand. Show palm to audience, then place hand beneath table. Under table, close hand into fist, making prints of the crosses on the palm, near base of thumb. With right hand, make similar chalk crosses on top of table, then rub them out. Bring out left hand and exhibit crosses on palm. (See "Tarbell Course", Vol. 3, p. 56.)

17. Bruce Elliott's "finger-finger." Magician turns back. Two spectators, whom we shall call Smith and Jones, play the game of finger-finger. On count of three, each extends either one, two, or no fingers of one hand. The total number of extended fingers is called out (by either spectator.) Magician immediately names the number of fingers extended by Jones. Repeated as often as desired. Secret: Smith is a stooge. His first play is agreed upon previously. Thereafter, he always repeats what Jones did on the immediately preceding play. Since magician always knows what Smith is playing, he has only to subtract Smith's play from each called out total to obtain Jones' play.

18. Fly away Jack! I know of no impromptu trick more entertaining for very young children. Two

## COMMENTS AND ADDITIONS

Source:

Date:



small pieces of paper are moistened with saliva and stuck to the nails of the two index fingers, or on each finger just below the nail (pieces should be moistened on both sides, to make them stick better.) Both hands are closed into fists, with the first fingers extending. The fingers may rest on the edge of a table, on each knee, or simply held in the air. Recite the following rhyme:

Two little birds,  
Sitting on a hill.  
One named Jack,  
The other named Jill.

Fly away Jack!  
Fly away Jill!  
Come back Jack!  
Come back Jill!

As you say "Fly away Jack!," raise one arm into the air, then return it to former position, only the middle finger is now extended instead of first finger. The thumb aids in keeping index finger bent out of sight by pulling it back into the fist. Small children never notice the exchange of fingers. The effect is that the paper has vanished. Repeat with other hand as you say, "Fly away Jill!"

Continue the rhyme. While you say the two "come back" lines, repeat the same maneuver with each hand, one at a time, switching fingers again so that the bits of paper miraculously reappear. Practice the exchange of fingers until you can do it rapidly. Be sure the angle at which fingers are extended is identical for both index and middle fingers, so as not to give the switch away.

After reciting the rhyme, you can continue trick by making both birds fly away at once. Bring one back, make him fly back and forth from one finger to the other, away again, then bring both back at once. A colorful variation is obtained by secretly affixing colored bits of paper to each middle finger before you begin. Instead of causing birds to fly away, you make them change color. By using pieces torn from the black part of a newspaper picture, together with white pieces, you can make "blackbirds" turn into white birds, etc.

This trick, perhaps the greatest of all impromptu

## COMMENTS AND ADDITIONS

Source:

Date:

tricks for children, is at least two centuries old. Oliver Goldsmith used to amuse children with it. Although the original English rhyme was about two blackbirds named Jack and Jill, there were later versions in which the birds sat on a wall, and were named Peter and Paul. See "The Oxford Dictionary of Mother Goose Rhymes", p. 147, for a brief history. The trick is described in "Hanky Panky", p. 13.

19. An interesting variation of the above is obtained by placing a piece of paper on right middle finger only. The first and second fingers are extended either touching each other, or opening in a "V" formation. It is best to rest them on the edge of table, or on left palm. Raise the hand quickly to your lips, to blow on the fingers, then return it to left palm. Under cover of this motion, which must be very rapid, the first finger is doubled back and third finger extended (Fig. 278.) Effect is that piece of paper was blown from one finger to other. Reverse the move to blow the paper back again.

A pretty transposition effect is obtained if you secretly stick a piece of black or colored paper to ring finger before starting. Keep this finger bent out of sight while you place a white piece on middle finger, and black piece on index. By making the move described above, the two pieces appear to change places!

20. Performer appears to slash left thumb with knife. Blood drips from thumb. But when it is wiped away, no trace of a wound can be found. Previous preparation: moisten top knuckle of left thumb with saliva. Using sterilized needle, prick the skin at half a dozen places along one of the creases. There will be no bleeding.

To perform: twist a handkerchief tightly around base of thumb, holding it in place by closing the fist around ends of the cloth. Pretend to cut thumb at the knuckle, without actually doing so. Bend thumb at knuckle, as tightly as you can. This causes blood to ooze from the tiny skin holes, and flow along the crease, making it appear like a deep gash. Let a few drops of blood drip from thumb to a plate, then remove the handkerchief and wipe knuckle clean. There will be no trace of a damaged skin. Some performers prefer to make

## COMMENTS AND ADDITIONS

Source:

Date:





the needle pricks at the base of the nail, instead of at knuckle.

20a. Another ghostly tap. Stand behind spectator, clapping your hands rhythmically so he knows your hands are not free. Raise hands and without breaking rhythm begin slapping one hand against side of face. This frees other hand for the mysterious tap on back of spectator's head.

20b. Still another ghost tap. Grab spectator's left forearm with both your hands. Your hands are touching, side by side, and your right thumb secretly extends under left hand where it presses against spectator's arm. Your right hand squeezes his arm, but left hand is held loosely, only your right thumb applying pressure. Spectator closes his eyes. You can remove left hand, but pressure of your right thumb makes it feel as if both hands are still gripping his arm firmly. With left hand make the mysterious tap on back of his head.

#### Sensory Illusions

21. Touch tips of index fingers as in Fig. 279. Bring them to within eight or ten inches of the eyes. Look past the fingers, focusing on opposite side of room. Separate tips slightly. A floating finger, with a nail at both ends (Fig. 280) will appear between the tips.



Fig. 279



Fig. 280

22. Hold a cardboard mailing tube (or rolled up sheet of paper) to right eye. Left hand is held against tube (Fig. 281.) Focus on opposite side of room, keeping both eyes open. You will seem to be looking through a hole in left hand. Slide left hand back and forth along tube until you get the "hole" in center of palm.



Fig. 281



Fig. 282

#### COMMENTS AND ADDITIONS

Source:

Date:



23. Aristotle's illusion – so called because it was first described by the Greek philosopher. Cross first and second fingers, then close eyes and feel a marble with the tips (Fig. 282.) It feels like two marbles. Two marbles feel like several. A similar illusion is obtained by running tips along a pencil. See William James' "Psychology", Vol. II, p. 86, for a discussion.

## COMMENTS AND ADDITIONS



Fig. 282

24. Ask someone to cross his arms (Fig. 283), clasp hands, then bring clasped hands to position of Fig. 284. If you point to any one of his fingers,

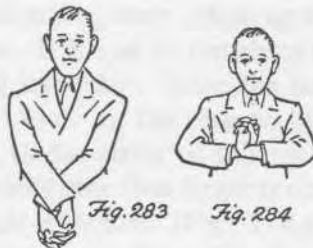

Fig. 283 Fig. 284

and ask him to wiggle it, he will have great difficulty finding the proper finger to wiggle.

25. The "dead" finger. With your right hand, clasp a person's left hand as shown (Fig. 285), the two index fingers upright and next to each other. Ask him to feel this double finger by running the finger and thumb of his right hand up and down it (his thumb runs along his own finger, and his index fingertip runs along your finger.) He will



Fig. 285

Fig. 286

find this produces an odd sensation, as though his left first finger were partially devoid of feeling.

26. Bite the tips of both pinkies for about half a minute. Now link the tips together (Fig. 286) and pull. A sensation like an electric shock will be felt in both fingers.

27. Have someone turn his back to you with arms extended as in Fig. 287. Grab his arms and bring them slowly backward (Fig. 288) until the backs of each hand touch. Rub the backs together. To

## COMMENTS AND ADDITIONS

Source:

Date:

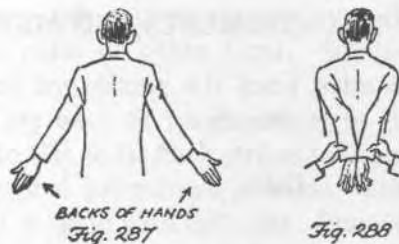

the spectator, the hands seem to touch while his arms feel as if they were still a foot or so apart. Many spectators are hard to convince that the backs of their hands really touched. (Francis Rigney)

27a. If palms are placed together, on opposite sides of a fence of chicken wire, and the hands moved about, remaining palm against palm, the sensation is most peculiar. In 1955 Steve Allen, on his "Tonight" show, actually had a framed section of chicken wire standing vertically on a table and asked various guests to try to describe what this felt like.

27b. There are three bowls, one with hot water, one with cold water, one with tepid water. Put left hand in hot water, right hand in cold water, for about a minute. Now feel the water in third bowl. It feels hot to one hand, cold to the other.

27c. Sawing spectator's finger. Hold tip of spectator's extended forefinger with your left hand, your left thumbnail touching the finger. With your right forefinger, pretend to "saw" off his finger, making the sawing motion alongside your left thumbnail. After sawing for a while, suddenly press nail of left thumb into flesh of his finger and watch him jump. It feels exactly as though your right index finger suddenly acquired a knife edge. (James Weaver)

## Sound Effects

28. By clasping hands, palm to palm, and squeezing, it is possible to produce the sound of a Bronx cheer. And need I remind anyone who was once a boy that similar sounds can be produced by a hand behind knee or under an armpit?

29. Hand whistling. There are several methods of placing the hands together (including the ordinary clasped hands, with fingers alternately interwoven), so that when you blow into them through a space between the thumbs, a musical tone, like the hoot-

ing of an owl, results. It is even possible to play tunes by raising and lowering a finger (for a description of one such method, see "The Strand Magazine", Dec., 1908, p. 737). An excellent imitation of a ship's whistle is obtained by blowing and humming at the same time. Wordsworth in "The Prelude, V, 364-374, recalls how as a child he stood beneath the stars:

And there, with fingers interwoven,  
both hands  
Pressed closely palm to palm,  
and to his mouth  
Uplifted, he, as through an  
instrument  
Blew mimic hootings to the  
silent owls  
That they might answer him.

Other methods of whistling, by placing one or more fingertips against the tongue, are too well known to require comment.

30. The sound of hand clapping can be produced by hands that remain clasped. Although the fingers are locked, the heels of the hands can be clapped rapidly without moving them more than an inch or so apart. Move the hands up and down to hide the clapping motion, and make the origin of the applause more mysterious.

31. Two, three, or even four fingers may be snapped off the thumb in rapid succession. Another unusual finger snap: press the tips of thumb and middle finger together, allowing first finger to remain very loose. If the hand is shaken vigorously up and down in the proper manner, the loose first finger will strike the middle finger with a loud snapping sound.

32. A small metal "cricket" of the type sold on toy counters of dime stores, which produces a loud snap when pressed, is concealed in one palm. Pretend to crack knuckles of other hand, actually producing the loud cracks by pressing secretly on concealed cricket. Gag can be introduced by saying, "Does it make you nervous if I crack my knuckles?"

33. Many unusual rhythms can be produced by snapping the fingers of both hands, and combining

## COMMENTS AND ADDITIONS

Source:

Date:

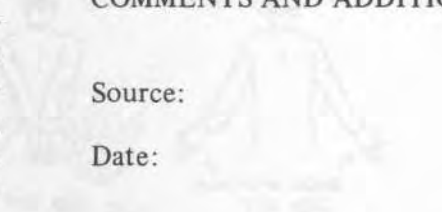

these sounds with sounds created by striking one fist against palm of other hand. Similar effects are obtained by placing left hand palm down on table, striking back of hand with right fist, rotating hand to left so its back strikes table, returning hand to original palm-down position, then hitting the back of it again with right fist. Francis Rigney recalls doing this as a small boy while reciting:

Go to bed Tom.  
Go to bed Tom.  
Get up in the morning,  
And give us a song.

Rigney also recalls using the same hand-flopping technique to produce the rhythm of "Shave and a haircut—six bits". The two sounds for "six bits" were made by placing his elbows, one after the other on the school desk, thus finishing in a position that would seem innocent to the teacher, if she looked his way.

34. There are several ways to fake the slapping of another person's face. One method is to stop your hand just as it reaches his face, while he makes the slapping sound by clapping his own hands. Your back should be to the spectators during this maneuver. Another method: as you start to slap, he raises his right hand in front of his face. Instead of slapping his face, you whack the palm of his hand. He immediately jerks his head back as though it were struck, covering his face with his right hand, as if in pain. This can be made to appear extremely realistic.

#### Strength Stunts

36. Place one hand on your head. It is impossible for even the strongest man to lift it from your head.

37. Place tips of your index fingers together. Challenge anyone to separate them by grasping each wrist and trying to force your hands apart. He must stand directly in front of you while making this attempt. It is impossible for him to succeed. A good method of insuring that he does not move to one side while trying to force your hands apart, is to have him stand behind you, grasping your wrists by reaching around your body and under each arm.

#### COMMENTS AND ADDITIONS

Source:

Date:



38. Ask someone to place one fist on top of the other. No matter how hard he tries to keep them together, you are able to separate them by striking them with the tips of your index fingers—knocking one fist to the left, other to the right. When you put your own fists together, however, he is unable to knock them apart. Secret: the upper fist secretly holds thumb of other hand.

39. Performer appears to rap his knuckles on edge of table with force enough to damage the skin. Done by quickly opening hand as it moves downward, so that fingers strike table edge, then hand is quickly closed into fist again.

#### Coordination Tests

Of the many hand stunts involving muscular coordination and dexterity, the following are best known:

40. Rub top of head with one hand, while other pats the stomach, or vice versa.



41. Each hand is moved in a large circle, but the two circles are made in opposite directions (Fig. 289), the paths crossing above and below. Francis Rigney says an easy way to learn this is to move the hands along perimeter of an imaginary square, instead of a circle. After one gets the feel, the path can be altered to a circular one. Also possible to twiddle thumbs in such manner that the thumbs rotate in opposite directions.

42. "Kneesy, earsy, nosey." So-called in the movie "The Devil's Brother" (a film of the twenties, starring Dennis King), in which Stan Laurel's attempt to teach this stunt to Oliver Hardy provided a running gag for the film. Begin with right hand holding nose, left hand holding right ear. Both hands let go, then slap the knees. Left hand now grabs nose and right hand grasps left ear. Keep repeating, as rapidly as possible.

#### COMMENTS AND ADDITIONS

Source:

Date:



43. Although this is probably as old as the Greeks, as far as I know it has no English name, or previous description in print. Begin as in Fig. 290-A. Separate thumb and finger at point X, then twist the fingers so that the same thumb and finger are able to touch again above, at point X in Fig. 290-B. Now separate the other thumb and finger, at point Y (Fig. 290-B), and twist them so they touch again at Y in Fig. 290-C. These motions are repeated

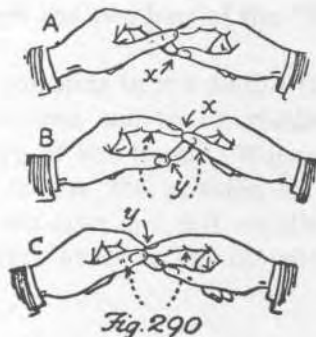

over and over as rapidly as possible.

An elaboration of this stunt brings all the other fingers into play. Start the motion with the thumbs and first fingers, as described, then substitute the middle fingers for the first fingers, without breaking the rhythm. The thumbs touch each middle finger only once, then they continue with the ring finger, then the pinkies, then back to the ring fingers, middle fingers, and finally back to the first fingers. The second, third, and fourth fingers are touched only once by the thumbs as the thumbs move to the pinkies, then once again as the thumbs travel back to the index fingers. The entire operation takes place very quickly.

Another elaboration, though more difficult, is to do this simultaneously with two pairs of fingers: the first and second fingers make the move while the third and fourth do likewise.

44. Up the ladder. Start as in Fig. 291-A. The right hand goes "up the ladder" as shown in B, C, D, and E, while the left hand remains fixed. Now the left hand goes "up the ladder" with identical motions, while right hand remains fixed. In this manner, the hands alternately move upward, until both hands are as high as you can reach. When done rapidly, the effect is amusing.

## COMMENTS AND ADDITIONS

Source:

Date:



COMMENTS AND ADDITIONS

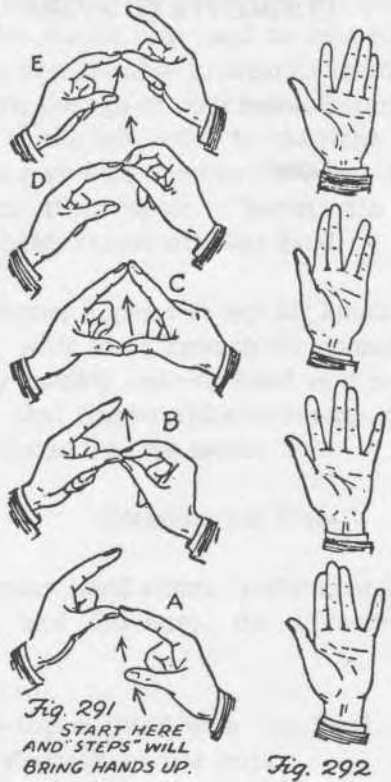

Source:

Date:

45. Many people find it hard to hold their fingers in one or more of the positions pictured in Fig. 292.

A pleasant effect is obtained by pointing the fingers of both hands toward each other, the left hand held as shown in second picture from top, right hand as in third picture. Rapidly reverse the positions of both hands in rhythmic fashion so that each hand is always in the position opposite to that of the other hand. (Jack McGinty)

46. One hand is turned palm up, the other palm down, with the middle fingers projecting above and below as shown in Fig. 293. The middle fingers are now wiggled back and forth so they appear like a

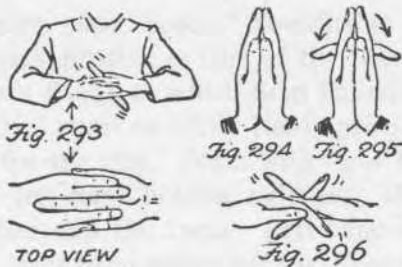

solid stick, inserted through the hands. An easy way to learn this ancient stunt is to start with the palms together (Fig. 294), cross the middle fingers (Fig. 295), then rotate the hands in opposite directions to obtain the final position of Fig. 293.

More complex variations are possible. For example, permitting first and third fingers of each hand to project above and below in an "X" formation (Fig. 296), then wiggling these fingers so that with each wiggle the two bars of the "X" change places.

46a. Ask someone to put middle finger of left hand on tip of nose and touch middle finger of right hand to tip of left thumb. When you give a signal, he is to reverse the position so his right middle finger is on nose and left middle finger on right thumb. He's likely to end up with right thumb on his nose.

#### Finger Rhymes

Only three finger rhymes seem to be currently part of our native folklore. They are:

47.

This is the church.  
This is the steeple  
Open the door and see  
all the people!

See the "Oxford Dictionary of Mother Goose Rhymes", p. 125, for a history of this rhyme. In England, it is usually followed by:

This is the minister going upstairs.  
And here is the minister saying his  
prayers.

The above couplet is accompanied by a finger action too complex to describe. It begins with the little fingers linked, one palm up, the other down. One at a time, the other pairs of fingers are linked, and finally the two hands are brought to a position in which one thumb (the minister) pokes upward from the other fist. At this point, British children often have the minister deliver a rhymed sermon on potato peeling.

Alan Barnert reports that as a child he would recite

#### COMMENTS AND ADDITIONS

Source:

Date:

the first rhyme, then clasp his hands again, with the fingers outside the hands instead of inside, and say:

Close the door and let them pray.

Open the door—all gone away!

On last line, the hands are opened to show there are no fingers inside.

A gag variation begins by asking spectators if they have seen the "modern version" of the old rhyme. The hands are clasped with fingers outside as in above version, and the following lines, recited:

This is the church.

This is the steeple.

Open the door,  
and where are the people?

The implication is, of course, that nowadays no one cares about attending church.

48.

Here are my mother's knives  
and forks.

Here is my father's table.

Here is my sister's looking glass,  
And here is baby's cradle!

See the "Oxford Dictionary of Mother Goose Rhymes", p. 262, for a history. The finger motions are too well known to require description.

49.

Tommy, Tommy, Tommy,  
Tommy,

Whoops! Tommy!

Whoops! Tommy, Tommy,  
Tommy, Tom.

This is a popular stunt among American children, and is probably very old. The extended index finger of right hand starts tapping the fingertips of the left, beginning with the pinkie. At each tap you say "Tommy." After the first finger is tapped, the right index finger slides down the side of left forefinger, along the crotch, and up the side of the thumb, while you say "Whoops!" Then the tip of thumb is tapped as you say "Tommy." The "Whoops!" is repeated as you slide the finger back along the same route. The four fingertips are now tapped to the accompaniment of "Tommy, Tommy, Tom," ending on the pinkie again.

## COMMENTS AND ADDITIONS

Source:

Date:

This is sometimes presented as a "do as I do" stunt, the victim never seeming to repeat it correctly. What he fails to notice is that after finishing, you fold your arms (or clasp hands) as you ask him to try again.

## COMMENTS AND ADDITIONS

Source:

Date:

### Hand Puppets

50. "Winkie." A face is drawn on left palm with ink, lipstick, or grease pencil. One eye must cross uppermost crease (Fig. 297). Bending third and fourth fingers forward will cause Winkie to wink.



51. Old lady. Hold left hand as in Fig. 298. Pieces of cigarette are clipped between second and third fingers, to make eyes. Fold handkerchief twice (Fig. 299), then wrap it about hand (Fig. 300) to form the old lady's shawl. Cloth is clipped slightly by pinkie and third finger, to hold it in place above, while right hand keeps "shawl" in place below. If index finger is moved up and down, the toothless old lady seems to be talking. You can also make her stick out her tongue at the spectators by pushing your thumb out through her "mouth." Two soda bottle tops, placed together (Fig. 301), can be held between first and second fingers, where they look like grotesque teeth (Fig. 302).

52. In this version, the large knuckle of index finger becomes the puppet's nose. With lipstick or grease pencil, draw the face on left hand (Fig. 303). Movements of your thumb make the face "talk," or "yawn" (Fig. 304). The yawn can be made so realistic that even with nothing painted on the hand, the effect is amusing. The stunt is





Fig. 303

Fig. 304

an ancient one, long popular with ventriloquists. Edgar Bergen used it for a vent routine in one of Disney's movies. Using a specially prepared glove, which forms the head of a rabbit, the stunt is the basis of Jay Marshall's well known act with "Lefty," (Fig. 304a).



Senor Wences, the Spanish ventriloquist, also makes good use of this type of hand puppet. His puppet "drinks" wine (gurgling sounds), sticks out its tongue (done with thumb of other hand), and puffs a cigarette (by squeezing left hand). There is a section on the puppet in Professor Hoffmann's "Drawing Room Amusements" (1883), p. 182.

53. An amusing imitation of two talking ostriches can be done by pushing each thumb between second and third fingers, and holding the hands as shown in Fig. 305.

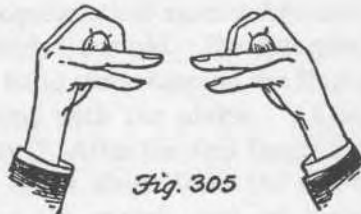

Fig. 305

53a. An amusing thumb puppet, featured by Lloyd Thaxton on a 1965 television show, is made by putting a thimble on left thumb, to serve as a hat, inking eyes and nose below thimble on the front side of tip of thumb, then drawing a circular

## COMMENTS AND ADDITIONS

Source:

Date:

mouth over the crease of the thumb. By bending thumb, the mouth opens and closes. The thumb sang a song as a recording provided the singing. Whenever a chorus of female voices came on, the hand opened to disclose similar faces on the tips of the four fingers, with mouths that also opened and shut as tips of fingers were bent.

#### Puzzles and Betchas

54. Fig. 306 pictures a curious method of interweaving the fingers. When you show this, few are able to duplicate it with their own hands, even though they study your fingers carefully. An easy way to learn the position is to start with fingers criss-crossed as in Fig. 307. Bring the hands to the position of Fig. 307-A by moving the index and little fingers outward, as shown. Now, place the tips of the index fingers against the tips of the crossed middle fingers. The tips of the pinkies are touched to the tips of the crossed ring fingers. The thumbs touch each other. And there you have it.

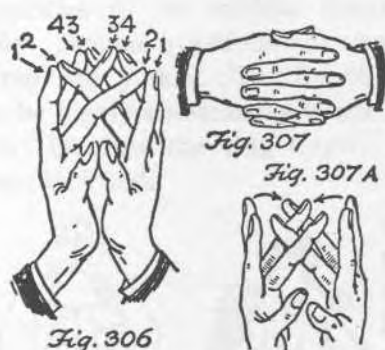

55. An ancient children's stunt. Performer moves his hand through the air in a large circle while he recites, "The moon is as round as a cheese." He continues with, "two eyes, a nose, and a mouth," the hand making gestures within the imaginary circle to indicate spots for the eyes, nose and mouth. Spectators are challenged to imitate this ritual exactly. Usually, no one succeeds, even though performer repeats it many times. Secret: left hand is used for the circle and gestures. Spectators seldom notice this, and use right hand instead.

56. Problem: put left hand where right is unable to touch it. Left hand is placed on right elbow.

#### COMMENTS AND ADDITIONS

Source:

Date:

Follow up with bet you can put something, not his elbow, on his left hand that he can't pick up with his right. Put drop of water on his hand.

57. Hold up your right arm. Bend the hand down as far as you can, at same time asking spectator if he can touch his elbow with his hand. When he says no, show how easy it is by touching right elbow with left hand!

58. Performer states he can have someone clasp his hands in such manner that he will be unable to leave the room. Done by having him place his arms around a post, table leg, etc., before he clasps hands.

59. Thumb and fingers of right hand are bunched together, then circled by left hand (Fig. 308). Spectator is asked to grasp the tip of what he believes to be your middle finger. Your hands are



Fig. 308



Fig. 309

then separated (spectator still holding firmly to the fingertip he selected), but he always has some finger other than the middle one. Reason: middle finger of right is bent down into the palm, a fact concealed in front by the left fingers. The tip marked "A" is actually tip of left pinkie, which rests along side of right ring finger, and is bent upward so the tip is visible. Eventually, spectator will grasp tip of your left pinkie. When your hands separate, and he finds himself holding finger of your left hand, it provides an amusing climax to the stunt. Shown me by Kuda Bux, who says it is popular among children in India.

60. Spectator is asked to bend right thumb into his palm (Fig. 309), then touch the tips of the fingers to his right shoulder. Tell him to remove his thumb from the palm position. Challenge him to replace it where it was before. Can't be done. In another version, fingers touch armpit instead of shoulder.

## COMMENTS AND ADDITIONS

Source:

Date:

61. Spectator holds his hands in position of Fig. 310. If he keeps the knuckles of his middle fingers touching each other, he will find it easy to separate the tips of all pairs of fingers except the ring fingers, which are impossible to move. This curious fact has been exploited in several ways. One version regards the ring fingers as a man and wife, who cannot be separated (other pairs of fingers represent relations less steadfast, such as man and brother, man and father, etc.). Another version involves placing a penny between each pair of touching fingertips. The thumbs, index fingers, and pinkies symbolize Irishmen, Frenchmen, etc., who find it easy to part with pennies—i.e., drop their penny to the table. The ring fingers are Scotchmen. They are unable to let go of the penny!

In still another version, one hand only is used. Spectator places right hand on table, in position of Fig. 311. He or she is now asked a series of questions such as, "Are you over 16? If so, raise the tip of your index fingers." Spectator does so, keeping knuckles of his middle finger pressed against table. Similar questions are answered by raising thumb and pinkie. The fourth question, designed to be highly embarrassing if not answered affirmatively, involves the ring finger, which of course cannot be lifted.



62. A number of finger and hand positions can be achieved only by persons with extremely flexible wrists or fingers. Perhaps the two most common of these "flexibility" stunts are (1) forcing the thumb to touch the arm (Fig. 312) and (2) touching tips of index and little fingers, in manner shown in Fig. 313. Some are able to keep the fingers touching while they bring their middle and ring fingers up through the triangular space then back down again.

## COMMENTS AND ADDITIONS

Source:

Date:



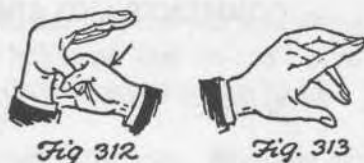

## COMMENTS AND ADDITIONS

Source:

Date:

62a. This curious stunt, of Frank Rigney's is difficult to describe. Hold left hand with palm up (Fig. 313-A), fingers pointing toward audience. Middle finger of right hand extends downward to touch left palm as shown, the other fingers curled back into fist. As the left fingers start to close (Fig. 313-B), the right hand pivots to the right, and the forefinger is extended (the picture exaggerates for clarity the angle at which it is extended). As the right hand pivots, it becomes horizontal, and the tip of middle finger rolls forward along the side of left hand. While this is happening, the left hand partially closes into a fist, and simultaneously rotates toward you until the back of the hand is uppermost. As the left hand rotates, the right index fingertip is placed on the back of left hand. At same time, the middle finger curls back into the right fist (Fig. 313-C).

As soon as the left hand completes its turn over, the partially closed fingers are extended once more, while the hand twists so it points toward audience again (Fig. 313-D). The right forefinger is now touching back of left hand, as shown.

All this is done in a continuous motion, neither too fast nor too slow. If properly executed, no one will see the exchange of fingers. Call attention to



fact that although you begin with middle finger touching left palm, you end with forefinger touching back of hand. It's safe to say that no one will be able to duplicate this odd flourish.

62b. Bet someone he can't guess within half an inch the length of the circumference around thickest part of his thumb. Average male thumb is three inches. Most men guess as low as inch-and-a-half.

#### Jokes and Catches

63. Announce that you will perform a difficult acrobatic feat—stand on one hand. Lower one hand to the floor. Place both feet on it.

64. Ask spectators if they have seen you make your "tummy" wiggle. When they say no, raise your hand and wiggle your thumb ("tummy.")

65. Extend three fingers. Pretend to adjust their positions very carefully and precisely, then ask which two have the widest space between them. Answer: the two end ones! (Rigney)

66. Tell spectator you are going to give him the "moron test." Extend your thumbs upward, saying, "Raise two fingers." If he follows your example, say "You're a moron, all right. Those are not fingers—they are thumbs!"

67. Place your fists together as shown (Fig. 314), and ask spectator to press his knuckles tightly against your knuckles. If you withdraw your hands quickly, it will cause him to crack his knuckles sharply against each other.



Fig. 315



Fig. 314

68. Hold your arms as shown (Fig. 315). Ask someone to press on your elbows. When he does, allow the pressure to lower the elbows, bringing your hands to a position in which you can thumb your nose at him with both hands.

#### COMMENTS AND ADDITIONS

Source:

Date:



68a. Another version of above. Hands are held as in Fig. 315-A. Ask victim to grasp your right pinkie and pull it toward him. As he does so, allow the pull to rotate your right hand forward, the right thumb pivoting on the left pinkie. At the same time, the left hand rotates backward until the tip of thumb touches your nose. This automatically brings both hands into a nose thumbing position. (Rigney)

69. There are a number of children's stunts in which a victim's fingers are caught so he cannot pull his hand away. For example: criss-cross the fingers (Fig. 316) and ask victim to push a finger through the center opening. When he does so, grab the finger tightly. Another example: victim places his first and second fingers together as in Fig. 317. If you grab them with one hand and hold tightly, he will be unable to pull his hands apart.



70. Several children's "catches" end with the victim getting pinched. Sample: ask victim if he would like to play "cops and robbers." If he says yes, say "Okay, you're pinched," and pinch him on arm.

71. Victim extends his palm. Move your index finger slowly over the palm while you tell a story of some sort about a car trip across the country. Your finger traces the supposed route of the car as it moves from city to city. After you finish the story, tell him that if he will smell his palm, he will be able to smell the fumes from the car's exhaust.

## COMMENTS AND ADDITIONS

Source:

Date:

When he tries this, push on his hand, causing victim to smack himself in the face. This stunt has many variations.

72. Dinner table prank. Hold your hand over victim's piece of pie, saying, "Feel the heat coming from that pie!" When he does so, slap his hand into the pie. A perpetrator of this prank can himself be caught, if the intended victim knows the joke. The victim pretends to fall for the prank, but is prepared to jerk his hand away as soon as the pranker tries to slap it. Result: pranker squashes his own hand into the pie!

72a. Pretend to nibble your fingernails, then spit out a mouthful of beans. (Robert Orben)

72b. Ask a child, "What's on your nose?" When he feels to see, say "It's your finger."

72c. Ask someone to cover one fist with palm of other hand and say "wing" three times. After he says "wing, wing, wing," pick up his hand as if it were a telephone, holding it up to your mouth and ear, and say "Hello".

### Games

73. "Stone, Paper, Scissor." On count of three, both players do one of three things: (1) Extend two fingers (known as "scissors"). (2) Extend all fingers ("paper"). (3) Extend no fingers, keeping hands doubled up in fists ("rock"). It is agreed upon that 3 defeats 1 (rock breaks scissors), 1 defeats 2 (scissors cut paper), and 2 defeats 3 (paper covers rock). In the United States, the winner is usually permitted to slap loser on the wrist, using his first two fingers for the blow.

According to Harbin's "Fun Encyclopedia", the game is popular in Japan, where it is called "Jan, Kem, Po." The Japanese often make a group game out of it by having two sides line up on opposite sides of a field. A player from each side runs toward the middle. When they meet, they stop running, and play the game. Winner continues running. Loser drops out, but his side sends another player forward to meet winner. When they meet, they stop running and play again. This process continues until one side succeeds in getting a man to opposite line.

### COMMENTS AND ADDITIONS

Source:

Date:



74. "Odds and Evens." Similar to above. Each player may extend either one or two fingers. Players take turns calling "odd" or "even." If fingers of both players match, they are "even." When they do not match, they are odd." If a player calls correctly, he wins. Otherwise, he loses. (The game is merely a finger substitute for matching coins.) If three people play, the "odd man" may be considered either winner or loser.

75. Player "A" extends both hands, palm up. Player "B" places his hands palm down on top of "A's" palms. "A" tries to slap the back of one or both of "B's" hands. "B" tries to jerk his hands away before they get slapped. If "A" succeeds in touching "B's" hands, he gets to try again. As soon as "A" misses, players reverse hand positions, and "B" tries to slap "A." The game can become quite vicious.



76. Two players face each other, holding their hands as shown in Fig. 318, the tips of their index fingers touching. Each must look into other's eyes. Both players now move their hands rapidly apart and together again, so that the fingertips keep tapping each other. While doing this, each player keeps repeating aloud, "this is a very serious game." The first person to laugh is the loser. Players may recite the phrase in any tone of voice, and may make faces, but are not permitted to take their eyes from other person's face. Excellent party stunt.

77. Thumb wrestling. Players clasp hands as shown (Fig. 319). Each tries to pin down the other's thumb.

77a. The popular Italian finger betting game called Morra has been solved by modern game theorists so that optimum strategies are known. See J. D. Williams, "The Compleat Strategist", 1954, p.163.

## COMMENTS AND ADDITIONS

Source:

Date:



## MATHEMATICAL

78. Finger abacus. In many European countries, peasants have long made use of their fingers for performing simple multiplication. For details, see Sloane's "Rapid Arithmetic", 1922, p. 80; Wallace Lee's "Math Miracles", p. 35; and Frank Rigney's article in HMM, Feb. 1950, p. 635.

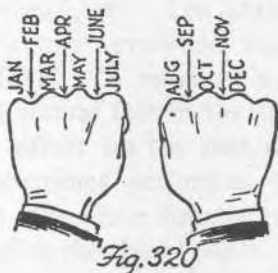

Fig. 320

79. The hands can be used for determining the number of days in each month. Fig. 320 shows how the knuckles and the spaces between them are labeled, the months running consecutively from left to right. All months indicated by knuckles have 31 days. Remaining months have 30, with February as the one exception.

80. To prove you have 11 fingers. Count the fingers on one hand by counting backward—"10, 9, 8, 7, 6." Then hold up the fingers of other hand, saying, "and 5 are 11." Can be carried a step further by counting all the fingers, from 1 to 10, ending on a thumb, then starting a backward count on the next (index) finger. The count for this hand will end on 7. Hold up fingers of other hand, saying, "and 5 are 12."

## PSYCHIC STUNTS

81. Spectator clasps hands, with two index fingers extended (Fig. 321). Tell him you are going to "grind his fingers together, without touching them." Make grinding motions with your fists, on each side of his hands. In most cases, the tips



Fig. 321

## COMMENTS AND ADDITIONS

Source:

Date:



of his extended fingers will move slowly together while you "grind." Due to suggestion, and fact that it is tiring to keep the fingers apart.

82. Spectator clasps hands, then extends both arms straight above his head, with palms of hands turned upward. Look him in the eye, make some hypnotic passes, and tell him he is unable to separate his hands. He must not bend his arms in the attempt. The position is such that his fingers lock securely.

83. Spectator extends both hands, palms up. Place your palms on his. Press down, and stroke his palms toward you. Tell him to try to keep his hands from being forced downward while you stroke them. After making several strokes, start the motion once more, but this time avoid touching his palms. Instead, raise your hands upward. Having been conditioned to pressing his palms upward against yours, his hands will automatically rise, as if your hands, by some subtle magnetism, were drawing his upward.

84. Tell spectator you are able to project coldness from your fingertips. Prepare his right hand by rubbing it vigorously between your hands, under some pretence such as uniting your two "magnetic fields." This makes his hand perspire slightly. When air currents strike the moist palm, evaporation will make the currents seem cool. He now holds his open right hand in front of him, the palm vertical. Move your right hand in a wide arc, keeping the hand open until it is close to spectator's palm, at which instant you stop moving the hand, and point your index finger at his palm.

The sweep of your hand creates an air current which he will feel as a momentary coolness. Repeat several times. On the last, secretly blow against his palm. If you blow quietly, and direct the air correctly, he will feel a strong current of cool air which seems to come from your pointing finger.

85. Lifting a person with the fingers. Someone sits in a chair. Two people stand behind him, and two on either side. Each person extends his index fingers, placing them alongside each other. The two in

## COMMENTS AND ADDITIONS

Source:

Date:



back of the chair place their extended forefingers under the seated person's armpits. The other two place their fingers beneath his knees. Tell the four that no matter how hard they try, they will find it impossible to lift the person from the chair. Let them make the attempt, which will fail, due in part to suggestion, but chiefly to lack of coordination among the lifters.

You now pretend to make the subject lighter by stroking his forehead, etc. The experiment is repeated, but this time everyone waits for your command of "lift!" To everyone's surprise, the subject is raised several feet in the air, apparently with very little effort on the part of the lifters. The stunt is sometimes performed by having all five participants take three breaths in unison, the lift being made after the third breath.

#### MISCELLANEOUS

86. To light a cigarette in heavy wind—a method widely used by sailors. Match is struck by right hand which is immediately placed against left palm as shown in Fig. 322. Hands are held with the



Fig. 322

opening uppermost, so flame will not burn fingers. Bend head over to apply cigarette to the flame.

87. Bend the index finger as in Fig. 323. If the tip of this finger is flipped up and down by right forefinger, it will vibrate rapidly, as though made of rubber. The sensation felt is strange. Also works on the other fingers.

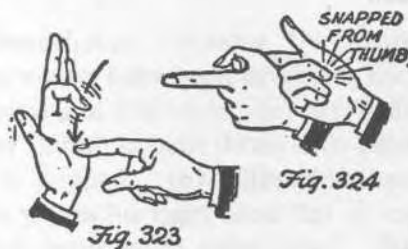

Fig. 323

Fig. 324

#### COMMENTS AND ADDITIONS

Source:

Date:

88. Children's stunt. Point left hand like a gun. Right index "cocks" the gun by pulling back thumb (Fig. 324). With hands in this position, make a popping sound by snapping middle finger of right hand off thumb. "Firing" the gun toward your left keeps the snapping finger out of sight. (Alan Barnert)

89. Thumb (or index finger) is pushed up through left fist, so the tip projects. Try to "catch" the thumb by withdrawing right hand quickly, and making a fast grabbing motion above the left fist. Children find this amusing.

Stanley Collins, in "A Conjuring Melange", suggests you demonstrate this a few times, secretly wearing a thumb tip on right thumb. After several failures, say, "sometimes you can catch it if you sneak up on it." This time, leave thumb tip projecting above left fist. Slowly remove right hand, put your finger to your lips with a "shh," then carefully pick up the tip and drop it in your pocket.

Not so well-known is Collins' impromptu version, same book, p. 120. Right thumb is inserted through top of left fist so it projects out between middle and ring fingers. When ready for the "catch" of thumb, the tip of left thumb is pushed out between the fingers as you appear to insert right thumb into left fist.

90. Magician "limbers up" his hands by a curious sleight which makes them appear miraculously flexible. Begin as in Fig. 325, fingers pointing toward audience. Slide right hand forward, at same time turning hands to the left (Fig. 326). As right hand moves forward, its fingers curl back over the fingertips of left hand. Now, right hand slides back and left slides forward, as the hands turn toward the right (Fig. 327). The left fingers curl over the tips of right fingers, as shown. The hands con-

## COMMENTS AND ADDITIONS

Source:

Date:

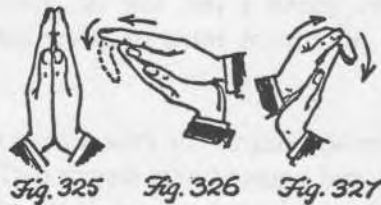

tinue turning from side to side, and sliding back and forth. From the front, it seems as if both hands are curling backward in a rubber-like fashion. The drawings show the hands from above.

91. Sewing fingers together. A comic pantomime in which you pretend to sew your left fingers together, one at a time, with invisible needle and thread. The routine has many variations - e.g., pushing the needle through left arm, so that when you pretend to pull on thread, left hand waves up and down; pulling the thread back and forth through both ears (the thread seeming to penetrate the skull); and so on. A good description of this routine, by Tom Osborne, is in his article on "Finger Tricks," "Linking Ring", Jan., 1960, p. 70.

92. Place thumb alongside extended forefinger (Fig. 328). The distance marked "A" is supposedly the length of your nose, says Frank Rigney, though anthropologists may be inclined to scoff. Test by placing finger alongside nose. (Fig. 328A).

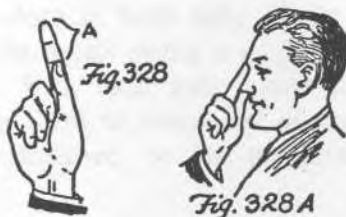

93. Tower of hands. Any number of people stand around table. One person places his right hand palm down on center of table. One at a time, the others place their right hands on top. Then the left hands are used in same manner, forming a tower of hands. The person whose hand is on bottom, jerks out his hand, slaps it on top of the tower. The person whose hand is next, does the same. This continues as rapidly as possible, and is reported to be great fun. Fine for boy's party.

94. Gag handshakes. Among the many comic handshakes which have been invented, the following are typical and printable. (a) Mr. Fish's handshake: right thumb is bent down into palm before the hand is gripped. (b) Milkmaid's handshake. One person places his right hand flat on top of the other's right, both hands palm down. Thumbs of each hand project downward. Each grasps other's thumb and "milks" it.

## COMMENTS AND ADDITIONS

Source:

Date:



95. Handies. A "handie" is a clever, amusing imitation of something by means of the hands. The handie craze reached its height in the United States in 1936. Several books of handies appeared, of which Milt Gross' "What's This?" was the funniest.

Typical handies: (a) Left fingers are bunched together, pointing upward. Right fingers are fluttered above them (quintuplets taking a shower). (b) Right hand is moved in a horizontal circle, the fingers snapping once on each revolution (broken phonograph record). (c) Left hand holds nose while right shades the eyes and you peer into distance (Indian looking for a dead horse). (d) Put fingertips together and push hands in and out (spider doing pushups on a mirror). (e) Put one arm behind back and hold out other hand, palm vertical (one-armed man showing how big a fish he caught). (f) Hold hand palm up, fingers slightly curved, and ask, "What's this?" When he gives up, turn hand over and say, "It's a dead that." (g) Snap fingers as you move hand in irregular way through air (butterfly with hiccups).

96. Charoodles. Charlie Manna introduced this in his nightclub act in 1955. You do something with your hands, ask "What's this?", and it turns out to be totally different from what everyone guesses. Samples: Wave arms like a bird flying (man painting two sides of narrow hallway); Act like man putting wallpaper on ceiling (man who fell in ice and is looking for the hole); Move fingers and left hand as if operating a typewriter (man washing socks and driving away flies); Wink one eye (man who took two sleeping pills and only one worked.)

#### HANDKERCHIEF

I know of no book or pamphlet dealing exclusively with impromptu tricks using ordinary pocket handkerchiefs. Will Blyth's "Handkerchief Magic", 1922, comes the closest to such a work. There are, however, a large number of booklets which treat exclusively of "silks," and which contain impromptu items applicable to pocket handkerchiefs. Some of them will be cited later as references.

No attempt will be made to list silk effects which cannot be performed with handkerchiefs, or tricks such as the classic Sympathetic Silks which can be done with handkerchiefs, but require so many of

#### COMMENTS AND ADDITIONS

Source:

Date:





them that they are essentially club or platform effects. Tricks requiring special apparatus or concealed gimmicks (thumb tip, false figure, pull, color change device, hank ball, extra piece of cloth, etc.) are likewise excluded even though they appear impromptu.

Some sleights for vanishing or producing a silk, without using gimmicks, can be applied to pocket handkerchiefs, but they are awkward for close-up work, and will not be discussed here. They may be found in such standard silk references as Harold Rice's "Encyclopedia of Silk Magic", 1948, and Jean Hugard's "Silken Sorcery", 1937.

If other objects play an essential role in a handkerchief trick (e.g., coin, thimble, cigarette, pencil, etc.) the trick will be found listed elsewhere in the "Encyclopedia", under the object used. In brief, the following are impromptu tricks using pocket handkerchiefs and nothing else.

1. Stretching hank. Hold hank by corners A and B (Fig. 329). Let go of A, grab C. In doing so, bunch the cloth in both fists. Twist it skip rope fashion. Alternately swing it in circles and pull on the ends. With each pull, allow some of the bunched up cloth to come out of the fists, until hank has stretched to its maximum diagonal length.

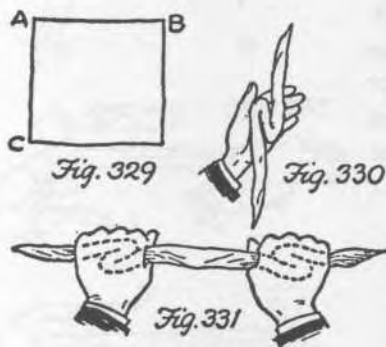

2. Method No. 2. Start as before. Let go of end A and as left hand grabs center of hank, loop the cloth as in Fig. 330. Loops are concealed by the fist. Right hand tugs alternately on the two ends, to stretch cloth to maximum length. Similar loops can also be secured by both hands, which hold the hank as in Fig. 331 while the hands move outward and appear to stretch it.

## COMMENTS AND ADDITIONS

Source:

Date:

3. Method No. 3. The hank is doubled and held by all four corners as in Fig. 332. Twist it skip rope fashion and begin tugging. Left hand releases end A, and right releases end D. Ends B and C are pulled in tugs that alternate with swinging the hank in circles.

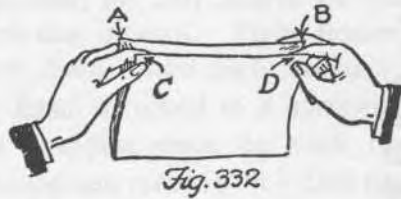
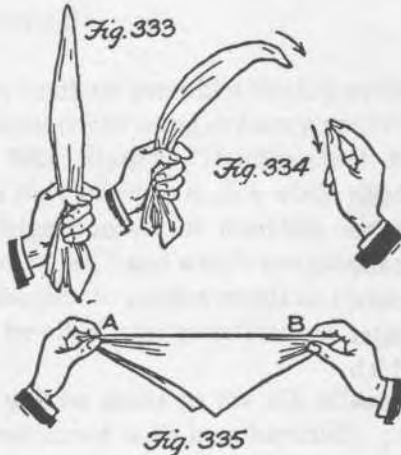

Fig. 332

4. Overhead vanish. Hank is rolled in small ball, apparently placed in left hand but retained in right. Right hand secretly tosses it over spectator's head under cover of a gesture, such as tapping left fist. Spectator can be completely baffled, and if others are watching, they will be highly amused. Hank falls noiselessly to floor behind spectator, or someone can catch it and secretly return it to you (or you can produce it from his pocket).

5. Invisible thread. Pull center of hank up through left fist so it remains rigid (Fig. 333). Pretend to tie invisible thread to tip of hank. As right hand pulls other end of invisible thread, the end of hank bends over (Fig. 334). When right hand moves back toward hank, the end returns to upright position. This movement is produced by secretly raising and lowering left thumb, and must be perfectly timed with motions of right hand. For finish, pull hank to bent position, then bend your head down and pretend to bite thread, at same



COMMENTS AND ADDITIONS

Source:

Date:

time letting hank spring upright.

Some prefer to tie knot at top corner of hank. Others roll hank into a tall, tight cylinder, rolling from corner to diagonally opposite corner. Wetting left thumb helps it make the move. George Sands uses right hand to turn an invisible crank. Crank knot down, then reverse cranking motion to crank it back up again.

6. Hank is held by diagonal corners (Fig. 335). It suddenly shoots to the right like an arrow. Done by pulling hank taut, then letting go of end A slightly before releasing end B. With practice, the hank can be caught by right hand, at corner A, as it travels to the right.

7. Threading the needle. An ancient trick with string, but very effective with hank. I once saw Paul Rosini present it with strong effect in a Chicago cabaret floorshow. The hank is first twisted rope fashion. Wrap it once around left thumb (Fig. 336), then form a small loop (Fig.

COMMENTS AND ADDITIONS

Source:

Date:

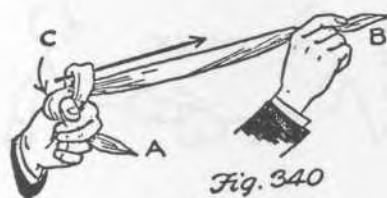
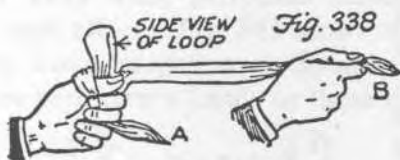
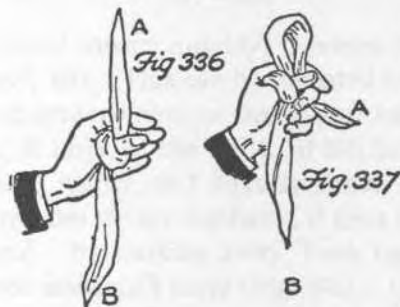

337), gripping end A between second and third fingers as shown. The long end (B) is lifted to position of Fig. 338, then brought back to position shown in Fig. 339. Jab the point of the hank forward several times toward the small loop, telling audience you intend to thread it through the loop so rapidly they will not see it done. Lunge forward with right hand, passing directly across loop, and ending with cloth taut as in Fig. 340.

It appears as if you threaded the loop in passing. Actually, the center of the hank has merely been pulled up from left fist and into the loop. Finish by grabbing the cloth at point C and slowly withdrawing it from the loop. The pictures show the trick as viewed from performer's right side. Care must be taken to finish with right arm either above or below left hand, so it will not hide the loop from audience on right. Trick is equally effective from all angles.

#### TRICKS USING THREAD

Many beautiful hank effects secretly employ a black thread, but because they usually require considerable preparation, or the use of a reel, no effort will be made to cover them fully. A few, in which preparation is relatively simple, will be listed here. Others will be found below among penetration and knot effects.

8. *Silk productions (pocket hanks are awkward to handle because of their weight and bulk). Silk is folded compactly into a ball that does not come apart, and placed under vest or in a vest pocket. Thread runs from silk to a lower button or the belt. When thumb is hooked in thread and hand moved quickly forward, it brings silk into the hand. See Hugard, "Silken Sorcery", p.78* Christopher prefers to have silk under the armpit, from where it can be obtained with greater ease. In either case, the production can be followed by a dissolving knot, using same thread arrangement.

9. Hank dances between performer's legs, while he is seated. Thread runs from leg to leg. Hank is knotted over it. The suspended hank is made to dance to music by beating time with one leg. See Hoffman, "Later Magic", p. 335.

#### COMMENTS AND ADDITIONS

Source:

Date:



10. Stage version of above, in which a horizontal thread is manipulated by an offstage assistant, can be presented in many different ways. It has been made famous in recent times by Blackstone. See Hoffman, "Later Magic", p. 336, for an early description.

COMMENTS AND ADDITIONS

Source:

Date:

11. Bert Easley's routine (published in "Conjuror's Magazine", 1946). Hank is fastened to a long thread, other end of which is attached to an upper button of shirt. Many comic effects are possible. Hank can be dropped to floor, and as performer tries to pick it up, it hops suddenly away. Fig. 341 shows the thread arrangement.



As right hand lowers quickly, it jumps the hand to performer's left. This can be repeated by reversing the thread arrangement so that as left hand reaches for hank, it hops to the right. If left hand (in Fig. 341) is held higher, and directly above hank, then as right reaches slowly for hank, it rises slowly into other hand. By walking away, hank can be made to rise into assistant's hand (Fig. 342). Or assistant can walk away while performer stands still, and achieve same effect. Fig. 343 shows arrangement by which hank, draped over thread, is made to float from performer's hands to those of assistant.

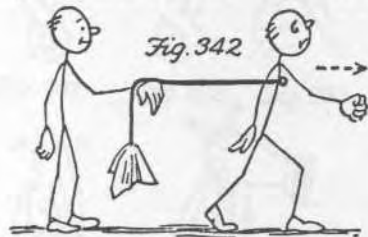



## PENETRATIONS

12. Hank is placed across spectator's wrist (Fig. 344). Ends are brought beneath and apparently crossed. Actually, tip of right index presses at point "A", forming a loop around which left hand

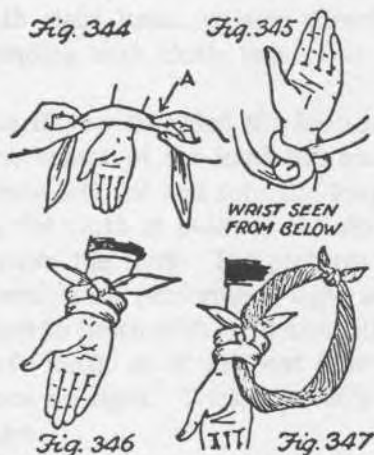

wraps hank (Fig. 345). This happens rapidly and gives good illusion of ends being crossed beneath wrist, then brought up again. A double knot is tied above wrist (Fig. 346). Right hand grasps knot, while left goes below to free the loop. Jerk up with right hand. Hank appears to penetrate wrist. A larger hank can be looped around performer's ankle, leg, or neck. This classic impromptu effect can be found in Hugard, "Silken Sorcery", p. 75; Rice, "More Naughty Silks", p. 13; "Tarbell", Vol. 1., p. 372; Sacks, "Sleight of Hand", p. 61; and many other books.

Rice suggests (in his effect No. 59) that a second hank be tied in a circle and placed on the wrist or leg, as shown in Fig. 347. The two hanks seem securely interlocked, but after the penetration is made, the hanks come apart also.

A complicated variation, involving two large silks of contrasting colors, was invented by Stanley Collins and described in his "Original Magical Creations", p. 77. One silk is looped around one thigh, and tied. The other silk is similarly fastened to the other thigh. When one silk is pulled free, the other jumps from one thigh to the other. A description may also be found in Hugard, "Silken Sorcery", p. 75.

## COMMENTS AND ADDITIONS

Source:

Date:

13. Hank is placed over spectator's extended first finger (Fig. 348). Cross it beneath (Fig. 349). In this and all succeeding crosses, end "A" must always be toward you. Cross ends above (Fig. 350). Spectator now places index finger of his left hand on top of the crossing (Fig. 351). Cross ends above this finger (Fig. 352), then beneath both fingers (Fig. 353). Bring ends up and hold them in your left hand (Fig. 354). His two fingers appear securely wrapped together. Grasp tip of his lower finger with your right hand, asking him to remove his upper finger from the cloth. As soon as he does so, pull up with left hand. The hank will pull free of his finger. (Fig. 355).

A pencil, table knife, etc., can be substituted for either or both of spectator's fingers. For a version using a broom handle and finger, see Blyth, "Handkerchief Magic", p. 72, or Rice, "More Naughty Silks", effect No. 19.

14. Hank is placed over a broom handle (or wand, back of chair, etc.) and looped about it as shown in Fig. 356. Spectator places a finger on the handle

COMMENTS AND ADDITIONS

Source:

Date:

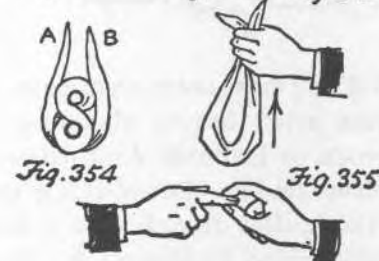
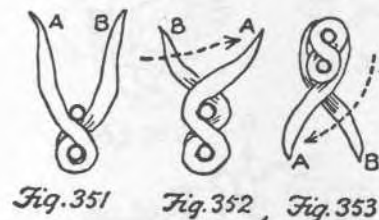
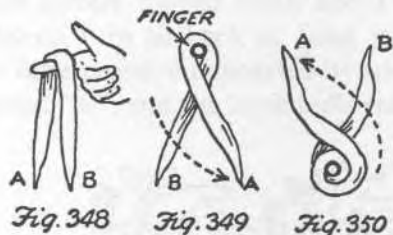

Faint, illegible text in the background, possibly bleed-through from the reverse side of the page.

Faint, illegible text in the background, possibly bleed-through from the reverse side of the page.



Faint, illegible text in the background, possibly bleed-through from the reverse side of the page.

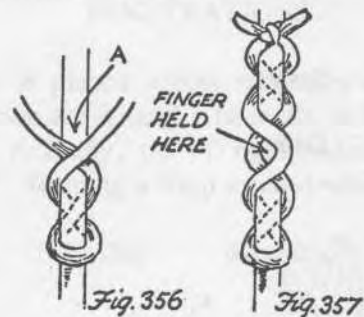

at point "A". The cloth now goes around the finger, crosses, and loops about the handle as shown in Fig. 357. At all crossings the same end must always cross over the other, or trick will not work. The ends of hank are knotted above the handle as shown. When spectator removes finger, and knot is simultaneously pulled upward, the hank comes free. As in previous trick, the second set of loops, being made in reverse directions, serve to undo the first set. Instead of spectator's finger, the blade of a knife can be pushed into broom handle at point "A". Loops need not extend along handle, as shown in Fig. 357 for clarity, but may be made on top of each other. With a larger hank, trick can be done on spectator's arms.

The trick is sometimes done on stage with stick held horizontally at each end by a spectator. A knife stuck in rod takes place of finger. When knife is removed, silk remains wound until it is jerked free.

15. Edwin Tabor's pull apart hanks. Cross one hank over another (Fig. 358). Reach under with

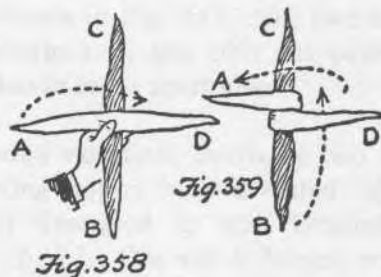

right hand, grasp end "A", wrap it once around the other (Fig. 359). Grasp end "B" of second hank, wrap it around first one as in Fig. 360. Bring ends "B" and "C" together below, and ends "A" and "D" together above (Fig. 361).

## COMMENTS AND ADDITIONS

Source:

Date:

## COMMENTS AND ADDITIONS

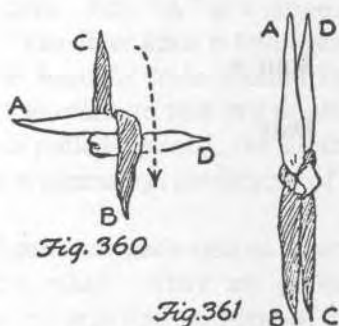

The hanks appear firmly locked. Pull—they come apart. Use hanks of contrasting colors. With silks, each can be wrapped twice around the other, and trick still works. See "Tarbell", Vol. 5, p.37, for full description. The trick can also be done with soda straws, rolled dollar bills, etc.

16. Hank is tied in a circle and placed over left wrist. Right hand grasps hank as shown in Fig. 362. It carries the cloth in the direction of arrow, to position of Fig. 363. Loop "A" is placed over left hand (Fig. 364). If done quickly, looks as if hank was merely looped twice about wrist. Left hand should turn so back of hand is uppermost, and the false crossing concealed beneath wrist. A tug at point "B", and the hank pulls free.

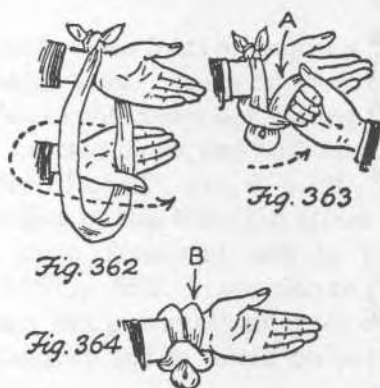

A little experimentation, and you'll find that hank can be genuinely looped twice around wrist by moves which look identical to above. Thus you can loop it legitimately and let spectator try vainly to pull it off. Repeat with phony looping, and remove it. A favorite of Nate Leipzig. See Rice, "More Naughty Silks", Effect No. 14; "Tarbell",

Source:

Date:

Vol. 6, p. 277; and "Dai Vernon's Tribute to Nate Leipzig", p. 78.

17. The false knot described below (No. 22) can be used for many penetration effects. In simplest form, place hank over stick (or back of chair, spectator's wrist, etc.), cross ends beneath, and tie the false knot (Fig. 365). Left hand reaches beneath, going behind end "A", and grabs end "B". Right hand reaches beneath and grabs "A". In other words, the ends are crossed below, end "A" crossing on the side nearest you. Pull hands apart quickly. Knot vanishes and hank will be stretched taut above stick.

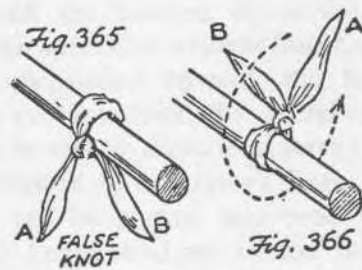

18. Tommy Dowd's penetration. Hank is tied around stick as described above, using the false knot. However, begin with hank below stick and tie knot above (Fig. 366). End "A" (which must be longer than other end) is brought around stick to the left, as shown by arrow. The ends are tied in a single knot, which is pulled down on top of first one. Hold tips of hank and jerk upward, at same time pulling hands apart. Hank penetrates stick, with a knot remaining in the center. See "Tarbell", Vol. 1., p. 382.

Al Baker's penetration through a spectator's wrist ("Tarbell", Vol. 1., p. 385) is similar. Instead of tying a second knot on top of first one, however, the ends are tied in a double knot, as in No. 12 above. When this knot is pulled upward, the hank (in form of knotted circle) pulls free.

Tarbell also describes (p. 386) a third effect using the Dowd principle. Two hanks are apparently knotted together at their centers. Each hank is tied in a circle. The circles are then pulled apart.

An elaboration of the Dowd principle, by Edwin Tabor is given in two variations by Tarbell, in Vol.

## COMMENTS AND ADDITIONS

Source:

Date:



3., p. 299. The false knot is tied above the stick as in Fig. 366. End "A" is wrapped twice around the stick. The false knot is tied again. The end on the right is brought once around the stick, as before, and the ends are tied in a double knot. When this knot is pulled upward, the cloth pulls free. A large hank is necessary, preferably of silk.

19. Two hanks are each tied in a circle, one interlocking the other. They are pulled apart. One hank must be prepared in advance by knotting opposite corners. This fact is concealed by stretching the hank along the other diagonal, and covering the knot with folds of cloth at the center of the hank. The free ends are tied openly in a false double knot, which will slip apart easily. A second hank is looped through the first, and its ends tied in a genuine double knot. This hank is held by left hand, or by spectator (Fig. 367).

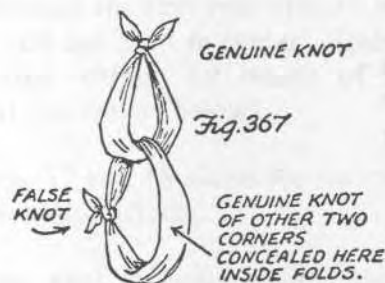

Right hand reaches into folds of prepared hank and grasps the hidden knot. Hanks can now be pulled apart. The false knot comes out, leaving hank still in form of a knotted circle, and both hanks can be examined. See "Tarbell", Vol. 3, p.310. Another excellent handling of this beautiful effect, by Jean Hugard and Jesse Schimmel, will be found in HMM, Feb., 1952, p. 893. In addition to the penetration, a finger ring previously threaded on one of the hanks, vanishes and is found on performer's finger.

20. Gene Tarbell's pull apart hanks. In this version, two hanks are tied together at the center with a genuine square knot. Each hank is now knotted into a circle. They are then pulled apart. See "Tarbell", Vol. 5, p. 41. The same release principle is employed in Tarbell's "Snap Away Silk," in which a single hank appears to penetrate a rope ("Tarbell", Vol. 3, p. 295.)

## COMMENTS AND ADDITIONS

Source:

Date:

21. A penetration of a single hank through a stick, back of chair, etc., can be obtained by means of a thread attached to diagonally opposite corners. See "Tarbell", Vol. 4, p. 355. In practice, however, the thread tends to cut the hand, and the effect is better achieved by means of a reel.

#### Dissolving Single Knot

22. A single knot is apparently pulled tight in center of hank, but when ends are pulled, it dissolves. Actually, knot is a slip knot. Begin with end "B" clipped between first and second finger of left hand. Right hand brings up end "A", passing it between left second and third fingers as shown in Fig. 368. It is held in place by left thumb.

Reach forward through the loop, grasp end "B" and draw it back through loop. As this end is pulled to the right, a knot seems to form. Actually, tip of left middle finger catches the cloth at point "X", forming a small "bight" around which the loop is tightened. The hands should be held so tip

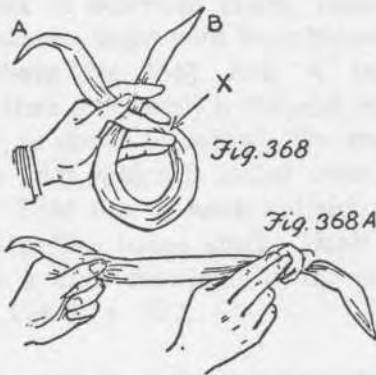

of middle finger is hidden as the slip knot is pulled tight. Right hand may even jerk its end vigorously several times, apparently forming a tight knot. See "Tarbell 1", p. 365, for more detailed description.

The knot's dissolution may be dramatized many ways.

(A) Blow on knot, at same instant pulling the ends.

(B) Left hand holds tip of end "A", letting hank hang vertically. Right fingers pinch top of knot and slide it downward slightly, as though tighten-

#### COMMENTS AND ADDITIONS

Source:

Date:

ing it. Actually, this pulls out the bight, but the fingers continue to pinch knot which prevents it from dissolving. Blow on knot, at same instant releasing it. (Note: end "A", not end "B", must be held by left hand, otherwise knot will not slide open.)

(C) Al Baker would hold end "A" in left hand, then right hand would pick up knot (Fig. 368-A), offering end "B" to spectator to hold. This gesture is a perfect cover-up for sliding knot forward and opening it. Spectator would take the end, then Al would walk away, not noticing that the knot had dissolved.

(D) The knotted hank is dropped into a hat, but before doing so, knot is secretly slipped open as previously described. Later, when hank is removed from hat, knot has vanished. Al Baker liked to drop three hanks, each apparently knotted, into hat. He removed the first two without knots, but third hank still had knot in center. This last knot then dissolved visibly, by means of a thread arrangement (see No. 31 below).

(E) See Nos. 17 and 18 above for use of this slip knot in penetration effects.

23. This slip knot is similar to the above knot, except bight is held by tip of thumb instead of middle finger. Start with end "A" held by left thumb and forefinger. Right hand loops cloth back around left hand as shown in Fig. 369, leaving end "B" between second and third fingers. Reach through loop from behind, hooking thumb over cloth at point "X". Thumb draws "X" through the loop (Fig. 370) then right hand grasps "B" in a closed fist. Left hand pulls "A" back through the loop, which forms a slip knot, the right thumb holding the bight.

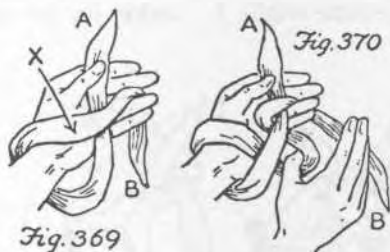

## COMMENTS AND ADDITIONS

Source:

Date:

The knot can also be formed with one continuous motion, the right hand never releasing end "B". In this case, the end is simply crossed over "A", then right thumb hooks "X" as left hand pulls "A" back through loop. As with previous knot, left hand may jerk cloth vigorously, apparently forming tight knot. See Rice, "Naughty Silks", effect No. 4, where the knot is described as a favorite of Houdini's.

24. Either of above false knots is tied in center. A second and legitimate knot is tied loosely over the false one. Hold one end and give hank a strong shake. Both knots vanish.

25. A genuine knot is tied loosely in center. Left hand holds one end of hank as right hand covers knot and strokes downward several times. On last stroke, knot dissolves. Accomplished by secretly inserting tip of middle finger into knot as it is covered by hand. The down stroke carries knot down and off lower end. Works best with silk.

26. Al Baker's knot. Several false knots have been invented which can be held firmly against the thigh or chest (or even against forearm) as the ends are slowly pulled, the knot drawing tighter and tighter then finally vanishing. The best method will be found described in Al Baker's "Ways and Means", p. 64. (See Thurston, "Four Hundred Tricks", Chapter 10, No. 10, for a simpler but inferior method.)

27. Sachs, in "Sleight of Hand", describes three dissolving knots. The third is clearly No. 32 below. The second I find unintelligible. The first seems to be a pseudo-knot similar to Al Baker's. If I understand it correctly, the ends are brought quickly together, throwing a loop with such force that it forms a double twist (Fig. 371). Appear to twist end "B" through loop, but actually bend it around "A" in the direction of arrow.

When ends are pulled, the cloth bunches in the middle, giving appearance of a knot which dissolves as the ends are pulled farther. Like the Baker plot, it can be pressed against thigh, chest, or forearm to make it draw tighter. A good description of the knot, pressed against thigh as it is pulled tighter, is given in H. Adrian Smith, "Superb Tricks", (1953).

## COMMENTS AND ADDITIONS

Source:

Date:





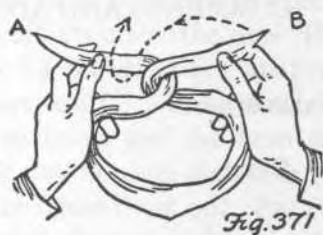

Fig. 371

28. Dai Vernon's knot. This is given in "The Dai Vernon Book of Magic", p. 155. (See Norman Houghton's similar method, HMM, June, 1963, p. 73.) Begin as in Fig. 372. Right hand forms a loop, bringing end "B" behind "A". Left thumb grips the crossing point (Fig. 373). Right hand retains grasp on "B." At this moment, turn to the left, so right side faces audience. Under cover of this turning, right hand moves downward, carrying the cloth, to form a small bight, as shown in Fig. 374.

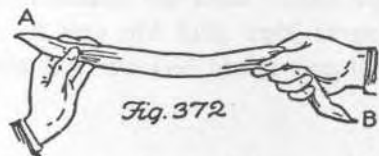

Fig. 372

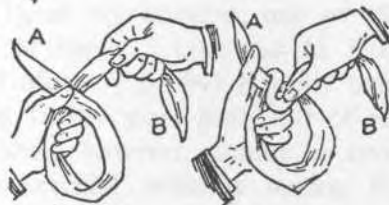

Fig. 373



Fig. 374

Left thumb immediately covers lower tip of bight, so when right hand is removed, audience sees the hank as in Fig. 375. End "B" appears to cross in front of "A", but actually is behind. Draw on "A" to make loop smaller, then push it through the loop (Fig. 376) to form what seems to be a knot. By alternately pulling at point "X", then on "A", the knot is drawn tight. Hank is held by one end and the knot - which looks amazingly genuine - is shown on all sides. A slight shake, and it vanishes.

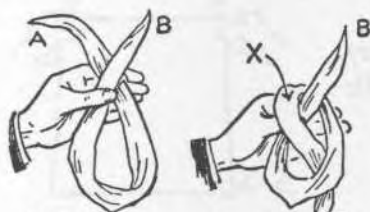

Fig. 375



Fig. 376

## COMMENTS AND ADDITIONS

Source:

Date:



29. The G. W. Hunter knot. A favorite of Nate Leipzig, shown to me by Vernon, and described here for first time, with Vernon's permission.

The ends are crossed as in Fig. 377. The small loop is held horizontally, so the picture is a view of hands from above. Right thumb and forefinger hold the crossing. Note that right second and third fingers curl through the loop.

Left thumb and middle finger grasp cloth at point "X". The left index is shown in readiness for pushing end "A" around point "X" then up through the loop. This would clearly form a knot. However, as left forefinger starts to do this, right hand rotates toward you. This enables right middle and third fingers to extend and give the small loop a half-twist before "A" is pushed up through it. Fig. 378 shows how the loop is twisted, forming a small bight at point "X".

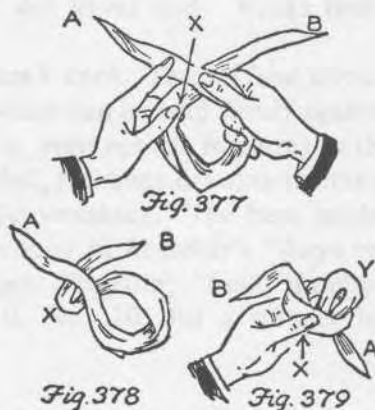

After left forefinger has pushed a portion of "A" upward through the twisted loop, hank should look like Fig. 379. At this point Leipzig would grasp the cloth at "Y" and by a series of small tugs, pull end "A" upward until it was completely through the loop.

Hold hank by one end to display the knot. Strike it sharply with back of other hand, and it vanishes.

30. Joe Berg's knot. The only false knot, to my knowledge, which pulls tighter and tighter, while hank is held by ends in mid-air.

## COMMENTS AND ADDITIONS

Source:

Date:

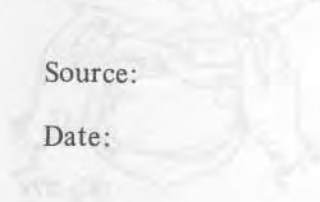

In 1937 Joe Berg published an excellent collection of original effects under the title "Here's New Magic". On p. 15 Joe describes what he calls an "odd handkerchief knot." Unfortunately, the instructions are so brief, and the knot so complicated, that to this day no one, including Joe himself, has been able to figure them out. For this, I must confess, I am entirely responsible. I helped Joe on the writing of this book, and in my description of the knot I not only was too brief, but also made one or two errors in the explanation. It is no wonder, then, that the knot has been unnoticed for thirteen years.

A month or so ago I got out my copy of "Here's New Magic" and went over the instructions again with grim determination to reconstruct what I had originally tried to say. I am happy to report success. A few days later, at a gathering at Bruce Elliott's, I introduced the knot to Dai Vernon and Doc Daley. It was not long until those two veterans experts had worked out a simplified handling.

The result is, in my opinion, one of the finest false knots in magic. Like the Al Baker knot ("Ways and Means", p. 64) it pulls tighter and tighter, then finally pops itself out of existence. The Baker knot, however, cannot be tied with a pocket handkerchief without resting the knot against the thigh or table top, whereas the Berg knot can be tied in mid-air. Any type of cloth can be used, but the best results are obtained from a strongly woven pocket handkerchief that has been handled enough to take out any stiffness due to pressing. The following instructions follow the numerical order of the pictures.

Figure 1: Hold the handkerchief as shown. Note that corner A does not show above the left forefinger.

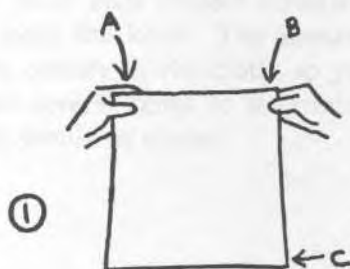

## COMMENTS AND ADDITIONS

Source:

Date:



Figure 2: Place corner B in the left hand, grabbing it so that three or four inches of the corner project above the fist. Corner A is retained by the left hand, the tip projecting slightly to the right as shown. This tip must not be visible to the audience. It is a good plan to cover this "getting set" move with appropriate patter, so the audience is not

COMMENTS AND ADDITIONS

Source:

Date:



watching the hands carefully until you have secured the position shown.

Figure 3: Pick up end C in the right hand, taking care to keep the tip of A out of sight.



Figure 4: Cross B over C.

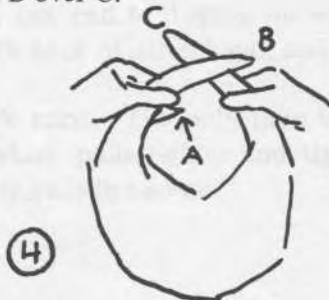

Figure 5: The left thumb and finger grasp the point of crossing. The right fingers bend B down and through the opening, as though tying a regular knot. This brings the tips of B and A together.



Figure 6: The right hand grasps both the ends. The tip of A is taken between thumb and first finger, the tip of B between first and second fingers.



Figure 7: Shift the left hand over to grab C. Hold the cloth vertically. The right hand pulls downward on the two ends it is holding. Because the ends are pressed together, they appear to be a single end. Actually the tip of A is toward you with B immediately behind it. Pull just enough so that these ends project downward about three inches from the knot. The amount of pull varies with the quality of the cloth, so you'll have to experiment several times to determine just how far this pull should be made.

## COMMENTS AND ADDITIONS

Source:

Date:



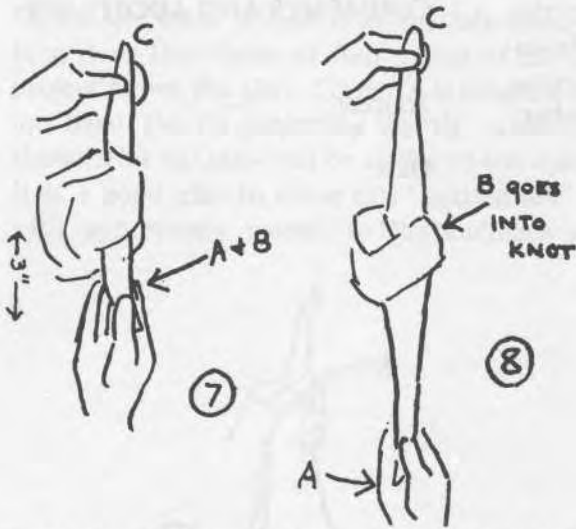

COMMENTS AND ADDITIONS

Source:

Date:

Figure 8: Release B from the first and second fingers, and give a sharp, vigorous tug on A, which is still held by finger and thumb. The result will be the formation of a convincing knot. End B is drawn into the knot, out of sight.

Figure 9: The knot can be pulled tighter and tighter, and shown freely on all sides. Then a quick jerk, and the knot dissolves. There is a danger of tearing a weak cloth by this final pull, which is why a sturdy cloth is recommended. If silk is used, the knot can be worked free by pulling on certain sides of the cloth at the two ends.

Actually, what happens is that two adjacent ends of the handkerchief are tied in a knot, then one end is switched for the end diagonally opposite the other. A pull results in tightening the knot until a point is reached at which it opens and vanishes.





To Joe goes credit for a brilliant conception, and I hope these expanded instructions will rescue it from its long and undeserved oblivion.

31. Thread methods. The serpent silk, in which thread is secretly used to make hank slowly untie itself, is too well known to require description. See "Tarbell", Vol. I, p. 376, for method using thread alone, and Albenice, "Reel Magic", for the standard method with reel.

The older method, in which thread was attached to table or floor, or the end held beneath foot, has been replaced in most stage and club acts by the use of a palmed reel. See "Tarbell 4," p. 352, for Jack Miller's more complex thread arrangement which causes knot to dissolve, then reform.

#### Knots That Won't Form

Many methods have been devised for apparently starting to tie a knot, but when the ends are pulled, no knot results.

32. Begin with end "A" held by left first and second fingers. Right hand loops hank around back of hand and over crotch of thumb (Fig. 380). Twist "B" through the loop, apparently forming a knot (Fig. 381), or, if you prefer, reach forward through loop and grasp "B." When the ends are pulled there is no knot. This is often described with hank looped over wrist instead of thumb crotch. See Keith Clark, "Silks Supreme", p. 8.

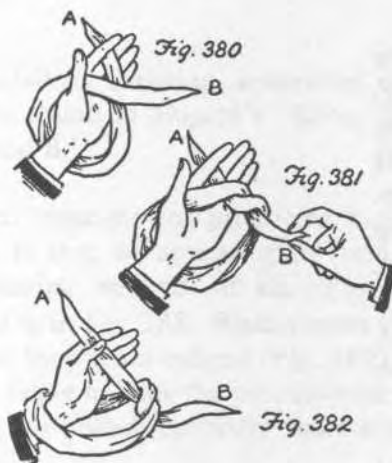

#### COMMENTS AND ADDITIONS

Source:

Date:

Same effect is obtained by making the loop from front to back over the wrist, and tying knot as in Fig. 382 (or reaching back through loop to grasp "B"). In both variations, the principle is that of tying a genuine knot with one hand inside the knot, so when the ends are pulled the knot comes out. Both methods are inferior to the following ones.

33. A second principle on which knot effects of this type are based is that of tying a genuine knot, but as the ends are pulled, one hand releases its end and seizes a portion of cloth within the knot. Here is one such method I developed recently.

Begin with the ends held by the fists, as in Fig. 383. Right hand forms a loop (Fig. 384). Note that tip of left thumb goes beneath cloth at point "X". Right fingers start to twist end "B" through loop. Left forefinger completes the twisting (Fig. 385). Once "B" is through, it is grasped by right

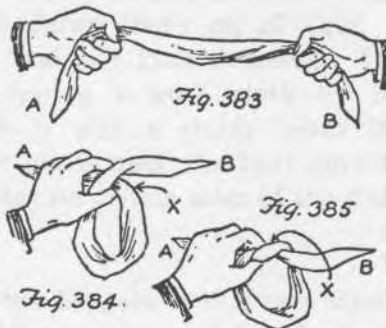

fist in same manner as before. This ties a genuine knot.

As the hands move apart with moderate speed, the left second, third, and fourth fingers relax slightly, letting go of "A", and the cloth is gripped at point "X" by thumb and forefinger. As the closed left hand moves to left, end "A" slips out of the loop. The end should be short enough so it flips back up into left fist, the tip projecting from it as before. There must be no visible movements of left fingers, the fist appearing closed around "A" at all times. Done smoothly and naturally, the illusion is deceptive and the move impossible to detect.

For a slightly different version of essentially the same knot, see "The Secret Out", p. 241.

## COMMENTS AND ADDITIONS

Source:

Date:

34. The above principle can be exploited in many other ways. For example, begin with "B" clipped between first and second fingers of left hand. Right hand places "A" between left third and fourth fingers (Fig. 386). Note that tip of left thumb is beneath cloth at point "X". End "B" is now twisted through the loop to form the knot (or right hand reaches through loop to seize it). As hands move apart, left forefinger and thumb grip cloth at "X", as in previous method. Hoffmann, "Modern Magic", p. 237, is a brief description of a variation similar to this.

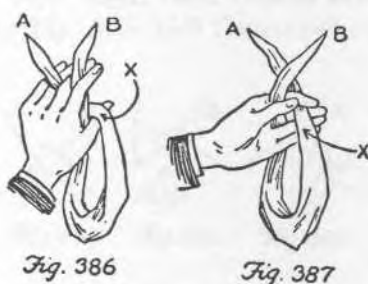

Fig. 386

Fig. 387

35. A third variation, and one of the best, has not, as far as I know, been recorded. Left hand grips "B" between third and fourth fingers. Right hand places "A" between first and second fingers (Fig. 387). Right now reaches forward through loop and seizes "B." Left hand draws its end to the left, right hand remaining stationary. As it does so, "A" is released by first and second fingers and grasped at "X" by thumb and third finger. Can be repeated many times, as the change of grip is undetectable. The tying should be done slowly so audience can be sure a genuine knot is being formed.

Another excellent variation, somewhat similar to this, will be found in Hugard's "Silken Sorcery", p. 65, method B.

36. A third principle for producing knots which do not tie is that of appearing to form a knot, actually forming no knot at all. For example, hank is held as in Fig. 388. Right fingers twist "B" through the loop from behind (Fig. 389), the left thumb and finger holding the pseudo-knot in place. When ends are pulled, naturally there is no knot.

## COMMENTS AND ADDITIONS

Source:

Date:

Another way of forming the pseudo-knot is simply to grip the cloth with right hand at point "X" (Fig. 388). Lift this portion forward over end "B" and down again, apparently making a knot. This move, like the previous one (and like so many knot moves) has what can be called a "mirror image" form. The ends can be crossed the opposite way (that is, "B" over "A") and point "X" lifted over end "B" from back to front instead of front to back. The result in both cases is a pseudo-knot, one a mirror image of the other.

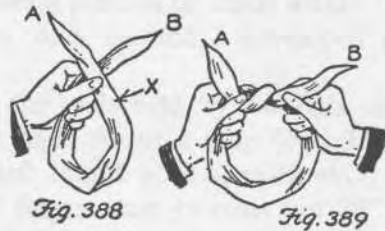

These pseudo-knots fall apart so quickly that spectators suspect improper tying, and consequently are less effective than previously described knots. They are useful, however, as the beginning of false double knots, as will be made in the next section.

**Dissolving Double Knots**  
**Pseudo Double Knots**

These are knots which appear to be genuine double knots, but actually are single knots tied on top of a twist. They may be used for knotting two hanks together, or the opposite ends of a single hank. They come apart easily.

37. The ends of hank are crossed, and under pretense of tying a knot, one end is merely twisted around the other (Fig. 390). A genuine knot is now tied to form the pseudo double knot. (See "Tarbell", Vol. 1, p. 368).



**COMMENTS AND ADDITIONS**

Source:

Date:



38. Begin as in Fig. 391. End B is twisted down by right forefinger (Fig. 392). Right forefinger and thumb grasp the crossing point, thumb below, finger on top. Right hand rotates forward, as though bringing end B up to complete the knot. The rotation, however, carries end A with it. This brings ends back to original position of Fig. 391. Second (genuine) knot is now tied.

39. Begin as in Fig. 393. Left forefinger twists end A down (Fig. 394). Crossing point is grasped by right thumb and forefinger, with thumb below, finger on top. Right hand rotates forward, bringing ends to Fig. 395. Left fingers seize end B, right



fingers seize A, bringing ends to position of Fig. 390. Second knot is now tied. Because of the double twist, this knot (like No. 37) is more secure than No. 38.

40. Tie the pseudo-knot described in No. 36 above. A second knot is tied over it. If spectator is allowed to tie second knot, the method described in second paragraph of No. 36 is best because the first knot appears more genuine, and also can be held easily while spectator pulls second knot as tight as he wishes. If both knots are tied by you, it is best to begin with pseudo-knot explained in first paragraph of No. 36.

41. Tie the pseudo-knot described in first paragraph of No. 36 above. Before tying second knot, however, push on the cloth at point "X" with left forefinger to form a small bight that projects toward you. (Fig. 396. Right "X" shown exaggerated for clarity). Second knot is tied on top of this bight. If spectator ties second knot, bight

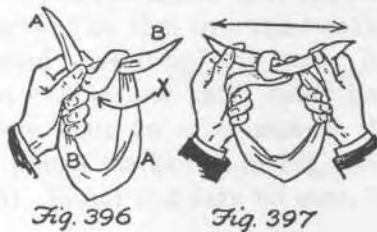

## COMMENTS AND ADDITIONS

Source:

Date:



can be held in place by left thumb. The result is a remarkably firm knot. It looks genuine and spectator may pull it as tight as he wishes. He may even examine it in his own hands after it is formed.

Two hanks tied together with this knot may be shaken vigorously without opening knot. Yet it can be released easily by holding knot with forefinger and thumb while remaining fingers pull on end B below knot. Another method of releasing it is to hold hank as in Fig. 397. Jerk hands apart a few times, apparently tightening knot, but actually pulling out bight. (See "Tarbell", Vol. 1, p. 369)

#### Tricks Using Pseudo Double Knots

Many tricks requiring false double knots, such as the Sympathetic Silks, are more effective if genuine double knots are tied, then "upset" as will be described below. The following tricks, however, require pseudo double knots.

42. Humorous quickie. Have spectator complete the pseudo knot described above in No. 40. Urge him several times to pull it "still tighter". Hold the hank in both hands while he does this, keeping first knot in place with left thumb and finger. Now turn to another spectator and say, "Will you please tie a third knot." As you do this, separate your hands. The double knot immediately falls apart.

43. Al Baker's dissolving double knot. See his "Ways and Means", p. 69. Two hanks are tied together with a pseudo double knot (No. 40), which is then placed on the back of one hand, the hanks hanging on both sides of hand. A tug on hanks partly untwists knot. Hand is tilted back and forth, causing both hanks to fall separately to floor.

44. Dai Vernon's dissolving double knot. Using natural moves for displaying and tightening pseudo-knot No. 40, the knot is completely undone. It seems to melt away without a trace. See "Phoenix", July 10, 1953, Bruce Elliot, "The Best in Magic", p. 78 and "The Dai Vernon Book of Magic", p. 158, where the trick is called "Splitting the Atom".

#### COMMENTS AND ADDITIONS

Source:

Date:



## Genuine Double Knots

These are genuine knots, tied or adjusted in such manner that one end becomes straight, and can easily be pulled out, untying knot. If silk or nylon hanks are used, knot may be pulled extremely tight and still slip open easily.

45. If first knot is tied by you, the simplest handling is to begin as Fig. 393. End A is twisted down, then brought up on right hand side (Fig. 398) where it is seized by right fingers. Left fingers take end B. In other words, ends are exchanged in process of tying first knot. (If you prefer, ends can be exchanged after first knot is tied in ordinary manner by you or by spectator.) After second knot is tied, a double knot will result (Fig. 399. Knot shown loose for clarity) in which end B remains perfectly straight. It does not matter which way ends are crossed before tying second knot, so a spectator may tie it if you wish. Knot is easily slipped open by pulling end B out of knot. ("Tarbell", Vol. 1, p. 371).

Once knot is tied, you can pretend to pull it very tight by holding it as in Fig. 397, and jerking hands apart vigorously. Actually, apply tension only to straight end. Or, let spectator hold straight end, below knot, while you pull on tip of same end. This is effective for large audience because they cannot see exactly how hank is being held, and assume that you and spectator are pulling on tips of both ends.



46. If spectator is permitted to tie both knots, he will produce either a square knot, or granny. In either case, you can adjust knot (under pretense of pulling tighter) so that one end becomes straight. This is called "upsetting" the knot. It is done by seizing an end in one hand, other hand grasping cloth below knot on same side as the end (for example, points marked A in Fig. 400, or points marked B). Either end may be used, but it is best

## COMMENTS AND ADDITIONS

Source:

Date:

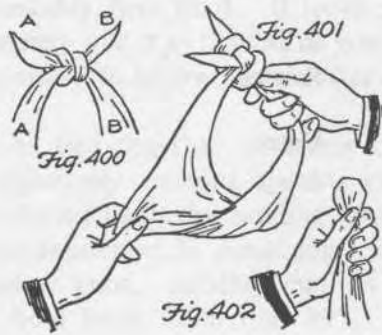

to use shortest end, as this end is lengthened by the upsetting. Under pretense of tightening, or under cover of moving hands forward to show knot to a spectator, you can slip it slightly, making both ends the same length. This also makes it easier to slip knot open later.

Dai Vernon's technique for upsetting a square knot is given in "The Dai Vernon Book of Magic", p. 157. Slydini's methods for upsetting knots, of all types are given in "The Magic of Slydini", Chapter 13.

#### Tricks Using Genuine Double Knots

47. A classic of impromptu magic which, as Sachs puts it, "should never be despised", is the magical dissolution of a double knot tied with opposite corners of a pocket hank. The knot recommended by Sachs is No. 45 above. Pretend to pull it tight. Hold knot by thumb and forefinger of right hand, the third and fourth fingers clipping the cloth below knot, on the end to be slipped (Fig. 401). Left hand takes a corner of hank, as shown, and covers knot with center of hank. As this is done, right third and fourth fingers slip the knot. Although one end slides completely out of knot, other end remains bunched in the form of a knot.

Through the cloth it feels like a genuine knot. Left hand holds hank at the base of this apparent knot (Fig. 402) and spectator is asked to hold knot tightly through the cloth. If right fingers do not succeed in slipping end completely free, which may occur if end is long, then the slipping can be completed after left hand has grasped hank as in

#### COMMENTS AND ADDITIONS

Source:

Date:

Fig. 402. Right hand merely completes the pulling as it emerges from hank.

After spectator has grasped knot through the cloth, and you have made a few appropriate remarks, take hold of the end that has been slipped out of knot. It will be twisted slightly, but as you seize it, smooth it out. Ask him to release his grip slightly, holding knot less firmly. As he does so, he feels the bunched up end start to uncoil. The sensation is that of a knot magically coming undone. Slowly lift up hank by the corner you are holding, shaking hank slightly as you raise it. If you wish, blow against it to open it further. Left hand takes the corner adjacent to one you are holding. Hank shakes open slowly, without a trace of original knot.

If you prefer, spectator may tie the double knot. Upset it while pretending to pull it tighter (as in No. 46 above), then proceed as before.

48. A comedy variation of above trick, not recommended because it repeats too often the slipping of a knot and tends to give away the method, is as follows. After spectator has grasped knot through the cloth, find two more ends and tie them the same way as before. Slip this second knot also as you place it beneath the cloth, alongside of first one. Spectator now holds what he believes to be two knots. Two free ends, however, can still be found. Tie them in a third knot, placing it with the other two, and slipping it as you do so. One end now remains, apparently proving the hank has seven ends. Grasp this end, ask spectator to let go, then shake hank open to show that all three knots have vanished.

49. This is similar to No. 47, except that five or six knots are tied, one on top of another. It is most effective if these knots are tied by spectators. Silk or nylon hanks are best to use. The first knot must be pulled down until only a small loop remains (Fig. 403). You can do this yourself, then have spectator tie second knot. Or you can hold hank in the center, palm down, and have spectator tie a double knot on the back of your hand.



Fig. 403

## COMMENTS AND ADDITIONS

Source:

Date:



Upset the knot as you pretend to tighten, then have another spectator tie a third knot. Upset it as you tighten. Continue having knots tied, forming a tight chain, until one last knot can be tied only with difficulty because of the shortness of ends. This sells notion that you are having as many knots tied as possible. Due to your adjustments after each knot is tied, one end remains straight throughout. It can be slipped by right hand as you cover the chain of knots with center of hank. Finish as in No. 47.

If properly dramatized, this is one of the strongest of parlor effects. Chief problem to overcome is that of one end becoming much shorter than the other as knots are added. To compensate partially for this, tie first knot with one end longer than other. Pull on shortest end when you upset this and succeeding knots. Finally, after each knot is upset, pretend to pull it still tighter, actually sliding knot until the straight end becomes a trifle shorter than the other. If you prefer, you can do this sliding as you extend hank to a different spectator for the next knot. A skillful use of these devices, covered by patter and misdirection, will keep ends always at approximately the same length, down to final knot.

The trick is well described in "The Magician's Own Book", p. 14.

50. Charles Waller's method. This effect is similar to the preceding, but the method involves an exchange of hanks. Prepare one hank in advance by tying a slip knot near the center (Fig. 404). Pull

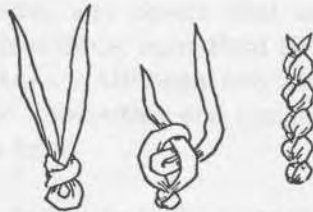

Fig. 404 Fig. 405 Fig. 406

it tight, then tie another slip knot on top (Fig. 405). Continue adding slip knots until hank looks like Fig. 406. Leave ends long enough for one final knot. Carry hank in right outside coat pocket.

## COMMENTS AND ADDITIONS

Source:

Date:



Show duplicate hank and patter about how your wife kept reminding you, at the breakfast table, of errands she wanted you to do before you came home later in the day. You decide to tie a knot in your hank to remind you of each errand. After each knot is tied, start to put hank in your coat pocket, without letting it get completely out of sight. Then your wife remembers something else, and you bring out hank to tie another knot.

After the last knot, right hand goes completely into pocket where you switch hanks. Bring out the hank with slip knots, and tie one final knot. Use the first single knot of No. 39 above, or tie it as described in No. 36, both of which produce only twisted ends. Pretend to pull knot tight. Patter about how you came home, after having forgotten about the errands. When your wife reminds you of the knots, you are forced to call upon your magical knowledge to extricate yourself. "But my dear", you say, "there are no knots here at all." Pull on the ends, and all the knots pull out.

Jean Hugard, in HMM, March, 1952, describes a version performed while seated at table. Left hand, holding knotted hank, is lowered to table edge after each knot is tied. Duplicate rests in lap. Switch is made by dropping hank from left hand, as it rests on edge of table. Right hand secretly takes duplicate from lap, brings it up to be grasped by left fingers.

Another version is to let spectators tie the knots (in this case patter about the wife should be omitted), then a pocket switch is made as you reach into your pockets to find a small object of some sort. The object is then waved over the hank, or touched to hank, to cause the knots to become slip knots.



## COMMENTS AND ADDITIONS

Source:

Date:

51. Two hanks, the ends tied with a double knot, may be released in many dramatic ways. For example, cover knot with center of either hank, slipping knot as you do so. Grasp bunched end thru the cloth, and hold hanks as in Fig. 407. A slight shake, and lower hank falls free. Slydini liked to push knot into a glass on table. When free, the ends of hanks are slowly lifted, the hanks emerge from glass unjoined. For comedy effect, Slydini holds knot in one hand, and with other hand offers an end of hank to spectator to hold. He walks away, leaving single hank in spectator's hand.

#### COMMENTS AND ADDITIONS



Fig. 407

52. Three hanks tied together with two double knots may be released by slipping each knot individually as the hanks are bunched together and placed on table, or as each knot is placed inside a glass on table. A simpler method, which slips both knots at once, is as follows:

Tie each knot as in No. 45 above. Straight end of each knot must belong to center hank (an easy way to make sure of this is to keep center hank in left hand while each knot is tied). Tie both knots loosely, with short projecting ends. Pretend to pull each one tight.

Left hand displays the chain of hanks. Grasp center hank with right hand, and drape chain over left (Fig. 408. For clarity, end hanks are shown darker in color.) Right hand now clips center hank between the fingers as shown in Fig. 409, which insures a tight grip. Move right hand under the left hand forward, palm up, until it can grasp the central portions of the other two hanks (Fig. 410).



Fig. 408



Fig. 409



Fig. 410



Fig. 411

As right hand moves forward, it carries with it the ends of center hank, slipping them out of the knots. The move should be continuous, with no hesitation.

Both hands place hanks in a pile on table. As you do this, see that the formerly knotted ends A and B project backward. Fig. 411 shows this from above. These ends, especially if you are not using silk or nylon, may be slightly twisted. To show hanks as separated, take one of these ends and raise hank slowly. The end that hangs free will show no twists, and the effect is cleaner. Pick up next hank in same manner. Remaining hank is the former center one, which has no twisted ends.

The Sympathetic Silks, for which this move is useful, can hardly be presented impromptu, and therefore will not be discussed. For a description, see "Tarbell", Vol. 1, p. 378; Hugard, "Silken Sorcery", p. 60; Edward Proudlock's manuscript "Sympathetic Silks", sold by dealers; and Keith Clark, "Silks Supreme", p. 13. Al Baker's "Ways and Means", p. 66 gives a version with four silks instead of six, including an excellent count move.

53. The knotted chain. Many performers, notably Hermann, have featured this effect. Six or more borrowed hanks are tied in a chain, a different spectator making each knot. In pretending to tighten each knot, it is upset. The knots are slipped one at a time as hanks are arranged in a pile on table or placed in a hat. Hat is shaken, then hanks are lifted out one at a time to show that knots have vanished. For a classic description, see Sachs, who considers the trick "worth half a dozen apparatus tricks put together."

53a. A beautiful effect, made famous by Slydini, is to knot three hanks in a chain. Each knot is pushed down into an empty glass. Each end hank is then lifted slowly upward. It pulls free of center hank, which remains with its ends still in two glasses. Slydini's handling has not been published. Dr. Daley's method of slipping the two knots simultaneously is given in "The Phoenix", March 5, 1954, p. 7.

## COMMENTS AND ADDITIONS

Source:

Date:



53b. Slydini's method of apparently tying what Sach's calls the "bete noir" knot, then splitting the knot apart so that a knot remains on the ends of each silk, is given in "The Magic of Slydini", Chapter 13.

## COMMENTS AND ADDITIONS

Source:

Date:

### Appearing Knots

54. Shaking knot in end of hank. Knot is previously tied at tip of one end. This end is held by right hand, as in Fig. 412. State you intend to shake a knot into lower end. Left hand lifts up this end, which is seized by right thumb and finger (Fig. 412-A). Give hank a shake, either vertically or horizontally to the right, at same time releasing unknotted end. No knot appears. Repeat once more. On third attempt, retain grip with thumb and finger, release knotted end.

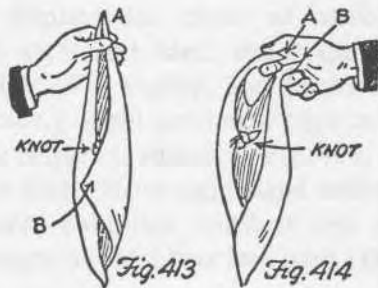
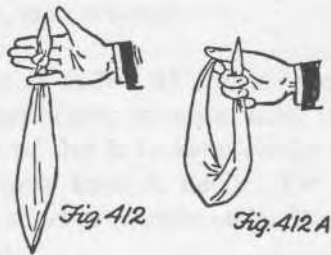

55. A more effective version of the above, which I worked out recently, begins by holding hank in left hand as in Fig. 413. The previously tied knot is concealed behind the cloth as shown. Ask spectator which end, top or bottom, he wishes you to shake into a knot. If he chooses lower end, bring right hand up behind hank apparently to seize top end. Actually, right first and second fingers secretly clip corner "B." Left hand now lowers hank so right thumb and forefinger can seize top end (Fig. 414). (This is better than continuing to raise



right hand, which makes more noticeable a slight disturbance of lower end.) Spectators are not aware, of course, that two ends are being held by right hand.

Give a slight shake, releasing end held by thumb and finger, and retaining grip on other end. The knot suddenly appears in lowest end. The move should be continuous, with no hesitation between the seizing of upper end and the shake.

If spectator chooses top end, seize both ends in either hand, and pull taut. You can now reverse the hank without danger of the knot swinging into view. Finish as before.

56. Two separate hanks are placed together and tossed in the air. Two ends instantly become knotted. Accomplished by a small rubber band secretly carried around first two fingers of either hand. The band is not slipped over the ends, but over a small bight (Fig. 415). Some performers



like to finish the Sympathetic Silks by placing all six together and tossing them into the air, using rubber bands (of the same color as silks) for apparently knotting all six.

57. Though not strictly impromptu, it should be mentioned that wax also may be used for magically knotting two hanks. Small knots are previously tied in a corner of each hank, and each knot covered with wax. Fingers of each hand conceal the knots when hanks are exhibited, one in each hand. Place the ends together, pressing one knot against other, and toss upward.

58. A knot is tied in center of hank. When hank is shaken, a second knot appears. A knot is previously tied, near one end, but hank is held so fingers conceal this knot. Tie another knot, tying it loosely, with first knot concealed within it (Fig. 416). Hold upper end and give a quick shake (or pull on both ends) to make second knot appear.

## COMMENTS AND ADDITIONS

Source:

Date:



59. Several methods have been devised for obtaining above effect without previous preparation. Large silks must be used. Both knots are tied simultaneously, one within the other, while apparently tying only a single knot. See Rice, "More Naughty Silks", Nos. 46 and 47, for two methods.

60. A number of thread methods have been worked out for making a hank knot itself visibly. G. W. Hunter was first, I believe, to do this (see "The Magic Wand", June-Sept., 1923, p. 36). See also "Greater Magic", p. 612. Note Tenkai's thread method for producing three knots ("Greater Magic", p. 613).

#### Knot Transpositions

Knot transposition effects, such as the Sympathetic Silks, are, of course, combinations of vanishing and appearing knots. Many such combinations can be worked out. Here are two in which a single knot seems to travel from one hank to another.

61. Horowitz's transposition. Tie dissolving knot No. 22 in center of one hank, and give corner of hank to spectator to hold. Another hank is held horizontally by each end. A second spectator is asked to cover it with a third hank, which must be opaque. As hank is covered, the hands momentarily come together, secretly tying the quick knot to be described (No. 64). The covered hank is then held at both ends by second spectator. Take first hank and vanish knot. Second hank is now uncovered to reveal knot. For details, see "Tarbell", Vol. 3, p. 302.

62. Tie dissolving knot No. 22 in one hank and hold it by one end in left hand. Right hand holds corner of another hank. Shake both hands, simultaneously shaking out the dissolving knot and tying a one-hand knot (No. 63) in other hank.

#### Knot Releases from Rope

62a. Scores of clever methods have been invented for apparently tying a hank around a rope, held at the ends by a spectator, then pulling the hank free, still knotted. It is not possible here even to attempt a selected bibliography. Five different methods will be found in "Tarbell", Vol. 6, pages 263-275.

#### COMMENTS AND ADDITIONS

Source:

Date:



## Knot Flourishes

63. One-hand knot. There are several methods for holding hank in one hand and quickly shaking it into a knot. Most widely used method is given in "Tarbell", Vol. 1, p. 363 (a simplified version, easier to do but less effective, is in Vol. 3 p. 305). For other handlings, see Blyth, "Handkerchief Magic", pp. 39-42; Hugard, "Silken Sorcery", pp. 69-70 (including a version in which one hank becomes tied around another); and Rice, "More Naughty Silks", Nos. 6, 35 and 62.

The knot can be tied during act of tossing hank into air, on floor, or over back of head. See No. 62 above for a transposition effect using the one-hand tie. Rice suggests (No. 36) tying a one-hand knot in a silk, then shaking silk gently by one corner. The loose knot will travel slowly downward, getting smaller and smaller, until it slips off lower end.

64. Quick tie. Hank is held by opposite corners. A knot is formed with lightning speed by bringing hands quickly together, then apart. There are several methods. For one, see "Tarbell", Vol. 1, p. 357 (Blyth gives this method on p.37 of "Handkerchief Magic", but in describing how ends are grasped to form knot, he incorrectly says to use first and second fingers instead of second and third). A second method is given in Hugard, "Silken Sorcery", p. 67 and Rice, "More Naughty Silks", No. 2.

A third method begins by displaying hank as in Fig. 417. As the hands start to move together, left thumb goes under cloth. The hands then come together as shown in Fig. 418. Each end is seized by thumb and middle finger of other hand. If you



## COMMENTS AND ADDITIONS

Source:

Date:

wish, you need not keep third and fourth fingers bent back as shown - in which case a firmer grip on each end can be obtained by the thumb and the third and fourth fingers together.

As in previous flourish, this knot may be tied while throwing hank over the head, on the floor, or in the air. See No. 61 above for a trick in which this flourish is used.

65. Simultaneous one-hand knots at each end of a single hank. Described in Blyth, "Handkerchief Magic", p. 42; Hugard, "Silken Sorcery", p. 67; and Rice, "More Naughty Silks", No.15.

66. Move-up knots. Two hanks are held side by side. Each hand simultaneously knots an end of one hank around the other. When the two free ends are pulled, the knots draw slowly together - a pretty effect if silks of contrasting colors are used. See Hugard, "Silken Sorcery", p. 68, or Rice, "More Naughty Silks," No. 60.

67. Lapilato's quick knot. Each of two hanks are tied in a circle. One is pulled through the other. When this is repeated, the hanks suddenly become knotted together. "Tarbell", Vol. 5, p. 103.

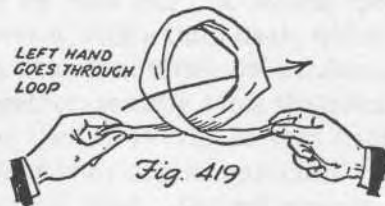

68. Quick knot on one wrist. Hold opposite ends of hank. Throw a loop in the air with right hand (Fig. 419) then plunge left hand forward through it. This ties knot around left wrist. Release the ends simultaneously with the tying. For two slightly different handlings, see Rice, "More Naughty Silks", No. 17.

69. Quick knot on both wrists. Magician holds opposite ends of hank, then turns his body slowly around in a complete circle. When he faces audience once more, hank is seen tied in a single knot around both wrists. To learn the move, have your wrists tied as in Fig. 420. Seize an end with each

## COMMENTS AND ADDITIONS

Source:

Date:

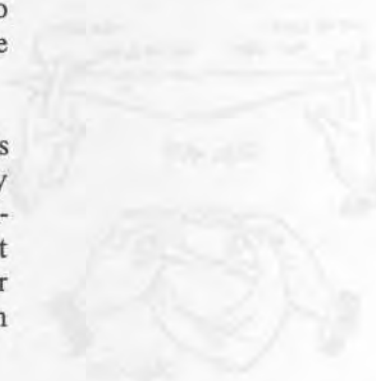

hand and slowly take hands apart. This unties the knot. To tie knot, reverse these moves, releasing ends as soon as knot is pulled tight.

An effective variation is to stand with back facing audience, and hank held behind back. Make a full turn with the body, tying wrists together as soon as hands are out of sight.

When your back is toward audience again, the wrists are seen to be securely tied.



*Fig. 420*

70. Miller's Four-in-hand knot. See Rice, "More Naughty Silks", No. 16. The flourish quickly ties a knot resembling a necktie four-in-hand.

#### Knot Puzzles

71. Problem: hold hank by opposite ends and tie knots without letting go of either end. Solutions: (1) Tie either of the wrist knots described above (Nos. 68 and 69). (2) Stretch hank on table, or have spectator hold it by opposite ends. Fold your arms, seize an end in each hand, then unfold arms to form knot. (3) Have spectator hold hank so it hangs in a loop, then grasp each end as in Fig. 421. If done quickly, spectators will have difficult time duplicating the feat. (4) Other methods, involving concealed sleights, will be listed later under ROPE. Some of these methods are applicable to large hanks.



*Fig. 421*

72. A large hank (a scarf is even better) is placed on table as in Fig. 422. Right hand grasps end B.

#### COMMENTS AND ADDITIONS

Source:

Date:

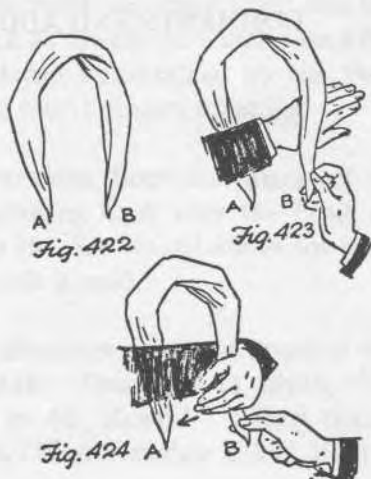

Tell spectators to observe closely how you tie a knot. Slide left hand beneath, palm down (Fig. 423). Pause, so spectators can take note of exactly how the move begins. Now quickly rotate hand back as in Fig. 424 to pick up end A. Separate hands and knot forms. For some reason, this move is exceedingly difficult for spectators to recall - particularly if you emphasize fact that it begins by moving left hand forward, palm down. An excellent party puzzler. You can demonstrate it repeatedly and spectators are still unable to do it. (Rice, "More Naughty Silks", No. 45).

73. Similar to above, but different method. Stretch hank in a straight line on table. Place right hand, palm up, on center (Fig. 425). Left hand picks up end B and carries it across palm to position of Fig. 426. Turn right hand palm down and move it to left where it clips end A with first two fingers. Separate hands to form knot. This seldom puzzles spectators, but if executed with great speed, makes a pretty flourish.

74. Exhibit three hanks tied in a chain (Fig. 427). Problem: get hank A tied between B and C without untying a knot. Done by tying A and C together to form a circle.

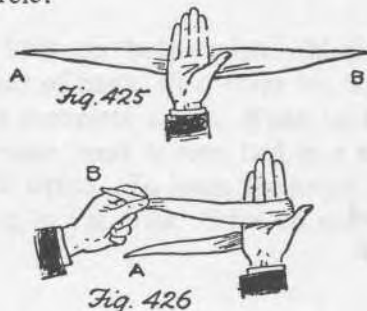

## COMMENTS AND ADDITIONS

Source:

Date:





Fig. 427

## Gags

75. **Zombie face.** Spread hank over face. Put spectacles on, outside of hank. Stick cigar or cigarette in mouth and puff it through the cloth. (Fig. 428).

76. Say, "Here's a good gag", then hold a stretched hank over spectator's mouth as though about to tie a gag around his head. Or, if you prefer, start stuffing hank into your mouth.



Fig. 428



Fig. 429

77. If a portion of hank is soaked in lighter fluid, you can set fire to it without damaging cloth. Keep waving hank about while flame is burning. It will go out quickly.

78. **Bouncing hank.** Comic wipes his face with hank, throws it on floor. It bounces back into his hand. Accomplished by small rubber ball of good quality, placed in center of hank and held by rubber band (Fig. 429). Silk must be used.

79. Toss hank over left hand. Right fingers take center of cloth. Lift it upward in a series of small lifts, and as you do so, something seems to be materializing beneath it, growing higher and higher with each lift. Actually, it is nothing more than your left thumb, which you keep raising. Whip away hank, wiggle thumb, and say "What did you expect — a miracle?" Index finger can be used instead of thumb.

80. Announce that you will put a dry hank inside an empty glass and it will "come out wringing." Take it out, shake it, ringing a jingle-bell you have secretly wrapped up in hank.

## COMMENTS AND ADDITIONS

Source:

Date:

81. You have a hank previously glued together in a ball. Borrow a hank from someone in audience, switch for glued hank. As you pull the glued hank open, look at spectator and say, "I asked for a clean handkerchief."

81a. Make a series of careful folds in hank, with mysterious passes, as though you are about to do something important. Finish with a folded hank that you simply tuck in upper pocket of jacket.

81b. Ask everyone in audience to take out a hank and follow your folds. Make a series of simple folds, then finish by picking up corner of hank and waving it in air as you say "Bye bye" and make your exit at end of act.

81c. Charlie Manna's famous nightclub routine, using only a handkerchief as a prop, is given in Walter Gardener's article, "In the Manna Manner," "Rogue", December, 1961, p. 73.

#### Folds

The basic reference on handkerchief folding is Tom Osborne's "Napkin Folding", 1945 (a revised edition of his "Fun at Dinner with Napkin Folds," 1943). Although Osborne presents his material as employing cloth napkins, most of it is applicable to pocket handkerchiefs. A more recent work: "Fun with a Handkerchief" by Philip Willmarth.

For a collection of 29 animals, dolls, human figures, and other objects that can be formed out of a handkerchief (with the aid of knots, rubber bands, and string), see Frances E. Jacobs, "Out of a Handkerchief", 1942. See also Osborne's booklet for methods of forming a doll, chick, turkey, nun, parasol, and candlestick holder.

The folding of cloth napkins into interesting shapes and designs is a European art that has a considerable literature going back as far as the Renaissance. Although handkerchiefs can be used for these constructions, it seems out of place to discuss this literature here. A few such designs are included in Osborne's booklet - rosette, tulip, rosebud, bouquet, roll, and crown. An early U.S. work on

#### COMMENTS AND ADDITIONS

Source:

Date:



this topic is Georgiana C. Clark's "Dinner Napkins and How to Fold Them" (Dick and Fitzgerald). A Bengalese waiter's napkin swan is pictured in "Life", April 2, 1949.

The following is intended as a check list of the more interesting hank folds, with reference to where a full description may be found. A few items, not yet recorded, will be described briefly.

82. The mouse. The greatest of all hank folds, and an excellent parlor stunt for small children. It will be found described in Blyth, "Handkerchief Magic", p. 17 and Osborne, "Napkin Folding", p. 6. In the process of forming the mouse Frank Garcia likes to pause at one point (just before the head and tail ends are pulled out of the roll) to exhibit what he calls a small flat iron (Fig. 433). Then one end is pulled out to form a tea kettle (Fig. 434). Pull out other end, and form mouse.

Before animating the mouse, stroke his back a few times and pretend to talk to him. While the



stroking right hand is cupped over the mouse, the middle finger of left hand can make his tail wiggle realistically by jiggling it at the base. As you continue to stroke mouse's back, left fingers jump him slightly to left. Catch him with the right hand before he has moved more than a few inches, and bring him back to former position on left palm. Repeat this several times, as though mouse were trying to jump out of your grasp. Then make the mouse jump completely out of your hand. Children squeal with delight if you cause mouse to jump six feet or so into their lap.

You also can make mouse jump against left arm, where you can retrieve him easily. Another amusing bit is to have mouse jump over your left shoulder, your right hand catching him by the tail and pulling him back over the shoulder into view. Although mouse appears to make this jump, actually you quickly lift him to the shoulder with right hand, allowing him to fall on other side while

## COMMENTS AND ADDITIONS

Source:

Date:

you catch the tip of his tail. You can also make mouse seem to crawl around the back of your neck. Act as though trying to drag him back, but actually push him around the neck with right hand. Seize him on other side of neck with left hand.

As a finish, have a child hold head of mouse while you pull on tail. This pulls hank out straight. Or, tell children it is a fortune-telling mouse, and have two youngsters pull it apart slowly. The end that pulls out first, you explain, indicates the person holding it will be first to marry.

The jumping mouse is very old; it would be interesting to know when and where it first appeared in print. Isa Bowman, in her "Story of Lewis Carroll", writes that Carroll liked to make a jumping mouse out of a handkerchief and do other handkerchief tricks "better than anyone I ever saw." The stunt is a favorite of the critic Edmund Wilson, who has always been interested in magic and is also an accomplished Punch-and-Judy operator.

COMMENTS AND ADDITIONS

Source:

Date:

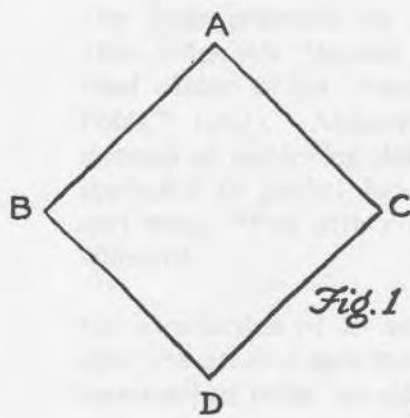

Fig. 1

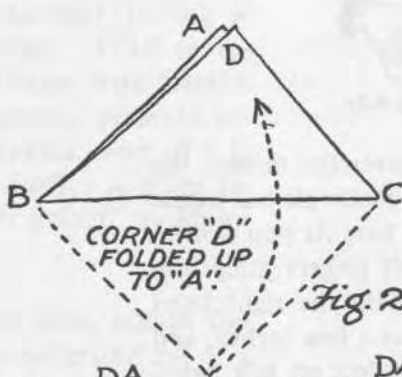

Fig. 2

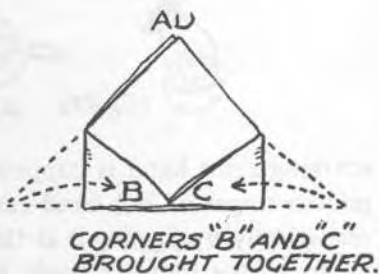

Fig. 3

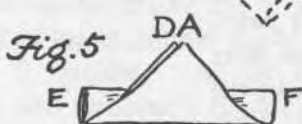

Fig. 5



Fig. 6



Fig. 7

ROLL ONCE AGAIN TOWARD CORNER AND THEN TUCK IN THE CORNER AS SHOWN BY ARROW.

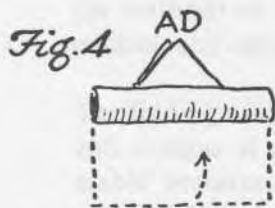

Fig. 4

ROLL UP LOWER PART TO ABOUT THREE INCHES FROM CORNER "AD".

HANDKERCHIEF TURNED OVER SO THAT THE ROLL IS ON THE FAR SIDE

FOLD ENDS "E" AND "F" TO MEET.



Fig. 8

THUMBS GO INTO POCKET AND TURN ROLL INSIDE OUT UNTIL ENDS SHOW.



Fig. 9

HOLDING BODY, PULL THE ENDS OUT GENTLY.



Fig. 10

TIE KNOT TO MAKE HEAD. MIDDLE FINGER ACTIVATES "JUMP."



Stewart Judah had a brilliant idea that adds so much to the presentation of the mouse that I have carried a watchwinder in my pocket ever since Judah mentioned it in the "New Phoenix", No. 319, in 1954. After making the mouse, explain that you now have to wind him up to make him jump. Reach into your pocket for the "key", coming out with the winder palmed but pretending to hold an invisible key between thumb and finger.

Pretend to push the key into side of mouse, then "wind" the mouse with the usual sound effects. Pretend to pull out the key and drop it back into your coat pocket. If it falls with a clank, so much the better. Or you can carry an actual key in pocket which you push between mouse and hand and pretend to wind with the concealed winder. After the mouse has jumped a while it can start jumping slowly, as though running down, so you have to wind it a second time. If a child tries to make mouse jump and can't, explain that he's "all run down."

83. Twins in a cradle. Probably the most widely known hank fold. See Osborne, p. 4.

84. The brassiere. Osborne, p. 2. Can be presented as imitation of a Hollywood movie queen, or of a cat by putting it on top of head to make ears.

85. Dancing girl who pirouettes and high kicks. Osborne, p. 8. Described with rhymed patter in "Greater Magic", p. 611, and Thompson, "My Best", p. 319.

86. The girl with dress, skirt, and panties. Osborne, p. 10.

87. Turbaned Hindu boy's head. Osborne, p. 12. Bert Allerton has long used this in his table routine, forming the Hindu from a piece of cloth stained brown at spot which later becomes boy's face. After completing the fold, Bert inks in the features, then pushes a long pin, with beaded head, down through turban. This locks the folds, and bead forms a jewel in turban. A small safety pin goes on the back to complete a novel lapel pin which Bert gives to a lady for a souvenir. See Bert Allerton, "The Close-up Magician", p. 52.

## COMMENTS AND ADDITIONS

Source:

Date:





88. The rabbit. Osborne, p. 14. Rabbit can be fed bread crumbs, or better, oyster crackers which crunch noisily when he chews them. A funny bit is to have rabbit pull a flower from your lapel and chew it while resting in crotch of left arm. Gag vanish: put rabbit in a hat. Remove the hank with a flourish, show both sides, then dramatically reveal hat to be empty.

89. Finger puppet. This has several forms, one of which is given by Osborne, p. 18. (In Osborne's description it should be pointed out that knot at A is made with both corners of hank.) Frank Rigney likes to roll squares of paper into cylinders, then bending the ends to make feet. (Fig. 435). Slip them on the fingers before winding the hank, so hank will hold them in place.



90. See Blyth, "Handkerchief Magic", p. 19, for a simply made hank puppet, with several presentation suggestions. It is formed by tying a knot near one corner. The tip of index finger goes into knot, and hank is draped over hand. Projecting thumb and middle finger form the arms. To make puppet more realistic, add features with lipstick, and a rubber band to keep cloth in place (Fig. 436).

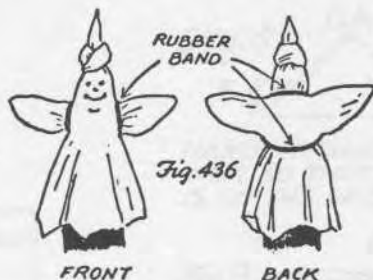

For children, the puppet can be worked into many magic tricks as an assistant or even the magician. For example, he can assist in overhand shuffling a deck of cards (Fig. 437), fanning them, adjusting the fan, and so on. He can peek over edge of fan (Fig. 438) to inspect the backs, or he can search

## COMMENTS AND ADDITIONS

Source:

Date:



Fig. 437

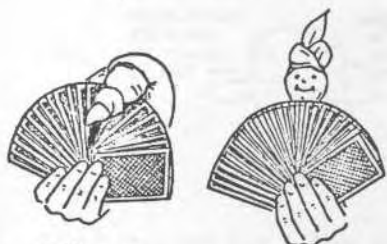

Fig. 438

Fig. 439

behind fan for selected card, occasionally peeking up to look at spectators (Fig. 439). Let him lift up a card from the fan, then change his mind and push it down again, finally lifting out and turning around the correct card.

An effective trick is to have puppet fan deck for selection of two cards. Cards are replaced in center, puppet closes fan, while you hold a pinkie break between the two cards. Puppet squares up deck by patting it on all sides, then he cuts it at the break. Puppet fans deck with backs to audience, pretends to look for two cards, but keeps pulling up wrong ones. Finally, he closes deck, tosses it on table, his arms retaining top and bottom cards. These are shown to be the chosen ones.

Innumerable routines with amusing bits of by-play can be worked out—not only with cards, but other magic as well. They are very effective with audiences of children, and the impromptu method of making the puppet is an added fascination.

91. Crying baby. This easily formed puppet can be animated to resemble a crying, kicking baby. Osborne, p. 40.

92. For two methods of knotting hank to make a cloth cap for a child, see Blyth, "Handkerchief Magic", pps. 22 and 23.

93. Parachute toy. Blyth, p. 21.

## COMMENTS AND ADDITIONS

Source:

Date:



94. Blackjack. Fold hank in half twice (Fig. 440). The three upper corners are rolled into a tight cylinder (Fig. 441). By bending the cylinder in the middle you can continue rolling it with the fingers to form the tightly rolled "blackjack" pictured in Fig. 442. Fairly well known to American school children, who sometimes play a game by striking each other until one hank comes unrolled, making other child the winner.

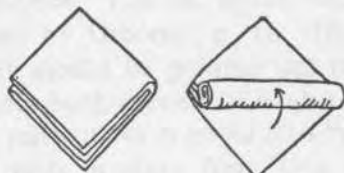

Fig. 440

Fig. 441



Fig. 442

95. Braided hank. Begin by folding one side of a corner forward a fourth of an inch (Fig. 443), then back a fourth-inch on other side (Fig. 444). Crease the folds sharply. Continue this process,



Fig. 443



Fig. 444



Fig. 445

alternately folding one side forward, the other back. Produces an attractive braided effect, the braids getting larger and larger. Fig. 445 shows the final curious result.

96. Gordian knots. Osborne, p. 32, gives two methods for forming hank into a tight ball, of such unusual character that it cannot be undone unless you know the secret. Osborne's second method appears in several old books (e.g., "Magician's Own Book", p. 12).

## COMMENTS AND ADDITIONS

Source:

Date:



## HAT

## COMMENTS AND ADDITIONS

1. Remove the crease from a fedora. Hold hat as in Fig.446, palms of each hand facing outward. Blow on top of hat, at same time pressing outward with the fingertips of both hands. Crease will appear as though blown into the hat. Others are unable to do it.

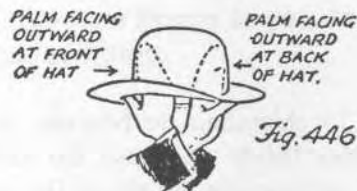

2. Wand through hat. This startling penetration can be done impromptu with a cane or even a long pencil. The cane goes behind hat, but inside a fold, so it appears to penetrate crown. See "Tarbell 5", p. 106, for detailed description.

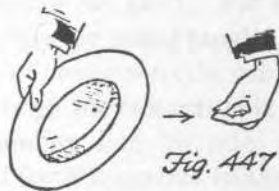

3. Right hand holds brim as in Fig. 447, while left pretends to pull an invisible elastic out from inside of hat. Left finger and thumb open suddenly. A loud snap is heard, as though the elastic snapped back into hat. Sound is made by right ring finger, which snaps off middle finger against back of brim.

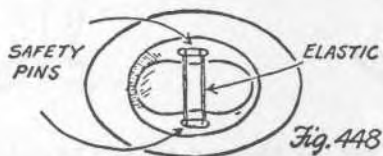

4. Rising hat. Stretch a rubber band across inside of brim, from side to side, looping the ends over small safety pins fastened to sweat band (Fig. 448). Pull hat tightly on head to make it stay down. If you raise eyebrows several times, it will wiggle the scalp and release hat. The elastic makes hat rise slowly for several inches, then wobble back and forth ludicrously. Pull gag while shaking hands on street, or after just entering a house, keeping a straight face as though unaware

Source:

Date:

of hat's antics. If loose fitting hat is used, you can pull it down, holding each side of brim, then release it. Hat shoots up into the air, where you catch it at the top of its rise. For this effect it is best to use two rubber bands across brim, one toward the front and other toward the back, to give it stronger spring.

5. Many restaurants and hotel lobbies have large rectangular pillars with mirror surfaces. Stand behind one, with your nose pressed against corner edge, so that half your body is exposed to spectators. The mirror reflection appears to be your other half. Raise your exposed hand and pretend to blow on the thumb. At same time, your concealed hand lifts hat upward (Fig. 449). Take care to keep hat horizontal. Looks as if hat shoots up with no visible cause. Take thumb from mouth and let hat settle slowly back on head. Surprisingly, many intelligent people are completely mystified by this stunt.

Additional comedy is obtained by looking toward pillar (which makes you look cross-eyed), and lifting the exposed leg (which makes both legs appear to go up like a jumping-jack's). Rolling the eyes makes them appear to revolve in opposite directions!



6. Audley Walsh calls this to my attention. Hold each side of brim as in Fig. 450, the middle fingers beneath brim. As you place hat on head, middle fingers snap it upward. Catch it a foot or so above head and repeat.

## COMMENTS AND ADDITIONS

Source:

Date:



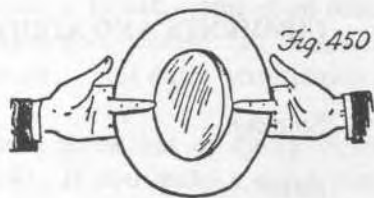

7. If hat has stiff brim, you can lean back against wall and hat will be levered upward several inches in front. Blow on fingers as you do this, making hat rise and fall slowly.

8. Wax is smeared on underside of back end of brim. Take off hat, look about vainly for a hat rack, then off-handedly proceed to hang hat on blank wall by pressing waxed brim against wall (Audley Walsh).

9. Take off hat (it must be stiff-brimmed) and place edge of brim against outside of left trouser pocket. Your left hand, inside the pocket, grips brim through the cloth. Put right hand in pocket. Hat can now be rolled rapidly back and forth from one side of trousers to the other, the hands holding brim through the trousers (Fig. 451). Two or more men, standing side by side, can roll hat rapidly back and forth from one to the other.

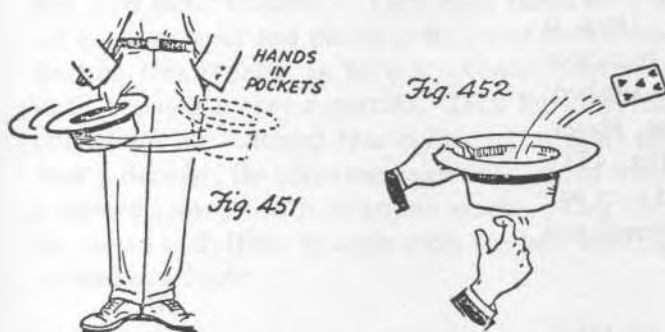

10. Selected card is brought to top of deck. Place deck in fedora, putting pack on one side of center crease and chosen card on other side. Hold hat in left hand while right finger snaps the crown directly beneath single card. Card jumps out of hat (Fig. 452). This principle can be applied in many other ways – snapping out marked cigarette, a particular paper pellet, and so on.

11. Two hats and four paper balls. There are many variations both in effect and handling. Usually,

## COMMENTS AND ADDITIONS

Source:

Date:

four paper balls are placed in square formation on table. One at a time they are beneath table and caused to penetrate table until all four are assembled under one hat. This is same as coin effect No. 20, which may be consulted for references. Another version begins with all the balls beneath one hat, then one at a time they pass over to the other. See "Tarbell 5", p. 30, for Silent Mora's handling of this. Mora uses four marbles, performing on tablecloth to prevent "talking." Paper balls have the advantage of being impromptu, as well as neither "talking" nor rolling. A clean, simple routine appears in "The Magic World of Stewart Judah", p. 7.



12. Charles Way's vanishing card. Selected card is returned to deck and brought to top. Deck is covered for a moment with hat. When spectator looks through deck, chosen card has vanished. Accomplished by pencil, with wax on eraser. Pencil is gripped through top of hat (Fig. 453). When deck is covered, end of pencil picks up top card. Hat is brought to table edge and pencil and card are lapped.

13. Three hats are placed brim down on table. Exhibit piece of bread, place it in mouth, and announce you will cause it to go beneath any designated hat. Simply place the hat on your head.

Variant: Turn back and ask someone (really a stooge) to hide piece of bread wherever he wishes and you will make it appear under whichever hat is picked. Stooge eats bread to play joke on you. Turn around, put selected hat on his head.

14. Immediately before entering a house, blow

## COMMENTS AND ADDITIONS

Source:

Date:

cigar smoke into hat, clamp it on head. A moment later, when you remove hat, wisps of smoke rise from the air. "Hot day," you remark.

15. Place a straw hat or derby sideways on head (Fig. 454). If you make a quick quarter-turn and start walking away, the hat will drop down correctly on head (Fig. 455). Start turning body first, then whip head around.



Fig. 454



Fig. 455

16. Hat is placed on floor against wall. Now remove it and ask someone to place fingertip on wall to mark how high they think hat was. He usually overestimates hat's height, especially if a top hat is used.

17. Two men face each other. Simultaneously, each seizes the other's hat in right hand, removes it, and places it on his own head. This is repeated as rapidly as possible, over and over, until someone calls out "Reverse!" Then each seizes the hat on his own head and places it on other person, repeating this rapidly as before. Game continues until a player makes a mistake. Dick Buckley, the comedian, has featured this in his club routine for over a decade. He plays the game with a man from audience, always with hilarious results. Can also be played with three or more men, the hats shifting around in a circle.

18. The moron and the beer. An old comedy routine using a felt hat as principal prop. The moron's mother sends him out for a hat full of beer. The bartender takes hat, fills it to the brim from a tap (all this is pantomimed), hands it back. Moron says he wants more beer than this. "Where can I put it?" asks the bartender. "In here," says the moron, turning hat over and pushing down center of crown to form a hollow. Bartender now fills the depression with beer. Moron carries hat back to his mother, who complains that he didn't bring enough beer. "Oh, I got more over here," says moron, turning hat over again and pointing inside.

## COMMENTS AND ADDITIONS

Source:

Date:



19. W. C. Fields gags. In his movies, Fields often introduced comic byplay with his hat. Here are some examples: (a) Starts to put hat on head, but hat goes to one side, missing head completely. Fields looks frightened, reaches up to feel if head is still there. (b) Fields carries a cane over one shoulder. Puts hat on head, but misses and puts hat on end of cane. Hand feels head, fails to find hat. Looks behind him and all around, finally discovers hat on cane. (c) Fields is standing beneath a hat rack or a hook on wall. In putting hat on head, it goes on hook instead.

20. Table productions. A large object of some sort is loaded under hat while seated at table. When hat is lifted later, the production is startling. See GLASSES, No. 2, for a production of glass of water in this manner. Max Malini sometimes produced a real brick or cobblestone, sometimes a large chunk of ice. (Where Malini carried the ice remains a mystery to this day.) The load is usually made from lap while attention is focused on table by some type of strong misdirection. See Dai Vernon, "Malini and His Magic", p. 55 for comments in the ice production.

20a. The two sides of a creased felt hat can be used for forcing of objects, pellets, etc. Duplicates are on one side, gripped through the felt by one hand as legitimate pellets are dropped into hat, falling into other side. Shift grip, so you hold the legitimate pellets as spectator reaches into hat to draw out a duplicate.

20b. Bar bet. Place a hat over your friend's drink and bet a dime you can drink it without touching or moving hat. If he agrees, lift hat, down the drink, give him a dime.

20c. Sight gag as you leave a gathering. Secretly open sweat band while you exchange amenities. As you leave (perhaps with a comment on how nutty everyone is except yourself), put on hat. The open sweatband, of course, makes hat stand a few inches above your head.



## COMMENTS AND ADDITIONS

Source:

Date:



## Use of Thread

21. Audley Walsh says an old burlesque bit is to fasten a thread about 2½ feet long to crown of hat and other end to the collar in back of neck. Hat is held in right hand, the thread passing around the arm below the shoulder. If hat is spun to the right it will spin around in back of body and can be caught by either hand as it comes around in front again. Then left hand can spin hat to left, sending it back the way it came. By rotating the body as hat makes its first revolution, it can be allowed to spin around body a second time before it is caught. Hat can be worn on street, with thread fastened to back of overcoat collar, and the stunt presented at any time.

22. A long thread is attached to hat, other end fastened to table top. Toss hat on floor about ten feet to one side. Pick up imaginary rope from table and pretend to lasso hat. As you make motions of pulling hat toward you, seize the thread and actually draw hat across floor and up to your hands (Jack Miller).

23. Other comedy effects using thread will not be discussed here because they require too extensive preparation. Two examples will suffice.

(a) One comic sails hat forward. It spins high into the air, then returns to his hand like a boomerang. Second comic wants to try. He grabs hat, spins it forward in same manner, but instead of coming back to him, it sails into hand of first comic. Accomplished by long thread running from crown of hat to a spot on ceiling directly above first comic. (I have seen this done by circus clowns, the thread running all the way to top of tent.)

## COMMENTS AND ADDITIONS

Source:

Date:



Fig. 456



(b) Jack Miller passes this one on. Two parallel threads, about six inches apart, are stretched horizontally across room at a height several inches above performer's head. When he puts on hat, it goes on the threads where it remains suspended above his head (Fig. 456).

### HORN

1. Behind your back, in one hand, you secretly hold a small bicycle horn - - the type that honks when you squeeze. Other hand holds anything that looks like it might make a noise when you blow it; e.g., a rolled up sheet of paper. Put device to lips and pretend to blow it. Each time you puff out cheeks, honk horn behind you. Take device from lips, but keep puffing cheeks, synchronizing this with the horn sound, as if you have something in your mouth. This gets first laugh. Now stop puffing cheeks. The honks continue and your hand brings out the horn you have been concealing behind back for the second yock.

### ICE

1. An ice cube floats in glass of water. Problem: lift it with small piece of string. Must not touch cube with fingers, or knot string in any way. Solution: lay string over ice cube (Fig. 457). Shake plenty of salt on top of cube. In a few



Fig. 457

moments, cube will freeze to string and can be lifted easily. Wooden match, toothpick, or rubber band may be substituted for string.

2. Imitation of Eskimo relieving himself at North Pole. Hold fist in front of fly and let two ice cubes pop out of hand. (Johnny Paul)

### COMMENTS AND ADDITIONS

Source:

Date:

## KEY

## COMMENTS AND ADDITIONS

1. Large door key is placed on left palm as in Fig. 459. If hand is tilted slightly forward, key will rotate to position of Fig. 460. Practice until you can make key rotate slowly, due to imperceptible tilting of palm. While key is turning, hold other hand six inches to right (Fig. 460) and twist it with the key, as though hand were turning key without touching it.

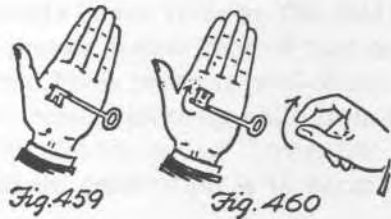

2. An eerie version of the turning key effect was contributed by Dr. Jaks to "Phoenix", January 11, 1952. A heavy key is balanced as in Fig. 461 on extreme tip of middle finger, the key's bit pointing toward you. As you concentrate on key, willing it to turn over, it will slowly rotate in direction of arrow. The position of hand depends on type of key. Experiment, tilting hand forward until you find a spot where the imperceptible quivering of the hand will cause key to rotate slowly. Also works on spectator's finger if you adjust his hand to exact position required.

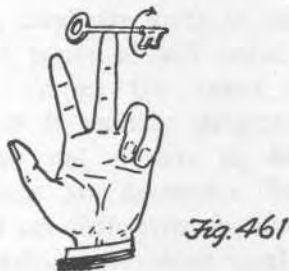

3. Six door keys, with ring handles, can be interlocked as in Fig. 462 and a glass or bottle balanced on top. From Tom Tit's "La Science Amusante", Vol. 1, p. 217.

4. A curious version of the dowsing rod principle is described in "The Secret Out", p. 223. Involves a large old-fashioned door key and a book tied shut around the key (Fig. 463).

Source:

Date:

## COMMENTS AND ADDITIONS

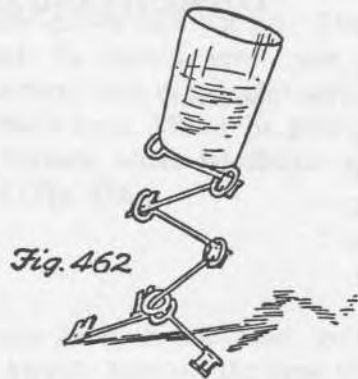

Fig. 462



FIG. 463

Two spectators balance the key's handle on the tips of their left forefingers as shown. The position is precarious, like a bent dowsing rod, with a tendency for a key and book to make a sudden quarter turn. Unconscious muscular action often causes key to turn at specified moments, e.g. on count of ten, or at a certain letter of alphabet. For some spectators, words can even be spelled out by reciting alphabet slowly until the turn indicates a letter, then repeating to get second letter, and so on. Modern keys are too small to hold a book suspended, but same effect can be achieved by hanging or tying a heavy object to key's bit.

## KNIFE, POCKET

1. Knife through coat. Borrowed coat is placed on back of open-backed chair. Magician stands behind chair, holding knife in right hand and folded sheet of newspaper in left. Right hand places knife behind coat while left holds the paper in front. Knife is apparently pushed through both coat and paper. There are many handlings.

A. Knife blade is first pushed through the paper, then right hand withdraws knife and goes behind coat. Actually, knife remains in back of the paper where blade is clipped by left thumb. Empty right hand goes behind coat, pushes against center of coat with tip of finger. This spot is covered in

Source:

Date:

front by the paper. Right hand grasps handle of knife through the cloth and forces blade through the paper, apparently having penetrated the cloth as well. See HMM, Oct., 1948, p. 475 where I described this version in detail.

B. Coat is placed on chair with back of coat to audience (Fig. 464). The fold behind collar will support a knife, where it is invisible to spectators. Right hand lowers knife behind coat, and in doing so, secretly leaves knife on this fold. Right index finger presses against back of coat as before, while left hand holds paper at level of coat collar. Left thumb secretly picks up knife from the fold, holding it behind the paper. Lower left hand to cover spot where penetration is to occur. Finish as before.

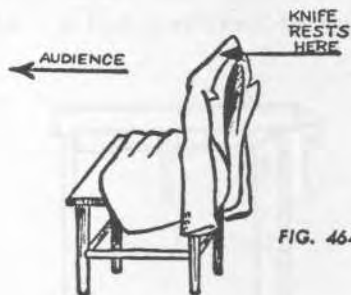

C. Both above versions can be done with borrowed knife (also with a pencil or fountain pen). In this handling, duplicate knife is used. It is concealed behind paper in left hand. Right hand unmistakably carries the other knife behind chair where it is secretly dropped into a side pocket of the coat — easy to do because the pocket openings are accessible from behind if coat is placed on chair with front of coat facing audience. Finish as in previous versions.

An effective presentation is to do the trick twice, using a different method each time.

2. Vincent Harrison's knife through coat. In this effect, the borrowed coat is held horizontally by two or more spectators. Knife goes beneath and is apparently pushed upward through center of coat and a piece of paper (or stage bill). The trick requires a specially prepared knife with a small blade that has been dulled. Before the final penetration

## COMMENTS AND ADDITIONS

Source:

Date:

of entire knife, this blade is actually shoved through the cloth without damaging it. Works only on loosely woven fabrics such as tweed. See "Tarbell" Vol. 5 p. 13, for complete description of several methods of handling.

3. Knife through hank. Two spectators hold a hank horizontally. Knife is pushed upward through the cloth and a piece of paper. There are two methods.

A. Knife is secretly transferred to left hand where it is concealed beneath the paper. Right hand goes under hank and simulates either handle of knife (by pushing upward with tip of finger) or the blade (by pushing a piece of toothpick against the cloth). For details see "Tarbell", Vol. 3, p. 326.

B. Jack Miller's method. Right hand actually places knife beneath hank, but it is tip of thumb which pushes center of cloth upward. First and second fingers hold tip of blade, and extend backward. This brings handle of knife to edge of hank where it is picked up by left fingers while left hand holds the paper near edge of cloth. See HMM, Oct., 1948, p. 475.

In both methods a coat of any type fabric may be used instead of a hank.

4. Sachs, in "Sleight of Hand", describes an effect in which cloth napkin or hank is wrapped around a man's arm. Magician saws a knife blade back and forth against the cloth, on underside of arm, until suddenly spectator feels the blade touching his skin! Actually, back of knife blade saws the cloth. A small pin is secretly pushed through the napkin and coat sleeve by magician's other hand, until the point touches spectator's flesh. See Sachs for detail.

5. Card location. Spectator inserts knife blade into deck. Lift upper half to show card on bottom. In doing so, the packet slides across point of blade, producing a scratch. Card can later be found by either sight or touch.

6. Card discoveries. An effective way of revealing chosen card or cards is by stabbing deck with a knife. The methods are too numerous to go into here.

## COMMENTS AND ADDITIONS

Source:

Date:





7. Opening knife with hank. Not recommended as a trick, because of dangerous features, but useful to know as an out-of-doors method for opening knife with badly stuck blade. Hank is twisted rope fashion, then wound tightly around knife. Free end of hank is twisted around a finger, and knife is thrown forcibly to ground as though spinning a top. Centrifugal force throws open the blade.

8. Many old magic books describe a stunt in which tip of knife blade is pushed into lintel of door (Fig. 465) and a bottle placed on floor directly below. Problem is to make knife fall into bottle by pounding lintel until knife drops. Done by letting water drip from knife, then placing bottle so the drops fall into it. With the bottle accurately placed, the knife is supposed to fall into it. Bruce Elliott once observed that this feat never works — a fact confirmed by my own experiments.

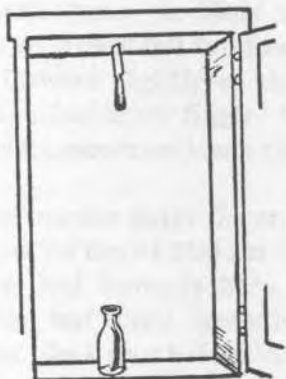

FIG. 465

9. Rising knife from bottle. This beautiful table effect is fully described in Sachs' "Sleight of Hand". A pocket knife is made to rise slowly out of empty bottle by means of thread attached to performer's coat. A loop in free end of thread goes over knife blade. As knife emerges, weight of handle causes it to topple and fall to table, automatically freeing it from the thread. See Sachs for details.

#### KNIFE, TABLE

1. The papers on the blade. The classic description of this great impromptu effect is in Sach's "Sleight of Hand", though it is also described in many earlier books. Six small pieces of paper are moistened with saliva and stuck to the blade of

#### COMMENTS AND ADDITIONS

Source:

Date:



a table knife, three pieces on each side. One at a time the pieces are removed by left thumb. A wave of the knife and all six return. Properly performed, it is one of the most startling of close-up effects.

The trick employs what has come to be called the "paddle move" (because of its similarity to a move used by pitchmen in demonstrating paddle tricks). Fig. 466 shows how move begins. Fig. 467 shows

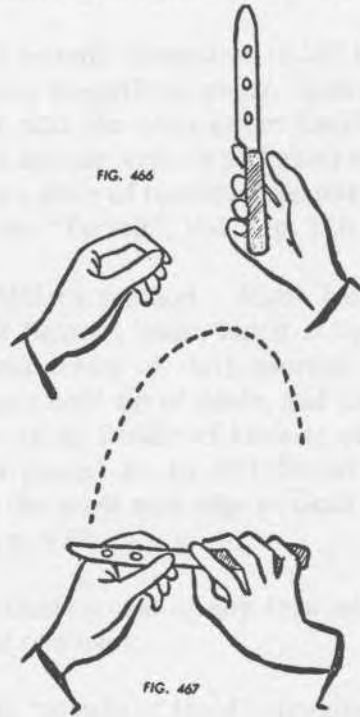

finish of move. Both sides of blade have apparently been shown. Actually, right thumb has given handle an extra turn so that same side of blade remains uppermost. The moves are reversed to bring knife back to Fig. 466. The right arm should not move at all. The hand simply turns at the wrist.

The secret of the move is that in moving from Fig. 466 to Fig. 467 the knife passes through an almost vertical position. The blade's tip describes a vertical arc indicated by dotted line in Fig. 467. If you do the move slowly you will see that at no time is the underside of blade visible to audience. Hence the move need not be made rapidly. It should be fast enough to hide the double turn, but slow enough to appear off-hand and natural. Although you will catch a glimpse of blade's underside, the spectators will not. The paddle move has other

## COMMENTS AND ADDITIONS

Source:

Date:



variations, but in my opinion this is the best. (In Sachs version, for example, the knife is not turned at all. Only the hand position is altered. This can be done effectively with a small pocket knife, but is difficult to apply to a large table knife.)

The trick is usually performed as follows. After the six pieces of paper have been placed on the blade, in full view of audience, both sides of blade are apparently shown. Actually, the paddle move is executed, even though unnecessary at this point. Otherwise, when the move is made later it will appear slightly different from a genuine turn.

Hold the knife as in Fig. 466 while left thumb removes the piece of paper nearest the handle. Lower left hand to your side and flick the paper from thumb with index finger, without calling attention to it. Raise left hand to position shown in Fig. 466. Make the paddle move. This brings knife to position of Fig. 467. Left thumb is raised while knife turns, so blade can be placed directly on top of curved left forefinger. Actually, tilt left hand forward slightly so that only inner edge of blade touches index finger. Otherwise the finger may displace pieces on lower side.

As soon as knife touches index finger, left thumb is lowered so it goes on top of blade at the blank spot where the paper had formerly been. This should be done casually, but timed carefully so audience does not see the blank spot before thumb is placed on it. The thumb now pretends to remove second piece of paper. Actually, it merely slides across vacant spot. The illusion is perfect if done skillfully. Lower left hand and pretend to flick off the piece. You may even pretend to have some difficulty in getting it off thumb, but don't overdo it.

Now do paddle move once or twice, calling attention to fact that four pieces of paper remain. The next two are apparently removed, using same procedure as before. Repeat paddle move to show that only two pieces remain.

The last two pieces are now apparently removed. If you wish, you can vary last removal by simply wiping base of left palm across entire blade, or by wiping blade against underside of left sleeve. Both sides are shown completely blank.

## COMMENTS AND ADDITIONS

Source:

Date:

The return of the papers may be dramatized several ways. You can wave knife quickly up and down, or from side to side, giving it a secret half turn. You can have spectator blow on blade, making the turn under cover of a sharp side to side motion. Or you can move knife to the left, passing it under left arm, then into view again with papers showing. If you do the latter, spectators often think you picked up extra pieces from underside of coat sleeve!

After the papers have returned, do paddle move a few times to show all six back again. When you wipe blade clean with left fingers, pretend to remove them from underside also, and toss all the papers on floor. As Sachs observes, if this is not done immediately, spectators are apt to notice pieces on the floor while all six are supposedly back on blade.

A further refinement of the effect can be achieved by moistening left thumb before you remove each piece. Pretend to flick the paper away, actually flicking the forefinger against lower part of thumb, leaving the piece undisturbed at tip of thumb. After faking next removal, this same piece can then be openly flicked from thumb. Better still, thumb may actually replace it on blade, then slide away without it. Will appear as if the paper is stuck so firmly to blade that it has to be removed with difficulty. This strategem need not be used each time, but if done at least once it is very convincing.

There are two faster handlings of the effect. One is to pretend to remove the papers in pairs, the thumb taking away upper piece while the forefinger removes the one directly beneath (actually leaving it on the blade). After each pair is supposedly removed, the paddle move is made to show both sides. A wave of the knife brings all six back again. Entire trick can be performed in less than ten seconds. For a good discussion of this mode of handling see "The Magic World of Stewart Judah", pages 76-81.

An even faster version is to remove all three pieces at once from one side of blade by wiping it against underside of left sleeve. The knife is ap-

## COMMENTS AND ADDITIONS

Source:

Date:



parently turned over and other side wiped clean by sleeve, but the paddle move is made so that sleeve goes over same side again. Show both sides of blade clean, then bring all six papers back again.

Some performers unduly prolong the trick after the papers have returned by making them vanish and reappear again. This is not only anti-climactic, but also tends to give away the method. Nor is anything gained by having the papers on underside a different color, except possibly when showing the trick to small children. For example, you can bring back blue pieces while child blows on knife. "You certainly blew those back," you can say. "Look how blue they are!"

2. Stewart Judah's knife and papers. This ingenious version, described with Judah's permission, has both an advantage and disadvantage over previous methods. The disadvantage is that spectators cannot watch you prepare blade. The advantage is that six pieces are actually removed, slowly and openly.

The secret lies in placing six pieces, instead of three, on underside of blade. Upper side has three pieces, each placed directly above one of the lower pieces (Fig. 468).

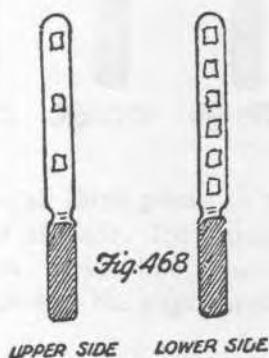

The six pieces can now be removed one at a time, and each piece shown. Slide lower piece off with tip of forefinger, then cleanly remove upper piece with thumb. Each piece is flicked away. After all three pairs are apparently removed, blade is shown empty on both sides by means of paddle move. Trick finishes in usual manner.

A further refinement enables you apparently to

## COMMENTS AND ADDITIONS

Source:

Date:



remove each piece separately from upper side of blade. The first piece is removed and openly flicked away. Make the double turn, placing left thumb on same spot as before and pretend to slide off second piece. As you do so, tip of forefinger slides off piece directly beneath. This piece is then shown and also flicked away. In other words, the six pieces are apparently removed one at a time from top of blade, and each piece shown before it is discarded. If you like, roll each piece into a tiny ball and bounce it off the palm — a gesture Gali Gali uses in performing his version of this effect. This prevents spectators from later finding the pieces on the floor, and also adds a dramatic touch.

3. Sliding papers. If pieces of newspaper are used, and moistened liberally on both sides with saliva, they will slide easily along the blade without coming off. This principle can be used to make the pieces alter their positions mysteriously. Many routines can be worked out. Here is a sample one:

Begin with pieces widely separated on both sides, (Fig. 469).

Show underside of blade to audience by raising knife to position of Fig. 470. Behind the blade, right thumb secretly slides piece A close to B.

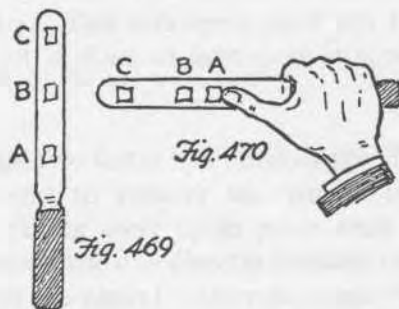

Apparently show both sides by means of paddle move, then wave knife, giving it a half-turn. This makes A seem to jump close to B. Do paddle move again. The jump seems to have occurred on both sides.

With left thumb, openly slide A back to former position. As you do this, tip of index finger secretly presses against B on underside. This auto-

## COMMENTS AND ADDITIONS

Source:

Date:



matically slides B down the blade toward A.

Do paddle move to show both sides then a quick half-turn followed by a paddle move again. Both B pieces seem to have jumped down the blade toward A (Fig. 471).

Left thumb slides B back to center of blade. At same time, forefinger beneath blade slides B up close to C.

Repeat former procedure to make B appear to jump toward C on both sides (Fig. 472).

Left thumb slides B back to center while forefinger beneath the blade slides C down close to B. Instead of showing this last change, however, hold up knife again as in Fig. 470 to show that pieces are widely separated. This enables you once more to slide A close to B with right thumb. Underside of blade now looks like Fig. 473.

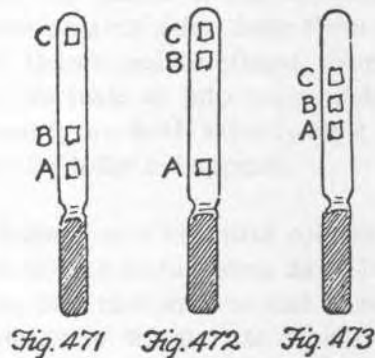

You now cause all three pieces to bunch close together at center of blade. Then jump them back to original position. If you like, you can now go into a routine of removing the papers and bringing them back again.

4. Effects with two knives. A table knife can be held in each hand and the paddle move made simultaneously with both knives. Obviously many different routines can be worked out in which the papers seem to jump back and forth from blade to blade.

Also, even though a knife is held in each hand, the thumb and finger of either hand are still able to re-

## COMMENTS AND ADDITIONS

Source:

Date:

move pieces from the knife in other hand. The two quickie versions described near the close of effect No. 1 are effective if performed with two knives. In the first of the two fast versions, the hands should alternate while apparently removing the pairs — first a pair from left knife, then a pair from right knife, and so on, making the paddle move simultaneously with both hands after each pair is removed. Nothing is gained, however, by performing more elaborate routines of this sort.

5. Catching salt on blade. Edward Victor, in one of his books, describes this novel effect. Upper side of knife blade is previously moistened with saliva. Shake some salt on the blade. Hold knife in right hand and pretend to dump the salt off the blade and into left hand. Actually, the salt sticks to blade. Close left hand as though holding the salt. Right hand shows both sides of blade to be clean by means of paddle move. Left hand pretends to toss salt into the air. Salt is then apparently caught on the blade by secretly giving knife a half-turn as you thrust it forward to catch the salt.

6. Walter Price, in Jan., 1946 issue of "Genii", contributed this table version of the above effect. Before showing shake a small pile of salt on tablecloth at a spot near you on the right. One spot of your napkin is wet. Pretend to dry both sides of knife blade, secretly touching wet portion of cloth to underside of blade. (Another way to moisten blade is to wet tip of left forefinger. Wipe left thumb across upper side of blade, then turn knife over and repeat on other side. This time, as thumb moves along blade, forefinger moistens underside.)

Reach for salt shaker with left hand. At same time, right hand lowers knife to table where the blade rests on the pile of salt. Some salt will stick to bottom of blade. Meanwhile, left hand shakes some salt on tablecloth directly in front of you. Take a pinch of this salt in left hand.

Make paddle move to show both sides of blade clean. Left hand tosses salt into air. Pretend to catch it on blade, secretly giving knife a half-turn to reveal the salt.

Pretend to wipe blade clean with left hand, actually reversing knife so left palm slides over clean side.

## COMMENTS AND ADDITIONS

Source:

Date:

Do paddle move once more. Then shake a small quantity of salt on top of the blade. Toss this salt high into the air, make one quick paddle move, then pretend to catch the salt as it comes down by giving blade a half-turn. Clean the blade with the napkin when trick is finished.

7. Pennies on blade, Bill McCaffrey, in "My Best", p. 174, describes a brilliant paddle routine using pennies. The coins are held on both sides of paddle by rubber bands. The routine is easily adapted to a wide table knife, and for thinner knives, dimes can be used.

A clean, simple version begins with the following preparation. Fold a dollar bill twice lengthwise to make a long narrow strip. Fasten it to underside of knife blade with three rubber bands. Under the bands (and on top of folded bill) put a penny, nickel and dime. Use paddle move to show both sides of knife empty. Put a penny, nickel and dime under the three bands, then "double your money" by doing the paddle move, apparently showing three coins on each side. Slide them off by pairs, with left thumb and forefinger, dropping the six coins to the table or into your pocket. Knife is shown empty on both sides (paddle move), then suddenly the dollar bill appears.

Charlie Miller has a beautiful routine that I hope will be published in full some day. He uses heavy paper, cut into neat squares, and attached to blade by dipping them in water (to avoid the unpleasant use of saliva), then blotting the blade with a napkin. By standing, and making the move so knife changes from a pointing-down to pointing-up position, everyone can see the blade. The reappearances and changes of position of the pieces of paper are made as the blade is tapped against the side of a glass. The routine concludes with a single piece vanishing from knife blade and found inside a spectator's closed fist.

8. Swallowing the table knife. This effect is seldom performed properly, thought it is one of the oldest and best of all dinner table tricks. Knife is first placed on edge of table and covered with both hands ( Fig. 474). Slide knife off the edge, then raise both hands to position of Fig. 475, tilting

## COMMENTS AND ADDITIONS

Source:

Date:

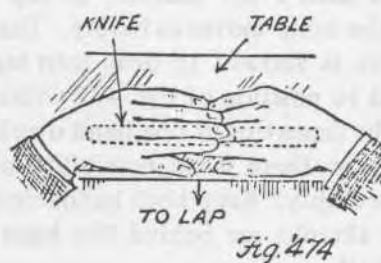



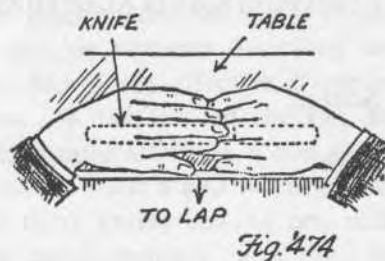

head back as shown. Act as if about to drop knife down the throat.

Cough as though slightly choked by the blade, and replace knife on table. Several excuses may be offered for this action. You can say the knife is too cold and proceed to warm it by polishing the blade with a napkin. Or you can pretend to salt the blade with a salt shaker. In any case, repeat exactly the same moves as before. This time, however, knife is allowed to drop into lap and hands are raised to position of Fig. 475 without it. Make certain the fingertips of one hand overlap the other as shown, so there is no possibility of seeing the hands are empty. Keep both hands rigid, and make sure the thumbs are behind the hands as though holding knife.

Pretend to drop knife into your open mouth by lowering both hands. Smack your lips and rub your palms together — an indirect way to prove both hands empty.

Someone is sure to ask what happened to knife. Sachs, in his lengthy description of this trick, thinks it best not to reproduce knife immediately. He suggests reaching for napkin in lap, and under cover of this gesture, putting knife behind knee

## COMMENTS AND ADDITIONS

Source:

Date:



where it is gripped by leg, or slipping it into the shoe. If leg is bent back and foot raised, the latter can be quickly accomplished. You now wipe lips with napkin, return it to lap, and later casually place napkin on table with knife beneath it. If knife is in shoe it is possible of course to stand and pull up both sleeves to prove knife is not on your person.

Another finish is to lower hands to lap, push knife up a sleeve, then raise arms and extract knife from sleeve. Spectators assume this is how trick was done, though if they try it, they will find it impossible.

In my opinion the best termination is to take knife from inside coat pocket. Left hand brings knife up under the coat and drops it partially into the pocket as right hand is opening coat. The withdrawal from the pocket can be made completely convincing.

A gag finish is to have a stooge across the table stand up and shake a table knife from his sleeve, while you unobtrusively replace yours on the table. A favorite prank at the Chicago Round Table is to persuade a visiting magician to do this trick. At the instant he laps knife, all other magicians at the table drop a knife on the floor!

9. Magnetized knife. This ancient stunt, in which knife clings to left hand while its wrist is squeezed by other hand, should not be neglected. It is still completely baffling to children, and often to adults as well. A good presentation is to start by laying knife on palm of left hand (Fig. 476). Right hand

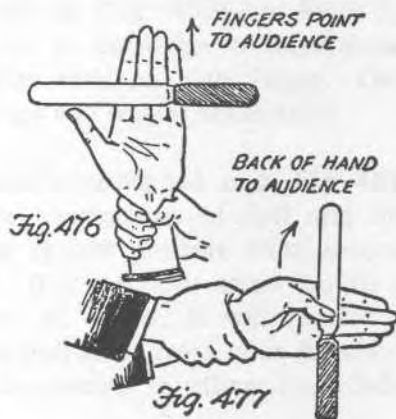

## COMMENTS AND ADDITIONS

Source:

Date:

holds wrist as shown. Grasp knife firmly with left thumb. Raise the hands to right side of body, rotating left hand as you do so, bringing the back of this hand toward audience. Right hand continues to hold the wrist, and left thumb continues to hold the knife against the hand (Fig. 477). Raise left thumb, allowing knife to fall to the table or floor.

Make an apology of some sort, such as that knife must be perfectly dry. Polish it with napkin. Now repeat same moves as before. This time, however, as hands are raised, right index finger is secretly extended behind left hand. Properly done, the move is invisible from the front.

Now, when left thumb is lifted, the knife clings mysteriously to the hand. It is held of course, by the tip of extended finger. Shake the hands vigorously to show how tightly it clings. Then let the knife, upon command, slide slowly downward by relaxing pressure with the finger. If you prefer, let it slide down in a series of short, jerky motions, finally dropping on the table.

10. A long pencil (or second knife) can be used for achieving an effect similar to above. The pencil should be in left sleeve, beneath wrist watch band (Fig. 478). Before doing the trick, pull it forward enough so it will support the knife.

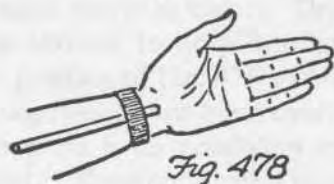

A good presentation is to pretend you are doing the old version. Grab wrist with right hand, keeping index finger in back of left hand so only three fingers are seen circling the wrist. Then, to every-

## COMMENTS AND ADDITIONS

Source:

Date:

one's surprise, remove your right hand and adjust the magnetized knife's position by pulling it up or pushing it down an inch or so. It continues, of course, to cling to the hand. Immediately bring right hand back to wrist again.

Finish by secretly pushing pencil back into sleeve with tip of right middle finger as you take knife in right hand. Or, more simply, take knife in right hand and lower left to lap where the fingers extract pencil from watch band and leave it on lap.

11. In this version of the magnetized knife, the hands are clasped as in Fig. 479 while the knife remains suspended behind them. It is held by a free middle finger in back. The fingers are interlaced in alternating fashion so missing finger is not noticeable from front.

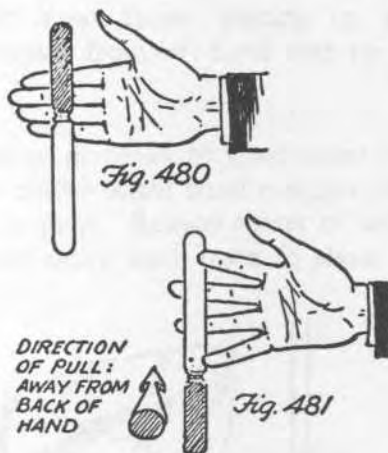

12. Right hand is held palm up and knife is placed across the fingers. Hand is slowly tilted until almost vertical (Fig. 480) but knife does not fall. Secret lies in the bulge or ridge at base of blade. This ridge rests on little finger. Only knives of right shape and weight are suitable.

13. Knife is suspended as in Fig. 481. It is kept in place by pressure of first and fourth fingers working against pressure from second and third fingers. If a spectator seizes handle and pulls in direction of arrow, it will require considerable force to pull knife from your fingers. This gives a strong impression to others that blade is stuck to

## COMMENTS AND ADDITIONS

Source:

Date:

fingers. See "Sphinx", Dec. 1951 for a handling attributed to Nate Leipzig of this and two similar variations.

14. Hold knife as in Fig. 482A, with bent wooden match resting on it as shown. Slight tremors of hand cause match to walk forward along tablecloth until it falls off end of blade. Wishbone, hairpin, etc., can be substituted for match.

Two joined matches (Fig. 482B) are more effective than single bent match. Match heads should touch table lightly.

15. Card location. Spectator inserts blade of knife into pack and notes card above it. As you lift upper half, note reflection on knife blade of card's index.

16. Fork is placed on knife as in Fig. 483. Adjust fork until knife balances on the rim at base of blade. Knife will now spin on table like a carnival spindle. See my booklet "Over the Coffee Cups" for a card effect in which this spinning knife is used (like the wind-up bird) for locating selected card when deck is spread in a complete circle

## COMMENTS AND ADDITIONS

Source:

Date:

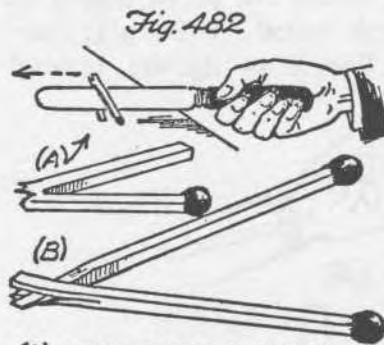

**(A) SINGLE MATCH BENT AND PLACED ON KNIFE AS SHOWN.**  
**(B) TWO MATCHES, TAPERED END OF ONE INSERTED IN SLIT MADE IN END OF SECOND MATCH.**



**Fig. 483**



**Fig. 484**

around knife.

17. A way to disclose selected card when it is in a row of cards on table (or which inverted cup covers an object, and all similar effects) is to balance knife on index finger (Fig. 484). Hand moves slowly along the row. When desired spot is reached, the blade dips mysteriously downward. Caused by an imperceptible forward rotation of hand.

18. Knife is rolled in cloth napkin by seated magician. When unrolled, knife has vanished. It is lapped by tilting rolled napkin, allowing knife to slide out.

19. Cloth napkin is draped over left arm (Fig. 485). Right hand holds knife as shown. Place knife behind cloth. Appear to put point of knife at spot "A" and lift napkin from left arm. Actually, as soon as knife is hidden, drop it down left sleeve. Extend right index finger, placing tip at point "A". Lift napkin from left hand with tip of finger.

Left hand now pretends to grasp point of knife through the cloth. Right hand emerges and takes a corner of napkin. Release center of cloth with left hand and shake hank open to show knife is gone.

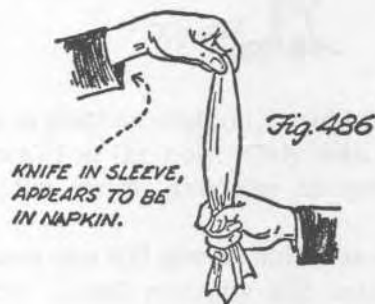
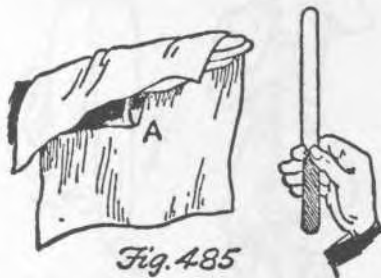

## COMMENTS AND ADDITIONS

Source:

Date:

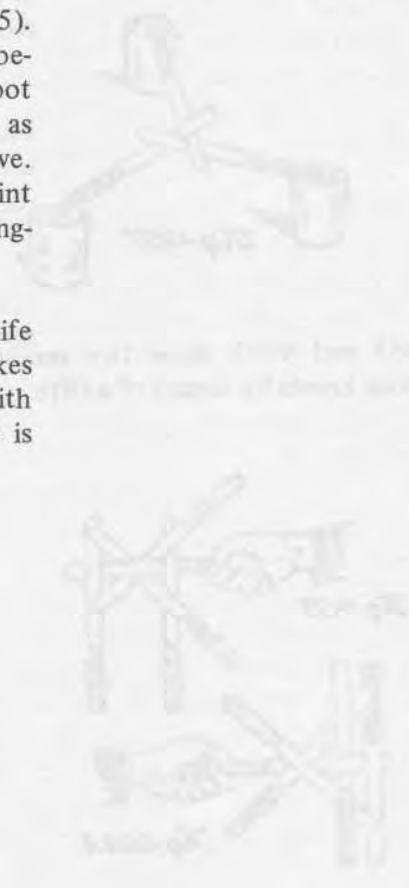



Another finish. Grasp cloth as in Fig. 486. If left hand pulls center of cloth upward, the napkin will remain erect after left hand releases it. Lower left hand, allowing knife to slide into it from sleeve.

Right hand turns napkin so it extends horizontally to the left. Turn to man at left and stab his chest with the extended cloth. Reach behind his body with left hand and produce knife.

#### COMMENTS AND ADDITIONS

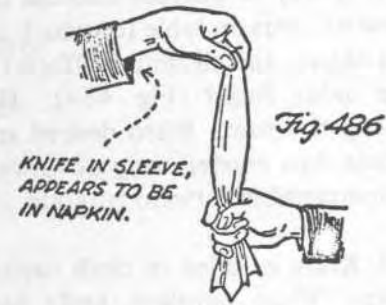

20. Fig. 487 shows how three knives can be balanced on three glasses. The crossed blade points will support a fourth glass. Four knives, on four glasses, can be interlocked in similar manner to support a heavy object.

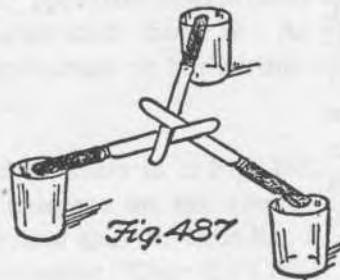

21. Figs. 488 and 488A show two methods of supporting four knives by means of a fifth.

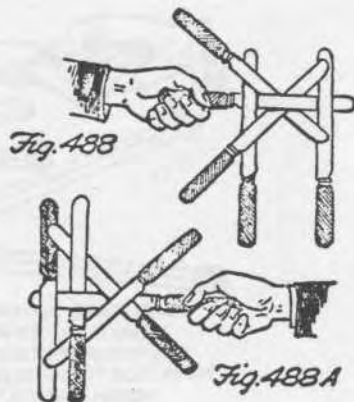

22. Fig. 489 shows how two knives can be crossed and held by thumb and index finger only. Spectators may study the position of your fingers carefully, but few will be able to duplicate.

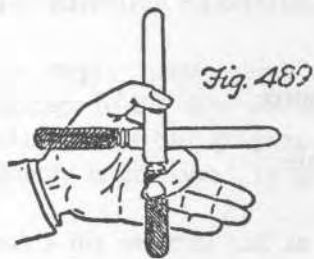

## COMMENTS AND ADDITIONS

Source:

Date:

## LEGS

1. Bend one leg at knee (Fig. 490). If leg is held loosely it is possible to spin it rapidly in a circle in either direction. Has a comical appearance from the front.
2. Spectator is told to stand with one side pressed against wall. Inside foot must touch wall. Ask him to raise outside leg. Impossible to do without falling.
3. If you can persuade someone to twist his legs around a pole or small tree as in Fig. 491, then



slide down to a sitting position, he will find himself securely locked to the pole. Only with great difficulty can the victim extricate himself unaided.

4. Announce you will give an imitation of man going upstairs. Stand perfectly still until someone says, "Well let's see it." You reply, "I'm on an escalator."

5. An imitation of man going downstairs can be given by walking behind a sofa (or similar obstruction), bending the knees a trifle more at each step. An amusing switch on this is to have a small step ladder secretly placed behind sofa. Do the "walking downstairs" bit, then repeat, stating you will now walk upstairs. This time, walk up the step ladder to everyone's surprise. Or have someone else, in on the gag, try to duplicate your downstairs bit, and find himself going up instead.

6. Funny walks. In the last few decades scores of hilarious methods of simply walking across a floor have been developed by stage comics. The Ritz brothers, for example, can entertain an audience for thirty minutes simply by walking across the stage in various preposterous ways. A description of these walks would make a valuable addition to the literature of stage comedy.

7. One lies on back, knees raised, trousers rolled so legs are bare to knees. Second man kneels astride the other, so that legs of reclining man appear to be his legs. Kneeling man should pull shirt from trousers and down over knees of the man on his back. From front, looks like a dwarf. Amusing effects are obtained by having man on back raise his legs, cross them, etc.

#### LEMON

1. Twist the corners of paper napkin and place it over a lemon. Spectators are unaware of what is beneath. By punching the "bug" with your finger, it will zig-zag over table top or across floor as though alive. Keep pushing it here and there to build up curiosity as to what type of curious device is beneath. Gets a laugh when someone lifts napkin and finds only a lemon. Eyes may be penciled on the "bug" as shown (Fig. 492).



#### COMMENTS AND ADDITIONS

Source:

Date:



## LIFE SAVERS

1. The empty space which extends the length of a package of life savers is large enough to take a rolled-up dollar bill, playing card, etc. The bill is vanished, later found in pack of life savers.

2. Break a life saver in half as cleanly as possible. Apply rubber cement to the broken ends. Let dry, then press halves together. Will stand close inspection. You can now perform what seems to be an impromptu version of the bolt on the string trick. Unprepared life saver is examined. Switch it for prepared one which is threaded on string. Under cover of hank, prepared life saver breaks apart noiselessly. Palm the pieces and attach unprepared life saver to string. Finish in usual manner.

Rubber cement is not essential. If broken ends are moistened with saliva they will stick fairly well, but cement method is safer.

## LIGHT BULB

1. A frosted bulb is held as in Fig. 493, with small flashlight concealed in hand behind it. Right fingers turn flashlight on and off. From front, looks as if the light comes from bulb. This enables you to unscrew a bulb from lamp at friend's house, and use it as you would a self-lighting bulb.



2. Sight bit. Hold base of bulb against each ear and say, "take me to your leader."

## LIGHT SWITCH

1. When you walk with others into a darkened room, pretend to flip light switch but actually pull it only part way and let it snap back. Repeat several times. Sounds as if you are throwing the switch. Remark that bulb must have burned out. You, however, are a magician. Lean across the switch, hiding it with your body, and press a spot

## COMMENTS AND ADDITIONS

Source:

Date:

high on wall. As you press spot, other hand secretly flips switch, turning on light. (Tommy Vander-schmidt, in "Phoenix", 1953). Or stand in front of switch, hand behind you. As you twist your nose to one side, hand in back switches on light.

### LIPSTICK

1. The metal cover of small lipstick container provides excellent substitute for thumb tip. In some ways it is superior, as there is more space between end of container and tip of thumb or finger. If called on to perform, and you do not have a thumb tip with you, you can still do almost any thumb tip trick by borrowing a lipstick container from a lady, returning it to her later. She will not know what use you made of it. The cover can also be used like a thimble for performing many tricks listed under THIMBLE.

2. Ask victim if he would like to have his palm "read". When he extends his hand, smear palm with lipstick. His palm is now "red".

### MAGAZINE

Many of the principles listed earlier under BOOKS can be applied to magazine mental tests, but so many methods have been published for magazine tests (most of them requiring considerable preparation) that no attempt will be made to list any here. Nor will we cover the many methods (also requiring preparation) for tearing and restoring a magazine.

1. Frank Rigney calls my attention to fact that many unusual designs can be formed by bending (not folding) the pages of an open magazine in various ways. Fig. 494 shows two ways a page can be bent. Method B can be done with either corner of page. By bending a group of pages near center of magazine (using one method only, or alternating different ways of bending), a variety of interesting patterns will result (Fig. 495). A pleasant pastime for small children.

### COMMENTS AND ADDITIONS

Source:

Date:





ROLL ALL PAGES INTO CENTER  
(1ST METHOD)

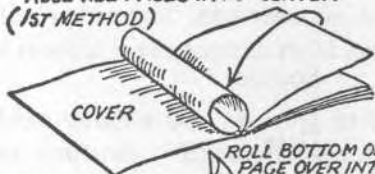

Fig. 494

ROLL BOTTOM OF  
PAGE OVER INTO  
CENTER.



(2ND METHOD)

ROLL BENT PAGE OVER  
ON TO FRONT COVER.  
CONTINUE BENDING PAGES AND ROLLING  
THEM TO THE LEFT. FOR VARIETY BEND  
ALTERNATELY TO CENTER FROM TOP  
AND BOTTOM CORNERS.

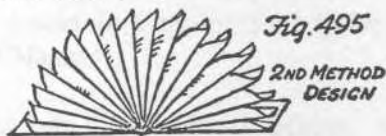

Fig. 495

2ND METHOD  
DESIGN

DESIGN MAY BE VARIED ALSO BY  
ALTERNATING CORNER BENDINGS  
WITH PLAIN ROLLED PAGES.

## COMMENTS AND ADDITIONS

Source:

Date:

## MAPLE SEED

1. When dropped, twirls like blade of helicopter.
2. Children split the bulbous part, attach to tip of nose to make a "polly nose."
3. Put it against roof of mouth near teeth, touch with tip of tongue, and hiss to make sound like those Punch-and-Judy whistles sold by novelty stores.
4. Attach several to eraser end of pencil by sticking pin through them and into eraser. Makes a pin-wheel that spins when waved through air.

## MARBLES

1. A row of marbles resting on a groove (Fig. 496) will furnish a simple demonstration of transmission of energy. If a single marble is rolled against one end of row, a single marble rolls away from other



Fig. 496

end. Two marbles rolled against the row sends two marbles from other end, and so on.

2. Spectator is given a number of marbles of different colors. Turn your back and ask him to place a marble in your left hand, which you place behind back. Right hand must be in trouser pocket and coat unbuttoned. This brings back of coat pocket's opening far enough back so that marble (clipped by first and second fingers of left hand) can be secretly dropped into the pocket (Fig. 497).



Take right hand from trouser pocket and rub forehead, as though 'trying to get mental image of marble's color. Offer to bet a quarter that you can name color of marble. Reach into coat pocket and take a quarter from the change pocket, at same time finger-palming marble. As you show coin, glimpse marble. If he refuses to bet, drop coin back into side pocket, retaining palmed marble. Place right hand behind back, immediately turning your back to audience once more so they see you feeling the marble with fingers of both hands. After a moment or two, name the color.

Another excuse for removing the coin (or any small object) is to place it against forehead, explaining that the metal will aid you in receiving color "vibrations."

3. Many beautiful sleight-of-hand effects using marbles, or small balls of wood, ivory, or plastic, have been developed. Sachs, in chapter six of "Sleight of Hand", describes a Chinese marble routine in which two extremely useful sleights are employed. They are: (a) Appearing to take a marble from the lips, actually substituting a palmed marble, the other marble remaining in mouth. (b) Appearing to place a marble on top of

## COMMENTS AND ADDITIONS

Source:

Date:

closed left fist. Actually, a marble previously held in left fist is brought into view on top of fist, and the first marble is retained in right hand.

Both these sleights can be used in many ways in different routines. Exact details on the proper execution of the second sleight have not, to my knowledge, been published. Silent Mora has published his ball and net routine, employing this move, but his description of the move is vague. The sleight has reached its highest perfection in the hands of Dai Vernon, who perhaps will some day publish his elaborate ball routine in which the move plays an essential role. Much of the routine can be found in Chapter 5 of "The Dai Vernon Book of Magic."

4. Sight bits. Mumble something. Straight man asks you to take the marbles out of your mouth. Open mouth and let marbles clatter to floor. Or explain how you became an accomplished political speaker. Show four marbles and put them in your mouth. Explain how you kept them in your mouth for a week of speech making, then removed one marble. (Take a marble out of mouth.) Continue along this line, each week removing a marble. Finally, you conclude, you became an accomplished political speaker, much in demand, as soon as you lost all your marbles.

5. Patriotic balls. The classic form of this trick, as given in Hatton and Plate, "Magicians' Tricks", page 169, is as follows: On the table are three hats in a row, a saucer in front of each. Three red balls are on the first saucer, three white balls on the second, three blue balls on the third. Here we assume marbles are used. One at a time the magician puts a marble in a hat, apparently placing all the red marbles in one hat, the white in the middle hat, the blue in the third. The hats are tilted. Out of each rolls a red, white and blue marble.

The trick can be done with colored tissue-paper balls or colored sponge balls, but the effect gains if there is a sound when each ball is dropped. To intensify the sound, opaque plastic glasses, cans, jars, etc., have been substituted for hats. There are many handlings, some secretly using a tenth marble, some not.

## COMMENTS AND ADDITIONS

Source:

Date:

Strategems including retrieving a marble on a bounce, dropping one marble as the same hand places another silently in the container, secretly picking up a marble while another is dropped, palming the marble that is supposed to be dropped then picking up a marble already there and dropping it, and so on. A switch can be made in the hand and a marble of different color dropped from a few inches above a container, since the color of a falling marble is difficult to observe. A clever routine using colored poker chips is in Stewart James, "Magic Mine, No. 1", page 17.

## MATCHES

Several small books have been published which deal exclusively with match tricks—"Match-Stick Magic", by Will Blyth, 1921, "Match-ic", by myself, 1935; and "Between Cocktails", by Sidney Fleischman, 1940. The latter booklet concerns only manipulative sleights with paper matches. In 1940 Samuel Berland issued a collection of five original match tricks, all but one requiring considerable preparation, under the title of "Match-effex". There are no doubt a number of foreign books concerned solely with match tricks, but the only one with which I am familiar is a German work, "Streichholz Spielereien, by A. Czepa, which covers match puzzles. I have not seen an earlier (1889) booklet, "Streichholzspiele", by Sophus Tromholt, said to contain over 250 items. The first volume of Jules Dhotel's "Magic with Small Apparatus" (translated from the French by Paul Fleming) has a large section on matches and match boxes.

The material to follow will fall into three main categories: I. Tricks which can be done with either paper or wooden matches. II. Tricks which can be done with paper matches only. III. Tricks which can be done only with wooden matches.

Many match tricks that require the use of other props, such as coins, cigarettes, etc., will be found listed elsewhere in the "Encyclopedia".

I. Tricks which can be done with either paper or wooden matches.

1. Penetrating matches. This beautiful impromptu illusion is described in many books, but there are several unpublished details which are essen-

## COMMENTS AND ADDITIONS

Source:

Date:



tial to securing a maximum effect.

With paper matches, it is performed as follows: Prepare one match by rubbing the tip against a hard surface to flatten the top of match head slightly. Moisten tip of right forefinger. Hold head of match with left thumb and finger and press it firmly against tip of right finger. This will cause head to stick lightly to finger tip.

Right hand holds this match vertically between thumb and finger (Fig. 498). Left hand holds second match horizontally. The second, third, and fourth fingers of both hands should be extended. The right hand is held about a foot to the right of left hand and six inches higher, as shown. It is then brought down in a slanting direction toward the other match. As soon as the hand starts moving, raise the forefinger slightly, leaving a small gap between the end of match and thumb—just enough to permit a silent passage of the horizontal match. At no time during this action does the left hand move. Right thumb returns to the end of match as soon as the apparent penetration is completed. The matches are now shown interlocked (Fig. 499). Reversing the move brings the hands back to original position of Fig. 498.

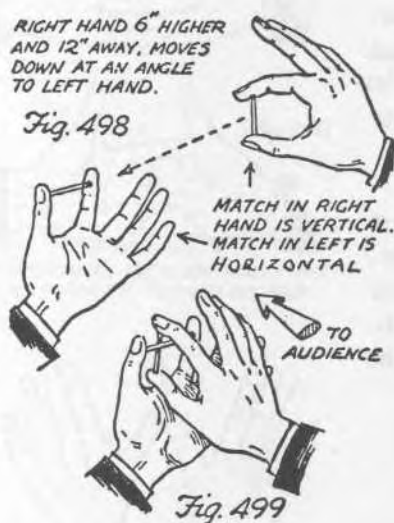

To give spectators a clear view of both matches, left hand should be extended toward audience and right hand held close to your right cheek before starting the penetration. In other words, the downward path taken by right match should slope more toward audience than toward the left. Left hand should be held palm up, the thumb and fore-

## COMMENTS AND ADDITIONS

Source:

Date:



finger pointing directly upward, to give spectators a full view of the match it holds.

Practice the move until you are able to reduce size of gap to less than quarter of an inch. You will then discover that the sleight is completely invisible even though the hand is not moved rapidly. A common mistake is to move both hands in and out during the penetration and release. This distracts from the illusion. Here are some additional tips.

Before making the move, explain that matches are held in such manner that if thumb and finger separate the slightest amount the match will fall. Demonstrate this by separating thumb and finger of left hand, allowing match to drop to table.

Secure the match in left hand once more. Press centers of matches against each other (at right angles) explaining that you intend to cause the matches to penetrate at this spot.

Raise right hand and execute penetration move. Pause to let everyone see clearly how matches are securely interlocked. Separate the hands and repeat the move once or twice. Now make the move three or four times at top speed, without pausing at either end of move. While these rapid penetrations are taking place, the gap is allowed to remain open throughout, the thumb not returning to end of match until the series of penetrations is completed. This can be extremely effective if done smoothly and silently.

Finish by placing tips of each middle finger against tip of thumbs, gripping each match at the base. You can now raise both forefingers (Fig. 500), and allow both matches to fall to table. This strengthens the suggestion that matches are not sticking in any way to the fingers or thumbs.



If wooden matches are used, two procedures are possible. One is to break a single match in half and use the two halves. In this case the right fingertip presses against one of the broken ends. It will stick to the finger.

## COMMENTS AND ADDITIONS

Source:

Date:

The other procedure is to clip the head of each match lightly between tips of first and second fingers rather than use forefinger alone. This enables you to exhibit the trick on a larger visual scale, especially if kitchen matches are used. The illusion is just as good, but the use of two fingers to grip each match greatly weakens the overall effect.

2. The floating match. Magician clasps his hands (Fig. 501) while a burning match floats back and forth a few inches behind them. From the front all the fingers appear to be interlocked. Actually, right middle finger extends backward (Fig. 502), but the seven remaining fingers interlock in alternating fashion so it is not noticeably missing. Burning match is wedged beneath middle fingernail. Finger is moved slowly back and forth to make match appear from the front as though it were floating unsupported from side to side.

Begin with burning match held by thumbs (Fig. 503). Close hands, securing match in nail of right middle finger as you interlock your fing-



PERFORMER'S VIEW SHOWING RIGHT MIDDLE FINGER TURNED INWARD.



ers. Finish by grasping match between tips of thumbs once more and opening the hands to original starting position of Fig. 503.

## COMMENTS AND ADDITIONS

Source:

Date:

John Boyko suggested the comedy effect of trying to light your cigarette with the floating match. On each attempt the match jumps to the other side of hands, away from cigarette. Finally you allow the match to float slowly over to cigarette and light it.

The basic idea for this effect (without clasping fingers, one hand simply placed in front of other) first appeared in "Genii", Feb. 1947.

The handling of the effect is obviously made much easier if wax, rubber cement, or some similar adhesive is used to stick match to fingertip.

3. Hand to hand transposition. Two matches are placed on table about a foot apart, the heads pointing away from you. Turn left hand palm up and place it flat on table, the fingers covering match A (Fig. 504). Pick up match B by grasping the head between thumb and first finger of right hand (Fig. 505). Place this match in left palm, actually leaving it there. Left hand should close before right fingers leave the palm. In other words, right hand withdraws only after left fingers have almost completely closed. This prevents audience from seeing the match, even though you actually leave it in left hand.

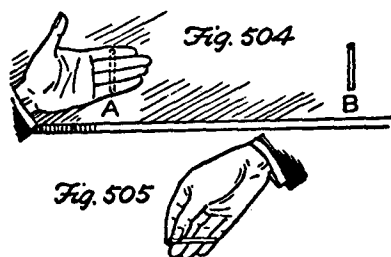

As left hand closes, match A automatically comes into view. Pick up this match in right hand, holding it by the head as before. The hands separate. Left hand rolls its match to the table, then right hand does same. Nothing of course has happened.

The moves are now repeated and should look exactly as before. This time, however, right fingers retain match B, withdrawing it as left fingers close. The exposure of match A distracts attention of audience from this sleight. Immediately pick up match A with right hand and separate hands. When left hand makes a slight throwing motion, as though rolling out the match, it is seen empty. Now roll out both matches from right hand.

## COMMENTS AND ADDITIONS

Source:

Date:

When these moves are made slowly and rhythmically, the transposition is extremely effective. Any two small objects—sugar cubes, paper balls, cigarette butts, etc., can be used instead.

Another handling of the trick is to count aloud from one to ten, making certain moves on each count as follows: 1. Put match A on table. 2. Put match B on table. 3. Cover A with left hand. 4. Pick up B with right hand. 5. Appear to place B in left. 6. Pick up A with right. 7. Place back of right fist on table. 8. Place back of left fist on table. 9. Open left hand showing it empty. 10. Open right hand, showing two matches. The counting insures a rhythmical presentation and makes it difficult for spectators to detect the moment of skullduggery.

An interesting variation, after spectators have seen the previously described sleight several times, is this. Instead of placing left hand over match A, put the hand palm up on table, then pick up match A and appear to place it under the left fingers. Actually, retain match in right hand. Now proceed as before, picking up match B with right hand and placing it in left, only this time you leave both matches there. As left fingers close over the matches, reach for match A, then look surprised to discover that it has vanished from the spot where it had apparently been placed. Search about on the table for the missing match, then open left fist to reveal both matches.

4. Returning match head. The well known trick in which one of three small objects keeps mysteriously returning to left hand, after it has apparently been thrown away or placed in pocket as No. 28 under CIGARETTE. Matt Schulien's match version of this trick appeared in "The Sphinx", April, 1940. It goes as follows: A match is broken in three parts. The part with the head is thrown under the table repeatedly, but it keeps returning to the left fist. An extra piece with a head is used, of course. It can be concealed in right hand by clipping the head between tips of second and third fingers, or simply by clipping it between thumb and middle fingertips (Fig. 506), leaving index finger free to pick up other pieces.

## COMMENTS AND ADDITIONS

Source:

Date:



As you extend right fist for him to insert match head up, left fist comes to edge of table and the match he inserted is lapped. When you open your hands palm up the matches now point opposite ways. (George Blake, in "Pallbearers Review", April, 1968)

### Mathematical Tricks

7. The well known Piano card trick can be performed with 15 matches by placing them between spectator's fingers (Fig. 508). Remove the pairs one at a time, separating the matches so that one goes to the left and one to the right, forming two piles. The remaining single match is added to whichever pile spectator designates. You now cause the extra match to transfer invisible to other pile. When each pile is counted by pairs, the transfer seems to have occurred. Trick works automatically.

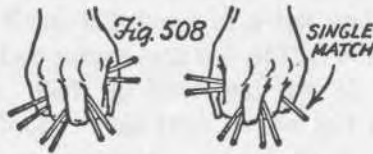

8. Tramps and Geese. This ancient trick is usually described as follows: Five matches are placed on table to represent geese. Each hand holds a single match. These two matches are tramps who intend to steal the geese. Illustrate this by picking up the five matches one at a time, beginning with right hand, then alternating hands. This puts four matches in right hand, three in left.

The tramps now hear a farmer approaching so they quickly put back the geese. Illustrate by replacing the five matches one at a time, starting with left hand. This leaves you with two matches in right hand and none in left, but keep both hands closed in a fist as though each contains a match. When the farmer leaves, the tramps pick up the geese again. Begin taking matches with right hand. This puts five matches in right hand, two in left. The tramp on the left now complains that he has only one goose while his friend has four. Open the hands to show that this is indeed the case.

9. Turn your back and ask someone to form three heaps of matches on table. The number in each

### COMMENTS AND ADDITIONS

Source:

Date:



heap must be the same, and must be more than three. Spectator now names any number from one to 12 inclusive. Without turning around you are able to give directions which will bring the number of matches in center heap to the desired number. This is done by asking him to take three matches from each end heap and place them in the center. He then counts the number in either end heap and removes that number from the center, placing the removed matches on either end heap. This always leaves exactly nine matches in the center, making it a simple matter for you to give instructions for bringing this heap to chosen number.

The trick may be varied by using some number other than three for the initial transfer, provided it is less than the number of matches in each pile. The procedure described above always brings center heap to three times this number. Once you know the number in center heap, you need not bring it immediately to the desired number. Have matches transferred back and forth a few times to make the procedure more confusing.

10. Three small objects (for example, a penny, ring, and key) and 24 matches are on the table. Three spectators, whom we will call 1, 2, and 3, are asked to take part. Spectator 1 is given one match.

Spectator 2 gets two matches. Spectator 3 gets three matches. You now turn your back and ask each spectator to take one of the three objects, which we will call A, B, and C.

Tell the person who took A to remove from the pile of matches as many as he already holds. Tell person who took B to remove twice as many as he holds. Remaining spectator, who took C, is told to remove four times as many matches as he holds. All three spectators put their matches and object in their pocket.

You turn around and immediately tell each person which object he is holding. The number of matches remaining on the table provide the clue.

If 1 match remains, Spectators 1, 2 and 3 hold objects A, B, and C in that order.

If 2 remain, the order of objects is B, A, C.

## COMMENTS AND ADDITIONS

Source:

Date:



If 3 remain, the order is A, C, B.

If 4 remain, then someone made a mistake, as it is impossible for this to happen.

If 5 remain, the order is B, C, A.

If 6 remain, the order is C,A,B.

If 7 remain, the order is C,B, A.

This key must be committed to memory or referred to in some secret manner, such as having it inside a match folder where you can read it when you pull out a match to light a cigarette.

The trick is discussed in several medieval treatises on mathematical recreations. For a recent discussion see Ball's "Mathematical Recreations", revised American edition, 1947, p. 30f. Mnemonic devices for performing several variations may be found on pages 23 and 218 of "The Magician's Own Book, 1857".

#### Stunts

11. If the fingers of an outstretched hand are moved slowly back and forth through a match flame, it looks dangerous but actually will not burn the fingers.

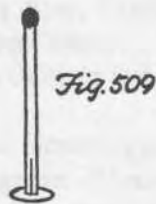

12. Push a thumbtack into base of match. If balanced on wrist (Fig. 509) directly over pulse, the match will wobble slightly with each pulse beat, providing a visual pulse indicator.

13. Each time you try to light your cigarette, the match goes out mysteriously. Accomplished by blowing through your nose. If a piece of flash paper is inserted in end of cigarette, you can touch head of blown-out match to it and it will ignite, lighting cigarette.

14. Hold a burning match a few inches above your

#### COMMENTS AND ADDITIONS

Source:

Date:

forehead. When you appear to blow forward, the match goes out. Done by extending lower lip so blast of air is directed upward. Because eyes of spectators follow match as you raise it above head, they seldom notice your projecting lower lip.

15. Hold burning match close to lips and say "Bo Peep." The flame will be puffed out.

16. If a burning match is held behind a drinking glass or bottle, and you blow against bottle, the flame will go out. Appears as if you blew through bottle.

17. In handing spectator a match, your thumb presses head of match against striking surface of box or folder. When he pulls match from under your thumb, it automatically ignites.

18. Burning match is apparently balanced on back of thumb (Fig. 510). Actually, end is gripped by one of the creases near knuckle.



19. Children sometimes produce a home-made "stink bomb" by dropping ten or twenty burning matches, one at a time, into a bottle. If bottle is corked immediately after each match is struck and dropped inside, it will accumulate a strong concentration of odoriferous fumes.

20. Match is held upright and another match balanced on top, the two heads touching. Match heads previously coated with rubber cement. The cement can be rubbed off before handing matches to spectator.

20a. If head of match is given two coats of rubber cement you can dip head in glass of water, dry the head with your fingers, removing the cement, then immediately light match by striking it.

21. If certain flowers are held a few inches above a burning match they will change color. A crimson dahlia, I am told, will turn yellow, purple columbine becomes pink and then black, and similar changes reportedly occur with other flowers.

## COMMENTS AND ADDITIONS

Source:

Date:

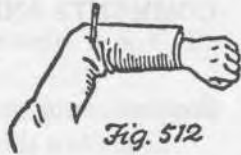

Fig. 512

22. Bend your left arm (Fig. 512). Hold center of match with thumb and finger of right hand, and press match down against a fold of cloth in your coat sleeve as shown. Release match. The fold acts as a springboard, often sending match several feet into the air.

### Gags

23. Magician lights cigarette and tosses match on floor. It lands with a loud clang. A finger-palmed nail is thrown down instead of match.

24. Magician strikes match behind his ear. A piece of striking surface is fastened behind ear with adhesive tape.

25. Announce you will make a match burn twice. Strike it, blow it out, then extend it forward as though intending to burn spectator's hand.

26. Start to strike a match to light your cigarette, but allow match to slip out of your fingers and fall to floor. Pretend to search for it under the table. It is dark beneath table, so to see better you strike a second match. With the aid of this light you find first match. Blow out second match and toss it away. Proceed to light your cigarette with original match.

27. Ask victim to make a fist. Insert three matches upright between his fingers. Light the matches, let them burn a moment, then ask him to blow them out. When he does, everybody joins in singing "Happy Birthday to You."

28. Show one match in left hand, penny in right. Close hands and announce you will cause objects to change places so penny will be on left, match on right. Pause for dramatic effect, then simply cross your forearms. Any small objects can of course be used.

29. Instead of lighting your cigarette with match, take a large candle from pocket, light candle, then use candle to light cigarette.

### COMMENTS AND ADDITIONS

Source:

Date:



30. State you will demonstrate a match that burns under water. Light match and hold it under glass of water.

30a. To prepare matches that sputter a moment then go out, cover heads with clear nail polish.

30b. Bend a match at two places, so it resembles miniature telephone, and rest it on tip of victim's upright thumb. Ask him to say "Wing" three times, then you say, "Well, aren't you going to answer the telephone?"

#### Puzzles and Betchas

The following list is representative only, it being impossible to cover completely the hundreds of match puzzles which have been devised. For additional puzzles, see the books listed as references at the beginning of this section. Other match puzzles are given under "Matches, paper" and "Matches, wooden." See "Coins" and "Checkers" for numerous puzzles which are applicable to matches.

31. Bet you can hold a burning match upside-down and count to fifty. Done by moving match in small circles to keep flame low. Similar bet: that you can make a match burn longer than anyone else. Hold match upright and move in small circles as before.

32. Two matches are floating on water a few inches apart. Problem: without touching matches, cause them to move closer together, then farther apart. The former is supposed to be accomplished by touching a rolled up cylinder of blotting paper to the water between the matches, but when I tried it the matches failed to respond. Touching soap to the water, however, works very well in sending them apart. In fact a tiny bit of soap may be hidden under the fingernail. When you place tip of finger on surface of water between matches, they separate mysteriously.

#### Placing Puzzles

33. With 12 matches spell a word that explains what matches are made of. Answer: LOVE.

34. Place six matches so each touches the other five ( Fig. 513).

#### COMMENTS AND ADDITIONS

Source:

Date:



Fig. 513



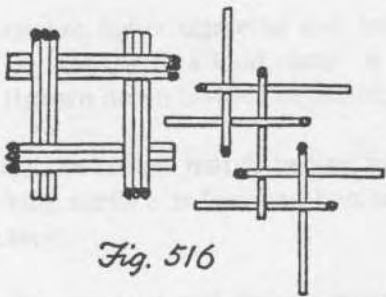
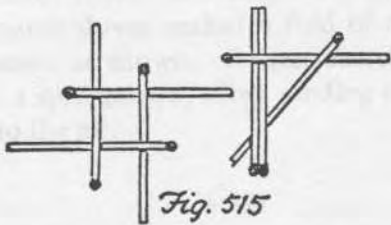
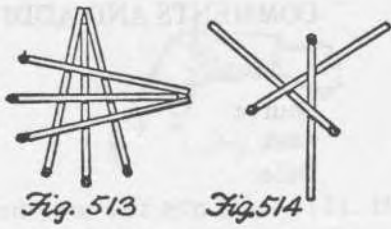

COMMENTS AND ADDITIONS

Source:

Date:

35. Arrange three matches so none of their heads touch the table (Fig. 514). Arrange four matches in similar manner.(Fig. 515 shows two solutions). If wooden matches are used, these formations will support heavy objects placed on the raised center portions. Larger numbers of matches can be arranged to keep heads off table in many different ways. Fig. 516 shows two examples.

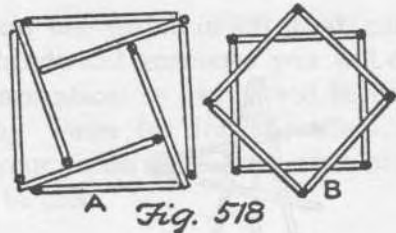
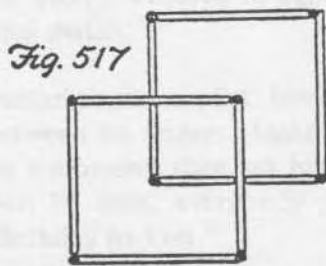

36. With eight matches form three squares (Fig. 517). With eight matches form two squares and four triangles (Fig. 518-A). With eight matches form two squares and eight triangles (Fig. 518-B).

37. Form two piles of matches so the number in one pile multiplied by number in other will equal seven. Answer: seven and one.

38. Form four triangles of equal size with six matches (Fig. 519). To form six squares of equal size with twelve matches, form skeleton of cube.

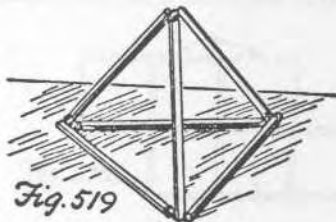

Fig. 519

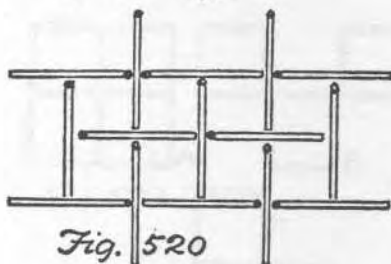

Fig. 520

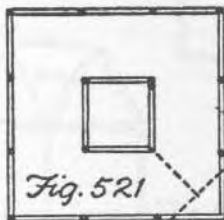

Fig. 521

39. Form eight squares with 15 matches (Fig. 520).

40. Five matches are placed on table. Problem: to make a Maltese cross. Solution: find a native Malta, put four matches in his ear and light them with the fifth (or light them and drop them down his back). Similar problem: to make a Nazi cross. To make a Venetian blind, poke his eyes with the matches.

41. Fig 521 represents an island surrounded by water. Problem: to form a bridge from island to mainland with two matches. Dotted lines show solution.

## COMMENTS AND ADDITIONS

Source:

Date:

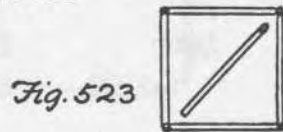

COMMENTS AND ADDITIONS

Source:

Date:

42. Place six matches as in Fig. 522. Add five matches to make "nine" as shown.

43. To prove that two plus one equals four, place two matches on table and add one to make the figure 4 or the Roman numeral IV.

Removing Puzzles

44. Begin as Fig. 523. Remove two matches, then add three matches to form a design identical with original one. Done by removing two matches and placing them in another spot on table. The remaining three are then picked up and added to the same two matches to reform the original design.

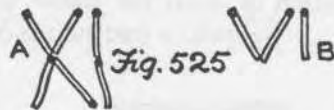

45. Begin as Fig. 524-A. Remove six matches and leave "ten" as shown in 524-B.

46. To prove half of 11 is six. Form Fig. 525-A, then take away lower half to leave 525-B.

47. Begin with Fig. 525-A. Remove two matches to leave two squares. Solution shown in 526-B, catch being that the squares are not same size.

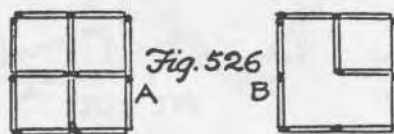

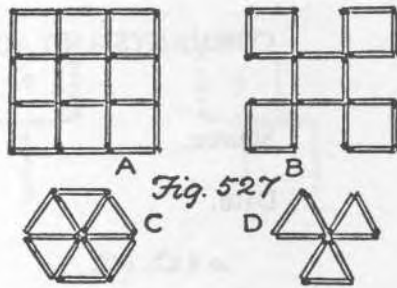

48. From Fig. 527-A remove four matches to leave five squares of same size. Fig. 527-B shows solution. From Fig. 527-C remove three matches and leave three triangles. Solution shown in 527-D.

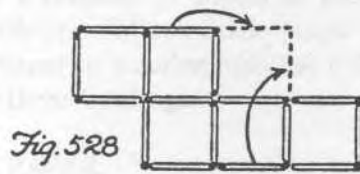

Fig. 528

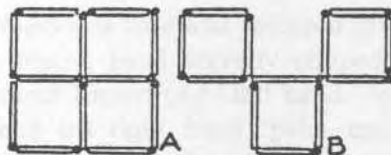

Fig. 529

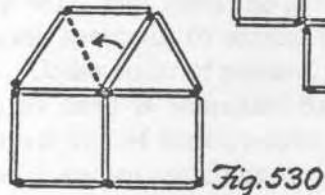

Fig. 530

Shifting Puzzles

49. Form pattern shown in Fig. 528. Move two matches to make four squares of same size. Solution is indicated. This is the best puzzle I have seen of this type. You can demonstrate solution, then set it up again in upside-down form, and spectator is as puzzled as ever.

50. Begin with Fig. 529-A. Move three matches to make three squares (529-B). Move four matches to make three squares (529-C).

51. Form the house shown in Fig. 530. Move one match to make house face west instead of east. Solution is indicated.

COMMENTS AND ADDITIONS

Source:

Date:

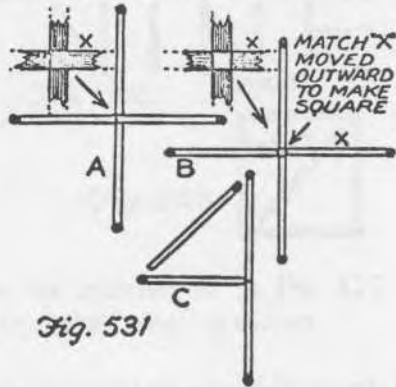

Fig. 531

INCORRECT TO CORRECT

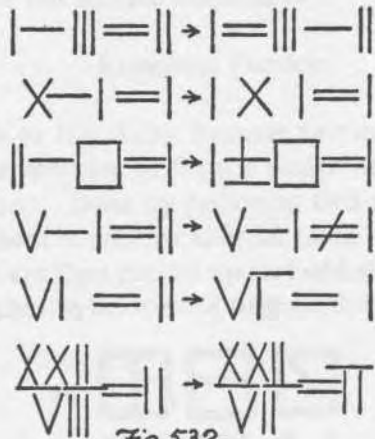

Fig. 532

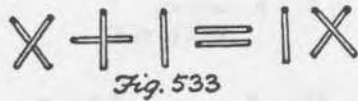

Fig. 533

52. Four matches are placed as in Fig. 531-A. Move one match to make a perfect square. Two solutions are shown in 531-B and 531-C.

53. On the left of Fig. 532 is a series of incorrect equations. In each case you move one match to make the equation correct. Solutions are shown on the right. In the last equation, 22 divided by 7 yields a close approximation of pi.

54. Change the equation of Fig. 533 into a correct one without moving, adding, or taking away matches. Solution: move yourself! Walk around table and view equation from other side.

55. Four matches form a Manhattan cocktail glass as shown at left of Fig. 533a. A match head provides the cherry. Without touching the cherry, move two matches to reform the glass, with the cherry outside the glass. Solution is shown on right.

COMMENTS AND ADDITIONS

Source:

Date:





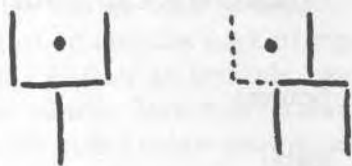

Fig 533 a

## Games

Matches can be used as counters in playing a variety of table games. See game section under "Coins" for a number of games of this sort, also Part 3 of Blyth's "Match-Stick Magic". Games peculiar to paper or wooden matches will be found listed under those headings.

## MATCHES, PAPER

1. Fred Peterson's torn and restored match. Begin with a match head secretly clipped between first and second fingertips of left hand. Ask spectator to extend his right hand, palm up. Tear a match from folder and place it on his palm, head pointing to your left.

Ask him to inspect match carefully. After he does so, pick it up with right hand and gesture with the hand as you ask spectator to extend his left hand, also palm up. Under cover of gesture, rotate match in fingers so its head is concealed by thumb and finger, and lower end of match points to left. Your left fingers seize end of match as soon as gesture is completed. Spectator thinks left fingers have seized head of match.

Pretend to twist off the head, immediately showing the duplicate head previously clipped by left fingertips. Drop this head on spectator's right palm. Your right hand now places the match on his left palm, the head still concealed by your thumb and finger. Ask him to close his left hand. Do not let go of match until his fingers close over it, otherwise he may catch glimpse of its head. Spectator now thinks he holds a headless match in his left fist, and that the head of that match rests on his right palm.

Pick up the head with right hand and pretend to place it in left, secretly retaining it. Right hand drops the head on floor as left hand makes throw-

## COMMENTS AND ADDITIONS

Source:

Date:



ing motion toward spectator's fist. When he opens his left hand he finds the match restored.

2. Color-changing heads. Your left hand displays a match with, say, a red head. Call attention to the color or spectators will not remember it later. Right hand secretly clips a blue-headed match (Fig. 534).

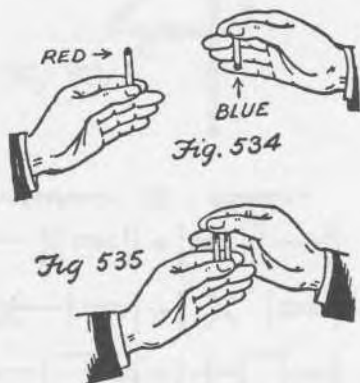

Seize head of red match between thumb and finger of right hand (Fig. 535) and pretend you are trying to pull it off by jerking the hand upward. Repeat once or twice. On third attempt the thumb and finger of each hand seize the head of match in opposite hand. The pulling motion is repeated, but this time the matches are switched, leaving the upside-down match in left hand. It gives the illusion of right fingers having pulled off the head.

Pretend to toss the head under table, actually tossing match away. Rest of trick is patter and build-up. Pretend to explain how trick was done. Under cover of right hand, you say, your left fingers secretly reversed the match, bringing its lower end into view. But, you continue, you were never able to comprehend why this always causes the match to change color.

With right forefinger, rotate the match so the blue head comes into view. Toss match forward for inspection, allowing audience to note that both hands are empty.

If matches of different colors are not available, you can pretend to pull off head of burnt match, finishing with an unlit one.

3. If the fumes rising from a paper match immediately after striking it, are inhaled through the nose, exhaling will produce a surprising amount of

## COMMENTS AND ADDITIONS

Source:

Date:

smoke that looks exactly like cigarette smoke. The principle can be used as follows: Pantomime the taking of an invisible pack of cigarettes from your pocket. Extract an invisible cigarette and place it in your mouth. Now strike a match, holding folder about six inches below your nose so that as soon as match is struck you can secretly catch a whiff of the rising fumes.

Pretend to light your invisible cigarette. Shake out match, act as if you are taking a drag, then remove the non-existent cigarette from your lips and slowly blow out the smoke. The unexpected appearance of the smoke is extremely startling.

The trick should be performed indoors where the air is still. If two matches are held as one and struck, the quantity of smoke produced later will be much greater. Only a short quick sniff is required, but even this is highly unpleasant, and one should perform the trick only at infrequent intervals.

4. If a letter or number is penciled on head of match, and match allowed to burn ten seconds or more, the letter will become visible on the head as black lines against the gray ash. Use a sharp pointed pencil to make a fine line, and do NOT go over the lines to make them heavier. Hold match vertically while it burns.

Some uses for the principle: (a) Prepare heads in a folder with numbers from 1 to 10. Spectator names a number. Pull out proper match to light your cigarette, then hold it vertically while spectator stares at flame and thinks of his number. Blow out match and show the number printed on the head. (b) Spectator stares at burning match, then finds his initials on the head—a letter on each side. (c) Match is used to reveal name of forced card—value on one side, initial of suit on other. (d) Prepare matches in folder with names of most commonly thought of cards. Ask someone to name a card. If he names one in the group, pull out proper match, etc.

5. Moisten your finger and thumb before striking a match. Hold it vertically and as it burns give it a bend in the middle as shown in Fig. 536. When you blow down left sleeve, match in right hand goes out. Done by sliding thumb and finger, caus-

## COMMENTS AND ADDITIONS

Source:

Date:



## COMMENTS AND ADDITIONS

Source:

Date:

ing match to make a quick half-rotation. The rotation swings the flame through such a wide arc that it snuffs it out. Another presentation: light cigarette, then take it in left hand and blow on it, at same time causing match in right hand to go out.

6. Light two paper matches and hold one in each hand. Left match is horizontal, right match vertical. Blow out left match. Immediately bring other match over to it, touching its end to the head of extinguished match (Fig. 537). Match in left hand will relight, apparently from lower end of burning match! Actually, a wisp of smoke from left match rises past flame of other match, and the flame jumps quickly down the smoke to relight lower match. Air must be quiet in the room and left hand should remain completely stationary throughout. Right hand brings burning match over to left, not vice versa.

7. Bert Allerton thought of combining the last two

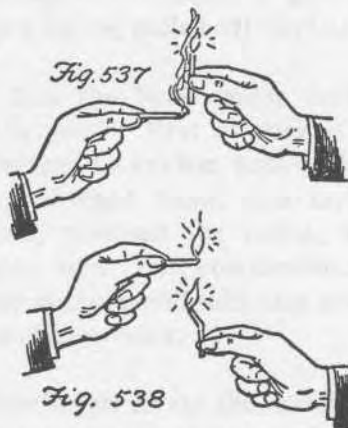

principles into a startling effect. Each hand holds a burning match (Fig. 538). Right hand match has been secretly bent. By snapping it as explained in No. 5 above, it will go out suddenly, then just as mysteriously relight as the flame of upper match jumps invisibly down the rising smoke.

8. Joe Tershay, of San Francisco, discovered this ingenious method of making a match appear to light twice. Two matches are held as in Fig. 539-A.



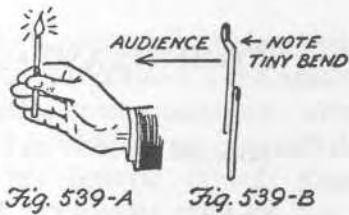

Fig. 539-A Fig. 539-B

Audience is not aware of the second match concealed behind the first. The top match has been given a tiny bend beneath the head as pictured in Fig. 539-B. Strike the upper match and let it burn vertically until you see that the head is glowing red. Blow it out.

Slide the thumb down an inch on the concealed match (your third finger against the end of match will keep it from sliding), then push it upward along the other match until the heads touch. The hand is waved slowly from side to side to conceal this action. A moment after the heads touch, the second match will burst into flame. From the front it looks as if original match has mysteriously ignited. The tiny bend in the match permits the heads to slide snugly against one another. Use a larger width match for the upper one, regular width match for the lower one.

9. Secretly prepare a match, without removing it from folder, by twisting it clockwise and counter-clockwise until its center becomes soft and pliable. To all appearances the match is unprepared. Tear out all the matches and have someone initial the prepared one. When matches are handed to you one at a time beneath table, you can spot the initialed one easily. Simply twist each match by the ends until you are handed a match that twists easily.



Fig. 540

10. Hold two matches by the heads as in Fig. 540. Move the hands back and forth, alternating fashion, for a distance of about six inches. Matches appear to penetrate each other. Actually, one match bends back, then springs into place again. For the best illusion, hold matches on level with spectator's eyes.

## COMMENTS AND ADDITIONS

Source:

Date:



11. In 1935, while gathering material for "Match-ic", I discovered that a wooden match head in a bottle of water could be made to behave like a Cartesian diver. This is also true of a paper match—either the head or entire match. The most impromptu version is to fill a soda bottle almost to the top with water. Drop two matches inside and let them soak a moment. Push your index finger into the neck and press down. The finger must be wet so no air escapes around it. The pressure will send the matches to the bottom of the bottle where they will remain.

To bring the matches up again, insert the finger as far as possible, then create a strong suction by bending the finger over the rim so that the tip of finger is drawn upward inside the neck (Fig. 541). The matches will rise slowly to the top. Releasing the vacuum causes them to sink again. Usually one match will be first to go down and last to come up. If you use matches with different colored heads (or one burnt match) you can give them names, then order them up and down singly. If you have large hands, the third or fourth finger may work better than first finger.



Heads of wooden matches are more buoyant than water-soaked paper matches and therefore will return to the surface as soon as pressure is removed. Since no suction is required they can be controlled by a cork which is either pressed firmly down or loosened. A piece of balloon stretched over the opening and held with a rubber band can also be used. Pressing on the rubber membrane sends the match heads down, releasing the pressure brings them up—making an unusual and easily operated toy for children.

12. Gerald Kaufman published during the thirties this ingenious method of communicating secretly the location of a hidden object. Magician sends assistant out of room while a small object (say a

## COMMENTS AND ADDITIONS

Source:

Date:

ring or pin) is concealed. Before assistant returns, the magician leaves room. The assistant, in apparent telepathic communication with performer, finds object quickly. A paper match does it. Magician lights his cigarette, casually places match on a cluttered rectangular table or desk. The table corresponds like a floor plan to the shape of room, so position of match indicates area where object is hidden. Moreover, room is divided into three vertical levels—from floor to table top, from table height to ceiling. The level is indicated by bending match near the head, near lower end, or not bending it at all.

### Paddle Move Tricks

The paddle move enables you apparently to show both sides of a paper match when actually only one side is shown. The move begins as in Fig. 542-A. The hand is then turned at the wrist (the arm should not move) to Fig. 542-B, apparently showing the other side of match. As the hand turns, the thumb pushes forward and the match is given a secret half-turn. The move can be made slowly and still remain undetectable. The following tricks employ this basic sleight.

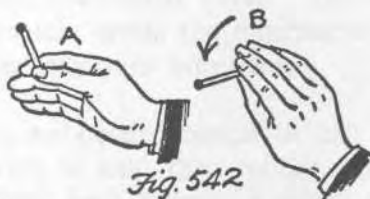

Fig. 542

13. Prepare two matches in advance by scraping off one side only of each head. The two matches are held side by side with the heads visible, and apparently shown on both sides by means of the paddle move. Under cover of seizing the heads between thumb and finger of left hand, give the matches a secret half-turn. Pretend to pull off the heads. Use paddle move to show matches headless on both sides.

Left hand pretends to toss the heads toward the matches. At same time, make a quick motion with right hand, snapping the matches over so the heads suddenly reappear. Tell children that the heads are invisible after you pull them off. Let child pretend to take them from you between his own thumb and finger, then toss them back on the matches again.

### COMMENTS AND ADDITIONS

Source:

Date:



14. Francis Carlyle, in his pamphlet "Decapitation" (Stars of Magic series), describes a beautifully worked out effect based on the paddle move. The head of a single match is apparently pinched off on both sides, then restored. The trick is repeated with another match and this time both sides of the pinched-off head are dropped on spectator's palm. The restoration occurs as before.

A pretty move to use in making the head appear is to hold the apparently headless match at its center, between right thumb and forefinger. Left index finger touches headless end of match and rotates it 180 degrees counterclockwise. This move is now repeated, but as match is rotated by left finger, right hand makes paddle move so that the head appears as the end of match rotates back to its former position.

15. Prepare a match head by trimming a tiny portion off the top and sides with a razor blade so the two halves of the head do not touch each other. If the match is struck on one side of the head, then blown out quickly, the other side will not ignite. By means of paddle move, show both sides burnt, then wave match and it becomes restored. Use paddle move to show both sides again, then strike match once more. A good follow-up for both this and preceding trick, making use of the match after it is struck the second time, is No. 2 above.

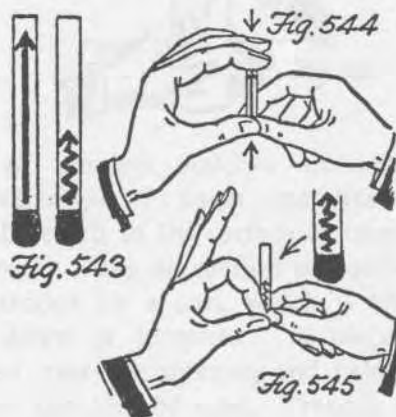

16. Cy Endfield's arrow. Draw a straight arrow on one side and a "squeezed" arrow on the other (Fig. 543). Match is held by the head. Use paddle move to show arrow straight on both sides. Left fingers pretend to "squeeze" arrow (Fig. 544) by making a squeezing gesture above the match. Under cover of this gesture the match is secretly given a half-turn. Show the compressed arrow on both sides.

## COMMENTS AND ADDITIONS

Source:

Date:



Now hold left hand above the match as in Fig. 545 and snap the forefinger forward. As the finger passes over the match, give it a quick half-turn. Timed properly, the turn is invisible and the arrow seems to elongate instantly and magically.

17. Bert Allerton calls my attention to fact that most paper matches are darker on one side than on the other. An impromptu quickie is to show match to be light-colored on both sides, then touch it to something dark and it instantly changes to a darker color on both sides. Touching it to a light-colored object changes it back again. The paddle move is responsible of course.

18. "Hen" Fetsch suggested in Vol. 1 No. 1 of M.U.M. that one side of match have glued to it a narrow length of striking surface. This match is held in right hand, an unprepared match in left. Show both sides of each match, using paddle move to conceal the striking surface. Rub the matches together with patter about a boy scout rubbing sticks to make fire. In the rubbing, strike left match on the underside of right match, using a stroke that brings the heads together at the moment that the match flares. This will ignite the other match, giving the impression that both matches magically burst into flame.

19. Split a red-headed match in half and blue-headed match in half, then rubber cement a red half to a blue half, forming a match with a red head on one side and a blue one on the other. By means of paddle move a striking color change can be effected. As in other prepared match effects, the feke may be carried behind the other matches in a folder. Pretend to tear it out when you start the trick.

20. Split each of two matches in half. Take two halves whose sides match in shade and rubber cement them together (Fig. 546). Hold the feke in the center when you make the paddle move. A half-turn, covered by a wave of match, makes it seem to reverse ends suddenly. Another presentation is to seize one head between thumb and finger. A wave of the match and the head appears

## COMMENTS AND ADDITIONS

Source:

Date:

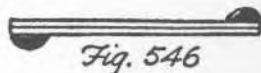

Fig. 546



suddenly on the exposed end. Other effects will suggest themselves.

21. By placing pencil dots or small x's on the sides of matches, many different effects can be devised. For example, two matches are held, side by side in right hand, holding both by the heads. Each match appears to have one pencil dot on each side. A wave of the hand and the dots on one match seem to jump over to the other match. When both sides are shown, one match is now blank on both sides and the other has two spots on each side. The spots are then caused to jump back again. The working should be obvious. One match has a spot on one side only. The other has a spot on one side and two on the other.

An elaboration of this effect makes use of a third match which has five or six spots on one side, none on the other. This match is left on the table (blank side up) until needed. Hold the other two matches in right thumb and finger and show a single spot on both sides of both matches. The spot on one match represents Peter Rabbit and the spot on the other match is Mopsy Cottontail. Cause Peter to hop over and join Mopsy. They get married. Pick up the third match, which represents an empty crib, and place it between the other two. Use the paddle move to show both sides of all three matches, then make the half-turn to cause Peter to hop back and the crib to fill suddenly with baby rabbits.

22. Another striking spot effect makes use of two matches with a spot or cross on one side only of each match. Begin by showing both matches to be blank on both sides. Take the left match momentarily in left hand while right hand waves the other match, causing a spot to appear suddenly on it. Replace the left match, do paddle move to show that a second spot has appeared on the underside of right match, while left match continues to remain blank.

A wave of the hand (with a secret half-turn) and the spot jumps suddenly to left match. The paddle move is made to show spots on both sides of left match while right match remains blank. Make the spots hop back and forth a few times, ending on left match.

## COMMENTS AND ADDITIONS

Source:

Date:



The left hand takes the left match once more while right hand waves the other match causing a third spot to appear on it. Replace the left match, and make paddle move to show four spots, one on each side of both matches.

The same effect can be performed with the heads of matches instead of spots. Simply remove one side of each head. The matches must be held, of course, by the ends.

An effective manner of causing spots (or heads) to jump from one match to another is to hold one match in each hand, making the paddle move simultaneously with both hands. One match is now struck sharply against the other, the matches hitting at right angles. As the matches hit and flip past each other, each is given a quick half-turn to produce the desired changes.

23. A second method of performing the paddle move is to hold both matches between the thumb and finger of left hand (Fig. 547). If a trick using



dots is performed, the dots should be in the center of the matches. Right thumb and finger seize the matches as shown and rotate them end for end to show the other sides, after which left thumb and finger grip the ends once more and right hand moves away to show the matches. A secret half-turn of both matches is made while they are being rotated. Moisten right finger and thumb slightly if the matches tend to slide rather than turn easily.

Changes are effected simply by making the rotation without the secret half-turn. Allow the forefinger to remain on the matches after this is done, then rub it back and forth across the match (for dramatic effect) before you raise it to reveal the change.

## COMMENTS AND ADDITIONS

Source:

Date:



Effects No. 21 and 22 above both lend themselves effectively to this manner of doing the paddle move. In the latter effect, when it is necessary to give a secret half-turn to the right match only, simply remove it momentarily by the right hand, giving it a half-turn as you replace it. Rub the thumb back and forth over the match, then lift it to reveal the change.

24. A sucker effect for spectators who know the paddle move. Make a fake spot by blackening a small piece of newspaper with pencil, then tearing off a tiny piece and sticking it to the side of a match with saliva. With the pencil make a second spot on the match that is the same size as the first one (Fig. 548). Both spots look exactly alike under close inspection. Underside of match remains blank.



Hold match by the head and use paddle move for showing two spots on each side. Now pretend to wipe off one spot with a moistened left thumb. What you do, of course, is actually wipe off the spot! Repeat paddle move to show a single spot on each side.

At this point the spectator suspects you have a match with two spots on one side and one on the other. But you give the match a wave and now it is blank on both sides!

Note: the fake spot should be stuck to the glazed side of match. If placed on the unglazed side it will leave a spot of moisture after it is removed.

The principle can be applied to other effects. For example, you can show one spot on both sides, remove it, then toss match out for inspection. The use of rubber cement opens up possibilities (such as transferring spot from fingertip to match, or from one match to another) but the effects are probably not worth the elaborate preparation.

## COMMENTS AND ADDITIONS

Source:

Date:





25. Another curious sucker effect involves a secret switch of matches. Start as in Fig. 549. The exposed match has one spot on upper side, the underside blank. Another match is gripped by the head between the tips of first and second fingers, and extends back beneath the thumb. If you practice in front of a mirror you will find it easy to make the paddle move without flashing the concealed match. The hidden match has three spots on top side, two on the lower.

Show one spot on each side of exposed match by means of paddle move. Wave the hand under left arm, secretly tossing exposed match on floor. This is easily done if seated. If standing, toss it down and back so your body hides the fall.

As soon as match leaves the hand, put your thumb beneath concealed match and lever it up and forward. This brings it quickly to the same position as the previous match. When your hand comes back into view, spectators see what they assume is the same match, but it now has two spots on it. Show both sides, using the paddle move.

Spectator thinks he knows what you are doing until you wave the match under the arm again, giving it a half-turn. It now has THREE spots on it! Show both sides with paddle move, then toss match away.

Other effects can be done with the switch. You can make one spot become two, or make the heads change color, or restore the head of a burnt match – in all instances handing match immediately out for inspection. Still another effect is to make one spot change to two, using only the original match. Then make the switch to reveal three spots. The final half-turn now brings four spots into view, or perhaps a match covered with many spots.

## COMMENTS AND ADDITIONS

Source:

Date:

## Tricks Using the Folder

26. Spectator is given a handful of folders of varying colors or designs. Magician turns his back and spectator hands him one folder, hides the rest. Magician faces spectator, identifies the folder. Method: after taking the folder and turning to face audience, push folder up right sleeve. Stroke forehead with right hand, while you glance down sleeve and inspect folder. Right hand goes behind back again so folder can be retrieved, and you name the color.

27. A number of folders are in a row on table. While performer is out of room, someone tears one match from one folder and replaces folder on table. Magician comes into room, picks correct folder. Before showing, wedge the flap of each folder down as tightly as possible. Spectator is unlikely to close folder that tight. "Hen" Fetsch likes to pick up each folder with thumb against bottom edge, fingers against top edge, and pretend to "weigh" it. Loose flap is easily detected by a slight squeeze downward on the flap. Magician announces that this folder is lighter than it was previously. To preclude use of stooges, use new folders that are all alike and have them mixed in a hat. Correct folder is identified by opening it to show that a match is missing.

Another variation is to prepare each folder by putting a slight twist in the cover so that when it is closed loosely, one corner of cover will project slightly beyond the edge of striking flap. All folders are then closed tightly, with no corner projecting. The loosely closed folder can now be identified by sight, without having to handle it.

28. A full folder is handed to spectator with request that while your back is turned he (1) tear out any number of matches from 1 to 10 inclusive and pocket them. (2) Count remaining matches. This will be a two-figure number. The two figures in this number are now added. He then tears out of folder as many matches as are indicated by the total. For example, if the number is 16, he tears out 7 (6 plus 1) matches. These matches are also pocketed. (3) He now tears out a few more matches and holds them in his closed fist. After

## COMMENTS AND ADDITIONS

Source:

Date:

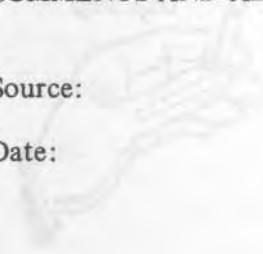



one look at the number remaining in folder, you tell him how many he is holding in his hand. Secret: The first two operations always leave nine matches in folder, hence you subtract the number you see in folder from 9 to arrive at number in his fist.

29. Prepare a full folder by inserting the cover down between the two layers of matches. When shown casually, spectators assume flap is behind all the matches. Actually, ten matches are visible and ten are concealed behind flap. Tear out the exposed matches and place folder face down on table. Drop the matches in your pocket, wave your hand over the folder, open it to show the matches have returned.

30. Christopher's homing match. Prepare folder by igniting a front-row match and blowing it out without tearing it from folder. This match is bent down over the striking surface so that folder can be held by left hand as in Fig. 550. Burnt match is concealed beneath left thumb. Bend back the cover with right hand and ask spectator to count the matches in folder. In act of closing folder, concealed match is levered up and inside. Toss folder on table. Show a single match (previously torn

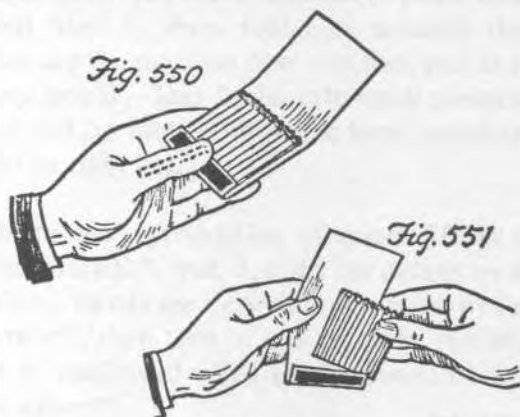

from folder), light it, blow it out, and vanish it with a sleight. Open folder to show burnt match. Tear it out before folder is examined, otherwise the crease at base of burnt match may be noticed. See "Tarbell", Vol. 3 p. 63 for details.

31. With a pair of scissors cut both layers of matches out of a folder, cutting them as close to staple as possible. Both layers are now replaced in folder, which looks unprepared when opened and shown. Hold folder as in Fig. 551. As left hand

## COMMENTS AND ADDITIONS

Source:

Date:





closes it, right thumb slides matches out of folder to a palmed position. Left hand offers folder to spectator who opens it and finds it empty. Can be used as a gag when handing friend a folder to use in lighting his cigarette. No need to glue the two layers of matches together. The heads interlock enough to keep them from sliding apart.

Another use for this principle was suggested by Ed Stoddard. In this case an extra layer of matches is secretly added to a full folder after it has first been examined. A number of matches are torn from the extra layer which is then palmed as folder is closed and handed to spectator. The group of matches are vanished, then found returned to folder. See HMM, April, 1951, p. 779, for details.

32. Tear off the cover of one folder, tearing it close to the staple in back. The cover is now slipped over a folder of different design, wedging front edge of cover beneath the striking flap. When held in left hand as shown in Fig. 552 the fingers will conceal



edge of fake cover in back, and folder can be shown on both sides without appearing gimmicked. Hold left hand so folder is upside down as shown, and stroke folder downward with palm of right hand. Back of hand should be toward audience. It is simple matter to palm off the extra cover, causing folder to change design suddenly. If seated, lap the extra cover and toss folder across table for examination.

33. The extra cover can be used in many other effects. For example, let us assume you have two

## COMMENTS AND ADDITIONS

Source:

Date:

match folders of different design—A and B. Write your initials on front of A. An extra cover, of design A, is placed on A and you are set to perform. Show both folders to audience. You initial front of A (actually initialing the extra cover) while a spectator initials front of folder B. Place both folders in a hat or under a handkerchief, slip cover from A to B. Remove B, which audience takes to be A, and place in pocket. Command folders to change places. Show A to be under hank, with your initials. Take B from pocket (without the cover) and let spectator check his initials.

34. This is Vernon's suggested handling of an effect in "Greater Magic". Spectator examines a full folder of matches. Your left hand has palmed an empty folder of same design, and right coat pocket contains handful of loose paper matches. Take folder from spectator and tell him you intend to make the matches vanish. Pretend to place folder in left hand, actually retaining in right, the left hand closing into a fist (with empty folder inside). Do this crudely as you want audience to suspect a pass. Place right hand in pocket, where you leave folder and grab a handful of matches. Pause while spectators insist you put the folder in pocket, then open left hand to show folder is actually there. But, you say the matches have vanished just as you said they would. Tear folder into small pieces and let them fall on table. Allow the loose matches to drop out of right fist.

35. Christopher's production of quarter from folder. See "Tarbell", Vol. 3, p. 61 for details on this fine effect. Hands are shown empty, cover of folder is torn off, then torn in half to make two small squares of cardboard. The coin is found between the two squares.

36. See "Phoenix", March 24, 1950, p. 796 for a self-working card effect worked out by Bill Simon and myself. Spectator tears out any number of matches from a folder of 11 matches, and the number is used for locating selected card in a packet of 7.

37. Inside of match cover is a handy place for pasting key lists of various sorts that are needed for certain mental effects. The key is consulted while extracting a match to light a cigarette.

## COMMENTS AND ADDITIONS

Source:

Date:



38. A folder of shiny metallic paper, left casually on the table, provides a handy "shiner" for many card effects.

39. Many useful pellet switches can be worked out using a match folder with duplicate pellet held against front of folder by inserting edge of pellet beneath striking flap. The switch is made during act of removing a match and setting fire to pellet.

40. For Stewart Judah's subtle pellet switch, in which the handling of folder and burning match play an essential misdirective role, see HMM, May, 1949, p. 545. The sleight is particularly useful in the trick of changing a check to a five dollar bill, and in Curry's I.O.U. effect in which a dime wrapped in flash paper changes to a penny.

41. Dr. Holdren of Columbus, Ohio, likes to use a folder for the well known "Cigarette from Nowhere". Cigarette is held in folder as in Fig. 553. After the usual pantomime build-up, take folder from pocket, tear off one of the exposed matches, strike it, then bring cupped hands to mouth to light the invisible cigarette. This automatically brings end of cigarette to lips.



42. Karrell Fox makes use of folder as a display stand for a card (Fig. 554). He shows wrong card with a double lift, then places chosen card in the stand, back toward audience. To reveal the change, he riffles edge of deck behind the card, causing a blast of air that topples card forward and face-up on table.

42a. Various attempts have been made to apply No. 32 (wooden matches) to a folder of paper matches. Spectator rolls an imaginary die, tells

## COMMENTS AND ADDITIONS

Source:

Date:

you the number. What are the best six "outs"? Louis Jaeger in "The New Phoenix", Feb., 1957, suggests a folder with five matches and a sixth wedged behind the base of the five where it cannot be seen. The numeral 3 is drawn on the inside of front cover where it can be concealed by thumb as cover is opened. The numeral 2 is written on back of cover, and 4 is written on front of cover behind the five matches. The six outs are:

1. Open folder, let the loose match fall out.
2. Turn over folder to show 2 on back.
3. Open folder to show 3 on inside of flap.
4. Open folder, thumb covering the 3, and bend back to show the 4 behind the matches.
5. Show that folder holds five matches.
6. Tear out the matches and drop on table, letting the loose sixth match come with them.

#### Stunts and Gags

43. Grasshopper. Split lower half of match stem and fold the two parts as in Fig. 555. Hold top of stem between thumb and forefinger and press the folded "legs" against table as shown. Release match. It will hop six inches or more into the air. Place two glasses close to each other, one upside-down, and make the "grasshopper" jump from the base of one tumbler into the other.

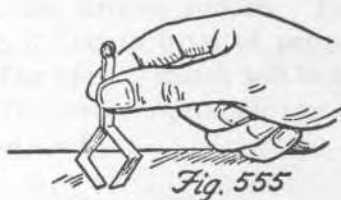

Another hopper: bend match in half and place the folded match on table, tip of finger forcing the head against end of match. Let head slip off finger. Match jumps forward about ten inches.

44. If you moisten tip of forefinger and press the end of a paper match firmly against it, match can be made to stand upright on the fingertip. When someone wants a light, strike a match, balance it

#### COMMENTS AND ADDITIONS

Source:

Date:





on fingertip, and extend hand as in Fig. 556. Match can sometimes be blown out without falling off finger.

45. Paper matches can be struck on glass by pressing the head firmly against glass with tip of middle finger, then dragging the head quickly across the glass. You may have to repeat several times before match lights. The heat generated by friction does it. Any hard smooth surface can be used in same way, even the surface of a dollar bill (see BILL, No. 12).

46. Apparently you tear a paper match from folder and strike it. However, when you extend hand to offer friend a light, the match proves to be a large wooden match of the kitchen variety. Before showing, the kitchen match is either palmed in right hand or carried diagonally in the folder behind the other matches. Pretend to tear out a match, then strike the wooden one.

47. Prepare several matches by splitting their stems up to the head, and carry them in front of folder. When two people both need a light, strike one of these matches. It can instantly be multiplied to what appears to be two burning matches. Hold one in each hand and offer the two lights simultaneously.

48. Ask someone if he would like a gift of a monogrammed cigarette lighter. Print his initials on a paper match and hand it to him.

49. Split one match near the head and push another through it (Fig. 557). Ask a seated person to



Fig. 557



Fig. 558

## COMMENTS AND ADDITIONS

Source:

Date:



hold the two ends of horizontal match between thumb and fingers of each hand. He is now instructed to shuffle his feet back and forth on the carpet. If you wish, tell him this is an experiment with static electricity, but assure him that the matches will not light and burn his fingers. While he is shuffling his feet ask him to turn the matches slightly to the left, then to the right. After this has gone on for a minute or so, slap him on the back and ask, "Aren't you a little too old to be riding a kiddie-kar?"

If victim is standing you can tell him to shuffle one foot only, then ask him if he isn't too old to be riding a scooter. Fig. 558 shows how one match can be split and used instead of two.

50. Close folder with one match outside of cover. Folder can now be balanced on back of hand, using match as concealed support in back (Fig. 559). Turn folder so striking surface is at bottom. As you do this, secretly bend match so folder will balance once more, as shown in Fig. 560.



Fig. 559

Fig. 560

51. When a light is requested, close folder with one match outside. Hold folder in right hand, bend over match with thumb, strike it by pushing its head across striking surface. Toss folder across table so it falls in front of person who asked for light. The upright match will be burning as in Fig. 561. The entire operation can be done quickly with one hand.



Fig. 561

Note that the burning match has a sharp bend in the middle. You can take advantage of this fact by striking a match as just described, then tearing out the bent match and magically extinguishing it as explained in No. 5.

## COMMENTS AND ADDITIONS

Source:

Date:



52. Karrell Fox is responsible for this topical bit. Close folder with three matches outside. The center match remains upright as in Fig. 561, but bend the outside matches so that the three together suggest a miniature candelabra of the type used by Liberace. Light the matches, smile beatifically, and murmur, "Ah — if George were only here.

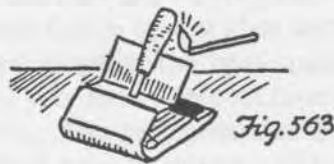
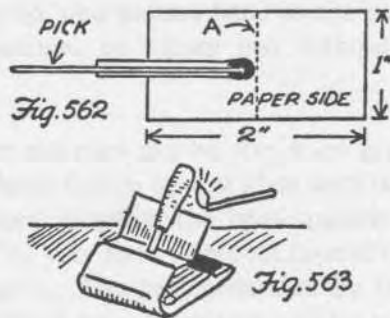

53. Miniature rocket. Place a toothpick (or a needle or pin) alongside match, then wrap both with a piece of silver paper from a cigarette package. The piece should be about 1 inch by 2 inches. It is not necessary to remove the paper from the foil, but if you can do so, the trick works better with the foil alone. Place match and pick on the paper side of the silver paper as in Fig. 562. Fold paper down on dotted line A, then wrap it securely around match and toothpick. Withdraw pick, leaving a small channel of space. Bend the cover of folder as in Fig. 563 so it will serve as a launching platform. Channel should be on underside of match. The flame of another match is held under the foil until the match ignites. It will shoot six feet or more across room.

After foil is wrapped around match and toothpick (instead of toothpick you can use an opened-up paper clip, needle etc.), you must run your thumbnail along both sides of toothpick to make a neat, tight channel. In the illustration, the folder is shown full of matches, but for safety reasons use empty folder for launching platform.

53a. Smoke from fingertips. Scrape the striking surface from several empty folders with well-used striking areas. Scrape this substance on a fifty-cent piece or in a saucer to make a small pile of powder. Heat with a match flame until it has completely burned. Blow away the ashes. A film will be left on coin. Rub tips of finger and thumb

## COMMENTS AND ADDITIONS

Source:

Date:

on this film. Now if you rub tips of thumb and finger together, it produces a bit of smoke.

54. Place a dime inside folder, behind the matches. Borrow another dime from victim and place it in folder also, but in front of matches. Close folder, show hands empty, then offer to sell him the folder for 15 cents. If he gives you 15 cents, let him have the folder. Since one dime is his, you profit five cents.

55. Bend an empty folder into a slightly curved shape. Place it face down on table and raise striking edge with tip of finger until folder overbalances (Fig. 564). It will turn a neat forward somersault. Several books can be placed in a pile to form a stairway. With a little care, folder can be made to somersault down the steps like a Slinky toy.

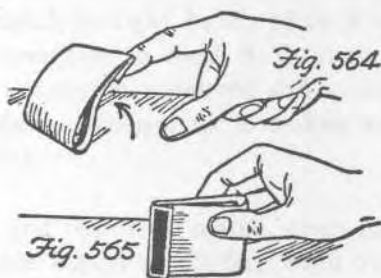

56. Spirit taps. Hold a new folder as in Fig. 565. Tap it three times on table then press the side against table and listen to three loud answering spirit taps. Taps are produced by pressing thumb firmly against cover, at same time pushing cover more tightly closed.

57. Insert cover behind all the matches and hold folder upside down as in Fig. 566. Place in left

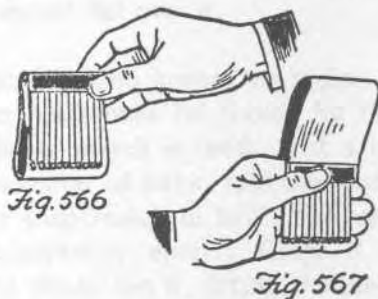

hand, the hand going between matches and cover. This levers cover upward to position of Fig. 567.

## COMMENTS AND ADDITIONS

Source:

Date:



Raise flap of cover with right hand to show folder apparently empty. Let cover fall forward and down, then take folder from left hand as shown in Fig. 568. Left thumb closes flap. Rotate folder forward so it faces audience. Snap it on the corner with a right finger, then open to show it full of matches. This is a slightly different handling of moves worked out by Bruce Elliott ("Phoenix", Aug. 11, 1950)

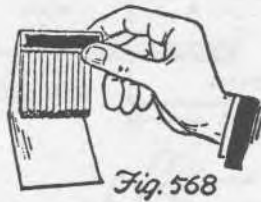

57a. Sick joke: twist the matches so they point in all directions. Toss open folder on table and say, "Made by the handicapped." (Alternate line: Made in Poland.)

#### Puzzles and Betchas

58. Pencil a spot on one side of match, two spots on the other. Hold match a foot above table and offer to buy spectator one beer if match falls with one spot uppermost, two beers if it falls with two spots uppermost. But if match drops and remains on its edge (hold edge of match against table to illustrate) then he owes you a beer. Before dropping, bend match in center.

59. Another version of above bet is to split the match stem up to the head, then give each half an outward curl. When match is held by the end it looks okay, but when dropped, the curled halves spread apart causing match to fall on its edge.

60. Bet someone he can't light all 20 matches in a new folder, taking them one at a time and giving each a single stroke only. Odds are high in your favor because as he nears the end, the striking surface becomes worn and matches light with difficulty. Best procedure for winning bet is to strike ten matches on one side of the surface, ten on the other.

#### COMMENTS AND ADDITIONS

Source:

Date:



61. A short piece of fine wire pushed into end of match will make it float upright in glass of water. Switch for unprepared match as you dry it with napkin, then challenge anyone to duplicate feat.

62. Allow match to burn completely, then challenge anyone to split the charred match in half lengthwise. Done by moistening the balls of both thumbs and squeezing match between them for about one minute. When you separate hands, a half of charred match will stick to each hand.

### MATCHES, WOOD

1. Prepare a man's handkerchief by pushing match into hem until it is an inch or so from corner. Two effects are possible. To vanish a match, throw a hank over left hand but bring the corner with concealed match beneath center of hank. Show a match in right hand, place it under hank and ask someone to hold it through the cloth. Actually, the match is palmed and spectator grasps match in hem. When hank is shaken open, match has vanished.

To break and restore a match, open hank flat on table. Place match in center. Fold over the corners, then grasp match through the cloth and ask spectator to break it. When hank is opened, match is found restored. Spectator of course breaks match in hem.

Other variations: (a) Duplicate match is in trouser pocket. Magician is seated and spreads hank over thigh. (b) Duplicate match is in tip of necktie. Hank is draped over hand and held close to chest so end of tie may secretly be brought up inside hank. (c) Duplicate match is under tablecloth. Hank is spread flat over it.

2. A spectator who knows the match in hem principle can sometimes be fooled by this variation. No duplicate match is used. Put a large kitchen match in center of hank, fold over corners, and let spectator snap match in half. This seldom breaks match completely apart. Grasp it through the cloth and straighten it, fitting the pieces carefully back in place. When hank is opened, match appears restored. If you wish, switch match at this point for an unbroken one. When spectator examines hank, he is surprised to find the hems empty.

### COMMENTS AND ADDITIONS

Source:

Date:



*[Faint, illegible text, likely bleed-through from the reverse side of the page.]*

*[Faint, illegible text, likely bleed-through from the reverse side of the page.]*





Another dodge: Simulate sound of breaking match by snapping thumb nail against a nail of other hand as you pretend to break the match.

3. Light a match and let it burn vertically until the head and about an inch of wood become thoroughly charred. Blow it out and hold as shown in Fig. 569. With left hand pretend to pull a hair from your head (or head of spectator). Wrap one end of the invisible hair all around head of burnt match. Now pretend to seize the loose end (you can add comedy here by pretending to drop the end, finding it again with some difficulty). Hold left hand a foot behind the match as shown.



*Fig. 569*

Pause and ask audience to keep their eyes on the match head. When you jerk left hand toward your body, head of match flies off as though severed by the invisible hair. This is done by pressing thumb firmly against match, then allowing end of match to snap off the fingernail. Nail of third or middle finger may be used. The nail is preferable to tip of finger because the loud snap which results will add to the effect. The trick is old, but continues to be one of the best of wooden match tricks.

A variation is to break match completely apart at the center then carefully stick the two pieces back again before performing. Match is not lit. Instead of the charred head flipping off when you pull the invisible hair, the match breaks neatly in two.

4. Place a match on left palm, head projecting over right side (Fig. 570). Rub a second match on left sleeve to "charge" it with static. When head of "charged" match is touched to underside of other match, a snap is heard and the match on the hand



*Fig. 570*

## COMMENTS AND ADDITIONS

Source:

Date:

jumps several feet into the air. Done by same secret snap described in (3). In this case you may need a stronger snap, so use tip of finger instead of fingernail.

A variation is to place match on center of palm, or on table, with head pointing away from you. When the match heads touch (Fig. 571), the free match flies backward toward you.



Fig. 571



Fig. 572

5. After lighting cigarette, magician holds burning match high in the air. When he blows down left sleeve (or takes cigarette from lips and blows against it), the burning match goes out. Match is held by extreme end with thumb and first finger (Fig. 572). Tip of third finger presses against middle of match, then match is snapped upward, off tip of finger. This will put out the flame.

Another method: Clip match firmly between first and second fingers, as though holding a cigarette. Snap the thumb upward so that thumbnail gives a strong flick to end of match.

6. Place one match across another exactly as in Fig. 573. "Charge" your right index finger (or another match, pencil, etc.) by rubbing it on sleeve, then place the finger as shown and draw it toward you. The top match rotates in direction of arrow as though its head were attracted by finger. Accomplished by secretly blowing toward the matches. See CIGARETTE Nos. 1 and 3, for similar effects in which matches may be used instead of cigarettes.

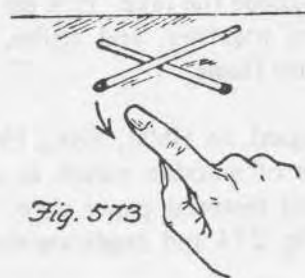

Fig. 573

7. Break a tiny piece from end of a kitchen match. If you break off head of another match, you will find you can push the head against broken end of first match and it will stick there. (Moistening the broken wood with saliva may help). Hold this double-headed match in left hand, the real head

## COMMENTS AND ADDITIONS

Source:

Date:

concealed. Light fake head with flame of another match. Blow it out immediately. Right hand takes match and in act of striking it, reverses the ends and knocks the burnt head into lap. Match ignites a second time, and may be examined.

8. Prepare some wooden matches by dipping their heads in black ink so that head and a portion of the wood is blackened. Carry these in your pocket until you have a chance to drop one into an ash tray. Tell audience that sometimes a burned match can be struck a second time. Take a genuinely burned match from ashtray and attempt unsuccessfully to strike it. Try once more, this time taking prepared match which looks exactly like another burnt one. It will of course strike easily. If you whittle match before you ink it, making it a trifle thinner below the head, the inked match will look even more realistic.

A good presentation is to have the fake match palmed. Strike another match, blow it out, switch it for the fake as you toss fake on table. State that as soon as it cools you will strike it again. Feel head of match, then jerk hand away as though head is still hot. Blow on head to cool it, then strike.

A more elaborate presentation was once suggested by Eddie Marks. Light a match, blow it out, and switch for the fake as you toss it on table. Go to pocket for second match, leaving burned match in pocket. Strike second match, blow out, and place on table alongside the fake. Pick up both matches, holding them together, and strike. Looks as if both burst into flame.

9. Jean Hugard, in HMM, Nov., 1953, p. 61 suggests the use of wooden match as a gimmick for the burnt and restored paper strip. The match is split as in Fig. 574 and duplicate strip is wrapped



*Fig. 574*

around it as shown. This match is taken from pocket and used for setting fire to the original strip. The match is easily discarded, leaving the strip in your hand to be produced from the ashes of the burned strip.

## COMMENTS AND ADDITIONS

Source:

Date:



10. A match is pushed head first into closed left fist. When it is pulled out of other side of fist, the match has mysteriously reversed ends. I have never seen this performed convincingly, but apparently it can be done. Of the many different moves that have been described, the best seems to me to be the handling of Harry Valcarte, p. 36 of Charles Eastman's "Expert Manipulative Magic", 1933.

11. If a loose fitting ring is worn on third finger, it may be used for vanishing several matches one at a time. Under cover of tossing motion, each match is pushed into the ring where it remains concealed behind the finger. The matches are reproduced by reversing the move. This trick was a favorite of T. Nelson Downs. See Dai Vernon's "Select Secrets" for a full description of the sleight as well as Down's excellent routine and patter for vanishing three matches one at a time, then producing them simultaneously in a fan formation. For Leipzig's handling, see Dai Vernon's "Tribute to Nate Leipzig", p. 150.

11a. Stretching a match. A long match, of type sold for lighting fireplaces, is in left sleeve. Hand is lowered so match drops to hand. A wooden match is held by fingers of both hands, its lower end touching head of long match. Right hand slides over short match, fingers grasp head of long match, and pull it up from left hand, apparently stretching the match. Short match is palmed off by right hand as left tosses long match to table or hands it to someone. See Dai Vernon's "Tribute to Nate Leipzig", p. 151.

#### Tricks Using Box

There are innumerable ways of "gimmicking" a box of matches — fake layers of matches, false ends, interior flaps, folded playing card on the back, etc.— all of which take the trick well out of the impromptu class. However, we shall include a few gimmicked boxes in which the required preparation is slight and the trick appears impromptu.

12. Acrobatic box. Open a wooden box slightly, place it upside-down on back of left hand, then close box so a bit of flesh is pinched by the drawer (Fig. 575). You may have to press a finger against

#### COMMENTS AND ADDITIONS

Source:

Date:





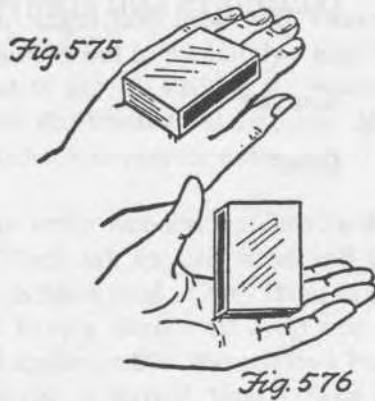

top of box to make it lie flat. Remove finger, at same time closing left hand into a fist. The box immediately stands on end. When hand is opened, box lies flat again.

If the flesh on back of hand is sufficiently loose, box can be made to rise and fall slowly. Some magicians find it possible to control box without bending fingers. Spreading thumb and pinky outward will tighten flesh enough to make box rise.

13. A variation is to place an empty wooden box crossways on left palm (Fig. 576), closing it so that it pinches the flesh at base of ring finger. Wave your other hand over the box and command it to rise slowly to a standing position, then slowly sink back again. The box's movements are controlled by an imperceptible motion of ring finger.

14. Walter Price was the first to think of making a match box rise and fall on a tablecloth by clipping a portion of the cloth at one end of the box. Again, a wooden box must be used. Place a half-match under the tablecloth, then close the box so this match goes inside the drawer (Fig. 577). The

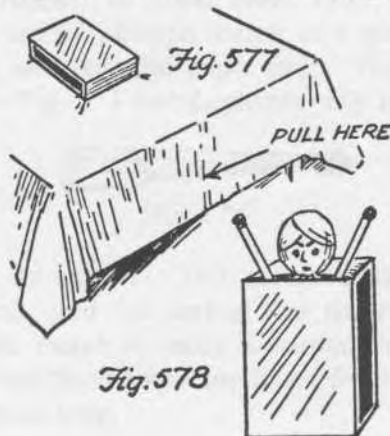

## COMMENTS AND ADDITIONS

Source:

Date:



match is necessary to prevent the pinched portion of cloth from slipping out. As you wave one hand over the box, other hand secretly pulls down on edge of tablecloth below the table. In this way the box is made to rise and fall.

Price suggests (in "Genii", Jan. 1946) dramatizing the trick by wedging three matches in the free end of box as shown in Fig. 578 to make the head and arms of an Arabian sheik. Do this after the cloth has been pinched at other end of box. The sheik's head is a wadded tissue fastened to center match with a rubber band. Sprinkle some salt around the box to represent the "sands of the dessert", and also to conceal the wrinkles where cloth is pinched. Hum some Arabian music. Price advises, using a table knife as a flute. Then intone a Moslem prayer while the sheik prostrates himself toward Mecca.

15. There are many ways to animate a match box by means of thread. The following method seems to me best. Cut a small slit at one end of the cover and attach one end of the thread (Fig. 579). Insert the drawer so thread goes around drawer lengthwise, as shown in Fig. 580. Other end of thread is fastened to front of coat.

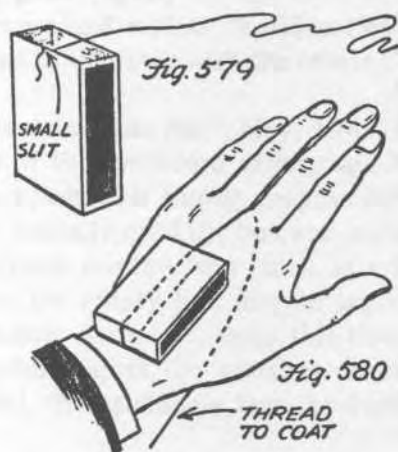

Place box on back of left hand near the wrist, the thread running forward between your fingers, then back to coat as shown. If you move the hand slowly forward, the box will creep along back of hand, then somersault over on its back. Finally, at end of box nearest you, the drawer will slowly open. As you hand the opened box forward for examination, the thread pulls from the slit and falls unnoticed against your clothing.

## COMMENTS AND ADDITIONS

Source:

Date:



16. Match box monte. Three match boxes – two empty and one partly filled – are on the table. The partly filled box is identified by rattling it. Spectators try to follow its position as you move the boxes about, but invariably guess wrong. The secret is a fourth box, partly filled. It is up your left sleeve where it is fastened to the wrist with a rubber band. When you shake an empty box with this hand, the rattling sound seems to come from the visible box. Naturally the spectators later guess incorrectly. You prove they are wrong by shaking all three boxes with your right hand. Work out your own routines.

17. Match tip vanish. Joe Berg discovered this odd principle many years ago. Break off the head of a match and put it on top of an empty match box cover (Fig. 581). The empty drawer is held upside-

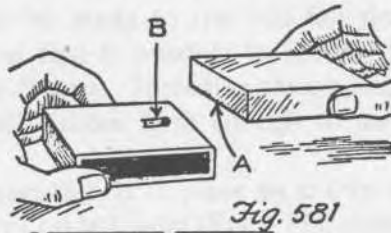

down in right hand as shown. Place edge A of the drawer on top of the match head, the edge touching the head at spot marked B. Slide the drawer to the right, carrying the match head with it. The drawer slides to the table, apparently with head beneath it. But if you press down on the drawer as you drag it off the cover, head will shoot to left, through the cover, and strike your left palm! This action is not visible to anyone.

Left hand now laps the match head as your right hand provides misdirection by picking up the cover and standing it on end on top of the inverted drawer. Command the head to vanish. When spectator looks under the drawer the head has disappeared. Joe Berg's somewhat different presentation may be found in his book "Here's Magic".

18. Suspended matches. This old trick (from Blyth's "Match-Stick Magic") is still a good one. The preparation consists of wedging a broken piece of match crosswise in the center of a partly filled drawer (Fig. 582). The piece must be long

## COMMENTS AND ADDITIONS

Source:

Date:

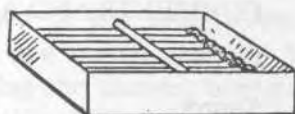

Fig. 582

enough to support the matches when the drawer is held upside-down by the ends (not the sides), but not too long, otherwise the sides will bulge so much that the drawer will not go into the cover.

The trick is presented as follows: Push out the drawer about an inch so audience can see that it contains some matches. Turn box upside-down, then very slowly, to build suspense, remove the upside-down drawer from the cover. The matches of course do not fall. The drawer should be held by the sides at this phase of the trick so you can apply pressure on the ends of the wedged match as you shake the box from side to side. This causes matches to rattle. You may even reach up into the box and remove one or two matches.

Take the box in your other hand, holding it carefully by the ends. State that when you snap your fingers, the matches will fall to table. As you snap the fingers, press slightly on the ends of drawer. This releases wedged match. It will not be noticed when it drops to the table with the others.

Sid Fleishman (in "The Bat", May, 1948) suggests using a box of the cardboard variety and having a duplicate box, which is empty, on your lap. After trick is over, casually refill the box and under cover of some suitable misdirection (such as a sneeze), switch it for the empty box in your lap. Repeat the trick exactly as before, only this time, when you snap your fingers the matches do not fall. Look puzzled, then suddenly tear the drawer into small bits.

19. Tom Sellers, in "Tricks That Work", 1927, explained the following effect. A box of matches is shown freely and attention is called to the fact that your hands are unmistakably empty. Unknown to audience, however, a match has been wedged between cover and bottom of drawer. Push out the drawer with your left finger, holding the end of drawer at the sides between thumb and middle finger of right hand (Fig. 583). The tip of third finger goes beneath drawer where it presses

## COMMENTS AND ADDITIONS

Source:

Date:

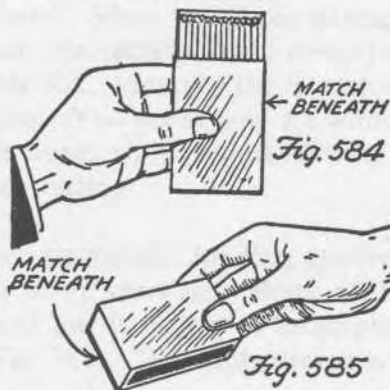
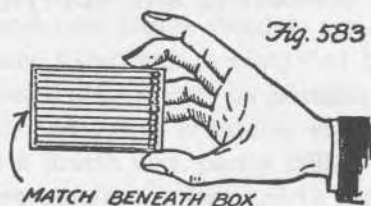

against head of match, keeping match firmly against bottom of drawer. Give the box a shake to rattle the matches, then hold up the cover so audience can look through it. As you replace drawer, the concealed match goes outside instead of inside the cover.

Close the drawer only halfway, then take the box in left hand as shown in Fig. 584. The left fingers retain the match as your right hand slides the box forward an inch or so until the match is brought beneath the cover. This enables you to close the drawer slowly and openly without revealing the match.

Now seize front end of box with right hand as in Fig. 585. Tip of middle finger presses head of match and keeps it in place against underside of box. Open left hand and place box flat on the palm. Tap the box then lift it to reveal a match on the palm.

With practice you can control two hidden matches in this way. The moves are the same except that you produce the matches one at a time. When you lift the box to reveal first match, hold box as in Fig. 585 so that tip of middle finger keeps the second match concealed. Drop first match on table, replace box on palm, tap it once more, then lift to show second match. If done cleanly, so audience sees the hands to be empty throughout, the trick can be made very effective.

## COMMENTS AND ADDITIONS

Source:

Date:



20. Hold box in left hand. Open it and appear to remove one match, actually taking two. In act of closing the drawer, one match goes under left thumb (Fig. 586). The matches in box should point to left, so head of concealed match goes under left thumb). Pretend you are trying to strike the match in right hand. Actually, let your fingernail scrape side of box. When you fail to light match, discard it. Now pantomime the taking of an invisible match from the box. Close the drawer, then pretend to strike the imaginary match on side of box. As you do this, seize end of concealed match and strike it. The effect is that the burning match appears suddenly in your empty hand. ("Greater Magic", p. 826).

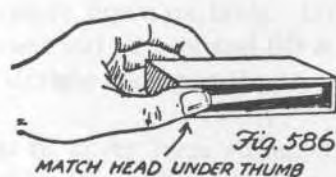

21. J. B. Ward, of Dewsbury, England, called my attention to this little known trick. Place a box on its edge, holding it firmly with left hand as in Fig. 587. One match is wedged between drawer and cover as shown, and second match leaned against it. Pretend to wrap an invisible thread around the head of leaning match. When you jerk the imaginary thread toward you, the leaning match suddenly topples over in the direction indicated by arrow.

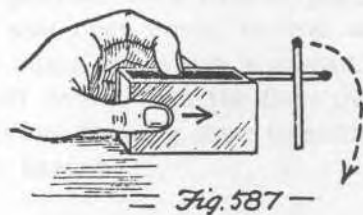

This is caused by pressing left thumb firmly against the cover and sliding it to the right. The thumb will slip an imperceptible distance, producing a slight "rap", at same time toppling the match backward. A spectator may be permitted to steady the box by pressing a finger down on the striking surface. He will feel a slight tremor as the match flies backward, but the cause of the action will remain a mystery.

## COMMENTS AND ADDITIONS

Source:

Date:



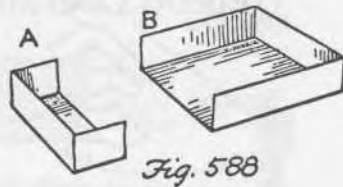

22. Drawer box. Empty the matches from drawer, then cut drawer into parts A and B, making the cut about one-half inch from end (Fig. 588). Replace drawer and fill it with matches. You can now make box appear empty by pulling out Part B, leaving matches and Part A inside the cover. Push back Part B, then open box by shoving finger against end of Part A. The box seems to have filled suddenly with matches.

23. Card trick. Secretly note number of matches in a box — let us say, 23. Fan 23 cards and have someone think of a card and remember its number from top of fan. Close fan and place the cards on top of deck. Now turn your back and ask him to take from match box the number of matches that corresponds to the number of his card in the fan. While your back is turned, secretly reverse the order of the top 23 cards. Then reverse top card of deck (formerly the 23rd card) and push it into pack near the bottom.

Turn around and hand deck to spectator. Open the box and count remaining matches. Chosen card will be at that number from top of deck. There is one exception. If box is empty then spectator thought of the 23rd card. Reveal it by spreading deck face-down on table.

24. Without opening a match box you can determine which way the heads point. Hold the sides between tips of thumb and first finger, exactly at center. Weight of heads will cause box to over-balance slightly at one end.

25. Match box may be used for secretly obtaining a silk or any small object that will fit into the cover in back of drawer when drawer is half open. The lighting of a match must play some role in the trick. After extracting match, closing the box automatically loads the silk or object into the hand. The use of match box for obtaining a cigarette in the "Cigarette from Nowhere" trick is too well known to require description.

## COMMENTS AND ADDITIONS

Source:

Date:



26. Dice force. Two tiny dice are glued at one end of an empty drawer, with desired numbers on top. When box is opened at other end, the glued dice cannot be seen. Show duplicate pair of dice, drop in box, and let spectator shake it. Open box at other end so spectator sees numbers on glued dice.

26a. Another die trick (contributed by Ben Christopher to "Pallbearers Review" in 1967) is to put into matchbox a die of such size that diagonally opposite corners, against top and bottom of box, keep die balanced on a corner. By squeezing you can cause die to fall in one of three directions. If drawer is cut in half, and one half inverted, you can open matchbox on either side and thus show any number called for on top of die. Or you can place box upside down on table. Either slide the inverted drawer out of box and lift it to show die, or turn box upright and open the drawer.

27. Removal of cover from string. Prepare cover of cardboard box by pulling it apart at spot where two flaps are glued together. Cover each flap with rubber cement and let dry. Place small strip of waxed paper over one flap, then put the flaps together. The paper prevents the flaps from sticking. The drawer is inserted and the box held by the sides to keep the flaps together.

To show the trick, remove the drawer of matches then push a long pencil or wand through the cover. Left hand continues to hold cover by the sides to keep it together. Cover with opaque handkerchief and have spectator hold ends of pencil. Beneath the cloth you open cover, remove waxed paper and roll it into a ball which is palmed. The cover is taken off pencil, then the flaps pushed firmly together before showing cover to audience. Cover can now be examined.

27a. Tom Sellers, in "Immediate Magic", has this idea for a removal of drawer from string. Drawer is secretly cut in half, and box contains a few matches. The string goes through a hole punched down through center of matchbox, or a pencil can be pushed through the box instead of string. Under cover of hank, remove both ends of drawer, exchange in sleeve for duplicate uncut drawer. Matches of course are replaced in duplicate drawer. Remove the drawer and matches from under hank, then take away hank to show cover still on string.

## COMMENTS AND ADDITIONS

Source:

Date:

28. Rattle box. Milbourne Christopher, in HMM, Dec. 1953, p. 77, explained Arthur Cowan's subtle method of using an empty match box as a rattle box. A cardboard box works best. Let spectator examine it and drop a quarter (or smaller coin) inside. Take box in right hand, holding it at one end by the sides, back of hand up. As you rattle it, gradually turn hand palm up, inverting the box. A pressure on sides of box will cause cover to bulge slightly, and coin will slide noiselessly into the hand. Place box right side up on table. Spectator later picks it up, finds it empty.

Another handling: Secretly invert box as you place it on left palm. Hold box by the sides, rattle it, then press on sides to allow coin to slide into hand. If you wish, adjust box so coin is on palm directly beneath it. By shaking hand up and down, the coin can be made to rattle convincingly against bottom of box. Right hand takes box and carefully places it on table. Later, when you pick it up to show that the coin has vanished, secretly right it.

A wooden box may be used by bending cover beforehand so it has a slight bulge. Another method of preparation is to cut about 1/16th of an inch from the edge of one end of drawer. This permits a half dollar to slide out easily.

29. Prepare empty box by opening the drawer half-way, then wedging a match inside, between cover and top edge of drawer where it cannot be seen. Several matches are counted as they are dropped into supposedly empty box. Close box and vanish a match. When box is opened it is found to contain an additional match. The principle can be applied to pennies, paper clips, etc.

30. Three empty match boxes, exactly alike, are shown. Each of three spectators writes his name on a slip of paper and puts it in one of the boxes.

The magician turns his back. The boxes are handed to him one at a time and each time he correctly identifies the name inside.

There are many variations in the presentation of this effect as well as ways in which the boxes may be prepared. Here is one method. With a razor

## COMMENTS AND ADDITIONS

Source:

Date:

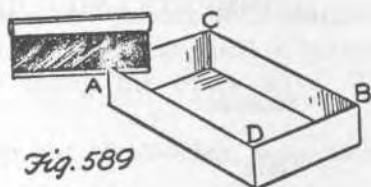

Fig. 589

blade cut corners A and B of one drawer (Fig. 589), cutting only about  $\frac{1}{16}$ th of an inch. Another drawer is similarly cut, but at corners C and D. Third drawer is unprepared. The cuts are easily found by the thumbnail. You must, of course, remember which names go in which boxes. Any reader have a better method?

31. Magician takes a handful of matches from a match box, then tosses box to spectator with request that he remove a portion of the remaining matches. The box is then closed. The magician counts his matches. Let us assume he has 20. He announces, "I have as many matches as you have, plus four more, and enough left to make 16." Spectator now counts his matches. Assume he has 11. Magician places his matches one at a time on the table until he has counted to 11. He puts four matches aside, then continues counting 12, 13, 14, 15, 16. The sixteenth match is the last one, as he predicted. The trick is repeated many times, though the prediction may vary in the final total as well as in the number of matches placed aside. It seems impossible for the magician to make his prediction without knowing the exact number taken by spectator.

When you take your matches, take over half of those in the box. This is to make sure that you hold about a half-dozen more matches than spectator. Count your matches. Now arbitrarily pick a small number, such as two, three, or four, and subtract it from the number you hold. Thus if you hold 17, subtracting 3 will leave 14. You now state, "I have as many matches as you have, plus three more, and enough left over to make 17." This will prove correct. Actually, you are merely counting your own matches, minus the number set aside! But as Blyth says, "the process has been so covered with verbal camouflage that detection is almost impossible to the uninitiated."

32. Tom Sellers, in "Tricks that Work", 1927,

## COMMENTS AND ADDITIONS

Source:

Date:



described the following effect. A match box is placed on table. Spectator rolls a die. Box is opened and found to contain a numerical feature that corresponds to number on die.

The working depends on preparing box so there are six different "outs." The box contains six matches – one is burnt, and two are marked with a pencil spot near the center. A large "3" is drawn on underside of drawer.

The six "outs" are as follows:

1. State that you will cause one match in the box to ignite. Open box slightly and pretend to blow out the burning match. Dump out the matches, calling attention to the single burnt match.
2. Wriggle a pencil above the box, stating that you are placing pencil marks on two matches. Open the box and show that this has been done.
3. Ask him to look at the number written on bottom of drawer.
4. Sellers suggested breaking the two marked matches in half to make four pieces, an extremely poor "out". George W. Hunter's suggestion (given in "The Sphinx", April, 1927, p. 66) was to have two matches facing one way, four the other way. Tell spectator he will find four matches pointing toward him.
5. State that you have six matches in the box, but to make the number of matches equal number on die, it is necessary to eliminate one match by igniting it. Pretend to blow out the burning match as previously described. Show that box contains five good matches.
6. Tell spectator you anticipated his number by placing exactly the same number of matches in box.

The trick is obviously subject to many variations. For example, instead of marking two matches with pencil dots, you can state that two matches in the box are reversed.

Howard Lyons, in "Ibidem", No. 26, Sept., 1962,

## COMMENTS AND ADDITIONS

Source:

Date:

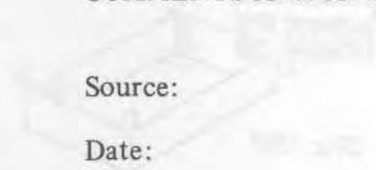



p. 30, proposed having four matches facing one direction (one of them glued to bottom of drawer) and two facing the other way. The six outs:

1. Dump out all matches, show one left in box.
2. Invert, slide out drawer, lift to expose two heads.
3. Same as No.2, but lift the other way to expose three heads.
4. Open box, show four heads.
5. Dump out five matches.
6. Open and show six matches.

Other ideas: The numeral drawn on underside of box (in original version) can be done with ink that becomes visible only when heated with match flame. Another large numeral can be drawn on inside of cover by opening one side of cover, drawing the numeral, rubber cementing cover together again. To display the number, tear open cover and unfold it. A sheet of paper can be folded into a rectangle that fits snugly in bottom of drawer under the matches. Dump out matches, take out the paper, unfold it. It says, "You shook the number. . ."

Bruce Elliott, in the "Phoenix", Oct. 23, 1953 proposed a new series of novel "outs" using a specially constructed match box. To add humor to the trick, Bruce suggests using the dodge of an invisible die. Pretend to remove it from your pocket and hand it to spectator. Ask him to roll the imaginary die and tell you what number he gets. After trick is over, pick up the invisible die and as you return it to your pocket, whisper that the trick never fails because your die is loaded.

32a. Sid Lorraine thought of having match waxed to under side of shoe. Pretend to take invisible match box from pocket, take out invisible match, strike it on shoe. As right hand is striking the match waxed to shoe, left hand obtains a cigarette from a coat dropper. Put cigarette to lips, light it.

32b. Match box can be used for switching objects, silks, etc., by having two drawers in cover. One

## COMMENTS AND ADDITIONS

Source:

Date:

drawer, containing object A, is inside the cover but projecting just enough from one end so second drawer can be pushed into other end. Left hand holds box, with empty drawer projecting and hand concealing projection of second drawer at other end. Put object B into empty drawer. Right hand pretends to push drawer into box, actually palms off drawer as left hand puts box on table with other drawer pushed flush.

Nick Trost, HMM, Jan., 1957, suggested having a dollar bill folded in concealed drawer. The other drawer is shown to contain matches. After right hand has palmed the drawer of matches, it holds box and shakes it so spectators hear sound of rattling matches. Left hand places closed box on table as right hand carries drawer to coat pocket, leaves drawer in pocket, comes out with a handful of matches. Box is opened. Matches are gone and there is a dollar bill in drawer.

32c. Vanishing matches in hank. Small elastic band is around one end of box. As left hand takes some matches from box, right thumb secretly slides band off end of box onto first two fingers of hand which are kept bent to conceal band. The loose matches are placed in center of hank. Right hand, beneath cloth, puts band over the matches so hank can be shaken and matches appear to have vanished. (Hatton and Plate, "Magicians' Tricks", page 423.)

#### Stunts and Gags

33. To strike safety match on sole of shoe, previously rub striking surface of box against instep of sole. Enough striking substance is transferred to sole to make match light.

34. Offer burning match to someone. When he takes it, your hand comes away with the flame, leaving stump of match in his hand. Match has previously been broken in half, but you hold the halves together as you strike what appears to be an unbroken match.

35. Hold match at lower end between thumb and middle finger. As you toss it in air, snap the finger, giving match a violent spin around its longest axis. If spin is strong enough, match will sail through air with an audible hum.

#### COMMENTS AND ADDITIONS

Source:

Date:

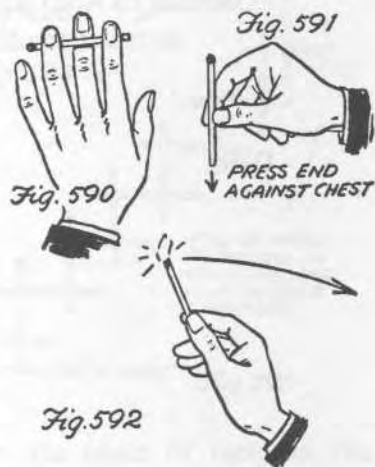

## COMMENTS AND ADDITIONS

Source:

Date:

36. A match held at tips of fingers (Fig. 590) is impossible to break with the fingers alone.

37. Dr. Jaks called my attention to this. Hold match as in Fig. 591 and press the end against your chest. At same time, press down on center of match with thumbnail, then let match snap off the nail. Match will jump forward six feet or more.

38. Matt Schulien grips burning match at extreme tip of lower end, holding it with tip of forefinger and nail of thumb (Fig. 592), and asks someone to blow it out. When they blow, match suddenly flies back in direction of arrow for six feet or so. Done by pressing thumbnail firmly against end of match, then lowering nail suddenly.

39. An amusing interlude occurred in Cardini's act when he tries to light his cigarette and the burning match suddenly shoots from his hand, making a high arc through the air to his right. Cardini's exact method is not known, but several descriptions of different grips on the match have been published. The best seems to be in "Willane's Wizardry", by Willane, 1947, p. 23.

40. A burning match suddenly becomes two, permitting you to give a light to two friends simultaneously. The match is prepared beforehand by splitting it to the head with razor blade.

41. By secretly moistening end of match with saliva it is possible to balance it upright on a hard smooth surface. Rubber cement can be used for similar feats, such as balancing match on fingernail,

on another match, edge of coin, corner of match-box, etc. The end (or head) of match, and the surface on which it balances, are coated with cement then allowed to dry before showing.

42. Remember how Joe Cook used to toss a burning match behind his back, then catch it in his mouth? This classic impromptu juggling feat must be done with a large kitchen match. Professional jugglers sometimes glue two matches side by side and slip a section of soda straw over them to make them resemble a single match. The extra weight makes the feat easier. Left foot is raised, match is struck on sole of shoe, then tossed immediately, while still in the first burst of flame. If match is tossed after flame subsides, it will go out.

Match is held by thumb and finger, extending back over the palm so that burning end points toward you. Held this way, the match has only to make a half-rotation before the end is caught by the lips. Right hand goes as high as possible behind back before releasing match, then you bend your knees and turn slightly to the left to catch it in the mouth. In this way the actual path taken by the match is made as small as possible.

Final perfection of this dramatic feat is to toss a cigarette first in this manner, catching it and holding it on one side of the mouth. Then the burning match is tossed and caught in other side, the cigarette is lit from the match flame without the aid of your hands. (Thanks to Larry Weeks for these details).

43. Small thin rubber band is stretched lengthwise around match, from end to end. Place match on inverted glass so its head projects slightly. Hold flame of another match to head of match on glass. As head ignites, elastic burns through, match is propelled forward like a rocket.

44. Whittle a match as shown in Fig. 593-A. Match A is placed crosswise like a miniature see-saw in the hollowed-out space of the whittled match, then other matches are added to form a chain as shown in Fig. 593. Head of match A rests on the table. By pressing on match B at the end of the chain, you can raise and lower the head of match A, although no movement of the intervening matches is noticeable!

## COMMENTS AND ADDITIONS

Source:

Date:



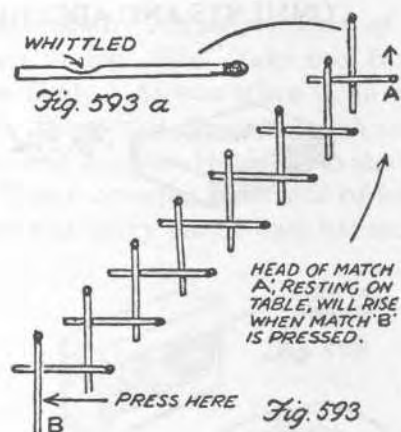

The longer the chain of matches, the closer the crossing points must be to the center of each match to obtain sufficient leverage. After all the matches are placed, carefully adjust position of match A so that a minimum of pressure is needed to raise its head. The stunt is not well known, although it appears in many old books on indoor recreations.

#### Stunts and Gags using Box

45. A burning match is extracted from box. As you remove match, it is struck on a piece of striking surface glued to underside of top of cover.

46. One hand holds a match. Box is tossed in air and as it falls, match is struck on side of box. Box must be heavily weighted inside. Easiest handling is to hold match in right hand, with the box flat on top of hand. Toss box upward, keeping it flat in the air, drag match across striking surface, then turn hand over and catch box, retaining burning match between thumb and finger. Some jugglers use a weighted box covered on all sides with sandpaper. It is tossed in the air with a spin, and a kitchen match struck on the box as it falls. Another method: match is struck on piece of sandpaper glued to tip of ring finger.

47. On some safety match boxes, the striking substance is put on unevenly, so that in spots

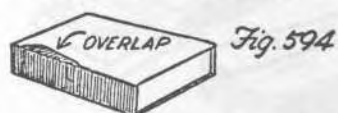

#### COMMENTS AND ADDITIONS

Source:

Date:



it slightly overlaps the top of cover (Fig. 594). If you drag a match quickly across top of box, passing the head over the bit of striking chemical at edge of box, the match will light. Looks as if match was struck on top of box.

## COMMENTS AND ADDITIONS

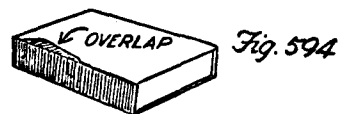

48. Make a small hole in the top of box near one end of cover and push a match into it so only head of match is outside. When the drawer is pushed out, this match emerges from the hole and stands upright. An amusing way to secure a match for a light.

49. Open match box, take out small folder of paper matches (or a tiny cigarette lighter) and use to light cigarette.

50. Six or more match boxes are placed end to end, forming a tower which is then balanced on top of hand or nose. The boxes are secretly locked in place by pushing a drawer at one end, causing each drawer to project a small distance into the next box.

51. A box apparently containing matches is handed to spectator, but when he opens it he finds it empty. "Greater Magic", p. 830, suggests that as you remove drawer to show it filled, left hand secretly pushes an empty drawer into the cover. Right hand pretends to put drawer back, but palms it. Another method: prove the box contains matches by shaking it. Box is really empty and the rattle produced by another box up your sleeve. It is fastened to the wrist with a rubber band.

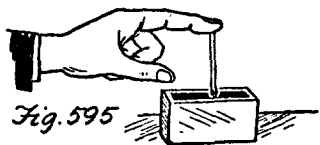

52. Left forefinger holds match against striking surface of box as in Fig. 595. Snap the match away with finger of right hand. It will ignite as it flies forward. On a porch at night, the effect is colorful, but you can waste lots of matches this way.

53. The human finger in the box (see BOX, No. 1) is even more startling, says Dr. Jaks, if done with a match box. The fact that the drawer slides out seems to preclude possibility of finger going into it

from beneath. Actually bottom of cover is cut as shown in Fig. 596. Take box from pocket and show freely. As you place it on right palm, secretly insert ring finger through bottom of both cover and drawer. Hold box as shown in Fig. 597, the thumb covering front side of box, and middle finger and pinky curled over left end. Push on left

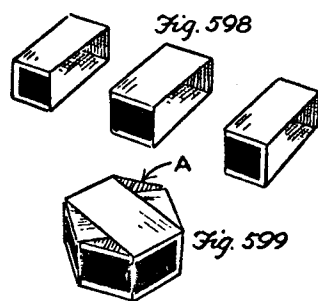
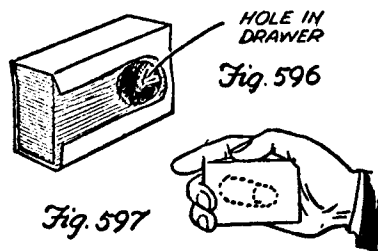

end of drawer to open it slightly, then slide cover to left (or remove it completely) to reveal finger inside. As previously explained, drawer should be lined with cotton which may be stained red at end where finger enters drawer.

54. If a cover is cut into three sections (Fig. 598) the parts will fit together neatly to form a tiny, attractive hexagonal pill box (Fig. 599). Section A slides back and forth, opening and closing box.

55. There are numerous ways to gimmick a match box so that a harmless joke results when victim attempts to remove a match. Here are some of them.

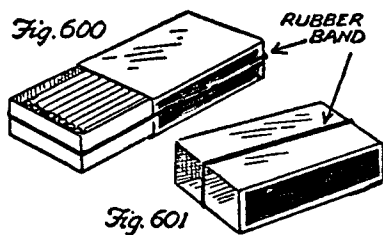

## COMMENTS AND ADDITIONS

Source:

Date:

(a) an elastic band circles box. Box is held half open (Fig. 600), fingers and thumb pressing the sides to keep drawer from closing. As he reaches for match, allow box to close suddenly.

(b) Rubber band is placed around cover only (Fig. 601) then drawer is pushed into cover against tension of band. Fingers and thumb keep drawer from coming out until victim starts to take box. Then you let drawer shoot into his lap, spilling the matches.

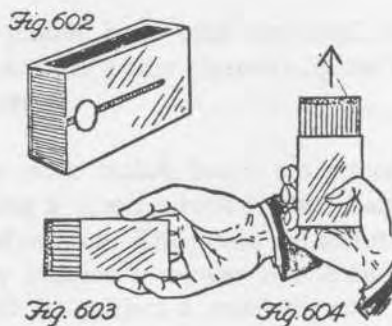

(c) Cut a slit in cover and push thumb tack into end of drawer as shown in Fig. 602. As you extend box to victim (Fig. 603) the nail of middle finger catches on head of thumb tack. As he reaches for match, middle finger slides the drawer mysteriously closed. The box may also be used for a rising drawer effect. Hold box as in Fig. 604, causing drawer to rise by sliding thumb tack upward with tip of forefinger.

(d) Glue drawer firmly to cover so it won't slide out.

(e) All matches in the box are without heads.

(f) Drawer is bottomless, allowing matches to fall in victim's lap when he opens box. Box may be filled with objects other than matches - e.g., marbles, BB shots, rice, beans, tacks, grape nuts, etc. As you hand him the box, ask him to see if he can count the number of beans, or whatever objects you have placed inside.

(g) Box is half filled with matches, but they are covered with a rectangle of glass. Glass is not

## COMMENTS AND ADDITIONS

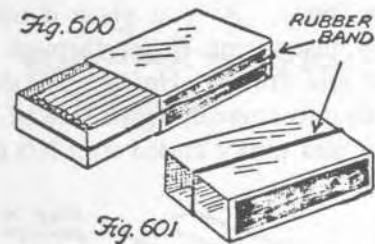

noticed until victim's fingers touch it.

(h) Prepare drawer so it has a bottom both above and below. In other words, completely closed on all sides, with the matches inside but no way to get at them.

(i) Both sides of drawer are removed, so ends of drawer become loose flaps. Glue drawer inside cover. When victim tried to open box, end of drawer collapses and his finger goes inside.

56. An effective rising drawer effect is obtained by placing elastic band around ends and sides of cover only, then inserting drawer. This produces less tension than having band around cover as in Fig. 601. Hold box vertically, thumb pressing against top of cover and fingers against bottom. Releasing pressure permits drawer to rise slowly upward.

#### Puzzles and Betchas

57. If a wooden match (especially the kitchen type) is ignited while its head presses against an object, then blown out, the head tends to weld itself to the object. This fact is the basis of several puzzles. In Fig. 605 the problem is to remove a coin (or any small object) from beneath the inverted glass without allowing match to fall. Similar problem: put glass over match before match falls, so match will be leaning against inside of glass.



Fig. 605

In both cases, solution consists of lighting the match with another match, then quickly blowing it out. The match will sometimes stick firmly enough to the saucer to remain upright when glass is taken away.

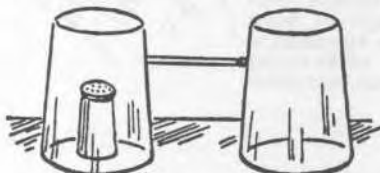

Fig. 606

#### COMMENTS AND ADDITIONS

Source:

Date:

In Fig. 606 the problem is to remove object from beneath one glass without match falling. The match head is ignited, then blown out to cause match to adhere to side of glass. The other glass can then be taken away. See BOTTLES No. 16 for for similar puzzle with three coke bottles.

## COMMENTS AND ADDITIONS

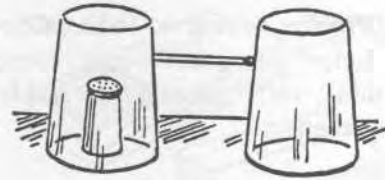

Fig. 606

58. Three glasses are placed close together in triangular formation. Problem is to rest three matches on their rims in such manner that the matches will support a salt shaker above the central space. A similar problem makes use of four glasses and four matches. See MATCHES, No. 35, for explanation of how matches are interlocked to form the supporting bridges.

59. If wooden match is bent in half without breaking it completely and a drop of water allowed to fall on the broken ends, the match tends to straighten. Several puzzles are based on this. In Fig. 607 the problem is to make the four bent

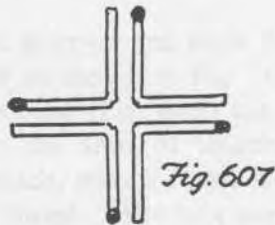
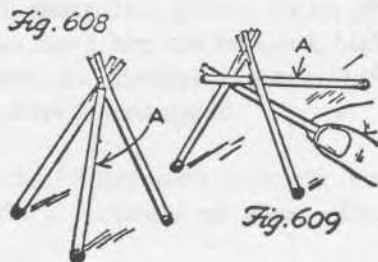

Fig. 607

matches form a four-pointed star without touching them. Some water on the broken ends does the trick. See BOTTLE, No. 15 for an ancient coin and bottle puzzle using same principle.

60. Split the ends of the two matches for about half an inch, then interlock the ends to form a "V." Invert the "V" and lean it against a third match (Fig. 608). Problem: lift all three matches with a fourth match.





The fourth match is held horizontally and inserted through the top of the tripod below the end of match "A". Pushing slightly against the "V" will cause match "A" to drop down and rest on the match you are holding. The end of match "A" is now maneuvered so it goes beneath the vertex of the "V", and the three matches are lifted as in Fig. 609.

COMMENTS AND ADDITIONS

Source:

Date:

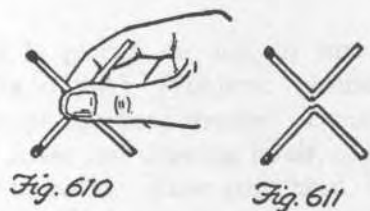

61. Two apparently solid matches are displayed as in Fig. 610 and spectator is challenged to form a square with the matches without breaking them. Actually, matches are already broken as shown in Fig. 611, making the solution a simple one.

62. Two matches are held as in Fig. 612. Right finger and thumb grasp the matches as pictured in Figs. 613 and 614. The hand may be turned in any direction without matches falling. This curious grip is extremely difficult for spectators to duplicate. The trick can also be done with table knives (See KNIFE, TABLE, No.22).

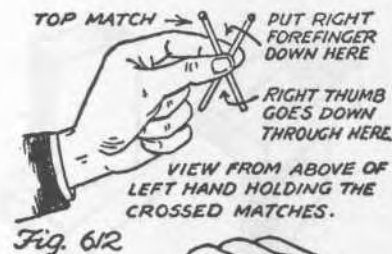

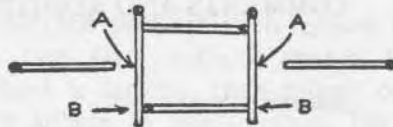

Fig. 615

63. Four matches are placed on table to form a square (Fig. 615).

Problem: lift them with the ends of two other matches. Most people attempt this by pushing the ends against the square at points marked A. The lift can only be achieved, however, by placing the ends at points marked B.

64. Dexterity test. Five matches are placed on table. Pick up first match between tips of thumbs,

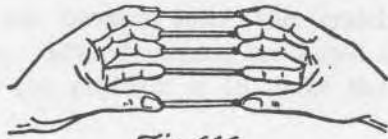

Fig. 616

next match between tips of first fingers, and so on until all five are held as in Fig. 616. Then replace them one at a time on table. The stunt is not particularly difficult.

65. It is said that Nate Leipzig sometimes used this amusing swindle to decide whether he or a friend picked up the tab. Nate would grab a handful of matches, break each in half, and toss the halves in a hat. He and his friend took turns drawing pieces with the understanding that person who took last piece would pay the check. Nate always drew first.

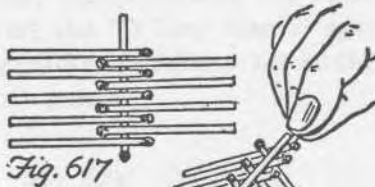

Fig. 617

Fig. 618

66. Ten matches can be lifted with one match as follows. Put a match on the table. On it lay nine matches, crossing the heads alternately as in Fig. 617. Tenth match goes on top, parallel with first match. If you lift lower match carefully by the end, the ten matches will hang from it (Fig. 618).

## COMMENTS AND ADDITIONS

Source:

Date:

67. An elaborate, stable bridge or archway of matches can be constructed in an ingenious manner too complicated to detail here. The stunt is explained in Vol. 1 of Tom Tit's three-volume French work, "La Science Amusante", and in many other early works on home pastime.

#### Puzzles Using Box

68. Cover is placed on top of inverted empty drawer (Fig. 619-A). Problem: reverse their positions without touching drawer. Done by placing mouth to cover and drawing in air, causing drawer to adhere to cover. Raise your head, bending the head back until drawer is on top of cover, then take cover from lips and place it on table (Fig. 619-B) with drawer resting on top.

69. Empty drawer is placed on its side and cover balanced on it (Fig. 620). Seems as if it would be easy to bring fist down on cover and smash both cover and drawer. But when tried, they both flip away.

70. Break open cover and place it on a smooth surface to form an arch (Fig. 621). Challenge spectator to make the drawer (placed on further side of arch) pass through the arch without touching either drawer or arch. He usually tries unsuccessfully to blow the arch over the drawer.

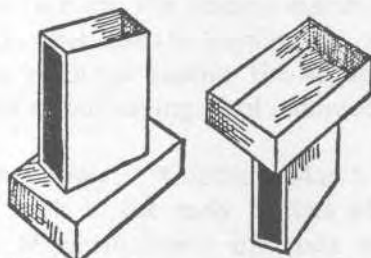

Fig. 619-A

Fig. 619-B

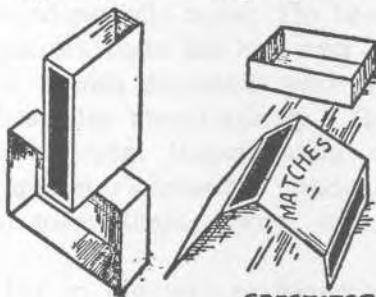

Fig. 620

Fig. 621 ↓

#### COMMENTS AND ADDITIONS

Source:

Date:

Solution is to place a cupped hand in back of drawer and blow against the hand. The blast of air is reflected by the hand, making it possible to blow drawer toward you and through the arch.

71. John Howie proposed this dexterity test in a 1954 issue of "The New Phoenix". The drawer (either empty or filled) is placed against upright cover as in Fig. 622-A. Rest tips of second and third finger against table and grip end of drawer between tips of first and fourth fingers. Lift drawer in this manner and deposit it on the cover (Fig. 622-B), keeping tips of other two fingers on the table at all times. Not easy.

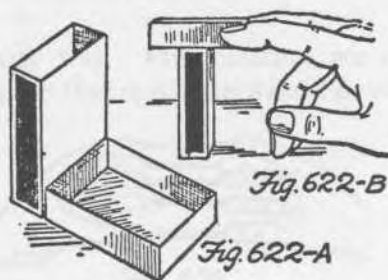

72. Full box of matches is held vertically and dropped to table from height of about a foot. It lands on one end and remains standing. When others try, the box lands and falls over. Secret is to let drawer project half an inch upward from cover before box is dropped. Projecting drawer is concealed by the hand as it holds box. When box strikes table, the inertia of drawer sliding flush with cover will stabilize the box and keep it standing.

73. Wedge two matches in sides of box (Fig. 623) and place third match between their heads as shown. If horizontal match is ignited at the center (with the flame of another match), which of the other two matches will ignite first? Neither. Horizontal match will burn a moment, then break and

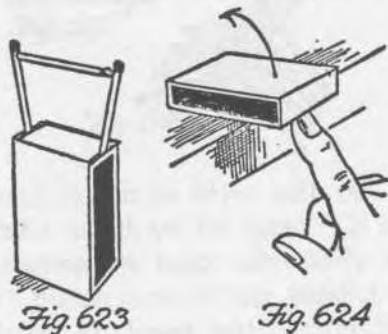

## COMMENTS AND ADDITIONS

Source:

Date:

snap away before flame reaches other matches. Another variation is to lay third match on top of the heads of other two matches. In this case the burning match will fall off before either head ignites.

74. J. E. Bowden, of Lanconshire, England, called this to my notice many years ago. Empty match box is placed on edge of table with one end projecting (Fig. 624). Place one finger beneath projecting end and raise box until it remains standing on other end. With some boxes this can be done only if drawer is right side up at the start. When spectator tries, see that drawer is upside down. *Weight of drawer's bottom will cause box to topple forward after it is raised to standing position.*

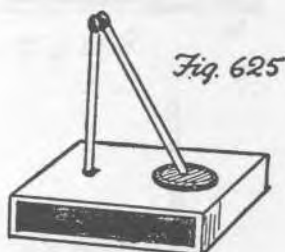

75. Push a match into top of box (Fig. 625) and balance another against it as shown. A penny is beneath the leaning match. Problem is to remove coin without knocking match over. Done by setting fire to leaning match at its center. The heads will soon ignite and fuse, then as the matches continue to burn, the leaning match will be raised in the air. Because the burning matches somewhat resemble a couple kissing, the stunt is sometimes presented as portraying a hot embrace.

76. Tom Boyer's "Contrary Match Box" was a popular trick in the early thirties when first marketed. Magician holds one box and spectator another. Each starts with drawer of his box right side up and partially open. The boxes are closed, then magician turns his box over slowly several times in various directions while spectator tries to duplicate the moves exactly. The drawers are then pushed open. Magician's drawer is right side up but spectator's drawer is upside down. This is repeated many times, always with same result.

Secret lies in the way performer's box is gimmicked. Empty the drawer, cut in half, turn one half upside down, fasten the halves together with

## COMMENTS AND ADDITIONS

Source:

Date:





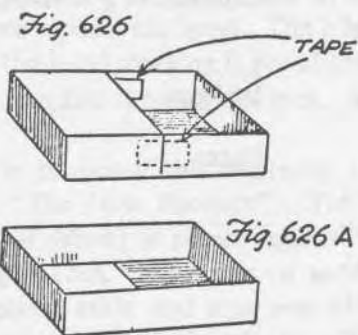

cellophane tape on the inside of sides (Fig. 626.) Refill drawer with matches and return it to cover. It is easy to work out routines for turning gimmicked box so at the finish its drawer can be shown apparently right side up although drawer of spectator's box will be inverted.

The trick must be performed with boxes that are the same on top and bottom of cover. Such boxes are rare, so you may have to prepare them by soaking off box labels and pasting them on underside of the two boxes used. An unprepared third box may be carried in your pocket for exchanging with gimmicked box after you have done the trick a few times.

Grady Nicholson once proposed another method of preparing box. Simply cut away half of the bottom of drawer (Fig. 626A.). When box is filled with matches the preparation is hidden. This box permits turning routines not possible with the other type.

### Games

77. Each contestant holds four matches between thumb and forefinger as in Fig. 627, and presses them firmly against the flesh until someone calls "Go!" Each person removes his thumb from matches. The matches tend to stick to finger and dangle in air for several seconds before they drop. Someone counts to fifty, then each person scores a point for every match still hanging on his finger. First to reach a specified score wins.



### COMMENTS AND ADDITIONS

Source:

Date:



78. Party game. Two rows of guests are formed. Empty cover is stuck on nose of leader of each row, then passed along the row from nose to nose without aid of hands. First row to finish wins.

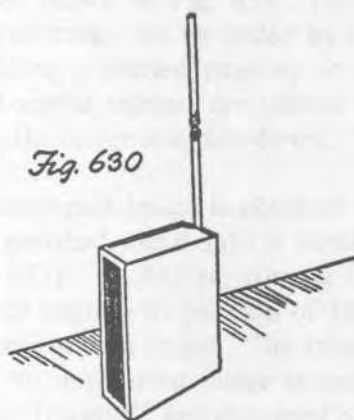
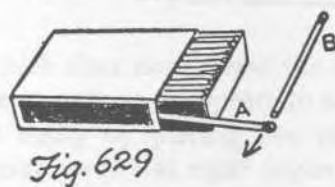
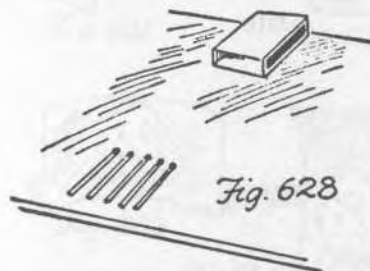

79. Place empty cover on table (Fig. 628) in front of row of matches as shown. Snap matches one at a time with finger and try to shoot them through the cover. Matches may also be snapped by means of device pictured in Fig. 629. The box is held firmly by left hand while right hand pulls back wedged match "A", then releases it so its head strikes end of match "B". Match "B" shoots forward like a ball in a pinball machine.

80. Place heads of two matches together, hold them in a flame until they ignite, then quickly blow out. This welds them together. Wedge them upright in a match box (Fig. 630). Balance another match on tip of left finger. Snap it with finger of other hand and try to shoot it forward so it knocks off the higher of the two welded matches.

81. A bottle is placed upright in center of table

## COMMENTS AND ADDITIONS

Source:

Date:

and players take turns balancing a match horizontally across neck of bottle. In this way a tower of matches is formed. When one or more matches fall, the player then attempting to place a match drops out of game. Game continues until only the winner remains.

## MILK

1. A tiny amount of cream, stirred into glass of water, will make the water resemble milk. One of Bert Allerton's pranks at the Chicago Round Table is to switch a guest's glass of milk for a glass of water doctored in this manner. Guest usually takes several swallows before he realizes something is amiss.

## MILK CARTON

Empty milk cartons, rinsed with cold water, can be used for constructing a variety of toys, games, models, and apparatus for science experiments. See "Science Fun with Milk Cartons", by Herman and Nina Schneider, 1953.

1. A milk carton cut along dotted lines as shown at left of Fig. 630a, will make an amusing little replica of an outhouse as shown on right.

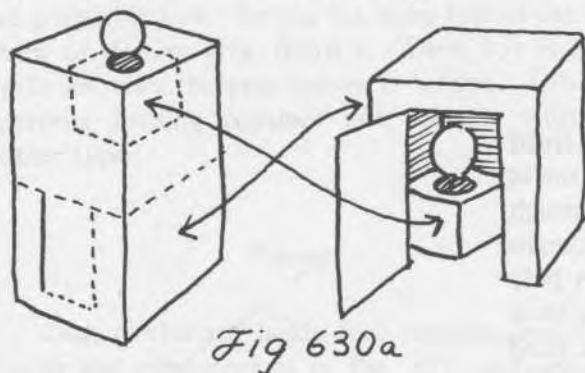

## MIRROR

Many clever toys, pieces of magic equipment, and devices for science experiments can be built with the aid of mirrors. Such items will be found described in the literature of scientific recreations. Here we shall limit our attention to simple tricks and stunts which make use of wall mirrors or small hand mirrors.

1. The unreversed image. If we look into an ordinary mirror we see a reversed image of our face.

## COMMENTS AND ADDITIONS

Source:

Date:

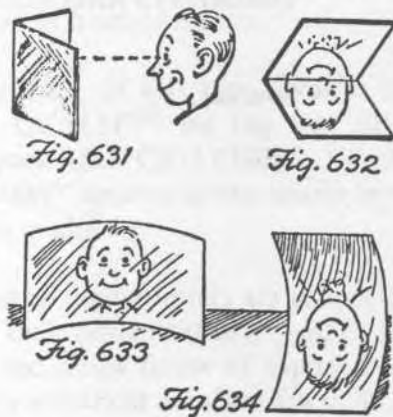

## COMMENTS AND ADDITIONS

Source:

Date:

A mirror which does not reverse the image, showing our face exactly as it appears to others, can be constructed easily by placing two mirrors (preferably without frame) at right angles and looking into them as shown in Fig. 631. The unreversed quality of the image can be tested by winking one eye, or holding a printed page up to the mirror. If the right-angled mirrors are turned to position of Fig. 632, the image is upside-down.

A similar unreversed image is obtained by bending a piece of polished metal into a slightly concave form (Fig. 633). As before, turning the concave mirror ninety degrees to position of Fig. 634 produces an upside-down image. The ancient method of forming an unreversed image is mentioned by Plato in the "Timaeus", and discussed by Lucretius in the section on mirrors in Book 4 of his poem "On the Nature of Things".

2. Personality test. Few people have perfectly symmetrical faces, a fact easily tested by placing the edge of a pocket mirror vertically on the nose of a front-view photograph. Viewed from the left, you see a composite face formed by two right sides of the person's face. Turn the mirror the other way, look at it from the right, and you see a composite of two left sides. The two faces are often quite different.

A German school maintains that the two composite faces indicate two basic sides of a person's personality. This theory is universally rejected by leading psychologists, though it has been taken seriously by Dr. Werner Wolff, of Bard College.

See his books, "The Expression of Personality", 1943, and "The Threshold of the Abnormal", 1950.

3. Coordination test. Draw a simple design, such as a five pointed star, on a sheet of paper. Place it on a dresser in front of the mirror. Pile some books on the dresser to prevent you from seeing the paper directly. Now reach around the books with a pencil, and by looking in the mirror, try to trace the outline of the star with the point of the pencil. More difficult than you might suppose.

4. The hexagonal designs of a kaleidoscope are created by two mirrors at a sixty degree angle to each other. This can be illustrated simply with two pocket mirrors by placing them on a colored illustration of a magazine (Fig. 635), holding them



at a sixty degree angle to each other. It is easy to find correct angle by looking into the mirrors and adjusting them until a hexagonal pattern forms. Keeping the mirrors at same angle, slide them to another part of page. Every spot shows a beautiful hexagonal design. Moving the mirrors in slow circles over the page results in a rhythmic motion picture of shifting abstractions. Quadrilateral designs are obtained by holding the mirrors at right angles.

5. Word and figure reflection stunts. If printing is held up to a mirror (or the paper turned over and held to the light, the words naturally appear reversed. Certain letters and figures, however, are symmetrical in respect to either their horizontal or vertical axis. The former appear unreversed when the printing is held upside-down in front of a mirror, or when a small mirror is placed above or below them. The latter appear unreversed when the printing is held right-side-up to a mirror, or when a mirror is held to the right or left sides. Other letters and figures are so constructed that they change to different letters and figures when they are reflected. These facts make possible a number of curious reflection paradoxes which we shall consider under two categories.

## COMMENTS AND ADDITIONS

Source:

Date:



A: Paradoxes that result when paper is held upside-down in front of mirror.

The classic trick of this type involves the words "CHOICE QUALITY" on the side of a Camel cigarette pack (See CIGARETTE, No. 30). The word "Quality" appears in the mirror reversed but "Choice" is unaltered.

The following capital letters are symmetrical with respect to their horizontal axis – B, C, D, E, H, I, K, O, X, and script forms of capital J and lower case F. (Symmetrical numbers are 0, 1, 3, and 8). Words formed from these letters appear unreversed when held upside-down before a mirror.

"Choice" is one of the longest words of this type. A partial listing of other words includes Bob, Bobbie, box, book, boob, boo hoo, beech, code, coke, cookie, cook, cob, choke, cheek, check, chick, chide, chic, choo choo, dock, deck, Dick, deed, do, died, did, dice, Dixie, Ed, echo, excede, hock, hobo, hide, he, heck, heed, hick, hood, hook, ice, Ike, I, kick, kid, kiddie, ox, oh, ode, oboe.

An interesting presentation is to print a group of these words on a sheet of paper, using colored pencil. With an ordinary pencil, print a series of words which you know will appear reversed in reflected form. Explain that your colored pencil is a new scientific discovery – a pencil capable of writing letters which are not reversed when viewed in a mirror. When you hold the page to a mirror, turning it upside-down but without calling attention to this fact, all the black words will appear reversed whereas those printed in color remain the same.

A phrase such as "CHOICE WATERMELON" can be printed, using colored pencil for "CHOICE" and black pencil for "WATERMELON". The mirror reverses one word but not the other. If a spectator's first name is DICK, EDDIE, or BOB, you can print this name in color and his last name in ordinary pencil. The mirror reverses his last name only. The phrase "HE CHECKED BOX C.O.D." appears unreversed in reflected form. Better phrases than this can probably be formed from the

## COMMENTS AND ADDITIONS

Source:

Date:

required letters.

The following letters change to other letters when viewed upside-down in a mirror. M changes to W (and W to M), lower case "b" to "p" (and vice versa), lower case "d" to "g" must be written with a straight line for the tail. Also, "n" changes to "u" (and vice versa). Among figures, 2 can be printed so it becomes 5, and vice versa. These changes make possible a number of stunts. For example, print the phrase "Bob kicked pop" as shown in Fig. 636. To find out what happened next, hold the paper upside-down to a mirror and read "Pop kicked Bob."

Fig. 636 also shows how "Choice dice - 50 cents" may be printed so that in the mirror the price is mysteriously lowered to 20 cents although the rest of the phrase remains the same.

**bob KICKED pop**

**CHOICE DICE-50¢**

*Fig. 636*

Words also may be printed vertically down the page, then held upside-down to the mirror. A word like "dig" in lower case will remain "dig", for example, whereas a word like "big" changes to "dip."

**B:** Paradoxes that result when paper is held right-side up to mirror.

The following capital letters are symmetrical with respect to their vertical axis: A, H, I, M, O, Y, U, V, W, X, Y, lower case "r" and script forms of "e", "l", and "r" as well as script forms of letters already cited. (Among the numerals, 0, 1, and 8.) Words formed from these letters can be printed vertically on the page and will appear unreversed in the mirror. For example, print "Tomato" in colored pencil and "Celery" in black.

T	C
O	E
M	L
A	E
T	R
O	Y

## COMMENTS AND ADDITIONS

Source:

Date:

Held to the mirror, "Celery" is reversed but "Tomato" remains the same.

If words such as TOMATO are printed horizontally, the letters remain the same in the mirror but the order of letters will be reversed unless the words are palindromes (that is, spell the same backwards as forwards). TUT TUT or TOOT TOOT will obviously not be changed by the mirror, and perhaps palindrome sentences of this type can be constructed. Some words will change to other words. For example MA and AM are mirror images, suggesting sentences that may read as different sentences in the mirror.

Although no capital letters change to other letters when viewed right-side-up in the mirror with the exception of Z and S (which can be formed so they are mirror images of each other) among lower case letters "b" and "d" are mirror images, as well as "g" and "p" (when "g" is written with a straight tail). Also script forms of "f" and "j". This opens up still wider possibilities, since capital and lower case forms of letters may be mixed together and still be readable. For example, words such as "bid" and "pig" can be printed horizontally so they remain the same in reflected form. Other words will change to different words, such as "bib" becomes "bib" regardless of whether it is written horizontally or vertically. "Bad" remains "bad" when horizontal, but changes to "dab" when printed vertically. "tag" changes to "tap" when vertical, and to "pat" if printed horizontally.

Certain numbers can be formed in such manner that their reflections are letters, namely: 1 (I), 2 (S), 3 (E), 4 (N, P, or H), 6 (J), 7 (T), 8 (G), 9 (P), 0 (O). Thus 306 and 314436 can be written to form JOE and JENNIE when reflected (Fig. 637). Columns of numbers can be worked out

306  
314436  
*Fig. 637*

which appear to be sums but when held to a mirror (or the paper reversed and held to a light) become amusing sentences, as for example, the

## COMMENTS AND ADDITIONS

Source:

Date:

$$\begin{array}{r}
 \text{Fig. 638} \quad 7192 \\
 \quad \quad \quad 41 \\
 \quad \quad \quad 347 \\
 \hline
 40077192
 \end{array}$$

$$\begin{array}{r}
 \text{Fig. 639} \quad 3414 \\
 \quad \quad \quad 340 \\
 \hline
 437
 \end{array}$$

$$\begin{array}{r}
 \text{Fig. 639A} \quad 3414 \\
 \quad \quad \quad 340 \\
 \quad \quad \quad 74813 \\
 \hline
 43374813
 \end{array}$$

sum shown in Fig. 638. Fig. 639 and Fig. 639-A also appear to be incorrect sums, but they become correct when viewed in the mirror.

I have gone into this odd topic in some detail, partly because it has never been analyzed before and partly to suggest the possibilities for amusing mirror gags which have yet to be explored.

Transparent glass or plastic stirring rods can be substituted for mirrors in many of the preceding stunts. The rods turn printing upside-down when held over the line, and provide left-right reversals when held vertically over words that are printed vertically.

6. Practical joke. To make a mirror appear broken, draw the cracks on it with a piece of soap.

7. For some people mirror writing (writing which appears correct only when seen in a mirror) is easy. Leonardo Da Vinci, for instance, kept his notes in mirror script to make them difficult for snoopers to read. Others find mirror writing difficult. If, however, they try holding a pad of paper against their forehead and writing from left to right, the task often becomes surprisingly simple.

## COMMENTS AND ADDITIONS

Source:

Date:

JOE  
JENNIE  
MAY

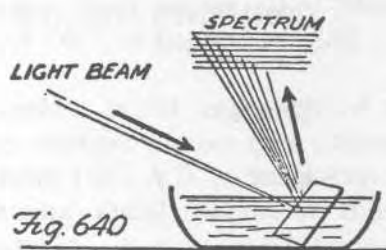

8. Submerge a small mirror in a bowl of water (Fig. 640) and allow a beam of light to shine on it as shown. The reflected beam will be refracted by the water, projecting a color spectrum on the wall or ceiling.

9. Senator Crandall suggests carrying with you a dentist's mouth mirror—a rod with a small mirror on the tip. When a waiter places a bill face-down on the table, you can amuse your friends by surreptitiously lifting one corner of the bill, then slipping the mirror under it to read the total without picking up the check.

10. To reveal name of chosen card, number, word, etc., have spectator letters or figures appear. Mirror is breathed-on hand or wall mirror. Then prepared as follows: Dissolve small amount of detergent in glass of water. Dip finger in liquid and write on mirror. If it leaves a whitish film when dry, rub off film with a cloth. Breathing on mirror causes surface to mist everywhere except on spots touched by finger. Same result can be obtained with tissues sold to prevent spectacles from fogging. Roll tissue into small ball and write on the glass with it. Works best of course when mirror is cold. A window pane may be used if room is too warm and temperature is lower outside.

## MNEMONICS

Mnemonics (from Mnemosyne, Greek goddess of memory) is the art of memorizing difficult material by means of ingenious mental "systems" or devices. Reference to such memory aids are found in the writings of many Greeks and Roman authors. A popular ancient device for recalling a list of items was to imagine each item at a certain spot inside a particular room of a large house or group of houses with which one was familiar. By making a mental tour of the rooms, along a predetermined route, the items could then be recalled easily.

## COMMENTS AND ADDITIONS

Source:

Date:



This device, still used by memory experts, was credited by several ancient authors to Simonides, a Greek poet who flourished around 500 B. C. Legend had it that after leaving a banquet, at which he had recited some of his poems, the roof of the building collapsed, killing the guests. The bodies were so mangled that it was impossible to identify them. Fortunately Simonides remembered each guest's position in the room and thus the identity of each body was established. On the basis of this legend, Simonides was popularly regarded as the founder of mnemonics.

It was not until the late Middle Ages that special treatises on the art of memory began to appear. In the Renaissance, mnemonics enjoyed a huge and fashionable popularity. Giordano Bruno, elaborating on the geometrical mnemonic diagrams of the Spanish mystic, Raymond Lully, produced many weird treatises on the art, and for a time earned a living by teaching mnemonics to wealthy Italian dilettantes.

Original works in English began to appear in the latter half of the seventeenth century. The most popular and influential early British work was Richard Grey's "Memoria Technica", 1730. In the United States, the first book on the subject was "Mnemonika", by Edward J. Coale, Baltimore, 1812. The first published bibliography seems to be the one which appears in a nineteenth century British work, "The New Art of Memory", 1812, by a German monk, Gregor von Feinaigle.

Since the time of Feinaigle, hundreds of books and pamphlets on the subject have been published. David M. Roth's "Memory Course", originally issued as seven booklets in 1918, later reprinted as a single volume by Sun Dial Press, is still one of the best references on modern mnemonics. The recent books of Bruno Furst, and Harry Lorayne also are excellent and readily obtainable surveys of the art.

A brief history of mnemonics may be found in the current edition of "Encyclopedia Britannica". As is so often the case, this is a cut version of the article which appears in full in the same encyclopedia's eleventh edition. The article in turn is based largely on the history by A.S. Middleton and the bibliography of G. S. Fellows, both of which were

## COMMENTS AND ADDITIONS

Source:

Date:

issued as a single volume, titled "Memory Systems, New and Old", in England in 1888.

The world's largest collection of mnemonic literature, containing more than a thousand different titles from 1466 A.D. to the present, was gathered by Bernard Zufall, of Forest Hills, New York. The collection is now owned by the Yale University Library, in New Haven, Conn. An interesting description of this collection, by H. Adrian Smith, appeared in "The Linking Ring", June, 1939. The assistant commercial vice president of General Electric, Mr. Zufall is well known for his club appearances as a memory expert and as the author of six booklets which he issued in 1940 under the general title of "Zufall's Memory Trix".

Another enormous collection has been made more recently by Morris N. Young, of New York City, whose "Bibliography of Memory" was published by Chilton Co., 1961.

What follows is a brief glance at some of the current methods employed in the presentation of memory feats for entertainment purposes.

#### Word Lists

A long list of words called out by an audience can be memorized quickly without the aid of a previously memorized list of key words. Simply link the words in a continuous chain of fantastic mental associations. The list can then be repeated forward, and without too much effort, backward. However, if the words are numbered you cannot quickly call out a word for any given number.

To be able to state quickly the word at any given number on a list, or conversely, the number of any called-for word, you must previously fix in your memory a basic list of numbered words. As spectators call out each word, it is associated mentally with the corresponding word on your basic list. Dozens of such lists have been published, with many ingenious gimmicks to aid in memorizing them.

Al Baker, in "Ways and Means", offers a useful suggestion. After each word is called out, ask the person who called it to give you some additional details. For example, if his word is "wine",

#### COMMENTS AND ADDITIONS

Source:

Date:

ask him what type of wine; if imported, from what country, and so on. These details are extremely easy to recall, and by reciting them later the feat is made more impressive as well as more entertaining.

### Numbers

A tremendous advance in mnemonic methods occurred in 1648 when Stanislaus Mink Von Winckelmann, of Germany, proposed that digits be symbolized by consonants. Numbers could then be transposed to words and the words memorized by systems such as those discussed above. To recall the numbers it would then only be necessary to translate the words back to figures again.

Winckelmann's original number alphabet was a crude one, but it was quickly improved by later memory experts. The German philosopher Leibniz was fascinated by it and wrote a brief treatise on the number alphabet. Lewis Carroll worked out an alphabet which he considered an improvement over the one he found in Greys "Memoria Technica". Carroll's alphabet is printed on p. 268. of "The Life and Letters of Lewis Carroll", by Stuart D. Collingwood, 1898. Carroll used it for memorizing history dates, first forming a word for the date, then composing a rhymed couplet which ended with the key word. Thus to remember 1492 Carroll devised the word "found" from the three numbers 492, then memorized the couplet:

Columbus sailed the world around,  
Until America was FOUND.

The modern number alphabet, used by almost all contemporary memory experts, is basically the same as the one developed by Feinaigle, the consonants arranged by various vague resemblances to the digits for which they stand. Once the alphabet is committed to memory, it becomes a simple matter to memorize dates, phone numbers, addresses, license plates, population figures, numbers on dollar bills, and so on. For entertainment purposes, long lists of random digits called out by the audience can be memorized rapidly.

In memorizing a long series of digits the best plan is to break them into groups of three, forming a word for each group. It is not necessary to lim-

### COMMENTS AND ADDITIONS

Source:

Date:

it yourself to words in which only the three required consonants appear. Longer words may be used provided the first three consonants correspond to the desired digits.

Another method of memorizing a list of random digits is by means of a key list in which several words, rather than consonants, symbolize each digit. For example: the number 1 may be symbolized by such words as bun, gun, nun, sun, (with which it rhymes), or such words as candle, pencil, smoke stack (which it resembles in form), or any list of random words you choose. Similarly with the other digits. As each number is called off, you pick a word that stands for that number. The list of words is then memorized by associating them in a chain of images, or by hanging them on a basic word list.

An extremely long list of apparently random numbers can be called off at any time, while someone records them, then repeated without an error simply by reciting to yourself a poem you have memorized. Each word of the poem is translated into digits as you go along.

An amusing New York City trick is to exhibit to the audience a list of twenty apparently random digits, then state that you will cause anyone to memorize this list instantly merely by whispering something in his ear. The list of digits is:

34425059667279869196

What you whisper is the information that the digits represent the stops on the Seventh Avenue IRT subway from 34th Street to 96th Street—a series of street numbers which most New Yorkers recall. A similar parlor stunt can be performed in Chicago by using Illinois Central stops, and doubtless there are variations suitable for other large cities.

#### Cards

Memorizing a deck of cards after it has been shuffled is always a dramatic parlor feat. The usual method is to have a key list of 52 words, one for each card. The words are then memorized, either in a chain of association, or by linking them to a basic word list.

#### COMMENTS AND ADDITIONS

Source:

Date:



In preparing a word list of the deck, it is convenient to have all the words for the Spades begin with S, Clubs with C, and so on. Aside from this it is best not to have other memory aids for linking the card to the word. The trick is entertaining only when performed rapidly, and for speed it is best to memorize the words directly, so that as you deal through the cards to memorize them, each card immediately brings the necessary word to mind.

Victor Conrad, in the "Genii", Feb., 1933 suggested using a basic list of 52 dramatic situations rather than words. For example: riding a bicycle, flying an airplane, etc. Each card is then symbolized by either an animal (dog, cow, etc.) or by a personal friend or relative. Thus if your first dramatic situation is riding a bicycle and the first card stands for Aunt Charlotte, you think of Aunt Charlotte riding a bicycle.

Zufall's system for memorizing the deck is fully explained in booklet No.4 of his memory trick series.

#### Miscellaneous

Armed with a memorized basic word list and the number alphabet, it is a simple matter to devise special systems for memorizing almost anything—a game of chess, throws of dice, the first name on each page of a telephone directory, the chess knight's tour, and so on. Zufall originated and has long featured the feat of memorizing what appears on each page of any magazine handed to him. His method is detailed in the first booklet of his series.

Mel Stover writes that Koltanowski, a blindfold chess wizard, performs the following version of the knight's tour. He places on each square of a large wall chessboard the names of 64 spectators present, then without looking at the board he calls out the 64 names in the order of the knight's tour. The names of 64 objects could be substituted for the names of people, and a mnemonic system used for memorizing them. Stover suggests that a "re-entrant" knight's path (that is, one which starts and ends on the same square) be used. You could then decide the starting square of the tour, he points out, by having a spectator throw a dart at the board.

#### COMMENTS AND ADDITIONS

Source:

Date:



Many experts make a practice of being introduced to each member of the audience before they present their club act, then as part of the act they call out the name of each guest as he rises. This is done by associating the name (using as fantastic an image as possible of course) with some outstanding feature of the person's appearance — an unusual necktie, an odd-shaped nose, his resemblance to a famous person or to a personal friend, etc. In addition to the person's name, many experts also memorize the person's home town. This is easily done by fixing the name in mind first, then linking the town to the name by means of some unusual association image.

Some effective mental effects make secret use of mnemonic skill. The following trick, based on a similar trick with cards, is one of the best.

A spectator calls out five words which the mentalist writes on a strip of paper. He hands the strip to the spectator with the request that he think of any one of the words. After this is done, the strip is torn into five pieces, each piece containing one of the words. These pieces are rolled into pellets and dropped in a hat.

The same procedure is followed with four other spectators making 25 pellets in all. The hat is shaken, then someone takes out any five pellets and hands them to the mentalist. The mentalist opens them one at a time, reading each word aloud. He asks the five spectators to raise a hand if they hear their chosen word called. Perhaps no one raises a hand. Perhaps one or more raise their hands. In the latter case, the mentalist immediately tells each person who raised a hand the word he is thinking of. Five more pellets are then taken from the hat and the same procedure repeated. This continues until all five thought-of words have been correctly identified by the mentalist.

It is necessary for you to memorize each spectator's group of five words. Later, when the pellets are drawn from the hat, you open them carefully and pretend to read them, but actually you ignore their words completely! What you do is call out the first word of each spectator's original list, taking the spectators in numerical order. If the

## COMMENTS AND ADDITIONS

Source:

Date:

first spectator raises his hand, you know that his word was the first one called. If the second spectator raises his hand, his word is the second one you named. And so on for the others.

Another group of five pellets are now taken from the hat and opened. As before, ignore what is written on them and call out instead the second word on each spectator's original list. If anyone raises a hand, you identify his word as previously explained. Since it never occurs to the audience that you have committed all 25 words to memory, the trick is very difficult to explain.

The mnemonic work involved is relatively simple. All you need is a basic list of five words to stand for the first five digits. Gun, shoe, tree, door, hive are as good as any because they rhyme with 1, 2, 3, 4, 5. When the first spectator names his five original words you first think of "gun", then take the five words in any order you please, linking all six words together in a continuous chain of fantastic associations. The same for the other spectators.

Dai Vernon called this fine effect to my attention, but did not know the originator.

### MUSCLE READING

Muscle reading is the art of reading a person's mind by means of clues provided by his involuntary behavior. Psychology has long recognized that thoughts are often accompanied by slight muscular tensions and relaxations of which the thinker may be totally unaware. If you think intently of your toes, for example, you are apt to wiggle them slightly. Think of your nose and you tend to look cross-eyed. Many people move their lips slightly when they read. The Ouija board, dowsing rod, swinging pendulum (sold in novelty stores as a "sex indicator"), and many other occult devices operate by means of such unconscious muscular movements.

The muscle reader is usually in physical contact with the subject and for this reason the art is often called "contact mindreading." The performer may hold the subject's wrist or hand, or the subject may hold the mentalist's wrist or hand. Some muscle readers prefer to have the spectator place a

### COMMENTS AND ADDITIONS

Source:

Date:

hand on his (the mentalist's) shoulder or forehead. Others maintain contact by holding one end of a handkerchief, rope, or piece of wire while the subject holds the other end. In most cases the performer is blindfolded throughout the test, though it is likely that the more sensational muscle readers use gimmicked blindfolds to enable them to move about with ease.

A wide variety of tests may be performed, the most common of which is that of finding an object (such as a pin) that has been hidden in the room while the performer is absent. Although the blindfolded mind-reader seems to be leading a spectator around the room in search of the object, actually he allows himself to be guided by the spectator's involuntary muscular tensions. Another common test is that of performing a sequence of simple actions decided upon by the audience — for example, taking off a certain gentleman's necktie and tying it around a certain floor lamp.

Many muscle readers have been able to guess a thought-of number by repeating the digits slowly from 1 to 9 and observing a slight muscular tremor on the part of the subject when the correct digit is reached. In this way the entire serial number of a bill may be discovered. If a large chart of letters is placed on a wall, letters and words can be divined by having the spectator hold the mentalist's wrist as he moves his hand slowly from one letter to another. The most difficult test seems to be that of drawing on a blackboard a number, letter, geometrical design, or simple picture of a thought-of object while wrist is held by someone who concentrates on desired result. Spectators vary widely of course, in degree to which they make good subjects for such tests.

In addition to tactile clues, muscle readers also are skilled in interpreting visual and auditory signs. A group of people can convey information by involuntary glances, facial expressions, changes in breathing, a conversational hush when the performer is "getting warm," and so on. Some performers have achieved sensational results by relying entirely on these "non contact" methods. Many famous muscle readers seem to have operated intuitively, genuinely surprised by their unusual ability and unaware of the basis on which it rested.

## COMMENTS AND ADDITIONS

Source:

Date:

It is possible, however, that this was a pose assumed for publicity purposes.

The world's first professional muscle reader apparently was John Randall Brown. As a young reporter on the "Chicago Inter-Ocean", Brown occasionally entertained friends with his strange abilities. In 1872 he made a bet that he could find a pin hidden anywhere in the city. His success (it was concealed under a rug in the Sherman Hotel) caused a sensation in the Chicago press, and by 1874 Brown had given up journalism for the career of a mentalist. He made many successful tours both here and abroad.

Brown was followed in this country by Washington Irving Bishop, the most sensational of native mind-readers. Bishop made a practice of driving, while blindfolded, a team of horses at breakneck speed through the streets to find an object hidden in some unlikely spot in the city. See "Nature", June 23, 1881 for a description of some of his dramatic performances in England. Bishop's name appeared in 1880 on a British pamphlet titled "Houdin and Heller's Second Sight Explained", but I understand it was ghosted by W. H. Frederick Wicks who later (1907) issued it in expanded form under another title. Bishop died in 1889 during a performance at the Lamb's Club in Manhattan. His mother brought suit against the doctors who performed the autopsy, charging that her son had been murdered by them while he was in a cataleptic trance. The case made melodramatic headlines. Mrs. Bishop lost her suit, but later published a macabre pamphlet about it, now much sought after by collectors of mentalist literature.

The most famous of English muscle readers was Charles Garner, a journalist who assumed the stage name of Stuart C. Cumberland. His experiences in entertaining notables (Prime Minister Gladstone was one of his best subjects) are recounted in an entertaining autobiography. "A Thought Reader's Thoughts", 1888. Cumberland never claimed telepathic powers. In his book (and in a magazine article in the "Nineteenth Century", December, 1886) he attributes all his skill to muscle reading, dismissing talk of psychic powers as "idle rubbish" and "sheer fudge". He also wrote several books attacking spiritualist phenomena.

## COMMENTS AND ADDITIONS

Source:

Date:



A German immigrant named Vogt took the name of Axel Hellstrom, settled in Chicago, and achieved notable success as a muscle reader during the late twenties. "Hellstromism", a booklet on his methods, was published by Robert A. Nelson in 1935. A similar text with the same title mimeographed and undated, was issued by S. W. Reilly.

C. A. George Newmann (real name, George Naeseth), of Minneapolis, claimed to be the first muscle reader to perform non-contact mind-reading. Born in 1880, he toured the nation many times with his performances of mind-reading and hypnotism. His magnificent collection of rare magic books, pamphlets, articles and press clippings (including the original press scrapbook of Brown) is now owned by John McManus of Brooklyn. In 1945 Newmann issued a booklet about himself and his collection under the title "The Newmann Library". It reprinted many articles about him that had appeared in magic periodicals.

Muscle reading, like hypnotism, reached its height of public popularity in the United States and abroad during the last quarter of the nineteenth century, when many mindreaders built their reputations on this type of work. It even became popular as a parlor game known as "Willing". Later, only a few mentalists such as Franz Polgar featured it in their public performances.

"Baldwin's Dictionary of Philosophy and Psychology" contains an article on muscle reading, as well as the "Annual Cyclopeda", 1887, p. 506. Early magazine articles on the subject include "The Methods of Mind-Readers", by Charles Gatchell, "Forum", April 1891; "Physiology of Mind Reading", by George M. Beard, "Popular Science Monthly", Feb. 1877 (reprinted in the "London Journal of Science", July, 1881. See the Sept., 1881 issue of the same journal for a brief history of muscle reading). An interesting letter on the subject appeared in "Popular Science Monthly", July, 1877, with a commenting letter by Beard. Beard originated the term "muscle reading" in 1874 after witnessing performances by Brown, and in 1882 published a booklet titled "The Study of Trance, Muscle Reading", and "Allied Nervous Phenomena".

## COMMENTS AND ADDITIONS

Source:

Date:

*A few years later, on his death, the library was dispersed, some of it going to the Library of Congress.*



Booklets on muscle reading, in addition to those already cited, include:

"Mind Reading or Muscle Reading", Sid Macaire, c. 1890. "How to Thought-Read," James Coates, 1901. "How to Read People's Minds", H. J. Burlingame, 1905. Distribution of this work by Johnson Smith and Company has probably made it the most wide read treatise on the subject.

"Contact Mind Reading—Expanded", Dariel Fitzkee, 1935. "Contact and Non-Contact Mind Reading", William Larsen, a four-page mimeographed manuscript published by Thayer in 1945. "Entertaining with Contact Mind Reading", S. Edward Dexter, 1952.

#### NAIL FILE

1. A small nail file which folds into a colored plastic case is currently on sale in most dime stores. With it a curious trick, based on centrifugal force, can be performed. It is necessary first to loosen the blade so it opens and closes without binding. To do this, dip the end of the case in very hot water to soften the plastic, then twist the blade from side to side until it moves loosely at the spot where a rivet attaches it to the case.

The trick consists in closing the file in such a way that the blade suddenly shoots open again as though propelled by an invisible spring. When the spectator examines it, he is unable to find such a spring.

Begin by holding the file exactly as shown in Fig. 641. The blade and case are on a plane which is perpendicular to floor. All illustrations are from performer's side.

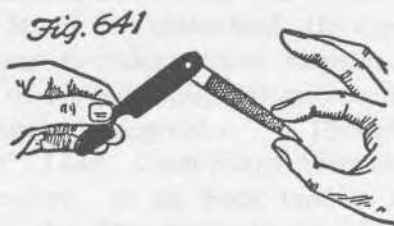

Left hand brings the case to position of Fig. 642. Right thumb prevents case from closing completely on the blade. Tip of left thumb presses case lightly against right thumb as shown.

#### COMMENTS AND ADDITIONS

Source:

Date:

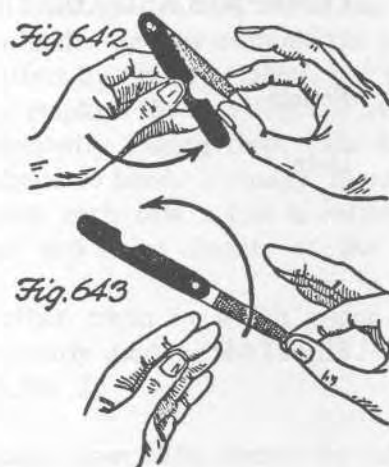

Squeeze the blade firmly between right thumb and finger, at same time pressing forward on the edge touched by forefinger and toward yourself on edge touched by thumb. Blade will make a quick half-rotation as tips of thumb and finger come together. This rotation causes the case to snap off the left thumb which has been pressing lightly against it. The centrifugal force of the rotation throws the case upward and to the left as shown by arrow in Fig. 643. There is a knack to executing the move, but once mastered, the case will snap suddenly straight, and the rotation of the blade will be undetectable.

When you begin the trick, move the blade back and forth a few times as though trying to catch it on some invisible internal spring. Close the case only to have nothing at all occur. Explain that sometimes the blade fails to "catch" properly. Now repeat the motions but this time cause the file to snap open. After snapping it open several times, hand it out for inspection.

#### NAPKIN, PAPER

Many tricks to be covered later under PAPER can be done with paper napkins. Here we shall list only items particularly adapted to paper napkins.

1. Sucker torn and restored napkin. This classic effect has been described too often, in Tarbell and other basic reference works, to require detailed discussion. As usually performed, the napkin is first torn, the pieces rolled into a ball, then the ball opened and napkin shown restored. The

#### COMMENTS AND ADDITIONS

Source:

Date:

magician now gives a pseudo-explanation, showing how a duplicate napkin ball is concealed in the hand. At the finish, however, both napkins prove to be undamaged, leaving audience more baffled than before. Some performers "accidentally" drop a piece of the torn napkin during the trick. Later, the restored napkin has a hole in it which the dropped piece fits. There are many variations in the handling and presentation. Note Milbourne Christopher's fine routine in HMM, July, 1953, and Williard Smith's valuable suggestions in Christopher's column two months later. For Slydini's handling, see "Slydini Encores", p. 107.

I was intrigued by Leslie Hunt's presentation when I saw it in a Chicago night spot twenty years ago. Instead of tearing the napkin into separate strips, he stopped each tear an inch from the edge forming a replica of a grass hula-hula skirt. He held skirt to his belt and while executing a few shim-mies, his hand secured duplicate ball from beneath his vest.

2. Small paper balls, formed by rolling pieces of napkin, are suitable for a wide variety of sleights and table tricks. One of the best is the old trick (the basic sleight is in "Hocus Pocus Junior") of tossing away the third ball only to have it repeatedly return to left hand (see CIGARETTE, No. 28). For a climax you may (1) cause all three balls to vanish, as explained in the cigarette version cited above (2) find in the hand some unexpected object, such as one large napkin ball (3) find in the hand a dozen or more small paper balls.

A simple way to achieve the last effect is to have the small balls in right coat pocket. Instead of pretending to toss away the third ball each time, pretend to drop it into coat pocket. When ready for the climax, grab a handful of the balls before you take right hand from pocket. Now (to vary the trick, you explain) push two balls into right fist instead of left, and drop third ball into left coat pocket. Ask audience how many balls are in your right hand. When you open the hand, a dozen or more paper balls roll out. Dr. Jaks' "Multiball" trick, on the market since 1952, uses sponges but can also be adapted to small napkin balls. In Jaks' version the shower of balls seems to come from spectator's hand.

## COMMENTS AND ADDITIONS

Source:

Date:



Many other sponge ball tricks can be done with napkin balls. See for example the hand transposition effect by Stanley Collins, in "The Jinx", No. 91. It employs the excellent but little used sleight of apparently tossing three balls back and forth from hand to hand. Actually, there are four balls, but with each toss a ball is retained at base of second and third fingers of the tossing hand.

For other tricks in which paper balls may be conveniently used see MATCHES No. 3, and MARBLES, No. 3.

3. Large paper balls, formed by rolling up an entire napkin, also lend themselves to many striking effects.

Slydini's "Flight of the Paper Balls", 1951 (Stars of Magic Series) gives his amusing routine based on the vanish of a paper ball by secretly tossing it over the spectator's head. Slydini's subtle misdirection and timing have made this one of his most effective night club routines. See Chapter 10 of "The Magic of Slydini".

Slydini has also explained the details of his beautiful pantomime table effect in which four paper balls vanish one at a time from his hands and appear in a hat previously shown empty. See "The Magic of Slydini", chapter 3.

Roy Benson's "Bizarre Bag", "The Phoenix", June 1, 1951 describes a method of secretly loading an egg bag with five eggs. It makes use of the same basic loading principle employed by Slydini in his balls and hat trick, and may easily be adapted to a hat and rolled-up paper napkins.

4. Strength feat. Twist a paper napkin tightly to form a rope and challenge anyone to break it apart by pulling on opposite ends. As he tries unsuccessfully, secretly moisten fingers in a glass of water. Take back twisted napkin by grasping it at the center. When center becomes wet, napkin pulls apart easily.

5. Place three napkins on table, one on top of the other (Fig. 644). Mark a large "X" on top napkin as shown. Start rolling all three napkins at corner A and roll forward until you have formed a cyl-

## COMMENTS AND ADDITIONS

Source:

Date:

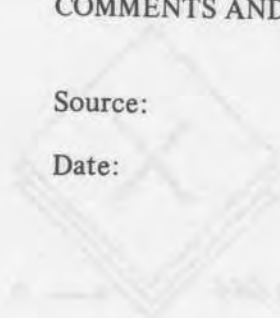



## COMMENTS AND ADDITIONS

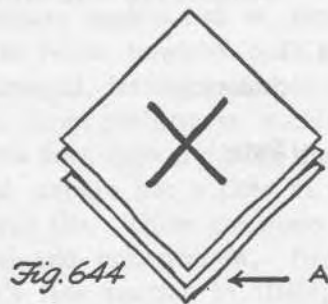

Fig. 644

inder. When unrolled, marked napkin is found between the other two. Accomplished by secretly allowing one corner to go around the cylinder as you complete the rolling. Repeat, allowing two corners to go around, and marked napkin will be back on top again. If napkins of different colors are available, use two of one color and one of another (instead of marking one with an "X").

6. R. C. Buff suggested this vanish in "My Best", 1945. Moisten crotch of thumb and seize napkin as in Fig. 645. The moisture softens the paper, making it easy to push up with left thumb and



Fig. 645

forefinger and break napkin apart at spot A. With other hand, start rolling up napkin from bottom but instead of leaving the ball in left hand, as you pretend to do, palm it in right hand. Reach for a match folded in coat pocket, leaving the ball behind as you take out folder. Decide against setting fire to napkin. Instead, pretend to tear off the exposed tip, wave it over left fist. When you open the hand, napkin has vanished.

7. Spread napkin over left fist. Form a "well" by poking the paper into fist. In doing so, poke a hole through the paper. You can now vanish a coin (as Jack Chanin has suggested) by dropping it into the

Source:

Date:



well, letting it fall through the hole into left fist. Take napkin in right hand, with coin apparently inside, while left hand disposes of coin. Tear napkin into small pieces to show that coin has vanished.

Salt may be vanished in similar manner. Rest left fist on edge of table. As right hand shakes salt into the well, the salt pours through fist to the floor to lap.

8. Magician forms a napkin ball, punctures it, pours out salt. Salt is carried in small packet formed by folding a piece of napkin around the salt and pasting it closed. Packet is palmed and loaded into napkin as you roll it into a ball. (Clettis Musson, "Minute Magic", 1955).

#### Stunts and Gags

9. Practical joke. Cut napkin in quarters, paste corners so that when victim picks up napkin it will hang as in Fig. 646.



Fig. 646

10. Tell victim you have mastered a method of telling fortunes by examining the imprint of teeth marks. Roll napkin into cylinder and ask him to bite it hard. Study his bite marks carefully, then say, "You sure bit hard on that one!"

11. Roll napkin into a cylinder and stand it on a plate as shown in Fig. 647 (the napkin will stand better if you first roll it from one side, then unroll and roll it again from the opposite direction). Set fire to the top of the napkin. As the flame reaches the bottom, the burnt napkin will float upward

#### COMMENTS AND ADDITIONS

Source:

Date:



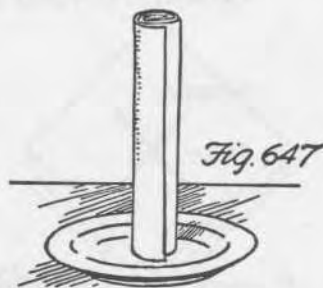

into the air. Works only on napkins of a certain weight and composition. It should be tried out of doors only when there is no breeze or in a room where there is no fire hazard, because napkin may be carried by air currents in unpredictable directions while it is still burning.

12. Charlie Miller holds hat in left hand, open side to right. A napkin ball is put inside hat. Pretend to attach it to an invisible elastic. When ball is pulled out of hat, to the right, invisible elastic seems to snap it back into hat. Actually, ball is propelled by a snap of right middle finger.

## NECKTIE

Many necktie effects which appear impromptu (e.g., cutting and restoring a spectator's tie) will not be included here because they involve duplicate ties, special equipment and so on. See HANDKERCHIEF for trick knots and other effects which can be adapted easily to neckties.

1. Flipping knot in tie. Hold small end of tie, letting other end hang free. Jerk the hand upward, then quickly throw a downward loop (Fig. 648)

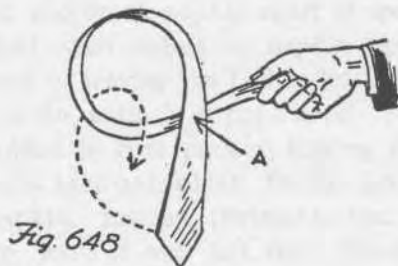

causing loop to strike lower end of tie at spot "A." The force of this blow against the dangling end will cause the end to flip up and through the loop as indicated by arrow. Result — a loose knot in lower end of tie. The loop may be thrown either to right or left side of hanging tie.

## COMMENTS AND ADDITIONS

Source:

Date:



2. Silly sight bit. Roll up longest end of the tie you are wearing, rolling it all the way up to the knot. Tuck the cylinder under your chin and hold it there with the chin. Now give a yank on tie's other end. At the instant you yank, raise chin, permitting cylinder to unroll like a falling stage curtain.

3. Prepare tie as in Fig. 649. Attach it to your collar by bringing the threads around your neck and tying them in back. Necktie now appears perfectly normal, but any time you wish you can perform a penetration effect simply by yanking on tie. Threads break, tie comes off. Circular



part of tie is then shown intact. For Tony Lopuato's combination of this stunt with a rope penetration, see "Tarbell", Vol. 5, p. 336.

#### NEEDLE

1. The needle swallowing trick, made famous by Houdini has been described in so many standard references and with so many variations that it is mentioned here only for completeness. Does any reader know who first suggested the following device for convincing audience there is no exchange of threads? A short piece of thread is held so it appears to be the end of the thread you pretend to swallow. This short piece is left dangling from the lips, in full view at all times.

When you are ready to pull out the thread with the needles, grasp the end of the small piece at the same time you take the end of the prepared thread, keeping the two ends together between your thumb and finger as you draw the thread from your mouth.

2. A needle will float on water if placed carefully

#### COMMENTS AND ADDITIONS

Source:

Date:



so as not to break the surface tension. Can be done with fingers alone if you use extreme care. Easier methods: (1) Suspend each end of needle in a loop of thread and lower needle to the water. (2) Rest needle crosswise at the extreme tips of the prongs of a fork. Lower the tips to the water. (3) Place needle on piece of tissue paper. The paper soon sinks and leaves needle floating.

After demonstrating the feat, if you secretly dissolve a tiny amount of detergent in the water, no one else will be able to float the needle. The detergent lowers surface tension.

3. Although this curious trick appears on p. 208 of "The Secret Out", it is virtually unknown today. Prepare for it as follows. Take a piece of thread about ten inches long, wrap one end around tip of middle finger of right hand, then place a thimble on the finger to hold thread in place. Bunch up the thread and conceal it in the hand.

In front of audience you now take another piece of thread (also ten inches) and thread it through a needle. You apparently draw the thread through the eye until both ends hang at same length. Actually, the end is drawn through only an inch or so and the concealed thread is allowed to drop from

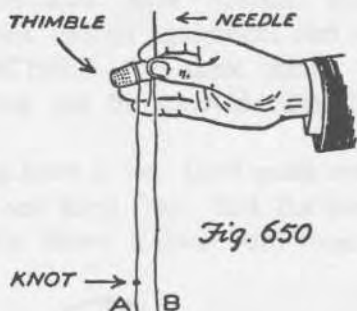

right hand. The hand now appears as in Fig. 650. The small end is kept concealed at all times. Audience thinks of course that the two dangling ends belong to same thread.

Allow someone to tie a double or triple knot in the end of thread A. Or, if you prefer, give him a small bead or button to fasten to the end.

You now apparently draw the needle and the thread completely through a handkerchief, coat sleeve, trouser leg, or any handy piece of cloth. As

## COMMENTS AND ADDITIONS

Source:

Date:



every woman knows, this feat is quite impossible if the end of thread is knotted. What happens is that you push the needle through the cloth near an edge, then reach around the edge, grab the needle near its eye, and quickly pull it through. Only thread B actually goes through the cloth. Thread A (with the knot) is carried around the edge of the cloth, but the illusion of both ends going through is strong. You may even take several stitches with the needle before pulling it through.

4. Many-threaded needle. Likewise found in many old books (e.g., Tom Tit's "La Science Amusante", Vol. 2, 1892, p. 177) though it continues to turn up as a new trick in current literature. The stunt consists in rapidly threading a needle with some thirty to fifty short lengths of thread.

Begin as in Fig. 651 with needle in the middle of a long length (several yards) of thread. At point X on one thread, a few inches below the needle's eye, twist the thread until its individual strands open slightly, then push needle through them. When these opened strands are drawn over needle and down onto thread B, the two threads become joined at point X in Fig. 652 (the picture shows the strands opened to make clear what has happened.) Most descriptions of the trick tell you to push needle through both threads. One however is sufficient.

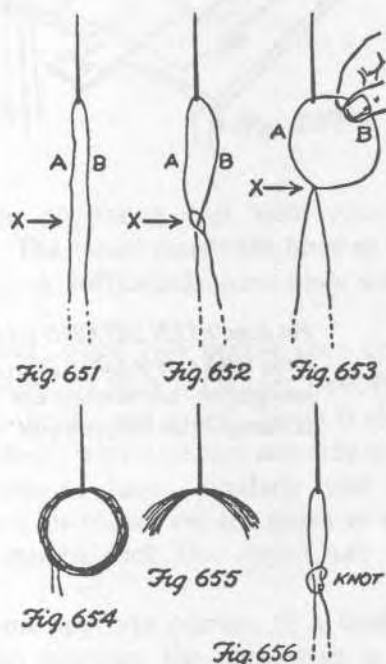

## COMMENTS AND ADDITIONS

Source:

Date:



Now pull on thread B (it must be B, not A) as shown in Fig. 653, until you pull the joined spot through the eye. As you continue to pull, the thread circles round and round through the eye until you reach the ends (Fig. 654). You now have only to snip the threads with scissors and you have a needle threaded with dozens of short strands (Fig. 655).

The larger the needle's eye, the longer a thread you may use and the larger will be the number of strands when you finish. Harry Dreilinger performs the entire operation in front of spectators, keeping needle out of sight by holding it behind his back or under a table. He first asks someone to thread the needle for him, calling attention to the length of time it takes to accomplish this. He then holds the needle behind his back, but instead of pushing the needle through the thread, he simply ties one of the threads around the other (Fig. 656) and pulls the knot tight. If needle has a fairly large eye, this knot will circle through the eye enough times to result in a needle with a dozen or so strands. This method lowers the number of strands, but has the virtue of being rapid and easy to do by sense of touch alone.

5. Pretend to hypnotize victim so he can't thread needle, the eye of which has been dipped in clear nail polish.

#### NEWSPAPER

Many newspaper tricks require such elaborate preparation that they cannot be considered impromptu. The torn and restored newspaper, introduced by Al Baker, is a good example. Also, cut and restored newspaper strips (such as the trick sold under the name of "Clippo" and Jesse Schimmel's effect in HMM, Nov., 1953) which require preparation with rubber cement. "Newspaper Magic", by Gene Anderson and Frances Marshall (Magic, Inc., 1968), contains many items of an impromptu nature.

In recent years a number of mind-reading feats have been developed in which a spectator tears out a small circular piece from a newspaper page. The mentalist, standing across the room, tells what is printed on the piece. Or the spectator may select a word by plunging a pin into a newspaper. Most of

#### COMMENTS AND ADDITIONS

Source:

Date:

*Pat Page's TEN SECOND PAPER TEAR, done with a page taken from a tabloid newspaper - and nothing else - probably is therefore an "impromptu" version.*

these effects use a specially prepared newspaper with duplicate pages.

In the items below the term "single sheet" refers to one leaf only of a standard size newspaper (that is, two pages—a page on each side). The term "double sheet" means a sheet twice as large, or four pages in all.

1. To prove he does not leave his chair during a seance, the medium places both feet on a single sheet of newspaper, draws an outline around his shoes with black crayon. Later, when lights are turned on, his feet are still exactly on the outline. Actually, medium moves about room as he wishes, returns to seat, turns over the paper, draws two new outlines before lights are turned on. (See Jean Hugard's use of this dodge in his fine seance routine, HMM, Jan., 1955). Or he may fold and pocket the newspaper (or slip it under the cushion of the chair), replacing it with a fresh sheet from his pocket.

2. A thin plank (about a quarter of an inch thick, eight inches wide, and two feet long) is placed on table with half its length projecting over the edge, then covered with a sheet of newspaper (Fig. 657).

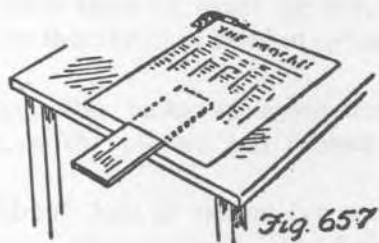

Strike the projecting end with your fist or a hammer. The board resists the blow as if nailed to the table. A sufficiently hard blow will break it.

3. Problem: place two people on a double sheet of newspaper in such a manner that they will be unable to touch each other. Sheet is placed under a closed door, with a person standing on the paper on each side of door. Similarly, you can place a person and an object on the paper in such a way that he cannot kick the object off the paper.

4. Pull on opposite corners of a single sheet of newspaper, pinching the corners so as to form a kind of groove that extends from corner to cor-

## COMMENTS AND ADDITIONS

Source:

Date:



ner. The paper is not creased – merely given a trough-like form along the diagonal. It can now be balanced on tip of finger or nose (Fig. 658).

5. Bert Allerton gag. Ask someone to tear off a single sheet of newspaper and hand it to you. Everyone expects a trick. Instead, take a wad of chewing gum from your mouth, place it in center of sheet, crumple the paper into a large ball and toss it into a wastebasket.

6. Torn wallpaper joke. Fold a sheet of newspaper in half and tear out a small triangular piece. Crinkle half of it, moisten other half, and stick it on the wall of victim's home (Fig. 659). Looks exactly like a tear in the wallpaper.

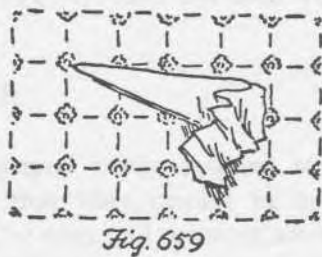

7. Nantucket knots. According to "Woman's Day", Oct., 1952 natives of Nantucket use old newspapers as kindling wood for their fireplaces. About ten opened double sheets are placed flat together, rolled diagonally into a fairly tight tube. Tube is then bent and tied into a knot without



cracking the paper (Fig. 660). The knots reportedly burn a half hour or more with strong hot flames.

## COMMENTS AND ADDITIONS

Source:

Date:



8. Bet someone he can't fold a single sheet of newspaper in half more than eight times. Seventh fold is easy, eighth extremely difficult, ninth impossible.

9. Strength stunt. Hold one corner of double sheet and raise hand until arm is parallel to floor. Without lowering arm, try to crumple entire sheet into a compact ball. Difficult unless you start slowly, compressing the paper as much as possible at the beginning.

10. If you tear off two corners of an entire newspaper, tearing through all the pages at once, it will always produce an even number of corner pieces. Can be used to force an even number, or as a swindle device to determine who buys the drinks. The pieces are placed on the bar. You draw first, and persons who gets last piece has to pay.

11. Transfer fluid. Newspaper pictures of any type (including color comics) can be transferred to a sheet of blank paper as follows: Fill small bottle with ten parts water and one part turpentine. Add a pinch of soap about the size of a large pea and let dissolve. Shake bottle before using. With the liquid, moisten part of newspaper to be transferred, place sheet of paper on top, rub back of paper with thumbnail or bowl of spoon.

Wax paper also picks up newspaper pictures if placed over the picture and rubbed with spoon.

12. Children's hats of various types can be folded from sheets of newspaper. See Leeming's "Fun with Paper", and "Fun with Paper Folding" by Murray and Rigney. Pressmen in newspaper printing rooms throughout the country protect their hair from ink by folding a box-shaped hat from a blank sheet of newsprint. If you find yourself forced to walk through rain without hat or umbrella, the hat can be folded quickly from a sheet of newspaper and worn for protection. The fold was described in "The New Phoenix", No. 315, 1954.

#### Newspaper Tears

13. The most popular newspaper tear is the fir tree, described in many old books on paper folding. To

#### COMMENTS AND ADDITIONS

Source:

Date:





Fig. 661



Fig. 662

get a maximum height, the best procedure is to start with five double sheets of newspaper. Fold and tear them in half lengthwise to form ten long narrow sheets (Fig. 661). These are rolled into a cylinder in the usual manner, making the cylinder about two inches in diameter. A rubber band around one end will keep it from unrolling. The other end is now flattened and torn twice to form the four branches (Fig. 662). As you start to pull the tree upward, twist and tighten the stalk with each pull. In this way you can form a rigid tree of ten feet or more in height.

Nightclub and TV comic Orson Bean featured the fir tree in his 1954 appearances. The comic supplied spectators with paper, then taught the entire audience how to make the tree. For pictures of Bean and his "Bean-pole", see "This Week", May 23, 1954, and "The Chicago Tribune", March 28, 1954.

Clettis Musson, in "Minute Magic", 1953, describes two tricks making use of a miniature fir tree. In one trick the tree is produced from a well in a handkerchief; in the other, from a glass filled with salt or sugar. See also the "Phoenix", Dec. 26, 1952, in which I describe a method of forming a cylinder that will produce a small cone-shaped Christmas tree.

Lester Grimes, of New Rochelle, N. Y. conceals in the base of the newspaper cylinder the gimmick used for the production of a flag staff. After tearing the paper, he releases the gimmick and the tree suddenly shoots up to its full height.

14. Jacob's ladder. Similar to fir tree, except instead of a tree, a ladder is formed. Fig. 663 shows several different ways the cylinder may be torn, each producing a slightly different type of ladder.

## COMMENTS AND ADDITIONS

Source:

Date:



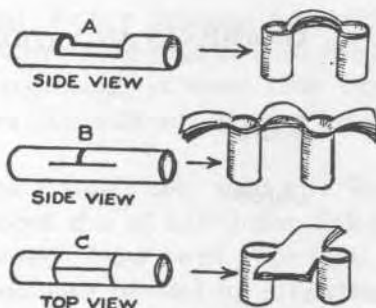

Fig. 663

See Leeming's book, cited above, for two other structures formed from rolled-up cylinders — a Chinese temple and a barber's pole (from red and white paper).

Lester Grimes, after making the tree which shoots upward (see previous item), tears a ladder which drops open to its full length when he gives it a shake. Lead weights concealed in the two ends of the cylinder are responsible for this surprising method of opening the ladder.

15. Tom Tit, in "La Science Amusante", Vol. 3, p. 229, gives a quick method of pleating and tearing a strip of paper to form a ladder. On p. 211 of Vol. 2 he describes still another type ladder, formed in a manner similar to Jacob's ladder.

16. A newspaper can be folded so that when small pieces are torn from it, it opens up to reveal an intricate circular pattern resembling a snowflake design. The method is discussed fully by Houdini on p. 167 of his "Paper Magic", 1920, as well as in earlier works. The fold can also be used for forming a circular chain of objects or human figures. Al Baker used to sell a version called "Ring-around-Rosie" which produced a circle of little girls. Vin Carey, in his "Easy-do" paper act (sold by Abbott) suggests tearing the paper first to produce a ship's wheel. The wheel is refolded, then after a few more tears, opens up to reveal a circular chain of dancing girls.

See HMM, Sept., 1949 for Jay Marshall's method of forming a circle of rabbits. In all these variations, the figures may be torn from the chain and passed out to children in the audience as souvenirs.

## COMMENTS AND ADDITIONS

Source:

Date:

17. Keith Clark, in his nightclub act, folds and tears a sheet of paper, opens it to reveal the face of a clock. Small holes indicate the hours and two hands show exact time the trick is performed.

18. To reveal name of forced card, pleat and tear sheet to form a picture of the card. Ten of Diamonds is a good card to use because it is easy to produce by tearing.

19. Adrian Plate featured a newspaper tear which formed a row of four skeletons that danced grotesquely when shaken. The method of pleating and tearing will be found in Houdini's "Paper Magic", p. 154.

#### NOSE

1. Nose popping. Cup both hands over your nose (Fig. 664). Outside hand seizes nose between thumb and forefinger and twists it from side to side. With each twist a loud crack is heard. The sound is produced by concealed hand. There are two methods. One, snap thumbnail off middle finger. The other, snap thumbnail against upper front teeth.



Fig. 664



Fig. 665

2. Under cover of left hand, pretend to push right ring finger up right side of nose. When left hand is removed, right appears as in Fig. 665. Ring finger is of course bent into palm, its knuckle pressing against nostril.

3. Joker dips finger in glass of water, stands behind victim, pretends to sneeze loudly, at same time flipping drops of water on back of victim's neck. Frowned upon by Emily Post.

4. Senator Crandall, one freezing December day, entered a house muttering about how cold it was outside. An icicle hung from one nostril. It was a Christmas tree icicle which the Senator brought along for the occasion.

#### COMMENTS AND ADDITIONS

Source:

Date:

5. Frank Rigney manages a convincing bagpipe imitation by holding his nose to give a nasal sound to his vocalizing, at same time tapping himself under the chin with side of other hand.

6. Frank Garcia's silly sight bit. Tear a piece of paper about size of half dollar, lick it, stick it on tip of nose. Now twist your right ear, at same instant blowing upward by projecting your lower lip. This sends piece of paper flying into the air.

7. Street fakirs in India perform this one. A piece of string is sniffed up one nostril, maneuvered across top of septum, then blown out other nostril. An end is seized by each hand and the string pulled back and forth.

8. "Sniff"—a party game. Guests form two rows. Leader of each row keeps a small piece of facial tissue against his nostril by inhaling through nose. Pieces are passed from nose to nose. Row to finish first wins.

#### NUTS

1. The following quotation from "The Magician's Own Book" is hard to improve. "Conceal a very strong walnut in your right hand, and take two other walnuts out of the dish. Place one of them on the joint of your arm, and say that you are going to break it by the power of your muscles. You will now have one walnut in your arm and two in your right hand. Close your left arm, and strike it an apparently violent blow with the right hand, at the same time clenching the right hand violently, which will smash the second walnut in it, and the spectators hearing the crash will be sure to fancy that it is caused by the demolition of the walnut in your arm.

Then open your arm very gently (for fear of dropping any of the fragments, you must say), and, when pretending to take out the walnut which you had placed there, you substitute for it the broken one from your right hand."

2. "And now," you announce, "I am going to show you a great mystery — a wonder of nature that no human eye has seen before and that no one will ever see again!" Crack open a nut, show the kernel, pop it in your mouth and eat it.

#### COMMENTS AND ADDITIONS

Source:

Date:





## COMMENTS AND ADDITIONS

Source:

Date:

3. By splitting the ends of peanut shells, children can hang them from their ear lobes (Fig. 666) as earrings.

4. A walnut can be opened by carefully prying apart the two shells. After kernel is removed, it can be filled with any small object, and the halves glued together again. "Willane's Wizardry" describes Wilfrid Jonson's trick of tearing up a bus ticket and pretending to place the pieces in the left hand. Pieces are secretly retained in right hand which leaves them in pocket as it takes out a prepared walnut with duplicate bus ticket inside.

The nut is placed on the fingers of closed left fist, then allowed to roll into the fist. When hand is opened, torn pieces have vanished. A spectator cracks the walnut, finds restored ticket inside. The numbers of the two tickets are made to correspond by obtaining tickets with consecutive numbers and altering one of the digits.

## OLIVES

1. When about to eat a Martini olive, try this. Extend your index finger upward, concealing a toothpick behind it (Fig. 667). Pretend to balance olive on tip of finger, actually pushing it on end of pick. After holding it there a few seconds, expose the method for a laugh, then eat the olive.

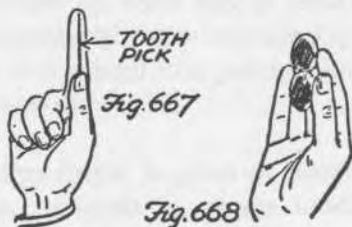

2. Right hand displays one olive at finger tips, keeping a second olive concealed in the palm. Carry the visible olive to your mouth and place it between the lips, holding it in full view between the lips. Pretend to take this olive from your lips

with right hand. Actually allow olive to go into mouth and show the other olive, previously palmed. Pretend to drop it into left hand, secretly retaining it in right. Raise closed left hand over your head. As right hand drops its concealed olive in lap, smack left palm on top of head. The instant this is done, open mouth and allow olive to drop out and fall into right hand. Simple but astonishingly effective.

Now repeat the trick, varying it as follows. Pretend to pick up one olive, but actually pick up two, holding the visible olive at tips of fingers and the concealed olive directly beneath it (Fig. 668). Raise right hand to mouth and pretend to place the visible olive between the lips. What you do is to put the olive all the way into your mouth, placing the concealed olive between the lips. Show both hands empty. Take olive from lips and proceed with the trick as before.

## ORANGES

1. Funny teeth. Remove peel from a quarter slice of orange. Cut slit down the center, and teeth on each side (Fig. 669). Turn peel inside out so white part is outside. Slip it under both lips (Fig. 670).



2. Cover an apple or peach with orange peel. Show what seems to be an orange. Pretend to peel it, only to find an apple or peach inside.

3. An orange peel can be cut to form many curious designs. See photographic article, "The Champion Orange Peeler," "Strand", Dec. 1899, p. 641.



## COMMENTS AND ADDITIONS

Source:

Date:



4. Seasick Sailor. Eyes, nose, and mouth are cut from an orange. Cover glass with cloth napkin and place orange on mouth of glass. By manipulating the cloth, the face is made to roll from side to side (Fig. 671) like a seasick passenger on a ship. Climax: drape the cloth over orange like a hood and squeeze the juice from the mouth into the glass.

"This last scene, however," writes Professor Hoffmann (p. 189 of his "Parlor Amusements") is disagreeably realistic, and we venture to think is much better omitted."

5. An orange, rolled up and down the black keys of a piano, sounds like you are performing a skillful finger run if spectators are standing so they cannot see keyboard.



### OVERCOAT

1. The "Man in the picture gallery." Frank Bellew, in "The Art of Amusing", 1870, describes this amusing parlor skit. A man, with his back to the audience, wearing an overcoat and hat, seems to grow a foot or two in height as he pretends to look at pictures hanging at various heights on the wall. The growth is accomplished by draping overcoat over your back and holding the collar tight against the hat with both hands (Fig. 672). Raising the hat makes the figure appear from behind to be increasing in height.



Presentation is as follows: Someone introduces the skit by telling audience to imagine that the wall in front of them is the wall of an art gallery, and every day at this time a strange man enters to study the pictures. You enter by a side door near the wall, walking sideways to keep your back toward the audience at all times. Bend forward and pretend to study a picture hanging low. Then shift your position a foot or so to one side and slowly "grow" a few inches as you appear to be inspect-

ing a picture hanging a trifle higher. The hat can be tipped forward and back by your fingers to give the illusion that your head is looking up and down the picture. Continue to shift your position side to side as you pretend to study different pictures, growing a few inches each time until your hands are holding the hat as high as you can reach.

The exact grip on overcoat collar and hat depends on type of hat being used. The hands should not show from behind, and you must make certain the collar is flush against hat brim at all times. I find it best to push back of collar up into hat, then place hands inside of collar and grasp sides of hat through the collar, thumbs inside hat and fingers outside. It is important to experiment with different grips until you find one that is most suitable.

Properly performed, the illusion from behind is very convincing. Bellew also describes how a broom can be used to make the figure grow even higher, but the broom method is more difficult to handle.

#### PAPER

The most important references on paper tricks, stunts and gags (as distinct from paper folding and other forms of paper craft, to be discussed later) are: "Paper Tricks", 1919, by Will Goldston; "Paper Magic", 1920, and "More Paper Magic", 1923, by Will Blyth; "Paper Magic", 1922 by Harry Houdini; and "Paper Magic" (mimeographed), 1941, by U. F. Grant.

Impromptu methods of tearing and restoring paper will be found under (1) NAPKIN, PAPER; (2) PAPER, CIGARETTE, (3) PAPER, TISSUE.

Before World War II, Lester Grimes, of New Rochelle, N. Y., billed himself as "The Paper Wizard", performing a club act in a paper costume and using only paper equipment and materials. Some of Mr. Grimes' novel ideas were mentioned under newspaper tears; others will be cited below.

1. Afghan Bands. If a paper strip is given a twist before its ends are pasted together, the resulting band forms a structure known to topologists as a "Moebius surface." It has only one side and one

#### COMMENTS AND ADDITIONS

Source:

Date:

edge, and cutting it in half lengthwise will produce one large band instead of two. If the cut is begun a third of the way from an edge, the scissors will travel twice around the band and the result will be one large band with a small band linked through it. If the strip is given two twists before the ends are pasted, cutting the band in half results in two interlocked rings of the same size. A thrice-twisted band cut in half forms a single band tied in a knot.

The cutting of bands with one and two twists is described in many recreational works of the late nineteenth century. Professor Hoffman called them "Afghan bands" in his "Later Magic", 1904, but the origin of this name remains a mystery.

An entertaining presentation of the trick, suggested by Phil Foxwell, is as follows: Prepare three bands from three strips of wrapping paper, each strip about 8 inches wide and 12 feet long. One band has no twists, one has one twist, and the remaining band has two. Because of the large size of the bands, the twists are not noticeable. Select two spectators and hand them each a band (giving them the twisted ones) and a pair of scissors. On command of "Go," each begins to cut. The first to cut his band into "two separate rings" wins a five dollar bill. Illustrate what you mean by cutting the unprepared band and showing the separate rings which result. Of course, neither spectator wins. One produces a single large ring and the other finds himself holding two rings that are interlocked.

Percy Naldrett, in "More Collected Magic", 1921, described a trick by British magician Ted Beal in which a wide paper band is cut in half to form two separate rings. The rings are handed to two spectators for cutting. One spectator produces two separate rings as before, but the other finds his two bands linked.

Unaware of Beal's trick, Philadelphia attorney James C. Wobensmith worked out a similar effect using a band of red muslin. It was marketed in 1922 and described by him in "The Magic World", Sept. 1923. Presentation patter about the side-show magician who provided belts for the fat lady and Siamese twins was suggested by Larsen and Wright in 1928, in "The L. W. Mysteries for Children". In 1930 Ellis Stanyon published his leaflet, "Remarkable Evolution of the Afghan Bands"

## COMMENTS AND ADDITIONS

Source:

Date:

(later reprinted in "Greater Magic). Although this dealt solely with paper variations, it suggested an improved method of preparing the muslin bands so that after cutting, the rings were without twists. The trick as sold today is Wobensmith's original effect, with Larsen and Wright patter, and Stan-yon's method of preparation. For several unusual muslin variations, see HMM, Dec., 1949.

Other references dealing with paper variations include James A. Nelson's method of producing three interlocked bands with one cut ("Sphinx", Dec., 1926); Lester Grimes' method of forming a chain of five rings with one cut (Hugard's Annual of Magic", 1938-39, and "The Magic Wand", Oct., 1949); and Stanley Collins' disclosure ("1948-49 Magic Wand Year Book") that if a ring is placed on a strip and the ends pasted after the strip is given three twists, the usual cutting results in one large strip knotted around the ring.

2. Double Moebius Band. Hold two strips of paper together as a single strip, then form the usual Moebius band by giving them a single twist. Paste the respective ends together (Fig. 673). You

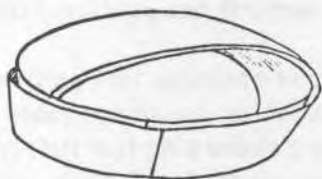

Fig. 673

now have what appears to be two separate rings nested together, since you can insert a playing card between the two strips and move the card all the way around the double ring. When opened up, however, it proves to be a single large band. Once opened, it is an exasperating problem to return the band to its original "double Moebius" form. Cutting the double band down the center, or a third of the way from an edge, yields interesting results.

3. Transposed X's. Show what appears to be a blank sheet of paper. Actually, four X's have been marked on the underside as indicated by dotted X's in Fig. 674. In what follows, it will be assumed that the audience is looking down on the paper as it is held a few inches above the table.

## COMMENTS AND ADDITIONS

Source:

Date:

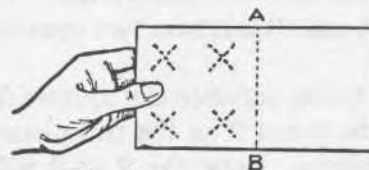

Fig. 674



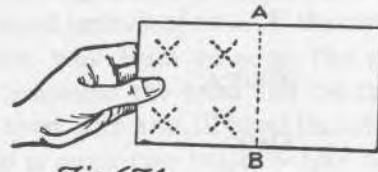

Fig. 674

Tear the paper in half along dotted line AB, casually turn over the right half (without calling attention to fact that it is blank on both sides) and place it under left half. Turn over both pieces. Tear in half again. Place either group on top of the other, turn them over, tear in half once more. Again, place either group on top of other. You now hold eight small pieces. Unknown to audience, every other piece has an X on its underside.

Deal the pieces into two piles, alternating left and right. Someone chooses a pile. If he selects left-hand pile, give it to him to hold in his fist. If the right-hand pile, pick it up and make an X on each of the four pieces, then ask him to hold the other pile in his fist. Burn the marked pieces. Spectator opens his hand, finds X's on each of the pieces he has been holding.

S. Leo Horowitz, in the "Phoenix", July 13, 1951, suggests that instead of burning the four pieces, you mark them with a fountain pen containing a rapid vanishing ink.

The trick was invented by Milbourne Christopher and appears in one of the "Tarbell" volumes.

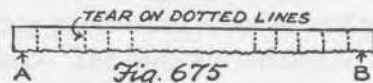

Fig. 675

4. "Six" prediction. Tear a strip from the side of a sheet of paper (Fig. 675). Starting at one end, tear off five small squares. Do the same, starting from other end. This gives you ten squares. Eight will have one smooth side. Two of them (marked A and B) will have two smooth sides.

Openly number the squares from 1 to 10, placing the 6 and 9 on the two pieces that differ from the others. Draw the 9 so it will look like a 6 when inverted. On another piece of paper, write the word "six" (not the numeral), fold it, place it aside as your prediction.

## COMMENTS AND ADDITIONS

Source:

Date:





Turn all the pieces face-down and let someone mix them by sliding them about on the table. Divide them into two groups of five each, making sure that the 6 and 9 are in separate piles. Tell spectator to tear up and discard all the pieces in whichever pile he chooses (it is this obviously fair choice which makes the trick effective). After this is done, have the pieces mixed once more, then divide them into two piles – three in one pile, two in the other. The latter pile must contain either the 6 or 9.

Ask him to place a finger on either pile. If he puts it on the three-piece pile, tell him to tear up the pieces. Otherwise, let his finger remain on the two-piece pile while you destroy the other. Now turn the two squares face up and place them so the spectator sees one as a 6, and the other as, let us say, a 4.

“Consider carefully,” you tell him, “then pick up either the six or four.” If he picks up the 4, direct him to destroy it, leaving the 6. If he picks up the 6, then you tear up the 4. The prediction is opened and found correct.

#### Stunts, Gags, and Betchas

5. Invisible writing that appears when the paper is immersed is easily produced as follows: Dip a sheet in water, flatten it on a window pane or similar hard surface, place dry sheet on top. Write on dry sheet with a pencil, pressing hard. Discard dry sheet. Writing is clearly visible on wet sheet, but vanishes when paper dries. Wetting the paper brings the writing back again.



Fig. 676

6. Each of two spectators holds a knife or old-fashioned razor as in Fig. 676. Paper bands hang from cutting edges of the blades and support a stick as shown. If stick is struck in the center with another stick, it will snap in two without breaking the paper rings. A version of this stunt is performed by Panurge in Chapter 27, Book II, of Rabelais' "Gargantua and Pantagruel". Panurge rests a javelin

#### COMMENTS AND ADDITIONS

Source:

Date:

staff on the brims of two glasses filled with water and five feet apart. The staff is broken without cracking glasses.

7. Silly sight bit. A strip of paper a foot long and  $\frac{1}{4}$  of an inch wide is pleated into a compact parcel and pushed up one nostril until invisible. Causes considerable surprise when pulled from nose.

8. Roll a large sheet of brown wrapping paper into

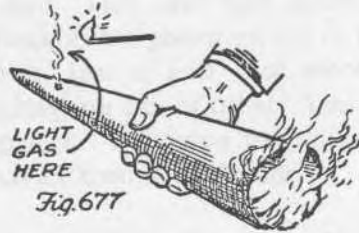

a cone. Make a small hole in cone near pointed end. Hold as in Fig. 677. Set fire to large end. The combustion produces a gas which can be ignited as it escapes from small hole.

9. On dry winter days a piece of paper becomes electrically charged if you hold it while you shuffle across a rug. Place charged paper on the wall and it sticks there.

10. Arrange three small pieces of paper in a row. Which two are farthest apart? Answer: the end ones. Problem: remove middle piece without touching it. One solution: move a piece from one end to other. Center piece is now no longer in the middle. Another: hold pieces in place with two fingers, blow away center piece.

11. Inform victim that if he can tear a sheet of paper into four parts while he whistles "Yankee Doodle" you will give him a quarter. He does so and you give him a "quarter" – that is, a quarter of the original piece!

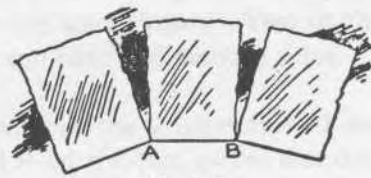

## COMMENTS AND ADDITIONS

Source:

Date:

12. Tear a sheet of paper in two places (Fig. 678) to form three pieces held together by the smallest possible amount of paper at spots A and B. Take hold of end pieces and pull hands apart. Even though pieces are held together by merest shreds, the paper will always break at either A or B, never at both spots simultaneously. An interesting stunt would be the successful performance of this feat (i.e., breaking the pieces at both spots) by the magician, whereas no one else could duplicate it. Can be done with aid of black thread, but does any reader have a better idea?

Frank Rigney presents this as a puzzle, stressing fact that center piece must not be touched in any way by the fingers. His gag solution is to hold middle piece with his lips while he pulls end pieces away.

13. Tie a knot in strip of paper, press flat, then fold over one end (Fig. 679). When held to light, the shadow of a five-pointed star appears in the knot.

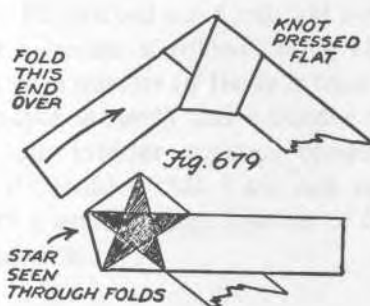

14. Geometrical recreations. There are simple methods of folding a sheet of paper to obtain an equilateral triangle, square, pentagon, hexagon, and other basic figures. A dramatic proof that the sum of the angles of a triangle is equal to a straight angle is obtained by folding the corners of a paper triangle as shown in Fig. 680. For these and similar matters see "Geometrical Exercises in Paper Folding", by T. Sundara Row, 1901.



## COMMENTS AND ADDITIONS

Source:

Date:

## Single-Cut Stunts

Under this heading we shall consider stunts in which a sheet of paper is folded several times, then a single straight cut of the scissors produces an unusual result when the paper is unfolded. "Paper Capers" by Gerald M. Loe, published in 1955 by Magic, Inc. is an excellent manual on paper cutting stunts, most of them of the single cut variety.

If you are interested in working out new effects along these lines you will find that sheets of transparent paper are indispensable. With such sheets you can draw whatever pattern you wish to achieve, then fold the paper until your outlines are properly super-imposed.

15. Regular polygons — triangle, square, pentagon, hexagon, etc. It is not difficult to devise ways of folding paper so a single straight cut will produce any of these figures. The number of sides of the polygon is limited, of course, by the number of folds that can be made without producing a bundle too thick to be cut easily. Tissue or onion skin paper can be used if a large number of folds is necessary.

Regular polygons of two types may be distinguished—the "border" polygon and the "interior" polygon. A border polygon is one that extends to the borders of the sheet. An interior polygon, usually requiring a more elaborate fold, is a figure that does not touch the borders. In other words, it leaves a hole in the sheet which is the same shape as the cut-out piece. Either the polygon itself may be unfolded and displayed, or the sheet may be opened to display the polygon-shaped hole.

16. Irregular polygons. As before, they may be either border or interior types. The latter make the best display. The pieces are torn from a folded sheet of white paper and discarded, then the sheet is opened and held in front of a dark suit so that the opening or openings are clearly visible to audience.

a. Stars. See Loe's book, cited above, p. 56f for methods of cutting stars with any desired number of points. Other star forms (star within circle, star within star, rings of small interior stars, etc.) are explained by Loe on p. 31f. On p. 55 he gives a simple method of producing a chain of eight stars.

## COMMENTS AND ADDITIONS

Source:

Date:



b. Crosses. The Latin cross is easily obtained in border form by folding an oblong sheet three times before making a straight cut. Same fold and cut, using a square sheet, produces a Greek cross, and if the cut is made at different angle, a Maltese cross results. The three forms are given on p. 205 of "Houdini's Paper Magic". Interior crosses of the three types all require four folds (see Loe's book p. 13f.

c. Ladder. See NEWSPAPER, No. 15.

d. Letters. The cutting of square-shaped letters, either of border or interior type, is an interesting challenge. Each letter requires of course its own special fold. See Loe's book, p. 20f, for methods of cutting each letter (interior form) with a straight cut. A good presentation is to cut the initials of any spectator.

e. Swastica. Cutting a border swastica is a difficult problem. As far as I know, Lester Grimes, of New Rochelle, N. Y. was the first to tackle this problem. He worked out a method many years ago in which a square is folded about 18 times, then one snip with scissors (if tissue is used) or wire cutters (if paper is used) and a border type swastica results. An interior swastica presents such formidable difficulties that I am not sure it can be done with a small enough number of folds to make cutting possible.

17. Bi-color cut. This is the name usually given to the stunt of folding a paper checkerboard in such manner that one straight cut will cut out each individual square, at same time separating red from black squares. Any size checkerboard may be used, but the greater the number of squares, the more folds required. A full 8 by 8 checkerboard requires tissue paper to make the cutting easy. The trick was worked out by Stewart Judah and Leslie Guest about 1930.

Walter Gibson, in "Magician's Manual", gives an interesting variation using a checkered sheet on which squares are numbered from left to right.

## COMMENTS AND ADDITIONS

Source:

Date:





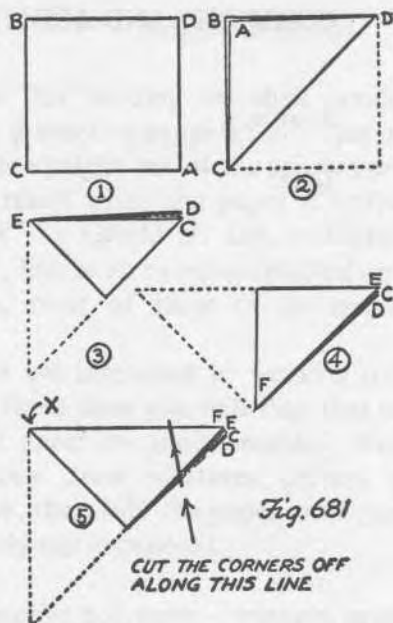

Fig. 681

CUT THE CORNERS OFF  
ALONG THIS LINE

After folding, a single cut produces separate pieces of only the odd (or even) numbers. The remaining numbers remain connected to each other. Audience is allowed to choose in advance whether the odd or even numbers will make the separate pieces. A similar version uses a sheet of evenly spaced polka dots. One snip cuts out all the dots, leaving a sheet with holes at the spots where the dots were.

18. Visualization tests. A test sometimes used by psychologists consists of folding a sheet of paper, making one straight cut, then asking subject to state how many separate pieces of paper result. A similar test involves snipping away a small portion of a folded sheet, then asking subject to state how many holes will be in the paper when opened.

J. C. Coy, in "Modern Magi", March, 1950, gave this version of a hole test. Fold a sheet slowly as in Fig. 681, then snip off corner along dotted line shown in last drawing. Almost no one correctly guesses the number of holes produced. The answer is one! Now refold the sheet once more, very slowly so spectators can try to follow each step in their mind, then snip off corner marked "X" in last drawing. How many additional holes does this produce? The surprising answer is none! The stunt can be done at dinner table by folding and tearing a paper napkin.

## COMMENTS AND ADDITIONS

Source:

Date:

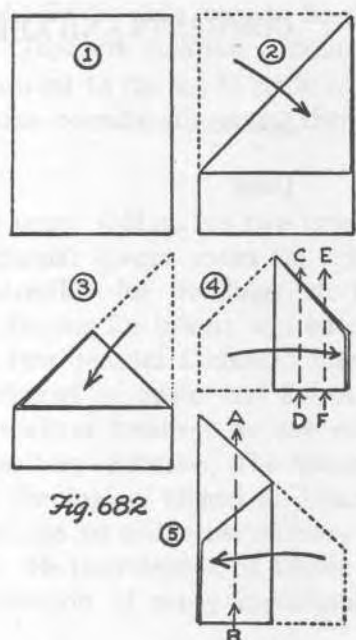

Fig. 682



Fig. 683



Fig. 684

## COMMENTS AND ADDITIONS

Source:

Date:

19. Passports to Heaven. If a rectangular sheet is folded as in Fig. 682, a single cut along dotted line AB in the last drawing will form nine separate pieces. (If you prefer, you can eliminate the last fold and make two cuts along dotted lines CD and EF in the next to last drawing.) One piece opens up as a large cross (Fig. 683-A) and the other pieces can be arranged. (Fig. 683-B) to make the word "Hell."

The stunt has been described often and with many different pattern versions. Usual story is about two men who find themselves confronting Saint Peter at the Pearly Gates. One man is without a passport. He begs his companion for help and the companion obliges by tearing his passport and handing over the smaller pieces. St. Peter forms the word "Hell" from these pieces and naturally refuses to let the bearer enter. The other man is admitted when he presents his passport in the form of a cross. The two men are usually identified as contemporary political leaders, one admirable, one villainous.

For an elaboration of this stunt to illustrate a religious message, see Rev. Don Bodley's contribution to "Tops", Oct., 1954. "Willane's Wizardry", 1947, contains a version involving Mussolini (whose pieces form "Hell"). Hitler (whose passport forms a swastica), and Churchill (cross).

This is the only printable single-cut stunt I know of in which pieces of different shapes are utilized to illustrate a story. There must be many possibilities along such lines that have never been explored.

#### Other Cutting Stunts

See "Newspaper", No. 13f for paper tears that can also be presented with scissors and large sheets of paper. Loe's "Paper Capers", cited previously, contains a valuable discussion of the "prepared message" trick, the most effective of all paper cutting effects. The performer folds and cuts quickly a sheet of paper, then opens it to reveal the name of the organization before which he is appearing, or a greeting such as "Merry Christmas" or "Happy New Year." Although the stunt appears impromptu, it requires a previously prepared sheet. Similar secret stratagems can be used, as Loe explains, for producing complex trade marks and other designs appropriate to the occasion.

#### PAPER FOLDING (Origami)

Paper folding in the classic Oriental sense is the art of folding lifelike reproductions of animals, birds, and other objects from a single sheet of paper (usually a square), and without cutting, pasting, or decorating the paper. On rare occasions these rules may be violated by using a sheet that is not rectangular; making a small cut; adding a spot of paste or piece of cellophane tape; or decorating the object in some minor way after it is formed. But just as the charm of any art lies in working within the confines of that art, so the charm of paper folding lies in working, as far as possible, within the classic restrictions.

The art originated in the Orient. Paper folded birds appear as kimono decorations in Japanese prints as early as 1783, but the art is certainly much older. In the past it was regarded as an accomplishment of all refined Japanese ladies.

#### COMMENTS AND ADDITIONS

Source:

Date:



Now only Geisha girls seem to be skilled in paper folding. Japanese children continue, however, to be introduced to the art in grade school, and Japanese shops occasionally carry sheets marked for folding.

Oriental paper folding has two branches – formal or ceremonial (paper cones for religious ceremonies, butterflies for weddings, etc.) and non ceremonial folding for beauty and entertainment. In the last two decades a marked interest in the art has developed in Spain and South America, and many excellent treatises on the subject have appeared in these countries. The Spanish poet, novelist, and theologian, Miguel de Unamuno, made a hobby of the art and wrote an essay on the subject in 1902. He later developed a basic fold which led to his creation of many remarkable new animal forms.

Friedrich Froebel, founder of the German kindergarten, placed a heavy stress on ornamental paper craft, including elaborate designs folded from squares. The Froebel movement developed an extensive European literature on the subject, but it led to a rococo sterility that offers little of interest today.

The most complete bibliography to date on the art of paper folding was contributed by Gershon Legman to the "Journal of Occasional Bibliography", London, 1952. It lists about 150 titles of books and articles. A shorter version of the list appeared in the New York periodical "Magical", May, 1952.

The following bibliography, based on Legman's, lists books of special interest that are the most readily obtainable in the United States. Later references to these books will be made simply by placing the identifying letter in parentheses.

- A. Blyth, Will. "Paper Magic", 1920.
- B. Blyth, Will. "More Paper Magic", 1923.
- C. Campbell, Mrs. Margaret W. "Paper Toy Making", 1937.
- D. Houdini, Harry. "Houdini's Paper Magic", 1922.

## COMMENTS AND ADDITIONS

Source:

Date:

E. Leeming, Joseph. "Fun With Paper", 1939.

COMMENTS AND ADDITIONS

F. Leeming, Joseph "Papercraft", 1949.

Source:

G. Murray, William and Rigney, Francis. "Fun with Paper Folding", 1928.

Date:

H. Solorzano Sagredo, Vicente. Numerous manuals published in Buenos Aires. He is the greatest living authority on paper folding in South America.

I. Soong, Mme. Maying Hsi. "The Art of Chinese Paper Folding", 1948.

J. Yoshizawa, Akira. "The New Art of Paper Folding".

K. Harbin, Robert. "Paper Magic", 1956.

L. Harbin, Robert. "Paper Folding Fun", 1960.

M. Lewis, Shari, and Oppenheimer, Lillian. "Folding Paper Puppets", 1962.

N. Lewis, Shari, and Oppenheimer, Lillian, "Folding Paper Toys", 1963.

O. Randlett, Samuel. "The Art of Origami", 1961.

*"THE FLAPPING BIRD" by Sam Randlett, a compilation of the 25 units that originally sold by subscription. Complete with index.*

P. Randlett, Samuel. "The Best of Origami", 1963.

The following list of paper folded items (drawn from the many hundreds of items to be found in the literature) is intended to give some indication of the variety of things that can be produced by folding rectangles, with special emphasis on items of interest to readers of this encyclopedia. In many cases I have cited (by letters within parentheses) the most accessible references in which the fold may be found.

For additional folds, consult the sections on BILLS, and NEWSPAPER.

#### Animals

Innumerable animals, birds, fishes, as well as human figures of great realism and beauty may be found in the Oriental and Spanish works on paper folding. The few listed below have been selected because they can be animated in some amusing way.



1. The flapping bird. Greatest of all paper-folded action toys. A life-like bird flaps its wings when its tail is pulled. In recent years it has become a popular dollar bill fold. Wings also flap (after a slight adjustment) when bird's head is pulled. (As you show this, move the bird backward through the air, explaining that he occasionally flies backward so he can see where he's been!) Perhaps there are entertainment possibilities in folding the bird with flash paper, placing on a plate, igniting, then finding a marked coin (secretly loaded into the fold) on the plate. The toy is always a great delight to small children. (C,D,E,G)

2. An odd-looking bird, mostly beak, that opens and shuts the beak when wings are moved in and out. Can be made to pick up bread crumbs from table and swallow them, (E).

3. The hopping frog. Blowing into the figure inflates the frog's belly, then by stroking the back with one finger, it can be made to hop and slide along the table. (B,C,D,E,G)

4. Fish that opens and shuts mouth. (G) See BILL, No. 45).

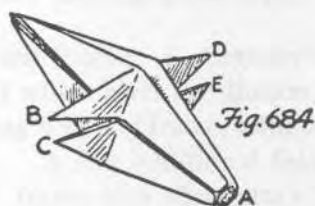

5. Cat that blows smoke rings. This remarkable stunt was passed on to me many years ago by a friend who learned it as a child in Alsace Lorraine. It begins by folding a miniature bellows (A,C) from a large square of fairly thin paper. Snip off a bit of the end at point A (Fig. 684) to make the hole larger. By working the handles in and out, the bellows will blow out a match or candle easily.

Now by blowing into the hole, at the same time using the fingers to mold the paper into a ball shape, the paper will form the cat's head shown in Fig. 685. If you inhale on a cigarette before doing this, the head will fill with smoke. Tapping the back of the head will send tiny smoke rings out of the cat's mouth.

## COMMENTS AND ADDITIONS

Source:

Date:

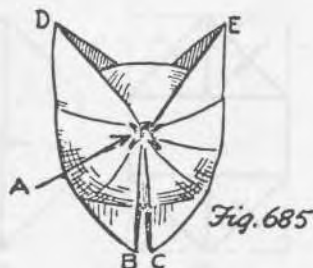

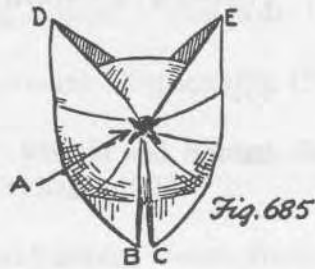

Miscellaneous

6. The familiar glider, known to every schoolboy, can be made to loop-the-loop or curve around corners by bending up the two rear corners of the glider. Bending one corner up and the other down will make the glider rotate as it travels. See "Parents Magazine", Sept., 1952, p. 138 for my description of an interesting elaboration by G. Legman. The glider is so folded that it can be shot across the room with the aid of a rubber band. It has been suggested (as a stage trick) that magician fold a glider, place it on the table, secretly pressing it to a wax pellet on the end of a long thread that leads to the wings. Assistant pulls thread, causing glider to rise mysteriously and sail offstage.

7. A boat that floats on water (E.G.) A biography of Lewis Carroll reports that he delighted in folding this toy for children. If a piece of camphor is scotch-taped at one end, the camphor will propel the boat rapidly through the water. Can also be propelled by putting a pin in front and drawing boat forward with magnet, or be erecting a paper sail against which one may blow. Boats of many other varieties will be found in the literature.

8. Pop Gun. This is a paper device that makes a loud popping sound when swished rapidly through the air. There are many variations, but the simplest is folded as shown in Fig. 686. For a more

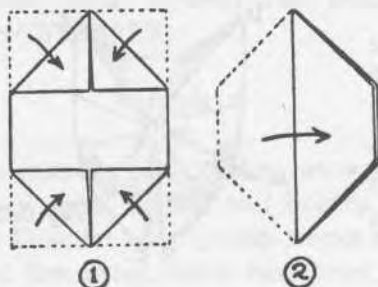

## COMMENTS AND ADDITIONS

Source:

Date:

## COMMENTS AND ADDITIONS

Source:

Date:

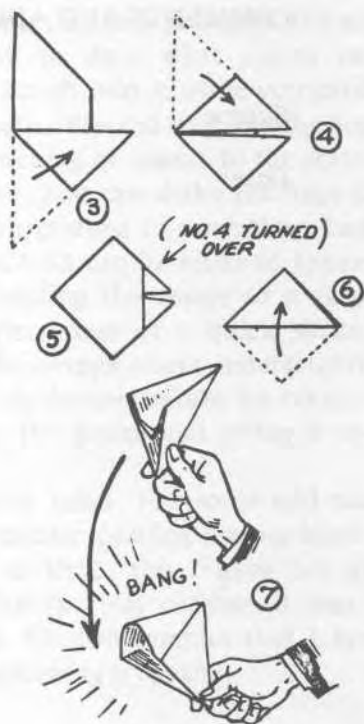

Fig. 686

elaborate one, consult Solorzano Sagredo's "Papirolas Escolares", 1946-47, Vol. I, p. 54. Stewart Judah suggests printing the word "BANG" in large letters on the flap that pops open.

9. Bolt and Frame. G. Legman worked out a curious fold which gives the illusion of a bar of paper penetrating a square frame, although no actual cuts are made. A few additional folds transforms the bolt and frame into Cleopatra's barge. See Legman's description in "The Phoenix", January 23, 1953.

10. Paper cup. The simplest of all folded items. The cup can be used for drinking water. (E)

11. Kettle. Like the frog and cat cited above, this fold is also inflated by blowing into an opening. The miniature kettle which results can be filled with water. If held by one handle over a candle flame, the water will boil without burning the paper. (A,C,G) Bert Allerton discovered that the kettles can be folded with colored Christmas wrapping paper, then pushed over Christmas tree light bulbs to make attractive, glowing ornaments. There is a fire hazard if the bulbs are large ones, so take care.

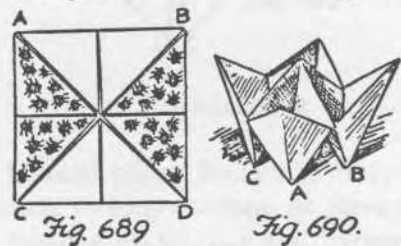
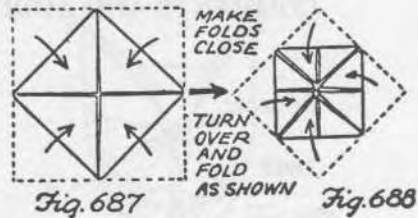

COMMENTS AND ADDITIONS

Source:

Date:

12. Bug catcher. Printed sheets for this stunt were marketed by Ernie Kob in 1948, although the stunt is much older than that. First crease a square sheet in half both ways to locate the center, then fold over the four corners (Fig. 687). Turn the sheet over and fold over the four corners once more (Fig. 688). Pencil the tiny "bugs" on opposite sides as shown in Fig. 689. By bringing corners A, B, C, and D together, the fold forms the well known bon-bon dish pictured in Fig. 690.

The bug catcher operates as follows: Insert thumb in one compartment, index finger in another, middle finger in third, and both ring and pinkie in remaining compartment. With a little practice you will find that you can open the gadget two different ways. One way (Fig. 691) shows an empty interior. The other way (Fig. 692) reveals an interior filled with bugs.

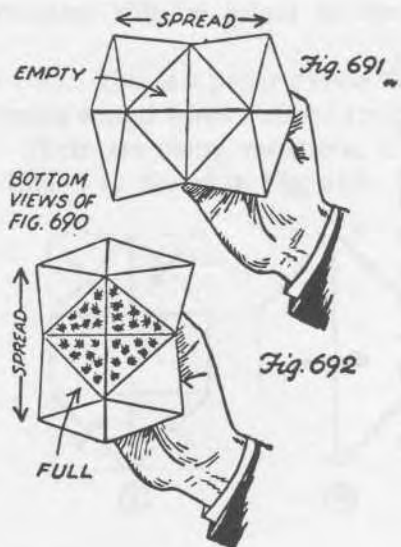

Show empty, make a grab thru the air, open it the other way to show what you've caught. Or let someone cough into it while you catch the germs in his breath. Pretend to shake the bugs out on the floor, switching of course to the empty position as you do so. You can shake the bugs into your left hand, then pretend to pour them back again. The shaking out bit can be made to appear quite startling by holding the device so it faces spectators, then, under cover of a quick shake, the fingers change the compartment undetectably. Ernie Kob finished his demonstration by taking an imitation bug from the device and giving it to a spectator.

13. Fortune teller. For some odd reason, this became a popular pastime among Manhattan school children in 1953, tho I have not yet seen it in print. Like the bug catcher, it uses the bon-bon dish fold. No two samples that I saw were alike, but the following is typical.

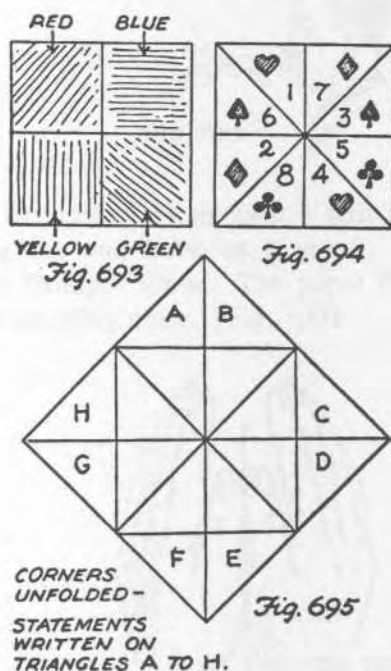

On one side, each square flap was colored a different color with crayon ( Fig.693). On the other side, each triangle was numbered randomly from 1 to 8 and also given the symbol of a card suit - (Fig. 694). The underside of each small triangle (Fig. 695) bore a statement such as "I love you", "I hate you", "You are a dummy", and so on, making eight statements in all.

## COMMENTS AND ADDITIONS

Source:

Date:



To work the device, insert the fingers as in operating the bug catcher. Ask the subject to pick one of the four colors. You now alternate the two finger positions, opening and closing the gadget as you spell each letter of the color. He now peers into the interior and chooses a number that he sees. Open and close the gadget as before, this time counting to the selected number. The subject now picks one of the four visible triangles by naming a suit. Remove the device from the fingers and read the message on the back of the selected triangle. If further ritual is desired, ask him to decide on "true" or "false" before the message is read.

Under this heading we shall consider items constructed easily from paper, but which involve a certain amount of cutting, pasting, etc., in contrast to the classic art of paper folding previously considered. An extensive literature exists on "paper work" (as the Library of Congress classifies it) for kindergarten and elementary school teachers, but this work is too far afield for our purposes. We shall list only items of special interest from a trick or stunt point of view. This precludes such material as Christmas decorations, costume jewelry, ornamental designs, flowers, silhouette cutting, and more elaborate toys that involve considerable construction work. When a capital letter is given in parenthesis, it refers to a book listed in the bibliography at the beginning of the paper folding section.

Noisemakers

1. Magic horn. Roll a square sheet diagonally around a pencil and fasten down the corner with cellophane tape (Fig. 696). Shake out the pencil.

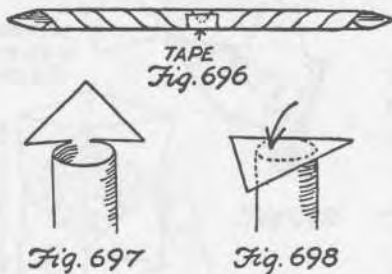

COMMENTS AND ADDITIONS

Source:

Date:



Trim one end of the tube as in Fig. 697, and fold over the triangular piece (Fig. 698) to form a "reed." When you inhale through other end, the reed emits a Bronx cheer. By cupping hands around reed you can achieve a mooing sound. If you pretend you are blowing instead of inhaling, others will be baffled by their inability to make the horn work. Trimming the tube shorter will of course raise the pitch. (E,G.)

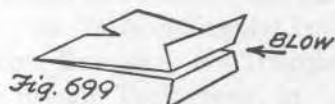

2. A piece of paper cut and folded as in Fig. 699 will give forth a nerve-wracking screech when you blow at the end indicated. The small flaps are held against the lips. (B)



3. Put one end of a long narrow strip in the mouth, putting the end between lower lip and teeth to hold it firmly. Blow. The paper flaps violently with a whistling noise. (Fig. 700)



4. Hold a small strip between the thumbs (Fig. 701). Blow through the thumbs. Makes a high-pitched squeak similar to sound produced in same manner with a blade of grass.

#### Animated animals

5. Rabbit. Fold a square diagonally in half twice, pencil in rabbit's face and tear along dotted line

#### COMMENTS AND ADDITIONS

Source:

Date:

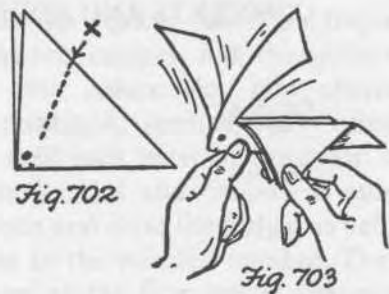

(Fig. 702). By bending down the four corners at "X" (bend two down on one side, two on the other) and holding as in Fig. 703, the bunny's large ears can be made to flap. Jack Chanin contributed this to HMM, Nov., 1947.

6. Caterpillar. Paste together the ends of new narrow strips, the strips at right angles, then pleat them by folding the strips alternately until you form the caterpillar shown in Fig. 704. Paste the other ends together, trimming them even, and pencil in the face. Place on edge of table with a forefinger at each end (Fig. 705). By moving fingers alternately to the right, the caterpillar is made to crawl realistically along the table. ("Humpty Dumpty's Magazine", May, 1954.)

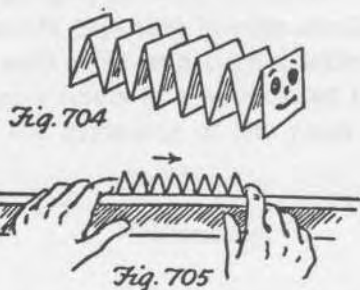

7. Snake. Cut a spiral (Fig. 706) and pencil in snake's eyes. Suspend from a thread at point "A" and hold over a hot radiator or light bulb.

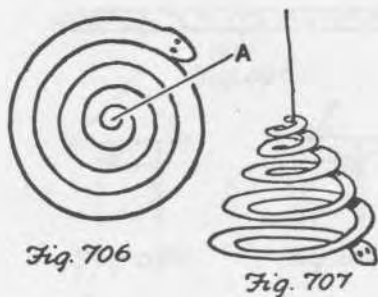

## COMMENTS AND ADDITIONS

Source:

Date:

Rising hot air will make it revolve slowly (Fig. 707). Simplest of many types of paper and cardboard constructions that rotate with convection currents. (B.E.)

#### Geometrical curiosities

8. It is possible to fold a piece of paper in such a way that it forms a Moebius surface (one-sided) with a single edge in the shape of a triangle. For details on how to construct this curious topological structure, see "A Non-Singular Polyhedral Moebius Band whose Boundary is a Triangle," by the inventor, Dr. Bryant Tuckerman, in "American Mathematical Monthly", May, 1948. Other stunts involving the Moebius band were discussed as items 1 and 2 under PAPER.

9. Rotating tetrahedra. These are rings of attached tetrahedra that can be rotated like a smoke-ring. If the sides are painted different colors, some pretty color change effects can be produced. See "Mathematical Recreations", by W. W. Rouse Ball, 1947 edition, p. 153 for details.

10. Hexa-hexa-flexagon. This astonishing structure is folded from one long strip of paper ruled into 19 equilateral triangles (Fig. 708). To make it easy to follow instructions, number these triangles as

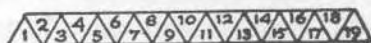

Fig. 708



Fig. 709

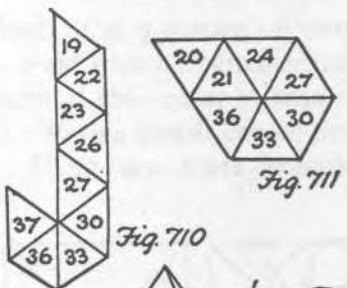

Fig. 710

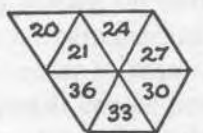

Fig. 711

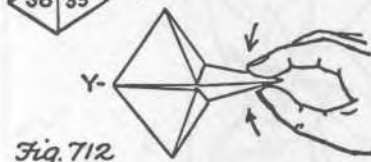

Fig. 712

#### COMMENTS AND ADDITIONS

Source:

Date:

shown. Continue the numbers on opposite side, placing 20 on reverse side of 19, 21 on the other side of 18, and continue to 38 on the opposite side of 1.

Crease the paper forward on every other crease, beginning with the first one (between 1 and 2). The result is pictured in Fig. 709. Now crease back on the line between 32 and 33 (Fig. 710). Crease back on line between 26 and 27 (Fig. 711). Fold over the projecting triangle and paste it on top of 36. In other words, surfaces 36 and 19 are pasted together. You now have a hexa-hexa-flexagon.

To operate the hexa, squeeze together any two adjacent triangles (Fig. 712) and push in on the corner directly opposite (labeled Y in the picture). The hexa will open up into a flat hexagon once more, but with a new upper surface. The surface formerly uppermost will be on the bottom, and the former bottom surface will have vanished into the hexa's interior. By manipulating it in this way you can bring six different surfaces to the top. If you color each surface a different color, the hexa becomes an intriguing puzzle because three of the six colors are relatively difficult to find by random turning. Occasionally you will discover that the hexa will refuse to open. When this happens you must shift over one triangle in choosing the two to be squeezed together.

In addition to the six surface changes, the triangles also rotate so that one surface may appear in six different forms. Thus if you divide each triangle into three parts as shown in Fig. 713, the surface will appear in the three different forms illustrated.

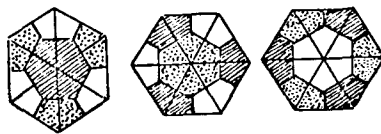

Fig. 713

However, instead of 18 possible patterns that you would expect, there actually are only 15 because three of the patterns are impossible to achieve. Of the 15, six are relatively hard to find by random turning. A neat procedure is to make one of the difficult inner hexagons red, and also use red for the parts of the three hexagons that can never be brought together. All other portions are colored

## COMMENTS AND ADDITIONS

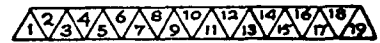

Fig. 708



Fig. 709

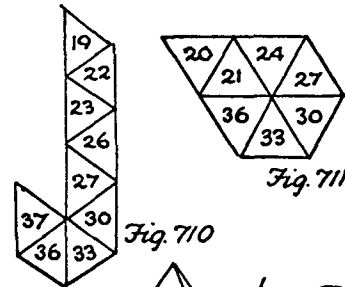

Fig. 710

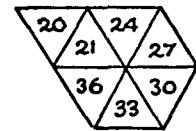

Fig. 711

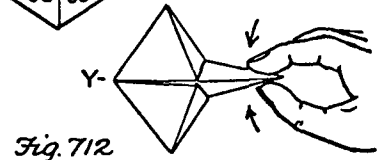

Fig. 712



black. The puzzle is to find an inner red hexagon. Random turning will often expose sides with broken red hexagons, but getting a red hexagon properly put together usually takes quite a bit of turning. Of course there are many other ways the thing can be colored to produce striking pattern changes, composite pictures, words and phrases, etc.

A double hexa-hexa-flexagon can be constructed from a strip of 37 triangles. Simply fold every other line to form a strip of 19 triangles, then construct the hexa from this strip exactly as previously described. The double hexa has twice as many surfaces that can be exposed. An infinite number of higher hexas are also possible, but of course the thickness of paper is a limiting factor.

For more on hexa flexagons see the first Chapter of my "Scientific America Book of Mathematical Puzzles and Diversions".

11. Cherchez la femme. This was the title of a cardboard puzzle item issued by Montandon Magic Company (Tulsa, Okla.) many years ago. The problem was to unfold a cardboard folder in such manner that you found the picture of a woman. The curious method of folding had been used earlier (without composite pictures) on advertising premiums. It can be folded easily from a rectangular sheet of paper that has been cut properly. It was first explained in print in "Willane's Wizardry", 1947. It is one of a variety of tetra flexagons. See Chapter 2 of my "Second Scientific America Book of Mathematical Puzzles and Diversions."

12. Pinwheel. Cut a square on dotted lines as in Fig. 714. Fold over corners marked with an "X" and pin them at the center to eraser end of pencil (Fig. 715). Waving pencil causes pinwheel to spin rapidly. There are more complex variations.

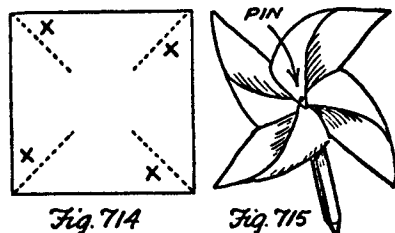

## COMMENTS AND ADDITIONS

Source:

Date:

13. Chains. Paper strips folded as in Fig. 716 can be interlocked ingeniously to form paper belts, "beanies," etc. (Fig. 717). For details see (E), p. 91.

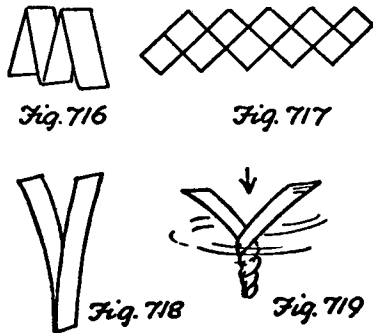

14. Fold a strip in half (Fig. 718) then twist as in Fig. 719. Adjust the "Blades" at proper pitch. When dropped from a height, it will descend slowly, spinning like a helicopter. (E)

15. Paper movies. Fold a sheet of paper (Fig. 720) and draw a cartoon on each flap to represent two positions of some simple action, such as a child bouncing a ball, dog running, man tipping hat, etc. Roll upper flap around pencil to give it a curl (Fig. 721). Hold an upper corner flat against table and move pencil rapidly up and down as shown in Fig. 722 to make upper flap unroll and roll up again. Result: a striking movie effect. Can't prove it, but I hit upon this device as early as the late twenties. It was passed around as a premium gimmick and although some inferior versions appeared in children's books in the forties, the first correct description was in HMM, Sept., 1949.

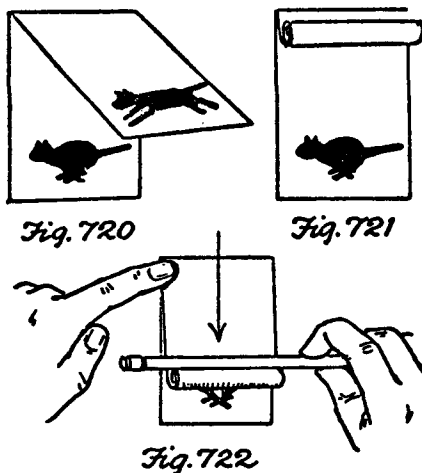

## COMMENTS AND ADDITIONS

Source:

Date:

## COMMENTS AND ADDITIONS

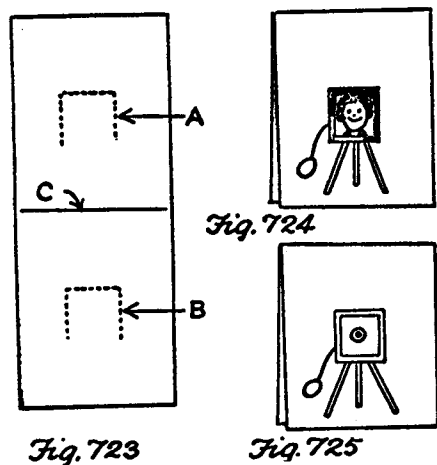

Source:

Date:

16. Camera. On a strip about 3 by 9 inches, cut dotted lines A and B (Fig. 723), then fold on line C. Draw a camera on upper sheet, with a funny face on it (Fig. 724). Now adjust paper so the tiny square flap on lower sheet goes over the flap with the face. On this blank flap draw the camera lens (Fig. 725). To snap someone's photograph, ask him to look at the camera, then quickly lift up the upper sheet. This unlocks the two tiny flaps and the face appears suddenly on the camera. (B)

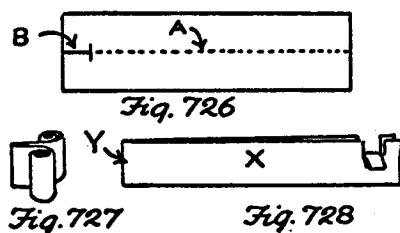

17. Guts test. Cut a strip of paper, about 11 by 3 inches, along dotted line A (Fig. 726), then fold on line B. By pressing each strip between thumb and edge of scissor blade, then drawing thumb and blade along the paper, you can give each strip a strong curl (Fig. 727). Open up the strips and "dog-ear" the ends (Fig. 728) to keep the strips from rolling up again. Mark an "X" on side of one strip as shown. Victim holds the paper at Y. Set fire to dog-eared end. If victim can hold the paper until flame burns to the "X" he passes the test. What happens, of course is that as soon as the dog-eared ends are consumed, the flaming strips suddenly curl back toward victim's hand, forcing him to drop the paper. The earliest reference I have seen to this stunt was a German book by Herman Pfeiffer, 1909.

## PAPER BAG

## COMMENTS AND ADDITIONS

There is a book by the Amazing Maurice, called "Paper Bag Magic", 1968, containing many ideas not listed here.

Source:

Date:

1. Problem: blow over heavy book standing on end. Solution: stand book on a flattened paper bag, blow into bag.

2. Water can be boiled in paper sack without burning it.

3. Breathing into paper bag will, it has been claimed, stop hiccoughs.

4. To vanish small objects, prepare bag with paper pocket on one side. As you place object in bag it goes into this pocket. Inflate bag, pop it, crumple and toss aside.

5. To produce a vanished finger ring. Left hand (with ring palmed) goes into bag to hold it while right hand pushes a pencil through sides of bag. Pencil goes through ring. Spectator now holds each end of pencil. Twist top of bag closed so he can't look down and see ring. Later, you rip off bag, exposing ring on the pencil.

6. With a little ingenuity a variety of children's masks (animals, space helmet, clown, etc.) can be made quickly from paper sacks. Also various types of headwear (overseas cap, king's crown, baker's hat, etc.)

7. Party games and stunts.

Each guest puts a bag over his head, draws face on front with crayon. Prize for best face.

Two guests compete blindfolded to see who can first fill his bag with confetti from large bowl. After blindfolds are in place, switch their sacks for two bottomless ones.

Inflate sack, tie it closed with one end of piece of string several feet long. Each guest takes free end of string, swings sack in overhead circle, and throws it as far as he can. Prize for longest throw. (It is hard to toss bag beyond a very short distance.)

Two teams line up in two rows, each guest holding a sack. Last man of each row inflates his bag, pops it on back of guest in front of him who then inflates his bag, etc. First row to finish wins. See Harbin's "Fun Encyclopedia" for other paper sack games similar to this.

#### PAPER CLIP

In 1947 U.F. Grant published a manuscript of eleven pages on paper clip tricks. It was titled C.L.I.P. Most of the tricks required special preparation or equipment that took them out of impromptu category.

(1.) The dollar bill and paper clip trick that swept the magic world in 1954 apparently originated with Bill Bowman of Seattle, Washington. It first appeared in print in issue No. 310 of "The New Phoenix" (June, 1954.) Two clips are attached to a bill as in Fig. 729. When bill is pulled straight, the clips pop into the air linked. With practice you can jerk the bill so the clips jump upward, permitting you to catch them with one hand. Or you can hop them forward into spectator's hands.



Fig. 729

Fig. 730

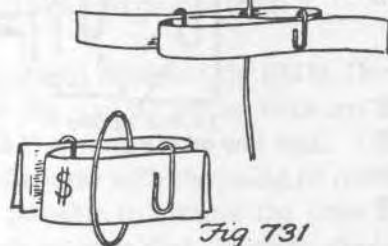

Fig. 731

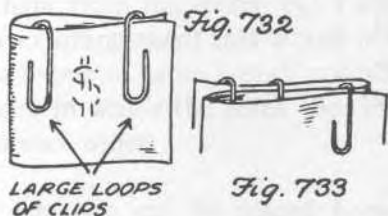

Fig. 732

Fig. 733

#### COMMENTS AND ADDITIONS

Source:

Date:



A piece of paper or length of heavy ribbon can be substituted for the bill. Two loose key rings can be used instead of clips. Bowman's presentation involved one steel and one copper clip, and patter about a couple who get "linked" in marriage.

It can be presented as a bet: that when the clips fall they will come to rest touching each other.

The following are some of the many variations that have appeared in print, most of them from "The New Phoenix".

For a bibliography of 29 references, see Jack Potter's "Master Index to Magic", Vol. I.

1. Link a third clip through one of the two clips on the bill before you pull the bill straight. Spectator holds this third clip. Instead of clips landing on floor, as they usually do, spectator is left holding a chain of three linked clips.

2. George Blake suggested running a thread or string through one of two large clips fastened on a folded piece of wide ribbon. Spectator holds the string while you pull ends of ribbon.

3. A clever version that appears to link three separate clips was worked out by Duane Duvall. Some secret switches are involved. See "The New Phoenix", No. 319 for the moves.

4. Tom Osborne contributed a fine four-clip variation to "Tops", Oct., 1954. Four apparently separate clips become linked after a series of well thought out moves.

5. Harold Turner suggested soldering two clips together. Do the usual trick once or twice, then switch the linked clips for the soldered ones as you hand them to spectator with request that he try the trick.

6. An interesting routine involving six clips and ending with three clips becoming linked in spectator's fist was contributed by Leslie May to "The New Phoenix", Oct. 22, 1955.

7. G. E. Emme suggested ("The New Phoenix",

## COMMENTS AND ADDITIONS

Source:

Date:

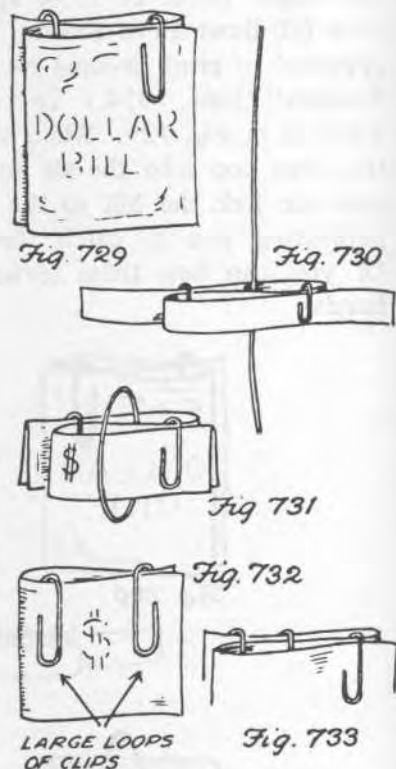

March, 1955) that a string be run through ribbon or bill as in Fig. 730. Spectator holds ends of string. Clips become linked and hang from string.

8. Dai Vernon suggested using a rubber band instead of string. First fold bill in half lengthwise, then arrange clips and band as in Fig. 731. Spectator holds band. See "The Dai Vernon Book of Magic", p. 103.

9. Stewart James suggested ("The New Phoenix", March, 1955) making an endless chain with several dozen clips. "Break" the chain by opening it at any point, then "restore" it by attaching the end clips to bill or ribbon.

10. James also proposed (ibid) the following unusual version of sympathetic silks. Sew a paper clip to one corner of each of four large silks. Link two silks together before showing. Count the four silks as separate, using the familiar move explained by Al Baker on p. 66 of "Magical Ways and Means". Place the two linked silks aside. Remaining two silks are now linked by means of ribbon. Instead of jumping off ribbon, they remain draped over it and can be lifted off by a spectator. Other two silks are now shown to have sympathetically linked themselves.

11. Paul Curry (ibid) came up with a new method of linking. The clips are placed "back to back" on a bill exactly as in Fig. 732. As you pull the bill straight, tip it so the edge with the clips dips slightly toward floor. One clip will remain on the bill, the other will link and dangle from it.

12. Elmer Applegit disclosed (in HMM, Dec., 1955), that a third clip can be placed between the other two (Fig. 733) and all three will link. This can be combined of course with the string or rubber band. It might be possible to arrange the three clips and string in such manner that the clips would always hang in a chain from the string, but I was unable to find such an arrangement that would work every time. There seems to be no way of controlling the precise manner in which the three clips link to the string and to each other.

More than one clip can be placed between the other two, and all will link, but nothing seems to

## COMMENTS AND ADDITIONS

Source:

Date:

be gained from these additional clips. It also is possible to make extra folds in the ribbon to take care of additional clips.

13. For some amusing patter by Norman Houghton, and a climatic production of a handful of smaller clips, see "Ibidem", No. 21, June, 1960, p. 13.

(2) A wrist penetration effect by John Boyko, using two clips on a small loop of string, appears in Bruce Elliott, "The Best in Magic", p. 5.

(3) Grade school children occasionally annoy their teacher with this stunt. Open up a clip as in Fig. 734. Force the tips together and overlap them (Fig. 735) to prevent the ends from springing apart. When dropped on floor or top of desk, the ends spring open and clip jumps several feet into the air.



(4) Gimmick for suspended glasses. By bending up the ends of a paper clip, with a pair of pliers, you can make the gimmick for performing the well known trick of covering a book or tray with a handkerchief, then causing two glasses on the book to remain suspended when book is inverted.

(5) Bar bet. Straighten clip, then bend one end so clip will hang as shown in Fig. 735a from a paper match held at each end, or from a small piece broken from wide end of a flat wooden toothpick. The wire is flicked with middle finger of right hand so it spins in direction of arrow. Bet that wire will come to rest pointing up instead of down. Although it would seem otherwise, odds are very high you will win. ("Ibidem", No. 18, October, 1959).

## COMMENTS AND ADDITIONS

Source:

Date:

## COMMENTS AND ADDITIONS

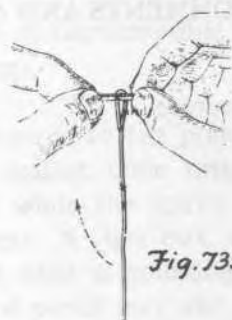

Fig. 735a

Source:

Date:

## PEN

1. Paper cut-out of clown is attached to point of pen and pen is supported inside a finger loop of scissors as shown in Fig. 736. A circular motion of hand sends the pen revolving. The pen rotates as it revolves, causing clown to spin rapidly as he whirls around the circle. (Tom Tit, "La Science Amusante", Vol. 3).

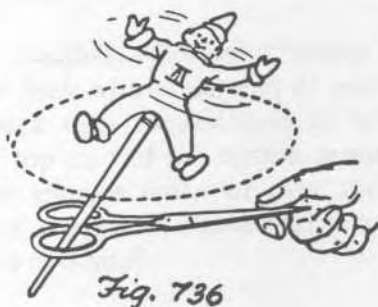

Fig. 736

## PEN POINT

1. Bend the halves of a pen point as in Fig. 737. Now force them straight again until their edges catch and hold. When dropped, the halves spring apart and pen point jumps a short distance off the table. (Tom Tit, op. cit.)



Fig. 737

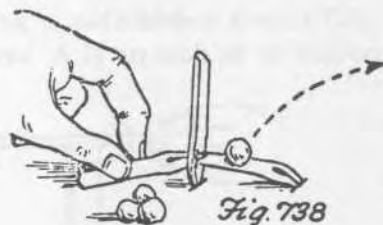

Fig. 738

2. Three pen points can be used by a child to form a miniature catapult for bombarding penmanship teacher with tiny paper balls. Two are stuck into desk and third serves as trigger release as shown in Fig. 738. (Tom Tit, op. cit. Vol. 2)



## PENCIL

1. Magician places his palm on top of pencil (lying on table), quickly raises hand to vertical position. Pencil remains clinging to palm (Fig. 739). Persons with naturally moist palms can usually do this at any time. The fleshy mounds at base of fingers are pressed firmly against pencil, then hand raised quickly. If hand is dry, moisten the mounds with saliva and massage before showing. Wooden hexagonal pencil works best.

For suspension methods in which pressure is secretly applied by fingers, see KNIFE, TABLE, Nos. 9, 10, 11, and 13. Methods using pins, thread, and other devices are covered in section on wand suspension, Sach's "Sleight of Hand", Chapter 15. Other thread methods will be found in Hoffman's "Later Magic", p. 104f.

2. Ralph Read's spirit pencil. A pencil with no eraser should be used, or a mechanical pencil or closed fountain pen. It is necessary that when end is held as in Fig. 740, the thumb comes in contact with wood or plastic. By pressing tip of thumb forcibly against pencil and pushing up, the tip will

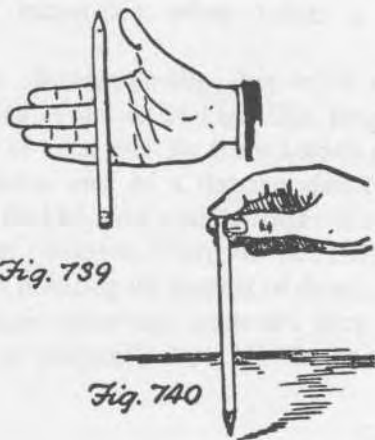

## COMMENTS AND ADDITIONS

Source:

Date:



slide upward in imperceptible jumps, each jump producing a rap.

Usual procedure is to tap point of pencil two or three times against table top, then hold pencil against table while the spirits answer with same number of raps. A cigar box, wooden match box, etc., may be used as sounding board to amplify raps. Point of pencil may also be pressed on back of spectator's hand, permitting him to feel the impulses, or against his temple. Thumb must be dry. A bit of rosin rubbed on the tip will keep it in readiness as well as increase sound of raps.

See Thompson's "My Best", p. 184, for Read's description. The trick had long been featured by Eugene Bernstein who did an extremely effective stage version. An assisting spectator holds center of pencil while performer holds upper end, a presentation that dramatizes the trick considerably.

3. Card location. Spectator pushes out a mid-section of deck with eraser end of pencil. As you extend pack with request that he lift up index corner of top card of the section pushed out (Fig. 741), you glimpse index of card above selected one. Deck is squared, cut several times, and trick terminated as desired.

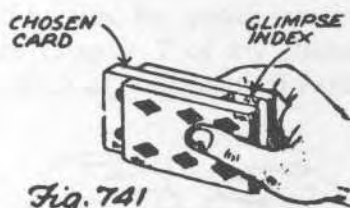

4. Ribbon and pencil. Pencil is held at both ends by a spectator. Hang a wide ribbon over it (Fig. 742), making sure end A is an inch or so shorter

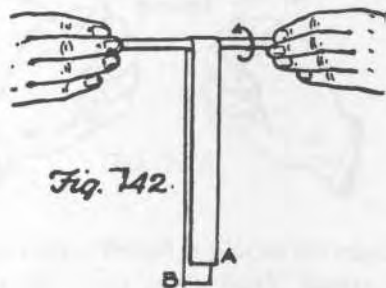

## COMMENTS AND ADDITIONS

Source:

Date:



than B. Spectator winds ribbon on pencil by twisting in direction of arrow, while you hold ends of ribbon. After ribbon is fully wound, allow end A to go over pencil, concealing this with your hand. Spectator now holds pencil loosely while you pull on ends. Ribbon of course pulls free. Same move can be used for putting it back on again. String may be substituted for ribbon (See FOUNTAIN PEN, No. 2).

A pretty variation is to loop ribbon over a pencil of one color, then place a pencil of contrasting color alongside the first. When ribbon is unwound, the loop is found transferred from one pencil to the other.

5. A topologically fascinating variation of above trick makes use of a closed loop of ribbon or cloth. Pencil is held in left hand while right hand winds the ribbon until Fig. 743 is reached. Note that left forefinger holds the wound ribbon in place, but is

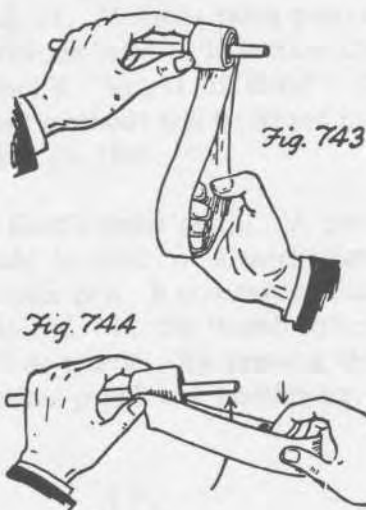

beneath the last turn of ribbon at point A. Seize the hanging loop with right hand as shown. As you extend left end of pencil toward spectator for him to hold, right hand passes the loop over right end of pencil (Fig. 744). The movement of right hand can be held to a minimum by moving left hand so that the end of pencil is carried forward through the loop as left hand moves forward. Right hand does little more than remain stationary. After spectator takes left end of pencil, ask him to seize other end in his other hand. As he does this your right hand (still holding the loop) gives the ribbon a half twist so that it hangs straight when you re-

## COMMENTS AND ADDITIONS

Source:

Date:

lease it. When ribbon is unwound, it will be found free of pencil.

The same move can be used of course for putting the ribbon on the pencil. It can be made at any point during the winding. There are numerous techniques for making it, but the above seems to me best. Two pencils of contrasting colors can also be used in this variation as explained before.

5a. The principle of the handkerchief from rod release (see HANDKERCHIEF, No. 14) can be applied to pencil and string. Wrap string four times around pencil, then hold center of string against pencil with left thumb. Right hand continues wrapping, but now wraps string four times around pencil in opposite direction. With proper handling, you appear to have wrapped cord eight times around pencil. Let spectators seize the hanging ends and pull while your thumb keeps string from pulling free. When you release pressure of thumb, the cord pulls completely free of pencil.

5b. Stewart Judah's pencil, shoestring and soda straw. The principle involved in handkerchief trick No. 13 was applied by Judah to a shoestring and pencil in such a way that when shoestring is pulled, it apparently penetrates both pencil and a flattened soda straw held alongside pencil. Soda straw is cut in half by this, but pencil remains intact. For details, see Chapter 7 of my "Second Scientific American Book of Mathematical Puzzles and Diversions".

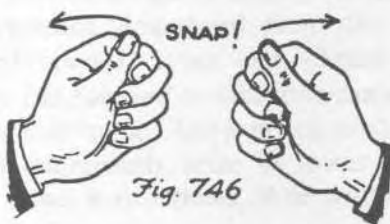
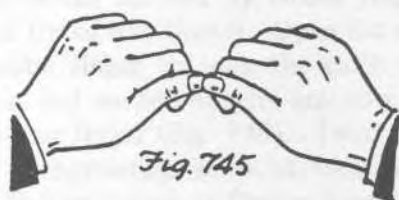

6. Lap and snap. Pencil is placed on edge of table. Pretend to pick up with both hands, held together, actually sending it into lap with tips of fing-

## COMMENTS AND ADDITIONS

Source:

Date:



ers as they curl downward to pick it up. Raise both hands as in Fig. 745. Pretend to break pencil in half by a quick twist of both hands (Fig. 746), at same time snapping right thumbnail off left thumbnail. The loud snap will sound like a wooden pencil breaking. Open hands to show pencil has vanished. Reproduce by lowering left hand to lap, picking up pencil and bringing it up inside of coat. Right hand opens side of coat as left pretends to extract pencil from inside pocket.

#### Pencil and Hank

7. Several effective vanishes make use of a finger to simulate a pencil beneath the cloth. For example, see KNIFE, TABLE, No. 19 for a routine that adapts well to a pencil. Instead of dropping pencil down sleeve as in this version, it may also be dropped in breast pocket of jacket if hank is held high enough to screen the move. Even if pencil is large enough to project from pocket, it will not be immediately noticeable after the vanish and you can reproduce it by simply taking it from pocket. See Tom Sellers' "Tricks That Work", 1927, for a similar routine in which a wand is dropped into left coat pocket, later produced from behind the knee.

These moves can also be used for stretching a pencil: for example, short pencil is sleeved and long pencil taken from same sleeve. Right hand seizes top of pencil through cloth, pulls up, apparently stretching pencil to twice original size. A wrist watch band (or rubber band on arm) can be used in all such routines for holding pencil in the sleeve.

8. Seymour Davis' penetration (sold as "Seymour's Phantom Hanky" about 25 years ago). The best of the methods by which pencil is apparently pushed through a well formed in fist. A cigarette, table knife, wand, cane, or even a silk of contrasting color may also be used.

Begin by covering left fist with hank and asking



#### COMMENTS AND ADDITIONS

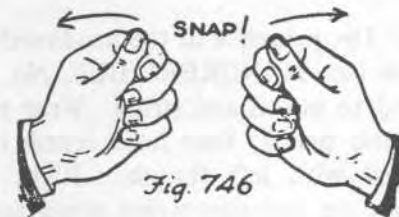



Fig. 748



Fig. 749

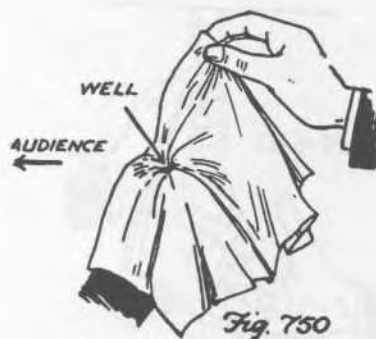

Fig. 750

spectator to push center of cloth into fist. Remark that the well is not deep enough as you insert your first finger to deepen it (Fig. 747). Middle finger points toward the floor on right side of fist, resting in a crotch formed by closed fingers of left hand and tip of left thumb. Open fist slightly and grab middle finger through the cloth (Fig. 748). Both first and second fingers are now inside fist. Remove first finger (Fig. 749). Twist the hand as though strengthening sides of well with middle finger. This exchange of fingers forms an invisible tube extending downward from the opening of well, and open at lower end. Insert pencil into well. Tip fist forward so everyone can see that well is in center of hank. Allow pencil to drop through, or reach underneath, seize its lower end, move it up and down a few times, then withdraw it from below.

I have found that an effective termination of the trick, after the penetration is as follows: Extend

## COMMENTS AND ADDITIONS

Source:

Date:





left hand to right of your body, tipping the fist so audience sees the opening of well. Reach down with right hand and seize the edge of hank on the side that formed the tube. Open the fist just enough to allow you to pull this side from the fist and raise it up into view (Fig. 750). Left fist remains firmly closed around the original well. Pull slowly on the edge you have raised. This will pull the cloth from the fist, providing a convincing proof that well was in center of hank and allowing you to call attention to fact that there is no hole at spot where penetration occurred.

Under certain conditions, a faster and bolder method of forming the concealed tube is as follows: Extend left hand forward for spectator to form the initial well. As you bring hand back toward body, turn so your left side is toward audience. Immediately insert middle finger into well. Actually, the finger goes into fist from the side, as in previous move, to form the tube. This takes place on side of fist away from audience, and if done quickly, with misdirection produced by speaking to spectator, move will not be noticed. Left fist should tip back slightly toward right hand as move is made to give impression that finger is inserted into well from above rather than from side.

9. Duke Stern's penetration. Hold pencil by end, point at top, and ask someone to drape hank over it. Left hand appears to grasp pencil point through the cloth (Fig. 751) but actually grasps only cloth. Right hand gripping pencil between second and third fingers, levers pencil back toward you, as shown, then thumb goes beneath pencil and levers it up again on outside of cloth.

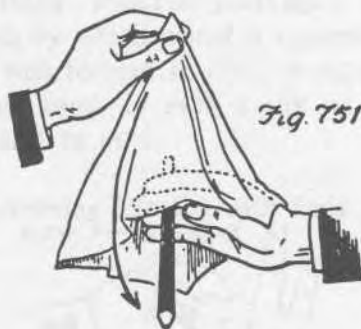

## COMMENTS AND ADDITIONS

Source:

Date:



Left thumb now grips point of pencil (Fig. 752). Close left hand in a fist around cloth and pencil. With right forefinger, push pencil up into view (Fig. 753) as though penetrating center of hank. The move is undetectable from front and should be done rapidly to provoke maximum surprise. The longer the pencil the more effective.

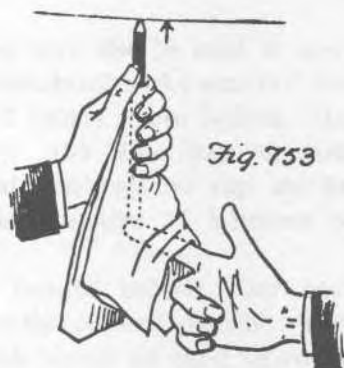
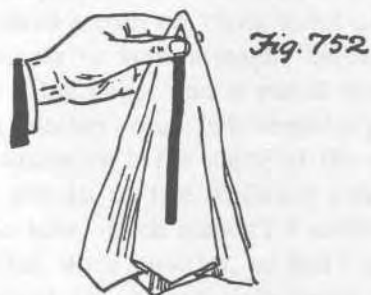

An elaboration makes use of two different colored pencils. Bring only one pencil outside, by the move described. Then allow spectator a "magician's choice" of color, causing chosen pencil either to penetrate or remain inside while you extract the other. Different moves have been published for producing a similar effect (e.g. Tom Sellers' penetration, "Immediate Magic", 1937), but all impress me as inferior to Stern's handling.

10. Procure a hank with a pattern of some sort that covers the center. Near the center, along a border of the pattern where it will not be noticeable, cut a half-inch slit. You'll find you can completely flabbergast a fellow magi with a pencil penetration, simply by pushing pencil through the slit. Work out a handling that conveys a faint impression of some subtle sleight being employed. Shake hank open at finish, then pocket it and refuse to repeat.

## COMMENTS AND ADDITIONS

Source:

Date:

Laymen, unfortunately, think immediately of a hole in the cloth.

11. Hank is opened flat on table, pencil placed in center, then hank folded in half diagonally (Fig. 754). Corner A must extend an inch or so beyond corner B. Place both palms on pencil and roll forward to form a cloth cylinder. When you reach the corners, allow B to go once around but conceal this with your hands. Spectator now holds the two corners against table with a finger while you unroll hank toward you. Pencil is found outside the hank. The trick can be repeated with same move to transfer pencil back to inside. As in No. 4 above, which operates on the same principle, two pencils of contrasting colors may be used — one inside, one out. After unrolling, the pencils will have changed places. This incidentally, is one of the best tricks to teach a small child.

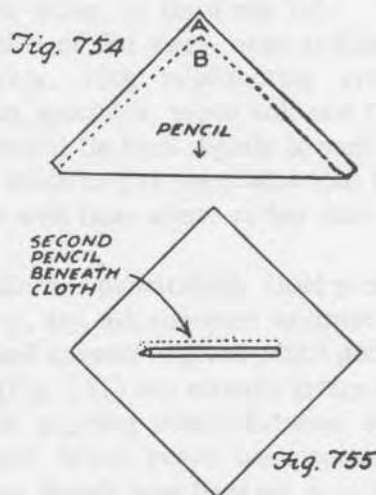

The principle can also be used for a transformation. The second pencil, of contrasting color, is concealed beneath the hank when it is first opened flat. Place the first pencil in the center (Fig. 755), then fold in half, this time making the top corner the short one. Start rolling under the cloth rather than over, picking up concealed pencil in the roll. Then turn the cloth over and continue rolling as previously explained, allowing short end to pass once around the cylinder. A spectator holds the lower corner only while you grasp upper corner and pull it back toward you. This automatically laps the first pencil and reveals the second one

## COMMENTS AND ADDITIONS

Source:

Date:

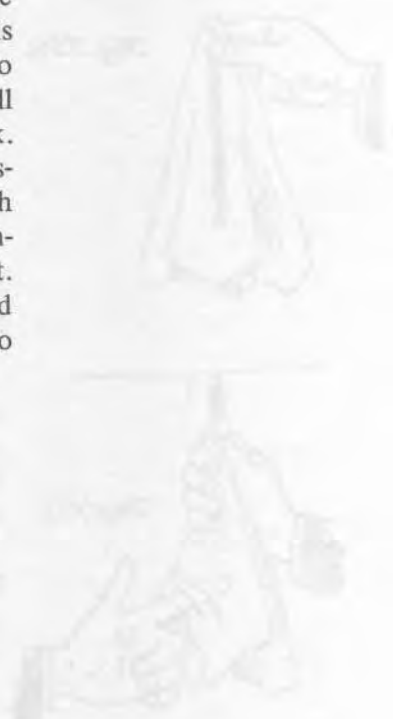

inside the hank. The trick can be done at the dinner table with a cloth napkin, causing one piece of silverware to change to another.

#### Mental Effects

12. Pencils can be used in many ways to communicate secret information to assistant. Example: someone places a coin on blank sheet of paper for a few moments to leave a magic "impression" on the paper. This paper and a pencil are taken to assistant in another room. He inspects paper carefully then writes on it the name of the coin. You must have pencils of five different colors in five different pockets. Each stands for a different coin (penny, nickel, dime, quarter, or half). As soon as coin is selected, take appropriate pencil from pocket and leave it unobtrusively on table.

A single pencil may also be used to convey information. (a) Thumbnail nicks wood of pencil above certain printed letters (Tom Sellers, "Tricks That Work", 1927). (b) Metal cap on eraser end is turned so that markings on cap are brought to desired position relative to lettering on pencil.

13. You are handed behind your back one of several differently colored pencils. Turn to face audience. Push pencil up right sleeve, pushing it under a rubber band around forearm but allowing end to project enough so you can see it when you bring right hand in front. Let the arm hang naturally at side for a moment, then rub forehead with tip of middle finger, keeping fingers spread to show that nothing is being held. Do not move your eyes to glance at pencil in sleeve. Color can be caught with side vision.

14. Similar to above except you are handed all the pencils at once. One at a time you name a color, then bring the corresponding pencil forward with one hand. For this you need a duplicate of each pencil. Duplicates are up left sleeve, held by rubber band around forearm. They are side by side in known order. Push the other pencils under a band on right forearm, then produce the duplicate one at a time. (Based on trick by Tom Sellers, "Immediate Magic", 1937).

#### COMMENTS AND ADDITIONS

Source:

Date:



15. Similar to No. 13 above except you do not turn to face spectators. In other words, a pencil is handed to you while your back is toward audience, and while it is in full view you name the color. Gimmicking the pencil is not a good method because everyone can see exactly how you hold or touch it. A better solution is to have a small hand mirror on your person where it can be obtained easily by right hand. Stand with feet slightly apart. Hold pencil by one end in left hand and shake it up and down a few times. Right hand lowers mirror as far as possible and tilts it so you can see between your legs. A downward shake of pencil will bring it within view of the mirror. (Fig. 756) A dentist's mirror on a rod might work even better. Sounds silly but if carefully executed it can be extremely puzzling.

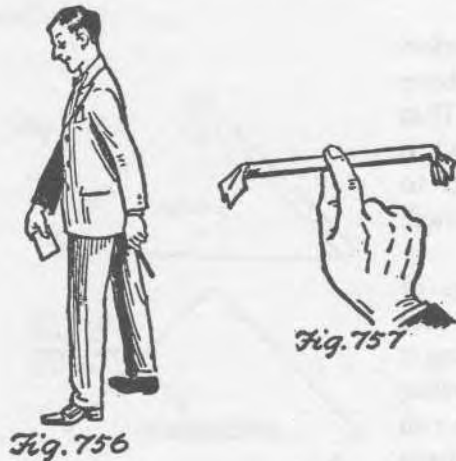

16. While your back is turned someone rolls a pencil tightly in a piece of newspaper, fastens down edge of paper with cellophane tape, then bends over the end. You turn around, take pencil between thumb and finger (Fig. 757), hold it to forehead, then correctly state which way pencil is pointing. Hold pencil exactly in center. Eraser end, being much heavier, will tilt downward. Does not matter whether pencil has a point or not.

17. No-write pencil. A pencil that will not write makes possible a number of mental effects. For example, a playing card can be forced simply by asking someone to hold deck behind his back and mark a large X on the face of any card. He is given of course a no-write pencil and deck already contains an X'ed card. A page of book or magazine can be forced in same way. For impromptu work,

## COMMENTS AND ADDITIONS

Source:

Date:



use a mechanical pencil or ball point pen with retractable point. Simply retract the lead or point before handing it out.

Bill Nord informs me that coating pencil point with transparent nail polish will prevent it from writing. He also calls my attention to a subtle method suggested by William Houghton in his book "The Magic 36". Break off a small piece of lead, then reinsert it in a mechanical pencil. You can now make a mark with the pencil to show spectator what you wish him to do. Before handing him the pencil pretend to adjust it to give him a better point, but actually retract the lead. The small piece of lead will remain projecting, but when spectator uses pencil behind his back, the piece is pushed into the barrel and no mark results.

#### Stunts and Gags

18. An amusing joke on a brother magi is to pretend not to know the trick of breaking pencil with dollar bill (see BILL, No. 6). He offers to demonstrate. You hold a pencil you have previously broken in half then pushed together again so it appears unbroken. When he strikes the pencil with the bill, pull it apart so that his finger passes between the broken ends. Feign amazement while he tries to figure out what happened.

If a stooge holds the prepared pencil, you can fool other magicians. Appear to break it with dollar bill, but hold bill in such manner that you obviously cannot be using your finger to break the pencil.

19. Announce that you own a mechanical pencil so cleverly contrived that it will write any color called for. Suppose someone calls for "pink." Pretend to make the necessary adjustments, then write the word "pink."

20. Leaky ceiling. Place a sheet of paper over a pencil and hold as in Fig. 758. Look up at ceil-



#### COMMENTS AND ADDITIONS

Source:

Date:

ing and pretend to catch drops of water on the paper. Sound of drops is created by pressing thumb firmly against paper and pencil, then sliding paper forward with a series of small, undetectable jumps. Each jump produces a loud tap. A common presentation among school children is to pretend to catch flying insects, fireflies, etc., on the paper, each "catch" resulting in tap. Then they pretend to toss them at one another.

21. If a hexagonal pencil is held vertically against the woodwork and pushed quickly upward with strong pressure, the heat generated by friction will sometimes cause the paint on pencil to adhere to the woodwork firmly enough for you to hang a hat on the pencil.

22. Place a pencil under the tongue. Curl tongue over pencil and feel inside of lower teeth with tip of tongue (Fig. 759). Feels as if teeth slope sharply inward.



Fig. 759

23. Tell a friend "I can write faster than you can." To prove it, a contest is arranged. You of course write the phrase "faster than you can."

24. An indelible pencil will write on beer foam.

25. Rubber pencil illusion. Hold pencil near one end as in Fig. 760. Wave hand up and down. The up and down motion should cover a distance of

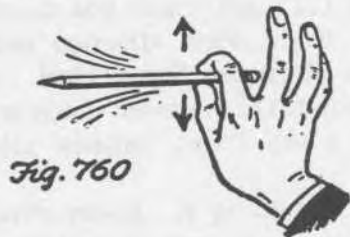

Fig. 760

no more than two inches. Pencil must be held very loosely and there should be no movement whatever of finger or thumb as pencil is shaken. Done properly, the pencil appears to be made of rubber.

## COMMENTS AND ADDITIONS

Source:

Date:

Bert Allerton idea: Show friend at table an actual rubber pencil, switch it in lap for duplicate wooden one, work the illusion, then say that if you stop quickly enough the rubber becomes rigid. Stop shaking the pencil suddenly, toss the wooden pencil forward for examination. Or work in reverse. Let the wooden pencil be examined, work the illusion, switch for rubber pencil, shake it again, then bend it almost double and toss out for examination.

25a. Short pencil illusion. A pencil about six inches long is held horizontally, a hand holding each end between fingers and thumb, fingers pointing inward. If pencil is passed quickly from hand to hand, the hands alternately seizing ends as pencil moves horizontally from one hand to other, the pencil will appear to be about three inches long. First show the "short" pencil this way then pretend to stretch it. The illusion works with a pocket comb and other objects that are the same at both ends.

26. Several balancing stunts with pencils and pocket knives are illustrated in Fig. 761.

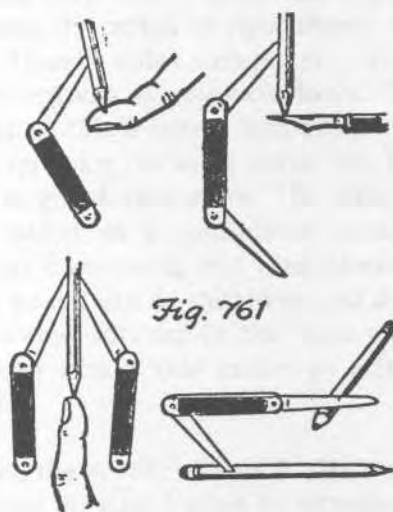

27. Mystery propeller. Notch the side of a pencil as shown (Fig. 762) and attach a small cardboard rectangle (3 by 3/4") to eraser by means of a pin. To make the cardboard spin counterclockwise, run another pencil back and forth across the notches (Fig. 763). Tip of right thumb must slide along side of pencil, otherwise propeller will not spin. To reverse direction of spin, simply shift right hand slightly so that instead of thumb, the tip of right

## COMMENTS AND ADDITIONS

Source:

Date:

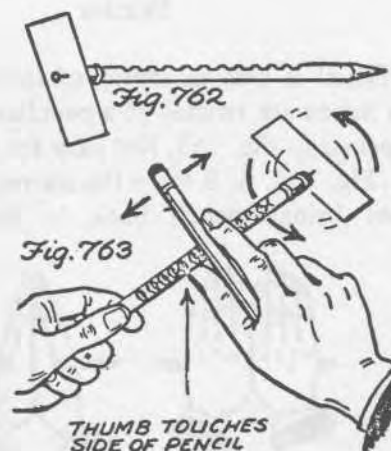

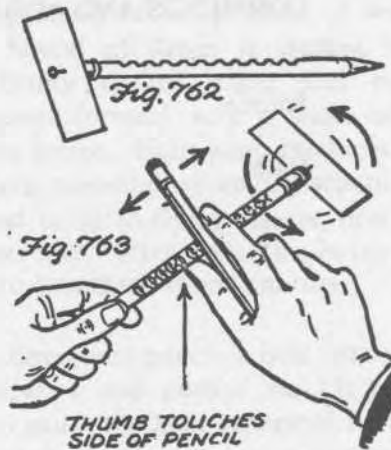

forefinger slides along pencil on the other side of the notches. With practice you can make propeller go first in one direction then the other, as commanded by spectators, without stopping the rubbing and with such a slight shift of right hand that it will not be noticeable. Others of course are unable to make the cardboard spin at all. This intriguing little toy is very old and descriptions are found in many old books and magazines.

28. A full size pencil may be taken from vest pocket simply by having a hole in pocket to accommodate the pencil. A tiny purse, also with hole in base, may be carried in pocket with end of pencil inside it. Take purse from vest pocket, concealing projecting pencil, then open it and take out pencil. Or pencil may be concealed in left hand. Right hand takes purse from pocket, shows it freely, then places it in left hand, the end of pencil going up through the hole. Open purse and extract the long pencil.

#### Puzzles

29. Pencil is held in crotch of thumbs (Fig. 764), then hands are twisted in a peculiar manner, bringing pencil to Fig. 765. Not easy for others to duplicate. Fig. 766, A, B show the moves. Reversing the moves brings pencil back to former position.

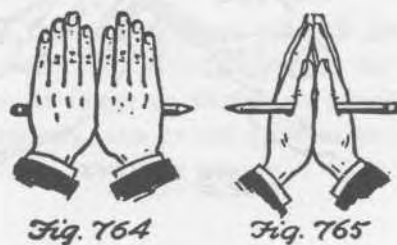

#### COMMENTS AND ADDITIONS

Source:

Date:

## COMMENTS AND ADDITIONS

Source:

Date:



Fig. 766

LEFT THUMB IN FRONT. PENCIL IN CROTCH OF RIGHT THUMB. PIVOT RIGHT HAND OVER BACK OF LEFT.



Fig. 766A

TURN LEFT HAND TO BRING BOTH PALMS TOGETHER.



KEEP PENCIL BETWEEN THUMB CROTCHES.

Fig. 766B

In making these moves the pencil is gripped firmly at all times by crotch of right thumb while crotch of left thumb slides around it. Pencil rotates counterclockwise as you look down. Try bringing pencil up in this manner, then bring it down again not by reversing the same move, but by making a mirror-image of this move. In other words, the pencil rotates in a continuous counterclockwise motion as it moves up and then down. With practice the pencil can be shifted up and down, up and down, always rotating in the same direction in a continuous action that makes an effective bit of jugglery.

30. "Find the gimmick" pencil. That was what Joe Berg called the pencil when he introduced it on the magic market more than twenty years ago. It has since become a staple novelty store item in many different forms. The trick can be performed impromptu with pencil of the type shown in Fig. 767. Moisten tips of finger and thumb, pull pen-

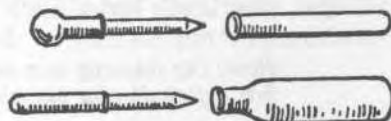

Fig. 767



cil almost out of case. By squeezing thumb and finger the rounded metal end of cap is made to shoot from the fingers like a cherry seed, snapping pencil back into the case as though pulled by invisible spring. Twist pencil back and forth each time before you make the snap, as though trying to catch it on this secret spring. Spectators are unable to "find" the gimmick.

The pencil was invented by George W. Hunter, the English magician who gave Berg permission to market it.

31. Pencil in buttonhole. Sam Loyd (the elder) claimed to have invented this puzzle and he may well have done so. Cut a groove around pencil below eraser, then fasten loop of string (Fig. 768). It can be looped quickly through a lapel buttonhole (Fig. 769). Victim is left with the difficult task of removing pencil without cutting string.



## PEPPER

1. Shake pepper into glass of water until entire surface is covered. With end of paper match, draw a cross on the surface. The pepper separates where it has been touched, leaving mark of cross on the water. No mark result when others try. A bit of ear wax on end of match does the trick.

## PHONOGRAPH

1. Weird sound effects are obtained by (a) Playing record backward (pianos sound exactly like organs!) (b) Attaching two needles to the arm so

## COMMENTS AND ADDITIONS

Source:

Date:

*A sauce dish of clear water is on the table with salt and pepper shakers. Shake salt in the water, then pepper. Salt cannot be seen but pepper sits on surface. Now put a forefinger in the water and the pepper immediately moves to the far sides of the dish. Used with many variations of patter about swim pools and beaches.*

*How: Dip fingertip into any liquid detergent just before dipping into the water.*

that one plays in a groove ahead of the other (c) Using an off-center hole that you have bored in the record.

2. If needle is clenched in front teeth and held against spinning record, the music can be heard distinctly.

3. A record can be played without needle or machine. Stick a short pencil through the hole, then spin record (on eraser end) like a top. For a "needle," use a small square of stiff paper folded diagonally and held as in Fig. 770. The music is faint but audible. (This and other stunts above are from "Gramophone Tricks," "Strand" magazine, Vol. 49, p. 358 1915).



#### PIE

1. Hold your hand over victim's piece of pie and say, "Feel that heat!" When he holds his hand over the pie, squash the pie by slapping his hand down on it. If victim knows this adolescent prank, he may try to slap your hand when you first pretend to feel the heat. Anticipate this and jerk your hand away quickly, causing him to slap his own hand on the pie.

#### PIN

1. Right hand poises pin over back of left (Fig. 771). Spectators do not know that pin has been attached to right thumb by pushing it through a small bit of surface flesh. Move pin up and down a few times then appear to slap it into back of hand. This is done by opening right hand and slapping its palm on top of left. Right thumb extends toward you, hidden from spectators by your left hand. Without moving left hand, reach underneath it, bring thumb and forefinger together once more, pretend to extract pin from center of left palm.

#### COMMENTS AND ADDITIONS

Source:

Date:



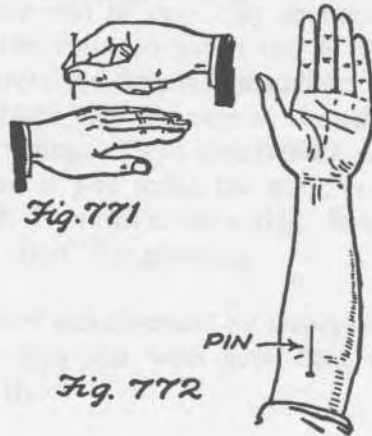

## COMMENTS AND ADDITIONS

Source:

Date:

In similar fashion you can appear to slap pin into your forehead. In this case, pin must point in opposite direction from that shown in Fig. 771. Stand with left side toward audience. Pretend to slap pin into forehead, reach behind head and appear to extract it.

2. Pin is placed in crotch of arm as in Fig. 772, pointing either direction. Arm is closed suddenly, then opened. The skin is undamaged. Looks dangerous, but actually nothing happens at all.

3. See "Annemann's Practical Mental Effects", p. 22, for Dr. Jaks' use of a hat or corsage pin for an excellent pellet switch.

## PING PONG BALL

1. A ping pong ball coated with rubber cement offers many possibilities. Pretend to balance it on tip of cane (also coated with cement), then do a walk-off with cane held horizontally, ball still sticking to the end. Jack Miller once got credit for some skillful juggling by coating a ping pong ball with cement and also applying cement to side of his middle fingertip. Holding hand as in Fig. 773, he was able to make ball apparently roll to tip of first finger, roll underneath, down crotch of thumb (as shown by arrow), then back up along the same path!



Fig. 773

Bill Nord suggests preparing ball and one side of ping pong paddle with cement. Bounce ball in air a few times with unprepared side of paddle, swat it suddenly with prepared side. Ball seems to vanish to mid-air. Show both sides of paddle by using paddle move. Produce ball on paddle by reaching behind your back or under table.

2. Ball is apparently rolled back and forth on small piece of rope held tautly (Fig. 774). Black thread is attached to each end of rope and kept a short distance from rope by the index fingers which are

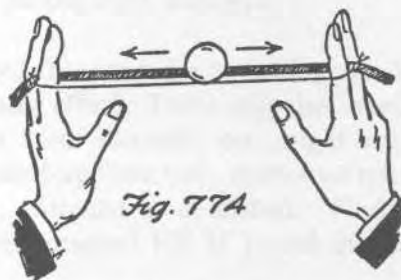

between rope and thread. When rope is tilted slightly, ball rolls along it.

3. Ball rolls mysteriously across table cloth. Accomplished by small ring of cardboard under the cloth. A thread attached to the ring runs away from you, down over far edge of table, then back toward you beneath the table. You pull thread with one hand while other hand gestures over the ball. Or thread can be operated by an assistant in various ways.

#### PLATE

1. While waiting for waiter to bring food, remark that you are hungry enough to eat the plate. Pick up plate, bite the edge. A loud cracking sound is heard. Produced by a half-dollar in same manner as in biting edge of glass (See GLASS, No. 10).

2. While someone at the table was talking excitedly George Jason liked to hand him his plate, at the same time looking him in the eye and nodding gravely. Victim usually kept on talking and holding plate for several minutes before he started to wonder why he was holding it.

3. Place four objects on a plate. Announce that you and three others will be able to take an object, but one will still be left on plate. You "take"

#### COMMENTS AND ADDITIONS

Source:

Date:

the last object by picking up plate with object on it.

4. About a dozen half-dollars are stacked neatly in center of plate. Hold plate by rim, a few inches above table. It is possible to withdraw the plate quickly to one side, allowing stack of coins to fall on table without toppling over.

5. Victim is handed a plate but does not know that bottom has been covered with soot from a candle flame. You hold unprepared plate. Tell him you intend to hypnotize him. He must look into your eyes at all times and duplicate all your actions. Rub your fingertips on bottom of plate, then rub fingers across forehead. He does the same. Rub bottom of plate again, then rub fingers on nose, and so on. Victim of course blackens his face without realizing it.

This stunt is so ancient and well known that an amusing switch can be based on it. The "victim" is in on the stunt. While your attention is distracted, he switches plates with a wink at audience. Go through usual routine and pretend to grow increasingly astonished at fact that victim's face is not becoming black. At same time you must act as if you are not aware that your own face is getting the soot.

6. Several bold methods for a quick vanish of a plate are explained by Sachs in Chapter 7 of his "Sleight of Hand". In the standing method, left hand is held behind back. Right makes tossing motion, leaving plate in left hand, then left immediately produces it from inside someone's coat. Seated methods involve clipping plate between leg and thigh, or leaving it on the chair. See Sachs for details.

7. Innumerable effects may be devised in which one or more plates are turned upside down, then small balls of paper, bread, or sponge (or small objects such as sugar cubes, dice, etc.) are made to vanish, reappear, transpose, etc., as in cup and ball routines. An excellent impromptu routine using two plates and four small bread balls is described by Sachs ("Sleight of Hand", Chapter 7) and worth careful study.

## COMMENTS AND ADDITIONS

Source:

Date:





8. Tom Sellers (in "Tricks that Work") gives his method of using a plate for the exchange of two small objects. Duplicate object is fastened to center of plate with wax, and plate is turned upside down on a coffee cup before starting trick. The object to be switched is apparently placed on the plate after left hand has turned the plate upright. However, as plate is lifted from cup by left hand, right hand drops object into cup. Right hand immediately is placed on duplicate object as left hand turns plate upright, leaving plate on top of cup with object resting on it. The plate of course hides the switch from audience.

Sellers used this move for switching match boxes in a divination effect. There may be many uses for the move. For example, one might attach to the plate a balled-up flash bill. Borrowed bill is formed into ball, switched as described. Flash bill is ignited, then original bill is found inside the cup.

9. Grinding the knife. Although old, this is an amusing table diversion when properly performed. It was a favorite of Nate Leipzig, whose handling is described so well in "The New Phoenix", No. 324 (March, 1955) that there is no need to repeat it here. The effect is that of spinning a plate on the knees, then using it like a grindstone for sharpening a table knife. "The New Phoenix" description is the only correct one I have seen of this striking illusion. Most descriptions fail to explain how the thumb of one hand is used to keep plate from toppling over as it is jiggled by the legs.

The trick is a favorite of Charlie Miller. He first tests the knife blade with his thumb, shakes his head, says it needs sharpening. The first few attempts to give plate a gentle spin fail, but finally you get going. The knife is moved forward and back, the blade hitting against the bouncing plate and making the grinding sound. Charlie then stops the plate by grabbing it suddenly with both hands.

10. Plate spinning. C. Lang Neil, "Modern Conjuror", p. 321, had a chapter on the art of spinning plates on the table. The ancient Chinese stage act of plate spinning on pliable bamboo sticks uses gimmicked plates, as explained by Percy Abbott in "The New Tops", September, 1964, p. 20.

## COMMENTS AND ADDITIONS

Source:

Date:

## PLATE, PAPER

1. Performer insists on absolute quiet while he tries to juggle three plates. He keeps dropping and breaking plates, then picking up new plates and trying again. He grows more and more furious at audience for laughing at him, until finally, in a burst of uncontrolled anger, he starts throwing plates at the audience. These of course are harmless paper plates, but for a few seconds the spectators are understandably terrified.

## POKER CHIPS

1. One of the oldest and prettiest of coin flourishes, though better known in the gambling fraternity than to magicians, is a one-handed faro shuffle of a stack of half dollars or poker chips. As far as I know, this beautiful move has never been fully described in print (if it has, I'd be grateful to any reader for the reference).

It is to Walter O. Taylor, of Tulsa, Okla., that I am indebted for exact details on the flourish. Taylor first learned the move thirty years ago, and was doing it with half dollars for several years until he saw a movie with a gambling scene in which one of the card players executed the shuffle with blue and white poker chips. The changing color pattern fascinated him, and it wasn't long until he was doing the shuffle simultaneously with both hands, and with incredible rapidity. Eighteen years as room clerk at Tulsa's Albany Hotel gave him plenty of opportunity for practice, so you can be assured Taylor's instructions are backed by plenty of experience.

Plastic chips with smooth sides are best to use, Taylor says, although cardboard chips work almost as well. The move can also be executed with coins of any size (Taylor can do it with dimes), but half dollars are less exasperating to handle. It's best to learn the shuffle first with a stack of eight chips, then increase the number until you can handle the full sixteen. Mastering the move probably takes more practice and patience than learning say, the coin roll, and there'll be times you'll feel like throwing the chips across the room. But if you like flourishes, the effort will be well spent.

## COMMENTS AND ADDITIONS

Source:

Date:

## COMMENTS AND ADDITIONS

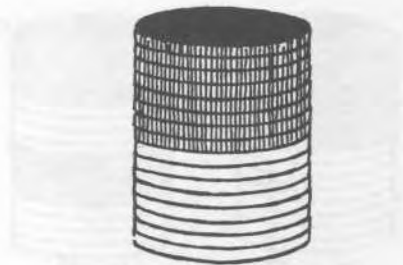

Fig. 1

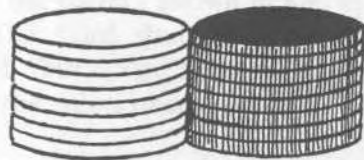

Fig. 2

The shuffle begins with a stack of 16 chips, 8 white ones on the bottom and 8 blues on top (Fig. 1). Only the right hand is used throughout.

Cut the stack in half, placing the blue chips to the right of the white ones as shown in Fig. 2. The right hand takes a spider-like grip on the chips. Fig. 3 shows the grip from front and back views, and Fig. 4, looking from above, indicates which fingers go where. The thumb and index finger press against the left stack at points A and B, the third and fourth fingers at points C and D on the right stack. The middle finger touches both stacks at the point marked E.

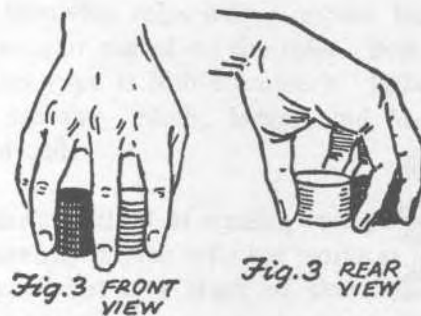

Fig. 3 FRONT VIEW

Fig. 3 REAR VIEW

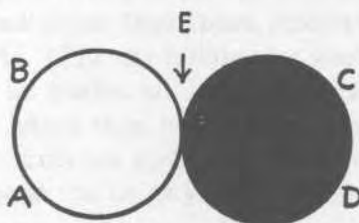

Fig. 4

Source:

Date:



Fig. 5

The tip of the middle finger raises the inner corners of the stacks slightly, tilting them to the position of Fig. 5. The middle finger now permits a few lower chips to fall back to the table. An inward pressure by the fingers on both sides will cause these few lower chips to begin dovetailing. As soon as this occurs, the entire hand rises slowly. As the hand rises, the fingers continue pressing inward, but the pressure is very slight. If properly done, the dovetailing will move upward through the chips as the hand rises.

The middle finger plays no part at all in this process except to act as guide in case the chips get out of line. The entire flourish can, in fact, be performed without the aid of the middle finger at all. It's chief function is the lift at the beginning, which greatly facilitates starting the dovetailing process.

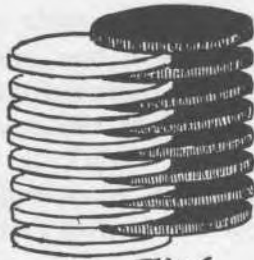

Fig. 6

After the dovetailing is completed, the chips will appear as in Fig. 6. The stacks overlap by about half the diameter of a chip. The fingers immediately push the chips together into a single stack. The colors will be alternating as pictured in Fig. 7.

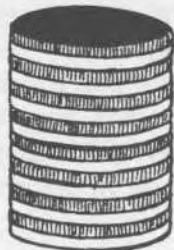

Fig. 7

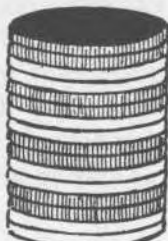

Fig. 8

## COMMENTS AND ADDITIONS

Source:

Date:

## COMMENTS AND ADDITIONS

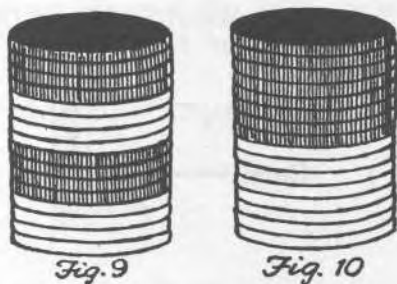

Fig. 9

Fig. 10

The stack is cut again and the move repeated. This produces the pattern shown in Fig. 8, the colors in pairs. The third shuffle forms the colors into groups of four (Fig. 9) and the fourth shuffle separates the colors once more (Fig. 10).

The final pattern may be exactly the same as the original one, or the colors may be reversed, with the blue on bottom instead of white. The outcome depends on the manner in which the first shuffle is made. If the first chip allowed to fall to the table is white, then white will be the bottom color after the fourth shuffle. Otherwise, the lower color will be blue. With practice it is possible, of course, to control the first shuffle so that whichever color you desire is permitted to fall first.

You may find it more convenient to leave one chip on the table when the middle finger raises the edges of the two stacks, rather than lift both of the bottom chips, then allow one to fall ahead of the other.

2. A number of mathematical effects have been published involving chips with numbers, letters, or designs drawn or pasted on the sides. Best known trick of this type is Bob Hummer's "Poker Chip Trick." See my "Math, Magic, and Mystery", 1956, for details.

3. A dealer's method of stealing two poker chips while apparently paying off a bet works as follows: Suppose your bet is a stack of seven chips and dealer is supposed to pay you same amount. He picks up a stack larger than yours, pushes it against your stack (Fig. 775). By holding his stack slightly above table, he pushes six of your chips off the bottom chip, which then becomes bottom chip of his stack. He cuts his stack even with yours, and unless you count the chips you do not realize that

Source:

Date:



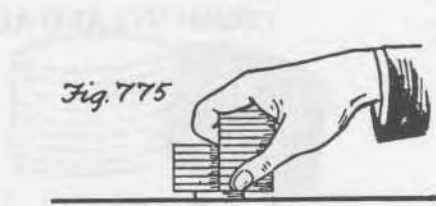

two are missing. Move can be undetectable.

4. Stand facing a wall. Someone hands you a chip which you take behind back in a closed fist. Turn to face audience. A tiny piece of palmed wax is attached to chip. Stick it on wall behind you. Pretend to concentrate, then turn and face wall, keeping both hands behind back, one closed in fist as though still holding chip. Name the color of chip (which of course you can see stuck on wall). Spin around again to ask if you are right, retrieve chip from wall behind your back, remove wax, and return chip.

#### POOL TABLE

An English book, "Fun on the Billiard Table" by "Stancliffe," is supposed to contain 75 easy stunts, but I have not seen a copy. Most of the following tricks are from a chapter on pool table stunts in A. Frederick Collin's "Mirth and Mystery", 1931. Other references include Newman Mord, "Tricks on the Billiard Table", and Fred Herrmann, "Tricks and Games on the Pool Table" (a Dover 1967 reprint of a 1902 book, "Fun on the Pool Table").

1. Problem: Place tip of finger on ball and by pressing down, cause ball to shoot forward the length of table. Secret: Saliva on tip of finger.
2. Problem: Hit ball A (Fig. 776) and send ball C into pocket. Ball B must not touch either of other two balls. Secret: Invert a glass over B.

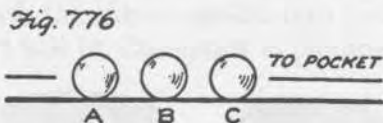

3. Bet someone he can't turn around three times, pick up cue, make an easy shot. While he is turning, put saliva on tip of his cue.
4. If ball is spun on table, impossible to bring it to a dead stop by suddenly pressing tip of finger on it.

#### COMMENTS AND ADDITIONS

Source:

Date:

5. Arrange balls as in Fig. 777. Appear to smack B with palm of right hand, causing it to travel

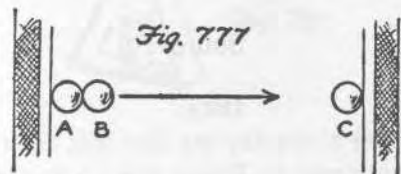

across table and strike C. No one else can do it. Secret: Instead of hitting B with palm, hit A with thumb.



6. Place a coin on edge against side of cushion (Fig. 778). Problem: Knock it over with cue ball. Secret: Aim ball slightly beyond coin so it strikes coin's farthest edge.

7. Wooden match stands upright between two balls (Fig. 779). Problem: Knock over match without moving one of the balls. Secret: Hit one of the balls with inside English.

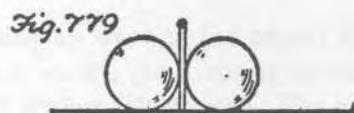

8. Coin rests on top of ball and chalk ring is drawn around ball (Fig. 780). Problem: Hit ball and knock coin out of ring. Secret: Either hit ball so hard that coin lands on cue ball and is carried away, or hit it so gently that it rolls over slowly, the coin riding with it.



9. To put ball B in hat (Fig. 781), use strong reverse English on cue ball.

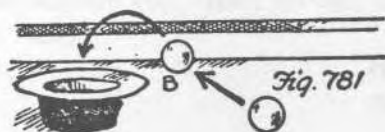

## COMMENTS AND ADDITIONS

Source:

Date:

10. Coin is placed flat on edge of cushion (Fig. 782). Aim cue ball as shown. It will strike cushion, flip coin into glass.

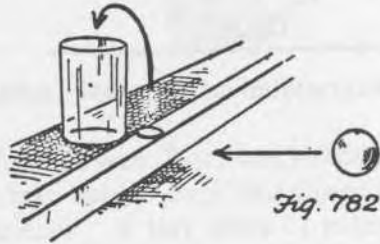

11. Glass is placed on its side between ball and pocket (Fig. 783). To put ball in pocket, simply send it into glass. Glass somersaults over and ball continues in a straight line towards the pocket.



12. Arrange balls and cues as in Fig. 784. Send cue ball as shown. Cue A will knock ball B into pocket. Cue ball continues, sending other ball into other pocket.

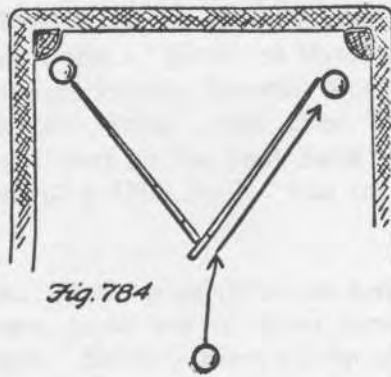

13. Balance two balls on match box covers (Fig. 785). Drive ball toward pocket. Match covers will be knocked aside. Cue ball goes in pocket and other two balls drop to table to occupy spots where the match covers formerly stood.



14. Hang ball rack on cue (Fig. 786) and place glass of water on lower rim as shown. Rack can be spun around cue without spilling water.

## COMMENTS AND ADDITIONS

Source:

Date:

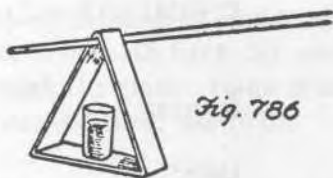

Fig. 786

15. If two cues and ball are placed as in Fig. 787, ball will appear to roll uphill in direction shown (actually, its center of gravity goes down).

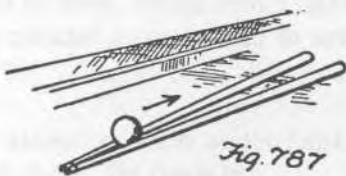

Fig. 787

### PULSE

1. Stopping pulse at will. A small rubber ball or tightly knotted handkerchief under armpit does the trick. Spectator feels your pulse. When you wish to stop it, press arm against ball. This presses artery in armpit and cuts off pulse as long as pressure is applied.

### PURSE

1. Extracting an unexpected object of some sort (cigar, man's wallet, etc.) from a borrowed ladies' pocketbook always gets a laugh. The object can be carried in sleeve and allowed to drop into purse as you reach inside. Loading one object while you remove another is a useful stratagem. For example, borrow purse and pretend to take from it a palmed half dollar that you have previously vanished. As you take out coin, load into the purse a larger object (piece of silverware, imitation egg, etc.) that is either palmed or in your sleeve. Close the pocketbook and return it. After some time has elapsed, you borrow purse again, show hands unmistakably empty, then extract the large object.

### RADISH

1. Cut radish in half. Make end slightly concave. It will act as suction cup strong enough to support a plate (Fig. 788).

### COMMENTS AND ADDITIONS

Source:

Date:



Fig. 788

Fig. 788



## RICE

1. The Hindu Trick in which a bowl of rice is suspended from a knife blade plunged into the rice, works exactly as Major L. H. Branson describes it in his "Indian Conjuring", 1922. A round, squat bowl, much larger at the middle than the neck, works best but is not essential. The trick can be done with any bowl, bottle, jar, or vase that has an opening smaller in circumference than the sides, yet large enough to accommodate the blade of, say, a table knife.

Fill the jar completely with uncooked rice. Pack down the grains by pushing with the thumbs, adding more rice if necessary to keep jar filled. Start plunging blade into the rice with short quick jabs only a few inches deep. You may have to keep doing this for some twenty or thirty times, as the jabs seem to settle and pack the grains.

Then try plunging the knife down as far as you can. If it does not bind, continue with the short jabs. Eventually, a hard jab will cause knife to stick so firmly that when you lift it by the handle, the jar is lifted with it and may even be swung from side to side.

Finish by giving knife a slight, imperceptible twist, then asking spectator to withdraw it. It will now lift out easily, making the effect mysterious indeed. Experiment with different brands of rice, as some seem to work better than others.

## RING

Unless otherwise specified, the word "ring" in all that follows will refer to an ordinary finger ring. Tricks that require stage presentation, special apparatus, or elaborate preparation (e.g., ring in egg, catching rings on end of wand, Linking Rings, etc.) are of course not included.

## COMMENTS AND ADDITIONS

Source:

Date:



1. Most common method of vanishing borrowed ring is to place it beneath hank, let spectator feel or hold it through the cloth. Hank is later shaken open and ring has vanished. Methods:

A. Hank is prepared with duplicate ring in corner pocket, or is a double hank with ring inside. Spectator holds duplicate while you steal original.

B. Similar to above except unprepared hank is used. A corner of hank, rolled into a tight cylinder and bent into circular form, is used to simulate the ring.

C. Stooge is asked to reach under hank to make sure ring is still there. He steals it.

D. Duplicate ring is attached to center of hank with short piece of thread. Spectator holds this ring through cloth, drops it into empty glass. Lift away hank by seizing its center. A good table presentation is to hold another glass (or hat) beneath table. When spectator drops ring he is holding, allow original ring to fall into glass you are holding, as though ring penetrated table.

2. Flying Ring. Borrowed ring is held in left fingers. Ask spectator to cover it with hank. As you direct him to place a rubber band around left wrist, to seal hank around hand, right hand makes circular gesture around left wrist. As it passes beneath left hand, ring is dropped into it (see COIN, No. 69 for details of this move). Right hand goes into trousers pocket (or it can be covered with another hank and band). Command ring to go from hand to hand. Spectator removes hank from your left hand, finds ring gone. Take right hand from pocket with ring or finger.

An excellent version using duplicate wedding ring, and the finger switch described below (No. 7) is given by Eddie Clever in "My Best," p. 224.

Another effective version, using duplicate ring and easily prepared sleeve pull (made with rubber band and safety pin) will be found in "Conjuring Trix", by Hans Trixer, 1955.

Jean Hugard's "Modern Magic Manual" gives an interesting method, not requiring a duplicate. A

## COMMENTS AND ADDITIONS

Source:

Date:

silk hank must be used. As left hand (holding ring) is covered, first and second fingers extend upward and clip center of cloth (to keep it from sliding later). Ring is extended to your right by left thumb and third finger. As right hand adjusts hank, its thumb and third finger grip the ring through the cloth by bringing tips of thumb and finger together inside the ring. Right hand moves away, sliding ring along underside of cloth until it comes free at the edge. Thus right hand is able to steal ring without going below hank.

3. Borrowed ring is vanished by any of above methods, then discovered in some unlikely spot. Traditional stage versions (finding ring in egg, potato, apple, loaf of bread, tied around rabbit's neck, in nest of boxes, etc.) do not lend themselves to impromptu work. Suggestions: tie a knot in another hank, later find ring in knot (see COIN, No. 72); discover ring on finger of your own hand after shaking open hank to show it has vanished.

4. Coin, ring, and hank. Half dollar is placed in center of silk hank. All four corners go through ring. Open hank flat and let two spectators hold opposite corners. Coin is of course firmly trapped by the ring in center of hank. Cover with another hank or piece of paper. It is possible to remove the coin (under cover of other hank) by tightly rolling one edge of silk until it reaches ring. Slip out ring and unroll.

5. Stewart Judah's beautiful version of above effect, making a real trick out of it rather than a puzzle, will be found on p. 55 of Bruce Elliott's "The Best in Magic", 1956. The trick makes use of the coin penetration move (COIN, No. 75). Judah often places a rubber band around the hank in addition to the ring. Instead of loading palmed coin into the well as ring is handed forward, he first removes the band, places it on the outstretched hank, dropping coin into well as he does this. The hand then goes beneath hank again to remove ring. When hank is pulled flat, coin is found resting on the center as it should be. Consult Elliott's book for details.

6. This penetration effect, described in many old books, uses a small piece of wire bent into shape of ring. Ring is apparently placed under hank, but wire fake is substituted. Spectator holds hank

## COMMENTS AND ADDITIONS

Source:

Date:

firmly in his fist, a few inches below what appears to be the ring. Under cover of another hank (or hat, piece of paper, or simply the hands), the wire is opened and pushed through the cloth. (Rubbing the spot a bit will remove the tiny hole.) The borrowed ring (which has been kept palmed) is then exhibited, apparently having been pulled through the hank. The classic description of this effect is in Sach's "Sleight of Hand" where it is used as a vanish instead of a penetration.

7. Borrowed ring rises and falls mysteriously on wand or pencil held vertically by magician. A thread attached to slit in eraser and running to button of coat does the trick. Finish by making ring jump into the air, catching it with other hand. Thread pulls out of eraser as you hand pencil forward for inspection.

For some excellent new angles and presentation features on this old-timer, see Paul Curry, "Magician's Magic", 1965, pages 95-100.

8. Finger switch. One of oldest and best methods of switching borrowed ring for duplicate. Duplicate is on first finger, but this finger is bent down out of sight and middle finger is extended upward. Spectator places his ring on tip of your middle finger. In walking back to spot where you are performing, simply exchange fingers. Slide duplicate from first finger. Sachs credits this switch to Devant.

9. Wand or pencil switch. Ask spectator to put his ring on a pencil you are holding in right hand. Already on the pencil, but concealed in the hand, is duplicate. Take pencil in left hand, the hand going over borrowed ring and exposing duplicate. As Sachs points out, both this method and the above can also be used for exchanging several borrowed rings at once.

10. Gags: to put yourself through a ring, write "yourself" on piece of paper and push it through. To poke a spectator's head (or any large object) through a ring, put your finger through the ring and give his head a poke.

#### "On and Off" Tricks

Most ring tricks are those that seem to violate a

#### COMMENTS AND ADDITIONS

Source:

Date:



principle of topology—namely, that two closed curves cannot be linked or unlinked without breaking apart one of the curves. The material to follow will be divided into four categories: finger, hank, stick, and string. In many cases the moves are so complicated that we shall be forced to give only a reference to where a full description of the trick may be found.

### Finger

11. This old-timer requires duplicate rings, one faked, but the fake is easily prepared. Buy two dime store rings with large settings. Cut one ring as in Fig. 789. This half-ring is placed on base of left third finger, or palm side of hand so it is not visible when back of hand is seen. Solid ring goes on same finger, with setting on back of hand.

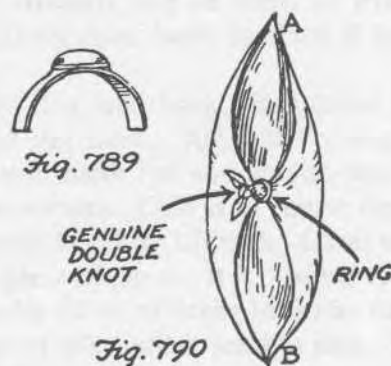

Hold up left hand, its back to audience, and remove solid ring. Let audience examine. Take it back in right hand and pretend to slip it back on left finger, actually retaining it in a finger palm. At same time, turn palm of left hand toward audience so they see the fake. Right hand now grasps fake and holds it while left hand rotates, bringing half-ring to back of hand.

Extend left hand, palm down, asking spectator to seize tip of ring finger. Cover hand with hank. Reach beneath, leave solid ring on back of left hand (or slip it on a free finger). Remove half-ring from finger and carry it away in right hand as you take off the hank. Left third finger is clean, and ring on back of hand may be picked up immediately by spectator and examined.

There are many slightly different handlings of this classic, one of which will be found in "Greater

### COMMENTS AND ADDITIONS

Source:

Date:



Magic". The trick was a favorite of Alexander Herrmann who reportedly placed the fake on spectator's finger then removed it using only his hands for cover.

Instead of a half-ring, you can also use a ring that has simply been cut at one point. This ring can be freely shown from all sides after it is placed on left finger. It is removed by forcing it apart at the break; easily done with cheap rings.

### Handkerchiefs

12. Larsen and Wright's "Ghost Ring." Hank is prepared beforehand as in Fig. 790. Ends A and B are tied in a false double knot (See HANDKERCHIEF, Nos. 37-41), while the ring and genuine knot remain concealed in folds of hank. Hank is then placed inside a hat. In doing this, pull apart fake knot. Duplicate ring is exhibited and also placed in hat, actually going under sweat band. Turn hat upside down. Hank falls out, ends still tied, and ring now on the hank. See "Tarbell", Vol. 3, p. 306 for details.

13. Nelson Hahne's "Ring of Thoth". Performer succeeds in putting a ring on a hank that is held at both ends by spectator. Duplicate ring is used, but moves are subtle and well planned. See "My Best", p. 167.

14. Hans Trixer's method of achieving same effect as above is described in his "Conju-ring Trix", p. 29. No duplicate is used, which adds to the effect in some respects, detracts in others.

15. Fitch Cheney's release. Two hanks are tied together at their centers with a square knot. Borrowed ring is slipped on the hanks, and a knot tied to secure it. While spectators hold ends of hanks, performer releases both ring and knots. No duplicate ring used. See "Magic from M.U.M.", 1954, edited by Milbourne Christopher, for this ingenious topological trick.

### Stick

By "stick" is meant any rod-like object—wand, pencil, fountain pen, cane, spoon, swizzle stick, etc.—on which a finger ring can be placed. The trick is to put the ring on the stick or take it off while a spectator holds the ends. Readers inter-

### COMMENTS AND ADDITIONS

Source:

Date:





ested in this effect should not fail to consult Dai Vernon's "The Ring on the Wand", 1950, in "Stars of Magic", Series 6, No. 1, in which four excellent methods are clearly explained and illustrated.

16. It is often necessary in the tricks to follow to place secretly a palmed ring on stick during act of seizing stick. If pencil or fountain pen is used, this may be done as hand reaches for it in breast pocket. If longer stick is used, it may be held under one arm so that both hands are free until stick is brought into use.

In taking stick from arm, ring is easily loaded on it by carrying ring in a conventional palm (center of hand), or in the finger palm shown in Fig. 791.



Frank Taylor has pointed out (Bruce Elliott, "The Best in Magic", p. 73) that the ring is easily brought to this palm by first carrying it on tip of thumb.

Another useful palm for loading ring on stick is shown in Fig. 792. Sol Stone calls my attention to fact that ring can be brought to this finger clip palm while apparently placing ring in left hand. Begin with ring lying flat on tip of first finger. As you pretend to drop it in left hand, right thumb aids in bringing it to clip position.

17. Borrowed ring is placed on stick, spectator holds ends. Under cover of hank, ring is removed. Method: a half-ring is sewn to one corner of hank. This half-ring goes over stick. Under cover of the cloth, left hand slides ring to left. Ask spectator to feel half-ring on stick with his right hand. As he

## COMMENTS AND ADDITIONS

Source:

Date:

does this, your left hand slides ring off left end of stick. Finish as desired.

18. Spectator holds ends of stick and under cover of hank you place borrowed ring on stick. In this case, duplicate ring is sewn to corner of hank or concealed inside a double hank. Place ring under hank, but give duplicate to spectator to hold through the cloth. While he holds duplicate, you retain your grip on it, keeping borrowed ring in a finger palm. Other hand pushes stick under hank, passing it through borrowed ring. Spectator lets go of duplicate to seize ends of stick. Whip hank free, causing borrowed ring to spin on stick. (C. Lang Neil, "The Modern Conjuror", 1902, p. 273.)

Sachs ("Sleight of Hand", Ch. 3) gives this procedure. Place borrowed ring under hank and allow spectator to hold duplicate through cloth as before. Your hands come free of hank with ring palmed. Load ring on stick (See No. 16 above) and allow two other spectators to hold the ends while your hand remains at center of stick concealing ring. Drape the hank (still held by first spectator) over stick and finish as before.

19. Ring is apparently placed in center of hank and held through the cloth. Actually it is brought outside of hank by the familiar coin-through-hank move (COIN, No. 75), from which position it is secretly loaded on stick. For details of two different handlings, see Jack Olten's version (HMM, Nov., 1947) and Bill Simon's well-planned moves in "Sleightly Sensational", 1954.

20. Ring is held in left hand, covered with hank, and rubber band placed around hank and wrist. In doing this, ring is stolen by right hand (see No. 2 above). Right hand takes stick from under left arm, secretly loading ring, then offers ends of stick to spectator. Left hand (still covered with hank and presumably holding ring) grasps center of stick as right hand moves away. When left hand is lifted, ring is on stick. See Johnny Platt's description, "The Sphinx", July, 1946.

21. Stick is under left arm. Hold ring in left hand. As you cover it with hank, right fingers clip ring at edge of hank. As you draw hank toward you to bring center of cloth over left fingers, the clipped

## COMMENTS AND ADDITIONS

Source:

Date:

ring is brought to end of stick where it is easily loaded on stick and left there. Right hand gestures spectator forward, showing hand to be empty, then gives him stick to hold.

A subtle variation of this procedure, using a different move for stealing ring, was worked out by Paquette and may be found in Bruce Elliott's "The Best in Magic", p. 68.

22. Ring is held by right hand and covered with hank. Under cover of cloth, place ring on tip of thumb. Apparently seize ring through cloth with left hand. Right hand emerges from hank with ring concealed on thumb. As you stroke hank downward, left thumb clips ring in back of hank. Right hand takes stick, placing it behind hank and through the ring. Or if you prefer, ring can remain on right thumb while you pretend to seize ring through cloth with both hands, then roll hank into a tight ball with ring apparently inside. Ball is held in left hand while right takes stick from under left arm, loading ring on it. Spectator holds ends of stick. Tap center of stick with hank ball and reveal ring on stick.

23. A bit of wax on center of stick enables you to stick ring momentarily to underside of stick—a useful stratagem in many ring and stick effects. For example, in No. 17 you can carry ring beneath hank and attach it to stick. Both hands now come free of hank under some pretext, and the fact that hands are empty and ring does not drop to floor creates impression it is still on stick. If fountain pen or mechanical pencil is used, the clip may take the place of wax. See John Derris' "Monte Cristo Ring," in "Come a Little Closer", 1953, for an ingenious ring and stick effect making a bold use of the wax principle.

24. A cheap dime store ring is cut so that by forcing it open it can be placed on a stick or removed while ends are held. Duplicate ring is unprepared. Many handlings suggest themselves. For instance, unprepared ring is examined, switched for cut ring which is placed on stick. Under cover of hank, force it off stick then switch again for unprepared ring to be given for examination. In similar fashion, cut ring can be placed on stick while ends are held, switched for other ring after you slide it off stick.

## COMMENTS AND ADDITIONS

Source:

Date:

There are innumerable possibilities here for subtle handlings.

25. The Adams switch. Left hand holds stick by center, concealing a ring on stick. Borrow a ring as much like duplicate as possible. To make sure it will fit over stick, hold stick vertically and drop ring over the end, allowing it to slide down into left fist. After a moment of hesitation, left fist allows duplicate to drop off lower end of stick into right hand. Since audience sees this ring only while in motion, it does not matter if rings are not exactly alike.

Left hand now extends stick toward spectator who holds the ends. Finish as desired. For example, you can give duplicate ring to a spectator (not the owner of ring, of course) to hold while you drape a hank over the stick and remove left hand. Take back ring, apparently place it on stick under cover of hank. T. Nelson Downs, "Art of Magic", 1909, credits this ring switch to one Elbert Adams.

The switch can also be made with a spoon. Duplicate ring is palmed. Slide borrowed ring on handle of spoon, to show it will go on spoon, then left hand closes around ring and allows duplicate to drop out of fist as though ring is being allowed to slide off end of spoon. Borrowed ring, of course, remains on spoon for a penetration effect after a spectator takes both ends.

26. An effective club or stage effect, using a stooge, is as follows: Borrow a ring, switching it on the stick as explained above or by any other method. Stooge is given stick to hold. He conceals borrowed ring in one of his hands. You stand several feet away and pretend to toss ring you are holding toward the stick, actually palming it. At same instant, stooge snaps ring to center of stick with his thumb. If a cane that tapers toward one end is used, ring can be shot from the hand with considerable force. It will travel only so far, then stick suddenly, giving effect of a sudden appearance on center of stick.

27. Jack Miller's ring on stick, using duplicate ring, will be found in HMM, Dec., 1950. Ring is apparently placed on stick while ends are held and without use of hank. The moves are curious and deceptive.

## COMMENTS AND ADDITIONS

Source:

Date:



28. The following effect, with sucker follow up, is from Sachs "Sleight of Hand", Ch. 3. Hold stick in left hand and slide ring on it with right. Show ring on stick, then let it slide off again into right hand. Repeat, this time merely scraping ring along outside of stick. Retain grasp on center of stick with right hand, the ring concealed in fingers. As you ask spectator to come forward, left hand comes momentarily below right. Allow ring to drop from right hand into left. After spectator has grasped ends, right hand leaves the stick to show ring has vanished. Left hand produces the ring. Or left hand can cover stick with hank, right hand emerges unmistakably empty, then both hands go below hank to remove the ring.

Now for the follow up. Left hand secures a duplicate ring. Repeat the previous moves, this time actually sliding borrowed ring on stick but doing it in a suspicious manner. Hold left hand below right as though clumsily catching the ring, and let audience glimpse ring in left as you appear to be trying to conceal it. "Stoutly deny that the ring is in the left hand," Sachs advises, "which however you decline to open." After a bit of argument, admit defeat and show the ring. To retrieve your reputation you now proceed to put ring back on stick. Duplicate is of course palmed, and original ring is revealed on stick where it has been all along.

For a streamlined version of this classic sucker effect, see Dai Vernon's "The Ring on the Wand," cited above.

29. In the first half of above trick, a borrowed ring is placed on stick without benefit of duplicate or handkerchief. To do this convincingly is one of the greatest challenges to the skill of an impromptu worker. I have seen Gali Gali, for example, repeat this effect several times using a different method each time and with steadily mounting audience interest. Many clever routines have been developed (one will be found in the Dai Vernon manuscript, "op. cit"), of which the following seem to me of special interest.

Tom Fitzgerald, in "My Best", p. 165, describes an interesting move for secretly getting a ring on pencil. Ring is first held flat against center of pencil with the thumb of one hand. As other hand

## COMMENTS AND ADDITIONS

Source:

Date:



covers it, thumb secretly slides ring over end of pencil.

A bold procedure is to borrow a ring, pretend to place it in left hand but actually retaining it in right. Right hand takes stick from under arm, loading ring on it. At this point, pretend to show ring in left hand to spectator nearest you. Actually, he sees nothing since you have nothing to show, but everyone else (sometimes the spectator too) assumes he saw the ring, otherwise why would you offer to show it to him?

Hans Trixer, in "Conju-ring Trix"(a booklet devoted primarily to uses for the Jardine Ellis ring and shell, but also containing a number of impromptu ring and stick effects), gives an unusual series of moves on p. 21f. Right hand holds ring while left apparently pushes stick through it. Actually, stick goes beneath ring which is then stolen by left pinkie as left hand points to the two ends of stick. Trixer also describes a move in which a ring on stick is sleeved during the gesture of handing stick forward for ends to be held.

It should be unnecessary to add that if spectator holding stick is a stooge, a borrowed ring can be placed on or removed from stick under conditions that appear miraculous. It is only necessary to work out moves by which stooge can assist you without his help being apparent to audience.

### String

So many hundreds of methods have been published for removing a ring from a string, or putting a ring on a string, that it obviously is not possible to do more here than cover a small number of representative methods. A bibliography of references alone would fill a volume.

30. The classic method of removing ring from string, while ends are held, makes use of duplicate ring. Under cover of hank, duplicate is attached to center of cord by pulling a loop through ring

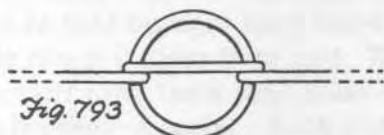

Fig. 793

### COMMENTS AND ADDITIONS

Source:

Date:



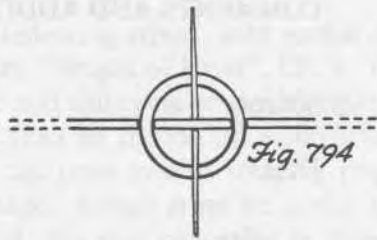

and passing it over ring to hold ring in place (Fig. 793). If preferred, a toothpick can be used to hold ring (Fig. 794). Taking this pick from your pocket gives you a chance to secure duplicate ring.

Left hand covers original ring and slides it to left. Right hand removes hank. All eyes, of course, are on duplicate ring attached to center of cord. If you wish, you may transfer hank to left hand where it helps conceal original ring. Several stratagems may now be adopted for getting original ring off string. (1) Point to loop at center of ring and ask spectator to lift it over ring while you hold left end of cord. As he does this, transfer end to right hand. Left hand places hank (and ring) in pocket. When loop is pulled over ring, it of course frees the ring. (2) Ask spectator to hold the cord a few inches on each side of ring. You take both ends to permit him to shift his grip, then come away with palmed ring. (3) Take cord from spectator and exchange the ends so each hand holds the end previously held by other hand (Jack Miller).

An excellent version, in which duplicate ring is sewn into corner of hank, will be found in Paul Curry's "Magician's Magic", p. 165.

It is possible to handle all this without the use of hank, though nothing seems to be gained by it. The trick also can be done with a borrowed wedding ring if your duplicate is a close match. In this case, cord must be held by someone other than owner of ring. After ring is removed, it is switched for original which is returned to owner.

31. Feke ring method. Best known of the gimmicked rings sold for above effect is the Bremanut. You can make your own feke by splitting a cheap ring so it can be forced open, or preparing a life saver as explained previously (LIFE SAVER, No. 2). Usual procedure is to have unprepared ring examined, switch for feke which is placed on string. Under cover of hank, feke is removed and

## COMMENTS AND ADDITIONS

Source:

Date:



palmed, original ring displayed. Or you may begin by having examined ring actually placed on cord. Under cover of hank, place feke on cord, then adopt one of the three strategems in No. 30 above for getting unprepared ring off the string. Cover with hank once more and finish in usual manner.

Frank Taylor's amusing follow-up in which your own finger ring, still on your finger, becomes mysteriously attached to cord, will be found in Bruce Elliott's "Best in Magic", p. 73.

32. Destructable ring method. In this variation you thread on the cord an object that can be torn apart silently under cover of hand—paper or cardboard ring, visiting card, gum drop, match folder, etc. The handling is obvious.

33. Ring is removed from double string looped over spectator's thumbs. This old-timer ("Secret Out", p. 225) is still one of the best of tricks to teach a child. Left forefinger is placed on both

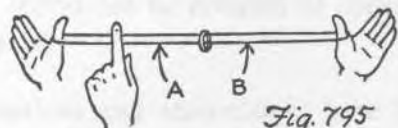

strings (Fig. 795). Right hand seizes single cord at "A," loops it over spectator's right thumb. Slide ring to left as far as it will go. Pick up single cord at "B" and loop it over same thumb. Let your left forefinger retain its hold on cord throughout these moves. Now ask him to touch the tip of each thumb to the tip of each forefinger, to make sure no loops escape from his thumbs. Hold ring in right hand and remove left finger. Ring comes free. These moves can be reversed to put ring back on, but the effect is less interesting.

34. Audley Walsh's method. No duplicate is needed for this brazen method of removing borrowed ring from single cord. Under cover of hank, fumble a bit with the ring, then slide it to left with left hand covering it. Pretend to seize ring through the cloth with right hand, actually taking only the center of cord. Shake hank gently, then ask spectator to hold his right hand below the hank to catch the ring as it drops from cord. When he does this, your left hand (with ring) holds end of cord. Nothing happens of course. Look puzzled and explain that ring must have gotten stuck. He takes

## COMMENTS AND ADDITIONS

Source:

Date:

end of cord again while you go beneath hank with both hands and pretend to be doing something. Right hand takes ring through the cloth once more, this time actually doing so. Repeat previous request that he catch ring as it falls from string. Ring drops into his hand.

35. Use duplicate rings of fairly weighty variety. Thread one on cord and place cord flat on table-top or rug and cover ring with hank. Under cover of cloth, attach duplicate ring to center of cord as in Fig. 793, moving original ring to left edge of hank.

Remove your hands and call attention to fact that both ends of cord have remained visible at all times. Fold back hank to left, exposing duplicate at center of string, the other ring remaining concealed under double fold of cloth. Seize the cord with both hands close to each side of ring and lift it from table. Weight of other ring keeps it beneath hank as cord slides free of hank. Give ends to spectator to hold. Pocket the hank (and ring) then proceed to remove ring from cord. If done on hard table top, keep ring from "talking" by pushing a fold of cloth under it as you fold hank to left.

36. Bob Hummer's ring and cord. Borrowed ring is placed on string and both ends held by someone. Announce you intend to remove it. Under cover of hank, pass a loop through ring (Fig. 796), then hold ring as in Fig. 797. Remove hank, display-

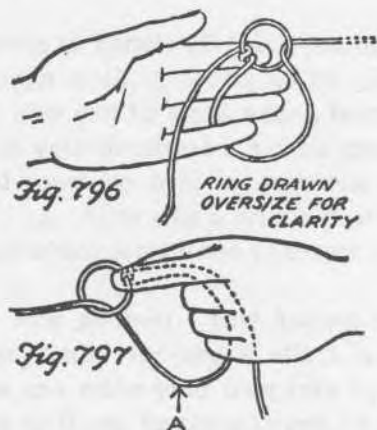

ing ring as shown, and explain that you are unable to remove ring because to do so it is necessary for one end of string to be drawn out of ring. Illustrate by seizing cord at "A" and pulling this end

## COMMENTS AND ADDITIONS

Source:

Date:



out of ring. Ring now appears free of cord, but actually is fastened to cord by two loops. "But," you continue, "putting it on the cord is much easier." Ends are held again and hank thrown over left hand and ring. When hank is removed, cord is found looped twice around ring.

An equally curious variation: instead of pulling one end out of ring (after you reach Fig. 797), thread this end through the ring once more. This appears to secure ring more firmly on the cord with a double loop, but actually the ring will now pull completely free of string. It is of course removed under cover of hank.

37. Slave Bangle. Cord is tied to each of your wrists. You display in one hand a large ring (such as a dime store plastic bracelet), turn your back for a moment. When you face audience again, ring is on cord. What you do is simply drop the ring in breast pocket and slide a duplicate off your arm (where it has been concealed under sleeve) and on to cord. Moves can be reversed of course to take ring off again.

Many variations and elaborations have been proposed. One of the best is the following effect by Rupert Slater, in "Magic Wand", Sept., 1925, p.79.

Three duplicates are used, one of which has a break that permits it to open. Your wrists are tied in front of you as before, and a spectator's wrists are similarly tied, but behind him. Let a ring be examined, take it in hand, step behind spectator, pocket the ring, attach the split ring to his cord.

This is effect No. 1. Second effect: step behind him again and attach split ring to both your cord and his. Third effect; remove feke, pocket it, slide duplicate down from your sleeve to show ring on your cord only. All may now be examined.

Another variant. Red and blue rings are on cord. White ring, of same size as other, is taken in hand. Turn back. Pocket white ring. Red and blue rings go up left arm; red, white and blue rings slide to cord from right arm.

38. Chinese coin release. The simplest form of this old effect, which wouldn't fool anyone, is to loop

## COMMENTS AND ADDITIONS

Source:

Date:







cord through one Chinese coin as in Fig. 798, then thread a dozen or more coins in a stack above it. Ends are held by someone and under cover of hank all coins are removed. Bottom coin is released simply by pulling loop down over coin. Replace coin on cord after stack has been removed. Rings of course may be used instead of Chinese coins.

39. More deceptive version of above effect uses one split ring which is genuinely threaded on cord to support the stack of unprepared rings. Last ring of stack is secretly threaded on one cord only. Under cover of hank, split ring is removed and palmed. All rings come free except last one, which remains on cord and which audience thinks is the ring originally threaded. It may of course be examined.

This trick may be performed with life savers, using a life saver prepared as explained in LIFE SAVER No. 2. A good move to use in connection with last ring of stack is as follows. Appear to put it over ends of cord, actually putting it over one only. Left hand slides it down to join the others, but palms it and immediately slides it back up cord as you seize the ends and display the stack as in Fig. 799. The stack now appears as it should. As soon as it is covered with hank, left hand carries ring back to top of stack.

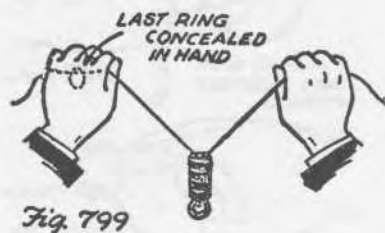

40. Two remarkable versions of the Chinese coin release will be found in Stanley Collins' "Deceptive Conceptions in Magic". The first (p. 42) uses no feke. After the coins are threaded on a short

## COMMENTS AND ADDITIONS

Source:

Date:

piece of cord the ends are tied and held as in Fig. 800. Hank is thrown over hand and a spectator holds the cord through the cloth. In covering the hand, however, entire stack is secretly turned upside-down, the knot preventing stack from dropping off. After coins are removed, threaded coin drops down into place. See book for details.

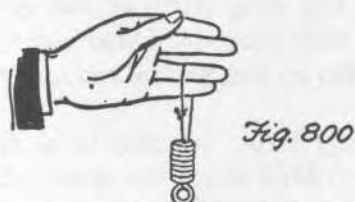

Collins' second effect (p.49) makes use of curtain rings, one of which is split. It also employs the upside-down principle. The ring first threaded on cord may be examined and marked for later identification. Split ring goes on top of stack, and because of the split, you are able to shift it later from both cords to only one. Ends of cord are tied as in previous effect and entire stack is secretly reversed as it is covered with hank. Before removing rings, you may lift cloth to show the stack, since it appears exactly as it should. After rings are released, marked ring drops down into place. Consult book for further details on this brilliantly thought-out version.

41. Scores of methods have been devised for removing a borrowed ring from rope or cord that has been secretly gimmicked in some way (e.g., cemented or waxed end, extra piece of rope, fake knots, and so on.) Tom Sellers (in "Magic Hits", 1937) was one of the first to suggest something along these lines. See also Tom Osborne's ring and rope effect, "My Best", p. 261; Edward Victor's ring release, "Methods for Miracles", No. 2, edited by Willane, 1952; and U. F. Grant's "Zella Ring," "Tarbell", Vol. 6, p. 173.

42. Gag: to take ring "off" string while ends are held, lift ring so it does not touch the cord.

43. As in ring and stick effects, many ring and cord releases can be performed under test conditions provided person holding ends of string is a stooge who secretly assists in the moves.

## COMMENTS AND ADDITIONS

Source:

Date:

44. The Sefalaljia principle. "Sefalaljia" (phonetic spelling of "cephalalgia") was the title Stewart James gave to a group of effects first published in the "Jinx", Dec. 2, 1939, later reprinted in "Anne-mann's Practical Mental Effects". The routine was worked out during a period of James' recovery from carbon monoxide poisoning when he suffered splitting headaches, hence the title. One of the effects was a method of putting a borrowed ring on rope. It was not impromptu, for it involved a small cabinet, but it introduced a new technique.

We can define this technique broadly as that of anchoring a portion of the cord in such a way that one end can be secretly drawn through the ring. The technique can be used either for putting on the ring or taking it off. However, in removing a ring one thinks immediately of drawing an end of the cord out of the ring, whereas it does not easily occur to one that the same move can be used for putting a ring on. The principle, therefore, is best adapted to putting on effects.

After Sefalaljia, a series of impromptu versions appeared. L. Vosburgh Lyons' "Fourth Dimensional Sewing" ("Jinx" No. 100, 1940) involved a ring, ribbon, and hank—the ribbon being anchored by sewing it together. This was followed by "Sefalaljia Junior" in "Phoenix", Oct. 30, 1942, and several effects in "Tarbell" Vol. 3 in which the anchoring is done by a safety pin. The spectator pins the rope or ribbon together to indicate where he wishes the penetration to take place. Ring is covered with hank and the move occurs as ribbon is pulled out from under the cloth by one end.

"Sefalaljia III," by Charles Nyquist, ran in the "Phoenix", Jan. 8, 1943 and was reprinted in "My Best". Nyquist further simplified the trick by tying a slip knot to hold the ring, and described a move that could be made without use of a hank. A similar version for the stage, using tape and large wooden ring, appeared in "Tarbell" Vol. 5, p. 288. The same trick, but using a hank again to cover the move, was contributed by Tarbell to the "Sphinx", March, 1953, and appears also in "Tarbell" Vol 6, p. 167.

In the Tarbell version, the cord is first placed in a

## COMMENTS AND ADDITIONS

Source:

Date:



straight line on the table. Borrowed ring is placed near center of cord and covered with hank, the ends of cord remaining visible at all times. Reach beneath hank, draw a loop through ring and tie the slip knot. Left hand remains under hank with thumb going through the loop. Right hand seizes right end of cord and draws it out from under hank. This automatically pulls left end through ring. Spectator now holds both ends and when he pulls, knot slips out leaving ring on cord.

A variation is as follows. After tying slip knot, both hands come out from hank. Left fingers apparently seize center of hank but actually pinch it together at a spot inside the loop of cord. Right hand then pulls out the cord as before, the pinching of fingers causing other end to be drawn through ring. Silk hank should be used.

Johnny Paul added an amusing bit of business. Before tying slip knot, slip the ring on your finger. Suddenly whip off hank and pretend to be looking for the ring which has mysteriously vanished! Of course you quickly discover it on your finger. Slip it off finger and go on with trick.

Mel Stover's version, performed on card table, uses a hat pin. After slip knot is tied, stick the pin upright in table at a spot inside the loop. You now take both hands from hank and permit spectator to seize end of cord and draw it out from under the cloth. Pocket both hank and pin. When spectator pulls ends of cord, ring is found threaded on it.

The latest variation, first described I believe in Hans Trixer's "Conju-ring Trix", 1955, p. 24, is same as Tarbell's except that the move is made in the act of removing hank and tossing it aside rather than by pulling cord out from beneath hank. A silk hank is used. The loop and knot are formed as usual. Left hand comes out and takes silk from outside, pinching it through the loop. Right hand holds right end of cord. Left hand now moves silk to the left as though simply tossing it aside. This automatically slips the end through ring. The gesture is perfectly natural and the move undetectable.

If an ordinary hank is used, the cord will not slide easily at the spot where it is pinched through the cloth. In this case it is best to keep left hand be-

## COMMENTS AND ADDITIONS

Source:

Date:



neath hank, inserting ring finger into loop. Right hand comes out to take right end. Left hand turns palm up, seizes hank from beneath and tosses it to left. In all these versions, soft, flexible cord should be used so it will slip easily and lie flat after hank has been tossed aside.

Stewart James worked out an effective version of Sefalaljia. He uses rope, ring, safety pin, man's jacket, and chair. Chair should have a back with projecting knobs or posts at the top on each side. Hang coat on back of chair, back of coat toward audience. Rope is threaded through both coat sleeves. Each end is held by a spectator. Place ring on center of rope, pull a loop through it, pin rope together with safety pin, then secretly hang the loop over left knob of chair's back. When spectator on your right pulls rope out of the sleeves, ring will be found threaded on it. Same effect, James points out, can be done with coat on coat hanger.

The hanger is either suspended from an overhead hook or held by another spectator. In this case, the loop is placed around lower end of hanger. In still another James' version, a ring from loose-leaf notebook is sewn inside the inside pocket of jacket, but near top of pocket where it is easily reached. Instead of putting loop over chair post or corner of hanger, it is clipped by this ring.

James also calls my attention to a trick marketed years ago (inventor unknown) as Robot Ring on Ribbon. Gimmick consists of a wire hook that fastens on back of your trouser belt. Display the ribbon, then pass it behind you under your coat. Someone stands in front of you and holds both ends. Place ring behind your back, draw loop of ribbon through it, hang loop on hook. Seize ring with left hand, pressing ribbon against ring but leaving right side of ribbon free to slip out. Ask spectator to release the end on your right. Bring to front in left hand. This automatically slips right end of ribbon through the ring. Let him hold this end once more. Cover ring with both hands, fumble a bit, then show that ring is now threaded on ribbon.

45. Jack Miller has worked out a routine using the

## COMMENTS AND ADDITIONS

Source:

Date:



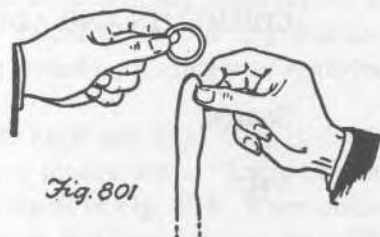

Fig. 801

Sefalalja principle in a curious way. Ring and cord are held as in Fig. 801. Center of cord is tied in a slip knot around ring. Ask spectator to cup his hands. You pull on ends of cord, knot pulls out, and ring drops into his cupped hands.

Repeat the tying of slip knot, but this time get right third finger through the loop. As you turn toward another spectator, both hands slide apart to the ends of cord. This of course slips out right end. Spectator now holds both ends. Ring is held by knot at center of cord, actually on the cord although audience does not know this. Take hank from pocket, at same time palming a duplicate ring in right hand. Cover ring on cord with hank. Hold both hands a few inches below ring but still hidden by hank. Ask him to pull on ends. As cord pulls straight, make a slight catching motion as though ring dropped into your hands. Show duplicate ring. Carry it beneath hank again, drop it down left sleeve. Whip off cloth to show that you have apparently placed ring on string.

#### Ring, string, knots

46. Ring is placed on string and single knot tied

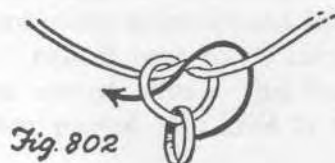

Fig. 802

over it (Fig. 802). Under cover of hank the ring is removed, knot remaining on cord. By pushing ring through knot as shown by arrow, ring will remain on cord but will be free of knot. You can then follow with one of the methods given above (Nos. 30-43). Audley Walsh's method is particularly applicable, because the knot strengthens audience's belief that ring remains at all times fastened to center of cord.

#### COMMENTS AND ADDITIONS

Source:

Date:

47. Jesse Schimmel's release. Ring is tied at center of rope. Hold it in right hand, letting both ends of rope hang down. In act of placing ring in palm of left hand, it is pushed through the knot as explained above. Left hand now covers ring and knot, but ring is actually to left of knot. Right hand pretends to take ring and pull it forward, sliding rope through left fist until left hand holds left end of rope. Actually, right hand carries only the knot forward while left fist retains ring. Your excuse for this move is that you ask spectator to hold right end of cord. After he takes it, offer left end to another person. Left hand comes away with ring palmed. Right hand still is around knot at center of rope.

Left hand (with ring) now seizes knot, freeing right hand. Right hand takes pencil from pocket. Left hand, pressing ring against knot, opens to allow you to tap ring with pencil. Push pencil through left fist, passing it also through ring. Remove left hand to show ring is on pencil and free of cord. See HMM, Jan., 1954 for further details.

48. Begin with a knot secretly tied near center of cord but kept concealed by left hand. Put ring on cord and display it as in Fig. 803, letting ring slide back and forth. Someone covers it with hank, then seizes both ends. State you will try to remove ring. Under cover of hank, open knot and slide ring into it (the reverse of move shown by arrow in Fig. 802). Remove hank, look puzzled, and say you

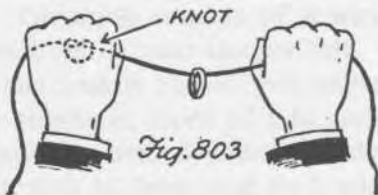

were unable to remove ring but you did manage to tie a knot around it which is even more difficult. This is a good follow-up for a put-on trick.

49. As follow-up to above, place cord flat on table, the ring attached to center with a knot. Cover with hank, letting both ends of string remain visible. State once more your intention of removing ring. Under cover of hank, slide ring out of knot and to left. Open knot several inches wide, hook third finger of right hand into it. Left hand takes left end of cord. Right hand tosses hank to

## COMMENTS AND ADDITIONS

Source:

Date:



right. This automatically removes the knot. Once more you failed to remove ring, but accomplished something equally puzzling—you removed the knot.

50. Chevalo knot and ring. Ring is tied at center of rope with a square knot. Loop one end through knot and ring as in Fig. 804. When ends are pulled, knot vanishes but ring remains on cord. Fig. 805 is a slightly different version. When ends are pulled, knot vanishes and ring drops free.

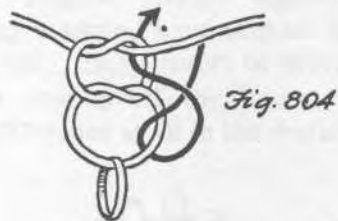

51. Ring is knotted on rope as in Fig. 802. Can you devise a way of looping one end through ring and knot so that when ends are pulled, ring drops free but a single knot remains on rope?

52. Ring is placed on cord, then ends are tied to your wrists. You turn your back for a moment. When you face audience again, there is a knot around ring. Knot is formed as follows. Pass a loop of cord under string around left wrist, give it two twists, pass it over hand, then pull it back under cord around wrist. This forms the knot. Ring is then pushed into knot as explained previously.

53. Jim Ryan's ring, rope, and stick. Ring is placed on rope and the G. W. Hunter shoelace knot is tied around it. When ends are pulled this seems to form a tight knot around ring. Someone holds both ends while another spectator holds ends of a pencil. Performer keeps one hand around ring, other hand around center of pencil. Ring transfers from rope to pencil. For the handling of this fine effect, see the "New Phoenix", No.337, 1956.

## COMMENTS AND ADDITIONS

Source:

Date:

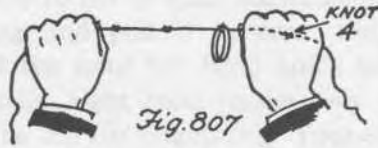
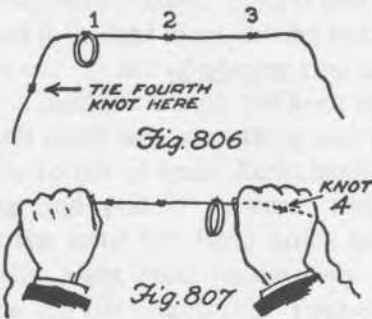

## COMMENTS AND ADDITIONS

Source:

Date:

54. This is a combination of an old principle with the effect of Ken Allen's popular Monkey Bar apparatus. Knot a borrowed ring near center of rope, then form two other knots to one side (Fig. 806). Call attention to fact that ring is attached to knot No. 1. Place rope behind your back for a moment, quickly tying a fourth knot at spot indicated by arrow. Right hand brings rope to front, the hand concealing the new knot. Display rope as in Fig. 807, calling attention to fact that ring has jumped from knot 1 to knot 3. Audience of course supposes you merely turned rope around.

Carry rope behind back again, taking the fourth knot in left hand. Left hand brings rope to front, concealing the knot, and both hands display rope to show ring has hopped back to knot 1.

Offer to do it once more. This time, as soon as rope is behind back, untie knot 3. Practice until you can do this quickly and surreptitiously. Carry rope to front and show that ring has become attached to center knot. Rope is handed to owner of ring who may examine everything and retrieve ring.

A variation: pretend to tie a regular knot for knot 3, but actually tie a slip knot. Then for the final effect you have only to pull the ends behind your back.

## ROPE

The field of rope tricks is far too vast for this series. I content myself with mentioning the two volumes of Stewart James' monumental "Encyclopedia of Rope Tricks", both published by Abbott, and the Tarbell volumes as the major references in the field.

## RUBBER BAND

1. Jumping band. Usually performed as follows: Band is placed around fist and second fingers of right hand. As right hand closes into fist, left hand aids in getting band secretly over tips of all four fingers. When the fingers are extended band jumps to third and fourth fingers. Right thumb now slips under band and as hand closes into fist again, band is brought into position for jumping back to first and second fingers. Tarbell suggests (Vol. 1, p. 134) twisting a second band around tips of fingers as in Fig. 808. This appears to prevent the other band from coming off the fingers, but actually makes no difference at all in the working.



Fig. 808

The jumping band is not ancient, having been invented by Stanley Collins and first described by him in "The Magician Monthly", Dec. 1911. Collins thinks the effect is lost if the fingers are extended to make band jump. Instead, fist should be given a quick up and down motion. Under cover of this motion the fingers are extended just enough to make band jump, then quickly closed again.

Frederick Furman, in "Thayer's Magical Bulletin, Jan., 1921, was first, I believe, to suggest using two bands of different colors. Begin with one band on first and second fingers, other band on third and fourth. Same move is used to make bands exchange places. See also Stanley Collin's "A Conjur-ing Melange", 1947, p. 115, where he explains how thumb can be used for secretly getting bands set for this double jump. A third band may be twisted around fingertips as in Fig. 808.

Tom Sellers, in "Immediate Magic", 1937, gives a version using three bands of different colors. All are on first two fingers of one hand. Other hand stretches the bands, a different fingertip hooked on each band. Spectator chooses a color. Allow all

## COMMENTS AND ADDITIONS

Source:

Date:





but that color to snap back into hand as you close it into a fist. When hand is opened, only desired band jumps across.

Bruce Elliott suggests using two bands of same color, and wrapping a strip of paper around one (Fig. 809). When the bands exchange places it gives impression that the paper hops from one band to the other.

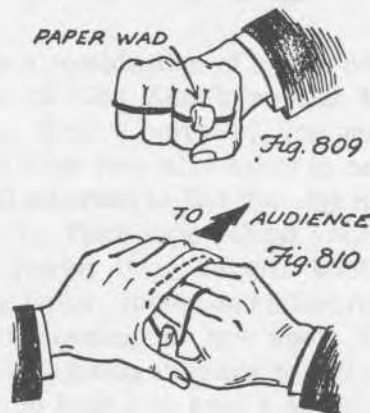

My nephew Theodore Weaver, at the age of five, worked out a handling with a single band that deserves recording. Right hand is partially opened (Fig. 810), but thumb hooks over band to restrain it from jumping. Cup left hand over right fingers to conceal the portion of band (shown by dotted line) that goes around all the fingers. When you call out "Jump!" thumb releases band and it hops across without any perceptible movements of either hand. To my mind, this is the most effective presentation of all. Can also be used for several of the variations given above.

Charlie Miller tells me that Malini would do the jumping band trick by waving his fist up and down in front of spectator's face, the band jumping from one side of hand to other. He would then repeat. This time, instead of inserting all four fingers secretly into band, only the first two fingers would go into it. Another up and down wave of the fist, in front of spectator's face, and the band flies over his head for a vanish climax.

1a. The basic move of the jumping band can also be used for a penetration effect. Put two bands around left hand: band A touches crotch of left thumb, band B is about a quarter of an inch away, below all the knuckles. Close left hand into a fist,

## COMMENTS AND ADDITIONS

Source:

Date:



secretly inserting all the fingertips under band A. Back of left fist is uppermost. Right fingers grasp band A and pulls it upward. An imperceptible opening of left fingers frees the band so that it appears to penetrate left hand as it is pulled up and "through."

2. Thumb tie. Several methods have been worked out for using rubber band to bind thumbs in a traditional thumb tie effect. They all have, to my mind, a basic weakness. Namely, laymen assume that an elastic stretches and enables you to slide out a thumb easily, even though it isn't easy. For Mel Forrester's version, the best I've seen, see "Tarbell", Volume 4, page 283.

3. Sid Lorraine was first to hit on this. Stretch band around visiting card as in Fig. 811, fold the card (Fig. 812), then cut the card through the middle. If loose scissors are used, they will cut only the card.

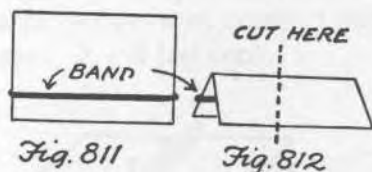

4. When wrists are tied together with rope or cord, it is easy to put a rubber band on the cord while your back is turned. Simply put it over one hand, slide it under cord around wrist, bring it up on the arm above wrist, then carry it down over hand and on to cord. Can be removed of course by reversing these moves. Harold Denhard ("Tarbell", Vol. 6, p. 164) combines this with the knot formation described under RING, No. 52. First put band on cord, form knot, then push band into knot. (Denhard suggests using rubber jar ring instead of band.)

5. Slave bangle effect (RING, No. 36) can be done easily with rubber bands. Johnnie Murray suggests having many bands of different colors on the arm. Spectator holds a set of duplicate bands, hands you any one of them, you turn your back and apparently put that band on the cord.

6. Rubber band is placed on pencil and spectator holds ends of pencil. Under cover of hank you remove band. One method: prior to showing, cut

## COMMENTS AND ADDITIONS

Source:

Date:



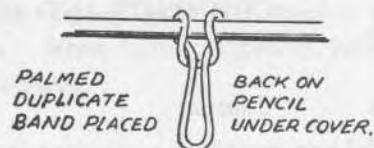
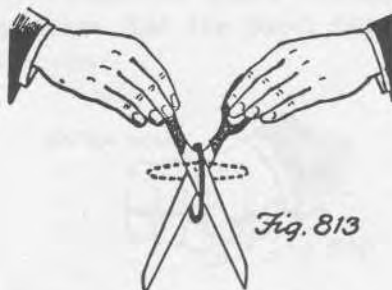
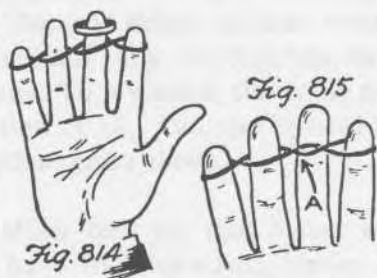

FIG. 812-A



the band almost through but not quite. It still looks okay, but under cover of hank it can be broken apart noiselessly. A palmed duplicate is placed on pencil as shown in Fig. 812-A and the broken band carried away with the hank. Of course if you do this trick with a kitchen knife or open pocket knife instead of a pencil, you can simply cut the band on the blade. Novel variation: spectator holds pair of scissors as in Fig. 813, with band around them as shown. Under cover of hank, pull band upward into crotch of blades, cut it, place duplicate band around blades as shown by dotted line, remove cut band with hank.



7. Tarbell gives this effect in his original correspondence course. Magician twists band around fingertips (Fig. 814), places a large ring on tip of middle finger as shown. A quick motion of hand causes ring to slide to base of finger, apparently penetrating band. Method: As you display ring, right hand drops to side and middle finger is slipped out of band. Finger is then pressed against twists in band and from the front the hand appears almost the same as before (Fig. 815). You can now do a back and front move, shifting middle

## COMMENTS AND ADDITIONS

Source:

Date:

finger to other side of band as you show back of hand.

To allow ring to slide to base of finger it is only necessary to move finger away from band under cover of a wave of the hand. Do back and front move once more, then allow ring to slide off the finger into left hand. John Boyko suggested that as you display ring, put tip of right thumb under elastic at point A (Fig. 815) and lift the elastic back over middle finger. The hand can now be inspected and band will be found twisted securely around each finger.

Instead of a large ring, another rubber band may be used.

8. Unlike most substances, rubber contracts when heated, expands when cooled. Conversely, when expanded it heats and when it contracts it cools. This can be proved easily by pulling an elastic taut, then immediately placing it on tongue. It will feel warm. Allow it to contract and touch it to tongue again. It will feel cool.

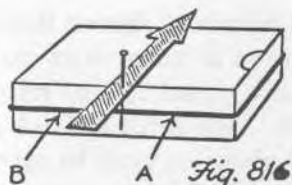

Bruce Elliott, in "Magic as a Hobby", applies this principle to a unique effect. Place band around card case as in Fig. 816. Small cardboard arrow is mounted on pin and pin pushed under band as shown. If burning cigarette is held close to band at spot A, the elastic will contract on that side, causing arrow to rotate slowly to left. Similarly, holding cigarette close to point B causes arrow to move to right. If you are smoking, you can rest your hand with cigarette casually on table near the card box. No one will realize that the heat from cigarette is causing arrow's motion. Thus the device may be used as a sex indicator, the arrow moving in one direction when a lady holds her hand over arrow, in other direction for a man's hand. Or it can be used to answer yes and no, and so on.

## COMMENTS AND ADDITIONS

Source:

Date:

A variety of rubber band "heat engines" operate on the same principle. Two ingenious such engines, designed by Roger Hayward, are explained in "Scientific American", May, 1956, p. 154f.

8a. Place the band on the index finger. Carry the other end around the middle finger and slip it back over the first finger once more. Be sure that the band is looped around the fingers exactly as shown in the third picture of Fig. 816a. Ask someone to hold the tip of your first finger.

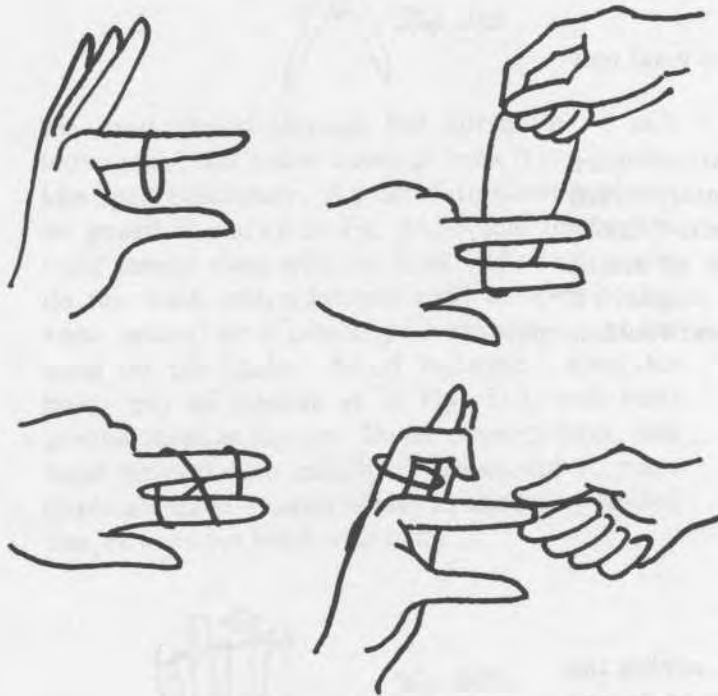

Fig. 816a

As soon as he grasps the finger, bend your middle finger. If the band has been properly placed, a portion of it will slip from the end of the middle finger. This causes the elastic to jump entirely free of the index finger and hang from the middle finger as shown in the last picture. It is difficult for others to duplicate this odd little feat. (Frederick Furman, "The Magical Bulletin", Jan. 1921.

Variant: Wrap band as shown in Fig. 816b. Let someone hold tip of index finger. When you slip middle finger out of the loops, the band shoots away so fast it seems to vanish.

## COMMENTS AND ADDITIONS

Source:

Date:



## COMMENTS AND ADDITIONS

Source:

Date:



Fig. 816b

8b. The moving ring. Break apart a thin elastic band. Slip a finger ring over it, then grasp the band, on each side of ring, between thumb and finger of each hand. Stretch the band horizontally as tight as you can, allowing ring to hang at center of band. Ends of band are hidden in your fists. Releasing pressure at one end of band will cause ring to move mysteriously toward the other hand. Thus you can make ring move left or right on command. Or explain that ring is attracted by water. When glass of water is placed near left hand, ring moves left. When someone moves glass to side of right hand, ring moves the other way.

8c. A band small enough to remain in circular form when lying on right palm is apparently dumped from right palm to left hand, which immediately closes into a fist and turns over. Right thumb secretly clips edge of band to retain it in right palm as right hand turns over. Right palm is placed on back of left fist, then fingers are raised (heel of right hand pressing against left fist) to reveal band, in circular shape, on back of left hand. A simple quickie move, but effective with laymen because they cannot imagine how a flexible rubber band can be palmed.

8d. Broken and restored band. An old idea, familiar to schoolboys, is to put the two ends of a rubber band together, hold then tightly between finger and thumb of one hand, and display the double band as if it had simply been twisted and doubled. You then pretend to break it apart at the spot where the ends meet. The following "get ready," which apparently comes from India by way of Kuda Bux, is not well known. It turns the old stunt into a beautiful close-up quickie.

Start by stretching the band between thumb and finger of right hand as shown in Fig. 816c-1. Tip

COMMENTS AND ADDITIONS

Source:

Date:

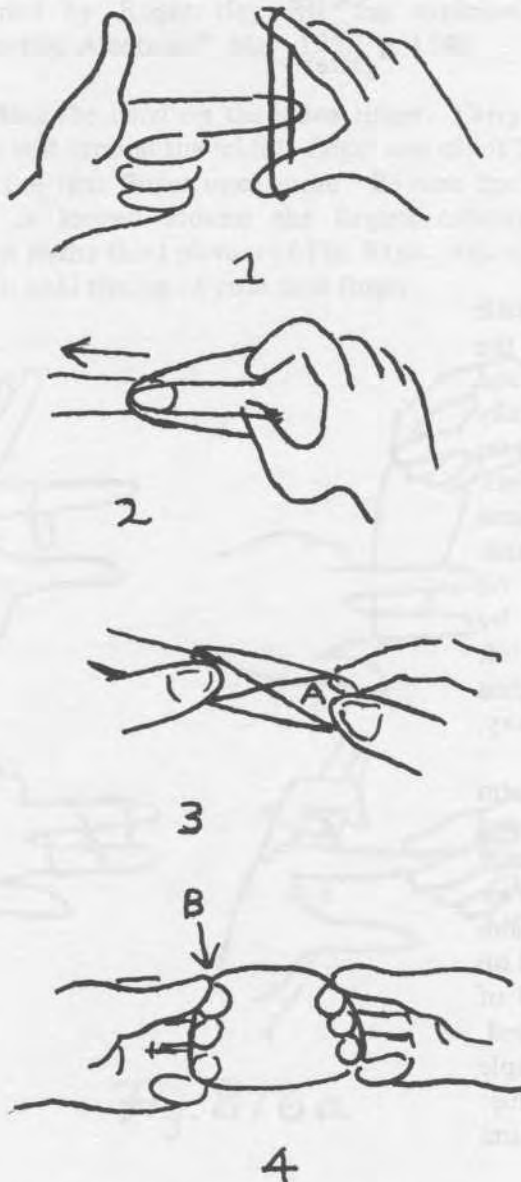

Fig. 816c

of left index finger comes up against underside of band as shown, then pulls center of band to the left as shown in 2. Tips of both thumbs simultaneously press against tips of index fingers. Right hand turns palm toward you, creating the pattern shown in 3. Tip of right middle finger enters the area marked A, followed immediately by tip of left middle finger into same area. This forces the cross-

ing point of the band leftward and under left thumb. Strong pressure of left thumb and index finger keeps the two free and touching ends of the band from coming apart.

Widen the circular space inside the doubled band by inserting tips of third fingers as shown in 4. If the band is large enough, you can also get your two little fingers into this area. You now hold what appears to be a twisted, doubled band. Actually the band's two free ends are touching at spot B where they are kept from flying apart by pressure of left thumb and finger. All these moves should be done as quickly as possible, so considerable practice is required before they can be made with the required speed and smoothness.

The rest is acting. Stretch the band open as far as you can to display it as completely as possible. Shift position of right forefinger and thumb so that they grasp the band at point B, thumbs touching. Pull on the band a few times as though trying to break it, letting spectators see a bit of the band stretch between the thumbs. Now with a sudden strong snapping and twisting motion (you must act as if this required a sudden burst of strength), pretend to break the band at point B. The pretended break should make a loud snapping sound as the thumbs and fingers of each hand move apart to show that the band has indeed been broken. Immediately push the apparently broken band into a ball, massage it with the fingers, open it up slowly to show it restored.

Instead of pretending to break the band, W. C. Dornfield has a spectator insert a knife blade into the opening so that edge of blade is at point B. As spectator lifts up on the knife, your hands snap the band apart as though it were cut by the blade.

#### Stunts and Gags

9. Dexterity test. Place band around hand as in Fig. 817. Problem: get it off without using other hand.



Fig. 817

#### COMMENTS AND ADDITIONS

Source:

Date:

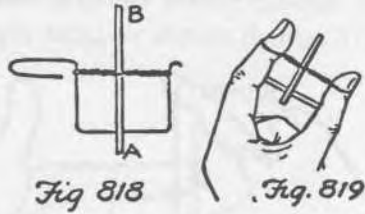

Fig. 818



Fig. 819



Fig. 820

## COMMENTS AND ADDITIONS

Source:

Date:

10. Optical illusion. Gadget shown in Fig. 818 is made from bent hairpin or paper clip, rubber band, and wooden match minus its head. Place tip of finger on end A of match, bring end B down against bar. When released, match snaps back so fast that it appears to penetrate bar. Same effect can be achieved (as I once explained in "Genii", Jan., 1941) with a band and two matches (Fig. 819).

11. A band stretched around head as in Fig. 820 gives impression of prize fighter with twisted nose and cauliflower ears.

12. Schoolboys often shoot rubber bands with one hand. Maximum power is achieved by hooking one end of band over nail of forefinger, carrying band back around thumb, then down to base of hand where it is held by tip of pinkie. Band shoots forward when pinkie releases its end.

13. A band is placed lengthwise around a business card or playing card. If one end of band is pulled several inches away from card and released, other end of band will shoot out from card a full inch-and-a-half, although this will not be visible. You can balance another card on its end (by bending it a bit) and use this principle for knocking the card over. Since the band's motion as it shoots out from other end of card cannot be seen, spectators cannot understand what force caused the standing card to be knocked down. Jerry Andrus showed me this.

14. One band shown as two. Twist band as in Fig.



820a. Tips of left forefinger and thumb are inserted up into band at spots A and B, tips of right

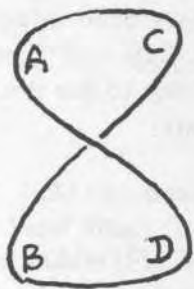
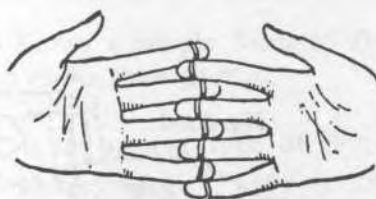
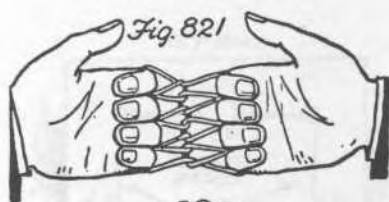

Fig. 820a



forefinger and thumb down into band at spots C and D. By alternately moving fingers and thumbs apart and together, in a scissor-like way, it looks as though you are displaying two separate bands, one held by your index fingers, the other by your thumbs.

Jerry Andrus, after doing a trick with two bands, secretly laps one band, then displays the other in this manner as though he were holding the two bands previously used. The two now suddenly become a single band.

15. Magician holds a band between thumb and finger of one hand. He places his hands under table

## COMMENTS AND ADDITIONS

Source:

Date:





or turns his back. A moment later he exhibits the band on his fingers in the intricate design shown in Fig. 821. Done by first placing band around fingers as in Fig. 822. Open the hand to Fig. 823. Now form both hands into fists, catching a portion of band on each finger. When fists are separated a few inches, the design will be seen.

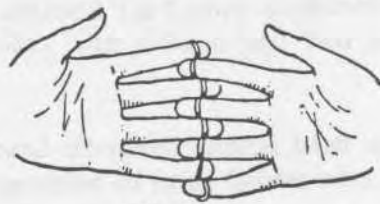
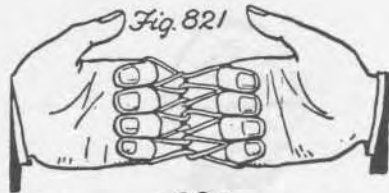

Fig. 823

16. Place tips of each forefinger in a band and move them in circles as in Fig. 824. Pause, bring together the tips of each finger and thumb (Figs. 825 and 826). Note that each thumb touches a forefinger. Open these fingers as in Fig. 827. This permits you to shake band off the fingers to the table. Challenge anyone to duplicate. They will find it very difficult, even though you repeat the procedure many times. Trick is sometimes done with large ring or bracelet, or loop of string. (Blyth, "Impromptu Conjuring", 1924.)

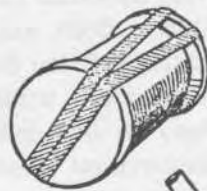

Fig. 828



Fig. 829

COMMENTS AND ADDITIONS

Source:

Date:

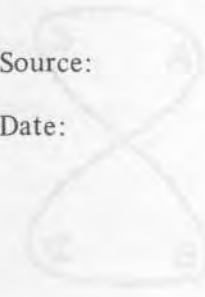

Fig. 820



Fig. 821

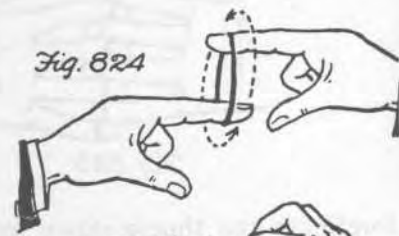

Fig. 824



Fig. 825



Fig. 826



Fig. 827

17. Twist a wide flat band twice around a spool to cover one hole (Fig. 828). Blow through opposite hole, which remains uncovered. Produces sound like a pitch pipe. "Ma! Ma!" can be rendered by cupping hands over end of spool, opening and closing one hand.

18. Flutterbugs. Fold two small sheets of paper into tight strips, bend them, twist a band several times around the middle (Fig. 829). Hold one strip and "wind" the other until band is tightly twisted. Place gadget under victim's inverted coffee cup. When he lifts cup, the bug dances madly over table. Or drop it suddenly in victim's lap.

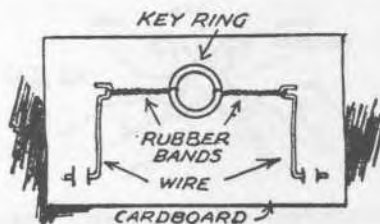

Fig. 830

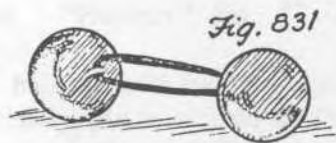

Fig. 831

Fig. 830 shows a simple form of flutterbug for sending to victim through mail.

Fig. 831 is an ancient type of flutterbug (See Albert Hopkin's, "Magic", 1897, p. 383), still sold occasionally as a toy. (Dime stores carried them in the early forties.) Easily made by stapling rubber band to two rubber balls. Gadget is "wound" by holding one ball, twirling the other around it in a circle on top of table.

## RULER

1. Balancing stunt with ruler, cord, and hammer is shown in Fig. 832.

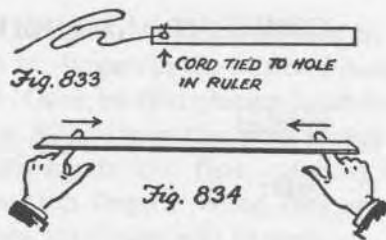

Fig. 832

## COMMENTS AND ADDITIONS

Source:

Date:



## COMMENTS AND ADDITIONS

Source:

Date:

2. Fig. 833 shows how to make a "ruler roarer" for a child. Hold free end of cord, spin ruler around body. It gives out a lion-like roar.

3. Support ruler on your forefingers (Fig. 834), then move the fingers slowly toward each other. Because friction increases as the weight of an end increases, it is impossible to prevent fingers from meeting exactly at center even though you may try to make them meet at some other point. The effect is particularly uncanny if a yardstick is used. In 1953 a version of this was marketed as the "Einstein Enigma," using a four sided stick weighted at one end and with indices of cards marked along the sides. Fingers always met at an off-center balancing point to indicate a forced card.

4. To bite an inch from the end of a ruler, hold ruler with one end an inch away from mouth. Bite.

5. There is an interesting puzzle connected with the standard carpenter's ruler consisting of four sections that are hinged together. The problem is to open the ruler one section at a time, and in such manner that each time you open it the ruler is extended by one section in the same direction. Fig. 835 pictures the solution.

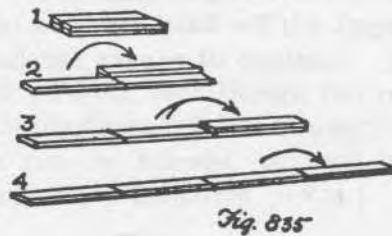

6. The comedian Jonathan Winters, on a 1964 television show, did a long, funny troublewit type of routine using a carpenter's ruler as the only prop: flute, walkie-talkie, bridge hand, bolt of lightning, golf club, fishing reel, the letter "W" on a sweater, the letter "M" on same sweater (for University of Wisconsin and University of Minnesota), accordion, and so on.

## SAFETY PIN

"Safety-Pin Trix", by Jerry Andrus, 1955, is a 70-page book that contains, in addition to effects using a prepared "key" pin, a number of unusual impromptu effects with unprepared pins. These are not included among the tricks given below.

1. "Piff-Paff- Poof." If two linked safety pins (blanket pins are easiest to handle as well as see) are held exactly as in Fig. 836 and jerked quickly apart, they will separate without opening. For Don White's routine, see "Greater Magic", p. 871.

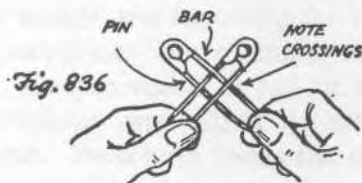

A gimmicked safety pin for performing this and other effects has been on the market for many years. It is based on L. Vosburgh Lyons' "Slip, Snap, Spoof," "Phoenix" No. 47, Nov., 1943.

2. Folded hank is held by two spectators as in Fig. 837. Safety pin is affixed to the cloth near fold as shown. Grab end "A" of pin, jerk it to the left, at same time twisting it so end "A" points in the direction pin is moving. This permits pin to slide along cloth without opening or tearing cloth. After moving pin about six inches, a quick turn of the pin puts it through the cloth again, giving illusion that bar of pin was dragged through the cloth without ripping it.

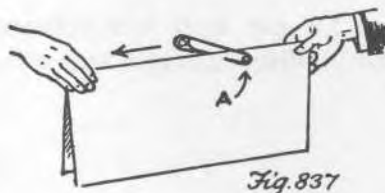

Richard Durham's version ("Genii", April, 1950) begins by putting pin through the cloth as described above, then rolling hank around it in a tight cylinder (Fig. 838). If you grab end of pin and yank, it pulls free without opening or damaging hank. If you begin this by folding hank diagonally like a diaper, you can patter about how to remove a diaper pin without scratching baby. It is also

## COMMENTS AND ADDITIONS

Source:

Date:

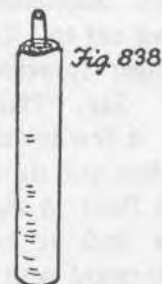

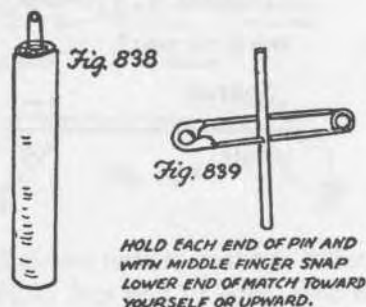

possible to yank pin free without rolling hank into cylinder. Spectators simply hold the folded hank taut (Fig. 837) as you give pin the proper twist and yank upward.

3. Large kitchen match (minus head) is pierced by small safety pin (Fig. 839). If finger presses one end of match against bar and releases, match snaps around too fast to be seen, giving illusion that it penetrates bar. (See RUBBER BAND, No. 10.)

4. Two open safety pins can be held so the point of each open pin is under the clasp of the other, making them both appear to be closed. Tossed on table, both pins mysteriously open. (Jerry Andrus.)

## SALT

1. Flying salt. Nelson T. Downs' "Art of Magic" gives this classic version. Spectator shakes a quantity of salt onto your right palm. For dramatic build-up, pour it onto his palm then let him pour it back on yours again. As you cover right palm with left, salt is tossed up left sleeve as in the familiar coin sleeving move. Right hand now apparently closes around salt. Show left hand empty. Make a tossing motion with right hand and open it to show salt has vanished. Lower left hand, allowing salt to fall into it. Reproduce the salt by pouring it from left fist onto spectator's palm.

2. Sleight of foot. Spectator cuts deck into two piles, looks at card cut to. Tap back of this card with your forefinger (previously moistened and touched to salt). Say, "Place the other pile on top of this one." A few invisible grains of salt fall on chosen card when you do this. The assembled deck is placed on floor. A slight kick with toe of your shoe causes deck to break above selected card. Push card forward with your toe and turn it over.

## COMMENTS AND ADDITIONS

Source:

Date:



## SALT SHAKER

1. Vanishing salt shaker. Wrap shaker in cloth or paper napkin and vanish by lapping as explained in GLASSES, No. 1. For misdirection, use either a coin on the table which you say you intend to make appear either heads or tails, or a small pile of salt which you say you intend to vanish. Instead of making shaker disappear, you can cause it to change to pepper shaker. Simply allow salt shaker to fall into lap. At same time, left hand takes pepper shaker from lap and pushes it up into napkin shell.

2. Wadding paper napkin into top of an opaquesided salt shaker, and loosening the cap, opens up vanish possibilities. For example, hold shaker in right fist, the cap visible at top of fist. Lap the shaker, retaining cap. Cover fist with left hand, palming cap. Press both hands flat on table, then lap cap.

## SAW

1. Any large saw can be used as a musical saw by clipping the handle between the thighs, then grasping end of saw firmly and bending saw into the proper S-shaped curve. Musical tones are produced by tapping the saw or bowing it with violin bow. Changes of pitch are produced by altering the curved shape. Slight tremor of hand produces vibrato effect. Veteran musical saw experts (e.g., Marlene Dietrich) use special saws designed for musical purposes.

## SCARF

1. See handkerchief trick No. 72 for excellent parlor puzzle that works beautifully with a man's scarf.

## SCISSORS

1. Many ring on string effects (see RING) can be applied to scissors. Gag: put cord through handle of scissors, let spectator hold ends. To remove scissors, simply use them to cut the cord! See HMM, Dec., 1948 for a routine in which scissors are removed from string by what seems to be this

## COMMENTS AND ADDITIONS

Source:

Date:



gag, since cord appears to have been cut and tied together. To everyone's surprise, however, the performer miraculously restores the cord.

2. Cord or piece of paper is tossed into air. As it falls, you snip a piece from it with scissors. Secret: narrow strip of paper is concealed between scissors flutters to the floor as though it had just been snipped from the paper.

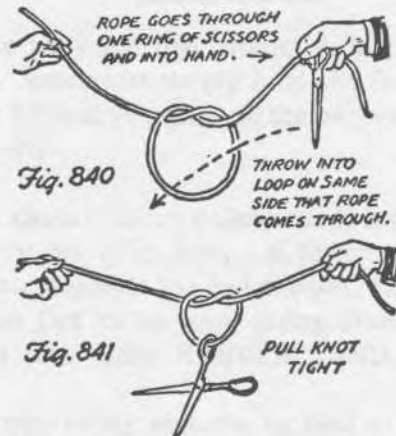

3. Hold ends of rope as in Fig. 840, with scissors on rope and held as shown. If you toss scissors into the knot as indicated by dotted arrow, they will drop through knot and hang as in Fig. 841. (HMM, Feb., 1946)

4. Tom Tit, "La Science Amusante", Vol. 2, p. 191 says that plate glass can be cut with ordinary scissors by holding the glass and scissors under water. If glass is thin and scissors sharp, a tolerably unjagged cut can be achieved. The water prevents glass from vibrating while being cut.

5. Large scissors with highly polished surfaces can be used as "shiners" in various ways. For example, spectator stabs points of scissors into deck, looks at card above. As this is done, you see reflection of index on the blades. Norman Jensen makes this suggestion in "Magic from M.U.M.", edited by Milbourne Christopher. Spectator holds his selected card up at eye level, face of card toward him. As a thought-transmitter, you hold one end of a length of ribbon to your temple while he holds other end against his temple. Then you "cut the thought" by snipping ribbon with a pair of scissors, and immediately name card. Ribbon is cut close to spectator so you can obtain reflection of card in the scissors.

## COMMENTS AND ADDITIONS

Source:

Date:

## Puzzles

6. An old party stunt. Everyone sits in a circle. Pair of scissors is passed around circle from person to person. Those "in the know" say either "I pass it crossed," or "I pass it uncrossed" each time they pass the scissor. The uninitiated try to guess what this means, and are corrected by the initiated every time they pass the scissors incorrectly. The secret has nothing to do with how scissors are held. "Crossed" simply means that one's legs are crossed when the scissors are passed. "Uncrossed" means the legs are uncrossed.

7. C. Lang Neill's "Modern Conjuror", 1902, gives a puzzle in which scissors are held by the two little fingers, flipped toward you, then backs of hands brought together in such manner that the scissors are pointing upward at the finish. When others try, they invariably end with scissors pointing down. The trick is dangerous, unless children's blunt-end scissors are used, and so will not be described here.

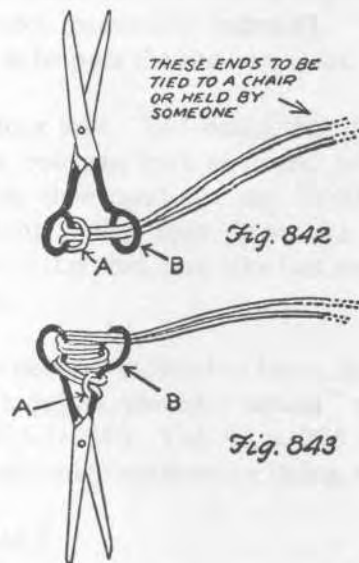

8. Fig. 842 shows an easily prepared puzzle. Problem: to free scissors without cutting cord. See "My Best", p. 158, for Clyde Cairy's effect in which this puzzle is first demonstrated, then scissors are apparently threaded on cord as before. This time they are removed from the cord quickly and magically. Fig. 843 (from Sam Loyd's "Cyclopedia of Puzzles") is a more complicated version of essentially the same puzzle. In both versions, loop A must be pulled along the double cord until it emerges from handle B, then loop is passed over entire scissors.

## COMMENTS AND ADDITIONS

Source:

Date:

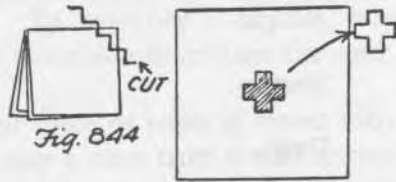

9. Problem: fold a sheet of paper twice and cut out a Greek cross with one snip of a pair of shears. Secret: you have to use pinking shears. Fold and cut as shown in Fig. 844. Tom Ransom, of Belleville, Ontario, takes the blame for this.

## SHIRTS

1. To remove spectator's shirt without removing his coat or vest, spectator must of course be a stooge. Shirt is "put on" by draping it over his shoulders, buttoning collar, and buttoning cuffs around his wrists. He then dons vest and coat. You will find that by adjusting front of shirt you will be able to button one or two buttons down from the neck so that shirt appears normal above the vest. Add necktie and stooge is all set. To remove his shirt, seat him in a chair, remove his tie, unbutton collar and any other buttons below it that have been buttoned. Unbutton his cuffs. Seize shirt collar behind his neck and pull up. Shirt will pull free. An old stunt but still one of the funniest if stooge does convincing job of acting nonplussed and enraged.

Variation: Prepare as before except that one arm actually goes into sleeve. In this case, shirt is removed by pulling it out through coat sleeve.

Once at a magic meeting in Chicago, Joe Berg convulsed the house by acting as stooge in this trick. Unknown to the magician, Joe wore a second shirt (complete with tie) under the prepared one! The performer removed Joe's shirt only to find Joe still wearing one!

2. Color changing shirt. Various gimmicks have been sold for this, but you can make your own by sewing a white collar to a brightly colored sport shirt. To make shirt appear white, tuck a white hank under your tie and collar and don a vest. To make shirt change suddenly to colored one, reach under vest and jerk down the hank.

## COMMENTS AND ADDITIONS

Source:

Date:



## SHOE

1. Russ Swan's production. Untie shoestrings so shoes slip off easily. Stand before audience with a large cloth that you hold in front of you. Lower cloth to floor. Behind it, slip off shoes. Whip away cloth to reveal shoes on floor, bow, walk off in stocking feet.

2. Jay Marshall's production. At formal dinner party, secretly remove shoes and hold in lap. Use table napkin as you would the cloth for a bowl production, draping it over one arm, then bringing shoes up under it with other hand. Whisk away napkin to reveal your muddy old shoes on the nice clean tablecloth.

3. The illusion that you are a midget can be created by getting on your knees, facing audience, with each knee in a shoe.

4. Logan Wait pretends that something hurts his foot. He takes off shoe and dumps out two enormous rocks (previously palmed). "Pebbles," he remarks as he puts the shoe on again.

5. Outdoor joke. Tell victim that if he hands you his shoe you can look at it and tell his fortune. Study his shoe carefully, say "You are about to take a long walk," then throw the shoe as far as you can. After that, you take fast walk in opposite direction.

6. For a peculiar method of lacing shoes so that no knot is required, consult "Strand" magazine, Vol. 40, p. 835 (1910). Vol. 41 p. 375 (1911) gives a somewhat similar method for lacing a boot.

## SHOELACE

1. Numerous methods have been devised for cutting off the ends of a shoelace, then restoring it; not strictly impromptu since they require the insertion of one shoelace inside another. An excellent early method, invented by John H. Percival and first explained in H. Adrian Smith's typescript, "Master Mysteries of 1933", is explained in Smith's later book, "Superb Tricks", 1953, p. 43.

2. Magician removes his shoe, yanks on knot, and shoelace pulls free of shoe. Or knot is untied,

## COMMENTS AND ADDITIONS

Source:

Date:





Buster Keaton managed several times to get publicity with the simple gag of kneeling in his shoes.

When he played the Cirque Medrano in Paris in 1953 he posed outside as Toulouse-Lautrec and made world wide wire services. He's shown here with Zsa Zsa Gabor in the late 1950's.



Keaton got his nickname from Harry Houdini.

At six months, Joseph Frank Keaton fell down the stairs of a theatrical boarding house in which the Keatons and the Houdinis were staying. The baby started to laugh and Houdini said, "That was some buster your baby took." And from that day on, he was known as "Buster" Keaton.

## COMMENTS AND ADDITIONS

Source:

Date:

spectator given ends of laces to hold, and under cover of cloth, you remove shoe. The shoe is apparently laced in usual manner, but actually is not. At each hole a loop is merely pushed down through hole. The hidden loops on each side of shoe can be held in place by two toothpicks, one on each side, which go through all loops. Under cover of cloth, toothpicks are of course removed to free shoelace.

### SOAP

1. To reveal name of chosen card, number, word, etc., write required letters or numbers on inside of forearm, using corner of piece of soap. Name of card is later written on sheet of paper. Burn the paper, rub ashes on forearm to bring out the soap writing.
2. Practical joke. A tiny bit of soap dissolved in ink makes it impossible to use the ink. When point of pen touches paper, ink runs out to make large blot.

### SPECTACLES

1. To reveal name of chosen card, say King of Hearts, performer takes off his glasses, breathes on them. "K" appears on one lens, "H" on the other. Letters are written with brush dipped in weak solution of detergent and allowed to dry. "No-fog" cloth or paper can also be used by wrapping it around end of match and writing on lenses.
2. A remarkable optical illusion can be demonstrated with a pair of dark glasses. Make a pendulum by tying a weight to one end of piece of string. Someone swings the weight back and forth on a plane at right angles to observers' line of vision. Observer holds one lens of dark glasses over his right eye, but keeps both eyes open. Weight will appear to swing in a circle! If the dark lens is shifted to other eye (both eyes remaining open) the weight will seem to go around circle in opposite direction!
3. Some sight bits:
  - A. Put on glasses at sharply tilted angle. Remark, "What is your opinion of Picasso?"

### COMMENTS AND ADDITIONS

Source:

Date:

B. Robert Orben includes this in one of his books. Your impression of a man from Mars cleaning his glasses. Pretend to take off invisible pair of glasses, breathe on one lens, then another lens next to it, then a third lens, and so on until you get the laugh.

C. Take out a packet of "Sight Saver" tissues. Remark on how much your vision has improved since you began using them. Tear off a tissue, remove glasses, wipe your eyes with the tissue.

D. Senator Crandall picks up restaurant bill, says "I'm a bit near-sighted," reads bill by pushing it between his eye and lens of glasses.

4. Gag glasses for special occasions can be prepared by pasting appropriate pictures of lenses. Example: when about to read a restaurant bill, or transact any sort of financial matter, put on spectacles with large dollar signs on each lens.

#### SPOOL

1. Three spools of different colored thread and two lengths of ribbon are all you need for colorful version of the familiar "grandmother's necklace" trick.

2. Push a thumbtack through center of a card. Card is held below spool as in Fig. 845. If you blow down through spool and release card, you would expect card to be blown to floor. Actually, it remains clinging to spool. The principle involved here is that which causes an airplane to rise. Air rushing over top of card lowers air pressure above card. By bending up corners of card, you can make it rotate as you blow.

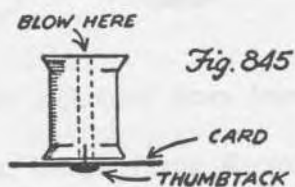

3. A variety of toys (puzzles, moving tanks, pencil shooters, whistles, etc.) can be made from spools. Joseph Leeming's "Things Any Boy Can Make" is the best reference for this I have seen.

#### COMMENTS AND ADDITIONS

Source:

Date:

## SPOON

1. The well known stunt of bending a spoon by holding handle with both fists and pressing bowl of spoon on table, is given some added twists in Bruce Elliott's "Best in Magic", p. 8. By using a nickel as a gimmick (an idea of Dai Vernon's son, Derek), the bending illusion is strengthened.

2. Gag: pretend to do bending stunt above, but actually bend spoon until it almost forms a right angle. "Does it look as if it is bending?" you ask. Everyone agrees it does. Then display spoon with, "Well, it sure as heck should!" Needless to add, this should be done only at restaurants using cheap silver. The spoon is easily straightened.

3. A surprise follow-up to either of above stunts is to place spoon at edge of table, pretend to pick it up with both fists (see PENCIL, No. 6) but actually lapping it. Wiggle fists up and down as though bending a rubber spoon, then vanish it with the fingernail snap explained under pencil version. If you wish, a miniature spoon (previously palmed) can now be tossed on table.

4. Magician leaves room while a guest snaps a "spoon picture." This is done by holding up bowl of spoon in front of someone, as if it were a camera, and taking his picture. Magician comes into room, examines a bowl of spoon, names the person whose picture was taken. A stooge conveys the information by sitting in exactly the same position as person to be named.

5. Lady bather. Rest bowl of spoon on right fist exactly as shown in Fig. 846. By moving first and fourth fingers up and down alternately (keeping them bent), the reflection in back of spoon will bear a striking resemblance to a woman, backside toward you, taking a bath. With practice you can go through routine of having the lady pick up the soap from side of tube (extend pinkie out to one side and back), drop the soap in tub and bend forward to pick it up, scrub first one foot and then the other (tilt hand to one side and scrub with one finger only, then tilt the other way and scrub with other finger), put back the soap, then dive out of tub. The dive is produced by moving hand up and

## COMMENTS AND ADDITIONS

Source:

Date:

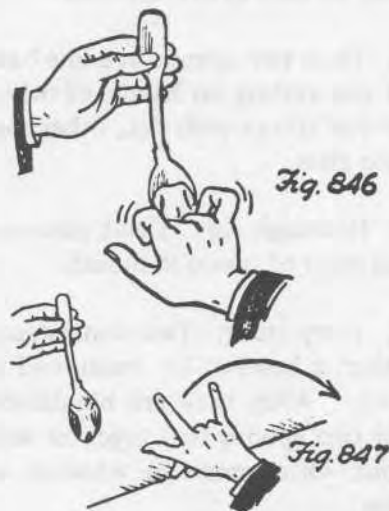

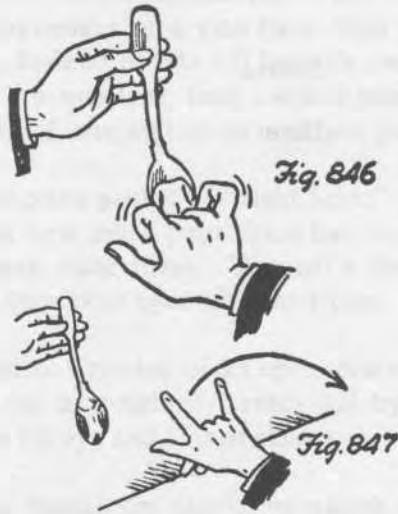

## COMMENTS AND ADDITIONS

Source:

Date:

back in a wide arc. This makes it look as if she dives forward.

Johnny Murray suggests resting knuckles of second and third fingers in an empty match box drawer to simulate a bathtub.

6. The diver. Similar to above except that you hold hand at edge of table about eight inches from spoon (Fig. 847). By waving first and fourth fingers up and down (keeping them straight), image appears to be that of bather at edge of pool preparing to dive in. Dive is accomplished as before by moving hand up and back in an arc as shown by arrow. If you like, make your diver walk to edge of pool before he dives in. A table knife placed so its blade extends toward you over edge of table may be used as diving board.

7. Place two spoons in a line beside glass, the bowl of one resting on handle of other. By hitting bowl of one spoon with fist, other spoon is made to flip into glass.

8. Hiccough cure. Drink glass of water while keeping bowl of spoon in mouth.

9. Party stunt. Two contestants sit opposite each other, a bowl of ice cream and a spoon in front of each. After they are blindfolded, switch spoons for two spoons tied together with a foot or two of cord. Offer prize to whoever eats his ice cream first.



10. If bowl of large wooden spoon is held over your open mouth and rapped with bowl of another spoon, it is possible to play a tune by opening and closing your mouth in varying degrees.

11. Two spoons can be rattled in the manner of rattling bones. For best sound effect, bend each spoon slightly so the backs of the two bowls strike each other at central points.

12. Knot a silver spoon at the center of a long piece of string. Wrap each end of string around an index finger (Fig. 848). Push tips of fingers into your ears as shown, bend over, allow spoon to strike chair or table. You will hear a sound like distant church bells. Other pieces of silverware can be used, as well as a straight poker, wire coat hanger, and other objects that vibrate regularly.



13. Gags. Pretend you can't recall name of hotel where you stayed, pull spoon from pocket and read name from handle. Enter party with remark that you just finished dinner at such-and-such hotel, lower arms, allow dozen or more spoons to drop out of sleeves and clatter on floor. At dinner table, surreptitiously load a spoon into hank pocket of victim's jacket. Later ask him if it's true that he has kleptomaniac tendencies. Continue along this line until he becomes aware that everyone is laughing about the spoon sticking out of his jacket.

14. Problem: pick up spoon with thumb and first finger only, the tip of forefinger touching inside of bowl and thumb pressing against end of handle. Seems to work best if finger is first dried by rubbing it on your sleeve.

15. Problem: hang bowl of spoon on tip of nose (Fig. 849) so that spoon remains suspended even though your head is upright. Takes a while to get the knack, or perhaps tip of nose simply gets stick-

## COMMENTS AND ADDITIONS

Source:

Date:



ier the more you try it. Earl Wilson's "New York Post" column, April 1955, reported this to be a current rage of Cafe Society. Karrell Fox likes to get spoon into position, then if someone stares at him he says, "What's the matter, haven't you seen a blue serge suit before?"

### STAMP, POSTAGE

1. Begin trick with a moistened stamp finger-palmed in right hand. Left hand shows both sides of an unstamped envelope. Take corner of envelope in right hand, secretly sticking stamp in place. At same time, left hand picks up duplicate stamp and carries it to mouth. Pretend to lick stamp, actually leaving it in mouth. Place envelope on table, stamp side down. Left hand pretends to fasten stamp to one corner. Show stamp has vanished, turn over envelope and there it is. (David Eisendrath, Jr.)

2. Magic postage stamp album is easily prepared by trimming 1/16th of an inch from the side of every other leaf. Attach stamps only to alternate pages. When pages are flipped through one way, album is empty. Flipped the other way, album is filled.

3. To stick stamp to ceiling, moisten it, place on top of half dollar, toss coin against ceiling with spinning motion to keep it flat.

4. Party stunt: blow off postage stamp, stuck to tip of nose, in 30 seconds or less.

5. Ask someone if he would like to have a handsome engraving of George Washington, suitable for framing. Give him a one cent stamp.

6. Problem: fold a stamp once only, and with one cut of scissors, trim off all serrated edges. Tom Ransom's solution: use a stamp with only two serrated edges, obtainable from either a booklet or roll.

### COMMENTS AND ADDITIONS

Source:

Date:



## STICKER

1. Tarbell's phantom sticker. See "Tarbell", Vol. 6, p. 131f, for three effects using a gimmicked sticker easily prepared with two Dennison paper seals. Tarbell's travelling sticker, using unprepared seals and a slit envelope, will be found on p. 136.

## STOCKING

1. Finger ring is dropped into sock, end of sock knotted. Performer removes ring. Ring is switched for wire gimmick (see RING, No.6) which is worked through cloth, switched back to ring.

2. Wear a sock of one color on one leg, sock of another color on other leg. When someone notices it, say, "Yes, and the funny thing about it is that I've got another pair at home just like this one." An oldie, but still funny.

## STRAWS, SODA

1. Kolar's straw trick. Straw is previously prepared by making three-inch slit with razor as in Fig. 850. Thread a two-foot length of string through straw. (Quickest way to do this is to insert string into one end of straw, suck on other end to draw string through.) Bend straw in half as in Fig. 851. A tug on string brings it down through slit as shown. Display straw as in Fig. 852, thumb and finger concealing string. Snip straw in half at "A." Put cut ends together then pull "restored" string from straw.

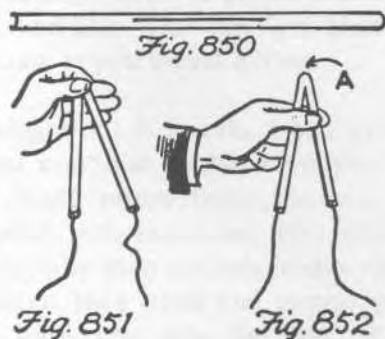

2. Thread string, as explained above, through unprepared straw. If straw is snipped with loose pair of dull-bladed scissors, it will cut straw without cutting string.

## COMMENTS AND ADDITIONS

Source:

Date:

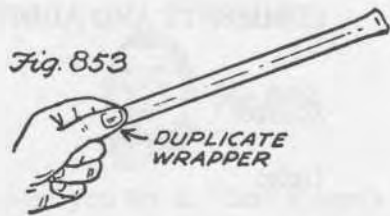

3. Torn and restored wrapper. Emil Jarrow has adapted the torn cigarette paper to the paper wrapped around drugstore straws. Before showing, slide a wrapper from a pair of straws, compressing it into a tiny ball. This is concealed between left thumb and forefinger as you hold pair of wrapped straws (Fig. 853).

Extend left hand and allow someone to tear off end of wrapper and remove the straws. You now tear wrapper several times, putting each piece between left thumb and finger. Roll torn pieces into ball. As you do this, keep moistening tip of right finger on tongue. When torn pieces are as compact as possible, dispose of them in mouth as you touch fingertip to tongue. Continue kneading duplicate ball. Then pull it slowly open to show restored wrapper.

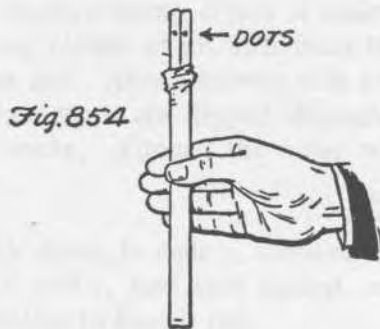

4. Slide wrapper down part way and pretend to pencil a dot on opposite sides of each straw near the ends. Hold as in Fig. 854. You can now do paddle move (see MATCHES, PAPER, No. 13) to show dots apparently on both sides of straws. As hand turns, straws are rotated by thumb and fingers on outside of wrapper. Dots can be made to vanish and reappear as in match trick cited above.

4a. Two flattened straws serve admirably for doing Tabor's interlocked silks trick (see handkerchief trick No. 15). A similar effect can be achieved by

## COMMENTS AND ADDITIONS

Source:

Date:



using the subtle move invented by Jay Marshall for his method of doing the thumb-tie with pipe cleaners, and explained in his manuscript, "The Jaspernese Thumb-tie" (Magic, Inc.).

#### Stunts and Gags

5. Slide off paper wrapper, compressing it into a tight spring. Put on table and let a few drops of water fall on it. It will expand with a wiggly motion like a caterpillar.

6. Flatten two straws and bend them as in Fig. 855. When ends are pulled, center portions of straws come together with loud popping noise.



7. If you pinch together the tip of a straw, it forms a reed that produces a musical tone when you blow through it. For best results, trim sides as in Fig. 856. By cupping hands over end and opening and closing them, you can produce a sound like a cow. The tone can be amplified by slipping neck of funnel over end of straw. Several straws side by side, of differing lengths, will produce a chord if the lengths are right. It also is possible to tear small holes in the straw at proper intervals and play a simple tune like "The Old Gray Mare" by fingering the straw as you would a flute.

An amusing stunt is to take a pair of scissors and while you continue to blow on the straw, keep snipping short pieces from the end. The tone rises in pitch with each snip. This ridiculous bit of business usually puts spectators into stitches, probably because they hope and expect you to keep snipping until you snip the end of your nose.

8. Tear off one end of wrapper. Blowing through straws will send wrapper sailing across room. A popular teen age sport is to dip end of wrapper in butter or chocolate syrup, and blow upward, caus-

#### COMMENTS AND ADDITIONS

Source:

Date:



ing wrapper to stick on ceiling. See "Life, Sept., 1953 (exact date not known) for picture story about a Ludington, Michigan, soda bar patronized by enthusiastic wrapper blowers. Ceiling resembles a grotto hung with stalactites.

9. Make pin holes along side of straw, then seal one end by twisting it. Rub soapy finger over the holes. When you blow, bubbles appear at each hole along straw.

10. A chain can be formed by pinching the straw as



Fig. 857

in Fig. 857, each pinch flattening it at right angles to previous pinch. Children like to ask, "Does so-and-so like so-and-so?" then form the chain while reciting over and over again. "Very much, just a little, positively, not at all." Last pinch gives the answer.

11. Slide off wrapper, compressing it into compact bundle. Conceal it in one ear. Take another set of straws, tear off end of wrapper, then hold straws to other ear. As one hand slides wrapper toward ear, other hand pulls out duplicate wrapper (Fig. 858). More offensive version: use nostrils instead of ears.



Fig. 858

12. Children's activity books and magazines often feature articles on how to use colored soda straws for making jewelry, Christmas tree ornaments, etc.

14. Paul LePaul picked up this one from a St. Louis bartender, contributing it to the "New Phoenix", No. 324, March, 1956. If you hold a raw, unpeeled potato in left hand and soda straw in right as in Fig. 859, it is possible – incredible as it seems – to drive straw completely through potato! (Fig. 860). Straw must be straight when it hits, the slightest angle causing it to bend. Quick downward thrust does it. The air column trapped in straw is what probably keeps it momentarily rigid enough to cut through. The bartender misled his patrons

## COMMENTS AND ADDITIONS

Source:

Date:

## COMMENTS AND ADDITIONS

Source:

Date:

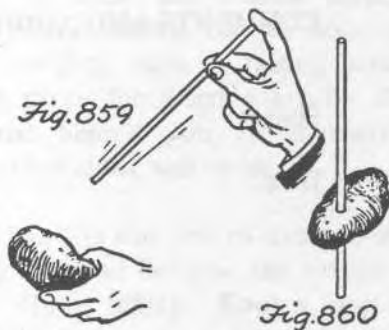

by pretending to suck air out of the straw (taking care not to get the end moist), then jabbing quickly before he "lost the vacuum." When others tried, their sucking bent the straw out of shape and also softened the end, making the feat impossible.

15. Problem: put a dime or some similar lightweight object with a flat surface, into a glass without touching object or glass. Solution: place end of straw against dime, suck on other end. Dime sticks to straw long enough for you to lift it into glass.

## STRING

1. Cut and restored. Methods are far too numerous to permit discussion here. Most methods of cutting and restoring a rope can be adapted to string; even methods using gimmicked or rubber-cemented ends have been applied to string by using wax and other substances on the ends. Yarn can be broken apart, the ends rubbed together to give the appearance of being joined. The oldest method of cutting and restoring string (the double loop that is cut, then chewed together) goes all the way back to "Hocus Pocus Junior", 1634.

The principle of dividing a many-strand string at its midpoint, pulling outward on the strands to form a loop, then twisting each side of the loop to simulate ends, is the basis of many beautiful string effects. In simplest form, exhibit what appear to be two separate pieces of string lying side by side. Spectator is offered a magician's choice of ends, then the strings are apparently joined as spectator pulls on two ends while magician's fist covers the other two ends. "Abbott's Encyclopedia of Rope Tricks", Vol. I, by Stewart James, p. 94, credits the principle to Joe Berg who had earlier marketed the trick. For typical routines using the prin-

ciple, see Joseph L. Barnett's handling in James Thompson, "My Best", p. 154, and Paul Curry's routine in "Magician's Magic", p. 145. Charles Miller's way of using the principle is given in detail in "Ireland's Trick Talk", Fall-Winter, 1959.

2. Releases and catches. These are stunts in which a loop of cord is apparently linked to something, but pulls free; or appears to be free but turns out to be linked. For example, the loop can be freed from a buttonhole, from around the neck, from the nose, from a finger ring. It can be twisted around the fingers of left hand in various ways and pulled free. It can be twisted around a spectator's raised finger and pulled free. "Garter tricks," in which a spectator tries to put his finger in a loop so that the string will catch on his finger when pulled, also belong in this general category. Again, the topic requires a book in itself. The literature is large, so I content myself with mentioning only three references: "The Secret Out", pages 210-260; R. M. Abraham, "Easy-to-do Entertainments" (a Dover paperback reprint of an earlier book); and Joseph Leeming, "Fun with String".

3. String figures. These are patterns formed between the fingers, such as the familiar cat's cradle, Jacob's ladder, crow's feet, and so on. The basic reference is "String Figures and How to Make Them", by Caroline Furness Jayne, 1906, now available as a Dover paperback reprint. For other references, see the bibliography at the back of Jayne's book and my chapter on string figures in "The Unexpected Hanging and Other Mathematical Diversions from Scientific American".

4. Practical joke. Ask victim to hold one end of long string, go around a corner, tie other end to something, leave.

5. Tie a finger ring or other small weight to string, and use as the well-known sex indicator sold in novelty stores.

6. Small weights are tied to each end of a string about six feet long. Hold center of string. Start one weight spinning clockwise, then give other weight a spin in opposite direction. By moving hand straight up and down you can keep the weights revolving in opposite directions. String should be held a bit off-center so the weights do not collide. Weights appear to meet at top and

## COMMENTS AND ADDITIONS

Source:

Date:

bottom of circle and reverse direction. With practice, many stunts can be done with the revolving weights, such as raising hand over your head to make the weights revolve alternately in front and behind you, or alternately on your right and left sides, and so on.

7. Betcha. Tie one end of string to an object, say a coffee cup, and bet you can cut the string without the object falling. Knot a loop in the cord, then cut loop.

8. There is a way of looping cord around the left hand so it is possible to break even the strongest fishline with one's bare hands. The principle is that the string is arranged so it cuts itself. The method is explained in the 1882 English translation of Gaston Tissandier's "Popular Scientific Recreations", p. 871, and my "Science Puzzlers", p. 98. A detective story in which this method plays a key role is "The Rajah of Agh Buthal", in "Secret Service Smith", by R. T. M. Scott.

There are several ways of looping the string. The best, in my opinion, is to start by holding one end of cord at crotch of left thumb. Right hand wraps the cord several times around the palm of left hand in counterclockwise direction. Form a loop in the cord, just below hand, twisting the loop twice, then slide the loop over left hand so the result is as shown in Fig. 860a. Left hand is closed into a fist. Wrap other end of cord several times around right hand, which then jerks downward causing the cord to cut itself within the left fist.



## COMMENTS AND ADDITIONS

Source:

Date:



## SUGAR, LUMP

## COMMENTS AND ADDITIONS

1. Spectator prints a letter, number, or design on lump of sugar, using a pencil with soft lead. While he does so, you moisten right thumb under cover of a cough.

Source:

Date:

Take sugar from him, holding it so marked side is in full view. Under cover of carrying it to glass of water, quickly rotate sugar in fingers so moistened thumb picks up impression of mark, then rotate back again so marked side can be seen as you drop sugar in glass.

Ask spectator to cover top of glass with his right hand. As you adjust position of his hand on the glass, your thumb presses against his palm, leaving an impression of the mark. Or you can turn his hand so it is palm up, leaving impression on back of hand.

While sugar dissolves, call attention to fact that carbon particles from the mark detach themselves and float upward. At the surface, you explain, they release a gas which condenses on the hand. As you talk, clean your thumb on napkin in lap.

Spectator finds impression of his mark printed on his hand.

Instead of spectator's hand, mark may also be transferred to saucer, menu, folded napkin, blank piece of paper, etc.

2. George Schindler has suggested this variation of above. Spectator draws a simple geometrical figure on sugar cube, drops it himself in glass of water which he then covers with saucer, hand, etc.

On your lap is a cube previously marked with six designs—square, circle, triangle, rectangle, cross, rhomboid. Spectator is likely to draw one of these. Press your moistened thumb on proper side while he is busy marking his cube.

After sugar has partially dissolved, pick up saucer, look surprised to find nothing on it. Leave thumb imprint as you return saucer to glass. After sugar has completely dissolved, the design is found on the saucer.





3. Pencil a pair of sugar cubes to look like dice, or mark the sides with letters or designs. Turn back and ask spectator to choose two marks, place the cubes together so chosen sides are touching, and hand them to you behind your back. Before taking cubes, moisten thumb and forefinger of right hand. Turn to face spectators. Get quick impression on right thumb and finger of the marks, then bring this hand to front to stroke forehead. A glance at impressions enables you to name the chosen marks while cubes are still held behind back in left hand.

4. Max Malini carried with him a sugar cube that had been hollowed out on one side. It was used in somewhat this fashion. Cube is secretly placed on table under a napkin. Show both hands empty, then palm cube with left hand in act of pushing napkin aside.

Spectator pours a small amount of sugar in your right hand. Carefully pour this into top of left fist. It goes, of course, into prepared cube. Left hand pretends to squeeze sugar tightly, opens to show cube on palm (open side of cube down). Drop cube into your coffee, or if you want to use it again, simply pocket it or switch for unprepared lump to toss out for examination.

5. The magnetized dice trick, in which one die clings to another (see DICE, No. 1) can be done effectively with sugar lumps by using tiny dab of butter instead of saliva. First rub sugar on sleeve and try unsuccessfully to pick up second lump on table. Repeat, secretly turning lump so buttered side is down. Carry the clinging lump over to coffee, drop both lumps, thus destroying all evidence.

6. Clettis Musson, in "Minute Magic, has this. Pencil two sugar cubes to look like dice. As left hand returns pencil to pocket, finger palm a pair of white dice. Pretend to drop sugar cubes in left hand, secretly retaining in right. Left hand immediately rolls dice across table. As they roll, right hand goes south with the sugar. When cubes stop rolling, spectators find them transformed to real dice.

7. Before showing, unwrap sugar lump carefully,

## COMMENTS AND ADDITIONS

Source:

Date:



removing the lump, then close wrapper and replace this shell among other wrapped lumps in sugar bowl. Several effects are now possible.

Keep unwrapped lump palmed in left hand. "Most



people sugar coffee like this," you say, as you pick up unprepared piece of sugar, unwrap it, and drop it in coffee. "But a magician does it this way." Pick up shell and place on back of opened left hand, watching angles so palmed lump is not visible. Hold hand palm down over coffee (Fig. 861). Smash shell with right hand, at same time allowing palmed lump to fall in coffee.

Walter Gibson in "Four Hundred Tricks You can Do", points out that shell is capable of supporting glass of water. Put shell under the glass. Suddenly force glass to table. Left hand, which has gone beneath table, comes out with sugar lump, previously palmed. Or you can stand a coffee cup on the shell, then push down with right hand as in Fig. 862, allowing palmed lump to fall into cup.

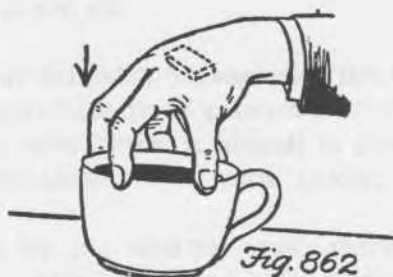

8. The act of putting two lumps in your coffee provides fine chance for impromptu sleight-of-hand. Example: display lump on right palm. Pretend to drop in left hand, but retain in palmed position. Right hand is held over cup, open and palm down. Left hand slaps top of right, which releases sugar so it drops into coffee. Left hand goes to lap and palms another lump while right pretends to pick up a lump from edge of table, lapping it. Repeat same effect, this time with left hand held over the coffee.

## COMMENTS AND ADDITIONS

Source:

Date:

9. Put two sugar lumps on edge of table. Pretend to pick both up simultaneously with each hand. Lap left one, then raise hand slowly, following it with your gaze while right hand lowers and picks up lapped lump. Show empty left hand, roll both lumps from right.

There is a sucker follow-up. Place both lumps on edge of table and offer to explain trick. Left hand is secretly palming two other lumps. Explain that as you pick up the lumps, one on left is dropped into lap. Allow left lump to fall visibly into lap as your left hand closes into fist. Spectators are unaware, of course, that it contains two lumps. Raise left hand and explain that right now goes to lap to retrieve lump. Actually, right hand dumps lump, comes up empty.

"Now" you continue, "I have both lumps in my right hand, none in left." Open your hands, appear startled to find situation just reversed.

10. Chink-a-chink. Four sugar lumps are placed in square formation on table. Fifth lump is secretly palmed. A bewildering series of magic transfers now take place beneath the hands as they cover various lumps. See Sachs' "Sleight of Hand", Chapter 3, for an early description of this classic effect and Horowitz's version, "Chink-a-chink", in the "Stars of Magic" series.

10a. Many dice tricks can be applied to sugar cubes simply by marking the cubes to resemble dice. In some cases, the cubes need not be marked like dice, but letters or symbols can be used instead. For example in dice trick No. 27, Hummer's die mystery, spectator can pencil any numbers, letters, or designs he wishes on each of the six faces. Or he can mark only one face, leaving all other faces blank, and you finish with the marked face uppermost.

The principle involved in dice trick No. 28 also does not require that the faces of a cube be marked like ordinary dice. It is only necessary that the cube be marked so that three faces meeting at a common corner be distinguished in some way from the other three faces which meet at the diagonally opposite corner. Thus you can mark each face of sugar cube with a cross, but draw them so that

## COMMENTS AND ADDITIONS

Source:

Date:



three of them have exactly perpendicular arms and three have arms not quite perpendicular (or use any other symbol, such as the initial of spectator's last name, but draw it in two slightly different ways that are apparent to you but not to others.)

### Stunts and Gags

11. Spectator tries unsuccessfully to set fire to sugar lump with match. Secretly obtain bit of cigar or cigarette ash on tip of finger and transfer it to sugar as you pick up the lump. The ash acts as a catalyst, permitting sugar to catch fire and burn completely when you apply match flame to it.

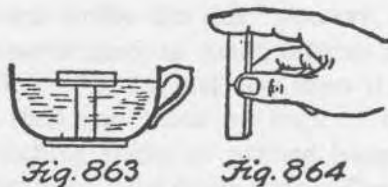

12. When no one at dinner table is watching, stand an oblong lump of sugar on end in your coffee and balance second lump on top as shown (Fig. 863). Top lump appears to be floating on coffee. The trick of getting first lump to stand on end without burning fingers is best achieved by holding two lumps as in Fig. 864, using top lump to steady lower one as you place it in position.

13. Curiously, if you hold two oblong lumps as in

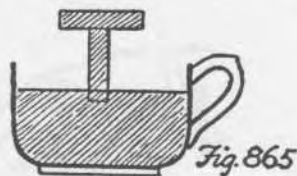

Fig. 865, touch lower end of bottom lump to surface of coffee, capillary action will cause both lumps to turn brown as they become saturated.

14. Palm several wrapped lumps. As you pull hank from victim's breast pocket, allow lumps to fall from palm as though victim has pocketed them.

15. Kirk Stiles suggests carrying pair of sugar cubes, one penciled with seven spots on one side, the other blank. After a series of dice tricks, switch dice for the sugar, roll on table as you call out, "Seven the hard way!"

### COMMENTS AND ADDITIONS

Source:

Date:



16. "It is well known," wrote Francis Bacon in his "Novum Organum", "that sugar, whether candied or plain, if it be hard, will sparkle when broken or scraped in the dark."

### SWIZZLE STICK

1. You have on your lap a glass stirring rod that has been bent slightly in the center (it can be bent by heating it in a hot flame). Pick up unprepared swizzle stick, shake it in such a way that it appears made of rubber (see PENCIL, No. 25). After spectators try it, switch sticks in your lap, then repeat illusion, explaining that if you stop shaking suddenly, stick remains bent. Hand out bent stick for examination. Can be done also with plastic stirring rod (which bends easily in match flame).

2. Prepare glass or plastic rod by tying knot in it. When served a drink, switch sticks. Stir drink, lift out knotted stick, remark "Strong drink!"

3. When a printed line is viewed through a transparent glass or circular rod, the letters are reversed and inverted. On vertical lines of print there is a left-right reversal only. Thus the rod can be used for the Camel cigarette package trick (See CIGARETTE, No. 30) and many of the mirror stunts discussed under MIRROR, No. 5. Rod may also be used as decoding device, writing secret message in symbols that are inverted and reversed versions of letters.

4. Silly sight bit. Say "I haven't felt good all day." Shake swizzle stick as you would a thermometer, put it under your tongue.

5. A plastic tie clip can be made in a moment by holding plastic rod in match flame, bending as in Fig. 866.

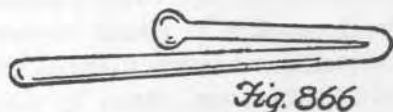

6. Problem: pick up drinking glass using only plastic stirring rod. Stick is held in match flame, bent so it will pick up glass as in Fig. 867.

### COMMENTS AND ADDITIONS

Source:

Date:







## COMMENTS AND ADDITIONS

Source:

Date:

7. Plastic or wooden stirrers (or cocktail picks) are sometimes shaped as in Fig. 868. If there is advertising matter on one side only, it can be made to vanish and reappear by means of paddle move (see KNIFE, No. 1).

8. An amusing motion picture effect can be achieved with wooden cocktail picks of type shown in Fig. 868. For example, draw on one side the figure of a man standing with upraised arms. On other side, draw man touching his toes. Use paddle move to show him standing on both sides. Now start counting "One, two, one, two," while you roll stick between thumb and finger. The sides flip into view alternately, causing movie effect of man exercising.

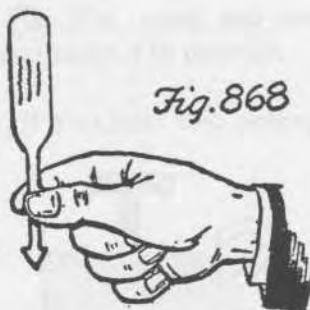

## TABLE

1. Impromptu table levitation. One or more people assist you in this experiment, all stooges. You face audience, your hands flat on center of card table. Others sit on sides, their hands flat on table near edge. Table rises slowly against apparent efforts of stooges to prevent it from rising. Actually, each stooge presses thumb against edge of table and is lifting while he pretends to be pushing down. Properly acted, this can be made convincing to others in room.

## COMMENTS AND ADDITIONS

Source:

Date:

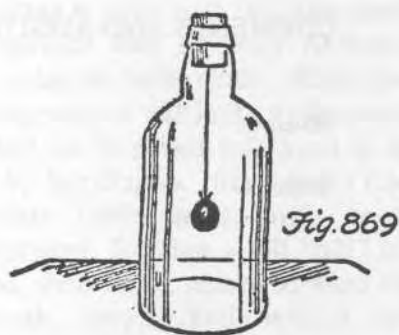

2. A bottle on center of table has small weight (a nut or bolt works fine) suspended by thread from the cork (Fig. 869). On command, weight mysteriously starts and stops swinging, giving numbers, yes and no answers, etc., by the number of times it strikes side of bottle. The gimmick is a plate palpitator device, sold by joke houses. It is under rug, palpitating end beneath a table leg. You stand where you can operate bulb with your foot.

3. Another version of above effect does not use gimmick. Spectators sit around light weight table, hands flat on it. Several different size bottles with different length pendulums are on table. Spectators concentrate on which weight they desire to swing. In many cases, unconscious hand movements will be in such rhythm as to start desired pendulum swinging without affecting the others.

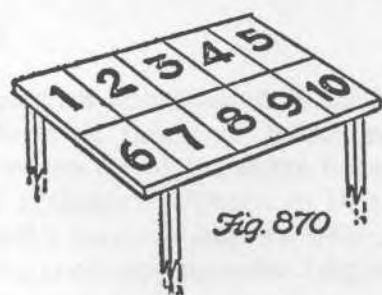

4. Table top can be used as coding device for sending information to assistant. Example: table is mentally divided into numbered sections (Fig. 870). Someone thinks of number from 1 through 99 while assistant waits in another room. You write it on slip of paper, put folded billet to forehead to "send" message, then toss pencil and billet on table. Position of pencil indicates first digit, position of billet the second. You leave room, assistant comes in, glances at table, gives number. (Nate Leipzig contributed this to "Strand" magazine in 1906, Vol. 32, p. 642).

5. The following nine objects are placed in front of someone at a dinner table.

1. Fork (or dime).
2. Spoon (or penny, or match).
3. Pencil (or napkin).
4. Ash tray (or quarter).
5. Bracelet (or envelope, or match box).
6. Cigarette (or toothpick).
7. Salt shaker (or half dollar).
8. Fountain pen.
9. Handkerchief.

Give impression that you picked these objects at random, though actually each spells with one more letter than previous one. Spectator thinks of one object, spells it to himself while you tap the objects, apparently at random. When he completes the spelling he calls out "stop" and you are always tapping chosen object. Make first three taps anywhere, then tap the nine objects in order. Doesn't matter if he spells "salt shaker" as "salt cellar," or "half dollar" as "fifty cents" because letter counts are the same.

6. Ask victim to crawl under table. Tell him you will knock three times. Bet that he will come out before the third knock, although you promise not to touch or harm him in any way. Simply knock twice, then don't knock again until he comes out! Naturally, he won't care to stay there for hours.

#### TABLE CLOTH

1. Silly sight bit. Stick your head under table cloth in imitation of photographer taking a portrait. Motion with your hands and say, "Stand back just a few steps and smile, please."

2. Fraternity house prank. By lifting up table cloth in front of where you sit at table, you form a trough in the cloth. If you surreptitiously pour a bit of water into trough, it will run down trough and pour into lap of victim sitting next to you. At long banquet table, with cooperation of other sadistic guests, a longer trough can be found for dampening victim seated several chairs away from you.

3. Penetrations of knife through hank or jacket

#### COMMENTS AND ADDITIONS

Source:

Date:

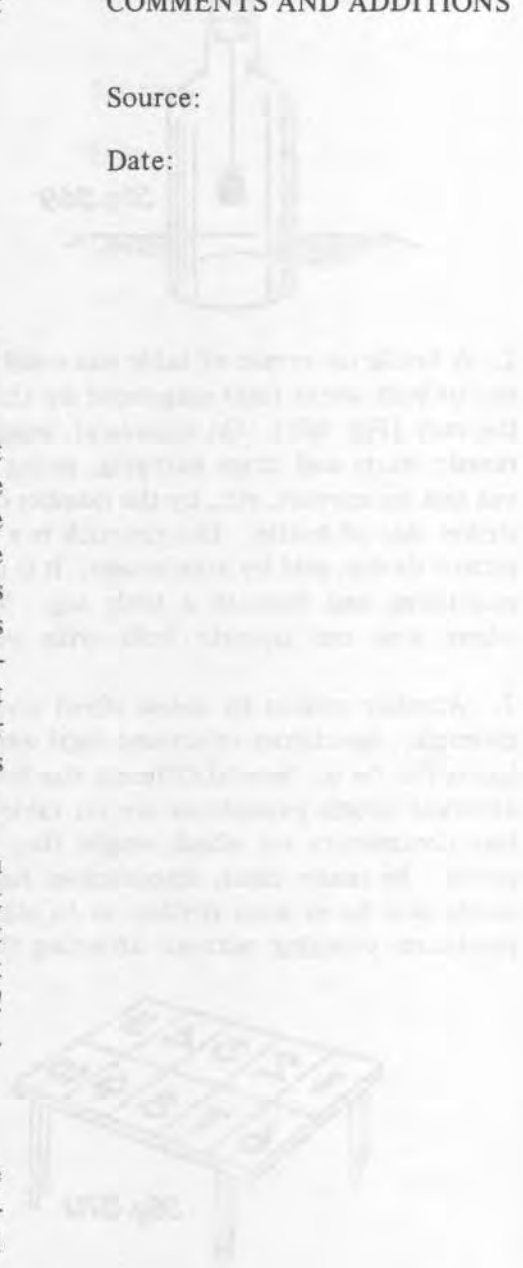

can be done at table with the table cloth. Here is a simple method used by Jerry Andrus. Left hand lifts up edge of table cloth. Right hand, holding knife, pretends to put knife under center of tablecloth, but as it passes left hand it leaves knife clipped by left fingers. Right index finger is raised to simulate knife under cloth. As right finger moves forward, forming a tall "hill" in the cloth, left hand, with knife, comes forward to seize center of cloth, carrying knife with it but concealed behind the "hill." As left hand appears to grasp knife through the cloth, the knife is transferred to right hand which then appears to push it up through the cloth.

### TENNIS BALL

1. Stewart James' "Love-Sick Tennis Ball," TOPS, Dec., 1940. Ball is placed in a box, open at one end. Magician stands across room, utters the mating call of the tennis ball. Ball rolls out of box, across table, drops on floor and rolls to his feet. Ball has a pin hole that lets air escape when you push with thumb to form a depression. The depression allows ball to remain on a slope until it slowly regains its rotundity which starts it rolling. A large unprepared box placed on its side, back end resting on something (say the cover of the box), creates the slight slope required.

### THIMBLES

Thimble tricks are rather recent in the history of magic. The basic sleight of thumb palming a thimble from the tip of the index finger was attributed by Professor Hoffmann to David Devant but in Devant's autobiography he writes: ". . . I have an awful confession to make—I did not invent the thimble trick." The move was shown to Devant by Baron Canitz, of Vienna, although Devant was first to introduce it in England.

The reader who is interested in thimble sleights, which cannot be covered here, may find helpful the following checklist of basic reference.

"Later Magic", Professor Hoffmann, 1904, Chapter XII.

"Magic Without Apparatus", Gaultier, pps. 463-515.

### COMMENTS AND ADDITIONS

Source:

Date:



"Tarbell Course in Magic", Harlan Tarbell, Vol. 4, pps. 73-110.

"Hugard's Modern Magic Manual", Jean Hugard, pps. 220-235.

"It's Easier Than You Think", Geoffrey Buckingham, London, 1952.

"Thimble Magic", Jean Hugard, 1936.

"Loyd's Master Manipulation of Thimbles", E. Loyd Enochs, 1931.

"Tantalizing Thimbles", Warren Wiersbe, 1948.

"Latest Thimble Magic", Duke Stern.

"Thimble Manipulation", Edward Victor (Willane's "Methods for Miracles", series, No. 13).

"Triple Thimble Act", Samuel Berland.

"Proudlock's Routine with Thimbles", Edward Bagshawe.

"Thimble Trix", Chester Dobski, 1955.

## COMMENTS AND ADDITIONS

Source:

Date:

1. Thimble filled with water is placed under hank. When hank is removed, thimble is empty. Simply pour the water down your shirt sleeve.
2. Miniature cups and balls routine can be worked out, using three thimbles and tiny sponge balls, match heads, etc.
3. Plastic thimble, dropped in soda water, will mysteriously rise and sink, rise and sink, as long as there is sufficient fizz in the water.
4. Cigar can be used for secretly conveying thimble to mouth. It goes on end of cigar from thumb palm position, cigar is popped into mouth, hands shown empty.
5. An effective color change makes use of the jumping cigar band move (CIGAR, No. 9). Begin with say, blue thimble on middle finger, red thimbles on first and third fingers. Rest first and second fingers against left arm as in Fig. 871. Right hand makes a quick motion to right and returns to arm. Under cover of the motion, extend third finger and bend down index finger. The effect is that of an instantaneous exchange of thimbles.

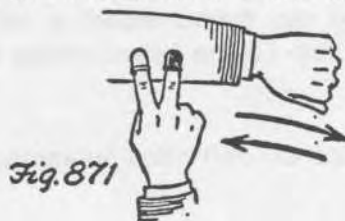



6. Thimble is tossed in air, caught on tip of finger as it falls. A duplicate thimble is secretly thumb palmed before the toss. Falling thimble is simply caught and finger palmed as index finger is extended with duplicate thimble on its tip.

7. An interesting effect is produced by wrapping small piece of tissue paper around tip of finger to make a small thimble-shaped cone. Cone is set on ashtray sand when ignited, it burns away to reveal thimble. Flash paper can also be used. Or form cone with tinfoil, then switch it for a metal thimble.

8. John Howie's ghost thimble. See Bruce Elliott's "The Best in Magic", p.20, for this unusual routine in which you convince audience that an apparently invisible thimble is really there by tapping it, popping it, and showing its solid form under a piece of tinfoil wrapped around it.

9. Four tiny objects, all different, are placed under four thimbles exactly alike. Turn your back while spectator lifts a thimble, peeks at object, replaces thimble. You turn around, identify chosen object. A tiny dot or other barely perceptible mark is on each thimble. Arrange thimbles in a row with the marks all in same position. When spectator lifts a thimble, he rarely replaces it without altering position of mark slightly. (Dr. Jaks, "Conjuror's Magazine", April, 1949.)

10. While your back is turned, spectator covers a dime with one of three large thimbles, then arranges thimbles in a row. You correctly guess which thimble dime is under. A hair attached to dime does the trick. Colored balls of tissue paper can also be used, with a long hair projecting on both sides of one ball, a hair on one side only of second ball, none on third. In this case you name color of ball under each thimble.

11. Magician names color of plastic thimble handed him behind his back. Take thimble in left hand, your right arm bent at right angles, hand in front. Turn left side to audience, looking over left shoulder to make some appropriate remark. At this moment, left forefinger (on which you have placed the thimble) deposits thimble in crotch of right arm (Fig. 872). Now turn to face audience. Rub

## COMMENTS AND ADDITIONS

Source:

Date:



Fig. 872

forehead with right hand as you glance down and note color of thimble. Reverse the procedure to return thimble to left hand as you turn your back



to audience once more. Thin magicians will have the least difficulty in mastering this stratagem.

#### Hank Penetrations

There are many methods for causing the apparent penetration of a thimble through the center of a handkerchief. Some require duplicate thimbles, specially prepared thimbles, or secret gimmicks. The following are standard impromptu penetrations in which only one thimble is used.

12. Display thimble on middle finger of right hand, holding hank in left as in Fig. 873. Bring the cloth

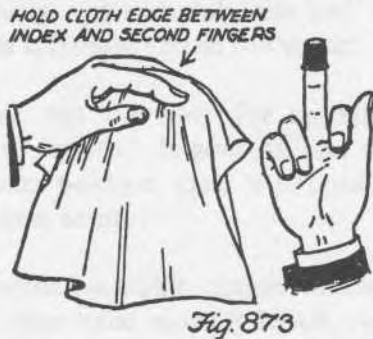

in front of right hand, lower middle finger and extend index. Tip of index finger goes against center of hank, then right hand is raised, carrying hank with it. As hank drapes over the first finger, left hand (still gripping edge of cloth between first and second fingers) is automatically brought to such a position (Fig. 874) that its thumb crotch can steal thimble from right middle finger (which is pointing directly toward you). Left hand moves away with thimble, then forms a fist around tip of index, grasping it through the cloth. Place

#### COMMENTS AND ADDITIONS

Source:

Date:

THIMBLE GOES TO  
THUMB CROTCH

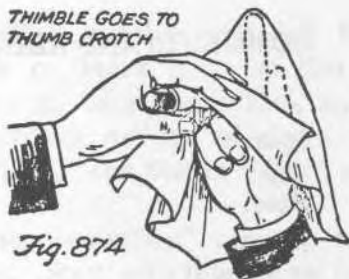

Fig. 874

thimble on index finger. Squeeze left hand a bit, then remove it to reveal the penetration.

13. Visible pop-through. Begin as in above method. After left hand has stolen thimble, it moves away allowing edge of cloth (which it had previously gripped) to fall down over right hand. Extend middle finger back toward you, under the hank. While you adjust the draped cloth with left hand, place the crotch-palmed thimble back on tip of middle finger as in Fig. 875. You now have only to give your right hand a shake, under cover of which you rapidly lower index finger and raise middle one. This pops thimble suddenly into view. The penetration is also effective if you first show left hand empty, then raise middle finger under cover of a downward stroke of hank by left fist.

THIMBLE ON THE  
OUTSIDE OF THE  
HANDKERCHIEF  
ON YOUR SIDE.

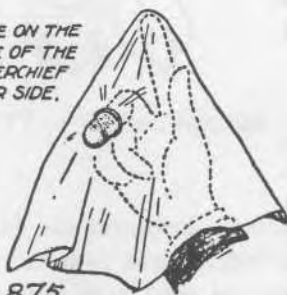

Fig. 875

Variant handlings of this move have been printed. See Edward Bagshawe's booklet, "Dleisfen's Visible Penetration of a Thimble", London, about 1937; Carlo Rossetti's version (first printed in a 1946 Italian book) explained by Bruce Elliott on p. 17 of "The Best in Magic".

14. Begin as in No. 12 above, except instead of stealing thimble with left hand, allow it to remain on middle finger. The cloth must be draped over this finger as in Fig. 876.

Show palm of left hand to audience (Fig. 876), then turn palm of hand toward you. Right middle

## COMMENTS AND ADDITIONS

Source:

Date:



Fig. 876

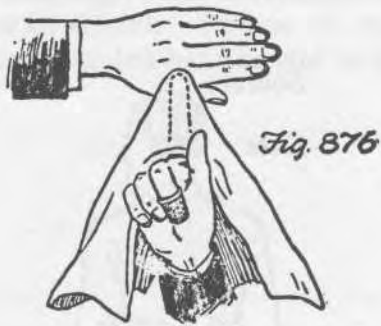

finger is now raised (Fig. 877) so that when left hand closes into a fist around index finger, it steals thimble and leaves it on tip of index. Middle finger immediately is lowered again. These actions will cause a slight motion of the cloth which should be concealed by a slight movement of both hands from side to side. Take away left hand to reveal the penetration.

An effective follow-up is to reverse these moves, sending thimble back to where it was previously. As left fist closes around thimble, right middle finger comes up and steals thimble (left hand simply places it on tip of middle finger). As before, a side to side movement of both hands will conceal the cloth movements caused by these actions. Squeeze left fist around tip of index, then remove hand to show thimble gone. As left hand removes hand, switch first and second fingers of right hand to disclose thimble on tip of upright middle finger just as when you began.

15. John Hamilton's pop-through. This begins as in above effect. After cloth has been draped over right hand (Fig. 876), left hand no longer plays a role in the effect. Under cover of a sudden shake, simply raise middle finger quickly to upright position (Fig. 878). From front it appears as if thimble has penetrated the cloth. Imme-

## COMMENTS AND ADDITIONS

Source:

Date:



diately adjust thimble with left hand, actually putting it on index finger so that right middle finger can go back under hank and thimble be shown actually on tip of cloth-covered index. (Bruce Elliott, "The Best in Magic", p. 15.)

A "reverse penetration" can also be handled by *this move*. Start with thimble on index finger of left hand in full view while left hand drapes hank over upraised middle finger of right. Switch fingers as this is done draping hank over index in such a way that middle finger can be raised in back of the cloth as in previous effect. Pretend to place thimble on the cloth-covered index finger, but actually place it on tip of middle finger as in Fig. 878. As left fist closes around thimble, right middle finger is lowered. Take away left hand to show thimble has vanished. Remove cloth, switching fingers as you do so, to show thimble on tip of extended middle finger. (This is similar to the reverse



penetration on p. 27 of Warren Wiersbe's "Tantalizing Thimbles".)

16. Chester Dobski has proposed that instead of popping thimble into view, as described above, the middle finger be raised in a bent position behind the cloth so that the thimble is just below top of hank. Then by straightening the finger slowly, audience sees a gradual emergence of thimble. This is best of course if a huge red thimble is used. You may also find the move easier by starting with thimble on index finger instead of middle one.

17. Another "slow penetration" is obtained by starting with thimble on tip of right thumb, the thumb extending upward from fist. As right hand is covered with hank, switch thumb for index finger. Drape the cloth over right hand so the thumb extends upward in back of the hank. By sliding the thumb upward, the thimble is pushed slowly into view as in the previous effect.

## COMMENTS AND ADDITIONS

Source:

Date:





Fig. 879



Fig. 880

18. "Well" penetration. Hank is thrown over left fist. Right index, with thimble on it, pokes cloth into left fist to form the familiar well. Thumb palm thimble as you remove the finger. Several moves may now be used for transferring thimble to left fist. The simplest is to place right hand below the cloth, then raise the edge nearest you and flip it up and forward over left fist. As soon as right hand is below cloth, thimble is taken from crotch palm by middle finger and transferred to left fist. Finish by pulling hank from fist (Fig. 879), then showing thimble in left hand.

Another transfer is managed by seizing right edge of hank (Fig. 880), extending middle finger under the cloth as shown so that left fist can steal thimble. Right hand then slowly pulls cloth to right until well is pulled out of left fist, showing that thimble is gone. Remove hank to disclose thimble in left fist or on tip of left index finger.

19. Another pop-through. Start with thimble on right index. Thumb-palm it as cloth goes over the hand. Drape cloth as in Fig. 881. Under cover of a shake, right index finger bends down, picks up thimble from thumb crotch, straightens up again.



Fig. 881

THIMBLE IN THUMB CROTCH

COMMENTS AND ADDITIONS

Source:

Date:



If you prefer, this move can be made under cover of left hand as it forms a fist around tip of finger, or strokes the cloth downward.

20. Same as above, except cloth is allowed to hang



on all sides of hand. If silk is used, or if thimble is sufficiently loose fitting, you can bend index finger down as before, picking up thimble from crotch palm through two thicknesses of cloth as shown in Fig. 882. As you straighten finger, toss rear side of cloth forward over the finger, bringing hand and hank to Fig. 883. From front the thimble appears to have penetrated the hank. If any reader knows the inventor of this odd, little known method, I would like to hear from him.

## THREAD

1. Gypsy thread trick. This classic effect consists of cutting or breaking a long piece of yarn or cotton thread (basting thread works well because it can be broken easily by the hands) into many pieces, rolling them into a ball, secretly switching for ball of unbroken thread, then pulling on the ends to show thread restored. An early description will be found in Sachs' "Sleight of Hand", a modern version in George Kaplan's "Fine Art of Magic". See also "Tarbell", Vol. 5, for John Platt's handling.

2. A finger ring is suspended by a cotton thread. Thread is ignited. Although it burns completely, the charred thread will continue to support ring.

## COMMENTS AND ADDITIONS

Source:

Date:

3. Practical joke. A spool of thread (the color should contrast with your suit) is placed in inside coat pocket. With needle, run free end of thread through front of coat, allow an inch or so to hang outside. When friend offers to pick off what seems to be a loose thread, he finds the thread to be of endless length.

### THROAT

1. Dick Stoner, Fort Wayne, Ind., thought of this gag. As you talk, your voice becomes hoarse. Apologize for frog in your throat, reach deep into mouth, extract tiny rubber frog of type sold as fishing bait.

### THUMB-TIE

One of the most effective of stage tricks and also one that can be performed impromptu in the parlor. Performer's thumbs are bound tightly together with cord, wire, pipe cleaners, tape, adhesive tape, etc. Various inexplicable penetrations take place, such as passing the hands over spectator's arm, one hand on each side, catching hoops on the arms, and so on after which thumbs are examined and found still securely tied.

Dozens of methods have been proposed. In my opinion, the best is the original cord version featured by Ten Ichi, and later by such well known performers as Carl Rosini, Paul Rosini, and Dai Vernon. The method is described fully by Vernon (along with many other Vernon specialties) in his book, "Dai Vernon's Book of Magic."

For other methods see "Tarbell", Vol. 4, p. 263f; "Sixteen Thumb-tie Gems", by Max Andrews; Jean Hugard's cord version using the grandmother's necklace principle, HMM, Sept. 1952; Joe Berg's adhesive tape method (glycerin is rubbed on one thumb to prevent tape from sticking), "Here's New Magic", by Joe Berg. See RUBBER BAND, No. 2, for still another method. An ingenious version is detailed by Jay Marshall in his booklet, "The Japanese Thumb Tie".

### TISSUE PAPER

1. Japanese butterfly trick. Performer tears a piece of colored tissue to form one or more small paper butterflies. By means of a fan he causes them to

### COMMENTS AND ADDITIONS

Source:

Date:



flutter here and there, settle momentarily on flowers or on the fan, elude attempts at capture with his free hand, etc. They may fly into a box, magician closes lid, but when box is opened, out they fly again. For a climax, they may fly into candle flame and be consumed, or go up in a flash if formed from flash paper; they may be seized by performer who then pours from his fist a shower of gold dust or releases a cloud of paper butterflies that scatter everywhere.

It is a beautiful trick when skillfully executed, giving the impression of great juggling skill. Actually, the feat is not difficult and is accomplished with the aid of thread. The butterflies must be joined by thread to each other, and one thread several feet in length connects them to performer's coat button, mouth, or ear. It is possible to keep two butterflies in the air even though they are not connected to performer, provided they are attached to each other. For details see Sachs' "Sleight of Hand", Chapter 6; Houdini's "Paper Magic", Jean Hugard's fine routine, HMM, March, 1956.

2. Paper snow. A piece of colored tissue paper is torn into small fragments which are dropped into a bowl of water. The wet pieces are formed into a ball, water is squeezed out, and when fanned, turn into a shower of colored confetti or small paper butterflies. The load is usually carried on underside of fan where it can be easily secured by left hand when the hand is fanned. Louis Tannen has suggested attaching load to bottom of glass or bowl of water in which torn pieces are dipped. See "Tarbell", Vol. 1 p. 301; Jean Hugard's version on p. 247 of Thompson's "My Best".

3. Tissue paper, rolled into a cylinder and ignited at upper end, will rise into the air as it is consumed. A pretty restoration is achieved by securing a folded duplicate piece in right hand, producing it after grabbing the floating ashes.

4. Torn and restored strip. See "Tarbell", Vol. 1, p. 297, for the most widely used version in which duplicate strip is rolled into ball and pasted to back of strip that is torn. A striking restoration effect is to switch torn pieces for a pleated strip that can be fanned in one hand as in Fig. 884 to simulate many

## COMMENTS AND ADDITIONS

Source:

Date:





pieces. When piece A is pulled from hand, the pieces seem to join magically. Many techniques for switching the torn pieces for duplicate strip have been worked out, both with and without thumb tips and other gimmicks.

5. Torn and restored sheet or sheets of colored tissue. See NAPKIN, PAPER, No. 1. Instead of restoring the sheets, they may be opened at finish to reveal a paper flag, hat, bunny, etc. This, of course, calls for extensive preparation. See "Tarbell", Vol. 1, p. 316, for the popular tissue paper to hat routine.

6. Old Japanese trick passed on to me by Randi. Tear a small butterfly shape from tissue paper, make crease down center, moisten the crease, stick butterfly on tip of shoe. The wings of butterfly now mysteriously flap up and down. Accomplished by a plate lifter, its end cut off. The tube is sewn inside trouser leg so open end of tube is at front of pants cuff where it can blow on top of the butterfly wings when bulb is squeezed in your trouser pocket.

## TOES

1. Spirit raps. The Fox sisters, who founded modern spiritualism, eventually confessed that they produced their raps by cracking their toes. This is often described incorrectly as a snap similar to a finger snap, one toe sliding off another. Actually, it is a popping of toe joints, produced by curving a toe and pressing its tip against floor. Apparently this ability is possessed by only a very few people.

## TONGUE

1. Tongue gymnastics. "The Journal of Heredity", Sept.-Oct., 1952, reports on these four tongue stunts, with photographs and bibliography of previous research. The ability to perform them is hereditary. They are listed here in increasing order of difficulty. No one has been found, the article states, who can do all four of them.

A. Sides of tongue curl up to form a tube without the aid of pressure from lips. Most people can do this.

## COMMENTS AND ADDITIONS

Source:

Date:



B. One side of tongue is raised, other depressed, causing tongue to twist sharply in one direction. Then tongue is twisted in same manner in opposite direction. In other words, tongue is rolled rapidly like a rolling pin, first on one side then on the other. One person in 3 can do this.

C. Tip of tongue is folded back so it lies flat on tongue (Fig. 885). Three in 100 can do this.

D. Tip of tongue is rolled in a curious manner resembling a clover leaf (Fig. 886). Three in 100 can do this also. Apparently it can be done only by those who can do stunt B.



2. Popular children's stunt. Twist one ear, at same time sticking out tongue as though the ear twist caused tongue to emerge. Tongue is sent back into mouth by twisting other ear or by pulling on flesh at front of neck.

3. Announce that you can stick out your tongue and touch your ear. Accomplished by sticking out tongue, touching ear with your finger.

4. By curling lower lip downward and end of tongue upward over upper lip. Ubangi lips are formed.

5. It is possible to form a small bubble of saliva on the tongue, then stick out tongue and blow the bubble into the air. If this is done while mouth is filled with smoke, resulting bubble will be white in appearance and will release a puff of smoke when it bursts in the air. This ridiculous stunt was performed by Harpo in the classic Marx brothers film "Animal Crackers".

## COMMENTS AND ADDITIONS

Source:

Date:

## TOOTHPICK

## COMMENTS AND ADDITIONS

"Toothpick Quickies", by Bob Mc Allister, a 14-page booklet, was published in 1960.

Source:

Date:

1. Pulse indicator. Grip one pick tightly between thumb and forefinger. Second pick is placed so one end is held by ball of thumb, other end rests on top of first pick (Fig. 887). Note that first pick lies across nail of middle finger. Press pick firmly against this nail then force it toward you in direction shown by arrow. The pick will slide across nail in a series of imperceptible jerky movements. With each movement the free end of second pick will mysteriously jump upward a short distance then fall back on first pick again.



An amusing presentation is to hold someone's wrist with your left hand as though feeling his pulse. Right hand causes pick to hop in the rhythm of a pulse beat. With practice you can regulate rhythm, causing it to slow down, then speed up in response to such questions as "How's your girl friend?"

2. How the Devil got his wife out of bed. Five wooden picks of the flat variety can be arranged as in Fig. 888, or six picks as in Fig. 889. Place the "bed" on a plate, then set fire to it at spot X with a match. When the flame reaches the first intersection there is a loud snap and all picks fly into air. "Spring mattress," you explain.

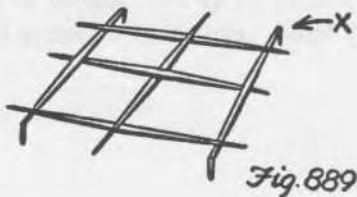
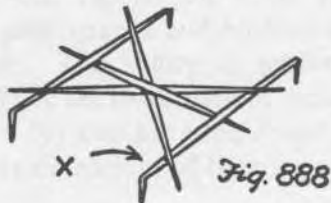

Bill Nord suggests combining this with card disclosure. Double lift to show wrong card on the "bed." Ignite. The picks snap card into the air, changing it to selected one.

3. Put one pick in mouth, keeping second concealed in right hand. Reach up to take pick, actually tonguing it as you leave second pick between lips. (If pick is too long to tongue, break off a portion to make smaller.) Remove pick from lips and hold one end against chin as in Fig. 890. Pretend to push pick into chin, letting it slide back into hand. At same time, tongue forces original pick out through closed lips. As left hand takes pick from mouth, lower right hand and drop other pick on floor.



*Fig. 890*

4. Silly sight bit. Break off piece of toothpick about  $\frac{1}{4}$  inch long and press broken end against forehead. When you remove hand, the piece will stick to the flesh. Continue breaking off pieces and sticking them here and there on your face until you have them projecting from forehead, nose, cheeks, chin, etc. Say, "I'm a porcupine!" or hiccup and remark, "I'm toothpickled!"

5. Prepare a pick by attaching a weird assortment of string and bits of colored cloth to one end (the stick is notched and the cloth and string attached by tying it on with thread). After a meal, pick your teeth with this pick, keeping prepared end concealed in hand. At opportune moment reverse the ends. Pretend to find something ledged between teeth, grimace as you pry vigorously, then remove pick and display uncouth "catch."

## TROUSER

1. Pocket concealment. A small object (rolled up hank, card, etc.) can be concealed in trouser pocket by pushing it into top corner of pocket. Pocket can now be shown empty by turning it inside out.

## COMMENTS AND ADDITIONS

Source:

Date:



2. Pocket transfer. Cut slits at top corner of each trouser pocket. You can now transfer secretly from one pocket to the other such objects as cards, pencils, fountain pens, etc. A useful stratagem in many effects.

3. Cut and sew right trouser pocket so you can enter it via watch pocket. There are many uses. E.g., selected card is palmed and carried to trouser pocket, later produced by taking it from watch pocket.

4. Sight gag. With a loose stitch at front and another at back, baste an extra pocket lining to each trouser pocket. Turn the false pockets inside out and have spectators hold them firmly. Absent-mindedly step forward, leaving pockets in their hands.

### VACUUM CLEANER

1. If cleaner has blower attachment, the jet of air will suspend a ping-pong ball a foot or more in air, and a balloon will be suspended at much higher position. Both ball and balloon can be suspended together as in Fig. 891. Walk around room and the ball and balloon travel with you!

The blower also will produce a strong musical tone



when applied at proper angle to opening of an empty bottle or jug.

### VEST

1. To remove a person's vest without removing his coat. Tuck left side of coat into left arm hole of vest from outside. Work arm hole over his left shoulder, down over the arm and hand. Hole will

### COMMENTS AND ADDITIONS

Source:

Date:

then circle coat in back of left shoulder. Work hole toward right shoulder, pass it over the shoulder, arm, hand, and right side of coat. Vest now hangs on right shoulder beneath coat. Push it halfway down right coat sleeve. Reach up sleeve, seize vest, extract it through sleeve.

2. Inside-out. Spectator wears vest but no coat. He clasps hands or they are tied together with rope. To turn vest inside-out, unbutton it, lift it over his head and let it hang on arms. Turn inside-out through one arm hole, return it to his body.

If he wears coat over the vest, the feat can still be performed. Remove coat, allowing it to hang on arms. Turn vest inside-out as before, passing the arm holes over the coat. Return reversed vest to his body, then put coat back in place again.

3. Loop of rope or cord goes over person's arm and he hooks thumb in lower vest pocket as in Fig. 892. Problem: remove loop. Done by pushing it through other arm hole, then over the other arm. Loop now circles his chest beneath vest. Lower it to floor and he steps clear.



Fig. 892

4. Bet someone he can't button up his vest in one minute. Chances are he loses by buttoning vest from top down instead of "up" as you requested.

#### WATCH

Samuel Berland has published a booklet titled "Tricks with Watches", and sections on watch tricks will be found in Sach's "Sleight of Hand", Hoffmann's "Later Magic", and Hugard's "Modern Magician's Manual". These references deal however, mostly with stage and apparatus effects.

1. Borrowed watch is handed to someone with re-

#### COMMENTS AND ADDITIONS

Source:

Date:



quest that he set the hands then give watch to you behind your back. Without seeing it, you correctly name the setting. Method: secretly attach to face of watch a small slip of paper saying, "We can have a laugh with this if you will help me out and set the hands at ten minutes after eight." Behind your back, remove slip so watch can later be returned to owner.

There are more legitimate methods. The following, by Don Nielsen, appeared in "Pallbearer's Review", 1966. Take watch behind back, secretly push it up under coat and hold with right arm near armpit. As left hand reaches into inside jacket pocket to get pencil and pad, pick up watch, note the time, and drop watch down right sleeve. Write the time on pad, put the sheet face down on table, lower right arm to let watch drop to hand as right hand puts watch on top of the sheet.

2. With practice, the ticking of a watch can be perfectly simulated by pressing together the tips of thumb and first (or second) finger, then clicking the nails slightly in the rhythm of ticking. There are many uses. For example, pretend to put watch under hank but actually palm it out or drop down sleeve. Twist hank into ball, hold it to someone's ear and let him hear the ticking. By grasping hank with curled first finger, middle finger is free to meet thumb and produce the fake ticking. Watch is then vanished. See also Nos. 10 and 18 below.

3. Magician demonstrates uncanny ability to gauge time by telling spectator (who is watching the second hand of a watch) precisely when three minutes have passed. Stand with hands behind back and feel your pulse. Prior to showing, count your pulse beat (which may vary from day to day) and determine the count on which three-minute period ends.

4. Spectator sets watch to any desired hour, magician places it face down on table, assistant enters room and correctly guesses the setting. Place watch so stem points to the hour on imaginary dial with an agreed-upon direction for 12.

5. A small alnico magnet held against watch will cause it to stop. Only a cheap watch should be

## COMMENTS AND ADDITIONS

Source:

Date:



used because parts may become magnetized and a good watch can be badly damaged. Several presentations are possible. For example, magnet is concealed inside cigarette. Watch stops mysteriously whenever cigarette is placed across it.

#### Mathematical

6. Spectator thinks of number on watch dial. You tap the number with a pencil and on each tap he counts silently to himself beginning with chosen number on first tap. When he reaches 20 he calls out "stop." Your pencil is resting on chosen number. Make first eight taps at random, then tap 12 and continue counter-clockwise around dial.

Repeat; this time letting him call stop on any number higher than 20 which he must announce in advance. Simply subtract 12 from number. This tells you how many random taps to make before starting the counter-clockwise series.

An interesting variation in which all taps are apparently at random is as follows: Say, "You are thinking of an even number, are you not?" If so, proceed as in standard version, with spectator starting the count on his number and stopping you when count reaches 20. Make first eight taps at random, tap 12, then a random tap, then 10, random tap, 8, random tap, and so on, tapping at random between each even number as you proceed counter-clockwise. The random taps conceal fact that even numbers are being taken in descending order. If his chosen number is odd, make nine random taps, then tap 11, random, 9, random, 7, random, etc.

7. Spectator thinks of a number, preferably under 50 to make trick faster. Ask him to roll an imaginary die and note the number that comes up without telling you what it is. (Of course he can also roll a real die, keeping it covered with his hand). While your back is turned ask him to start tapping on watch dial at the number indicated by die, tap clockwise until his count reaches the original chosen number. The hour on which the count ends is jotted down. He then repeats this procedure, starting with same number on dial but this time counting counter-clockwise. The two hours are added and the total called out. You then name the number on die. Method: if total is under twelve, halve it; is over 12, subtract 12, halve the result.

#### COMMENTS AND ADDITIONS

Source:

Date:

## Stunts and Gags

## COMMENTS AND ADDITIONS

8. Bert Allerton thought of this. If you remove balance wheel from watch, the hands will spin rapidly whenever watch is wound. At appropriate moments, wind watch and make such remarks as, "Time flies," "Are you in a hurry?" "This pace is killing me."

Source:

Date:

9. Pretend to put watch in lower vest pocket but slide it into finger palm with thumb. Produce from beneath vest. Explain that you have a hole in that pocket. Place watch safely in pocket on other side.

10. Borrow watch, wrap in hank but substitute a bunch of small keys on a ring. Hold to owner's ear so he can hear it tick, using method explained in No. 2 above. You can now slam hank against edge of table and keys will sound as though watch is being smashed.

11. When someone asks, "Do you have the time?" glance at your watch, say only "Yes," which of course answers his question.

12. The Great Ballantine has popularized this sight bit invented by Howard Brooks. Wear a reel tape measure on your wrist. When someone asks for the time, pull out tape, say, "Twenty inches after four."

13. Another Brooks sight gag. Pull watch chain from pocket to reveal rubber bathtub stopper on end.

14. The rubber coin illusion (COINS, NO. 103) works well with borrowed pocket watch. "Hmm," you can remark, "one of those new plastic watches."

15. Wear wrist watch on a band of stretchable type. Show left hand empty, cover it with hank. Say "Watch!" As you remove hank, right thumb hooks over band and carries watch to left hand where it is displayed after cloth is removed.

16. Wrist watch is on stretchable band. Put watchmaker's glass in one eye, then pull watch up from wrist as high as you can, bringing it close to eye-piece so you can inspect it and give the time.

17. Someone asks for the time. Pull up pants leg and glance at watch (or clock) attached to leg. Or wear wrist watch high on left arm. Take off jacket, look at watch, replace jacket.

18. Small children are amused by this. Draw a watch on sheet of paper, then hold picture to

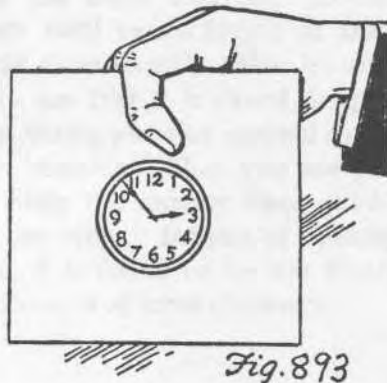

child's ear (Fig. 893) so he can hear it tick. Ticks are produced behind paper with nails of thumb and second finger as explained in No. 2 above.

19. Ask someone for the time and note if his watch dial lacks figure 6, because of the second hand. If so, as a test of observation ask him to tell you if the six is an Arabic or Roman numeral without looking at his watch again. He'll be surprised to find no six at all. If his watch has Roman numerals, ask also if he can tell you how the four is formed. Most people guess IV, but most watches and clocks use IIII.

20. A watch can be used as a compass. Hold it flat, point hour hand toward sun. (Fig. 894). Imagine a line running from center of dial through a point midway between hour hand and 12. This line will point due south. If the time is before six in the morning or after six in the afternoon, this line points north instead of south. If you are south of equator, these rules are reversed.

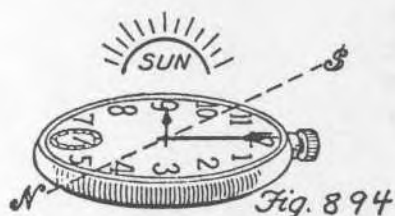

## COMMENTS AND ADDITIONS

Source:

Date:

## WATERMELON

1. Close your eyes, stick a wet watermelon seed on each eyelid to produce comical effect of small beady eyes.
2. While munching a long slice of watermelon, palm a handful of seeds. Complain of getting watermelon in your ears. Bend head to one side, shake ear with hand and allow palmed seeds to drop out.

## WHISK BROOM

1. Place a small coin on center of palm and try to brush it off with whisk broom. Can't be done.
2. Stand behind someone. Brush his back several times with whisk broom, then brush yourself, at same time running your free hand down his back. He will not be able to detect the change. If you have occasion to brush someone's back while others are watching, an amusing bit is to brush only yourself in this manner. The victim believes, of course, that his own back is being whisked.
3. Nylon whisk brooms acquire strong static charges when brushed on clothing. See COMB for static stunts that can be done with whisk brooms instead.

## WINDOW

1. At night, window panes become mirrors and can be used occasionally on unsuspecting spectators for learning their chosen card, a number written on a pad, and so on.
2. Norman Jensen thought of this: Before boarding a train or subway, make a small X with your finger on the outside of a dusty window by a vacant seat. Go inside, take this seat. Later, if you have occasion to show someone sitting with you a trick, make a series of X's on the window, one being directly over the X you previously drew outside. Let him choose an X, forcing the desired one by "magician's choice." Erase all the X's and only his chosen one remains on the window.

## COMMENTS AND ADDITIONS

Source:

Date:





## ZIPPER

1. A briefcase, lady's bag, and other objects or items of clothing with a fairly long zipper can be used for this. First open the zipper. If you begin at the end opposite the sliding piece, you'll find it possible to lock the sides by bending each side so that the teeth open as far as possible, then meshing the teeth together. Continue meshing the teeth until entire length of zipper is closed. This is all done secretly. Now let someone inspect zipper to see that it is closed, keeping your hand over the sliding piece to conceal a slight gap alongside it. Announce that you are going to zip it open. Slide the moving piece quickly from one end to the other. Instead of opening the zipper, however, it is found to be still firmly locked, to the puzzlement of most observers.

## COMMENTS AND ADDITIONS

Source:

Date:

# INDEX

573

Introduction	5	Face	156
Apples	7	Feather	158
Arm	8	Fire Tongs	158
Balloon	11	Fork	159
Banana	15	Fountain Pen	160
Beans	16	Funnel	162
Beer	16	Glasses	162
Belt	17	Gloves	178
Bill	17	Grape	178
Bill Folds	26	Grass	178
Book	27	Gum	179
Book Tests	29	Hair	179
Bottle	32	Hands	180
Bottle Cap	38	Handkerchief	218
Box	38	Hat	267
Bracelet	39	Horn	274
Bread	39	Ice	274
Brick	40	Key	275
Broom	41	Knife, Pocket	276
Brush	43	Knife, Table	279
Button	44	Legs	295
Cabbage	45	Lemon	296
Calendar	45	Life Savers	297
Candles	47	Light Bulb	297
Cane	48	Light Switch	297
Capsule	49	Lipstick	298
Celery	49	Magazine	298
Cellophane	49	Maple Seed	299
Chair	50	Marbles	299
Chalk	52	Matches	302
Checkers	53	Matches, Paper	321
Chess	54	Matches, Wood	345
Cigar	54	Milk	378
Cigarette	60	Milk Carton	378
Cigarette Lighter	78	Mirror	378
Cigarette Paper	79	Mnemonics	385
Clothes Pin	80	Muscle Reading	392
Coat	81	Nail File	396
Coat Hanger	83	Napkin, Paper	397
Coins	85	Necktie	402
Comb	131	Needle	403
Cork	132	Newspaper	406
Cracker	133	Nose	412
Crayon	134	Nuts	413
Cup (Coffee)	135	Olives	414
Cup (Paper)	137	Oranges	415
Dice	138	Overcoat	416
Dominoes	147		
Doughnut	149		
Ears	150		
Egg	150		
Envelope	155		

Paper	417	Vacuum Cleaner	564
Paper Folding (Origami)	428	Vest	564
Paper Bag	444	Watch	565
Paper Clip	445	Watermelon	570
Pen	449	Whisk Broom	570
Pen Point	449	Window	570
Pencil	450	Zipper	571
Pepper	466		
Phonograph	466		
Pie	467		
Pin	467		
Ping Pong Ball	468		
Plate	469		
Plate, Paper	472		
Poker Chips	472		
Pool Table	476		
Pulse	479		
Purse	479		
Radish	479		
Rice	480		
Ring	480		
Rope	504		
Rubber Band	505		
Ruler	517		
Safety Pin	519		
Salt	520		
Salt Shaker	521		
Saw	521		
Scarf	521		
Scissors	521		
Shirts	524		
Shoe	525		
Shoelace	525		
Soap	527		
Spectacles	527		
Spool	528		
Spoon	529		
Stamp, Postage	532		
Sticker	533		
Stocking	533		
Straws, Soda	533		
String	537		
Sugar, Lump	540		
Swizzle Stick	545		
Table	546		
Table Cloth	548		
Tennis Ball	549		
Thimbles	549		
Thread	557		
Throat	558		
Thumb-Tie	558		
Tissue Paper	558		
Toes	560		
Tongue	560		
Toothpick	562		
Trouser	563		