

BARON
VON WELLING

a TREATISE ON: \triangle \ominus ♀



R A M S

a 1989 Production

A WORD ABOUT **R.A.M.S.**

R.A.M.S. , the Restoration of Alchemical Manuscripts Society is a very loosely knit group composed of private citizens around the world who have contributed to the present work and others in one way or another. The goal of the society is to seek out and obtain copies of Alchemical manuscripts, tracts, printed works and other such materials and literature. From these, certain items are selected for 'restoration'. This consists in re-typing the material to render it readable, therefore useable. The reading is made more enjoyable by the use of charts, symbols, dictionaries, diagrams, insertion of printed illustrations and other annotations to shed additional light on the text.

R.A.M.S. is a non-profit organization with members from all walks of life. There is no 'organization' per se, just individuals desirous of performing a labor of love. It is their hope that these efforts will perhaps result in renewed interest in the science of Alchemy or even contribute to new discoveries or fields of experimentation. While this material is for all on the path of Alchemy, it is particularly for the sincere practicing Alchemist.

The transcription of this material is as verbatim as human skills permit. The only exceptions are to make the matter more readable, or understandable, with some 'modernization'. This is done ONLY where it is judged that no ambiguity will arise from a slight departure from the original and there is no danger of deleting key words or phrases where a possible use of Gematria, Temura, Notariqon or other form of written code exists. Thus, mis-spelled or grammatically incorrect material is to be found as well as archaic or strange words. This is in an effort to maintain the original text as far as possible. The completed material is then reproduced, sometimes bound and offered to interested parties. The costs for these copies are used to defray reproduction costs and to obtain additional material for restoration.

The work of R.A.M.S. includes such material as "Last Will and Testament" of Basil Valentine, important selections from the invaluable Bacstrom Manuscripts such as "Golden Chain of Homer", "Lamspring's Process for the Lapis Sophorum", "The Chemist's Key", "The Mineral Gluten of Nitre and Sulfur", "Coelum Philosophorum" and others. Additionally, material by other writer's is or will be offered. Such writers as Flamel, Artephius, et al.

It is highly appropriate to acknowledge the many persons who have either materially or philosophically contributed to the present effort and future ones. For some this might well be the first indication that they are considered as members of R.A.M.S. or that such a group even exists! While the list is long, it includes: C. Collins, Rick Stern , K. Hellesoe, A. Joo, D. and J. Nintzel, N. Ogle, G. Price, F. Regardie, W. van Doren, K. von Koenigseck and especially David Ham. For their labors and contributions, grateful thanks are given. Let their unselfish efforts inspire others to light the fires of Alchemy.

To obtain copies of these materials, or to contribute in some way to this work, contact: **R.A.M.S.** c/o Hans W. Nintzel
733 Melrose Drive
Richardson, Texas 75080

PHILOSOPHY OF THE UNIVERSE
OR A GENERAL SYSTEM OF
CHYMICAL, METAPHYSICAL, & MATHMATIC
KNOWLEDGE .
IN WHICH THE ORIGIN, NATURAL PROPERTIES OF
THE THREE PRINCIPLES
OF
NATURE ARE FULLY DESCRIBED.
THE PRODUCTION & MATURATION OF METALS & MINERALS.
A COMPLETE TREATISE UPON THE WISDOM OF GOD & THE
EXCELLENCY OF NATURE.

WITH A GENERAL KEY ENRICHED WITH A GREAT VARIETY OF METAPHYSICAL,
MATHEMATICAL & THEOSOPHIC FIGURES. FORMING A COMPLETE TREATISE UPON
THE ABSTRACT & USEFUL ARTS & SCIENCES.

TRANSLATED FROM THE ORIGINAL GERMAN OF BARON GEORGE VON WELLING, AND
CAREFULLY CORRECTED AND REVISED BY:

FRANCIS BARRETT F. R. C.
(WITH ADDITIONAL NOTES & OBSERVATIONS)
PROFESSOR OF CHYMISTRY & NATURAL PHILOSOPHY.

L O N D O N J U N E 1 8 0 1 .

TRANSLATORS PREFACE.

As it may appear necessary to know who the Author of this Book is, & the Character he bore in the world, I have transcribed the Account given of him by FICHILD in his PROBIER STEIN, who was not very apt to Flatter. He wrote the Characters of all the Adept's, & of those that pretended to be so, & seems to have given them very fairly. He pretended himself to the Knowledge of the SECRET, and published several Treatises of Note upon it. He therefore has a good Pretension to give the Characters of these Writers. His PROBIER STEIN was published at FRANKFORT & LEIPZIG in 1753. He speaks as follows of our Author.

"Mr. GEORGE WELLING was of a noble Family in SUABIA, and was born in the County of WEISSENHEIME. He was once Director of the Mines in BADEN-DOURLACH and PRESIDENT OF THE REFORMED CONSISTORY there, both which Employments he quitted in 1723., and retired to BOCKENHEIM near FRANKFORT, where he died the 28th. of Feb. 1727, 75 years old, as his Second Son assured me.

He was a very Learned & ingenious Man, well versed in CABALISTIC, MAGIC & THEOLOGIC Knowledge and very Zealous for the Honor of his God, as may be seen by his Writings and Letters to his Friends. He left behind him, this MAGO-CABALISTIC Work in which he has admirably explained the ORIGIN, NATURE, & PROPERTIES & USE of SALT, SULPHUR & MERCURY, and formed SO GOOD AN HYPOTHESIS of them, that it were much to be wished every body would read it, and lead their Lives accordingly, and then CHRISTIANITY would have fair Play. And as this Work sets Vice in Detraction, and shews the Absurdities of failing in spiritual Duties, so it makes one lament the Contradiction and Prejudice of Mankind.

He has so clearly explained many things in the CABALA and written so candidly upon ALCHEMY that I have never seen his Fellow. Let incredulous and ignorant People laugh as they please, and disbelieve as they will, because they do not see a Man who possesses this Science abounding in Riches & great Possessions, but This Opinion of theirs, does not in the least lessen his Reputation, for if these MOCKERS think themselves sure of one thing, let them quietly leave to inform them of another.

That the Author first of all was a very HONEST AND RELIGIOUS MAN whose chief Study was the HONOR OF GOD, and the GOOD OF HIS NEIGHBOUR.

2ndly. Whether their own Salvation is as secure as these Men wished it, and if they have followed his Method of ascertaining it.

He could also say with JOSUA "I and my House will serve the Lord," We would also ask sincerely whether this Man might not have known by Practice what he treats of in

his Writings? And whether he had not sufficient Knowledge of them to put them in his Works? I Answer YES. Add to this; His Writings are recommended by all good & virtuous Men."

It will be proper & fair to subjoin a Character of this Author from Mr. Diederick Wessell Linden, another German Author who speaks as follows.

"I cannot help taking some notice both of the AUTHOR & EDITOR OF THIS WORK as I have the good Fortune to be acquainted with both these valuable Men.

Mr. Welling, who is dead was formerly Page at the Court of MERSEBURG in SAXONY and met with many Misfortunes, which he always bore with the greatest Resignation.

Among his other Misfortunes he had that of looking for the PHILOSOPHERS STONE, which I conceive to be among the GREATEST & he gave himself a great deal of Trouble in the Pursuit of it, and I believe had never the good Luck to find it, but in its Stead like many thousand others met with Disappointment & Poverty.

He lived for a long time in the GREATEST DISTRESS AT BOCKENHEIM near FRANKFORT, where he bore his Poverty with the greatest Firmness & Resolution, and it was at that Place he completed this Treatise upon SALT, SULPHUR & MERCURY, & I can aver with the greatest Truth, that he never intended to impose upon the World any idle Opinions, or to lead any body astray, and if it has ever been the Case, it was far from the Intentions of this very excellent Man.

The Editor is Mr. Christopher Scheuten at HAMBURG on the Hill. A very Honourable & conscientious Man and as far as I know, is still living.

He was a very charitable Man & loved his Neighbour, and he was said to be a Professor of true Science, whether it was so or not I cannot tell, I only know he was a very excellent Chemist.

He had also a very nice Judgement in Works of this Kind. And as he says in his Preface, He believes the very Marrow of Truth is in this Book, and tho' Jewels and false Stones are mixed together, he has endeavoured to repose to them as much as possible."

My Reason for taking the Trouble of Translating this Book, are First; The Curiosity of the Subject of it, and the Reputation I had heard of it from all those who were capable of reading it, as well as the Character given of it by FICTULD. The Subject is very interesting to those who can pay every Attention to those Mystical and very deep Inquiries into Nature, and the Operations of the Creator; both in the visible and spiritual World, and tho' these Subjects incorrectly held by the Learned in no Estimation, because they are not thought useful for the common Purpose of Mankind, who for the most Part see no further than their present State, and take their Chance for the rest, yet as it cannot be denied upon certain Principles, by any so

Character of Welling from another German Author.

1783.

Page 167. by the Rev. Hartly.

Cause of the Petitioners Examined.

Author.

of Men, that there is a future State, and that God, superintends all his works by his immediate Providence, it is certainly worth the while of those who are envious for their future Happiness to enquire as far as our human Abilities and the Penmanship of God admit of it into this great Mystery. The Result of which, must be an Acknowledgement of the Wisdom and Goodness of God, a Respect and Veneration of his Power, and a Religion to his will & provident Government of his Creatures. He will also learn how Nature operates in her first Principles, and be a good and profound Philosopher and Christian.

How far this Reasoning is just & true, I must leave to those who think it worth while to pursue this, and the rest of the Authors Works with Attention.

I cannot help inserting a Passage from a Work of a REVEREND DIVINE whom I had the Pleasure of being acquainted with, who was a Man of great Nobility and sound Christian Truth, where speaking of Alchemy, he says:

"Alchemy on the higher Chemistry exhibits to us very wonderful Resemblances of spiritual Things in such as are natural, a particularly in the Exaltation of the IMPERFECT into more PERFECT Metals; and the actual Transformation of one METAL into another inasmuch that the Regeneration of Metals prevents to us a surprising Similitarity of the Process of Our Spiritual Regeneration, where the Spectator has Judgment sufficient for the Application, and I cannot but observe I have at Times been much with Admiration, at what I have met with in the Hermetic Writings on this Subject; & could refer the Object to a Work of this Kind, were he fit for it; wherein the Process of the GRAND OPERATION in that Art is represented as figuring the Purification of the Soul, by great Aptness of natural Analogy: This however is observable that all celebrated Adepts in this Science, have been Believers in CHRIST, seeing in external Nature how the God of Nature reconciles, restores and perfects therein Things degenerate & corrupt & contrary, & that there is a kind of picturesque Conformity to things in spiritual Nature; nay, I could farther tell him upon credible Testimony, of a PERSON OF DISTINCTION now living, who, after having read the most noted of our controversial Writings on the Christian Religion without the desired Success (having a Turn for this Kind of Alchemy) being a sound Believer on pursuing the Hermetic

Baron Welling of the County of Wissenheim in SUABIA was Director of the Mines & President of the Reformed Consistory of the Margrave of BADER DUERLECH.

He was a very enlightened Man, & of a very penetrating Genius, who entered very deep into the Secrets of Nature, which he perfectly understood, & knew how to distinguish the good from the Bad. He was a true Exemplary of the ancient MAGI, CABALISTS AND THEOSOPHISTS of whom there is scarce his equal. He was particularly zealous for the Honour of God, which is proved not only by his Writings, but is well known from his private Friends & Correspondents. He worked with his own Hands, the GREAT SECRET OF NATURE, and of the ANCIENT MAGI which is the Key of true Wisdom, and is the Universal MENSTRUUM for the MINERAL, VEGETABLE & ANIMAL KINGDOMS, springing from ONE ROOT out of 2, WHITE AND RED Bodies, composed of the 3 Principles SALT, SULPHUR, & MERCURY & the 4 secret Elements FIRE, AIR, WATER, & EARTH, and since it has pleased ALMIGHTY GOD to set this Stock & Powers out of the wretched Garden of this World, and to place it in the Garden of EDEN, in that place and Land of Paradise where they rest, who wash their Garments in the BLOOD OF THE LAMB, & where they ascended with their Brethren on the 28th. Feb. 1727.

He has left this great Secret & Key of Nature as a Legacy to his Friends, when it has pleased God to preserve, & by his gracious Benediction to bring to such Righteousness as to enable them to follow their true Friend & Praiseworthy; Our Friends valuable Writings, as his Treatise upon SALT, SULPHUR & MERCURY, which our beloved Friend in God Mr. C.S., has published at his own expense, as he would have nothing to do with the Book-sellers.

Another Person Says:

We recommend these Writings to every bodys Perusal, in the Name of the FATHER, SON & HOLY SPIRIT, and you will obtain a wonderful Light, that will lead you to Eternal Happiness, which we most cordially wish you, Our Friend left some more of his Writings, but whether they have come to Light, is not known.

You have now all that I could collect of this Authors Character & Situation and I have given it to the Public in the best Garb I could dress it in so as to preserve the Plain and Sense of his Writings, and must leave to the Reader to judge as they please upon a Subject that is not for every Ones Contemplation, & now I leave it to its own Merits & shall be very much satisfied if it is well received, & so of any Use.

THE TRANSLATOR.

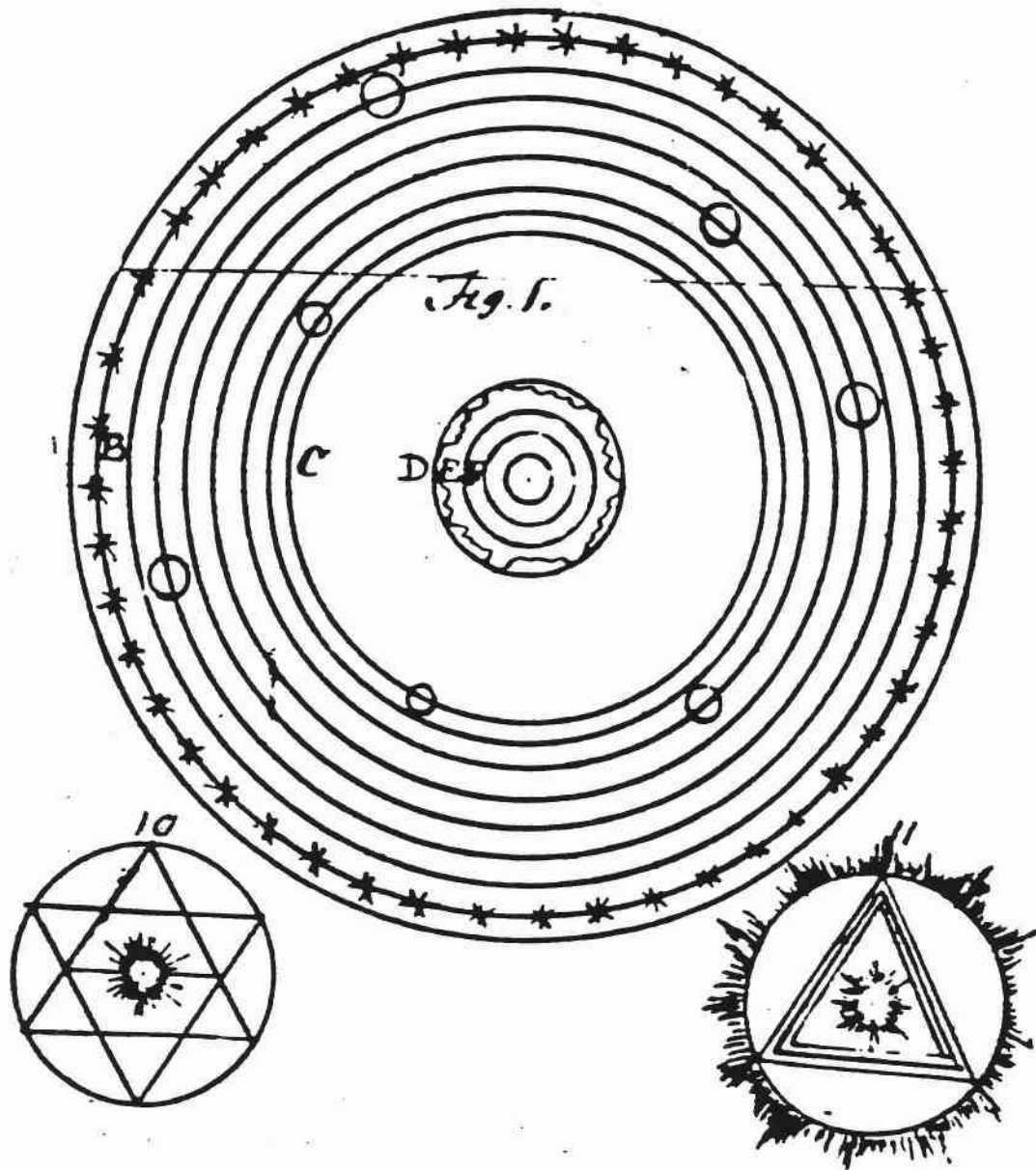

*The Magic Plan of the Universe by Ptolemy.
 Fig. 1. Chapter 1. S. 12.
 With Fig. 10 & 11.*

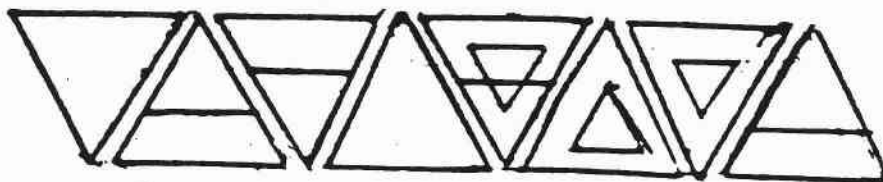

*Figures- 2 - 3 - 4 - 5 - 8 - 6 - 9 - 7.
 To be found in Chapter 2. S. 10.*

Table of Contents.

Translators Preface.....	i
<i>Of the Origin of the Three Principles.</i>	
<i>Part the First</i>	
<i>Of Salt Characterized</i>	
<i>Origin of Common Salt</i>	
Chapter 1.....	1.
Universal Mercury.....	3&4.
Perpendicular rays of Light.....	4.
Mercury out of the Air.....	4.
The Total Theory of Alchemy.....	8.
Universal Mercury.....	8.
Earth is made from Water.....	9.
Light & Darkness are Spiritual Substances.....	10.
Light in Water makes Earth.....	10.
The Vitriifying Principle comes from Water.....	10.
Experiment- Putrefied Water yields Earth & a Mercurial Essence.....	11.
Putrefied Water burns Like Brandy.....	11.
Light of the Sun exists in Water.....	11.
Medicine made from Dew.....	11.
All Water produces Sand & Stones.....	12.
An explanation of Metallic Veins.....	13.
Water is the First Matter of all Things & Virgin Earth is Silica.....	13.
All Sand contains spiritual Gold & Silver.....	14.
All Earthly things come from the Heavens.....	14.
Of the Central & Celestial Fire.....	15.
Water is digested to a Viscous Water.....	15.
The Poles of the Earth are Lunar, and the Equator is Solar.....	16.
Sal Alkali can be animated into Sea Salt (sodium Chloride) by the air and Sun.....	16.
Light can be concentrated to a Sulphureous Oil in Water.....	18.
Coal is made from Light & Water.....	18.
Proof that Sulphur is in Water.....	18.
Spiritual Gold & Silver in all things (which he calls red and white Sulphur).....	18.
Saturn & Jupiter converted to Quicksilver.....	20.

<i>Inflammable Sulphur is to be removed from metals, to purify them.....</i>	21.
<i>Quicksilver is Red & White Sulphur.....</i>	21.
<i>The purer the Matrix is, the purer the metal is.....</i>	22.
<i>A hint to ripen Mars, Venus, Saturn & Jupiter.....</i>	23.
<i>Why Saturn is so impure.....</i>	23.
<i>GUR.....</i>	24.
<i>Pit Coal is basis of Pyrites, & pyrites always contain Sol & Luna.....</i>	25-26.
<i>Salts are the red & white Sulphur.....</i>	26.
<i>Pure alkali is Salt of Metals.....</i>	27.
<i>That all Salts are infected with Sulphur, which makes the salt spirit acidic, remove the Sulphur, you have a sweet spirit of salt.....</i>	28.
<i>All things come from Salt, and are reduced to Salt.....</i>	28.
<i>A Simple Process for a Vegetable Stone.....</i>	29.
<i>To convert ashes totally to a pure Salt.....</i>	29.
<i>To reduce Gold into Salt by means of Mercury.....</i>	29.
<i>Common Sea Salt reduced to Water.....</i>	30.
<i>The Three Principles are Salt, Water & Sulphur.....</i>	31.
OF THE NATURE OF SALT. Chapter 2.....	33.
<i>A hint about a regenerated Salt.....</i>	33.
<i>All Things are created by Light & Water.....</i>	34.
<i>That Sea Salt has acid only as an accident, purified Salt is a transparent alkali.....</i>	37.
<i>How the Sulphureous acid gets into the Salt.....</i>	37.
<i>Purified Sea Salt is metallic Mercury.....</i>	38.
<i>No metal can be made without its matrix.....</i>	38.
<i>Sal Enixium.....</i>	38-39.
<i>Sal Enixium petrifies everything.....</i>	39.
<i>That Sal Enixium is made by fire & water from Sea Salt, and is a universal Medicine.....</i>	39.
<i>Sea Salt is the Basis of all other Salts.....</i>	42.
<i>How to make any alkali into Sea Salt.....</i>	42.
<i>A Hint how to precipitate metals by Water.....</i>	43.
<i>Sea Salt can be made into all other Salts.....</i>	45.
OF THE USE OF SALT. Chapter 3.....	51.
<i>A Medicine made from Calx viva and Salt (calx viva is Lime).....</i>	53.

<i>A Hint that the Embalming fluid of the Egyptians was</i>	
<i>Sal Enixium.....</i>	<i>54.</i>
<i>A Radical dissolvent of Gold & Silver by Salt.....</i>	<i>56.</i>
<i>A hint about Aqua Regis.....</i>	<i>70.</i>
<i>NOTE- S. 15 should be read very carefully, exposes</i>	
<i>much about Mars.....</i>	<i>71-72.</i>

Book Two

Mago Cabbalistici & Theosophici

The Second Part

Treating of Sulphur.

Chapter 1.

The Birth & Rise of the Heavely as well as the

Earthly Sulphur..... 80.

All things on earth contain Sulphur..... 81.

*NOTE: This S. should be read very carefully, he says metals are not trans-
mutable, but can be refined to Gold. i.e. S. 9..... 83.*

Chapter 2.

The use and properties of the Heavenly Sulphur..... 101.

A hint about Saturn & Neptune, i.e., Lead Chloride..... 105.

Washing metals with Nitre..... 105-a

Aurum Potabile to be made with new gold one..... 106.

Dissolving gold & silver by Water into a gum..... 106.

The true process compared to a Natural Process..... 107.

A hint of ripening ones by Lixiviums..... 109.

Aurum Potabile differs from the material it is prepared..... 110.

Red & White Sulphur..... 111.

The Third Chapter

Of the Nature & Advantage and Use of the Earthly Sulphur..... 114.

Red Oil of Antimony..... 116.

Fixed Oils of Salts made by Water..... 117.

Venus, Mars and Antimony graduates Silver..... 118.

Another hint of preparing ones by Lyes..... 120.

A Red Tincture from Hepar Sulphureous..... 121.

Silver fixed by the same..... 121.

A red Liquor made from Coal & Lixivium..... 122.

Increasing Venus by Sulphur..... 122.

<i>Sulphur of Mars as medicine; & in alchemy tinges Silver.....</i>	123.
<i>A description of how to change Mars into Venus.....</i>	124.
<i>Lapis Calaminaris & Arsenic tinges Venus to Sol & Luna.....</i>	124.
<i>Sulphur of Venus.....</i>	124.
<i>Mars is united to Venus through the Mediation of Saturn.....</i>	125.
<i>That Copper is to be changed from green to red before use as a Medicine.....</i>	127.
<i>A hint that green Venus is to be ripened to red by a pro- cess of changing to Vitriol.....</i>	127-28.
<i>Oil of Tartar & Sulphur of Antimony tinges Silver.....</i>	129.
<i>Tincture of Tartar (Sulphur of Tartar).....</i>	129-30.
<i>All things have 2 Sulphurs and can be separated.....</i>	132.
<i>The Use of Mumia in Magick.....</i>	133-34.
<i>Hint of Tincture of Human Flesh.....</i>	134.
<i>Tincture of Human Excrement.....</i>	134.
<i>The phlegma of excrement is mercury.....</i>	136.

Operis Mago Cabbalistici

Et Theosophici

Part III.

Of Mercurio.

*Concerning the Origin, Rise of the the Heavenly and
Earthly Mercurii.....*

<i>Quicksilver is a Sulphureous Salt.....</i>	140.
---	------

Of the Use and Advantage of the Heavenly Mercurii

<i>Chapter 2.....</i>	148.
-----------------------	------

<i>True Aurum Potabile is gold dissolved totally into a Liquor.....</i>	149
<i>An Explanation of why it Lightens and Thunders (by Phosphoris).....</i>	151-52.
<i>Gold & Silver from pebble stones generated in Water.....</i>	152.
<i>Common Quicksilver can be extracted from all metals & Minerals.....</i>	153.
<i>That gold is generated out of atmospheric Water.....</i>	153.
<i>Alkalis are MERCURY.....</i>	154-55.
<i>Secret of S.V. Tartaris. S. V. Tartaris is alcahest, extracts coloured glass.....</i>	156.

Of the Figures and Illustrations in the Texts.

<i>Figures 1, 2, 3, 4, 5, 6, 7, 8, 9, 10, & 11.....</i>	v.
<i>Figure 12.....</i>	60.
<i>Figure 13.....</i>	61.

<i>Figures 14 & 15</i>	62.
<i>Figures 16, 17, & 18. & 19</i>	65.
<i>Figures 20, 21, 22, 23</i>	66.
<i>Figures 24 & 25</i>	67.
<i>Figures 26, 27, 28 & 29</i>	68.
<i>Figures 30, 31, & 32</i>	69.
<i>Figures 33, 34, & 35</i>	70.
<i>Figure 36</i>	71.
<i>Figure 37</i>	72.
<i>Figures 38 & 39</i>	74.
<i>Figures 40 & 41</i>	75.
<i>Figures 42, 43, 44, 45 & 46</i>	76.
<i>Figures 47, 48, 49, 50, & 51</i>	77.

OF THE ORIGIN OF THE THREE PRINCIPLES.

PART THE FIRST.

OF SALT CHARACTERIZED.

ORIGIN OF COMMON SALT.

CHAPTER 1.

S. 1. It is surprising there should have been so many different Opinions both among the Learned & Unlearned; of the Origin and first Production of Salt, viz. the Common Kitchen Salt, which is the Basis of all other Salts (as they are usually called) and one may venture to say, there have been as many different Sentiments as Writers upon this Subject, not one of which seem to have had the least true Idea of the Operations of Nature in her first Productions, who being most assuredly the Principal Agent in the Oceanomy of our Worldly System, well deserves to be studied upon better Principles; and all the Opinions hitherto held, by even the best of our SPECULATIVE Philosophers, who have only examined her quietly in their CLOSETS without the least Experiment to support their Hypothesis; ought totally to be rejected; and her true Principles and material Operations laborously and carefully enquired into; as I shall endeavour to do in the Course of this Work; and lay it before you in good Sterling Coin if I may be allowed the Expression. The simple Distillation of a Spirit from this or that SALT is by no means the Way to form a Judgement of its TRUE ORIGIN, AND ESSENTIAL Constitution. It has never yet been said, that it was created by ALMIGHTY GOD, in a MATERIAL AND CORPoreal form from the BEGINNING AND DETAINED IN THE OCEAN, as in a Universal Store-House; and passing from therein into SUBTERRANEOUS Conduits, as so many VEINS; is conveyed all OVER this Globe of Earth; and here and there showing itself in SPRINGS, from which the Salt is separated by Evaporation, and produced as we have it in its corporeal Form.



S. 2. And though it is allowed that Salt in that State as we use it, comes from the SEA thru subterraneous Clefts and Veins, and is separated from its Humidity by Evaporation, yet this does not give the LEAST LIGHT unto its ORIGINAL Production.

S. 3. But rejecting all erroneous Opinions, and Looking for Truth on the

broad Road of Nature, I will first consider Salt in its MATERIAL Form; as it appears to our Sight, where we generally have it in 3 different States, though fundamentally it is ONE and the SAME thing, viz. SPRING, ROCK & SEA Salt, which in their Nature and Figure are simply but ONE, but when blended with their HETEROGENEOUS Bits have some Difference in their Texture.

There is also a 4th. SORT, not improperly called so, which is the Base and MOTHER salt of NITRE, for by a very simple Manuduction, it may be made perfectly like the Spring or other Salts in FIGURE, FORM & PROPERTY. Its Figure is a Cube which is a Mark of its being an EARTHLY BODY, and having GRAVITY; and the Line passing thru it shows it is mixed with earthly Qualities. In its Form it is fundamentally TRANSPARENT, and the more it is deprived of its HETEROGENEOUS Parts, the more its CELESTIAL AND DIAPHANOUS Form is manifest. It is fluid and easily penetrates other Bodies. Its Taste is acrid and somewhat astringent. It is of a dry Nature consequently COOLING, though in its Centre it is PURE FIRE, as shall be shown by and by; taking it at present only in its outward Appearance.

S. 4. I will now attempt to trace its REAL PARENTS, and answer every Question fundamentally, as to its Origin and Nature.

S. 5. Moses, says in the 1st. Chapter of Genesis where he describes the Creation of the World, or Our Solar System, that Almighty God in the Beginning created Ha Schamajim veeth Haaretz, that is, the Heavens, on a PARTICULAR KIND OF FLUID, and the Earth. Here Moses places the Heavens, on the Igneous Water first, and not without special Reason, being the FIRST Principle of all things that God created; on the PRINCIPLE OF PRINCIPLES; whose real Essence is inscrutable, by the Powers of Man, as their wonderful Specification sufficiently testifies; for Moses or rather the Holy Spirit thru him calls this Expansion ; Schamajim, which is a Compound Word, and is described by the Ancient Rabbis (as their Cabala mentions) as compounded of  & , Aesch & Majim; Fire & Water, and it is indeed according to the external Characters, a wonderful and rare Mixture, nor is it to be conceived how two things so diametrically opposite, can be so INTIMATELY united, but you may be assured, this igneous-Water or this Aqueous-Fire, without which no Creature can breathe or exist, and which is so little known, shall be ACCURATELY AND DILIGENTLY investigated; but to describe it in its FULL EXTENT, is far from being my Intention; such a deep and holy Mystery being much above the Reach of so humble a Pen as mine; but on the other Hand, I will not conceal the small Portion of Light that has been imparted to me; and that can in the Least contribute towards the Plan I have already proposed, viz. to describe the particular Production of the Common Kitchen Salt, whether it comes under the Denom-

ination of Sea, Spring or Rock Salt or even the NATIVE SALT OF THE EARTH. ALL other Salts, such as Vitriol, Alum, Nitre & Sal Ammoniac not in the least belonging to them; for Vitriol & Alum are mixed with Metalline Particles, & Sal Ammoniac is composed of Urine & Common Salt; Salt-petre is also a Compound of ACID, VOLATILE AND ALCALINE Particles, as shall be ascertained in the following Chapter. But ALCALIES are next in Affinity to Our Kitchen Salt, as shall be shown in its place.

S. 6. I have already briefly observed that God in the Beginning created the Heavens (Schamajim) as the Principle of Principles, on the Element of Elements, on igneous-Water which Moses brings forward, and immediately after mentions VEETH HAAREZ, AND THE EARTH; which was the 2nd. secondary quality. Here are then EARTH & WATER separately taken as their Signs here, and the following Observations upon them testify; at that time the Dark EARTH was not there, viz. the Distinction of the two (commonly called Elements) from which the Schamajim might find a STRONG RESISTENCE, and upon which they might shew their Virtue & Efficacy. In the 6th. & 9th. Verses he further describes the Separation of the other Secondary Qualities, as the Air & Waters from the Earth, or rather the Earth from the Water; and WATER was also the FIRST SECONDARY QUALITY as shall be shown hereafter. This igneous-Water or Essential Fire has taken its Place (as the lightest of all) in the Sphere of the Schamajim, while the heavier or Elemental Fire remains in the Center of the Earth; the Division & Separation also of the Elements was first produced by the Schamajim, & every thing owes its Life, Being, and Conservation to it; as we see in the 3rd. Days Work V. II., where by Gods Command thru the Efficacy of this igneous-Water (which the Ancient Philosophers called the UNIVERSAL MERCURY) THE EARTH BROUGHT FORTH GRASS, ALL SORTS OF HERBS, AND TREES BEARING FRUIT & C., (before even the Sun, Moon, or Stars were made) for the Use and Support of all Living Creatures, which were not created till the 5th. or 6th. Day, in which the Creator shewed his consummate Wisdom, by providing Food ready for the Animals he intended to create.

On the 4th. Day, the Sun, Moon and Stars were made; now appointed to preside over the Oceanomy of this World, & Emeration of the Schamajim, for the Support of every Creature according to its Necessity. Now the Sun began with fuller Power to impregnate the Air with its Atoms; which being Pure Fire united themselves with the aqueous Atoms of the Moon, and the Air conveyed these Celestial Seeds immediately to the Sea, which at this Hour is full of them; and not only the Sea but the Whole Globe of the Earth; which not only salt every where found is a Proof of but the DEW, HOAR_FROST, RAIN & SNOW also contain them. They are in like manner conveyed from the great Stone-House the Sea thru the Clefts & Veins of the Earth, for the

Support & Subsistence of all Living Creatures. It has already been said that the Schamajim is a Compound Word of Aesch, FIRE & Majim WATER, in which it has its Abode.

The Sun is only a grosser Portion of the Aesch, the Heavenly Fire, as the MOON & STARS are of the Majim, the Heavenly Water, which bodies the first Principle Schamajim flowing without Intermission, and which also partaking of the heavenly Virtue & Emanation from the great and wonderful River, which ran thru Eden, taking its Rise from the great Ocean of the benign Essence of God which watered the Garden of Paradise, so little known to Man, now sinks into the Sea by Means of the Atoms that are floating in the AIR, & upon which it is conveyed thru the whole Globe of Earth for the MAINTENANCE & SUPPORT of all Things.

S. 7. And that this Influx from the Sun, Moon & Stars is Salt, nobody can deny, on Fire & Water on Schamajim called by the Philosophers the UNIVERSAL MERCURY: And which God has illuminated, for it is in the first Place undeniable, that the Sea is SALTIER as you approach the ECLIPTIC than in other Places, as has been proved by Experiments upon the Spot. 4 lb. of Sea Water yielding more than 1 lb. of Pure Salt, and the Sun itself produces Salt from the Froth of the Sea left upon the Shore. On the other Hand the nearer you approach the Poles, the less salt the Sea is, as the Inhabitants of that Country very well know, and all the world knows also how little Profit the Sea Water there is, and to procure Salt; for though the Water is SALT to the Taste and the Rays of the Sun are very powerful; their Virtue is not so effectual, as under or near the Ecliptic where they fall perpendicular upon the Sea.

S. 8. ALL TRUE PHILOSOPHERS knew that the whole Atmosphere is filled with this Celestial & Balsamic Salt, as they can with a CERTAIN MAGNET KNOWN ONLY TO THEMSELVES, attract & procure this igneous-Water, or wonderful Salt in a considerable Quantity, it may be supposed this Magnet is of itself SALINE, though it is NOT GIVEN BY NATURE; those therefore who know our various & simple Instruments, by which this saline celestial Schamajim, humid Fire or igneous-Water is collected which is fundamentally nothing but Salt, know also how to PROCURE IT, and by a particular Manuduction to free it from all Humidity, & produce this wonderful Salt before your Eyes. Further, how many have proved that DEW (not to mention RAIN, SNOW & HOAR FROST) is full of this heavenly Balsam or Salt of Life, as may be easily seen by a slight Digestion & further Separation.

S. 9. But if the Air should not be sufficiently filled with this heavenly Salt, either by the immediate Interposition of God for the Sins of Mankind or from any immoderate Heat of the Sun, or from any other Causes, the Air will become PESTILENT

IAL & CORRUPT, both Men & Cattle will die, and the whole Creation be scorched up & withered; as has frequently happened since the Beginning of the World to our Days. It is on the contrary as true, that in a continual Draught, when no Rain has fallen for some time, that the DEW alone has produced very fertile & healthy Seasons, because the Air has at that time been full of this Balsam & Celestial Salt.

We could go a little further, and say something of the great SECRET OF SECRETS, and point out what the Philosophers mean by their Universal MERCURY, and how palpably and clearly Almighty God has laid before our Eyes the Efficacy of his Power (which so few have hitherto known any thing of) and almost continually allows us to contemplate it, which SO FEW ALSO HAVE BEEN PERMITTED TO SEE, from their Presumption and Ingratitude. We could also show how ALL THINGS are produced by Means of this Celestial Fire or Salt, and will be brought by a continual Conuption & Regeneration to an infinite Splendor & Perfection. Also how Christ Our Saviour, who is himself this celestial Perpetual SALT. Fiat or Word was manifested & brought to Light, out of caring Love of God for our Attainment of Eternal Happiness, without which ACTUAL MANIFESTATION we should have been subject to the Fire of Gods Anger either temponally or perpetually, and never have entered into His Holy Rest; as may be proved from numberless Passages in the Sacred Scriptures. Viz: Gen. 5.

V. 24.

וַיֵּלֶךְ עִנֹּחַ אִתְּךָ אֱלֹהִים

"And Enoch walked with God and he

לֹא הָיָה כִּי לָקַח אֱלֹהִים אֶתְּמוֹ

was not, for God took him."

Exodus 3: 24.

וַיֵּרָא אֱלֹהִים אֶל מֹשֶׁה מִן הַלְּהָבוֹת

"And the Angel of the Lond appeared

בְּלֶהַב אֵשׁ

to him, in a Flame of Fire out

מהוך-הסנה-ויטר-רחבה

of the Midst of a Bush and he Looked &

הסנה בער באש וחסם

the Bush burned with Fire & was not

נסתר אכל

Consumed."

Ch. 19: 18.

"And Mount Sinai was altogether in a Smoke because the Lord descended upon it in Fire." ^{YHVH}

Eccles. 24: 17.

"And the Sight of the Glory of the Lord, was like devouring FIRE in the Top of the Mount." ^{YHVH}

Levit. 9: 24.

"And there came a Fire from before the Lord, and consumed upon the Altar the Burnt Offering & Fat." ^{YHVH}

C. 10. V. 1. & 2.

"And there went OUT FIRE from the Lord, & devoured them." ^{YHVH}

Numbers 16: 35.

"And there came a Fire out from before the Lord, & consumed the 250 Men that offered Incense." ^{YHVH}

1 Kings 18: 38.

^{YHVH}
:Then the Fire of the Lord fell & consumed the burnt Sacrifice & the Wood & the Stones & the Dust & Licked up the Water that was in the Trench."

2 Kings 1: 12.

וַיִּפֹּל אֵשׁ מִיְהוָה וַיִּשְׂרֹף אֹתוֹ וְאֶת הַעֵצִים וְאֶת הַבָּשָׂר וְאֶת הַדָּבָר וְאֶת הַמַּיִם אֲשֶׁר בַּחֲדָרֵי הַבְּרֵיתִים

"And the Fire of God consumed him & his Fifty."

C. 2. V. 2.

"And he brought the shadow 10 degrees backward."

1 Corinth.

"For other Foundation can no Star lay, than is laid, which is Jesus Christ."

V. 19.

"It shall be revealed BY FIRE which shall be every Mans Work of what sort it is."

V. 15.

"Every Man shall be saved yea so as by FIRE."

And in various other Places where generally all Evil is understood. Thru all the Little World of Man there is not the least Part of this great Secret made Known, as all true Philosophers that have wrote upon it have fully shown.

S. 10. But not to perplex ourselves too much at first with this Mystery, till it shall please God to communicate Light & Grace, we will return to our first Subject, viz. the Salt that is generated in the Sea, from the Sun, Moon & Stars, these being the Repositories (as has been already observed) where the Emanation from God (the Schamajim) Lodges itself which is the Celestial Aesch or Fire in the Sun, the Majim or Water in the Moon & Planets, & with which they are filled, as is said in the 4th. Days Work.

Gen. 1. V. 14. & 18. "Let there be two great Lights, One to rule the day, the

other the Night & to divide the Years & the Times, viz. That the Sun during the Day sends forth his fiery celestial Spirits into the Air, where all the STARS ABSORB IT (each of which being SPECIFIED by Gods SPECIAL DIRECTION to promote the UNIVERSAL HARMONY) & each change it into THEIR OWN NATURE & PROPERTY AND DURING THE NIGHT the Stars transmit the Spirits they HAVE RECEIVED from the Sun as Father, to the Moon, after having qualified them according to the PECULIAR PROPERTY OF EACH. Of the Efficacy & penetrative Rays of the Moon: See in Psalm, 124.V. 6: "The Sun shall not SMITE THEE by Day nor the Moon by Night, where by the particular Word SHALL SMITE THEE both the Rays of the Sun & Moon have the same Effect & Operation, which as the smaller Light & Regent of the Night congeals them further to a COLD WATERY SPIRIT, & sinks them in the Air; whose Aesch & Majim (i.e., Schamajim) again reunites as in a MATRIX, & makes a new Production, viz. AESCH MAGIM OR SCHAMAJIM & becomes the Spirit or Origin of all sublunary Creatures, as well as their Preservation & Nourishment, from hence it is communicated with the Air like a fine Vapor in great Abundance into the Sea, & the Earth, & by the Power of the Sun & the Central Fire is formed & generated into Salt & conveyed from the Sea thru Veins & Clefts of the Earth all over it, to make it fruitful & multiply, & show itself here and there in Salt Springs & Wells, but where it appears in larger Veins, & the Humidity is evaporated by subterraneous Heat, it is then what we call ROCK SALT; and though in several Places it is entirely dug out, it is SOON REPLENISHED from the Air, by the Nature of its own FIERY & CENTRAL MAGNET, but when it meets with a PROPER EARTH, it then specificates itself to the Production of METALS & MINERALS by the Action of its Central & subterraneous Fire on SULPHUR, according as this SULPHUR IS MORE OR LESS PURE. Hence it is that Our Salt, viz. the Common KITCHEN SALT is both the Beginning & End of ALL Things, & is fully proved That this SALT IS FIRE & WATER, OR SALT, SULPHUR & MERCURY OR WATER, viz. the Universal MERCURY so much talked of & so little Known.

S. 11. It will be necessary here to be a little circumstantial upon the Generation of Metals, and make strict Enquiry into their Matrix, as well as their Manner of Production; we must therefore return to the Beginning of Things at the General Creation, and deduce from it, what is mentioned in the 3rd. S., "That Salt in its interior Part is an ESSENTIAL FIRE. In S. 5., it is said: "That God in the Beginning created the Heavens and the Earth, on the Water & the Earth, and that Schamajim the Heavens was the Beginnings of all Beginnings. In S. 6., it is said that Aez the EARTH is the 2nd. SECONDARY QUALITY. In S. 10., that the Sun is an ESSENTIAL FIRE produced from the Schamajim, as the Moon & Stars were from the Essential WATER.

S. 12. We must also speak fully of the EARTH, and its particular Condition,

that we may understand the better what follows, and be more able to delineate the whole World, on Our Solar System. Fig. 1., in which we will neither oppose the COPERNICANS on any other Sect of Astronomers, upon the Truth or Falsehood of their Systems, but only appeal to the Lovers of NATURAL MAGIC, and Heavenly Truth; for this Magical Scheme will coincide with every Bodies Opinions.

Let us suppose therefore A. B., the Region of the Schamajim, which in Gen. 1. V. 5., is called LIGHT, as the Deep is called NIGHT, both which are two essential Things, and particularly to be attended to in the Magical System of the Universe No. 1., B. C., is the Region of the Stars of the Stanny Heaven. C. D., the Region of the Air which is the 3rd. SECONDARY QUALITY D. E., is the Circumference & Surface of the Earth & Sea. E. F., The Under Region on Gathering of the Water & Virgin Earth on Anez produced there as mentioned in S. 6., and which we would here understand by the known Name of TRIEB SAND, or Quicksand. We have before, called this Region the Proper Collection or Nativity of the WATER, which has a Nature by its petrifying, vitrifying Quality to form SAND & STONES, as shall be proved by & by, and particular Care shall be taken, as NOT A LITTLE DEPENDS UPON THIS POINT, towards the Support of our Argument. But we must first explain what is meant in Genesis 1., V. 1., where it is said Anez is the first Separation from the Schamajim when here we say, this VIRGIN EARTH, AREZ is the Produce of the Water E. F., which petrifying or Vitrifying Water (must necessarily exist before the Earth) & with Reason be called the FIRST SECONDARY QUALITY. To obviate therefore the Objection that the Virgin Earth could not be the FIRST SECONDARY QUALITY according to the literal Sense of the Words, we must go back a little & see what the Holy Text says in Genesis 1. V. 1., "In the Beginning God Created the Heavens and the Earth, and in V. 2., The Earth was without Form & Void, and Darkness was upon the Face of the Deep, and the Spirit of God moved upon the Face of the Waters. Here it is undeniable from the Text, that the Heaven and the Waters are mentioned before the EARTH, it is therefore very clear, both from this as from what follows in the 9th. Verse, which has also been urged in this S., that this Water which is mentioned in the 2nd. Verse, is the vitrifying & petrifying Water out of which THE VIRGIN EARTH & OUR HABITABLE, STONY, SANDY & CLAYISH EARTH, D. E., was produced. Why then is Earth & Water taken for One & the same Thing here in the Text, & that in this sense we may reasonably conclude that Earth as well as Water is the FIRST SECONDARY QUALITY.

S. 13. But we will prove that the MATERIAL Water which is a Child of the Cold Night, or the Water of the Moon is properly the FIRST SECONDARY QUALITY but with this Caution, that we do not mean to include the Sun, Moon & all the Stars among

the 4 material SUBSTANCES OR ELEMENTS so called, having observed in the 10th. & 11th. S., that the Sun is an Emeration from the FIERY WATERY Schamajim, differing only according to their Operations, to prove which we must call such particulian Evidences to our Assistances as can be denied only by those that have lost their Senses. And first we will produce the Holy Scriptures as the best and surest Foundation of Truth, and begin with the most unanswerable Parts of it, as in the 2nd. Peter. C. 3. V. 5, 6, & 7. "For this they willingly know not, the the Heavens were OF OLD & the Earth that was OF the Water & BY the Water, by the Word of God, therefore the World which THEN WAS, perished, being overflowed with the Water but the Heavens & the Earth which are now, are kept by the same Word in Stone, and reserved unto FIRE against the Day of Judgement, and of the Destruction of ungodly Men.

This Text is quoted here for the sake of the WISE and not for the IGNORANT. Moreover it is not to be denied that the Holy Spirit gives in Genesis 1. V. 1 & 2., a general & full Description of the Creation, viz. of the Schamajim as upon which all things proceed by the Will & Power of God. In the 3rd. V. the most wonderful & essential Things are comprised in very short Terms, viz. The Light & Darkness, on as they are afterwards called: The Day & Night, which are two DIFFERENT SPIRITUAL SUBSTANCES & shall be demonstrated hereafter. In V. 4., the Separation of the LIGHT from the DARKNESS is mentioned from which the Water & Earth were to be brought forth, viz. out of the Day, Light and the Earth. When the Light, therefore, centered itself in the Water, which fluid from the Moon, the Virgin Earth was produced; as the Text says. "And there was Evening & there was Morning." And also the Essential Properties of the DARKNESS OR NIGHT & their Offspring the Water which was the First. All which proceed from the fiery or Light Water Schamajim as is mentioned in S. 10.

In V. 5. These essential Properties of the Light & the Darkness have their proper Name viz. DAY & NIGHT. The 6th. V. points out the 3rd. SECONDARY QUALITY and its Creation or Separation viz. the AIR as the subtle Portion of the Water. In the 9th. V., the Separation of the Land is described viz. the WATER of the Sea Rivers & the Surface of the Earth, upon which the Power of the Spirit of God moved upon the Face of the Waters, that the Sun, Moon & Stars might be created on the 4th. day & produced the VITRIFYING WATER, & out of it the Virgin Earth, from which Water, was brought forth in this Verse the COARSE SAND, commonly & generally called EARTH, WITH HILLS, STONES, CLEFTS and subterranean VEINS; the superfluous Water was gathered together by itself & called Sea. It is also very clear from the 6th. & 9th. Verses of Genesis 1., as Peter so truly & clearly says in the above cited

Place. "That the Water was the FIRST SECONDARY QUALITY. It is further said in Psalm 24. V. 1. & 2. "The Earth is the Lords, and all that therein is the World and they that dwell therein, for he hath founded it upon the Seas, and established it upon the Floods." See also Psalm 136. V. 6. "Who hath stretched out the Earth upon the Waters." By which we may see that the Water is the FIRST SECONDARY QUALITY, & very well explains what is said in Genesis 7. V. 11. "In the same day were all the Fountains of the GREAT DEEP BROKEN up, and the Windows of Heaven were opened." From all which we can carry Our Evidence a little further, & shew very clearly how these Fountains of the Great Deep, by the Wrath of God & for the Sins of Mankind have burst out in uncommon Eruptions for their Chastisement, but enough has been said of this; we will now demonstrate from Nature what was advanced upon it at the Beginning.

S. 14. That all WATER, choose which you will, so that it be SWEET WATER, has Sand in it, on the Power of forming Sand, though filtered a Thousand Times, which may be proved by the simple Experiment.

Rx. Rain, Spring or River WATER, put it in a WELL CLOSED GLASS, set it in the Sun on a warm Place, and you will find that after a certain time this WATER will grow thick, and deposit a Sediment which is nothing else, than a fine EARTH or Sand, of which whoever knows the SECRET QUALITIES will probably see more & Learn a little what is meant in Genesis 2. V. 7. And the Lord God formed Man of the Dust of the Earth, it is not permitted to say more only that if you PROCEED PROPERLY with this thick WATER by Distillation you will procure a fine clean Oil of a WONDERFUL FIERY and INFLAMMABLE NATURE, LOOKED FOR BY FEW, AND KNOWN BY LESS, of which at present we will say no more.

Curious Observers at Sea know that the WATER that is carried good & sweet from Europe for the Use of the Crew, turns thick and stinking & slimy as soon as they come UNDER THE EQUATOR where the Rays of the Sun fall perpendicular and are very penetrating, but UPON THEIR RETURN it grows thin again and BURNS LIKE BRANDY. These two Experiments are not mentioned for the Ignorant to gape and stare at. But as a Proof that the Light of the Sun is SOMETHING ESSENTIAL and exists in the WATER, as has been said in S. 13. They know also a certain CHEAP INSTRUMENT thru which by Means of a CONCAVE METALLIC MORROR, the Quintessence of the Moons Rays MAY BE CONCENTRATED, in which the Influence of the Stars lay, and be REDUCED TO WATER, which has something FURTHER in it, to cure radically all Lunar Diseases SO CALLED; and we may still further ascertain, that Darkness on the Cold Night has something essential in it, as is said in S. 12., and tho this Water is ETHEREAL we can prove that from it every WATER has the Power of producing Sand & Stones, but every one must

not flatter himself he can perform what is only told to the Wise, these things belonging only to those who HAVE CLEAN HANDS, and are GODS CHOSEN PEOPLE, who do not attain the Source of the principle River Eden without great Desire and earnest Endeavour to arrive there.

We have now proved what was said in S. 14., that all WATER without Exception has the Power of producing Sand & Stones and not only WATER but AIR has this Property as we have said before in this S.

S. 15. We will now prove, that the Virgin EARTH OF THE FIRST ELEMENT, viz. the Trieb Sand, which is the Region E. F., in the General Plan s. 12., is the Basis of this Our Earth, as is said in Psalm 24. V. 2. For he hath founded it upon the Seas, and established it upon the Floods, & etc. All the world knows you cannot dig deeper any where when you come to this TRIEB OR QUICKSAND, and whoever has been a little out of his own Country may be convinced that in BRABANT, & IN THE NETHERLANDS they cannot dig above 4, 5 or 6 feet in depth before they come to the FOUNDATION OF OUR GLOBE viz. to Quicksand; and that in other Places they sink no Wells or Shafts to Mines, & c., DEEPER THAN THIS SAND, and in several Parts of the NETHERLANDS there are many high TOWERS TO THEIR CHURCHES that stand only upon this Sand which have stood firm for several Hundred Years, without SINKING OR TOTTERING, for which Purpose they first lay a Floor of Planks or strong Beams of such WOOD AS WILL NOT ROT IN WATER, & then build upon this Foundation only, but with this Remark, that they dare not open the Ground within 100 or 1000 Paces of these Buildings, or sink any Wells, Ponds, & c., or turn up the Quick Sand to go deeper down, Least these Buildings should give way & sink on the Side the Quicksand was dug away. They are never raised upon any other kind of SAND, EARTH OR SWAMPY GROUND, without making the Foundation upon PILES hardened in the Fire, or helped some other Way. For Quicksand & firm Ground unite well together. For Water & this Sand are of KIN to each other, the last being produced from the first, and also of being mixed together; which similes and dissimilar Bodies will not do, & similiar Bodies being of the same Quality, are of the same SPECIFIC GRAVITY. Further, those single Buildings formed, stand as fast and immoveable upon these Foundations of Trieb-sand, as Mountains and Rocks, and the whole Superficies of the GLOBE IS UPON THE SAME FOUNDATION; it being their common Base & from which they are all produced; which can be proved in the Case of Mountains & Rocks; this sand being often found upon the Top close under the surface, as well as in very dry Earths and sometimes it is found as WHITE AS SNOW, and in the Veins of VERY SOLID ROCKS & now and then in the very middle of it, Like Marrow in the Bones. We know also from daily Experience as a further Proof of what is asserted in the S. 14., that the WATER which is

continually ascending thru the Fissures of the Earth to the Tops of the Rocks & Hills from the Region E. F., of the general Plan S. 12., changes immediately to various SANDS & STONES as may be seen very evidently in several large Quannies, and in the HARTZ FORREST as well as in other Parts of Europe, there are vast Caves where the Water is continually DROPPING, and coagulates to a curious Stone, in the Form of Large COLLUMNS and other singular Shapes sometimes like LARGE ANIMALS, and monstrous Forms of Men according to THE IDEAS of this Spirit of the Air, out of the Waters with which the whole Atmosphere is impregnated, of which more shall be said in its Place.

The Histories of Mines, tell us, that when the Miners meet with such hard Rocks, that they are obliged to use a great deal of Violence to work them or to blow up, they meet with Water here & there in the MIDDLE which seem to be their Nourishment & Support, besides in all Stones & Flints which are pierced with a Variety of coloured Veins, if you separate these Veins so carefully from the Stone that nothing remains but the pure Matrix, you will find the SEPARATED STONES WILL FIT EACH OTHER & JOIN as exactly as if nothing had been between them, from which we may draw this Conclusion, that these Stones had UNQUESTIONABLY WATER or some Juice within them and they must have split at once and pierced thru, & these Veins have deposited themselves in the Fissures, & kept the Stones apart, while they grew larger. This is particularly mentioned here, for the further CONSIDERATION OF THE CURIOUS, as there is some thing DEEPLY CONCEALED in it, which will now and then be the Case, as we proceed in this Work and which confirms what is briefly touched upon in the S. 13.

S. 16. We hope to have made good, that WATER is the FIRST SECONDARY QUALITY, OR THE FIRST MATERIAL MOTHER from which all other palpable Bodies that have any Name are generated. Moreover, that the TRIEB SAND OR VIRGIN EARTH is the other UNIVERSAL MOTHER and produced from the first, and that it may safely be said: I AM THE EARTH THAT IS MADE FROM HEAVEN. Here indeed is a Subject that will admit of SOMETHING VERY PARTICULAR to be said upon it, but for certain Reasons we must first go back a little. What the Trieb sand is, as to its exterior Nature has been amply discussed, viz. that it consists of the most minute Particles vitrified & if you EXAMINE THEM through a good Microscope, you will find them generally of different Forms, all unlike each other, which can only proceed from their being produced from WATER; as has before been proved, which WATER is of itself composed of very SMALL PARTICLES each of which especially contains the VIRTUES AND EMANATION of the Sun, Moon & Stars, i. e., their Essential Seed, consisting of infinite Forms & Qualities; for EACH STAR as well as the Sun & Moon has been particularly

qualified by the Schamajim with different PROPERTIES OR CELESTIAL SEEDS, which being absorbed by the WATER are the Cause of this infinite Variety of Productions, particularly, HILLS, ROCKS & PEBBLES upon which are again produced TREES, SHRUBS & HERBS of all Kinds as mentioned in Genesis 1. V. 11 & 12.

This is confirmed by the following incontestible Experiment: Pour 1000 Lb. of pure MERCURY upon a large Plain, so as to have a lucid surface, and the WHOLE HORIZON will be reflected in it, as in a Looking-Glass. Take some of this MERCURY and divide it into a Number of small Globules, and you will find by a good Magnifier, that every one of them reflects the Horizon, and every Object in it as perfectly as the whole Body.

There is the same Conformity between WATER & every one of its most subtle Particles; the minutest of which have the whole Schamajim in it, as it was specified in the Stars, consequently EVERY PARTICLE of Virgin EARTH as the Produce of the WATER must contain the whole Celestial Seeds from the Sun, Moon & Stars. It is well known to good Assayers, that there is not the LEAST GRAIN OF SAND, though no bigger than the Atoms of the SUN, which has not a small Portion of SPIRITUAL GOLD & SILVER, which is nothing but the true Influx of the Light & the Night, on the Sun, Moon & Stars; for the First Material Mother, or WATER, having its Origin from the Center of Things above, and from which the other Universal Mother or Virgin EARTH (Trieb-sand) which is one & the same, was formed, from whose most subtle & inferior Dust MAN WAS MADE, denoted also from the living GOLD & SILVER on the IMMORTAL WORLD. This is the Bridle that keeps our most diffusive Ideas within Bounds, and obliges us to stop a little as we proceed too far, and lose ourselves in the Abyss, upon which the Spirit of God moved; Genesis 1. V. 2. We have now fully performed our Promise in S. 14., which will it is presumed, raise the Readers Thoughts, to contemplate the Microcosm, and will possibly give him some Ideas of Our Immortal Soul.

S. 17. Having now fully proved that WATER is the FIRST SECONDARY QUALITY, or the FIRST ELEMENT from which all Bodies proceeded & originated, & that the Virgin EARTH, OR TRIEB SAND, IS THE OTHER ELEMENT, OR SECOND SECONDARY QUALITY, and is the same with the FIRST, we learn how this World and all its Particles subsisted in WATER not forgetting at the same time that we may also learn, that the ORIGIN, ESSENCE, COLOURS AND NATURE of all the sorts of Earths that we see, such as Flints, Pebbles, & c., are from the Heavens by which we again catch Hold of the broken Thread in S. 12., and return to the Magic System, where F. G., is the Circle or Region of the subterraneous AIR; which being more dense than the AIR C. D., where the Influxes of the Sun, Moon & Stars are mentioned in S. 10., form the Vital

Spirits, and in which the essential Properties of the Cold Night, after being conveyed there by the Rays of the Sun, Moon & Stars, congeal themselves into the Material Vitriifying WATER E. F., and that this is the Case, daily Experience tells us, from the Rain, Snow, Hoar Frost, Dew & Hail; and all Miners know there is a subterraneous Region of AIR from the Blasts, they meet with in the Mines. The terrible Effects of Earthquakes both in our own and former times are sufficient Proofs of a subterraneous REGION OF AIR established as an indispensable & regular Order of Nature.

We come now to the last and most central Region, viz. the subterraneous FIRE which, as the Living aqueous FIERY Schamajim, possesses the upper Region of the Universal, has also found its Repository in the LOWERMOST REGION OR CENTER OF THE EARTH. For the Region of Schamajim A. B., is set in Opposition to the Central, Material, FIERY GLOBE G.

The Region B. C., to the Subterraneous Region of dense AIR F. G.

The upper Region of AIR, or more subtile WATER, C. D., to the vitriifying or petrifying WATER, E. F., but the Sea & Circle of the EARTH are in common to the above-mentioned upper & Lower Regions, as the Repository of their Effects & Emenations, for as the Superior Virtues reunite & harmonise in the AIR, and are brought down to us by the Rays of the Sun. So the SUBTERRANEOUS FIRE which is in the subterraneous AIR, works upon the active Powers of the Stars in the Region of the Great Collection of the Waters; Viz. in the vitriifying WATER, E. F., & digests it afterwards to Living Bodies and that there is such a SUBTERRANEOUS FIRE is very evident to those who know the Sources of Nature as well as to ALL MINERS. The several Ages of the World have given us melancholy Proofs of this, by the many foul Eruptions out of the Earth, as well as Earthquakes in different Parts; what can be said of the fiery Lake in Japan, as mentioned in the Voyages to the East Indies? Not to mention what we see daily in Mines, of this subterraneous & central FIRE, which shews itself most in the hardest Winters, for at the Approach of Winter when the AIR is filled with a great many dense Vapours, with which the Celestial Seeds are intimately mixed, and which are extracted in the Summer by the Heat of the Sun, from the Moon & Stars but cannot all come down on Account of the fine thin Atmosphere at that Season, but from their own Gravity and Declination of the Sun in the Winter they come down to us abundantly in RAIN & SNOW & lay dormant in the Earth during the Time, the Sun is at a Distance, and the Earth is covered with Frost, which prevents these imbibed Virtues from escaping again and returning to their Chaos, and leaving the Earth without Moisture, therefore these Celestial Virtues are digested by the subterraneous FIRE TO A VISCOUS WATER by which each particular SEED IS SPECIFICATED and

appropriated to its proper Action, which WATER THE SUBTERRANEAN FIRE raises again in the Spring to the Surface of the Earth and sends it forth into the vegetable Kingdom, which gives us Room to admire the wise Providence of God, in sending Frosts in these Climates; for when they come AT A PROPER TIME, LAST AS PROPERLY, we may expect fruitful Seasons, but if on the contrary, he pleases to send A RAINY & WET WINTER, this celestial Balsam of Life is by that Means DEFICIENT & rendered abortive by the subterranean FIRE, and turned again to its CHAOTIC STATE, and we have in Consequence only a foul and corrupted WATER. See the Circle D. E., Fig. 1., by whose moist Vapours in Spring & Summer all sorts of Diseases are brought upon us, which proves what is said in Psalm 104. In Wisdom hast thou made them all, the Earth is full of thy Riches, but we refer our Readers to the MAGIC SYSTEM S. 12.

S. 18. We can now ascertain upon better Grounds what is said in S. 11., viz. that SALT in its INTERIOR PART IS AN ESSENTIAL FIRE and is produced in the Sea, and in the Body of the Earth by the Sun, Moon & Stars, as has been already proved, and that the Emanation of the Sun, Moon & Stars is nothing but SALT shall be more fully explained in what follows; but we will here observe, that the nearer you go to the Poles the more the Sea partakes of LUNAR INFLUENCE, and the nearer to the EQUATOR the more Solar it is; which we prove by these Experiments: First, that though the SEA, under the Poles is very Salt, it does not YIELD IN COCTION without a great Deal of Difficulty A FINE SALT, for Want of the MALE SEED OF THE SUN.

Again, if you take a Piece of raw Flesh and lay it in a Sieve, with the Skin downwards, on in any Place where the AIR can come thru, and sprinkle the fleshy side with SALT, it will melt & drop from the Flesh into a Vessel below, continue this till the Flesh is salted enough to keep, and the Salt will at last lay dry upon it, and will melt no longer; coagulate the SALT LYE again, and you will have the SALT, but it will be GOOD FOR NOTHING, and you cannot use it again to salt with, because its FIERY MALE NATURE is lost, and sunk into the Meat, and nothing remains of it, but a FEMALE WATERY SEED, which may again be animated by the SUN OR FIRE and become good SALT; for the Reason the Salt lays dry upon the Meat after it has taken up enough for its Preservation, and no more will melt, is, that the Meat will retain no more of its fiery Particles, and this explains what Our Saviour says in Luke 14. Verses 34 & 35. Salt is good, but if it has lost its Savour, wherewith shall it be seasoned? It is neither fit for the Land, nor yet for the Dunghill, but Men cast it out. He that hath Ears to hear, let him hear. Moreover it is said above, that Water carried from our Northern Climates to the Equator, grows slimy, but when brought back grows thin again and burns like Spirit of Wine, both which have been fully proved.

But before we Leave this Subject we must again refer to the forementioned Passage in Luke, & beg Leave to ask what Our Saviour means by these Words:

But when Salt has lost its Savour wherewith shall it be seasoned? Again in Mark 9. V. 80., Salt is good but if the Salt has lost its Saltness, wherewith will you season it?

How can Salt Lose its Savour? And what Sort of a Thing can it be then? And what can one again season and give Virtue to? Further, if it is good for neither the Ground nor for the Dunghill, Of what Use is Salt either for the Ground or for the Dunghill according to Our Saviours Words. That the Earth is dead when there is no Salt in it. We beg of those who understand this Secret, that they will still keep it from the MURDERERS OF COALS, AND PROSECUTORS OF MINERALS & METALS; Destroyers of Nature. The Little we know shall also be kept to ourselves; but in speaking of Dunghills and such Filth, we are afraid of giving a great deal of Trouble to those that wish to find out these heavenly Mysteries, half of which are concealed in those impenetrable Words of Our Saviour, when he says, Salt is a good thing; None is good but God, & c. For every Man must be salted with Fine, and every Sacrifice must be salted with Salt. Have Salt in yourselves, & be at Peace with each other. Mark 9. V. 50.

S. 19. The Conclusion is, that the essential Operation and Influx of the Light and Night, or of the Sun, Moon & Stars is nothing else but SALT, or a watery FIRE, OR FIERY WATER produced from the Sun as Father, and by the Moon or Mother, viz. from the Sun infused into the Stars & this Influence from the Sun operates upon us as Salt. That this Salt is an essential FIRE, and far above our understanding or Comprehension, we can prove by the most certain Principles; viz. Let a Man concentrate the Rays of the Sun thru a very good Burning Glass, and he will see in a few Minutes how the most solid Bodies are penetrated, & reduced to a Calx, and at last vitrified; which deserves much further Consideration.

We have now proved that the Essential LIGHT IS A TRUE SALT, as well as the essential NIGHT, nay that the primary essential Emanation of God is nothing else, as true Philosophers know; and we know also by an approved Experiment, that Salt is an essential FIRE, for we can DEMONSTRATE that the Rays of the Sun may be CONCENTRATED IN WATER to a sulphureous OIL; and that this OIL can be again transmuted to a Salt. Further, all Vegetables that are nothing else but an Emanation from the Sun, Moon & Stars from this Universal SALT to be a FIRE, as the Scriptures incontestably tells us in Genesis 1. All Vegetables are nourished by a gentle Fire, and being brought back again by Fire to their General Chaos, they leave nothing behind but a small Quantity of Fixed Salt, to make this volatile by a natural Way & reduce it to its

First Essence, you must use the Universal MERCURIAL Salt.

Those who have been in Countries where the Trieb Sand is chiefly upon the Surface, as in the Netherlands and thereabouts, where there is a great deal of TURF, know very well that the Rays of the Sun form as it were FAECES in the Water, and produce this SULPHUREOUS EARTH, and if they are taken out, they grow again, as those that live upon the Spot know very well; this is not only true of TURF, BUT OF COAL, tho not in all Places alike, as may be proved in Loose or spongy Land as in the COUNTY OF LIEGE, where these Kind of Coals are very different from the Pit Coal in other Countries.

Curious People have observed that the Rays of the Sun concentrate themselves in Shaken Water that lays just above the TRIEB SAND, and if the Water is evaporated, and Leaves a BROWN SEDIMENT, which burns Like SULPHUR, it is a strong Confirmation of what has been said upon this Subject in S. 3 & 4.

S. 20. We now come to the SYRTES where so many People have been lost, viz. The Inquiry into the ORIGIN of Metals & Minerals; See S. 11., but we will take another Road in the Description of these Bodies, persuing the open Path, & having the Principles the Spirit of the Living God has been pleased to reveal to us, being assured this is the only way to arrive at our wished for Port.

It has already been observed, and upon good Grounds, that there is not a single Grain of Sand, that has not SPIRITUAL GOLD OR SILVER IN IT, which is either the Red Male Solar, or the White Female Lunar Seed, by which we prove what has already been said in the S. 10 & 16. That as every Planet had at its Separation from the Schamajim at the Creation, retained its own proper Qualities, & Essence, and Strengthened itself with the celestial Solar Seed of the Day which was specified according to its proper Quality and that the Seed of the Night was also furnished from hence, and lodged in the Moon, where it was also coagulated and sent down further into the Atmosphere from whence the MERCURIAL WATER is conveyed to us, and that each of these Atoms has the whole celestial Virtue in it & is of the same Nature as the minutest Grain of Sand; from which we conclude there is no Metal or Mineral, by whatever Name it is called, that has not also some Portion of this SPIRITUAL RED & WHITE SULPHUR or Solar & Lunar Seeds in its innermost Form, and from which Salt or whatever you please to call it cannot be produced.

N. B. We could speak more clearly of this Red & White SULPHUR or Spirtual GOLD OR SILVER was I not afraid of exposing myself to the Ridicule of an ungrateful World. I shall however now & then touch upon it in the following Sheets as far as I am permitted. In the mean time we may gather from what has been said, with proper Attention, where this Spirtual GOLD OR SILVER or Red and White

SULPHUR is to be found in Abundance, observing that when the Red & White SULPHUR on the Solar & Lunan Seed, as spoken of, we would not contradict the Proposition in the S. 7. THAT THE EMANATION OF THE SUN, MOON & STARS IS SALT, but when we call this CELESTIAL EMANATION OR SEED, RED & WHITE SULPHUR, we would wish to be fully understood, that when this celestial Spiritual Essence, Light & Darkness is also once infused into the VIRGIN EARTH, or produced by means of certain Instruments out of the FIRST ESSENCE as we have plainly said already; it is from thence, further conveyed to all other Bodies & Creatures.

S. 21. We must for special Reasons declare that Almighty God has specificated all Metals to their Bodies according to THEIR ESSENCES, and assigned them their PARTICULAR PURPOSES in the Harmony & Constitution of the World; as is said in the S. 16., and shall be proved hereafter.

S. 22. Before we proceed it is necessary to take Notice of the Grain & Texture of Metals, as not a little depends upon the Knowledge of it, for which we must apply to the Mechanical Powers for their assistance; and first in the Weaving of Linnen, Silk, Wool & Hair, that the longer & finer the web is, the better and stronger is the work, and the shorter the Wool, Silk & c., it serves only for common Use.

Secondly, In the making of Paper, where each sort is put under the Stampers; which make it fine & flacky like Down; and with the assistance of Lime Water, good Paper is produced, but if worked too hard, and the web divided, and raised into small knots like MERCURY drove thru the FIRE, the Paper is broken grained, & good for nothing. This holds good with Metals & Minerals for as the Paper Makers & Weavers work the Wool & Rags with WATER, and bring them afterwards to a proper Body with Lime Water, so are the Red & White MERCURY of Metals brought into their particular species by the first conponified and finer worked SALT (which here answers the Purposes of WATER) and is formed into a Metallic Grain. One coarser than another, as we see by Experiments made upon them, particularly those of the SMITHS & WIRE DRAWERS, and the better these 2 SULPHURS are worked up in the Metals, the more valuable is the Produce, as may be seen particularly in GOLD & SILVER, whose very fine and thin Leaves & Threads, both for Gilding & Wire are brought to such a Delicacy as to be almost transparent. COPPER & IRON, whose SALT is the proper WATER for forming their grain, are much fitter for all sorts of work than SATURN & JUPITER; for though these last are soft & ductible and may be hammered to thin Leaves, they soon break to Pieces in that State, which is a Proof their Texture & Grain were made too strong or too weak, by the Force of the subterraneous FIRE; hence it is their Bodies partake more of the rude or METALLIC WATER, OR MERCURY, and this consisting of innumerable small Particles, that will not abide

the least FIRE, or bear hammering, the infinite Globules separating from each other like WATER, for want of the live SULPHUR, prevents their being beaten into leaves like the 4 clean grained Metals GOLD, SILVER, COPPER & IRON.

These 2 Bodies consisting of gross Particles are easily REDUCED TO A RUNNING MERCURY, and being separated from their heterogeneous Parts, which is their Phlogiston, the rest is MERCURY, and we know by incontestible Observations, that this Phlogiston is in a very small Proportion, because you may separate 3 xi. of good MERCURY from 3 xvj. of SATURN, nay I once knew an Artist who by the same Method though in a longer time, and somewhat a different Process, could get xiv. out of xvj, which sufficiently proves what is just now said, that these Metals consist chiefly of MERCURY, with little Phlogiston, but here an Objection rises; and it may be asked, how the whole Body of SATURN & JUPITER, not to mention SILVER can be changed into MERCURY of which scarce $\frac{1}{4}$ is volatile (which is nothing but inflammable SULPHUR & a little EARTH), and further by Means of this circulated Menstruum, that these Bodies of SATURN & JUPITER may be wholly changed to a SALT of which scarce a Particle is volatile, for in this Work the Phlogiston vitriolises itself with it, and turns at last to a SALT.

To which I answer. That we do not mean such a SALT OF SATURN & JUPITER as all QUACKS AND APOTHECARIES Servants know how to make with VINEGAR on other acid Spirits, and can reduce afterwards to a Metal, with Fat & c. For those that know THESE ONLY we boldly affirm, will NEVER ARRIVE at the true Source, of Our Sweet Sea, nor Bathe in the WATER, which has this Virtue. Neither do we mean a HIGH GRADUATED SPIRITUAL SALT, prepared by the Acid of Nature, which can again reduce such a Body to its First Saline MERCURIAL Essence, or First Principles. OURS is another Metallic SALT or Spiritual Vitriol different from the other Vitriol; because you can again separate Metallic Bodies from it. This SALT is easily made by those who well what the true Simple and Cheap Menstruum is, and the TRUE CALCINATION OF BODIES

We could further very reasonably ask, as these Bodies SATURN & JUPITER (not to mention other Metals) are entirely A PURE MERCURY, how can it be; as the Philosophers on the other hand say, that Metals are composed of three Principles, as, SALT, SULPHUR & MERCURY, and how can they prove these Principles upon a true Hypothesis? And who can assure us that there are 3 ESSENTIAL PRINCIPLES in Metals, as in their Composition? But if due Attention is paid to what has been said, this Gordian Knot will be unravelled, and the way out of this wonderful Labyrinth laid open, for He that knows the two above-mentioned RED & WHITE SULPHURS, of Nature and their Saline fiery & watery Origin, and how they are specificated to their proper Bodies, in the terrestrial Globe, and how they assume their particular Qualities, will know how

to answer the opposite Question, viz. That the Bodies of SATURN & JUPITER are entirely A PURE MERCURY AS WELL AS A PURE SALT, and also the connection they have with the 3 Principles SALT, SULPHUR & MERCURY as the Principles of Metals, which will be explained by what follows.

S. 23. But to return to the Texture of Metals, which must be explained before we proceed. It has been observed that GOLD & SILVER are perfectly mixed and tempered, & next to these COPPER AND IRON are the most malleable; and the more these are freed from their inflammable SULPHUR which they have in great Abundance, the fitter they are for all sorts of Work.

We come now to the 7th. Metal, or rather Metallic WATER, viz. MERCURY which has made more FOOLS THAN WINE OR LOVE EVER DID; and we should have good Reason to be afraid of this very volatile Bird; had we any Design either TO TAKE HIM OR HOLD HIM, but as we mean only to take notice of his wonderful Birth, we shall not be much afraid of him, much less dispute upon the Opinions hitherto held of his Nature and Origin, leaving every Body to think as they please upon Condition we are also allowed our Prejudices; but let nobody expect that in this Treatise of the Texture & Composition of Metals we shall speak fully of MERCURY; but only repeat for once that his Texture is LESS IMPERFECT of the Metallic WATER, that is the SALT and Viscosity, and the subterraneous FIRE OR SULPHUR. ALSO THAT LIVING MERCURY is in Truth nothing else but the Red Solar or White Lunar SULPHUR of the Universal MERCURY in a Metallic Form, not SUFFICIENTLY DIGESTED in its Minera or Specified to a Metal by the subterraneous FIRE, for want of the Metallic WATER to give it a proper Texture, and though we cannot too often repeat a Subject, which yet ought to be sufficiently understood, it is necessary to READ AND CAREFULLY REFLECT UPON WHAT is said in S. 17., by which Our MERCURY will be EASILY COMPREHENDED viz. "That Spirtual GOLD & SILVER OR the Red & White SULPHUR, otherwise called the Universal MERCURY is digested to one or another Metal, by Means of the WATER that gives Metals their Texture, assisted by the subterraneous FIRE, which FIERY EMANATION is the TERRESTRIAL INFLAMMABLE SULPHUR; and we have elsewhere proved that every Ray or Emanation, as well from the Sun as the FIRE IS SALT, which is also FIRE; now the material Rays of the FIRE unite themselves with the vitrifying WATER, E. F., Fig. 1., and produce this viscous inflammable substance on terrestrial SULPHUR, which is nothing else but SALT, as all good Chymists know, and this FIRE on Viscous FIERY SALINE Substance, generates further out of this EARTH, the Matrix of this or that Metal; as may be seen in all Flints or Pebbles, that is, when you strike them with a Piece of steel they emit sulphureous Sparks. The purer this EARTH is, shows that it is produced from the Virgin EARTH, and impregnated with

the Celestial Seed (for which look carefully over the S. 16.). The purer will the Matrix be, as well as its specificated Virtue in the Metals that are produced from it.

S. 24. We have now briefly, though fully laid before you the true BIRTH OF METALS and their MATRICES as premised in S. 11., viz. That the Celestial Seed existing in the MATRIX OR MINERA formed by the Emanation of Subterraneous FIRE (or terrestrial SULPHUR) and vitrifying WATER is digested to this or that Metal; and we must go a little further and say; that the Matrix qualifies this Seed lodged in it according to its Tendency, Purity & Fixity. Therefore the Emanation of the subterraneous FIRE cannot have an immediate Operation as we shall see presently. It has been proved that every Stone has its particular Qualities, according to what it receives from the Light of the SUN, who transmits it to the MOON, as the Mother of the vitrifying and petrifying WATER, E., Fig. 1., and from thence it is carried to the Sea, and with the subtle AIR thru the Cavities of the Earth into its Matrix. It has also been said that every Grain of Sand, of whatever Species it is, has this CELESTIAL SEED in it. Now as the Rays from the Stars cannot strike equally thru the Sphere of the Moon, so the Motion of the Earth & Stars as well as the Changes of Light & Darkness, are the Cause, that the Light or Rays of the Sun, cannot operate with more continued Velocity towards the Earth; therefore it follows that the operations in the great Source of the Abyss in the Region of the WATER, E. F., Fig. 1., cannot be like those in the Sea, as we have said in S. 18., it must consequently follow also that the Trieb Sand and its Origin the common Sand Stone, & Stone Quarries must originate from WATER by means of the Subterraneous FIRE, and must have very different Qualities with this FIRE OR SULPHUR, and occasion a Difference also of the Matrices of the Metals and Minerals. The purer & more perfect the SALINE SAND MAKING WATER, and the viscous EARTH which is the Basis of Stones are, the purer & more perfect will the Concentration of the subterraneous FIRE be in them, and of whatever Nature the Perfection or Imperfection of the Matrix of this or that perfect or imperfect Metal is and the higher the Digestion of the Celestial Seed, (which is the Red & White SULPHUR of all Nature) is carried by the Nourishment of the Lunan Universal WATER (as the Menstrua of the Matrix) to this or that Metal the purer is the Mother and her menstrous Aliment. And this is confirmed by all sorts of Ores, as the Matrix happens to give birth either to Metals & Minerals, which is confirmed by the most perfect ones, as GOLD & SILVER, for the richer the Ore is, the more perfect is its Matrix & free from all coarse things & Impurity, as in the SULPHUREOUS & VITRIOLIC Ores; viz. the TREM ORE, WHITE & RED GOLDEN ORE, and many others which have a good Appearance, whose BERG. to speak in

the Miners style, is much richer & purer than that of the poorer Ones; not having so much impure SULPHUR on Arsenical & Vitriolic Nature in it. It is quite the contrary with the poor GOLD & SILVER ORES, and examine the IRON & COPPER Ones, we will not appeal to the first Rate, but to the common Mines, and they will tell you how full of unripe SULPHUR & VITRIOL they are; and not the half of them turn to any Profit, but the more experienced Smelter knows how to separate them from the heterogeneous Parts, and get the purest Parts of the Metal from them, and bring them to the End they were designed for, as good Chemists can prove from IRON, for if you often moisten the CLEAR SCHLICH with WATER in the open AIR, it will be at last decomposed to a YELLOW OCHRE, (a great deal of which you find in Iron-Veins) and if you reduce this OCHRE AGAIN TO IRON, it will be much TOUGHER, SOFTER & BETTER than at first, because its coarse inflammable SULPHUR has been connected in its Reduction to a Crucus by its own vitriolic SALT, but on the other Hand it is more difficult to melt it again, because its gross volatile SULPHUR is connected, & digested by its own menstrous WATER to a perfect State & Form. But we do not make this Remark for the Ignorant but ingenious Artists.

It is the same with COPPER, which in its Matrix abounds with this unripe VITRIOL & SULPHUR, & the more it is separated from them, the more perfect, purer & difficult of Fusion it is; but the Refiner knows how to carry off its impure SULPHUR by its own metallic WATER, and bring it to Perfection, and reduce it to a Metal, for there is a Process in refining known only to those who understand the Operations of Nature, and he that knows this Method of purifying baser Metals COPPER, JUPITER, IRON & SATURN may fairly expect to arrive at greater things, but let him first of all learn to know, the Sweet SALT of Metals, we having in several Places mentioned the original WATER of Metals.

S. 25. As to SATURN & JUPITER you may easily form a Judgement of them from their Miners, that the Emanation of the subterraneous FIRE OR SULPHUR has not well concentrated and united itself with the Saline menstrous WATER & the viscous EARTH, therefore they cannot exceed their appointed Degree, for want of purer Digestion, & their Impurity or Porosity of the Matrix is the Reason that in one Metal more than in another (as in SATURN more than in JUPITER) there is more spiritual GOLD & SILVER; for the subterraneous FIRE instead of having digested this celestial Red & White SULPHUR or Seed to a perfect Production, has destroyed it, for want of a pure wholesome Menstruum & Saline nourishing Juice, which cannot exist in so impure a Matrix. The same thing holds good with the 7th. Metal, or rather Metallic WATER OR MERCURY, for its RED COLOR proves sufficiently that its Matrix consists of a pure SULPHUR or Volatile FIRE and a small Portion of EARTH, and wants the menst-

nous saline forming WATER (to fix the SULPHUR) it has therefore left its celestial Lunar Seed in its first Coagulation into the watery Form without any further Digestion. But if the Minera happens to be of another Colour as GREY & c., it gives Rise to different Ideas of it, and shews us running MERCURY or Quicksilver, as the first Order of Natural Digestion and the first Intention of Nature. The Mercurial Alchemists knew what sort of a Bind they have to do with, & what Kind of a Fire is necessary, to burn its Wings, and being still homogeneous, they have thought to fix it to good GOLD by giving it what it wants in its Minera, which is easily understood by what goes before. But as its gross earthy SULPHUR can be of no Use, particularly while it wants the Menstrous SALT, it must therefore have a proper Proportion of SULPHUR & SALT given it, or such a fixed sulphureous SALT that flows in the Fire, and can penetrate all fixed Bodies.

S. 26. What has been said of Metals, may also be understood of Minerals, both as to their Origin, and WHOEVER COMPREHENDS us well, will know what is meant by Gun, viz. an untimely Birth, or unripe Metal, which with another Degree of Digestion, would be Running MERCURY & take away the superfluous Humidity which would approach very near to a Metal; but by an untimely Appearance is prevented being brought to a perfect Coagulation by the subterraneous FIRE. This Gun is besides as various as the MERCURY of Metals, & Minerals, but they are GREATLY MISTAKEN who say it is the FIRST MATTER, and endeavours to make the Stone of the Wise from it, it being no more the FIRST MATTER than the CHILD IN THE WOMB.

S. 27. A little shall be said here of the Production of Realgars, viz. ANTIMONY, Arsenical Bismuth, Marcasite, Zink, & c., which are in fact A REAL MERCURY in dry Form, digested by the subterraneous FIRE with Salt WATER, without having the proper PURE SULPHUR to each particular specified Body, as known to all, which may with a small FIRE be turned to Arsenic; for one having too much of the WHITE LUNAR SULPHUR, & the other of the RED SOLAR, neither can be exalted to GOLD OR SILVER, though all of them being homogeneous Offsprings of these Metals, yet for want of the proper SALT OR PROPER SULPHUR remain in another Order of Coagulation, they are arrived at their predestined End, and are included in the UNIVERSAL HARMONY, nothing being done without the appointment of GOD, and on that account every thing has its proper End & Utility.

S. 28. Before we proceed any further, let us say a Word of the wonderful MINERAL WATER, viz. Pit Coal, of which there are 3 Sorts. Coal upon the surface; Coal under the Surface & Pitch Coal. The fat Coal in the County of Liege is of another Sort, which burns like Pitch, and when it is almost quite taken away from a Place where it is 2 or 3 Fathom thick, IT GROWS AGAIN IN A FEW YEARS, for its Magnet re-

maining, it draws it again from the Stars or Atmosphere, its Birth being from the SUNS RAYS that fall upon a PURE LUNAR SALT, Uniting with the Exhalations of the SAND MAKING WATER of the Region E. F., Fig. 1., which gives a Fixity (the FIRST Specimens of these are a sulphureous SALT OR SULPHUR coagulated by a gross vitriolic SALT) (see S. 23.) more subtle than that of the Dach & Pit Coal mixed with crass Letterish EARTH or Clay, which is not fixed but decomposes in the AIR, & falls into a MULON very unfit for Smiths or work that requires a strong FIRE. It must be helped therefore with Letterish Salt EARTH: SALT being the Bond of SULPHUR, & then it is good, as will be seen by & by.

The other Sorts as the DACH COAL have a coarse SULPHUR in them which is more coagulated by the SALT, mixed with a pure Clay, which gives its Compactness & Solidity. There are other Sorts, according to the LETTEN mixed with them which being yellow. The COAL IS BROWN & Like wood lain long in the Ground, and is therefore called WOOD COAL, THE BLUE WHITISH LETTEN yields a much browner, to a black Coal.

If the Letten is black, & Iron coloured the Coal is black, & this sort of Dach Coal is very good for Iron works & especially when BEATEN WELL and mixed WITH LETTEN well impregnated with SALT, which makes it burn well & clear; its Sole or Base is generally a Flotz or compact Letterish Earth, & sometimes a Sand Stone according to the Rock. This DACH COAL often improved in the Vein to a very good fat or PITCH COAL.

The 3rd. Sort is PITCH COAL, & consists of a gross metalline SULPHUR & delicate LETTEN like Trieb Sand, & this sort of Coal is the best when nearest the Trieb sand, its Earth being fine & pure, sufficiently mixed with SULPHUR & fixed by the SALT WATER, it is therefore harder & remains longer in the Fire; and when this Coal breaks the best, you will often find, both, where it continues, and, where it breaks off, a fine Letten mixed with Trieb Sand, laying just under it which is assuredly the Basis of the Solidity and Firmness of the Coal.

That the SULPHUR or this VISCOUS INFLAMMABLE SUBSTANCE is an Emanation of the subterraneous FIRE, and how it is produced, you will see hereafter & where it passes thru the Veins & Fissures of the Region E. F., Fig., to the Region D. E., and there meets with the same sort of Letterish Substance, and is absorbed by the Salt Water, and is then coagulated by the subterraneous FIRE, by Means of the above WATER to this hard stony inflammable Substance, there is also found here & there another Letterish Earth (nextwise as the Miners call it) a fine & full digested MATERIA is not so porous as the Letten, and can only admit of the pure solid Particles of this SULPHUR & produce the SULPHUR PYRITE which is so frequently found in LUMPS among Pit Coal: Sulphur PYRITE is also commonly found in Beds of Letten, which

fully confirms our Hypothesis: That LETTEN is the Base of all Pit Coal is already known, & where this PYRITE IS FOUND IN LUMPS in Pit Coal it is a particular MARK OF ITS GOODNESS & the greater Quantity of it is found, the more it proves that the SULPHUR that generates the Coal is more corporeal & fixed, than where this is not found. ALL these Sulphur Pyrites contain GOLD OR SILVER; being already a pretty ripe Matrix, in the Emanation of the Heavens through the Sun, Moon & Stars, & is digested to a perfect Maturity. The Sun in fact being nothing else but an essential & fine spiritual GOLD of which we read in the Revelations, Chapter. 3. V. 18. "Gold tried in the Fire." And this GOLD or Solar Emanation is nothing but SALT. This may be an OCEAN of Error to those who Love SPECULATION only & never taken the Trouble of investigating the fundamental Principles of Nature.

S. 29. It has been fully proved that the Sun, Moon & Stars are an Emanation proceeding from God, immediately, or from the Schamajim, by his Appointment, which Schamajim was produced from his incomprehensible Power. It is also proved, that the Emanation of these Bodies which are the Receivers of the SCHAMAJIM are only SALT, or an essential FIRE, & THE RED & WHITE SULPHUR OF NATURE, which is spiritual GOLD & SILVER, from which other Essences have their Existence, and are found in all Bodies even in the smallest Grain of Sand, tho' as fine as the Atoms of the Sun, it must therefore follow that FIRE, SALT & GOLD in their intimate Parts are ONE & THE SAME; also that the RED SOLAR & WHITE LUNAR SULPHUR ARE FUNDAMENTALLY ONE, viz. Spiritual GOLD & SILVER, OR SALT & FIRE, and whoever knows where TO FIND THESE SULPHURS, AND MIX THEM IN DUE PROPORTION, knows also TO UNITE & FIX THEM and must necessarily arrive at the Knowledge of the immortal Life of Adam, for man being the Microcosm is the intelligible End of all Creation, in which the Seeds of the Universe are and were perfected, & which could not be carried farther, & who ever understands this will also understand what has been said in S. 9. & 20., where we speak of the Red & White SULPHUR of Nature or of the Wise; and why Our Saviour chose Bread & Wine as the Lunar & Solar Elements of his Holy Supper, by which we are made Partakers of His Body & Blood, which is the fixed & immortal SALT of Life or Gods Mercy; and is the Spiritual GOLD & SILVER mentioned in the Revelations C. 3. V. 18., but we are allowed to say no more of the Mysteries of God, than what is necessary for our Justification, it being better to drink at the Spring of Gods Wisdom in STILLNESS OF SPIRIT and see oneself in it quietly, otherwise from the INGRATITUDE OF THE WORLD Cavils and Objections will be made which obliges us to put a Bridle upon the Tongue of Wisdom & Truth.

We are told to declare that in the City of God mentioned in David Chap. 21., there is neither the Light of the terrestrial Sun and Moon, or is there any GOLD

there, for the ETERNAL ESSENCE of God being present is both Sun, Salt and GOLD, which tinges us through the Means of the Living SALT OF CHRIST and quickens us and feeds us the quiet Ocean of the celestial WATER. Revelations 21. V. 6. & 22. V. 1., which may conduct us to the Living Sheere by its eternal Power, but no more must be said of this, least should we sink in this boundless Ocean.

S. 30. But to resume our subject viz. SULPHUR PYRITE & PIT COAL. The first is said to contain GOLD & SILVER mostly volatile, the Matrix being too porous for want of the Saline WATER of Composition, therefore the Artist must know how to remedy this by giving it the proper digesting FIRE & WATER, to fix the volatile & make a profitable Separation. He must know the FIRE too, and we think this compounding WATER which is so necessary for the fixing it, is not made of KITCHEN SALT, the Artist must therefore KNOW BEFORE HE UNDERTAKES THIS WORK, the sweet ALCALINE SALT OF NATURE, & how it is procured from the Rays of the Sun for most assuredly he that is ignorant of this Living SALT knows nothing of the Difference of Salts, for the Saline compounding WATER of the Metallic, Animal & Vegetable Kingdoms is very different from the common SALT as it is found in the Sea, Springs, Mines and in the Earth, but at the same time we do not contradict our first Proposition in S. 10., where we assert, that COMMON SALT IS THE BEGINNING & END OF ALL THINGS, but on the contrary we MEAN TO CONFIRM IT, for when we speak of this SALT OF NATURE as the Basis of all Acid Salts, we do not mean as it is produced to us, but as it is digested in the Bowels of the Earth & animated there by the subterraneous FIRE, and its Acidity destroyed by this digestive Heat, or sulphureous Vapours which are nothing but VITRIOL. THIS IS ENOUGH FOR THE TRUE PHILOSOPHER, Let others understand it as they may. It suffices that when we speak of the compounding saline WATER, that dissolves all Bodies, we speak of SALT as we see it ourselves, handle it, & taste it, & which those who understand it can at every Instant change into the SALT OF NATURE for it is produced from the SUN, MOON & STARS, of which enough has been said, & those that understand us will have no Doubts about it.

S. 31. It has been said that OUR UNIVERSAL SALT is originated in the great Kitchen of the Earth by the sulphureous Vapours of the FIRE there, as well in the Sea, for the Exhalations of this FIRE are there; also Pit Coal is a particular Proof of this, and who ever assents, where ever there is PIT COAL, there are no SALT SPRINGS, on our earth, is very little conversant in Nature. Therefore as the Veins of Salt generally run deep, the Coal that is exposed to the Day & the DACH COAL have less Fixity & Goodness than the PIT, FAT, OR PIT COAL, because the SULPHUR of the Salt Springs is more fixed. On the other Hand, the Salt Veins absorb more & more of the sulphureous Acid, and are the sharper for it, which makes the Springs weaker

in one, and presence of this ACID in the other as shall be explained in the 2nd. Chapter of the Nature of Salt.

When they meet with good Pit Coal in HEAPS, the Springs are much stronger than where it is in small Quantity, and of a bad Sort, as the DAY AND DACH COAL. Good Chemists also know how to separate the ACID OF SALT, for the accidental Acids that are mixed with it; and give it its own natural SWEETNESS, which essentially belongs to it; when you draw it out of its pure and true Sea, but this is not in every ones Power; for its Acid derives its Essence from the SULPHUR or subterraneous FIRE, and it may again be separated from it & the SALT brought to its FIRST ESSENCE. Every Acid is produced from SULPHUR, which may itself easily be reduced to an acid WATER, such as is in SALT, and this again, to its first State.

Whoever comprehends this well, will easily conclude how ALCALIES (S. 5.) are easily changed WITHOUT MUCH TROUBLE TO AN EXCEEDING ACID SALT. It has been proved, that the Acid is accidental to SULPHUR and they who understand this, will easily see how much they err, who take Vitriol & SULPHUR to be nearly allied and even for one & the same thing, but more of this shall in the next Chapter S. 10. (S. 10.?).

Enough has been said of Pit Coal & proved that SALT is a true FIRE & MERCURY & that everything CONSISTS of 3 in 1., Viz. SALT, SULPHUR & MERCURY, which are fundamentally but one, i. e., FIRE. We must now prove that FIRE IS WATER, which is an important Point. And further that SALT is the Beginning and End of all Things, viz. WATER, which is also FIRE & the Emanation of God, or SCHAMAJIM.

S. 32. And first that SALT is the Beginning and End of all Things, and that the End of all Perfection is nothing but SALT; which the Wise knew very well. WE have already proved that every thing sprung from Schamajim & that every sublunary thing was further produced by the Sun as Father, & the Moon & Stars as Mother, which are the Schamajim worked up to three spiritual Bodies, whose Emanations are the same as what they sprung from, SALT & WATER OR SOL & LUNA or what the Wise call Universal MERCURY. These Emanations congeal themselves and augment in these sublunary Bodies by the subterraneous FIRE to this or that Body in all the 3 Kingdoms. Further FIRE proves to us that no Body can be found in Nature that cannot be wholly reversed to SALT even the most perfect GOLD & SILVER. But here I see a Storm arise from the Sophists, but I will melt them intrepidly with Truth for my Shield. "For in Time of Trouble the Highest will hide me in his Pavilion, in the secret Part of His Tabernacle, and set me upon a Rock." Psalm 27. V. 5. "Therefore I will be comforted, & the quiet water Murmurs of the Living water of Immortality, shall give me Content in the midst of Storms & Tempests."

Let us next see whether the Ignorant will grow wiser, and begin to work in the

VEGETABLE KINGDOM, for the Animal speaks for itself, we only wish those that are obstinate in their Ignorance would not attempt a Business that does not belong to them.

Burn some 1000 lb. of Wood, preserving the Smoke and Vapour, when burnt you will have a small Quantity of Ashes, in which there is a sulphureous SALT. Put them in a strong Glass and pour the said spirit upon them, just enough to moisten them well. Close the Glass and digest, the Liquor will COAGULATE & FIX WITH THE SALT. Repeat the Imbibitions carefully & patiently & you will have all the Liquor coagulated & fixed to a SALT, which is the first Process; but it is necessary here to answer those who may object to these LIXIVIATED ASHES and ask what is become of them, and whether they are hid in the SALT which seems against the Order of Nature; to which I reply: That if they Knew what this TERRA DAMNATA was in the Beginning, and that all things were again reduced to their first Principles; and they would no longer torment and destroy Nature as they do, but would learn that all Bodies from their Original Growth to their Perfection may be reduced by this METHOD TO THEIR FIRST PRINCIPLES, it being the Treasure of the Wise. It is against the Order of Nature to transmute GOLD TO SATURN OR AN IMPERFECT BODY TO BE CHANGED TO A LESS PERFECT, BUT GOLD AS WELL AS SATURN after their own proper Method may be reduced TO ITS FIRST PRINCIPLES and original State, which may be known by Comparison from this Reduction of the EARTH DAMNATA.

Take therefore these lixiviated Ashes, & put them in an earthen Vessel, well closed, & calcine them by a strong FIRE, open the Vessel after a certain Time, and you will find the Ashes AGAIN SALT, LIXIVIATE THEM WELL, & you will have again a small Quantity of Salt, weigh the Ashes & you will find them lighter than at first, repeat this often with Care & Patience & you will perfectly reduce them to SALT.

There is not the least Doubt the Ancients knew a nearer Way in Nature for this Preparation.

What we have proved in the VEGETABLE Kingdom also hold good in the ANIMAL.

Let us now consider the MINERAL Kingdom, & the length of time necessary to form the most compact & perfect Body of GOLD, & be assured you never will find any thing so difficult to imitate right as this, though you have it very well described.

Rx. Fine GOLD, AMALGAMATE with pure MERCURY, draw off the MERCURY carefully, by a gentle FIRE, calcine the GOLD gently, AMALGAMATE with fresh MERCURY, draw it off again, calcine again, AMALGAMATE again, & grind it as well as can be in a Mortar leaving it always 24 hours in Digestion before fusion, then proceed with the Calcination till the GOLD is not only reduced to an impalpable Powder, but is so opened as to be irreducible, & is in the nearest Form to SALT. If you then know

the true WATER ACTUATED WITH ITS OWN SALT, you may immediately reduce this POWDER OR SALT into an actual and essential SALT. This is a true & perfect Work, though not described particularly.

The mineral Work is easily finished by a SIMPLE CALCINATION by those who understand us, but if you can keep COMMON SALT a proper Time in a Melting FIRE, volatilise it by the Way of Nature, by the Water of the Sea, in which it is particularly produced, & which is itself, a WATER, saline WATER, SALT & NO SALT, & A WATER & SALT without Taste.

The Stone must be calcined & lixiviated as directed in this S., and whoever knows the abovementioned SWEET SALT WATER will easily attain it, and who understands the First will the more easily comprehend our Meaning, particularly if he enters into our Reasoning upon the Composition & Texture of Metals and as all Bodies may be reduced to SALT; if it is asked whether the finest precious Stones which have hitherto been thought so difficult to dissolve can be also reduced to SALT. I can only answer; though perhaps neither you nor I know it, it is nevertheless true, for if you consider only what VITRIFICATION IS, you may even be satisfied upon this Subject, but how to perform this Reduction into Salt, is not so proper here, but He that knows the Virtue of the SUN, FIRE, SALT & WATER, will easily do it, for they are all united, only they are coagulated very pure in their first Mixture, & form a Lunar clear WATER, or a other coloured solar Water.

S. 33. The last Article is, that FIRE is the true WATER, & that WATER IS WATER, & if you understand the Principles we have already laid down, you will comprehend the Truth of this Assertion, for all Salts may be so managed as to dissolve in the AIR per Deliquium; but this is not sufficient for a good Chemist, this Salt WATER being reduced further, for which Purpose you must have its own ORIGINAL WATER, from which by the proper use of common FIRE, you cannot separate the SALT again, & if you know how to calcine this SALT properly & make it volatile in its own Lunar WATER, & reduce it simply into Salt again which I HAVE DONE MORE THAN ONCE, you will by this simple Process, which is a difficult one, have a Menstruum very well worth Attention, & which is more fully mentioned in the following Chapter.

It is also proved in S. 11 & 6., that FIRE is a WATER, or that WATER is a FIRE also that it is GOLD & SILVER or the Universal MERCURY. The Philosophers say, that the Beginning & End of all Things is Salt & that this Salts Mother is WATER, therefore the first created Substance was WATER, which is internally FIRE OR SALT, upon which 3 Principles SALT, SULPHUR & MERCURY, A great deal of NONSENSE HAS BEEN WRITTEN which even A SYBILL COULD NOT KNOW THE MEANING OF, nor do these writers UNDERSTAND THEMSELVES, but we must not forget what has been so often said of the

Emanation of this celestial Substance, viz. that it is red & white SULPHUR, on the celestial spiritual GOLD & SILVER on Seed, from which the whole Creation sprung & which was PERFECTED IN MAN; also that Man (the Microcosm) is the ASSEMBLAGE OF THE UNIVERSE on Macrocosm, on which all their Productions & Forms ARE AGAIN UNITED, through the unsearchable & boundless Mercy of God washed & cleansed at first by the Holy Baptism of Christ, who is the Fountain of Life, from the Deadly Darkness of this transitory Life in the Flesh, & next, thru his heavenly Flesh & Blood in his Holy Supper, made us new & regenerated by his Love for Man. This inflammable, volatile SULPHUR (which without this Medium must remain in the Grave) must be united with the celestial WATER of Eternity. Third as SALT is the Medium by which this WATER & THE OILY FIRE OR SULPHUR must be united; so is Our Saviour, as the immortal FIRE OR SALT of Life, the uniting Medium between us, who are composed of fat & fetted SULPHUR & the incomprehensible Goodness of God, who is the unflamthable & inscrutable Sea of Immortality, which is perpetually open to receive us, & is also the spiritual GOLD & SILVER, the true Essence of the Schamajim, which is an Emanation from God himself. Here we must rest, for we can proceed no farther, being upon the edge of that profound Abyss, that stops all nearer Investigations; for it has neither Bottom, Beginning or End, being self Existent, & proceeding from itself, we cannot dwell upon the Consideration of it, because we have no Ground to stand upon, no Datum, no Name, or term to call it by, only, that it is the Beginning of all Things & all Creatures. If we would humiliate ourselves in the most solemn Acknowledgement of this most holy Essence I. H. V. H., and express ourselves with the higher sense of Gratitude (enlightened & warmed by his ineffable Light) and would endeavour to approach him in Soul & Spirit, & enter into the deepest possible Consideration of His inexpressible Essence as far as the Creature can comprehend the Creator, in the first Emanation of the Schamajim, which is SALT, FIRE & WATER, we must approach nearer to the Knowledge of the most Holy Trinity; which according to the Prophet Zechariah, C. 14. V. 19., is the Unity of God the Father, Son & Holy Spirit; we must consider this Schamajim, as an essential FIRE, an essential SALT; not as three divided Properties but each essential in itself, and essentially united, 1 in 3, & 3 in 1; without any Difference or Distinction, the WATER IS FIRE & SALT equally; the FIRE IS SALT & WATER equally, and the SALT IS WATER & FIRE equally, the one is neither separate or distinct from the other, but each is essentially One, and the 3 essentially & inseparably ONE at the same time. "O Lord, who is like unto Thee: Who has ordered all Things in Wisdom? "Heaven & Earth are full of thy Goodness & all this Light shone upon the World in the Time of the Jewish Desperation, we fully believe, both Nicodamus & many of the present time would have better under-

stood what Our Saviour says in the 3rd. of St. John, V. 5.: Jesus answered: verily I say unto you, he that is not born of Water & the Spirit, cannot enter into the Kingdom of God. O Lord, may all of us who thirst after thy Mercy and Rest, be partakers of the wonderful and holy Regeneration, that our corruptible Body may arrive at that incorruptible Purity, and that at the End of our Lives how we may have our Portion in that pure River of Living Water, which is clear as Crystal, and which springs at the Foot of the Throne of God & the Lamb and is arrayed with precious and Shining Gold of the celestial Hevila, & that is watered by the wonderful Stream of Pison in Paradise; till we arrive with Harps of Praise at the Sea of Glass mixed with Fire to love & praise to Him who is for Ever and Without End.

HALLELUJAH.

OF THE NATURE OF SALT.

CHAPTER 2.

S. 1. This Chapter indeed says little more than was fully explained in the last; but that we may be as good as Our Word, we will endeavour with Gods Permission to shew that the Eternal Wisdom has not forsaken us. In S. 3. it has been said, That the Figure of COMMON SALT IS 1. CUBIC, and that it obtains this Property from the EARTH being struck thru it. In the same S., it is said, 2ndly. That its Form is diaphaneous or transparent like Glass. 3rd. That it is soluble & easily penetrates all Bodies. 4th. That it has an Acid Taste, and is somewhat astringent. 5th. That it is of a dry Nature. 6th. That it is cooling, & 7th. That it is interiorly an ESSENTIAL FIRE.

As to the First. Every Physician, Apothecary, & Common Distiller of Waters knows that Common SALT has a CUBIC FORM, and the more it is separated from its heterogeneous Parts, the cleaner this Figure shews itself. But this cannot be done by COMMON WATER, but it must be purified IN ITS OWN BATH, which every Body does not know. He that does know it, can reduce it to a very penetrating & sweet Salt, and the most perfect Figure. If you will carry it farther, by FIRE and reduce it to itself, and make it quite VOLATILE, and again crystallize it, you may boast of being in Possession of the WONDERFUL SALT OF NATURE, and the Secret Alumen Plumosum which reduces COMMON MERCURY to a Dry Form, but there are few who know, this difficult Road of Nature, and obtain this precious Jewel, for tho' the Operation is Common & simple, it is too MYSTERIOUS and TROUBLESOME & requires great Patience and a fundamental Knowledge of the true Solution; without which it is impossible to bring it to Perfection.

It is said above, which must be taken as an Axiom: "That ALL Bodies must be reduced to their FIRST PRINCIPLES, by the same Means they received their Growth, their Increase, & Perfection. Who understands us well will know that the true Figure of this terrestrial SALT is CUBIC, which those that do not believe it, may be convinced of, if they follow the RIGHT METHOD, for as a round Body is the swiftest and most moveable of all Bodies, so a square Body is the heaviest and least capable of Motion. There is another great secret in this CUBIC FIGURE which will be explained in the 3rd. Chapter, OF THE USE OF SALT, where we treat of the Cabalistical and Magical Characters of Nature.

This Cubic Figure shows that the SALT in the Earth is a New Production of a

heterogeneous Base, for if we separate it from its heterogeneous Qualities, we shall find that its Conponiety proceeds from Virgin EARTH or Trieb Sand, and if you DIS-SOLVE & VOLATILISE it by a Natural Process, and again FIX it; you deprive it of its CUBICAL FORM, which it acquires from the Trieb Sand, and if you reduce it to its ORIGINAL PRINCIPLES, into which as has been already said, all Flints & Stones may be reduced; you have then the Secret SALT, or Alumen plumosum, of which also a great deal has been already said. The Trieb Sand is the Cause of Solidity in all hard Bodies: You will probably ask: WHAT IS THIS SAND? & WHAT IS ITS ORIGIN? ALL which has been so fully described already, that nothing more can be added. WATER is produced from Darkness, for the Stars, & the Moon, and the EARTH was formed by the Sun in the WATER, all which is so self evident to the Wise, that no more need be said upon it, only the uninformed Lovers of Truth will require a further Explanation, and they must be informed that all corporeal & spiritual Things, in their Original are Twofold, as they come to Perfection. One is a SPIRITUAL Conception of the CELESTIAL Lights, and the other a CORPOREAL Production of a Terrestrial WATER & FIRE, which derived their Origin from the First FIERY WATERS. It is also evident that the Trieb Sand does not descend in a Natural Form from the Heavens (Schamajim) but is worked into that Form BELOW, but the Red & White SULPHUR of Nature; The Spiritual GOLD & SILVER descends in a spiritual Form from above; from the Lights in the Schamajim; and is afterwards conceived below; & brought to Effect by the Terrestrial FIRE & WATER, as in a material Vehicle; so that this spiritual Body APHOR. has no Grains of Sand in it like Atoms of the Sun, as is said before. Then as the Emanation of the Superior FIRE & WATER are all, & each of them Bodies, so is the Emanation of the subterraneous FIRE & WATER. The trieb Sand, the Basis of all solid Bodies (called in the Beginning Terra Damnata) which interiorly is nothing but LIGHT THE PRINCIPLE OF ALL THINGS, and the same as the Schamajim. Now as this terrestrial FIRE & WATER are congealed SALT in Comparison of the superior FIRE & WATER, so are they by their Immunity closed & locked up together, and cannot be brought to light in their true Essence without being reduced to another Form, neither can the other be produced in their homogeneous simplicity. This immature Creation is the Martydom & destruction of all Bodies, which can better be conceived from the Idea we may form of the Bodies of the BLESSED AND DAMNED, as the FIRST by Means of the Baptism & Supper of OUR LORD, & by his Death, are freed from all Impunity and terrestrial Heterogeneity & must be reduced to their First Principles; which is Heavenly Happiness; while the LATTER for want of this Purification & separation, remain in an impure & material Form, & are therefore very unfit for their First Intention, & must remain under the Inconveniencies of their SECONDARY QUALITIES, &

gross Impressions, according to the Gospel of OUR SAVIOUR, TILL THE APPOINTED TIME OF THEIR PURIFICATION; by the FIRE of the Almighty Vengeance, but how this Separation & Obstruction happens & how these Qualities with their first Effects. The Fallen Spirits were originally produced, & their Figure transformed & changed by the Harshness & Contraction of their Form, & the fallen Spirits took Possession of them, are inscrutable Mysteries, which having no Beginning will remain so for Ever.

It is sufficient that we know that without God, there is Nothing, and that every thing proceeds from HIM; that Nothing exists independent of Him & that every thing is preserved by HIM; in its own proper Form & Order; & that every created Substance is compounded of 3 different things; which substantially are but 1. And that each is in itself what the 3 are jointly, & yet each is itself particularly.

We have shown from whence the Common Rock SALT acquired its CUBIC Figure; but the Figure of the SALT of Schamajim which is the wonderful MERCURY, is in Comparison with this SALT, as a SPIRIT TO A SOLID BODY. The Wise call it Alumen plumosum, & it can not be better explained than by the Glass Sea mixed with FIRE, as mentioned in the 25th. Chap. of the Revelations.

Almighty God has often told us its Form, but few in a Million know it who Love & praise the Creator of this Wonderful Production for his great wisdom; which SALT (Schamajim) must be the Food & Support of our SPIRITUAL BODY, as Christ the Saviour of the World by his Holy Flesh & Blood & the eternal Salt of God is the Food & support of our SOUL & Spirit forever.

S. 2. (2) That it is transparent as Glass.

He that can purify Common SALT from its EARTH by its own Spirit (not of the common Distillers) will at once see the Truth of this without any long Operation, nay it may be done by the common Mode of Evaporation, and be very nearly reduced to the Transparency & he who knows why the RINDES TARBE on Blood purifies and clears the Sole which is the Mother Salt WATER as it comes from the Spring; will also know the Reason of this. The Blood consists of volatile Parts & Sulphureous SALT, & he who knows more of this SALT, & why Nature produces Stronger Qualities in it, can also purify & precipitate this SALT in the boiling, till he has a SALT that cannot be SUFFICIENTLY ADMIRER. And this is the Beginning of true Precipitations of which more shall be said hereafter, but it will not be improper to observe here, that no Sohle or Mother Salt WATER can be found, that is not mixed with different Kinds of SALT, which cannot easily be separated, & from their interior Combination are so united, as to make it almost impossible to separate them; as the whole Composition would be destroyed & a dead useless dry SALT is obtained from a moist Lunan one,

the male solar Particles generally flying away & are driven off, as may be observed in the Salt Works of a certain Country; but if at the Beginning of the operation the foul Sohle was boiled away, it would yield a fine, sharp & white SALT, hard & dry, but, when conceited & perverse Operators build a Salt Work, and by their very absurd Method of working reduce the Sohle to a thick lee, they have only a weak & useless SALT, whose subtile, fiery & rich Particles fly off in the Boiling, & return to their Chaos, i. e., the Red Solar Seed, (which in this red Sohle is not fast enough united to the Lunan One, which happens in the Boiling) which being set loose in this Operation, returns hastily to its Original Matria, leaving the menstrous Lunan SALT of the sulphureous Acid behind, very weak, & which can never be brought to a solid Substance. This Sohle is therefore super-abundantly impregnated with the subterraneous FIRE, as may be clearly seen, in Stone Coal, but whosoever CAN SO TEMPER this Sulphureous Acid in the Precipitation, as not only to make it milder, but also TO UNITE IT INSEPARABLY with the first mentioned Universal volatile Acid, has obtained the Master Piece of an Operation, which cannot be done but by the living Universal volatile concentrated Acid; but we intreat him that knows to be silent upon the Subject, for the Honour of God & not to divulge it for the Use of an unworthy World.

S. 3. (3) That this SALT is fluid & Penetrates all Bodies. The first every Body knows, but that it pervades all Bodies, is known particularly to Chemists, for it well penetrates all METALS, MINERALS & STONES in Flux, as well as VEGETABLES & ANIMALS, nor is there a Body however compact or solid, that it will not dissolve, separate or penetrate, being itself the Origin of all Things, as has been before observed. It separates or pervades the MERCURY of Metals & even the most perfect of all GOLD & reduces them to their original Form & Essence & this SALT TRULY PREPARED is the Secret Key of Nature & dissolves GOLD & other fixed Bodies, without any Violence; so that they are no longer again reducible to their metallic State, but remain in their original SPIRITUAL ESSENCE; but this Sal Enixia is so little known as to have no Credit for its Assistance. He therefore who has it, will produce a wonderful Thing for the blind World; & will be able to purify the dank infernal FIRE, the Black Coal, which is the Black Fire of Hell, and will bring them to their first Heavenly State, & Perfection, and may Almighty God so purify Us, & every one who hopes for Salvation through Jesus Christ, they they may be made Partakers of His Resurrection, & enjoy eternal Happiness, & dwell with God for Ever.

S. 4. Its Taste is acid, & a little Astringent.

Its Astringency proceeds from the Virgin EARTH in its Composition, as in Chap. 1. S. 28., and its Acidity from its subterraneous FIRE or SULPHUR, and here we must

carry our Enquiries a little farther, and attend to what has been said before.

That the Stars shed their super abundant Influx both upon the Ocean & the Surface of the whole Earth, & coagulate it to a ☿ but that this ☿, or heavenly Emanation is neither acid nor astringent in its first Essence may be proved beyond all doubt, for if you deprive it of these Qualities by Circulation, & again reduce it to its original Sweetness, which evidently proves the Acidity & Astringency are adventitious only or they could not be separated from it Again, its Acidity may be restored by a certain PREPARED SULPHUR which also proved its being an adventitious Quality, that may be by Circulation be changed into a pure & PRIMARY SALT, as is already mentioned in Chap. 1. S. 28: That every Thing proceeds from the SAME ORIGIN & can be again reduced to its First Essence.

Here you may say: This is all very well; but how can all the SALT in the Ocean, & in the interior Parts of the whole globe of EARTH, be made acid by the Operation of the subterraneous FIRE? It is at the same time worth while to ask another Question, which will be best answered by referring to our System in S. 12 & 17., of Chap. 1., where we have laid it down as an incontestible Truth that the Ocean near THE POLES as well as in the MEDITERRANEAN near Sicily, and in several other Places, there are certain WHIRL POOLS or GULPHS in some of which the Water is swallowed up, & in others thrown out again, with continual Violence & Fury, & that these Gulphs pass the Region D. E., see S. 12 & 17., and thru the Sand and Stony FIRE Region E. F., on the Foundation of the Globe, & the subterraneous AIR F. G., & so on to the great Repository of FIRE, as the human Blood circulates thru the Heart & Keeps the Body alive & there is no Doubt, that if it was not for this Circulation of Nature together with the great Lake of Fire in Japan, every thing would be burnt & be destroyed to ashes.

You might also farther ask what becomes of the WATER in the Region of AIR F. G., which we take Notice of & is the Place where the SULPHUREOUS Acid penetrates & operates, & as the Emanation of the ☿ has its first Effect in the Stars, & from thence descends into the Ocean with its own Lunar WATER & continues to communicate itself to the Surface of the EARTH, it must necessarily penetrate farther with the WATER of the Ocean thru the Whirlpools we have mentioned into the subterraneous Regions of AIR & FIRE, where it is corporified in this dense AIR (and as the Region of AIR, C. D., is also FIRE, which in respect of Our Well known WATER is without Compression more material & substantial) by the very cold & astringent Qualities of the great Whirlpools of FIRE, & Like a Magnet attracts the Acidity & Astringency of the FIRE in passing thru the Region E. F., and collects them together & from thence this WATER by Means of the violent Heat of the Abyss of FIRE is sublimed in Vapours thru other Passages & Clefts & forms the first Origin & Matter of

Rock Salt (but in its Passage to the EARTH it becomes very sharp & pungent, & acquires great strength, as it shoots thru the SULPHUREOUS Vapours, from which the SALT has formed itself into Pit Coal, as may be seen in the s. 31., as well as in S. 9., of this Chapter, where it is said that Common SALT acquires its Acid from the EARTHY, material FIRE, from whose Emanation material SULPHUR is formed, for it is very well known, that the Acid of SULPHUR falls from the Atmosphere, for which see Chap. 1. S. 31. It also fixes itself with the Rays that fall upon the great Region of the EARTH, D. E. The Veins of sweet Water also which pass thru the Region D. E., (and which undoubtedly originate from the Sand making WATER E. F., or from the Great Abyss & have taken up their SALT in their Passage, which at present, we will not proceed upon) and unite themselves with these Emanations of the Stars & carry them with them into the Sea, where they unite the Superior with the Inferiour & from them into SALT; upon these Testimonies we take for granted & true Philosophers will be very well satisfied, & will also comprehend what has been said in Chap. 1. S. 22., viz. That from this pure SALT which we have called the original WATER of Metals & Minerals, & which is the Medium thru which the celestial red Solar & white Lunar SULPHUR is fixed & specified to this or that Metal in their Matrix; and if this SALT is not adulterated by the subterraneous FIRE, but remains & is fixed in its own Veins & proper Repositories, it is this SALT which is poured down from the Heavens themselves by the Sun & Stars, is purified in the EARTH, & falls thru the Surface of the Earth into the Clefts & Veins of the Hills, and afterwards by Means of the subterraneous FIRE, assisted by the active & essential Rays of the Sun by Day, & the pure & mild ones of the Moon & Stars by Night, digested in the Earth D. E., in their particular specified Matrixes, & Matunated to this or that Metal, as the subterraneous FIRE, the Trieb Sand, & the particular appropriated Salt WATER, happen to be united for that Purpose as is said in the 1st. Chapter.

This original WATER or pure SALT, called by the Ancients their Universal Dry MERCURY is little known, but much less by its Taste & Virtues; tho' we so often see it with our Eyes, but as the Creator of the World is so little known, how is it possible we should know so beautiful a Part of the Creation, and distinguish it from other wonderful THINGS SO VERY LIKE IT. When these collected Qualities of the Sun, Moon, & Stars fall so abundantly in these Veins, as to prevent their uniting with the Sea WATER, & that there is no Matrix, in which these Rays of the Sun, Moon & Stars can fix themselves, no Metal can be produced even with the Help of the Subterraneous FIRE. It is from these Places the petrifying Springs have their Origin, which are found so frequently in GERMANY, Bavaria, Switzerland & Austria, whose interior Essence is nothing else than this Secret Sal Enixum, in which all

sorts of ANIMALS & Plants are preserved continually, FRESH, GREEN, & incorruptible; which is done by depriving Common SALT of its acid & EARTHY Nature, & preparing it perfectly by FIRE & WATER; but observe these Springs, may also rise out of the great Region of WATER E. F., from such Places as are not affected with the Acid of the Salt WATER. This Point therefore how SALT obtains its Acidity & Astringency is we hope sufficiently explained.

S. 5. It has a dry and astringent Quality.

As this SALT is essentially WATER, it is also essentially FIRE, which is sufficiently explained in the First Chapter; we shall now further explain what has been said in the last Article, of THE SWEET SPRINGS of this wonderful SALT, which take away all the radical Humidity from Wood or Flesh, & turns them to real Stone, which are the true Operations of this SALT. This is also verified in all the Productions of Nature, & we have also observed before, that SAND & FLINTS are formed from Salt WATER; which in another Place we call MERCURY & SULPHUR. There is no Occasion to repeat that they are all one, viz. SALT, SULPHUR & WATER OR MERCURY; it is fully explained in the First Chapter and the Beginning of this. Its dry Nature can only be denied by those who are quite ignorant of the Degrees of Nature's Operations. It may be proved by IMBALMED BODIES, SALTED FLESH & etc., which are all hardened & contracted with it.

What is said in S. 32., Chapter 1., of concentrating or fixing the Liquor of wood by its own proper SALT is undoubtedly true. Can it be less doubted, that a spiritual WATER, may be made dry, astringent & conporeal? And as all this is done thru FIRE & SALT so is it also WATER & MERCURY. This Point therefore we hope is established.

S. 6. That Salt is cooling.

There are as many Opinions upon this Subject as there are Learned Men in the World, therefore it will be proper to take it up upon such Grounds, that it may be comprehended by the most illiterate; for which Reason we must first distinguish between One SALT and another, but we must not have this understood of Common material Kitchen SALT, which from its Acidity & Astringency is heated & inflammatory, but whose Spirit & WATER must be again reduced to a very subtle & reconcentrated Cubic Salt, Spirit or WATER, & he that can truly make this Enixum by FIRE & WATER comes near the Mark. Both ways are true, but it is not every BROTH MAKER OR COAL BURNER can do this, but only REAL CHEMISTS & PHILOSOPHERS. When it is thus prepared its Virtue is COOLING, which is nothing more than removing the Disorder in the Harmony of the Microcosm, and tempering the ARCHÆUS, which little word is so particularly worth the Attention of all Physicians; that if understood they would not perplex

themselves with so many SPECIFICS & ARCANAS & if they would take Pains to draw a small Quantity of this WATER, they would remove all this Discord & Heterogeneity.

This SALT is also the true WATER of the River Pison in Paradise; but here we do not address ourselves to those who are only versed in the common Alphabet of Learning, but to those who are skilled in the MYSTERIES and are Lovers of CELESTIAL SECRETS and who believe with us, that Paradise is not to be found upon the Surface of the Earth, but in the Region of אֶדֶן where the true East is, and that the River flows through this Eden & divides itself into 4 capitol Streams. This is the River of Living WATER clear as Crystal which springs from the Throne of God, & the Lamb: Revelations 22. V. 1. In this Eden is the spiritual EARTH the Dust of Aphon of which Almighty God, formed & built the spiritual BODY OF MAN (the אֶסֶר כֹּהֵן הָאֵדֶן Aphon mim Haadamah) where Man having his free Choice given him either to remain in this quiet Rest of Heaven, in full Enjoyment of the Light from whence he sprung, or to sink into Darkness, & perpetual Torment. He chose the latter and allowed himself to be infected by the prevailing dark WATER & hot sulphureous FIRE, letting his Imagination run away with the presumptuous Hopes, that he should rule over all temporal & worldly Things without Interruption, which even to this Hour prevails among Mankind, whose Inclinations still lead them to Works of Darkness, & they are so absorbed in this terrestrial Coagulum & MATERIAL BODY, into which State Man is fallen by the Malice of the Old Serpent who flattered him with being Lord & Master over all the 4 Elements on Secondary Qualities, at the very same time he was invested with a perfect Body, and might have multiplied himself ad Infinitum, & fully proved what God promised in Genesis, Chap. 4. V. 28. But allowing himself to be blunted and letting his will give way to it, Satan infused into him that diabolical Concupiscence & evil Desire, which have infected all Mankind as shall again be observed in its proper Place. That Man could no longer maintain himself in that Light of the World or Eden, but must have sunk with the weight and Darkness of his Body, to this diabolical Origin, and abide a temporal Death, or Dissolution of this dark Essence, by which the SPIRITUAL BODY that originated in Him must again be restored to Eternal Rest, and all that belongs to God be again manifested & be again united to him, & what belongs to Satan, on Death remain with them; but whoever throws off, what is generated in his own Will & imagination sturred up by the infernal Fire, shall be interiorly purified & has the Rays of God, the Immortal Spirit, the Rest of Life & the heavenly Inspiration enclosed in him; & he can from a Simplicity and Purity of Spirit neither feel or be subject to, the strong Acid Astringency, or Anxiety of Mind. That he must also send down every infernal & heterogeneous Quality into the GREAT SUBTERRANEAN ABYSS OF FIRE which is

the THRONE OF LUCIFER and the chilly cold subterraneous Abyss of WATER or Region of the AIR, where the Elements are mixed & confounded together, and will remain like a thick gross slag or Dross, till the appointed Time of Purification, by Means of the sulphureous avenging Fire of the Living God, which will again dissolve & purify the Alloy of infernal SULPHUR, that the spiritual GOLD & SILVER, the Paradisaical EARTH Aphon, the spiritual SULPHUR Schamajim, which were originally in the Free Will, may be again purified by the Salt of the Eternal & heavenly Mercy of Christ, and the still WATER of perpetual Light, and celestial Rest.

Let us now return to where we left off, & resume these Subjects for the Lovers of heavenly Mysteries, till another opportunity, when it may please God to give it to us, that we may employ this wonderful Knowledge to the Honour & Praise of his Almighty Power.

It has been observed in the Beginning of this S., that the SALT must be thoroughly cleansed from all Heterogenietys, when it will have a COOLING Quality, & be made the cool WATER OF SILVER of which see more in Chap. 1. S. 1. & 10., also in 14., where the WATER is said to be concentrated by a Minnon. This SALT is then a cooling Remedy in all INFLAMMATORY DISEASES, & radically cures Dropsies & Alkaline Disorders, but it is sought by Few, & found by much less, & this is sufficient to prove its true cooling Quality which is in its Center.

S. 7. It is an essential Fire.

Which is also proved in the 1st. Chap. & makes it unnecessary to repeat here more than is proper to establish the Truth of the assertion; for which we will ask a Question of those who have different Degrees of HEAT AND COLD, with other silly Absurdities, how they reconcile a thing being at the same time essentially HOT & ESSENTIALLY COLD in its simplest & highest degree? Those who fully comprehend what has been already said, & what we now repeat: That God Almighty has created ONE SIMPLE ESSENCE, which is at One & the same Time, 1 & 3, viz. SALT, FIRE & WATER, will fully understand the Difference of HEAT & COLD. It is certain that SALT is an ESSENTIAL FIRE, and to make this FIRE OR SALT spiritual & volatile by the Process of Nature & reduce it to its First Natural cooling WATER, whose interior Qualities are Heat & FIRE or Light of which we have spoken in S. 6., Chapter 2., will also clearly know what Relation SALT has with essential Heat & Cold; we have now said enough of the Nature of SALT, to leave the Subject.

S. 8. We will therefore proceed with other Minerals & other Salts, as far as it pleases God to give us Information, & his blessed Light will permit us to satisfy the Learned & Lovers of Truth; for which it will be necessary to go back to the Origin of COMMON SALT as it is the Base of all other known, as well as unknown SALTS, so

called and all Bodies so called produced from it.

S. 9. That Common SALT is the Base of all other Known & unknown ones; can admit of no Doubt by any experienced Chemist or those conversant in Mines, but we must for certain Reasons explain ourselves clearly upon this Subject & we will first take NITRE or Salt Peter which is not one of the least Subjects to make this intelligible to our Readers, to ascertain which, we must deprive NITRE BY FIRE of all its ACID & volatile Parts, which are the strongest Reasons to prove that Common SALT was a NITRE. Further, take away also its Alkaline Nature & restore in the Room of it its TERRESTRIAL ACID & you have a true Common SALT, with all its contingent Properties. The last may be done by PRECIPITATING THE DISTILLED Part of the UNIVERSAL VOLATILE ACID as you know, and a certain pure MINERAL SULPHUR, COMMON SULPHUR being too impure for this Purpose.

This is a true Process, but we do not believe every one will understand us perfectly, particularly in the last Part; "depriving it of its Alkaline Property, & restoring its TERRESTRIAL ACID", but whoever is a little conversant with the Fine will more easily comprehend it, particularly who understands which we have said in Chap. 1. S. 28.

O (arsenic?) may also be helped by the same kind of PRECIPITATION & a perfect Kitchen SALT made out of it. This can also be done by another Operation, which deprives it of its ACCIDENTAL ACID, and dulcify it, which many know, but not how to change it afterwards into Common SALT. The better to satisfy all Lovers of Truth & of the Secrets of Nature, we will lay down a fundamental Rule that will satisfy every one who has a little Knowledge of the FIRE in Nature, viz. THAT ALL Salts after having passed the last Degree of Circulation, and made Alkalis, then poured in Common WATER, mix this Lixivium with a proper proportion of the SULPHUREOUS Universal Acid, then evaporate, & you will have a perfect common SALT, which will taste indeed a little insipid, but if you repeat the SOLUTION; Filtrate & Coagulate 2 or 3 times, it will be perfectly good. The Description is perhaps too simple for your very wise ones, but that love plain Truth will thank me for it; and find their Account in it but how to give it the last Degree of Circulation and to alkalise it again, shall be shown by an Experiment. Of VITRIOL IN COMMON WATER & boil over the FIRE, while boiling throw in C. V. qs., & let it settle, & you will find all the Impurities separated from it, which could not have been done by a thousand Precipitations, Coagulations & Filtrations. Repeat this 2 or 3 times, & you will have performed a most perfect & uncommon Operation. Whether this VITRIOL IS COPPERISH, IRONISH, or has any other Metal, or heterogeneous Quality interionly mixed with it which is essential to its Metal which its SALT will partake of, we will shew how to deprive it of

this Quality.

Rx. Common SALT *qs.*, Let it melt in a good CRUCIBLE, throw in *qs.*, of CALX VIVA & SAL AMMONIAC, Let them flow a while, if the VITRIOL OF COPPER, take what is contrary to COPPER & is fully known, & throw in as much as the Mass will take up, with a little SAL AMMONIAC, & let it flow till it is thick, then Precipitate (f) the VITRIOL in an IRON Vessel, & Rx. about OUNCE *ij* of this Mass POWDERED & throw it in while boiling for 7 or 8 minutes, let it cool, filter & coagulate & you will have the VITRIOL cleansed from its Metalline Nature & nearly changed to a Common SALT. If it was a martial VITRIOL, it must be PRECIPITATED in a COPPER Vessel, & instead of a COPPER VITRIOL use an IRON one.

The PRECIPITATION which is so difficult to see will be copious & those that understand will learn how to PRECIPITATE the pure Metal from the rich GOLD & SILVER VITRIOLS, & how to make the PRECIPITATION for that purpose, which is no common Experiment & will give a perfect Information how to separate Metals both in the WET & DRY way.

While we mention PRECIPITATION it will not be amiss to say a Word or two to improve the SOHLE, that holds white SALT, & how great Profit may be made by a proper PRECIPITATION, but it is necessary to premise, that the Properties of the SOHLE should be well examined, as SOHLE being found that is pure & homogeneous, for in passing thru the Earth, it has imbibed some Qualities of this or that Metal, or Mineral, which it is essentially necessary to examine carefully. ALL SALT SOHLES are either mixed with VITRIOL, ARSENIC OR NITRE, & with VOLATILE ACID PARTS that are fixed in it.

If there are but one of these Qualities, it is easily remedied, but if 2 or 3 are in it they must be removed by PRECIPITATION, as happened to me in a certain Salt work which converted of the first Saline Essence, which we call Common SALT, (also of a pure VITRIOL, which it gets from very rich and volatile VITRIOLIC Sand, covered by a Dach Coal, which it shoots under as well upon the Veins themselves with which the Salt Springs are inclosed, which generally lay in a bed of perfect volatile COPPER, containing SILVER. Thirdly of a volatile NITROUS Acid which it gets from its own interior magnetic Quality, or original Saline Property which is derived immediately from the Celestial Influx. to help that Sohle we found it absolutely necessary to purify it with SPERMATIC ESSENCE instead of the RINDES FORBEN, the Manipulation of which is to unite the ESSENCE intimately with the SOHLE, by which you produce the Purification; & for this you take the PRECIPITATE of the MICROCOSM P. *ij* of SATURN P. *ij*., & of Amezodan P. *j*. to *j*. P., or 2 & let them flow together, then throw of this Mass into a clarified & boiling Pan of SOHLE *lb*. *j*. *℥*., Let

them mix well together & a very fine & durable white SALT WILL PRECIPITATE from the natural SOHLE drawn from the well; to a great Profit, which WILL ATTRACT NO HUMIDITY, but remain dry Like a Stone, & exceed every other Rock Salt in Purgency & Taste; but some time after when the Workman, who did not know the Manipulation, expected to receive the Profits by the Graduation found the SOHLE already graduated & strong enough, except (the AIR having deprived it of its VOLATILE ACID in the Graduation, viz. the SOLAR Male Seed) there was only a humid LUNAR SALT remaining; when on the contrary by the PRECIPITATION both of them were so purified & inseparably united by their own fixed Magnet as to be brought to the highest Perfection. This is the Method of PRECIPITATING when the SOHLE is poor or mixed with any heterogeneous Qualities. The operator must know how to direct himself according to the Qualities or heterogeneous Particles mixed with it, as he will find in this whole Article, S., on his Endeavours will be to no Purpose; we must also observe that VITRIOLS OR ARSENICIS are of no bad Consequence in the Composition of Common SALT, but if they happen to predominate, or that the Common SALT does not prevail in alkalinity, or that the VITRIOL OR ARSENICIOUS Qualities proceed from the Decomposition of the Metals or Minerals; in which Case they are very dangerous & unhealthy, when prepared by the common Method, but by the Mode of PRECIPITATION mentioned in this S., such SOHLES are perfectly corrected; & made very fit for Health & Preservation. We must further observe for the Sake of simpler People how the Term PRECIPITATION is to be understood; as we do not mean such a one, as that the Salt falls entirely to the Bottom, & that the WATER remains so clearly above it, that you may take it out, & put it into Baskets without any further Trouble, this is not the Case; but that the Lovers of Truth may be assured that the LUNAR SALT is so interionly united with the WATER, that it is very difficult to separate it in the boiling, as may be observed in the Section of the 1st. Chapter & in other Places, & the WATER that evaporates acting as a Matrix comes off with it; the finest Particles, viz. the Male SOLAR Seed; wherefore the first Preparation is only a perfect Separation of these Celestial Influences (the saline ones) from the Materia, i. e., the WATER, with which it is so intimately united; then, according to all our former Dissections both are internally of one Origin & Essence. This PRECIPITATION is also the specific Operation & perfect Separation of the SALT from the WATER, which occasions the WATER to evaporate the easier & leaves a pure crystal behind, & also prevents the finer Particles flying off in the Evaporation, & requires so much less Time & Fuel for the Purpose & yields a much purer & greater Quantity of Salt, than can be obtained by any other Method, but we must not forget to make another Observation that those Salt Springs which consist of the FIRST SALT, AND THE PETRIFYING, VOL-

ATILE, FIXING ACID are much the best, as they are found in various Parts of GERMANY, particularly in AUSTRIA, BAVARIA & SWITZERLAND & other mountainous Countries.

Enough has been now said, upon the Reduction of ALL SALTS to Common SALT, taking Care to ALCALISE them, & then to PRECIPITATE THEM in WARM WATER with the SULPHUR of C. V., mixed with (Wentzel Saure) then inspissate, PRECIPITATE again with common WATER, inspissate again, & you will have a true Production. If you can volatilise this Alkali by a natural Operation & ferment with the Acid of a certain SULPHUR, you will have a better Produce; but perhaps every body will not understand this. This Article is so well explained in Chap. 1., S. 3; as well as in the End of S. 5., of the same Chapter, that nothing more can be desired upon it.

S. 10. That all Kind of Salts may be produced, out of common SALT as in Chap. 1., S. 5., is sufficiently proved, and it is well known by all ruined Adventurers that with common SALT, COPPER OR IRON a perfect SALT may be produced. It is now clearly known from what has been said in Chap. 1., S. 31., that SULPHUR & VITRIOL are two very different things & what SULPHUR is, we have already proved without a Doubt, & that VITRIOL is a SALT generated from Common SALT that is shot by means of a SHARP ACID SALT, from the SULPHUR of DECOMPOSED OR UNRIPE Metals; and the METALLINE PARTICLES being indiscriminately united with the SALT produce a VITRIOL, which on account of these metalline Particles differ widely from SULPHUR. This Difference is clearly shewn by the heavy O (vitriolic acid) whose BASE is nothing but an O (spirit of Salt) CONCENTRATED BY THE METALLINE PARTICLES, & as the same heavy & hot O can be PRODUCED FROM COMMON SALT, so may the O be concentrated upon Lap. Calaminaris. Further VITRIOL may be purified as mentioned in the former S's of this Chapter, & afterwards an OIL distilled from it which will better illustrate what has been asserted in S. 25 of Chap. 1.

That common SALT melted in due Proportion with C. V., & fermented with a little O may be changed in a very short time to a perfect SALT, which every one knows, but I still know a better way, which it is not proper to mention here. I will only observe that whoever knows how to reduce SALT from its Cubic Form to that of ALUM PLUMOSUM, will understand what I mean, & makes it unnecessary to say any more. Again, Common SALT may be treated by FIRE, as to be reduced to a perfect fine ALUM, by Means of PYRITE & URINE, without any Loss, & every Apothecary knows that a pure SAL ARMONIACK may be prepared from Common SALT & URINE. (or Salt of Urine), or Blood & Soot. Again, it has been shewn in the former S., that Common SALT may be alcalised, & again reduced to SALT, in short, by turning the Wheel, with proper Manuductions you may make what kind of SALT you please out of common SALT; & if we are not understood after what has been said it will be in vain to explain ourselves more

upon it, but be assured every thing has been said upon this Subject in the 5th. S., of the 1st. Chapter; & it is sufficient to know that every thing has been originally created by God in a SIMPLE ESSENCE according to HIS LIKENESS, and all Creatures produced from this ESSENCE OR EMANATION from God Himself, as they were formed & named by His Almighty Will & Fiat, as well the Holy Angels as the INFERNAL DEVILS; (in their first pure & celestial Nature, before their Fall & Deviation from Good) with all other Parts of the Creation, as they happen to be, Good or Bad, pure or Impure, or in whatever Sense you please. This Truth being understood that one Eternal Wisdom, One Almighty & Everlasting God, the Creator of All Things both in Heaven above, on the Earth beneath, and in the Waters under the Earth, & which reach to the Center of Hell, & that every thing was good & perfect in its Beginning: But degenerated from its pure State either by the evil Influence of Lucifer or by Mans own Will. It is also a truth that all things shall be restored to their original Perfection, which is agreeable to the Dictates of sound Philosophy. Then if we consider what great Medicines may be prepared from this Red & White SULPHUR of Nature by those who know the true Principles: Which is the greatest of all things except the eternal Medium of the Soul in the Flesh and Blood of Christ, which purifies, & restores every impure & mortal Body, to perfect Health; & that no Imperfection may remain in Nature by Means of this immortal & incorruptible Medicine, & if the smallest Particle of it (which is a fixed SALT an essential & pure FIRE) can perfectly cure every Disease in a short time, how much more can the SALT of the Mercy & Love of Jesus Christ, who is the Light of all Creatures transmute the fallen Nature of Man without any Distinction, & restore every Particle of the Creation to its Original Perfection; because what proceeded from God must necessarily return to him, nor can it be separated from him; otherwise God would be divided; & his CELESTIAL ESSENCE would not be comprehended in his eternal, immutable & inconceivable Circle of Infinity; for God is in Himself pure & perfect Essence & can have no mixed or 2nd. Qualities, being ALL in ALL, comprehending ALL, & sees & directs ALL. Therefore every thing must return to Him, & be made perfect by him, as nothing impure can remain with him, or we must allow Contradictions in his Nature & Essence.

Nor can there be an Eternity of Misery and Corruption with God, but on the contrary a perpetual Redemption thro Christ his ONLY BEGOTTEN SON, who is the eternal SALT of his Paternal Love; by the Power of which all Creatures both in Time & to Eternity will be saved from total Destruction. That is when the dark elementary infernal FIRE with all its diabolical & malignant Effects be swallowed up & destroyed by its own devouring FIRE, which consists of the impure Elements as in Fig. no. 2, 3, 4, 5, viz. or in Heat & Cold or dark SULPHUR & SALT, & shall be so totally envelope

in the natural elementary Qualities on dank & infernal Essences, that not the least Atom of it shall remain & every Desire & Concupisance be Lost, but that of the eternal Light of Jesus Christ; & the whole Creation shall be again renewed by the 4 CELESTIAL CAPITOL STREAMS. See Nos. 6, 7, 8, 9, which reunite in the River which springs from Eden (as is well known to the MAGI, TRUE PHILOSOPHERS, & CABALISTS) & Again, Through this Stream flows in & out, into the Glass Sea, in the Revelations, Chap. 15. See Fig. N. 10., which is the Still Eternal Godhead. See Fig. No. 11., who is the Beginning & End of ALL Essences, IN WHOM, all is contained, & FROM WHOM every Thing proceeds, and TO WHOM, every thing must return again, to partake of this inscrutable & delightful Splendour of Light & WATER; of which St. Paul says, "No Eye has seen, No Ear has heard, & is beyond the Heart of Man to conceive, to which We and ALL who long to arrive at this Height of Happiness thru Christ; may the Father of Mercies lead us thru his Love that he has most gloriously shown us, in his Son, that we may partake of it in this Life, in SOUL & SPIRIT, & that we may feel no TRACE OF HIS JUSTICE after Death, but be purified by the Cross & mortifying FIRE (which passes thru the RIVER OF EDEN) & be swallowed up in the bottomless Sea of his Love. Amen."

S. 11. In Consideration of the last Matter of this S., which has been so often touched upon in the Course of this Work, viz. "The full Restitution of all Creatures to their first State of Perfection", we must ask an important Question, which may give some Alarm. As nothing can be supposed independent of God; but that every thing proceeds from him, and as HE ALONE IS GOOD; how comes it that this Perfection is so corrupted and perverted, as to be so totally lost in SIN & MORTALITY & from whence does the Evil arise, that the CREATURE is so opposite to the CREATOR when Nothing can be but what proceeds from God? Further:

If God had not manifested his Will, in the Redemption through Christ whether the KINGDOM OF SATAN, THE CONDEMNATION OF MAN, AND ORIGINAL EVIL, had equally taken place From all which we may draw this Conclusion: That not only a contradictory Separation took Place in God, & an direct Opposition to his Will, even in Dispite of Himself, & will exist forever, but that it was also ESSENTIALLY IN HIM, & WITH HIM, and manifested itself at the APPOINTED TIME.

Further, we shall treat in the Course of the Chapter, of the wonderful SULPHUREOUS DISTILLED SALT Spirit, the אֶפְרַיִם אֶפְרַיִם אֶפְרַיִם - Aphan mir Ha Adamah of the Paradisiacal EARTH from which the Spiritual Body of Man was formed, & which must again be produced in Him which SALT IS THE PUREST: The most PERFECT, and the most excellent of all Things except the Celestial Body of the Son of God. We shall also fully treat of the Magical & Cabbalistical Characters which compose the

JARGON of the Chemists, but are so obscured and misunderstood thru their Ignorance, as not to have the least Idea of the true Signification.

S. 12. Now to the first Question, whether Almighty God could have prevented this Perversion of his Creatures?

It is out of all Doubt His ALMIGHTY POWER could have done it, if He pleased. Why therefore did He not do it?

I answer: It is not permitted to such a weak Creature as mortal Man to penetrate so deep into the boundless WISDOM of God; and it is Our Duty to look at this astonishing Abyss with the highest Submission, & Fear, least we come too near its Brink, & lose ourselves in a perpetual Gulf of Misery, & fall into a spiritual Vertigo by examining into Subjects so surpassing Our Comprehension; Let us for a Moment consider how it is possible for us who are so inconsiderable a Part of HIS INCOMPREHENSIBLE MAJESTY, to have an Idea at once of the following Number produced from Unity; 100,000,000.000,000,000,000,000,000,000, & to see it in its different Parts, which is a NOTHING compared to the infinite Perfection of God, & tho' a Man is able to comprehend the above Number, & reduce it to Millions, Thousands, Hundreds, Tens, & so on down to simple Unity, yet it is Nothing & far from our Opinion, that a Man should be able to take in at one Idea this Number & see its Relationship at a single glance, which is totally impossible; how then can poor miserable Man be able to investigate or measure even a single Unit of the INCOMPREHENSIBLE NUMBER OF THE DEITY; & how can we give a fundamental Reason how the End is considered with the Beginning, where there is no Beginning but from essential Unity, & which runs on to indefinite Numbers that have no End.

What Folly therefore for Man to encourage such an Idea; & to avoid falling into this Abyss, nor run headlong to eternal Ruin, we must wait patiently & quietly for the Measure of Knowledge it shall please the Almighty to bestow upon us, after our Dissolution, when we may be made Partakers of HIS HOLY REST.

It is impossible that Evil can originate from God, but must arise from the Will of the Creature: As God therefore created LUCIFER & all his Host & gave him Power to rule over what we call The Universe or Our Solar System, & formed him with full Liberty, to serve his Maker, & glorify His Majesty, without the least Control or Compulsion; but Lucifer was so elated with his own Power & Greatness as to give a loose to his Pride, & quit his duty & Obedience to set himself up against the Majesty of his Maker; wherefore it pleased God to make a Separation, of which more shall be said by & by, as far as the Spirit of God shall please to give us Utterance, but it is necessary to premise that for a mortal Man to attempt describing such a Mystery particularly what happened before his Existence, among which the CREATION

& THE FALL OF LUCIFER is not the smallest Part, is but a vain & fruitless Undertaking; & will remain hidden till the full Manifestion of Gods Majesty, & must be totally incomprehensible to us; also why this Pride & Disobedience, as well as why essential Evil was not prevented.

The ALMIGHTY has been pleased to impart to his Creatures, that nothing really exists or can remain but His Own Essence, & that even the KINGDOM OF HELL will fall to nothing, without His divine Permission & must be subservient to HIS IRRESTIBLE WILL & POWER; but that God has given us a Proof of his Greatness in the Person of the Celestial Man Christ Jesus. His beloved Son born from Eternity, as the Reconciler & Mediator of all Creatures, & that without this Medium Man could never have been restored to his first State of Perfection, & reconciled to the Favour of God; & what would have been the Consequence if God had not been pleased to send us this MEDIATOR, whether without Him, the Ruin of Man & the Kingdom of Satan would have been permitted by God to have taken Place forever, are Mysteries which are hidden in the inscrutable Counsels of God, & which we cannot even think of, but with the deepest Humility & Submission; & patiently wait for its Manifestation till the FULLNESS of Godhead Christ Jesus shall please to explain it according to the Powers each has of receiving it, & the Knowledge of these Mysteries are imparted to him. These Points indeed we might be able to answer thru the Mercy & Goodness of God, to the very terrible Opposition mentioned in Chap. 2. S. 2., not doubting but that every one whose Hopes rest in God, will be satisfied with me, till I shall, be able to say more upon the Subject in the following Part thru the Grace of the Holy Spirit in Christ Jesus.

S. 13. Of the SULPHUREOUS DISTILLED SALT, on the Aphon min Ha Adamah on Paradisical EARTH (S. 11.) Having already said enough of the Beginning of things when the Lord God made the Prima Materia (from which all other things were formed) & is a celestial SALT OR FIRE OR WATER, & every created thing which has a Name which are also SALT, WATER OR FIRE: We would also treat of these at large as being the ultimate End & Design of the Creation: Only what has been already said will have sufficiently satisfied those that understand it, as for the perverse, wicked & perverted Part of Mankind, nothing is here written for them, and every one may think of it as he pleases.

S. 14. Of the Origin of the Magical & Cabalistic Characters with which the true Magi and Cabalists have shewn the Rise & Separation of the Elements, & all other things arising from them, shall be differed to the next Chapter. In the mean time we hope to have sufficiently fulfilled our Promise at the End of the S. 5., Chap. 1., & that those who understand me & are Lovers of Truth are satisfied. To please

every body is neither in our Power or Inclination; therefore instead of this Treatise, a Work of many Volumes would have been required, besides we have the particular Satisfaction of having put together more than ever was known to the World.

OF THE USE OF SALT.

CHAPTER 3.

S. 1. There may be several curious and subtle Enquines in the Chapter relative to SALT, that may appear to be of no Kind of Use; but those that know how to distinguish the Good from the Bad, will season their Meat accordingly, but this is the least Advantage arising from this Subject, which is indeed so very useful & necessary, that no Creature can exist a Moment without its Influence.

S. 2. SALT is always taken Notice of as a most necessary Thing, as well in the Writings of the ancient MAGI as in the Original Jewish & Vatican Churches, as may be seen in all their sacred Writings. St. Mark, says: All Men must be seasoned with Fire, & all Sacrifices with Salt, and enough has already been said to prove that FIRE & SALT are One & the same Thing. Christ says: None are good but God. And in another Place: Salt is a good Thing. Hence the early Christians learnt from the Jews, that no Service could be paid to God, without FIRE OR LIGHTED TAPERS, which are still in Use by several Sects in their religious Ceremonies; which is only a well derived Custom, or rather an Abuse of one taken from the Anti-Christian Forms; and a Specimen of the Faith of silly People.

The first true Believers held (& it is practiced to this day by the real Magi, in their private Prayers) that no Adonation should be paid to God, without SALT & FIRE; (not that the Essence of God could be compared to natural FIRE AND WATER) and they remembered also that in the personal Appearance of the MAJESTY OF GOD to Men, it was always in the Form of FIRE. GOD calls himself a Consuming FIRE; a Light that no One can approach, and it is still the Custom in the Christian Churches of the East, to baptise with FIRE & WATER. In the Beginning of Christianity, they always used SALT at Baptism & when the Infant was dipped, the Priest took a little SALT, & put it in the Childs Mouth, with these Words: Receive the Salt of Wisdom, which is as much as to say, that as surely as the Child received SALT from the Hand of the Minister (besides strengthening and preserving his Body) he as surely received the SALT of Eternity, Christ Jesus, at his Baptism, for his eternal Salvation.

SALT has always been held in the highest Estimation at all times, by all Nations & Religions; and the most ancient GERMANS always set SALT the first upon the Table at all their Meals which is still practiced in many Places to signify GODS Presence & Blessing; moreover, as all Creatures were at first produced from this perfect Part of Nature; and interiorly consist of nothing else; we therefore ought in Duty before

we eat & drink to make an Oblation to the DIVINE MAJESTY of this Offering of our Lips; seasoned with the ardent Fire of the Spirit; and as our Meat is seasoned with SALT to strengthen our natural Body; so may the Mercy of GOD season our interiour & immortal BODY, SOUL & SPIRIT with the SALT of Our Saviour Jesus Christ, to the Continuance & Participation of his eternal Glory by the Words He pronounced in Matthew, 4: Man shall not live by Bread alone, but by every Word that proceeds from the Mouth of God: Therefore, Christ in his Summary of all Prayers has commanded us to say; Matt. 6. & 11. Give us this day our daily Bread, on what soever is necessary for us, in which Words is not only contained our daily corporeal Food, but also the Food of the interiour Man; the HUNGER & THIRST OF THE SOUL & SPIRIT.

They also left the SALT the last Thing upon the Table as a Memorial of the same Duty, by offering up a Thanks-giving or fervent Prayer for the good Creatures GOD has been pleased to give us for our Food & Preservation.

S. 3. It is very well known to all good Chemists, that every Body is purified by SALT; that is by FIRE; and at one time or other the whole Creation will be purified by SALT OR FIRE; hence is explained what St. Paul says, 1. Cor. 3. V. 12. to 15: If any one should build upon this Foundation, Gold, Silver, Precious Stones, Wood, Hay, Stubble: Every Mans Work shall be made manifest; for the Day will declare it, & it shall be shewed by FIRE, for whatever each Mans Work is, will be proved by FIRE: If any Mans Work that he has built shall remain, he shall receive his Reward; but if any Mans Work shall be burnt, he shall suffer the Loss; but he shall be saved also by Fire. There is no cleared Expression upon the Subject in all the Scripture; nor one that contains deeper Mysteries; but the wise conceited World; tho' in fact blind as Beetles take every thing according to their preconceived Ideas, & therefore misunderstood this Fiat totally. Every Vessel that is used by the Jews, that can bear the FIRE & that requires cleaning, is done by FIRE.

The PERSIANS hold their Onim arda so sacred, that it must only be used for holy Purposes under Penalty of Death; & their KING has this FIRE always carried before him; at which time every Body that passes by is obliged to stop, out of Respect & Devotion to their GOD. The same Respect was paid to FIRE by the EGYPTIANS, CHALDEANS, ASSYRIANS & MEDES, and what is more, the burnt Offering in Elias' Time at the Consecration of Solomons Temple, was set on Fire & consumed by the FIRE of Adonai, & this Unim Asch Jah, likewise consumed the Offering upon the altar at the Consecration of the Tabernacle as may be seen in Numbers, & this holy FIRE was always kept up by the Priests of the LORD. Also in the Time of the Asonances (commonly called the Macabees, from the Symbol in their Standard) it was customary as we see in the 2nd. Book Chap. 1., of the Maccabees, that Nehemiah (who knowing the Place where the Priest

by Order of Jeremjah the Prophet had hid it, found it in a Ditch of slimy WATER) brought this FIRE, & threw it upon the Altar, & rekindled the Offering with it, & it was so preserved till the last Destruction of Jerusalem.

From these Words (Unim Asch Jah) the FIRE of the Lord) the Persians in their Language called it Onim arda, & it was held by them in the highest Degree of Veneration. That this FIRE was a true SALT has been proved beyond Contradiction in Chap. 1., & particularly in S. 18 & 19., and also that the Gates of Hell could not prevail against it.

Here a great Mystery offers itself for our Consideration, namely: For what Purpose this SALT was always used in the Burnt Offering?

It has just now been said that the FIRE of the Lord consumed the Burnt Offering at the Consecration of the TABERNACLE in Solomons Temple, & that all the Wood upon the Altar was burnt, which FIRE was continually kept up WITHOUT EXTINCTION. This terrestrial SALT is the terrestrial & corrupt Men who must be consumed by the FIRE of GOD (which is SALT, or his Mercy). Therefore St. Mark says, All Mankind must be seasoned with FIRE, & every Offering (of the Lips) with SALT, or with a broken & contrite Heart, in a fiery or fervent Spirit. But that this sacred FIRE has perpetually existed is PARTLY proved by his merciful Kindness having been perpetually shown to us, & PARTLY that it will forever exist towards us, by the continual Offering up of our most fervent Prayers to God for it.

These Observations arise from the holy Love of this FIRE; which may be carried much farther by the Magical & Cabbalistical Application of it, which shall not be mentioned at present but we will proceed to what the Spirit of Wisdom vouchsafed to explain to us in the following Pages.

S. 4. SALT is applied to many useful Purposes besides its use in the Kitchen.
The common Miner

Note. This is the end of page 215 of the Manuscript, the next page is 216 which is missing & so we will continue with 217. If I can obtain this page I will insert it later. D. H.

salubrious FIERY WATER from the PRINCIPAL RIVER of Eden, which is in the Power of those only who know where to find it, & what Use to put it to.

All barren Ground is made fruitful by this rich Manure. And brings VEGETABLES that are ALMOST DEAD to Life & Virtue.

The Spirit of common SALT will not only preserve Health, but is also an excellent Medicine in grievous Disorders; which many able Men have written upon, but the Spirit made from SALT & C. V. mixed together & melted as above mentioned is a very extraordinary Medicine, and a great Preservative, & next in Virtue to the SALT ENIX-IUM.

The ancient Egyptians used to preserve their Dead in the most Perfect Manner, in which Mode of embalming, SALT had the greatest Share. This Art was also in great Use with the Jews, but which of the two were the Inventors of it is not to be found in History; it is sufficient to know that SALT was the principal Ingredient in the Composition, & as the Art is in great Measure lost, it would be greatly to the Credit of ingenious Men if they would endeavour to recover it.

EMBALMED BODIES called MUMMIES are still found in EGYPT in a Case of pure BALSAMIC GUM, like a fine clear Varnish, & the SULPHUREOUS SALINE Substance which was used for this Purpose is so compact as to prevent putrefaction to the Body, which it preserves also from falling to Dust; & gives great Scope to examine how we can imitate it, & recover the Secret.

In many Parts of Germany where Battles have been fought a Long time since, Bodies have lately been found as fresh & unconsumed as if but lately buried, for which no other Reason can be given but their being surrounded by such a Kind of Sal enixum, produced by Nature in those Countries as has been already mentioned in S. 4 & 9.

Without the Assistance of SALT neither Man or Beast could exist & without it, numberless Diseases would prevail in the world, which does not at all interfere with what is said of the Inhabitants of Africa, who never use Salt, who living always in a very hot Climate & where the Sun is so very predominant power, are of a very different & particular Constitution of Body, from those of our cold Climate, where the Lunar SALT only predominates, which is not able to preserve us from the scorbutic Disorders that makes such Havock among us, particularly in those Countries that border upon the Sea & HOLLAND, is a sufficient evidence of this Assertion, where there is scarce a single Person, & particularly among the Community, that is not more or less affected with this Disorder; for which no other Reason can be given but that the AIR of that Country is not so full of the Solar Atoms; and not that the Heat of the Sun there is not so effectual as in the hotter Climates; besides, the Ocean, & Countries bordering upon it; which are full of brackish WATER, attract the Solar Atoms floating in the AIR, & absorb them like a Magnet, of which the fertile Soil of the Netherlands, as well as the excessive Plenty of Fish in those Seas clearly prove; and what remains in the AIR is only the Lunar Seed or SALT, which is incapable of nourishing as has been fully demonstrated in S. 18 of Chapter 1.

Now as the MAGNET, or attractive Medium of MAN, like that of the MACROCOSM, is continually endeavouring to attract this SALT of Life for its own particular Use, but cannot succeed, because the MENSTROUS Lunar SALT which has very few Solar Atoms mixed with it cannot supply & nourish this Body, it must therefore produce only a phlegmatic, foul Blood & Habit of Body, from which this horrid Disorder called the

SCURVY takes its Rise; it did not therefore originate, as has been supposed from the Use of too much SALT, or from the eating such a Quantity of SALTED FLESH OR FISH (as many absurd & foolish People pretend to say) nor will we assent that too much of this Food is not very unwholesome, but still it is very different from the prevailing Opinion, viz. That both in Flesh & Fish when salted, the sweet nutritious Juices are dissolved & absorbed in the melted SALT (which is seen by the Brine, for if you throw this upon NITROUS EARTH it wonderfully assists the Generation of NITER) and do not remain in the Meat; as the SULPHUREOUS alkaline Body does, which we call EARTH, on which the male Solar Particles of the SALT unite themselves & fix, contract & dry up the Body, and prevent its being so able to receive the distilled Menstrual Lunar EARTH OR SALT; & this will make us better understand in what has been said of the Composition of SALT in the 1st. Chapter, viz. & the following Question.

Q. What is the peculiar Effect of SALT in pickling?

A. It acts as a Menstruum upon the Lunar Atoms and dissolves them, being the Bond of the Body, & consist of these inclosed spirits of Life, which contain both the viscous SALT, & sweet Juices. It penetrates thru the Pores, & acts in Opposition to the SULPHUREOUS SOLAR Atoms, that were intimately united with the menstrous SALT in the Flesh or Fish, and were carried into the Pores of the abundant terrestrial Body (which consists only of a FIXED SULPHUREOUS Alkali) and expells all the menstrous Humidity; the better to resist the Corruption proceeding from it.

The Flesh & Fish, whose Essential & spiritual Juices are set at Liberty by the SALT, give only impure Faeces & by no means any Nourishment, & consequently must produce gross phlegmatic & scorbutic Humours; we flatter ourselves that what has been said upon this Subject will be well received by all who investigate the Secrets of Nature; however it may be laughed at by the Children of Folly & Intemperance; we can only say to these last, that we hope they know a better Method of curing those noxious Diseases called the SCURVY, DROPSY-GOUT, & other ALCALINE DISORDERS generated by foul & viscous Flegm & Obstructions, indeed by the Assistance of specious Language, they lay at ease upon their Beds & assert without any Remorse, what a true Philosopher cannot acquire with all the Trouble he puts himself to in following the direct Road of Nature, & we may venture to say that among the ABLEST & BEST PHYSICIANS, there are not above One in Two, nay we may say Three, that know how to cure disorders radically; which is done by the Universal MERCURY, the red & white SULPHUR of Nature, which we have already mentioned in this Chapter; & which is found in ALL CREATURES WITHOUT EXCEPTION, in some however more than in others. If you are Master of these MERCURIES & know how to apply them; observing that the white or

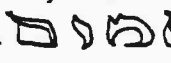
Lunar operates in DRY DISEASES, & the red on Solar in COLD & phlegmatic; & you may be sure no Disease will be able to resist you, & all Quacks would in this Case become good Physicians, which last deserve great Credit, but as to your Dealers in the 4 Qualities, with their different Degrees of HEAT, COLD, DRY & MOIST in all Bodies, they are only subtle & foolish Assertions, to impose upon the world, with a View of acquiring Reputation upon false & specious Principles under the Pretence of understanding the Secrets of Nature; who knows nothing more than Light & Darkness on Heat & Cold, which are also Dry & Moist, which belong equally to all Diseases of the human Body. The Learned may dispute as long as they please, it will only prove a Jargon without any reasonable Conclusion, as all Diseases proceed from the Disorder of our natural Magnetism which is the CENTRAL SALT OF LIFE, and if once indisposed, & either the Solar or Lunar Qualities prevail, whether we are totally hot or phlegmatically cold or have any particular Disorder upon us, as Leprosy, Gout, Scurvy, Pox, & C., or Fever, Dropsey & C., they have their source in either HEAT OR COLD, MOIST OR DRY, more or less, and it often happens that when this wonderful Magnet of Ours is in perfect Unison, by some Accident of either moisture or Heat it is suddenly dissolved by the Solar or Lunar Menstruum & becomes immediately subject to most fatal Disorders, which indeed may be perfectly cured, if this our natural SALT of Life, this WONDERFUL MAGNET, which shews itself continually in Us, through the Celestial Nourishment of the  (Schamajim) is restored to its proper State, & Order, but how few are there that comprehend it? Hence the wise Theophrastus who has written upon the TARTAR of the Microcosm, & of the resuscitated SALT is so little understood but the world must be deceived, as mankind always prefers Falsehood to Truth.

S. 5. Every DYER, GLASSMAKER & other Mechanics who get their Bread by it know best what sort of a Thing SALT is, and it is agreed that Salt is the Treasure & Riches of the World; & we will be bold to say, No Creature can do without it, it being as necessary for him, as the INCOMPREHENSIBLE GOODNESS OF GOD, from whose Emanation SALT proceeds. It is THE KEY OF LIFE AND DEATH, which Word includes more than the simple & natural Man can believe or understand, without SALT there can be no TRUE SOLUTION OF BODIES in all Nature, but this is said to those WHO UNDERSTAND THIS MYSTERY, for it will remain a secret to all worldly Men.

We know a contemptible SALT which has PER SE the Power of curing all Diseases; and is at the same time as mild as Spring Water, & in which the most perfect Metals, viz. GOLD & SILVER will dissolve like Ice, & be reduced to their original saline Essence or UNCOAGULATED red & white SULPHUR of Nature, or the First MERCURIAL SALT, which is Schamajim from the River PISON which waters the Land of Havilah (we call it here SALT, which must be rightly understood) & dissolves all Bodies, & reduces

them to their First Matter, and this SALT will by means of the FIRE, fix all Bodies, & they will remain so forever; but how few are there who believe that the Eternal God has been graciously pleased to give this extraordinary Power to his poor mortal Creatures; he however who knows SALT well, and the FIRE of which we speak (which FIRE may be perfectly known by its Root, if it is not understood from itself) will easily be convinced we speak the Truth.

SALT is all that is precious in all Creatures, that know, fear, and Love God.

SALT dissolves & coagulates all SULPHURS by those who are well versed in FIRE & from its Simplicity it might also be a SULPHUREOUS Alkali; & whatever this fixed & unchangeable SALT does not act upon, remains in the Corruption of the Elements, & must go to Ruin.

SALT is the only strong Bond that chains the EVIL SPIRITS in the AIR, WATER, EARTH & FIRE, whose ESSENCE is a CONGEALED DARK & DEVOURING FIRE, according to the Quality of each Element in which they are confined, (See Chap. 5. S. 11.) & by which all Light is contrivally held and reversed. Nay, Hell itself with its devouring SULPHUR which is the ESSENTIAL FIRE OF LUCIFER & his ANGELS, is fast bound by this SALT, we having proved that every Element interiorly is nothing but SALT, and that all their Productions COMPOUNDED OR SIMPLE are nothing else.

That, the Terrestrial Globe, is SALT to which every Kind of SALT, is distinguished belongs, is sufficiently deduced in the 1st. Chapter; from which, and the SYSTEM OF THE UNIVERSE FIG. 1., & the Description of it, the whole may be understood as well as by what shall be said upon it by & by. LUCIFER remains bound in the GREAT ABYSS, till his VICE-GERENT, THE OLD DRAGON BELZEBUB is cast down under him, and a SEAL set upon him Revelations 20. V. 3. And after this he must be loosed again for a certain Time, & be more furious & fiery, because his Fury which had been long confined in the fiery Abyss, having received fresh Strength from his MASTER LUCIFER will be more vehement and pointed, but LUCIFER himself must remain bound till the GREAT DAY OF JUDGEMENT by Him, who lives for Ever & Ever when all THE ELEMENTS AND CONDEMNED CREATURES with the DEVILS will be all confounded together in one Heap of MORBID MATTER, & consumed by His AVENGING FIRE (at which Time the Expansion, Schamajim will cling & be dissolved) which is Justified by the Name of HELL, on the consuming FIRE of Gods JUSTICE, & perpetual Torment be inflicted upon the rebellious Angels; and all the Elements be mixed together in CHAOS & remain so to the END OF TIME, and what is written in the Revelations Chap. 10. V. 6. shall be brought to pass, That henceforward Time shall be no more, that is, till the FIRE of VENGEANCE & HELL, has consumed the CURSE OF THE ELEMENTS with all its PRODUCTIONS OR DARKNESS and the SOULS OF THE WICKED that have followed the Works of SATAN with every thing that is

DIABOLICAL shall be consumed, & by that Means restored to its original & essential Purity, in the PURE STATE OF REST in the Mercy of God, which can only be done thru the Medium of Christ Our Saviour, all which shall be fulfilled, & the Form of the Devil changed, and all his Kingdom reduced to Nothing, & Darkness shall roll in upon itself, & for want of Nourishment be changed to Light, when SATAN with his MILLIONS OF SPIRITS shall see and lament their miserable Condition, and ardently wish to be restored to his original Excellence and humble himself before the God of Victory, who is the Lord of all Power and Might, & glorify His most Holy Name, before whom, every thing THAT IS IN HEAVEN, OR ON EARTH, OR IN THE WATERS UNDER THE EARTH, OR EVEN IN HELL, must bow down, & worship. Then will this CHIEF OF THE FALLEN ANGELS, with all his Host, again obtain Mercy. Thru the MEDIATION of Jusus Christ and be admitted again thru His Blood (without which no Grace can be expected) to the HIGH ANGELIC STATE HE FELL FROM & shine before the Throne of God his Creator, with all the numerous Hosts of Angels that shared in his Disobedience and Punishments. Then will be fulfilled what is said in 1. Cor: Chap. 13. V. 23 to 28. But every Man in his own Order. Christ the first Truth, afterwards they that are Christs, at his Coming. Then cometh the End, when he shall have delivered up the Kingdom to God even the Father, when he shall have put down all Rule, and all Authority, and Power. For he must reign, till he hath put all Enemies under his Feet. The last Enemy that shall be destroyed is Death. For he hath put all things under his Feet, but when he saith all things are put under him, it is manifest that he is excepted which did put all things under him. And when all things shall be subdued unto him, then shall the Son also himself be subject unto him, that put all things under him, that God may be All in All.

Zachariah. Chap. 14. V. 9. And the Lord shall be King over all the Earth; in that Day shall there be One Lord, and his Name One.

Revelat: 21. V. 4 to 6: And I saw a new Heaven, & a new Earth, for the past Heaven & the past Earth were passed away; & there was no more Sea. And I John saw the holy City, new Jerusalem coming down from God, out of Heaven, prepared as a Bride adorned for her Husband and I heard a great Voice out of Heaven saying: Behold! the Tabernacle of God is with Man, & he will dwell with them & they shall be his People, & God himself shall be with them, & be their God, and God shall wipe away all tears from their Eyes; & there shall be no more Death, neither sorrow, nor Crying, neither shall there be any more Pain for the former things are passed away. And he that sat upon the Throne, said, Behold! I make all things new. And he said unto me, Write: for these Words are true & faithful. And he said unto me, It is done, I am ALPHA & OMEGA, the Beginning & the End: I will give unto him that is athirst of

the Fountain of the Water of Life freely.

Chap. 22nd. V. 1 to 5., particularly in the Beginning of V. 3., And he shewed me a pure River of Water of Life, clear as Crystal, proceeding from the Throne of God & of the Lamb. In the midst of the Street of it, and of either Side of the River was there there the Tree of Life, which bore twelve Manner of Fruits, & yielded her Fruit every Month & the Leaves of the Tree were for the healing of the Nations. And there shall be no more Curse; but the Throne of God & of the Lamb, shall be in it; & his Servants shall serve him. And they shall see his Face, & his Name shall be in their Foreheads. And there shall be no Night there, & they need no Candle, neither Light of the Sun, for the Lord God giveth them Light, & they shall reign for Ever & Ever.

And there shall be no more Curse, we cannot otherwise describe these words then by saying. It is AN INCREASE OF TORMENT FOR EVER & EVER, on an incomprehensible Evolution of Time which cannot be described, we must therefore wait with Fear & Trembling & throw ourselves before HIM WHO SITS UPON THE THRONE, WHOSE KINGDOM IS AN EVERLASTING KINGDOM & who alone has in his Hand the Key of DEATH & HELL, who SHUTS AS MAN OPENS, AND WHO OPENS AS MAN SHUTS (before the appointed Time) to WHOM BE PRAISE & HONOUR & GLORY from all Creatures without Ceasing. Amen. HALLELUJAH.

S. 6. Hitherto very little has been said of the inconceivable advantage of SALT which the blind world pays so little Attention to, tho' it is so wonderful a Production among the works of God, and indeed enough cannot be said of its Nature & Essence; but it is unfortunately the Custom of the world to set a small value upon the best of things, tho' so many wonderful Circumstances are continually passing before their Eyes.

S. 7. It is time indeed to put an End to this long dissertation upon SALT, which we have so constantly declared to be the Origin & End of all Creatures, and we will do it in the Close of this Chapter, but a word or two must first be said upon its SIGNATURE, which we have already proved is CUBIC or QUADILATERAL.

In Chapter 1. S. 3., under No. 1., we have said that this Cubic Figure is a Mark of its being an earthly Body & heavy; & that its CUBIC Form is a Sign of its TERR-ESTRIAL Nature is best proved by common SALT, as you may see in S. 1., Chap. 2., for though the EARTH is round, this Figure is not essential but accidental to it, and happened from its very particular Properties. The Figure of true Virgin EARTH is CUBIC as well as of other regular irregular Mathematical Forms with Rays interspersed on it may be seen by a good Magnifier, that there is not a grain of SALT that is not angular, which sufficiently proves our Assertion, whatever your critical Defence may say upon the Subject.

S. 8. Farther, the Figure of a Square is a Sign of weight, as a GLOBE (which is the Figure of FIRE & WATER) is a Sign of Velocity, which is to be demonstrated. All Mathematicians know that no active Body can move by its own Power, on Account of its Gravity, but in a perpendicular line, and this Motion is not always purely absolute, but depends upon the Ratio of its Gravity, & the aforesaid Line, for pure & absolute Motion consists only in the Free Will of the Creatures; which may also be proved Mathematically.

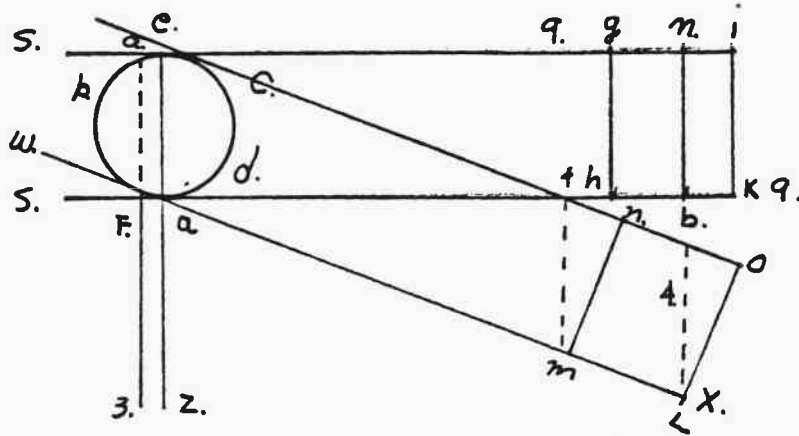

No. 12.

Let the given Superficies S. 9., be so horizontal Fig. 1. N. 12., that it does not in the least incline, if you set a perfect Globe upon it at any Point, THE POINT OF REST a on the PERPENDICULAR e.a. is the POINT OF GRAVITY, and remains at rest, all which is easily comprehended by every Man of common Sense. It is therefore demonstrated that if you let fall a PERPENDICULAR a.z. from the HORIZON S. 9. it will form one & the same Line with the DIAMETER of the GLOBE a.e. and that the GLOBE, b.c.d.a. must remain equally at rest, upon the PERPENDICULAR a.z., at the POINT OF REST a., as upon the HORIZON S. 9. The CUBE h.g.i.k. has the same Properties of Rest upon the same horizontal Line S. 9. and the Perpendicular n.l. is in the Point of Rest l. which is the Point of Gravity. Therefore a Ball of several hundred Pounds weight, and a Cube of the same weight upon the same plane will both have a common Horizon; which is almost a self evident Proposition.

Again, Let the Superficies W.X. cut the first Superficies S. 9. between f.a., then the Point of Rest of the Ball a.b.c.d. and the Point of Gravity of the Superficies W.X., is at the Point f., from which Point let fall a Perpendicular f. 3., from the Horizon S. 9. & it will be parallel to a.z. It is then clear that in the

Ratio of the common Gravity $f.e.c.a.$ the Ball at $f.$ cannot rest any longer upon the Perpendicular $f.c.$, but will move from it, and run to the Point X . Now a Cube of the same Weight $L.m.O$, would not have the same Properties, as it rests upon the Horizon $W.X.$, but not upon a Point as the Ball does, but upon its own Plane $L.n.$, which besides the Portion $n.b.O.$ is charged with the whole of its weight of Air $L.4.m.$, which is perpendicular & is increased by the Momentum of the inclined Part $n.b.O.$, but yet it cannot move forward by its own Gravity without some extraneous Motion to assist it, upon the same Principles as the Ball being pressed down upon a particular Point of the whole of its Gravity, & by the additional weight $f.e.c.a.$, of the other Half $a.c.d.$ it cannot so soon be impelled from its first Point to another, nor on Account of this Gravity can it be prevented drawing on continually to a fresh Point, till it is retarded by some Resistance.

Moreover, that the Cube $L.m.n.O.$ can move easier upon the Surface $W.X.$, which forms an acute Angle with the Perpendicular $a.z.$, than it can upon the horizontal Surface $S.9.$ is clear to every Mathematician, as we know, a heavy Body runs much easier down a Hill, than upon a Plane, and this Motion of the Cube inclines much easier to the Perpendicular $a.h.$, the more the Surface $W.X.$, is pressed upon by its Gravity as in Fig. 13., till at last it stops no more, but inclines with all its

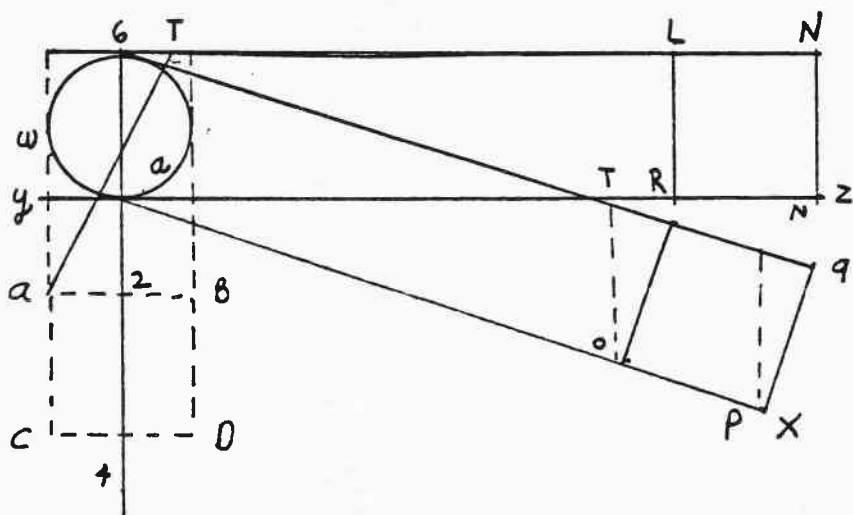

Fig. 13.

Force to the Perpendicular $a.h.$, but tho' this Motion is occasioned by the Gravity of the Body, it is not a simple, but a compound Motion. For Nature admitting of no VACUUM, nor comprehending one, every Space is filled again the Moment one Body has quitted it as $a.z.$, Fig. 13., which Succession takes Place in Proportion to the Velocity the Body falls with as may be seen, N. 14. where $b.c.d.f.$ is the EARTH,

and *c* the Center to which all Bodies, compounded of the Elements naturally tend. *A.* is a Body that falls from a Height *g. h.* towards the Center *c.* on the Surface of the Earth *d. e. f.* Now as the Air which surrounds the Earth from a Conic Figure with the Center, as is seen by the Cone *g. h. c.* it is easy to conclude that the deeper the Air presses into the Cone with the falling Body *a.*, and the Vacuum is filled, the more the Air in the Cone will be pressed to the Point *c.*, and the violent the Fall of the Body will be & hence the Motion of Bodies is concluded to be in the Ratio of their respective Gravities, and as there is no pure absolute Motion in inanimate Nature, it follows that the more the Line in which the Cube rests inclines to the Perpendicular *e. h.* N. 13., the easier its Motion will be as may be seen in the same Figure is here *W. X.*, is the Line of Inclination upon which the Body rests, its Motion being accelerated by *p. s. q.* & the Air *C. T. R.*, what follows close upon it; & the more the line *W. X.*, inclines, the more the Perpendiculars *p. s.* & *O. T.*, add to the Momentum of the Cube, and accelerates its Fall, it is hence evident that the Cube is a Mark of Gravity, & that there is no Body at the same time more void of Motion, which it was our Business to demonstrate.

S. 9. We will now proceed to its SIGNATURE. The ancient Magi, & the Cabalists of all times have signified the Elements & 2nd. Qualities by certain Signs and Characters, to shew their glorified Forms, which the Philosophers and Chemists have since followed, but their Imaginations being filled with strange Conceits, the Truth has been obscured under the Signature of foolish Characters. The old Magi & Cabalists characterised Salt as in the following Fig. No. 15., by a Cube, and with great reason

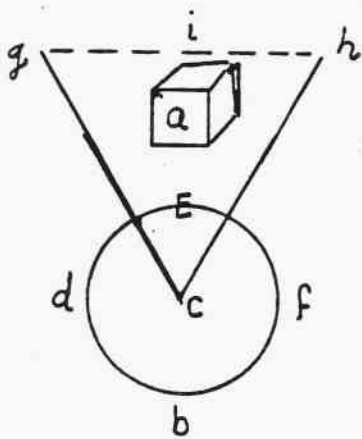

Fig. 14.

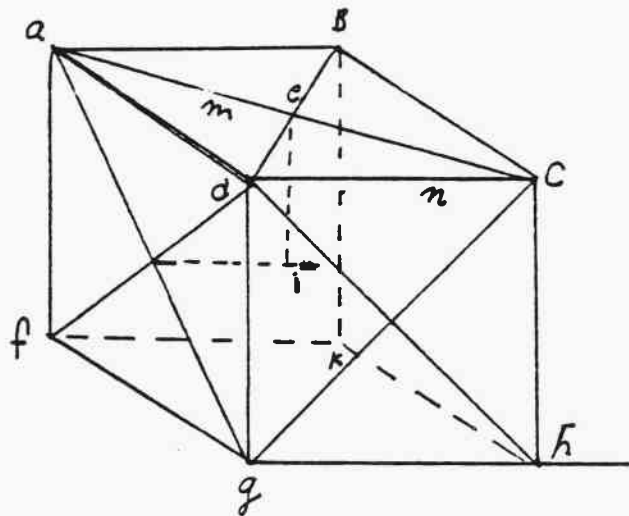

Fig. 15.

as they explained and signified by it, The Secrets of the Whole Creation.

The Cube has 6 sides which is the Number of the 6 Days of Creation, & 1 is the Point of Rest on Sabbath, & take which side you will you have the Characters of the 4 Elements marked upon it from the primary Character of FIRE, which evidently proves that Salt was the first created Substance or Emanation from God which the Holy Writ calls THE SCHAMAGIM, from which again all creatures were formed, & we are also specifically marked with this Character in which all the Creation is concentrated. Again, the CUBE, is composed of 12 PARTS, each of which have 6 SIDES, and these 12 Parts are the 12 principal COLLUMNS of the TRUE & INVISIBLE CHURCH & these 12 Bodies again multiplied by their 6 sides compose the Sacred Number 72., which is a mystic Number and is the 24 Elders of the first Churches multiplied by 3. The true Magi have also signified by this Figure of a CUBE, that no Figure is perfect however minutely divided, separated & reunited again, but the CUBE which is composed of 12 Parts, each of which consists of equalateral TRIANGLES which can only be described from the CENTER or Unity.

Also 3 are formed from 1 & 4 from 3 & 1, which 4 multiplied by 3 makes 12, & this last by 6 gives the mystic Number 72.

Again, the CUBE is composed of 6 PYRAMIDS according to the side of the Cube, which meet at the Center t., as the Point of Rest. These 6 PYRAMIDS (each of which consist of 4 TRIANGLES, which shew the 4 Elements) signify at the same time the 6 Days Work of the Creation, and the 7th. Day is the Sabbath by the Point of Rest in the Center; which 7 is the Holy Number is the Number 7 multiplied by itself shews the mystic signification of Eternity, which also shews the Revolution of Time to the Restoration of the Creatures, to be 5,764,801 Years that is 50,100,000, which is the GREAT JUBILEE & 700,000 Years, which is the Great Sabbath, but it must not be supposed we speak of our NATURAL YEARS & TIMES, having made use of these Terms because we can not find (after the Destruction of this visible & corruptible World, in the New Jerusalem, where neither sun or Moon shineth, as the Brightness of God, enlightens it, and where the Lamps are the Lane, as in Revelat. 21. v. 25.) a Term to express the Time of the Duration (of the Curse) from which by Degree all Mankind shall be restored to their original State & be happy forever. In the remaining 64,800 the fallen Angels will recover their lost State, and in the 1 remaining Year, the FALLEN SON OF THE MORNING LUCIFER, who is the Origin of Corruption will remain alone in Misery & Torment, as the last of WICKED SPIRITS & the Marks of GODS ANGER and continual an Example to fallen Creatures in inconceivable Pain & Misery, in full Consciousness of his wretched Separation, & cut off from the

1-7
7
2-49
7
3-343
7
4-2,401
7
5-16,807
7
6-117,649
7
7-823,543
7
5,764,801

Source of LIGHT & LIFE, till he is quite sensible of his Wickedness & Fall, and after eagerly wishing to taste the Mercy of God in J.C. when he shall be restored to his original Dignity Light & Glory, when also the predestined Mysteries of Our Solar System shall be fulfilled, & God shall be ALL IN ALL, & there shall be no more DEVIL, nor shall DEATH & HELL exist any longer, but all shall be completely purified in this tremendous Revelation, & remain in full Enjoyment of Peace & spiritual Happiness at the central Point of Rest, which is in God for Ever & Ever.

That these things must come to pass are pointed out in the Holy Scriptures, where we so often find, The Words for ever & ever, & That the Fine of their Torments is for EVER & EVER or From the Beginning to the End of Time, which means an inconceivable Duration, & that this will be the Case may be concluded from the figured Repetition of this terrible Menace, and though these Times are only described by certain Numbers merely to express a long Series (because the Distinction of DAY & NIGHT, of YEARS & TIMES will then be no more) as we have no Idea of what is meant by ETERNITY from any Measure of Time here, which is divided only by the SUN, MOON & STARS all these Durations which we call Time, being nothing in the Eye of Almighty God, as is said in the Psalms, 90. v. 4., A thousand Years in thy Sight are but as Yesterday, seeing what is past as a Watch in the Night; but there is something here according to the present Changes of the World, which is not only incomprehensible, but no Name can be found to express it, which is, that according to our Ideas, the constant Duration of the SUN, MOON & STARS with their Changes is held as a Certainty; but by this System all doubt is at an End, & we must abide by the alone Assentation; we do not mean to interfere with the Opinion of those who hold this Time of Purification to be the Great Catholic Year of 7000 multiplied by 70 making 49,000 till the Great Jubilee Year of 50,000 when every one shall be restored to Happiness, as is said in Leviticus 25. v. 8: And thou shalt number 7 Sabbath (weeks) of Years unto thee, 7 times 7 Years, & the Space of 7 Sabbath of Years shall be unto thee 49 Years, no positive Ordinance in the Old Testament having intimated this as a great Mystery.

Again, these 6 Pyramids or Days of the Creation correspond so exactly that one does not in the least exceed the other by 1/1000 of an Atom of a Sun Beam, as they meet and join exactly at the CENTRAL POINT L., which denotes that every thing before it can return to God, must be perfectly purified, and ere it can resume its original Perfection. Revelat: 21. v. 5. See I make all things new, that at the appointed Day the GREAT CITY, the New Jerusalem may come forth, which is Four Square, whose Length is as its Breadth, 12,000 Stadia on each Side which Number makes up 144,000 Cubits, ACCORDING TO THE MEASURE OF A MAN. This Holy City has 12 Walls, and 12 Gates

according to the Number of 12 sides of a Cube. At these Gates there are 12 Angels, & the 12 Tribes of Israel, the Foundation of the Wall is Jasper, which is the unalterable Colour of Eternal Light. The City itself is of pure Gold, like Chrystel, & the Walls of the City are 12 precious Stones after the 12 Tribes of Israel, and the 12 Gates are 12 Pearls. In this City there is no Temple for GOD ALMIGHTY is the TEMPLE, and the LAMB. There is neither SUN or MOON, for the Glory of God enlightens it, & the LIGHT is the LAMB and the Gates will be no more shut, and there will be no more night there. Revelations, Chap. 21. v. 10 to 25.

S. 10. We have here the Foundation of true Philosophy & how the Beginning & End of all Nature exist from God, and according to the Form of the Circle every thing must return to its Beginning as the *Terminus a quo*, & the *Terminus ad quem* & from this terrestrial & restless Substance be restored to an endless Peace of Mind & Rest.

S. 11. The Philosophers have signified Salt, thus \ominus N. 16. to explain it we must go back to the UNCREATED First Cause, & from thence to the First Created Substance, & resume what we premised in S. 14., Chap. 2. viz. The Mago Cabalistical Explanation of the Characters of the Wise and then close this Chapter.

The MATHEMATICIANS say a Point which is the Beginning & End of all Superficies & Solids, is an INDIVISIBLE ATOM, with neither Length or Breadth, & yet is the Beginning & End of all Things. The Point or CENTRE of all things is in God himself, and as this sacred & undivisible Point, with its Motion or Momentum is only a glance of Thought & can neither be conceived or described, we must hereto Recourse to the MATHEMATICAL Point, & this being next to INVISIBLE we must come to the PHYSICAL POINT to obtain even the smallest and nearest Idea of the Almighty Creator, and we will suppose this Point as No. 17., \circ which protracted in a straight Direction gives a Line. No. 18. a \circ — \circ band is the First Principle of Motion, making the Beginning, and End of a Line as a. b., a Line being no more than a certain or uncertain Number of Points protracted. But the FIRST POINT a., remains at rest while the others are carried forward to b., in the same Dimensions from a. & so quite round to b. again as in No. 19. \circ —b and from the Line of all Perfection, and from which all other Figures & Bodies are formed, which we will not explain further then by a few Theorems & Problems; this LINE now takes the Name of Circle, & is formed by another Kind of Motion & there are no other besides these.

In the Beginning of all Things is from a Point, therefore the line a. b., is called a Radius or Some diameter on the First Momentum, & all lines from the Center or First Point to the Circumference b., are called Radius or Semidiameters, which for the better Understanding of what follows by those who are not so well versed in

Mathematics shall be a little examined.

The ANCIENT Magi have characterised the Superior spiritual Light as in No. 20.  with a Point & a Radius on Semidiameter downwards to shew that from this 1st. & 2nd. Motion, which is the Termination of the Circle all other Forms & Figures are produced.

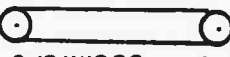
DARKNESS or NIGHT is described with the POINT downwards & Radius upwards as No. 21  to shew that this Character denotes the central subterraneous devouring Fire, which is carried all about, and is in direct Opposition to the other. Water is signified by 2 Radii on a complet Diameter, in a HORIZONTAL Direction as No. 22.  which is the Character of the Universe. Which consists of Light & DARKNESS and is denoted by No. 23.

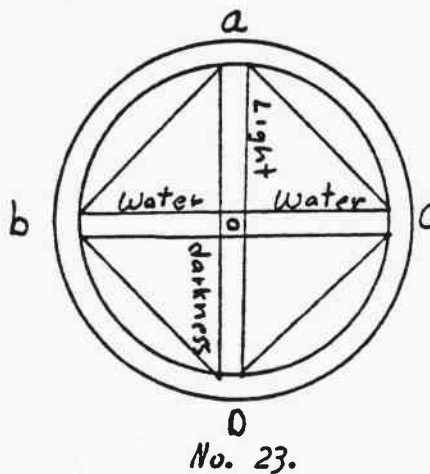

When therefore the Radius of the heavenly Light a.c., strikes towards b. & c., it acquires the Character, b.a.c., which is Fire and is the true Character of the Celestial \triangle for 2 Rays of Light a.b., - a.c., and the Diameter b.c., is the Water on Separation, which is also the true interior Characteristic of the fiery Water or watery Fire Schamajim, but as the Radius of Darkness in Subterraneous Fire d.c., strikes to b. & c., & is severed by the Diameter of the Earthy ∇ b.c., it forms this Character ∇ which is the true & proper Character of Earth, which the Subterraneous Fire surrounds & encloses; then as the INFERIOUR Fire is in direct Opposition to the SUPERIOUR and the dark Earth of the celestial Fire in Opposition to the Paradisaical or Schamajim. This Character of ∇ which is given by bungling Philosophers is false and belongs to Water as shall be observed. The foregoing Scheme of the Characters of the Schamajim and Anez (See Chapter 1. S. 5. & 6.) are taken from the First Days Work of the Creation; Gen. 1. v. 1. to 5. In the Beginning Elohim created the Heavens & the Earth, and the Earth was without form & void, and Darkness upon the Face of the Abyss and Elohim said let Light be, and Light was. And

Elohim saw the Light as good. And Elohim divided between the Light and the Dark-ness. And Elohim called the Light Day & Darkness he called Night, & Evening was & Morning was, One Day. When the superiour and inferiour Radii that issue from the Fiat of God, strike in the same uniform Proportion from Unity to the perfect Trinity, the other Days Work proceeded from them, & the whole Creation was perfected, which is shewn by the Mago-Cabalists in No. 24, and compleats the 6th. Days Work to per-

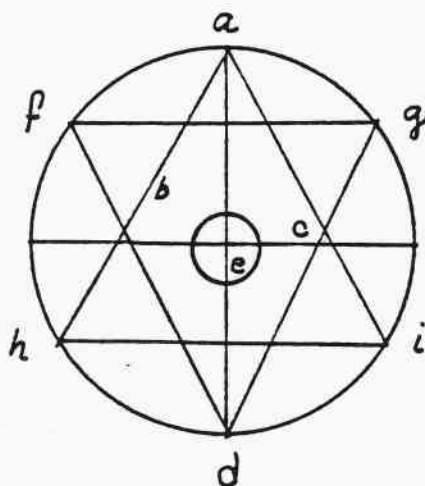

No. 24.

fect the **WHOLE CREATION** upon the Point of Rest, e, which is the Sabbath, this was compleated by the Separation that is mentioned in Genesis 1. v. 7. And Elohim made an Expansion and divides between the Waters below the Expansion and the Waters above the Expansion, and it was so. The interiour Diameter b.c., shews also the Air h. a. i. b. c., and the Water f.g.d.b.c., but h.a.i. is the Fire, & f.d.g., the Earth which is only an Emanation from the Fire as in No. 25. where the Radii m.n. o.p. strike

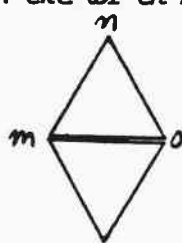

No. 25.

from the Radii n.m.n. o. upon the Diameter of the Water m.o. upon the Diameter of the Water m.o. and from thence to the subterraneous \triangle which is conponified and becomes ∇ .

The Character of the Air is denoted by No. 26. whose Legs i.n.i.s. proceed from the Eternal Light & ethereal ∇ m.L, but the inferiour Part n.s., denotes its

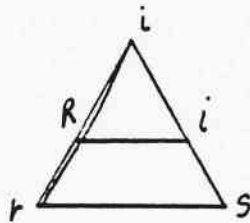

No. 26.

Humidity from the material Water or Secondary Quality.

It has also the same Relation with the Character of Water No. 27., whos sides

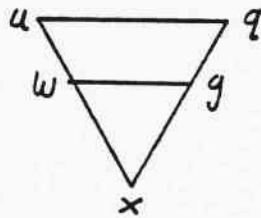

No. 27.

$x.u.x.q.$, denote that its material Origin proceeds from the subterraneous \triangle as is shown by the TRANSVERSE LINE which denotes the Mixture of the tennestrial Particles, and the superiour line $u.q.$, is the celestial ∇ not in the least diminished but sufficiently strong in itself to receive these CELESTIAL RAYS as a common Mirror.

It is said in the 1st Chapter ∇ is the 1st. Secondary Quality which the Wise clearly denote by No. 23., where the Line $b.c.$, is as well a \triangle as ∇ , as both $b.a.c.$ & $b.d.c.$, partake of it in common. Again, we have incontestibly urged in the whole Work, that \ominus , \triangle & ∇ are interiorly one, it follows therefore, that the Ancient Magi denoted by the following Character No. 28. Both \ominus , ∇ & \triangle as they

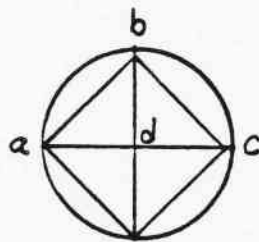

No. 28.

found it necessary, but when they would particularly signify \ominus by itself it was done by No. 29., viz. \ominus . They denoted Fire with all its Properties by No. 30., $a.e.b.f.c.d.$, by a Semi Circle with the Lines $b.a.$, $b.c.$, the Radius $b.d.$, is drawn parallel to the Diameter $a.c.$, and $e.f.$, then it is the Character of the Air as is

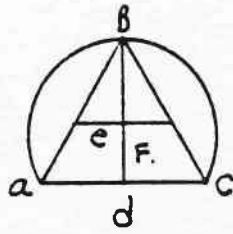

No. 30.

the Character of the Air as is seen in the Fig. They have also denoted Water with the other Semi Circle, a.g.c., reversed, as No. 31. with its Lines g.a.g.c., the

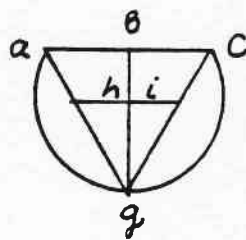

No. 31.

Diameter a.c. and the Radius b.g., made parallel with a.c. as n.i. is, but when the Radius b.g. that is, n.i., is changed it then denotes the Earth as may be seen in the Fig. Hence we know why the Ancient Magi denoted Salt (\ominus) to shew that it contained all PERFECTION and that ALL NATURE was concentrated in it. And we have already explained that \ominus , \triangle & ∇ are one & the same thing; and the 3 Characters taken together prove it. Have we not now fully explained why \ominus was signified by the True Magi & Cabalists by a Cube & Circle with its DIAMETER, or by a SPHERE? That from the Circle, a.b.c.g., No. 32. and the square of this Circle both serve the

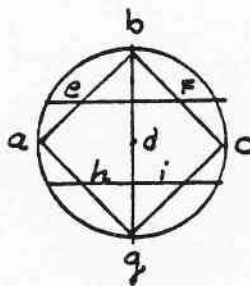

No. 32.

same Purpose, the Characters of all the other METALS & MINERALS & SALT spring from

hence as shall be shewn in the following S.S. We have now said enough if not too much upon Salt which would deserve Blame, had not God from which all things proceed been our Conductor and Guide.

S. 12. In the following S. S. we shall speak of the Characters of the METALS, MINERALS & SALTS & begin with Gold, which is denoted by the Ancients as No. 33.

 by which also the Sun is signified, to shew that both are interiorly the same, viz. essential Fire from the Schamajim; and these 2 Bodies, which as seen by their Characters, for as no Figure can be generated from a Point so perfect as a Circle, and that nothing is more perfect than these Bodies both of which are an essential Fire, on the red SULPHUR on Schamajim, to which no terrestrial FIRE ever was, can, or will be received forever without being destroyed by the celestial WATER.

That the Circle, Globe or Sphere is the Fig. of FIRE & WATER, is already said in the Beginning of the 8th. S., of this Chapter and requires no Repetition, & the perpetual Motion will be best understood from the Consideration of FIRE & WATER.

In the TRUE ANCIENT CABALA we meet with the Macrocosm & Microcosm signified like No. 34 , that as the POINT is circumscribed by the CIRCUMFERENCE so is the World by the Schamajim which is the WONDERFUL FIRE we have just mentioned, but that the MICROCOSM is also signified by it, we suppose they mean that the INTERIOR Man is essential FIRE (Aphon men Ha Adamah) that this an eternal & immortal Body in him, & that this inconvertible SOL is found in other Forms is certain & no Creature can exist without this SOL OR SULPHUR, and PURE MERCURIAL WATER. That SOL is a pure coagulated Body in its Matria from the EARTH. See Chapter 1. S. 20., 25., to the End, & that we do not see its Form before it is GOLD is as the Ancients say, because it is dissolved by its own MERCURIAL WATER & separated from all heterogeneous Qualities that it meets with in the EARTH, which is easily done, if you take the right MENSTRUUM & you know the True Form of GOLD, it is for this Reason we have said; That with the MERCURIAL WATER of GOLD, which consists of the SULPHUR of GOLD & SILVER, a Liqueur may be made out of 2 Salts, which fundamentally is one & the same.

S. 13. We proceed now to the next Metal, which is Silver, which is also signified by the Ancients as in No. 35.  by a Semi Circle & a Point or Centre with the other semi Circle reversed inwards, which is also the Character of the Moon, & shews us clearly that SILVER must be a perfect Metal like GOLD, & holds a pure Essence, also that the Red is reversed in the exterior Form of GOLD. The Ancient Cabalists have also DELINEATED WATER by SILVER, and every thing that was liquid in which MERCURY was included, & shews that SILVER consists of a WHITE SULPHUR, an aqueous MERCURIAL SALT, which is the Lunar Seed (of which see Chap. 1.) and that if you extract this WHITE AQUEOUS MERCURIAL Form, which is done by drawing out the inverted

Semi Circle & restone it to its proper Place & you have GOLD again. What the true solar & white Lunar SULPHUR is, need not be repeated as it is fully explained in Chap. 1., & if that is not understood all we now say of these Characters will be of little Use; and how this is to be done the Character itself shows you, particularly if you have attended to what has been said of the Sacred FIRE the Philosophers so cleanly write of. This Sacred FIRE, and its SOURCE, the Prophets & Priests in the Old Testament were well acquainted with as you may see in the 2nd. Maccabees Chap. 1. v. 18. & so on.

The PERSIANS called this FIRE ORIM-AS-DA, which we have said a little upon already; and whoever knows in what Manner this WATER, FIRE & SALT are One & the same thing, will also easily comprehend the Affinity between GOLD & SILVER and perfectly understand, when the true Physicians speak of curing the most inveterate diseases; and say that GOLD must be taken for one & SILVER for another, what is meant by GOLD & SILVER, and how they are made potable, but that the Heavens formerly existed as well as the Earth, from the WATER and in the WATER lays hid from them by their own choice. 2. Pet. Chap. 3. v. 5. For this hid from them by their own Desire, that the Heavens formerly existed by the Word of God, and that the Earth was produced from Water and in Water. We will now finish with SILVER, taking it for granted it is more than sufficiently explained.

S. 14. We will now proceed to the IMPERFECT METALS. The fairest of is Copper, which is denoted by No. 36, having a Circle without a Central Point, and a Cross below which signifies SALT. This Character explains itself, the Circle denoting its SOLAR SULPHUR or SOLAR EARTH, with which it abounds, but the CENTER or POINT OF REST shews that its terrestrial SULPHUR is only upon the Surface, and very VOLATILE. This Circle also being without the CENTRAL POINT OF REST denotes that its FIRE is composed only of an impure terrestrial FIRE OR SULPHUR, & that it wants the fixed essential FIRE of REST. The Cross below shows (which within the Circle is only the Radii or Diameter or SALT) that it wants the INTERIOR ESSENTIAL SALT which is the FIRE we have been speaking of, and that it contains only a coarse terrestrial vitriolic SALT; but he that knows how to turn this inwards again, as well as the SULPHUREOUS FIRE wheel by its Spokes or Radii upon its Axis or Point of Rest, & give it the finest essential FIRE knows the whole Art.

S. 15. Now Mars, the WARLIKE AND INVINCIBLE CHAMPION comes forward, who on many Accounts is the Chief, being the most useful & profitable of ALL on SCIENCE whatever in which he is not employed; nay even our Food & Nourishment depends upon him, which is proved by all the LETTENISH and FAT EARTHS, that BRICKS are made from whose RED COLOUR proceeds from a MARTIAL QUALITY; and by a good Flux and a strong Fire may be

separated more or less, & that these CLAYS & YELLOW EARTHS have once been Iron is clearly seen by the Plough share which is taken from its Minera, and grows more & more conroded, & which produces Grass and all kinds of Vegetables for our Nourishment, but a certain Proof is, that, if you moisten Iron with Water, and expose it to the Air, it soon rusts, and if you sprinkle the Rust again with Water, in Time it becomes a yellowish CLAY or LETTEN which is as good to seed in, as any other Mold. (F.B. Remark. This is evident from the Decomposition of the Iron Pyrites to a brown & reddish Earth which is commonly found in the Cliffs on the Kentish & South Coast, from being exposed some time to the Air, & the Moisture of the Sea)

That the whole Surface of the Earth has been covered with Iron Ore which in length of time has been decomposed seems very clear from the Lumps of Iron Ore that are frequently found, particularly where the Soil is not much above the Trieb Sand; and when the Rays of the Sun (the red SOLAR SULPHUR) can easily penetrate to the Water of the Trieb Sand (which is a petrifying WATER) of which See Chap. 1., S. 12, 13, 14, 15., and where these Rays by Means of the Water and the subterraneous Heat, are digested to an Iron Minera (which we have also mentioned in the same Chapter) which clearly proves there is no fruitful Soil, where this YELLOW OCHROUS, and MARTIAL Water does not shew itself.

In Short, what sort of a Companion Mars is, his ORIGIN, HIS GREAT UTILITY and his INFLEXABLE, PERVERSE and UNGOVERNABLE he is, when the wickedness of Man draws the Wrath of God upon him, and the Lord withhold his fruitful Rain, and the dissolving Water as is described in Deuteronomy, Chap. 28. V. 23. "Moreover the Heavens which are above thy Head shall be Brass, and the Earth which is under thy Feet shall be IRON." But where this true Water does not fail, there shall be accomplished what is said in Job. Chap. 38. v. 14. It changes itself, like Clay (the WATER) which a Man sets his Seat, nor have we quoted this Passage without Reason.

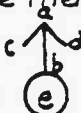
Again, SOL is the immediate temporal FATHER of Mars, & LUNA his STEP MOTHER, and his Father having committed Fornication here below & begat him without the Lawful Bed of Matrimony; and tho' he is so degenerate and perverse, he has still a great deal of his FATHERS NATURE in him, We ourselves may know from our daily Food, which is chiefly produced by Mars as has been lately observed (our Degenerate Inability and Perverseness, but on Account of the pure Blood that he derived from his Father & which is said to be perfectly pure, clear, and an ETERNAL UNEXTINGUISHABLE FIRE) of whose Seed our interior spiritual and incorruptible Body must consist, as the SCRIPTURE SAYS, out of the red EARTH taken from Paradise (Men Aphon men Ha adamah). The Ancient Magi have denoted Mars or Iron by No. 37.  diameters at the Top incline

downwards to the CIRCLE in a Right Angle. This Character has many mysterious Significations, the chief of which we will mention & begin with the Point a. from which 2 Radii or Semidiameters of the Superior Light a. c., a. d., emerge and form a Right Angle in a., which shews it wants only the WATER Schamajim the Lunan white SULPHUR, to make it a perfect Globe of FIRE, which is a pure Essence. The FIRE of the red SULPHUR, but the 2 Radii of Light \wedge . which c. d., want, are united to an impure Wife a. b., which is the full Diameter of the inferior Cross, or to an impure terrestrial SALT, which is a SALT of Vitriol and is his impure Body, but still his SALT is much purer than the SALT of Copper as may be seen from the following Observations.

1st. That his SALT or Diameter is a pure SUBLIMATED or EXALTED SALT, which has united itself in the AIR with the Radii of Light, and is included in the 2 Rays of Light, which makes it so sweet & gentle, it being in great Measure concocted by these Rays. The SALT of MARS is very different from the SALT of VENUS which is very terrestrial, and whose Cross is below, but the SALT of Mars resembles the wonderful SALT called NITRE, which is evident from the superior RAYS OF LIGHT & FIRE (See S. 11.) of which more shall be said in its Place.

It is from this excellent SULPHUR and the abovementioned SALT, that Mars Cross is produced; but having no CENTRAL POINT signifies that the RAYS OF LIGHT are totally absorbed by the DIAMETER above and that the IMPURE SALT predominates and that the red SOLAR SULPHUR is entirely turned inwards. It is on this Account that the SALT in Mars is used as its own MENSTRUUM for its own Purification, and that its SALT is again turned inwards, that is, it is interiorly united with the fiery DISTILLED SULPHUR, & he that knows how to turn the Wheel upon its Spokes, will again turn him upon his Center, and compleat the Circle. We have already said elsewhere and not without Reason: "That all Things are predestined to their proper END, and proceed in Order from their first Conception to their last Productions; and return back to their original State", which is not improperly applied in Chap. 1. S. 24., upon the Melionation of Iron, we will now finish with the Character and leave those who love TRUTH and WISDOM to consider it. That this MARK \nearrow was given by the ANCIENTS as an Arrow Head of the Sphere of Mars, for another Purpose, as well as what may be said upon the Subject shall be reserved for another Reason as it properly belongs to the Description of the Universe, and shall be resumed at that Time.

S. 16. Jupiters Turn comes next, or Tin, which is a metal neither Philosophers or Chymists have hitherto properly treated of, the Miner considers it no farther than the producing it out of the Mines & smelts it for common Uses, but there being much more in this Metal, than is generally imagined, it is worth while to consider it a

little further. It is denoted by no. 38., which shews its Character and Property. Its Semi-Circle a. b., denotes that it has a large Portion of Solar SULPHUR at least half as we see by g. a. h., the other Part b. g. h., denotes the Lunar WATER, MERCURY or SULPHUR. The Cross annexed to it b. d. f. e., that its whole Body is united with a terrestrial SALT. The Cross is its own MENSTRUUM, by which its exterior Form may be wholly destroyed that its interior may be again manifested, and this Sphere a. h. b., may be turned round upon its Axis g. The impure terrestrial SULPHUR & SALT denoted by e. c. f. & b. c. d. gives JUPITER its melting Quality, with all its Impurity. You must therefore pass this Cross with his Semi Circle of Imperfection thru the FIRE to purify it, & you will gain your End & produce very good effects, but it is not our Business to describe the Process, but only to explain the MYSTIC & HIEROGLYPHIC Meaning of the Character.

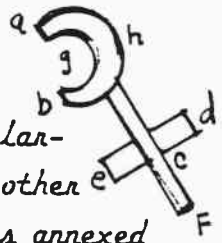

S. 17. Saturn on Lead comes next whose exterior Appearance everyone knows is very contemptible, but he that can get at his interior Qualities will acquire great Reputation. The ancient Magi who knew him better than we do, have denoted the cross grain ed subject by No. 39. with a Cross at Top g. h. i. k. b., and 2 Semi Circles Lean in Reverse to each other. The upper one with a Central Point as a. b. d. c., and c. e. f., which singular Distinction shews it must be something particular and as for the lower one with a Central Point a., denoted that this Half consists of SOLAR SULPHUR, or Male Seed. The Lunar white Lunar SULPHUR on Seed, otherwise it would be impossible that this Metal should destroy all the rest so easily & carry off their volatile MERCURIAL Parts, & leave their dissolved ones, which shews us how to know this UNIVERSAL TERRESTRIAL Menstruum, and procure at the same time the Knowledge of the Spiritual Universal Menstruum. He therefore who can reunite these CIRCLES by its SWEET and WONDERFUL SALT h. i. k. b., & transpose the CENTER g. of the cross to the Center of the Circle a., and complete the SPHERE of a., will assuredly know what wonderful Things can be done with SATURN. He must also learn to know why his own Menstruum h. i. k. b., is above and not below. It is no TERRESTRIAL, but a CELESTIAL SALT which has great Affinity with the SALT of MARS. If you would give him a Materi that SATURN Loves, and a Water that is like him, you will know how to unite them & his INTERIOR FIRE a., will be vivified & the whole CROSS brought to its highest Exaltation. SATURN is now gently LAME.

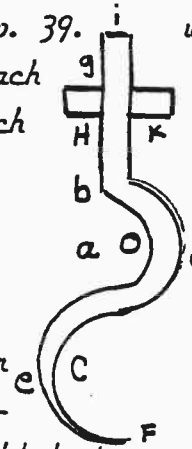

S. 18. Let us now proceed to volatile MERCURY who is notwithstanding the most DISSOLVED but it takes up too long a time to bring him to it. His CHARACTER is denoted by the Magi & Cabalists as in No. 40., with the CIRCLE of the Moon above and a



compleat CIRCLE underneath without a CENTER and under this CIRCLE a CROSS. This is a wonderful Deleneation for the upper Half ☾, denotes its LIQUIDITY, or SPIRITUAL VOLATILITY and the CROSS below its TERRESTRIAL AQUEOUS or SALINE HUMIDITY or metalline FORM & VOLATILITY. Also, that it wants the Form of DISSOLVED SALT in its Circle. The compleat Circle shews, that its PUREST & MOST FIXED. But the red SOLAR SULPHUR lays in its CENTER, but its LIFE & EFFICACY viz. the POINT is wholly shut up in him and lost in its volatile Lunar Form. These must be brought together and manifested, and its SALINE CROSS with its LUNAR DISSOLVED Form or Humidity must be turned inwards; & then he must be DISSOLVED by his own FIRE or SOUL i.e., his HIDDEN POINT, and it will be found that RUNNING MERCURY is nothing more than the red Solar, or white LUNAR SULPHUR in a metalline Form. Examine carefully Chap. 1. S. 23 & 25., but the Magi & Cabalists had a much higher & more mysterious Meaning to that Character than the COMMON RUNNING MERCURY for the SUPERIOR SEMI CIRCLE is the Figure of the Moon, and the COMPLEAT CIRCLE of the Sun, and the Cross when brought within the Circle is the Character of the Universe. See S. 11. They would also signify that the Universal MERCURY, which is the Beginning of ALL Things, and the so often mentioned Schamajim, which is WATER & FIRE & SALT, as you may find it necessary to call it; is the FIRST CREATED Essence of all Essences of which enough has been said. The Character of MERCURY is also sufficiently explained.

As we have mentioned all the 7 Metals after the NAMES of the 7 PLANETS it will not be improper to say a Word of the PLANETS themselves & their Qualities, as they are the nearest Worlds to us, for the better comprehending of this Subject, but as this does not appertain to the Use of SALT, we will leave them to their proper Place if we shall have time for it.

S. 19. Let us therefore pursue our Point, and make an End of the Minerals & Salts, that is, of their SIGNATURE, not their Natures, enough of this last having been said in Chap. 1. S. 26. to the End of S. 31., and Chap. 2. S. 8. thru 10., we will therefore stick by their SIGNATURES, as far as we can collect from the ANCIENTS And First of Antimony, which they have denoted by No. 41. with a CROSS above, which shews its UNIVERSAL SALINE PRINCIPLE; and a COMPLEAT CIRCLE without a CENTRAL POINT to shew its VOLATILE ABSOLUTE and Solar SULPHUR which exists in its whole Sphere. The SALT tho' pure & excellent, yet nests upon its EXTERIOR CIRCUMFERENCE, but he who can bring this SALT, to the Form of COMMON MERCURY & digest the pure Body of IRON in it, will find the Heaven of this Mineral is not unprofitable, & he will bring it to Perfection.

Next comes Arsenick called by the ANCIENTS ARSENUM, and is denoted by No. 42., by 2 COMPLEAT CIRCLES one above, and the other below, with a RADIUS that joins them;



which clearly shews it had 2 Beginnings the SUPERIOR Light, and INFERIOR FIRE, & that it is the compleat acid, dry, & absolute Universal MERCURY, whose POINT is ABOVE as well as BELOW, extracted by the subterraneous FIRE, & he that can give it a true metalline Humidity, on proper SALT and true EARTH for a Matria will know how to fix him.

Next comes Sulphur which is signified by No. 43. a CROSS below which denotes SULPHUR & SALT, but is only meant of the TERRESTRIAL SULPHUR, for speak of the SUPERIOR or CELESTIAL \triangle they de-



with a TRIANGLE above and you must understand, this when the Magi & Cabalists note it by \odot , therefore

we must be rightly understood what kind of SULPHUR we speak of here, and what it wants in its imperfect state viz. \ominus &. See above S. 11., what it is destroy the TERRESTRIAL FIRE in its own WATER & receive the CELESTIAL FIRE that is locked up in him; digest these together, & you will gain your Purpose, that of producing a living



Now follows the natural Zinnebar which is denoted by No. 44.

Circle opposite to each other with 2 transverse Radii, by which it proceeds originally from a pure SULPHUR & MERCURY, for the 2 the 2 Crosses, one of which belongs to MERCURY, & the other to First is the SULPHUR of LUNA, the other of SOL, & these are so the subterraneous FIRE, which unites itself with the metallick radical Humidity & that you have its one FIXED Metalline Form. These are the 4 Characters from which the ANCIENT Magi either by Combination or Division have denoted all the Rest of the Minerals.

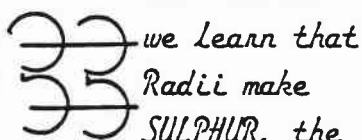

with a Semi

we learn that Radii make

SULPHUR, the

dried up by

But they have reserved a particular Character for unslaked Lime, from a very important Consideration and have denoted it by No. 45, & SALTS. It has a SEMI CIRCLE above which is the and a CROSS below, which is the purest terrestrial which the Celestial SALT just now mentioned is plant CIRCLE denotes the pure EARTH and the CROSS the dis- as a MEDIUM. The Ancients have also denoted the Volatile Universal Acid brought to a FIXITY by this CHARACTER. It has a great deal concealed in it which it is necessary to know.

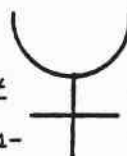

which is between MINERALS MAGNETICAL Lunan SALT,

SALT, as the Soil in

ed. The SUPERIOR SEMI

tilled terrestrial SALT

We now come to the combined Salts, of which Nitre is the First, which is denoted by No. 46. Its SPHERE is taken from the Universal, & it has the Radii of the SUPERIOR LIGHT and INFERIOR FIRE. It consists also of FIXED & VOLATILE Alkaline Parts, & is the wonderful Salt of Nature.



No. 47 is VITRIOL \oplus which is a Combination of the Universal and Common SALT, with a Portion of metallic Particles. Its RADII strike from above downward as well as sideways, and from below upwards; if it had a 4th. Radius (which is the powerful MERCURIAL Essence) it would have been the Character of the Universe (See above S. 11.) where the Curious may see what an excellent Subject VITRIOL is, but it is not the Universal Subject SOL which you must look for in another Mine.

No. 48. Is the Character of \times SAL ARMONIAC which is not described in a Sphere which shews that it is not a natural one. It consists of 6 Radii, the Radius of COMMON SALT, \wedge of the \wedge Universal Acid, and the \vee d. of the Salt of SULPHUR, but that there have no interior Union is evident from its wanting the Circle. It derived its Name originally from the Temple of Jupiter Ammon, for this Temple being built in the Deserts of Egypt which were very dry, where many Pilgrims came, this Salt was generated from the Urine of Men & Beasts, by the concentrated Solar Rays and the SUBTERRANEAN FIRE, but as it was not to be procured from thence in after times they have found a way of producing it artificially by Salt of Urine, Wood Soot and Blood, which has been found equal to the ORIGINAL NATURAL SALT and it is so necessary a Subject, that a Volume might be written upon it, but that is not to our present Purpose.

No. 49. is the Character of Allum, \bigcirc which in its outward Form partakes of SALT, NITER & VITRIOL, & that all these are contained in it, because you neither see the RADII of the SUPERIOR & INFERIOR LIGHT of the \vee d. FIRE and much less a Central Point but it is certainly great Affinity with the SALT OF COPPER, but great Skill & Time are required to produce its INTERIOR LIGHT & FIRE on Account of its ACIDITY, but it may be done if it is perfectly DISSOLVED and again COAGULATED in its proper Ocean; and he who knows how to cleanse it with its own WATER & to reunite it, will obtain the wonderful Salt of Nature, which is as great a PURIFIER OF METALS as Saturn, as well as an extraordinary and uncommon Medicine for inflammatory Disorders in the Human Race.

No. 50. Is Alcaline Salt \square , which is an Arabian Term, but is as much to say Salt, and it is the radical Salt of all Vegetables, and the Foundation of all other Salts, as it may be transmuted to either of them as in Chapter 2. S. 9. & etc. It contains these \wedge Radii which denotes a perfect Nitre and these \vee , which denote a perfect common SALT. There are great Mysteries in it, which are well known to those who work in FIRE. What else may be said upon the Subject is needless at present.

No. 51 is TARTAR, \boxplus on the Salt of Wine, a very wonderful Salt of Nature not improperly called the SULPHUREOUS radical Acid or Salt. This \square denotes that it is produced by the 4 Elements & the \oplus , that the SUPERIOR \vee d. Light, & the

INFERIOR ∇ d. FIRE strike upon it, but that their $+$ is fast locked in, and who ever can bring them out and concentrate the INTERIOR $+$ on Radii, and inseparably unite them, will obtain a most wonderful Salt, of no small Profit, & we know no Salt that can produce a better Medicine if the Operation is well attended to, but we cannot give the Process here, particularly as we find no Trace of it among the Ancients which is either lost by Time, or that they supposed these Explanations of their Meaning were sufficient to discover the rest of the Processes, & we must suppose that every experienced Lover of Truth will find his Expectations satisfied, we shall therefore finish these long and tedious Dissertations upon Salt, from a full Assurance that those who understand us, will forgive our ending this Subject as we began it, which is that God at first created a fiery WATER on an aqueous FIRE, that is, a FIRE, which was a Salt and a WATER, which were individually 1 and each 3 & 1, at the same time and that all Creatures were produced from them, and as they did not intend themselves to an infinite Number but ceased and ended on the 6th. Day of the Creation, we cannot otherwise conclude but that the Wise Creator not only instructed Mankind, who was the Last created Part of this Master-Piece of Nature, but also concentrated in him, the Beginning and End of all Creatures, i. e., united the WHOLE UNIVERSE in THIS SINGLE CIRCLE at which Completion of the Creation the POINT OF REST or Sabbath was ordained, to shew that all without the Point is in continual Restlessness or Disquiet, and is continually hankering after this POINT OF REST its Original Object.

We have now fully explained that the First created Emanation from the Great Majesty of God was a SALINE ESSENCE, which was also \triangle & ∇ & \square or \circ called by Moses, the Schamajim; but by the Ancient Sophi, The Universal MERCURY, and it had that Name because like QUICKSILVER, it assumes every perfect Shape & Form, and like a Mirror reflects them back again.

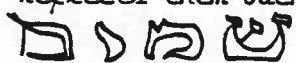
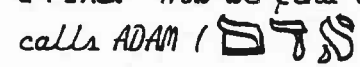
 (Schamajim) as is observed in Chap. 1, & Aesch & Majim on WATER & FIRE. Now we find on the 6th. Day Man was Created, which MOSES in the holy Text, calls ADAM () and there can be no Doubt of his being created perfect; and not only so in the common Idea, but so essentially perfect, that his Soul had an immediate Share of the eternal Light: Gen. 2. V. 7. "And Elohim formed Men of the Dust of the Earth, and blew into his Nostrils the Breath of Life, and Man was a living Soul, and a Spark of the eternal Godhead."

WHO NOW HAS EARS TO HEAR, LET HIM HEAR, and read the 1st. Chapter of GENESIS with the greatest Attention together with these 3 CHAPTERS & he will be more instructed than he could ever have an Idea of, but this to set it down word for word, would be great Imprudence, but it is so often & clearly set forth in this work as to be in-

controvertible. Our Opinion is, that thou on whom the Light of the Highest does not shine cannot see even at MIDDAY.

But if Man would learn to know himself, he would be able to perceive from his own proper Nature all the CREATION, both VISIBLE and INVISIBLE; nothing could be hid from him. Nay, the 4 Principles or 2d. any Qualities, commonly called the Elements, with all their invisible Combinations, would be laid open to him, & fully explained, as we shall further examine in the 3rd. Part of this Work. Even Heaven and Hell, Light & Darkness would be perfectly open to him. He would see and know without any Disguise that every dead Body will be perfectly restored to Life, and live for Ever. Which last Expression may be a Stumbling Block to some uninformed People, which shall not prevent our making use of it, as WE KNOW WILL SPEAK THE TRUTH, but how Mankind can be made perfect, & how all Creatures that are now buried in Darkness and Mortality, can at the Time appointed from Eternity, be renevated and restored to a SPIRITUAL and MERCURIAL Life, in which only Light & Soul can operate and act, is far beyond our Ability to explain.

Therefore O Man Learn to know thyself above all Things, and you will then know what that is, The Philosophers call THEIR MERCURY, what MOSES called WATER which is SALT & FIRE, but which we by every well known Word call SALT. You will also know what is meant in Jeremjah, Chap. 10. V. 13: "He that maketh the Lightning to rain," which Words most assuredly imply more than a common Interpretators know how to explain with all their Glossary. In short, it is well worth considering why Man was called the Microcosm, or little World, and while we are the very thing we enquire about, it is proper that we begin upon ourselves, that we may afterwards know all the other Creatures and their Origin and at last attain to some Knowledge of the Creation himself: To whom be Love, Honor & Praise and Dominum for Ever and Ever World without End. With which we will conclude this long Chapter, and recommend Fig. 52., to the further Consideration of our Readers, but whether they will comprehend our Meaning will be seen by the Progress they make in it.

Here ends the Authors Treatise of Salt, & the rest of his Work will be given in another Book.

OPERIS

MAGO CABBALISTICI & THEOSOPHICI

THE SECOND PART.

TREATING OF SULPHUR.

CHAPTER 1.

THE BIRTH & RISE OF THE HEAVENLY AS WELL AS THE EARTHLY SULPHUR.

S. 1. *The Birth & Rise of Sulphur.* But not only of the common of which Matches and such like things are made. But our intention is to treat of that *SULPHUR*, whose Birth & Properties are the same, with *SALT & MERCURY*. Of this secret and wonderful *FIRE* and Light, it is we intend to treat of. And that from this the destroying deadly Earthly Sulphur. By the fall of Lucifer has its rise and Manifestation.

S. 2. In the foregoing first part of *SALT*, we have treated at large the rise and properties of *SALT*, and how that in the same the first matter on the Birth of the incomprehensible Divine Essence *SULPHUR & MERCURY*, as Light *FIRE* and Spirit, are essentially United. Now might those, that have seen and Read this first Part, as also this, Imagine it to be needless, that we should have occasion to say still something particular of Sulphur. To such may serve this answer, that had he but taken a full View of the Creation, he might have spared himself this un-needful Remark.

S. 3. The Sacred Text says: In the beginning God Created the Heavens and the Earth. Here the Text treats of the distinct Essences, namely, of the Dark Concentrated *FIRE* or contracted *SULPHUR* clod, and then of the spiritual Salt (which is *MERCURIAL*) Light & *SULPHUR*. Whereby we must again remind those cunning Ones, not to be offended, that we have in the foregoing tract treated so much of the Red & White, Masculine & Feminine, Solar & Lunar *SULPHUR*, and now again intending anew to treat of it, but we first beg of Him to wait with patience for the end of this Work. As then he is allowed to exercise his over cunning speculations, as much as he pleases, according to the drift of his Inclination.

But then shall it stand as Pilate said to the wicked Jews: Namely: What I have wrote, I have wrote. John 19. V. 20.

S.4. But to return to our Intentions, and follow the sacred Text, so is the same to be well observed: Why the Earth, as the Dark stinking SULPHUR Lump, directly is mentioned after the making of the Heavens & its agreeable light FIRE? That this is not the property of the Language, That it is the dictation of the Holy Spirit for High prophesy officially to those who are but little acquainted with the Hebrew. That the same admits equally to say, The Earth and the Heaven, as is before said the Heaven and the Earth. Therefore the same is Highly necessary to consider it more minutely.

S.5. And first, that in this Earthly Lump on Globe, there is not a grain be it as subtil, as it will be void of FIRE, that is SULPHUR, although the same may not be mechanically demonstrated & made visible on account of its subtil, on minutest purity, but it will be revealed to those who know how to bring many Thousand of them in a compass without violence of FIRE, and by rubbing two such lumps together will soon be manifested. The FIRE & SULPHUR which was therein concealed. BUT THIS IS NOT THAT SULPHUR WHICH IS OUR FIRST IN VIEW, although the same has its beginning from SULPHUR that is, Light SULPHUR, was also the Center of darkness or Anguishing Fire & Lucifer had also its beginning originally from the Light SULPHUR. But we mean here that SULPHUR has its Rise with SCHAMAGIM or AESCH MAGIM the fiery light Waters. Namely the first outflowing Salt, and is also that oily warm light which refreshes all Creatures, namely in the Lovely Balsam in which Tincture, & in which all conpon-eal things have their existence.

S.6. That all smells, which may be pleasant or distinguishable, have their Rise (through all Nature) in the oily parts of its substance, that is, in SULPHUR & which is well known to all those who are any means acquainted with Nature, & each pleasant and refreshing smell has its rise in the Moons Oily Light as its source, on the other Hand all disagreeable Stink & Smells proceed from the Returning or dissolving or spoiling of that which quickens all Creatures and is the light or SULPHUR which is formed and composed of 13 equal Lines or crosses, & three circles; (See Figure 1), that form an equal sided Triangle and three equal squares, as the most perfect of perfection, namely, the three Circles represents Eternity, and with the two crosses the incomprehensible wonder Salt of Light (\odot) and Fire (\ominus) namely \oplus through this character \triangle represented, in that dark Earthly Anguish FIRE whose true character is (Fig. 2.) which perhaps will not be understood & known by every one at first sight.

S.7. The Mago Cabbalists have represented the Light on Fire, Air & Water and

Earth, by the placing & Turning of an equal sided Triangle, (whose rise is mentioned in the foregoing S.) and in the first part of SALT is largely treated, namely the Light or Fine \triangle , and also the Air \triangle , the Water also ∇ , and so the ∇ , where the matters, are afterwards by those dirty Creatures & Spoilers of coals in their Ruinating Chymistry, err'd & prevented; & to work with their useless Matters, and though amongst numberless scarce one single one knows their true meaning. The Earth is also represented ∇ by a triangle turned upside down, through which is a line, to shew a spoiled, gross, or full of earthly parts of stinking sulphureous salt (namely a Mineral Vitriol) and is known that the true Character of Vitriol, is a circle with two lines and two half Circles hanging thereon, (See Fig. 3) to shew that when this Character is anatomized, all Metals, that is, all Earthly & viscid parts are found in the same, namely the outward Circle is \odot Gold; whose cross on line hanging out wards is Copper, also two half Circles with the Cross, Lead \ddagger , (see fig. 39 in the first part) & then also as (fig. 4) Tin; the whole Circle divided and laid in one another above \smile Silver; but if laid as (fig. 5.) Iron or σ , namely the whole Cross, but that which is Broke & shews us that the salt of Iron is found in over-plentifulness & causes the vitrification of Iron, Quicksilver is formed also \ominus . When the Character of the ∇ , the other line of Vitriol is added. So does it appear as (fig. 2.) will shew, And represents then the Earthly Grim Fire or stinking SULPHUR, although the lovely Sulphur of Nature or Heavens Light is also SULPHUR represented: Yet the stinking Hellish sulphur on the Anguish Fire is always represented turned upside downward and the Cross which is salt turned in the same inwards; but the saltish Mercurial cross on Light remains in its place upwards, But to shew the rise and Origin of the dank Conrupted SULPHUR, in the beginning of darkness in whose center the true original Light is hid, but which light is chained & bound by the bands of darkness, when its FIRE is awakened and its Grain becomes manifest, and nothing but destruction follows with Spoiling & passing all what come in its way, the same also his form. His so cold Spirit, that is when the same is pressed out by those Spoilers of Coals & which tears & rends all Bodies with violence, When by its FIERY Hellish principles and hidden sulphureous stink is manifested. But on the other hand the SULPHUREOUS spirit of the first created light operates in an incomprehensible manner, resolving in a lovely manner all things to its first (but we don't say Very first) matter, separating the same from its Heterogeneous particles. Those, who have a thorough knowledge of Nature, is here said enough; but for others much too much. In that, they regard this not & would not less understand, was there more hereof.

S. 8. That the greatest part of common VITRIOL is composed of Sulphureous parts,

namely of Earthly gross SULPHUR, will not be denied by anyone that is well acquainted with Metallic affairs: Therefore it is easy to judge, how far they shoot from the Mark, that chooses this VITRIOL for the subject of the Heavenly SULPHUREOUS Light Water, AESCH MAGIM, then although this SULPHUREOUS Light Water is to be found in all things under Heaven, and without the same nothing can exist: But this is the most particular in the common Metals & Minerals, shut with such hard Locks & Bonds of darkness as that these Bonds will bind the same (without the above mentioned SALTY SULPHUREOUS Light WATER) out of SALT, SULPHUR & MERCURY to all Eternity; although the Gold Cross should destroy all the tombs on the Face of the Earth, then as impossible as it is to join Light and darkness so that they may be inseparable united to this inseparable beginning, & known in an inseparable Unit. Even so, little will these Chymical Smoke Swallowers obtain this sweet & Lovely Wonder WATER; that is saltish out of these Gross Bodies, this they should take here to the very purest Gold to send up the Chimney! Or even to still their hunger Rinsed Bellies herewith.

S.9. We have tis' True, plain enough demonstrated in the first part of Salt that this Solar Lunar Wonder SULPHUR or Balsam is to be found in all things, as their soul, but this is not done to strengthen the Errors of the Coal Murthering Alchemists, which endeavour to persuade the World to their ways, that because in the common Metals & Minerals may be shown a seed of Gold, and therefore should have been Gold had they have had their perfect Maturation, & not have been hindered by foreign & strange Matters in its Matrice and therefore is now this on that Metal, but in truth they have shot far from the Mark, as far as Heaven and Earth are from one another.

For the Omnipotent God has by his Everlasting Intention & Knowledge caused the different parts of the Creation to his greater glorification and Wonderful Majesty, and the Seven Metals are as distinct in their Qualities, as they are in frequency do all have their respective places in Nature, & their peculiar advantages & Uses. Here I see an astonishing tribe, not transmuters, but of various Labours of Pretenders, that are transmuting Honid Catahen's wanting to Storm at me & through their Anonymous examples of past Transmutations, to overturn our assertion, & prove themselves true; Namely all Metals had or should have been gold, but to answer more to these People is not our intention, otherwise we could soon help them out of this dream & shew them the difference between the probability & possibility, & perhaps should bring them to Reason & from the true Ground convince them, what a true change is, (but more refined) a separation of the Pure from the Impure Goop? Those who have seen a true & not Sophistical Operation, will know and Understand, of what we are here speaking of.

S.10. Above in S. 5., we have said, that in this Earthly Globe there is not the

Least Atom, in which is not to be found SULPHUR or FIRE; which by the Wise wants no more explanation & that when this FIRE or SULPHUR is lighted it is a stinking eating destroying & deadly Flame; and is known to all, that this SULPHURS outward Form is composed of stinking slimy moisture, which is further observed to have much Salt, as the beginning of this Slimy & MERCURIAL Light, and the Reason of the Manifestation in the flame, out of the darkness & deadly Fire. Further experience has shown, that when this SULPHUR is wholly Burnt, from its stinking slimy remaining Matter, there may be extracted a small grain of Gold. Whereby we shew those Scholastic Wise, this demonstration quite clear and undeniable layed before them: Namely, it is known that when the SULPHUR is lighted, by a common FIRE, the same burns wholly away. But if the same is lighted by a burning Glass in the Sun, that the SULPHUR does not burn away, but retains it after its whole weight. Here is asked: What is the true Reason hereof? These Gentlemen are desired not to laugh this out of countenance, till they have without this Metaphysical whyme resolved me this. In which there is contained more wisdom, than in Aristotle and those who will have the World to be composed of the Atoms of the Sun formed in Balls. From all what has been before said, it appears undeniable that this SULPHUR has a higher birth and is as it were returned on sunk from the Light (AESCH MAGIM) the darkness () namely from the Light, Fire, destruction and death, as the Mago Cabbalist and Theosophii may see clearly demonstrated in (fig. Num. 6), there, a, is the point or dot, or Center of Eternity; and when this moves, towards b. d., and o, there was the first Manifestation of the Rays (Radiorum) a. b. a. d. a. c., and in the unity, is the undivided & incomprehensible Trinitiy, in the true square and equal sided Trine, or triangle, b. d. c., is revealed the wonder worthy & Incomprehensible TRINITY, in b. c. d., in the UNITY, a, and the, UNITY a, comprehends the, TRINITY, b. d. c. which is every way one and the same and even is the same every way, before the beginning of the World, (MUNDI ARCHETYPUS) from the Trinity a. c. d., that is from the center or middle point of Eternity, a, (or Him who was, and is, and will be, and who cannot be otherwise called, then in that in which He has Revealed himself namely, JEHOVAH, be praised from Eternity to Eternity) in the Water SALT, Light MERCURY and SULPHUR, that is Fire makes manifest. But we don't here speak with those wanting understanding, or the Scholastick Whym teachers, which knows no word to express themselves, as what their worm eaten Metaphysics has hatch-ed, or appertaining there on of such Theology which stick by their Scholastik Learning on the Bird to the Bird Lime: But we speak with a MAGO CABBALIST, PHYSICS and THEOSOPHICA, as the three lines, e. g. in the Triangle the perfect perfection, h. i. h., are contained in the Circle the highest Throne k. i. k

S. 11. In the foregoing part of SALT we have treated at large of the Creation of

the Spiritual World as also the Fall of Lucifer and of this Visible World and explained & perfectly demonstrated, as much as can be through Figures. But perhaps some, who can't base any thing unmeddled with, this they will find some thing quite New & turn themselves to see some New Figures crept before them. But while this is not our intention to meddle with such self conceited, but with the true Lovers of the MAGO, CALLABA & THEOSOPHIO, and to those we are speaking. But the others we may say, they are men allowed to write against it as much as they will, But shall not Bias us, nor will their roaring bring us to their way of thinking. But not regarding them we will remain by our intentions, and say that the Center, a, The Eternity, or ELIJAH ASCHER ELIJAH, (I shall be that I shall be) the Godly three united, (which way of speaking the Sacred Text by no means uses, & we have borrowed this from the Schools for particular Reasons) and this is manifest, in the three inseparable lines or crosses from one Center, and its fonthgoing Works, e. f. g., out of b. d. c., from the Center on eternity, a. Namely, SALT, SULPHUR and MERCURY. But pray that no one will meddle with these sanctified signs, of those Black with Coals, defiled, and of Salt, Sulphur & Quicksilver, stinking Alchemists or such like Gold makers or spoilers. Then truly we mean not here nor speak of those gross Earthy Minerals which are under the Curse, nor even thought of them. But of these pure Characters here we speak, whose original is from the center on point, & is manifest in Rays of the circumference, of which is referred to the first part of SALT. And which further reveals itself through the RADIUM a. L. till in i. n, L, and made the point L. its Center, and then from the Center it ascended till in m., the district of the circle of the Godly might on working SALT, SULPHUR and MERCURY, namely e. f. g., centered in the three in one, h. i. k. Comprehended from EN SOPH. The Abyss on depth without beginning or end, and that also the RADIUM, L. m, is drawn, through which all the Spheres of the Visible World (or Worlds) that was in the beginning light & Spiritual, and thus was the Sons of the Morning Found, with all his Millions of Spirits formed, whereof more may be seen in the first part of Salt, and particularly how that Lucifer after His fall was thrust from His throne, namely out of L., the Center of his World, with those of his excellent Angels, in whose place by the Creation of this Visible World, the Universal Eye, namely the Sun was placed; He, Lucifer with all his throne Angels is in this dark Earthly Fire globe, or lump. But the other Angels left in his Region, are thrust into the Visible Elements, where they are Locked and bolted, therefore those of the Air, whose Prince is Beelzebub, has still the greatest Liberty, as also still the greatest Power, see Phil. 6. 12.

S. 12. From the Holy Scriptures its manifest, that Lucifer is the Fiery Lake and there is bound with the Chains of darkness, that is restrained to the Center of this

Earthly Globe, & also has lost that Godly friendly sweet Light, wholly, that this Globe is formed or composed wholly of SULPHUREOUS parts or atoms: We have in all the foregoing plainly shewn, as also, that this FIRE or SULPHUR is prepared for the Anguish of the Devil & Damned mankind; as our Lord, J. Christ shews, Matthew 25. 41. Now might be asked, How the Devil & those of Mankind that are damned, as Spirits, may and are Martyred by this Corporeal Fire, which then has been said by the Mouth of Truth, which cannot err, that a Corporeal Matter cannot effect an incorporeal matter, is certain, and also cannot this SULPHUR or pitchy matter (as the sulphurs slimeyness) in the literal sense, be understood to torture and Martyr the Devil and his Angels: But those who have understood us above, as well as understood what has been said in the first part of Salt, how that this SULPHUR or FIRE is Grim or Anguish, in which Satan is chained and bound, & how the same is the prickly Bitter Contracting & Astringent property, But let no one be offended at this way of expression, as prickly, bitter, contracting & Astringent, which is an Elementary property, then a true Naturalist will easily conceive from those properties, what it is we would signify. Then through the natural understanding those qualities as observed, even also may a Spirit have the sensation of the Spiritual Fiery, swelling, pressing, offending and contracting, Pains, and to the above mentioned properties, be in their spiritual state capable of feeling then such anguish properly suffers in the flame; and some where else: There will be Crying and Gnashing of Teeth. What is here asserted is by the Spagyrick art in distilling of Spirits easily shewn, how the same strives against the sweet wonderful Godly pleasant Light, which Lucifer is stript of, & there stands in such a property, storming and Raving against God, in the Grim or anguish FIRE as the trembling, contracting, prickly Astringency, as the spiritual property of the Elemental FIRE, by the Vengeance of God wrought in him, and is in a continual feeling susceptibility till His time of times is fulfilled, and His scales or dross, namely when Lucifers Kingdom shall be uncovered, and has had all his prisoners from their everlasting anguish released, Yea, the very Choirs of his Angels & Arch Angels or Throne Angels shall be released from their confinement. And He as the Cause or origin of the separation or fall and remains quite alone in the above mentioned anguish and Grim till He knows, his Pride, Malice and foolishness, and humbles himself in the Fiat, before the Throne of the Glory of God, and shall also be released by the friendly or Joyful water of the everlasting unity. Rev. 22. 1., And then be changed into his first form, which will fulfill what, Rev. 22., says: And there shall be no more Curse.

S. 13. Although the foregoing S. 12., has been sufficiently treated of in the first part of SALT, yet a desirous and true Mago Cabbalist and Theosophie will also

find in this part, the Key to the above mentioned first part, and will not be offended at these Reiterations: But here the poor and to be pitied Gold Cook and coal spoilers will clearly see, what sort of dissolving Water, is proper, to dissolve their untimely subjects on first forms in, to have the true Congelation on first matter, which no earthly fire will be able to damage, and has the Power, to release all Earthly Bodies from their bonds and deadly foreign parts, till to its predestinated time of its releasement? Which word is magical and twofold, namely to be understood concerning the Mineral and Animal Kingdom; then of the Vegetable Kingdom is not here the Discourse, although this is hid in the Animal Kingdom, and, the other in this. Concerning which, much might be said, But will not rule here, the fore-mentioned Fire and constant fixt Matter shews it self and power with regard to the Mineral Kingdom quite perfect, as long as the present World may last. But with regard to the Animal Kingdom, in which Man is as the concentrated Middle Point, the same has a much higher property, & which (Namely Mans) separation from foreign matter on Hellish States & dross and partaking of the ever-lasting fixedness, to withstand the rage and just sentence FIRE, the Tincture of the Godly Majesty, from the spring of Life, which is sublimed and fixt through the Godly rage FIRE to a Medium of everlasting Life. And which was demanded & which is Christ Jesus himself, the beginning and the End, the Center, the Revelation, the Godly Eternity, this way of speaking is again, such as will not suit the greatest part of mankind, and from their Youth tutored Schollars, as little as Honey suits in SAURE THROAT; regardless of this, we will persue the Way the Spirit of God directs and here persue the same, to the Lovers of Truth this is too little, but to the foolish is said much too Much.

S. 14. How that Lucifer with his whole Host, has separated themselves from the Spring of Life, the Godly pleasant Light, by the Pride, as also that this whole world with him, fell in an astonishing blinding and darkness of all his Legions: Namely that that so Noble created Light in him and all his Legions, is turned inwards & is no more AESCH MAJIM, FIRE & WATER, but Majim (a Slimy thick salt water) not unlike a rotten Egg, in its shell, then His pride Brooded in the Grim or ANGUISH out of this Chaos to be Like unto God, to form again a New World: But whilst He wanted hereto, the beginning, namely the moistening, warming Light and Life, He remains in this Slimy Salty & Watery Globe, with all his Tribes, Locked and Entangled.

S. 15. That in this water, Fire is concealed SULPHUR, as the property of the salt is demonstrated enough in the first part of SALT: Through the just sentence of God, over Satan & his Host, God was the everlasting Centre, as (see fig. 6). In Elohim, that is, the Mighty Judge, in the inseperable circumference, e. f. g. manifest from the middle point, b. c. d., namely from the CENTRE of Eternity, a, But as God is

Identical goodness. So could He not see, and Behold the works of His Creation, in this deplorable & Ruinated state; But He the almighty God, manifested His visible Love in the FIAT, or word, 6. In which He began the forming of this word FIAT, as is declared & revealed in the Holy Scripture as the Words say: In the beginning God Created the Heaven and the Earth was without form and Void. N.B. The Spirit of God moved upon the face of the Waters. And the Spirit of God moved & c. We will therefore make a Beginning from the words, what ever the School Theologians may have to assent, nor shall the same hinder our intention.

S. 16. From the above words, the whole world almost believes, that while the Text says, the Spirit of God, that the same was the Holy Ghost, as also that the same has by the Learned & Philosophers style another meaning Namely, that the same was the Created Soul of the World; Or was the Universal Spirit of our Solar System. The Theologists mean the same to have been, the Godly Unity (on according to their school Terms Trinity) is quite contrary. And was it not for those Conscientious people who may perhaps see this or read this. To whom we would not lay any thing before them that might give them offence. We could by a Manual Operation confute this Theological meaning down to the Ground. But we will deal herein with precaution, and desire the Reader only to observe that which shall be hereafter here and there said of of this matter, and particularly regard it, so will he find no Reason to blame Us, but will there find the same explained enough.

S. 17. This is certain, no true Theologist will undertake to say that the same was the Holy Ghost, for if he should, He has made a division of the Godly Unity, which would be an unanswerable demonstration, to make or bring the Holy Ghost in one particular place & would be open paganism. Should anyone undertake to prove this by the whole Magazine of School distinctions and garbs it would be very dangerous: Then so soon as one says: This was the Holy Likeness, for a further consideration: How this passage is generally explained by the Theologists is known to every body: Namely according to the Image of God, that is He was made in holyness & Truth, which as in itself is true. But the original Text, uses here two different expressions, Image and Likeness and my CONTERFEIT & STATUE may shew My Image, but not my Likeness, else this PORTRAIT or STATUE must have my Understanding, & all the properties of my Spirit & Soul. Who has comprehended in Spirit the 9. V. Rev. 24., and knows who is the Bride & Wife of the Lamb, will know what is meant by this similitude: But to write of this Mysteries more as has been Revealed to us, will not sit very well here, & which would carry us too far from our intention. Here some thing has been said which will enlighten a true Lover in the foregoing, and explain our Meaning. But to the Blind the noon day sun is lost. But perhaps this high matter may be further and

cleaner touched, Peruse in the mean while the following passages: Gen. xviii., xix., xxvii. 53., xxxii. 24., 26: Exodus xxxii 34., xxxiii 12. 19 till the end. xxxiv. 5. 6. 7. Joshua V. 13. 14. 15. Jud. V. 7. till the end. 1 Kings xix. 11 & 15. Esdra vi. 1 Con. xv. 49. "And as we have bore the image of the Earthly, we shall also bare the Image of the Heavenly." Dan. vii. 13. 14. & also farther Job. xxvii 12. 3. Wisdom vii. 24. 26. viii. 2. If the Lover of these sentences knows to unite them, so will the sense be clear and intelligible, what is here pointed at by the Image and Likeness? & Perhaps more of this might be said in another place.

S. 18. Following the Text further, where the same says: Let there be Light, and there was Light. And God saw that the Light was good & c. And God said, Let there be Light; which is properly so much said; the Fiat or word wrought the Light, which was the first Ray or Wonder Light of this Chaos, as L., see Fig. 6. S. 10., above, namely SALT, SULPHUR and MERCURY, not three distinguishable Forms or Matters, but One, yet what the signification of each of the Characters shews, in particular, observed, & was separated from the SULPHUREOUS, slimy, Salt Water. That this Light or Spirit was concentrated before in the Stars & Heavens, the Text further shews, and was therefore the Universal Light of this System, till the following separation of the great Lights of Heaven followed on the Fourth Day.

S. 19. And God separated the Light from the Darkness. Hereby was manifest, the separation of the Heavenly quickening FIRE, Light or Spirit, from the Earthly Grim or Anguish Fire that is the quickening Life-giving SULPHUR or Balsam, was now wholly separated from the Eating, tearing, destroying & death giving SULPHUR. And also both these contraries, as the one that held Life and the other Death, was manifest. And both sulphurs brought to light. In, and from the first beginning stood Adam in the Creation, in which he might have remained. Had he not by the Instigation of Satan tasted or longed in the Earthly, which is further treated of in the first part of SALT. This is also the Origin of this Earthly Globe or Ball, which further through & through, in its most minute particles nothing but FIRE, or SULPHUR as is said above in the S. 5. This FIRE or SULPHUR is in the outward parts, or on the surface of this Earthly Globe, very hard shut up, occasioned by the saltish through Watering of the Sea, so that this FIRE is not revealed but by Friction, as rubbing and other strong motions, then not only the other grand Heavenly Aesch Majim and the just mentioned earthly SULPHUR. N.B. Each in particular through his own Salt; (which of more may be seen below) according to its properties may be found without dividing its internal power. This a true CHYMICUS must know, or else He knows nothing, tis' therefore unnecessary to give here a Rx. & would not fit itself here, & which belongs to the Hand operations, which is not our intention here to Handle.

S. 20. That this Globe of Earth is through and through FIRE the manifold burning mountains at all parts of the same shews, then the Central depth of the Earth is not so penetrated by the congealing Salt-water, & therefore this destroying FIRE, has there a free power: And may be further proved, that if the fore-mentioned FIERY Mountains was a Vent or passage, the whole Globe would burst like a Bomb, But why this Vent is in the high Mountains, and not in the even or low ground? This is the Reason, because the Root or foundation of the Mountain is composed of a Fire & corruptible tinctured SULPHUR, as may be further looked into, in the first part of SALT of the Origin and Rise of the Metals and Minerals, more than this, all stones in the Mountains, clefts & c., as the daily experience shews from those workings in the quarries, the same property. Therefore the under earthly FIRE is lighted through the Rage of God, as an Anguish FIRE, for the Devil and the Damned, for the above Reason also, it is, that the same has there easiest Vent.

S. 21. What supports and Maintains this Destroying Earthly FIRE Sulphur in its Form, must be sought with diligence in the first form of SALT, & in particular to be regarded how that the Rays of the Sun works in the Slimy Waters; a natural SULPHUR; And the Turf which is digged in the Lower Saxony and used for Fire, grows again, and in particular in these places. The Lava or Ashes of the Burning Mountains, which is nothing in Truth but SALT, and this will already have given a sensible Person Perfect information. But no one must think here that we here contradict what we said in the foregoing 19.S., but on the contrary this is a further proof of what was said there, & has been evidently demonstrated in the first part of SALT, that sulphur is alcały SALT & MERCURY, the same as also the SALT is SULPHUR and MERCURY, and MERCURY again SALT & SULPHUR, for which the way of Nature may be seen by those who are experienced in the FIRE, & how & in what manner those three are in government but one; & can't be divided in eternity, or reduced to a Nothing. But to be after the predistinated time, brought or reduced to its first Matter, and therefore the same has in and from itself its sustainance. As also this FIRE of Anguish; that burns and yet is not consumed, till such time, all its impurities are cleansed, one after the other, through the everlasting, unalterable Love, and its first properties of light becomes manifest, and its Prisoners is released through Faith in Jesus Christ, till Lucifer remains in the Center quite alone in the concentred anguish, controlled, trembling, prickly bitterness, quite naked, & confesses his Honnid fall on separation. And longs again after the everlasting Love & etc., also when his CENTER shall be replaid in his first Sign and form, and then shall be, the great everlasting Year of Jubilee, the sentence is passed, and wherein each shall be raised and plaid in his right and properties His detriments, which was clearly typified by the great Jubilee of the Jewish Church, & Lucifer is become again a thing of all his Hosts. Which sentence is called

in the Holy scriptures ever, or from everlasting to everlasting. Representing that this Revelation, is an incomprehensible continuation of the Times. The Original Text uses these Words OLAM OLAMIM, & is here translated, ever or from Eternity, but its proper meaning is from time into the TIMES, and in the Latin Text the same is right in SECULA SECULORUM. But the true sense hereof is that this terrible Judgment shall continue its predistinated time, but not so long as God shall be, that is everlastingly, then by the original unchangeable presence of God there can be no passing of TIME, therefore as all our times have had a beginning, undeniable, the same must also end, as Olam Olamim plainly shews a nominated time or times, & c., is plainly demonstrated elsewhere, & times is comprehended, and is nothing but certain Periods, whose separation is through the Constellation of the Stars.

S. 22. This is also the origin of the Elementary SULPHUR, whose sign is as observed above in Fig. 2., of which we have already spoke of in the first part of SALT; This Earthly Sulphur cannot be refrained or withheld from any thing in the Creation in the three Kingdoms, and must be well known to all those conversant in the Art of Separation. "It is not the Balsam of Life, but the glutinous slimy property that holds all Bodies together, this is also the Magnet of which constantly attracts in this Creation the Heavenly SULPHUR, or Balsam of Life." N.B. The drawing on contracting, but more shall be said of this when we particularly treat of the Use of this SULPHUR, but before we close this Chapter, we must follow the Holy Text a little further, concerning the above, on our Earthly or Heavenly sulphur, as the true Balsam of Life of all Creatures, although in the first part of SALT considerable has been said of it. To which the following may not be unserviceable & may help to enlighten it.

S. 23. In the above S. 4., we have said, it is necessary to consider these Words: In the beginning God Created the Heaven and the Earth, & in particular why immediately after the word Heaven, this Earthly void lump is placed? We shall not here follow the common Interpretation because the same is foreign, and far dispersed from the secret sense: And must minutely consider the words, in the beginning God Created the Heaven, and further say, that from these Words, God Created the Heaven, nothing further may, or can be understood, but the creator of all the upper Worlds (which shall be circumstantially treated of in the third part of MERCURY in the Chapter of Astrology) with their different Choirs, Orders, Principalities, as also in the same shall be comprehended, the Worlds of Lucifer, and all His Angels, (Our present Solar System) as the Center of all the above Worlds together.

S. 24. Further, we must consider the connection of the Words, the Heaven & the Earth, Namely, that between the same something particular was translated (as is

plainly demonstrated in the first part of SALT) the words of the Creator of the six days undisputably further declare; and God said Let there be & on the first day, Light, (not Schamajim) (but On) the soul or universal Spirit of the World, the Spring or driving Motion of this System, brought out on through the Fiat, by which these words are placed, the Evening and Morning. N.B. The first Day: The Interpretation of those words may be further seen in the first part of SALT, as also the S. 23. is to be well observed, the second day, let there be a firmament or expansion between the Waters and the Waters: Further Gen. 8: And God called this expansion Heaven: Now the first Verse says, In the beginning God created the Heaven and Earth, which words must be understood in a double sense, (1) in Commencing of the Creation of Heaven & Earth in general (2) in abstracts, or in particular, which the word Schamajim (Heaven) is understood in a double sense, as firstly, where it says v.1., the creation of the upper & Spiritual Worlds signifies in general, & then secondly it signifies in the 8th. verse, the astonishing distance from our atmosphere to that of the fixt Stars, or upper Worlds; which ought to be well observed, that one does err in the following regarding the Creation of the Schamajim, the Spiritual World, which see farther in the first part of SALT: But He that knows not to unite this & that, will fall in a great error: And therefore the Reader will find it necessary to peruse with deliberation all the 3 parts: The word Schamajim is true, is used again in the 20 verses but in general badly Translated, & is there called a Bird: And the Winged Fowl, that may flie above the Earth in the open firmament of Heaven. But Rather has translated it better, & with winged Fowl that flies on the face of the Earth under the expansion of heaven. But the indentical sense of the Ground, just is this. And Winged fowl that flies on the face of the Earth against the surface & expansion of Heaven, that is, flies under the Heaven in our atmosphere, which we have therefore noted or mentioned, that no one may make an unnecessary remark on the word Schamajim in this place Gen. 1.-20.

S. 25. But to return again to the creation Schamajim (and how this word in Verse 8, is used and to be understood) we have therefore already said that the word Schamajim, comprehends all that is between our Atmosphere and the atmosphere of the fixt Stars, with all their Bodies therein contained. Yea the unfathomed expansion or firmament of all the upper worlds, and is, or are the sum in each SYSTEM are the Noble & most glorious Bodies then all the rest; even so is it with our Soul & Spirit, which pervades the whole Body for its motion, but has its proper residence in the Heart, also the universal soul of the World (is light) the cause of motion, which is expanded through the whole Universe for a perpetual Motion, of this wonder Worthy Machine. But in the Sun this has its seat & Throne, as the Heart of the World, from

whence the same comes to all Bodies of the Creation, and quickens the same & with multiplication & is only in the fixt Stars and those Bodies which we call Planets & wandering Stars: And the Godly Majesty has fixed and decreed to his Glorification, that in and all these Stars or Bodies are unnumbered Creations according to the property and quality of those Bodies. Then as not to be thought that God should have formed or made those wonder Worthy Numbers of Globes or Bodies in the unfanthamable abyss or Void (or by comparision) dead balls rolling in their circuit, but has created and filled the same with Creatures, according to their several distinct properties to Glorify and Praise his Glorious Majesty, whereof in the third Part of MERCURY more shall be said at large.

S. 26. That what we have said in the foregoing S., namely, that that Light or the Universal Spirit of the World, which was brought forth from the Fiat, quickening all things to Life, is motion, & the cause of growing & vegetating, and is that which the creation of the third day confirms, where the words run thus: And God said, let the waters be gathered together under the Heaven in one place and let the dry land appear: And it was so, and further God said: Let the Earth bring forth Grass, the Herb yielding seed, and the fruit Tree yielding fruit after his kind, whose seed is in itself & it was so. Therefore through the Universal Spirit of the World the whole Vegetable Kingdom was brought forth as the Sun or Moon or Stars was created. Then on the fourth Day there was through the fiat a separation of the Light, namely in the Universal Spirit of the World, from which was separated the coarser part. (this word coarse we have been obliged to make use of for want of one more expressive.) And from this are all Bodies under the Waters, above the Heaven or Worlds was originated, which water is called by the wise AESCH MAGIM, that is Schamajim (Fiery Water i.e., Heaven) and that the Sun is there placed as a Middle point or Heart of this World, as the Identical residence & Throne of the Universal Spirit of the World, from which He is perpetually Awakened, strengthened, strengthened & fortified for his Work, just as the Spirit and Soul of Man comes from the Heart which is withheld by a foregoing Warmth in Life & Motion. In this Globe of the Sun this Spirit concentrates perpetually, and enables Him through his Middle point to send His Rays more vigourously in the whole Universe to keep all things in Life and Motion.

S. 27. The Creation of the 4th. Day is in particular to be considered, that the Great Light, the Sun was created to govern the Day, & the Lesser one, namely the Moon to govern the night, as also the Stars and does another in Glory; whereby we say further, that as the Sun by Day in its enlightened SPIRITUS MUNDI gives to all Bodies its Rays, even also does the MOON, by the driving and pressing the Rays of

the SUN, which are in her and the AIR is the expanded Soul of the World. But not as the SUN in sulphureousness, but in a SALTISH NITROUS form, as a moistening, spiritual substance, on Feminine Seed, to rise or swell the SOLAR sulphur on Masculine Seed, to bring forth all the Creation, in all the three Kingdoms by her Nocturnal Rays which she emits, whereof more may be seen in the first part of SALT.

S. 28. Just now we have mentioned the working of the Universal Spirit of the World through the SUN and MOON; which is to be observed, that as this Universal Spirit is every where the same, and are also, in all, one and the same; and of consequence follows, that the Rays or out flowing of the SUN & MOON, as also the Stars, are wholly one & the same: But the difference of Bodies according to their qualities is occasioned, also, as in the SUN is a FIRE or SULPHUR and in the MOON, a SALTISH WATER, which are although in their center one and the same; then did not this occur, nothing of the Creation could be brought forth. The same properties may be observed in this Spirit, and all SUBLUNARY CREATURES. When the heart as the residence of FIRE or SULPHUR and the Rays, that is occasioned by the moist SALTISHNESS, not one and the same source had, the whole Human frame could not stand a moment, or be capable of Increasing, also was there no Harmony between the Masculine & Feminine Spiritual Seed, there would be no Children generated in eternity; by which we have occasioned to take the same in a further consideration, namely Gen. 1:26 & 27., it is said, as after God said, Let us make man in our own Image & after our Likeness & c. Wisdom 1: 23. And He made him in the Image of His Nature; and further, also God created man in his Image, according to the Image of God created him (according to the Image and Likeness of the Fiat, through which all things were created in Heaven and Earth: (See S. 19). N.B. Here we have made use of the word Image, & have LEFT out the word Likeness, a sensible person will understand, without METAPHOR on our further description, enough hereby is shewn, that the Image or form of man was made like unto the Fiat, whereof here further more, Masculine & Feminine created He them. The 27th. V., says, according to Our Image, according to our likeness. In the 20th. V. according to His Image, according to the Image of God created He them, (which is spoke of Man or man & woman as they are found & observed) male & Female Created He them. Namely, (this is spoken as the different properties in him for their Increasing) from which sentence, may undeniably be observed, 1. That each word, Image & Likeness point out some thing very particular, of which we have already sufficiently treated in the 22. S., to which the Lovers hereof is referred: 2. He created them Male & Female, but will shew, that How God is one or Unity, and that the first created Man was but one and stood in Unity: But which Unity was so created or made, that the same was culpable of increasing: Therefore the Text says: He created them; (man is a single

number) but where He says: Created them, comprehends Male & Female, to shew the power with which he was created: But how this Increase should have been, before Man was infected with the Beastly Imagination, through the List of the Devil, and how the dividing and working, suffering power was occasioned in him & Is a secret, which must be sought in the similitude of God. But to a man resigned to God, the Spirit of God may conduct him thereto, even in this Mortal Life. The Almighty God is and remains the incomprehensible Unity, & works all things in and through himself; also could Man, as also he was by the separation become man & woman, Increase himself, also in his single number Adam, in and through Himself, whereof enough is said for this time; the Lovers whereof may find more in the first Part of SALT.

S. 29. We return again, to the Origin of the over Earthly and heavenly SULPHUR, as the true Balsam of Life of all creatures. In the first part of SALT, is true we have already said a good deal, & the following will serve a Lover to enlighten (elucidate) the first part in more particular. In the just mentioned tract, we have said that God created all things from the out flowing Spring of his Majesty, and that this outspringing or forth-going is a spiritual Wonder SALT which was also FIRE and WATER, namely also SULPHUR and MERCURY. But this incomparable united substance or matter, the first Godly forth-going or (breathing) may not be comprehended, without a particular enlightening of the Holy Ghost in any way, or even to form an Idea, it is then in the similitude of a few words, the 148 psalm says, v. 4., Praise Him thou highest Heaven, & thou Water, above the Heaven, this is the first exhalation of forth-going of his Glorious Worthy Majesty, the unmeasurable, unfathomed & incomprehensible Sea of his almighty Wisdom, Aesch Majim, properly called the Crystalline Sea (see Fig. 6., S. 10 above). In which the godly Majesties goodness everlastingly flows without ceasing, & from thence to all Spirits and living creatures, for their existence & increase. It is the outgoing of the Trinity in Unity: Three single substances or forms SALT, SULPHUR & MERCURY. Keep your hands from this, You, that are filled with the earthly Whims, in that we speak not of your smeary salts, stinking SULPHUR & poisonous MERCURY: We have said, this Aesch Majim, is a single Trinity, which was manifested first through the Fiat, in the Spirit of the World, out of the Circumference of Aesch Majim till to the Central or Middle point of our Solar System, (that was in the beginning the Throne of Light of the Son of the Morning Star, but now being the middle point of darkness & through the specific Creation is manifest in SALT, SULPHUR & MERCURY, which will not be known or understood but of those, which knows the true separation of the Life which dwells in all Bodies, known from the earthly Bodie, or otherwise through the Right magnet, (understand this right; it is the ENIXIUM UNIVERSAL, but not the \oplus Enixium, which the Glass & Crucible Murderers do learn on) this

is the Life or Balsam of Life of all Creatures (also is called the Spirit or soul of the World) which to accomplish the following will be better to explain.

S. 30. In the foregoing S., we have said, that the AEsch Majim, or the WATER above the Heaven was the first forthgoing of the everlasting Godhead & from which all was made or Created, namely, all that is therein contained above as well as all below, as well as all the upper worlds with their qualities & Creatures (see Fig. 6. S. 10, above) (the relative to the Spirit above the heaven, that are continually before the most Holy Face of God, namely that are in his consort & His presence, the same has quite another station) and out of the same, as one incomprehensible subtilty and Unity in Trinity, all things are withheld in Life & Substance. These Fiery WATERS are the above earthly & heavenly SULPHUR or Balsam of Life, whereof we have chosen to speak in the 27th. S. Those separate themselves firstly in all the Hierarchy of the Angels, from thence to the worlds above, (which by the astronomers is called the sphere of the fixt Stars) which Light, or the universal Spirit of the World remains to uphold all Worlds and the Creatures of the same, as in the continual inflowing or overflowing them to their support & Increase; As the AESCH MAJIM, however, SULPHUR, or Balsam of Life, namely when the same has been first SPECIFIED in the upper Worlds according to the properties of each World, & then further comes into this our System, through the Rays of the SUN by Day, and the Rays of the MOON by night to this Earthly Globe whose continual flowing makes all things Live & Grow.

S. 31. At the end of the 34th. S., that the true Lovers of the Mago Cabbalist Theosophictica may through or by the true magnet obtain this so circumstantially & Spiritual SULPHUR or universal Balsam of Life, to those experienced in Nature we have here said enough. But to the unexperienced, that have a desire after and attention to this Secret Wisdom, serves for information, that this wonderful SULPHURS first-form or substance (while this AEsch Majim is far beyond our comprehension) is not to be obtained by man through any Art or Knowledge, but only so far, as the same is hid in this System, Light or Spirit of the World, & in all created things, as their life and sustainance; but the easiest way as we may say, (to obtain the same) is in its untimely separation, namely before the same has taken upon itself, or become, the properties of Bodies. Where this is to be sought and found? We ought to say, but at this time shall only point, that it is to be OBTAINED THROUGH A MAGNET CALLED ENIXIUM, who knows and understands the Power of attraction & Sympathy, will know to help himself herein without further information. LEARN TO KNOW THY SELF. To the Wise this is enough.

S. 32. Before we conclude this Chapter, we will again consider the Words, Gen. 1. V. 6., And God said: Let us make Man, according to our Image & Likeness & c., not

according to the school Theologists, moreover, but Magical & Theosophical, Namely, of the Image or form of Man, in the Hebrew called La'lem. That this form or shape is not altogether to be looked upon as beastly, or according to the School TERMINIS ANIMALI, because our Bodies are found corruptible & to have some of the same properties of the Brute Insensible Beast, but shall consider the same in angelick form, of the which We are here intending to treat of. That this Natural Body of ours which it has borrowed from the corporeal & Visible Elements for the dwelling of the Spirit, the soul, and the inward everlasting Spiritual Man, as liable to corruption, Death and passing away, & that Death, corruption, putrefaction & their Elemental properties, cannot possess Eternity in this form or state: No sensible nor God instructed Person will in the least doubt. That St. Paul had Christs meaning & clearly left the same, 1. Cor. 15. 44., shews. It is sown a Natural Body, it is also a spiritual Body. V. 46. But the spiritual is not the first, but that which is Natural and afterwards, that which is spiritual. V. 8., as is the Earthly, such are they also that are earthly, and as is the Heavenly, such are they also that are heavenly. N.B. V. 49. And as we have been the image of the earthly, we shall also bear the Image of the heavenly. N.B. V. 8. Flesh & Blood cannot, and all things springing therefrom, as a certain Black Bearded Theologist, and others of the same opinion. But these, belong not to the Everlasting Life, then those parts & Members cannot inherit the Kingdom of God, Neither can the Mortal inherit immortality. And those Notions belongs only to the Jews & Mohamaton, whose Fleshy Parts and qualifications are this imaginary Paradise.

S. 33. From the above mentioned sentences, tis' clear & manifest, that in this Earthly Habitation, without Soul or Spirit, there is hid an invisible Body as the proper dwelling & habitation of the same, that the Spiritual man is composed of three or in three spirits, as Spirit, Soul & Body, is everywhere proved in the scriptures: Where there is separately mentioned the Spirit of Man, & the Soul of Man; St. Paul Hebr. 4. 12, says the word of God & c., dividing asunder of Soul & Spirit, & of the Joints & Mannow. Thess. 1. 5. 23. And He the Very God of Peace sanctifies you wholly: N.B. Your whole Spirit with the Soul and the Body, to be preserved unblemished, unto the Coming of our Lord Jesus Christ. No man of sense, will doubt these truths, Namely that Man is composed or withheld of, 1, or in three. But mankind in general knows no more than what Mr. MAGISTER NOSTER says and Preaches, ERGO, this our inward Man and Soul or Spiritual Body, has its Origin from the angelick World. But the Spirit which was immediately from God which He breathed into Man, has a far higher Origin, namely from the Heaven of the Spirits above the Heavens of the Angels. AEsch majim, the first godly outflowing, in the true form of a Spirit, without the

form or Image of either Angel or Men, namely the Spirits that are, and stand continually before the Throne of God, The Temple of the fullness of the Godhead, Jesus Christ, as in whom the (Countenance) face of God is revealed, to know and to see him.

S. 34. In the foregoing 37 & 38 S., is shown our spiritual or inward man, and that the same is formed or figured like to this earthly one, and has its certain length, breadth & expansion, according to the outward form or shape of our Members, (namely so far - as the true Human figure is formed or Likeness may be signified; then in the true Adamical Likeness, has not need of all Members, which we have mentioned to our reader to remind him, not to entertain that shameful Notion, with the Jews & Mohometans of their Paradise) the words Image & Likeness proves this, Gen. 1. 26., further that the Angels, yea the very Cherubim & Seraphims have a human form. The Holy Writ testifies everywhere, Exod. xxv. 12. 19. 20., where the forms of the Cherubims is thought of, concerning the same, see Josephus on the Antiquities of the Jews, & how he describes those Chububs, farther see Esra. V. 1. 2. Dan. vii. 15., ix: 24., xii. 12. Acts. 1: 10., and in the Revelation almost everywhere; cannot be denied, therefore, that the angelick, and in and outward figure of Man is one and the same, except tis' by those METAPHYSICAL PHILOSOPHERS, with their ungrounded Dreams, stifle the truth, & take upon them to prove those are only forms acquired, namely that the Angels which appeared to the Patriarchs, acquired or took upon themselves a Human form.

But how tasteless and non-sensical these high bound Whims are, in comparison to the pure clear Godly truth, a Lover of truth may easily comprehend. All things comprehended under the Schamajim or AEsch Majim, whether Spiritual or Corporeal, wears or carries the Image & Likeness of the Earthly & Heavenly Adam, the Angels as clarified Spiritual Bodies. But Man, not only after the fall of Adam in his Bodily Elementary form, is like unto the Angels, but also in his Spiritual Body, confirmed also by the Soul & Spirit which God immediately Breathed into Him, from, or out of the beginning or origin of Spirits above the Heavens AEsch Majim, that has no human Figure, in that the same is the beginning of all Forming or Figurating as is made in Eternity; therefore, this so excellent Soul, which God inseparably united in Man through his Almighty will in the Creation, & that this Soul of the fallen should not lay in everlasting perdition, came Christ the Lord in our flesh & Blood & by taking of the same upon himself he fulfilled the Eternal decree of God & accomplished the Redemption. But no scoffer must come here with his notions, namely if the inward man is formed like the outward Man, as Cripples, Crooked, Lane, little Children, Long or short, big and little Men. The Answer hereto: Prov. xxxi. 4., Yet we will answer these fools wisely, & see if thereby they will become Wise also, and say, that we,

that will be partakers of the Clarification, shall be like unto the glorified Body of Jesus Christ, in the Measure of his fullness, & Whether we are in this Life crooked, Lame, Little or big, which are wholly the effects of the Astral Elementary Copulation of the Image of the Ideas, Imaginations and desires.

S. 35. We proceed farther & say, that Lucifer and all his Host before their fall, had the same form & Figure, but when they lost the Light, they also Lost the same. And although the Devil appears, to this or that Soncener, in Human or Angelic form, as St. Paul says, that Satan can transform himself in the form of an Angel of Light; as well in the APPARENT Holiness or Figure, yet in such appearances or Figures, there is always found a difficiency. Then 'tis impossible for the Devil to take upon Himself either the Figure of a Tame or Horrible Wild Beast, without a deformity or mixture. Because by his separation or fall, His form or figure is uncommon and through the rage of God, contrary to all forms of the Creation, so that the true form or figure of the Devil, can not be seen by any Earthly Creature; therefore in this or that natural shape He has always an addition, or exchanging, but yet defective. His present situation is the incomprehensible Darkness, Bunning Cold, or a Cold Bunning, in a Horrid unbearable form or Figure, which is not to be found, or is excluded from the Spiritual & bodily World: And in the scriptures he is called and shown to us under the form of the Old Serpent, or old Dragon. But whereof enough: We will leave him in his chosen ruinated state, till His time is fulfilled, namely, till the end shall come. And Christ the Lord, shall have answered the Father that is, the Kingdom of God, and when all Dominion, power and might shall be put away, then He must Rule, till his Enemies becomes his foot Stool: But the Last Enemy which shall be found is death, 1. Cor. 15. 24. 25. & 26., (not the timely or present death, but the everlasting which Satan brought through his Lust) & then will be wholly fulfilled what, Rev. 2: 3. And there shall be no more Curse.

S. 36. We return again to Angels, and Man, and by this opportunity will just mention, something of this food & sustenance, in the 8th. Psalm, we read, V. 24. And he rained upon them Mana to eat, & gave them of the corn of Heaven, V. 25., and every one did eat of the Bread of the Mighty. Item. Psalm 105, 40. And He satisfied them with the Bread of Heaven, & further translated; psalm 78; 25. They eat the Bread of Angels, & in the 16th. V. 20. of, He feeds his people with Angels food, and sent them bread prepared from Heaven, without work, which gave them every Least, & every delicious taste; which represented the Spiritual Bread & food Jesus Christ, the true heavenly food to quicken Soul & Body; and also to nourish the spiritual body, the true Adam, be feed & satiated in the eternal Life with the food of Angels. Therefore says our Lord and Saviour Jesus Christ, Math. 8:11. Verily I say unto you,

there shall come many from the East and West, and shall sit down to table with Abraham, Isaac and Jacob in the Kingdom of Heaven, Luke 13: 29., & they shall come from the East & West from the North and the South, and shall sit down to Table in the Kingdom of God & c.

S. 37. Those applyed scripture sentences, needs not by those who reads the Scriptures in singleness of Heart & earnest DESIRE, to search for the truth & Wisdom of God no farther explanation. But the masters of the same & which explains them in their high and Learned manner, & particularly according to the meaning of an undisputable fine Author, their Predecessor, teaches Mankind so and as other (although the Holy Ghost is herein abstract in its function & of our Light and Instruction, so that its power is hindered & unknown) and yet their belief is strengthened by this saying: The Kingdom of God consists not in eating & drinking; Rom. 14: 17., although many of the Lovers of this self denying action, are yet seen running with such desire after their belly privity & leaves the poor pastors with his Church unvisited. But sings with the EPICURE, Eat, drink and Live Stout, after death all is out. True is it, that the Kingdom of God does not consist in Bodily Eating and drinking, as we do in this Life, for the support & maintainance of this sinful spoiled Flesh. But that also in this Bodily food, NAMELY IN THIS EARTHLY MEAT & DRINK, which is a kind of vehicle TO CARRY THE ANGELICK FOOD TO THE UNWARD MAN FOR ITS SUREST STRENGTH & NOURISHMENT, NO ONE WILL DENY THAT HAS SEEN OR KNOWN THE TRUE LIGHT. The more this our natural Bodily meat and drink is blest & sanctified by God Almighty with this Angelick food, this hidden MANNA, the more durable, constant & Lasting our health is found, which fulfills what Moses said, Deut. viii. 3., says, that He might make Thee to know, that man doth not Live by Bread alone. But by every word which proceedeth out of the mouth of God, doth man Live, & what Jesus Christ the Lord said to Satan, saith so too, man doth not or shall not Live by Bread alone, but by every word that proceedeth out of the mouth of God, till his predestinated or numbered days are accomplished & has received the Wages of Sin, namely, through the Bodily death & the corruption of the fleshy dwelling, in which Adam dwelled, through the awakening of the Devilish Imagination.

S. 38. Now many would be glad to know wherein this Angelick food consists? And how the same is received? But to speak of this in our dying, Mortal Life, as we have seen & known ourselves in the Spiritual state, is not possible to know without an immediate Revelation of the Holy Ghost, as the scriptures are herein silent, & of this nothing clear & intelligible is therein found. We must therefore content ourselves with that Light that has hitherto conducted us, In the interim, the Heavenly Manna which fell for the Children of Israel in the Wilderness & fed them 40 Years &

satisfied them in all their Lustful Imaginations, is an excellent Type of the Angelick food. An Incomprehensible Godly satiation, more of which see in Chap. II.
S. 4. And herewith conclude this Chapter of Sulphur.

CHAPTER 2.

THE USE AND PROPERTIES OF THE HEAVENLY SULPHUR.

S. 1. Let no one herein seek how Matches and such like things are made. Then we shall treat of quite another use & properties as of this old Womans Mechanical Fabrick. Nor must the Gold Thieving Alchemists thus train their imagination that we shall show them their common & so called out pressed Spirit of SULPHUR? In the foregoing Chapter we have spoke of two SULPHURS, the Heavenly & the Earthly, and now are intending to treat of the use & properties of the heavenly, with the grace of God, as much as is known to us, that the heavenly SULPHUR as well as the Earthly is the cause of all compactness, & of course conponality. No true Naturalist will deny. The true Art of Separation Manifests it, Namely, when its Body is dissolved without the force of FIRE (as by the knowing Hellish MENSTRUUM, is not dissolved, but tore from one another in a Hangmans Murthering way) and brought back.

S. 2. Here the poor gold thirsty smeary stew-cooks, plague themselves to find a Menstruum to dissolve GOLD & all other Metals radically & then to make the Volatile Fixt. Here is found such unheard of strange processes, quite contrary to the ways of Nature, (From such rare, contrary things, that Ignorance herself, would be at a loss for such foolish inventions. And the paper that is blotted hereof would warm the rooms of a garrison a whole Winter. And is scarce credible how much GOLD & SILVE is chased through the Chimney, by their Hellish Murthering & not only wholly destroyed but being without even the Wonder Stone of the Wise, still unknown to the Rest, by their Thieves Work, becomes invisible.) did they but know the ways of Nature, these absurdities would soon be manifest, & would see, in how far different this Universal dissolvent must be, & that the same is a compounded matter. But that IT IS ONE SINGLE MATTER. Then as the Number one or unit cannot be divided by numbers. But this

one Number may divide all Numbers; even so is it relative to this matter: Namely; that that thing which must dissolve an elementary Body, or compound substance, must consist of the most simple unit, that it may be agreeable to all Elements & the parts of the composition that figures or binds a body, & in a moment, as the beginning of all things, pervades or goes through without violence and reduces or brings back to its first form or Embryoni: We say EMBRYONI, then to bring the same in the first Essence or out-flowing unity as it came from God, is hid from the Understanding of Man, then the opening or dissolving of the Elements, God has reserved to himself, to the great Day, to pass Sentence, and to the time that Esai. Lxv. 17., has mentioned: See I will Create a New Heaven and a New Earth, and the former shall not be remembered, nor come upon the Heart. And 2 Peter. 3. 13. We are waiting according to his Promise for a New Heaven and a New Earth, in which dwelleth Righteousness, farther, Rev. 21. 1. And after I saw a New Heaven and a New Earth, then the first Heaven and the first Earth was passed away, and the Sea was no more & etc. Further peruse this Chap. with all diligence.

S. 3. What has been said in the foregoing S., is enough for a true Naturalist. But to the Gold Makers and their tribe, is said nothing at all, then while these are the words of Christ our Saviour, Life & Light. Math. 6. 33., are diametrically opposed to their ways, namely; But seek ye first the Kingdom of God, and all these things shall be added unto you. By wholly turning and first consider the part, and, that Gold & Covetousness is not able to satisfy the Soul, before you reach after the Godly knowledge & how Nobley He manifests himself in his Creation without which they remain without their knowledge as blind as Bulls, & Leaders of the Blind, till they of all sides of this timely, & but to obtain in that of Eternity & fall together in the Pit.

S. 4. That both the heavenly & Earthly SULPHUR is Light & of consequence a fire, the first is an equally quickening, & Life giving Light & FIRE, pleasant & Joyfull to all Creatures. As their Life & Support, but the other is such a disagreeable Hell Coloured stinking matter, destroying all Earthly things into dead Ashes, & consuming Light & fire & which will have been well understood from what has been already said hereof, to satisfaction. The first is only one single Matter, although it is signified by SALT, SULPHUR & MERCURY, but the other is a composed or mixt matter, a slimy Saltishness, drove together by the subterraneous FIRE of the Earth, while this Saltish Slimy gross MERCURIAL WATER is thus impure, it can penetrate (divide) this Earthly SULPHUR in its most minute particles, as well in the wet, as the dry Way, but not after the manner of the foregoing Chapter or section, S. 2., the secret radical dissolution. Hereby the Montebanks may know & see, how hurtful those sulphureous,

namely the common Balsam of SULPHUR is for the Human frame, but what properties this true dissolvent must have, we have pretty largely mentioned here & there, (in & on itself). And hereby will farther remind, that the same is in a particular manner a Universal Medium. We say in a particular manner, then in its pure UNSPECIFIED state, it is truly such a fire that would dissolve our Earthly Bodies. But when the same is specified, and by us obtained in the form of a red SULPHUR and has been dissolved in its own Mercurial Salt Water, so is the same the TRUE AURUM POTABILE, which is so much sought for, but found by so few, this is the Meat & drink with which Elias was fed by the Angels. 1 Kings 19 6., by which he traveled 40 days & 40 Nights without Elementary food & drink, to the Mount of God, Honeb, this is the drink; Book 4 Esdras 14. 47., which he, Esdras drank of out of the Pitcher full of WATER whose color was like to FIRE, this is the food which Our Lord pentook of in the Wilderness, in the 40 days & 40 Nights of his Temptation. As he himself in the devils strikeing him said (to whom this food of Light is now wholly Lost on hid). This saying, Deut. viii. 3., which is interpreted according to the Original thus: Man Lives not by Bread alone. N.B. But by every word which proceedeth out of the Mouth of God. But the foregoing words must have been also well observed, which says, And he humbled thee, and suffered thee to Hunger, & fed thee with Manna, which thou knowest not, neither did thy father know, see Chap. 1. S. 41., till the End.

S. 5. A nose wise Scoffer, might here ask us, seeing the Matter is so much known & spoken of, if we have the same? Or why we don't prepare the same, for our Use, seeing that nothing greater or higher could be wished for in this Mortal Life, as the Jewel which preserves & supports Health & Long Life? To such a one, we first shall answer, Another thing is Knowing, and another thing doing & possessing. Then the knowing all the Materials, & how a shoemaker makes a Shoe, does not imply we can do it; further one may know how the Land is plowed, manured, Harrowed and then sow the Corn, & as also when the Wheat is ripe it is cut by the sickle or Scythe, brought into the Barn, threashed, ground, Leavened, Kneaded & then must be Baked to Bread. But if one had neither, House, Farm, Land, Barn, or oven, & can't bring also the theory into practice, & yet this does not hinder the fundamental Theory in the least, by this reason we answer this over Cunning one. Why we have not long ago, made & done this or that before. We have undertaken to talk so much of it. Foolish; hast thou not regard, how wonderful the Almighty distributes his Gifts? To the one the perfect knowing, the other without further to do, the performing, this or that without even so much as knowing the true Grounds necessary for the accomplishing his intention. For Example a shoe maker makes his shoes of Leather whose preparation, may be known to him, but knows so little of the properties of the Beast, (whose skin has

been taken for his Leather) as we do of the secrets of the present Emperon. But we are not obliged to give an account to any one of that, which we herein have done, on it pleases God to give us Life & Health still intending.

S. 6. But perhaps it may be shown, why we don't reveal & describe this matter more open & Clean, that each one might comprehend & understand, as, how, where, & in what manner it is to be obtained, namely, this Universal dissolvent (which we here call the SULPHUR of the Wise, but before, the SALT, and as after shall call it the MERCURY of the Wise) And how it is to be prepared, to be the so much praised Aunum Potabile: Surely, He would have deserved to be Laughed at, that should set before a lazy, foul drone, a soap ready prepared, & then when he would not give himself the trouble to feed himself, feed him in the Bargan. But that such a one may have some satisfaction to his Question, which indeed the following Proverbs xxvi. 5., will suffice, namely, Answer the foolish according to their foolishness, that he may not imagine himself wise. The Lovers of Truth must Consider well, how the pure Rays of the Sun concenters themselves in certain Boggy WATERISH marshes, to an apparant natural SULPHUR, & in others, all sorts of Coals, & again in others, Turfs or Mud, but often in an apparant good Iron Stone, which are according to the several degrees of SULPHUR from the SULPHUR APHOR out of AESCH MAGIM, according to their several Specifications, and as far distant from each other as Light & darkness, & even then they are in their inward Center even the same red SULPHUR APHOR. He who has an understanding, let him understand, & note this Well, as also of that said hereof in the first part of SALT. Who knows the working or Influences of the SUN & MOON, will easily comprehend, what is said in this Part Chap. II. S. 34. And through the sympathetic Magnet ENIXIUM may be obtained for the Wonder Sulphur AESCH MAGIM, which is at the same time SALT and mercury, & even that what was very lately said (the text says) (the alcahest) & implies as much as a substance.

S. 7. We know not, how we could well have spoke plainer to a desirous Searcher. But for the foolish we concern ourselves not at all. But concerning its preparation, the foregoing similitude lets in light enough. We have said, that the rays of the SUN & MOON coagulates themselves, in the Saltish Waters, & becomes Conponeal, but why not in clear transparent WATER, that has no manner of thick Slimyness in it? Therefore or wherefore? Fathom this with all thy drift, so will the Knowledge of the Rise & Origin of Metals & Minerals in the bowels of the Earth, be revealed & Clean, and will better comprehend what we have said in the first part of SALT, Chap. 1. S. 22., with the following already spoke of. Then those visible workings of Nature, which are before our Eyes, Leads & Conducts us to the hidden Secrets of Nature. In the foregoing first Chapter we have said that this is not to be obtained in its

first on Pure State (by Human Art & Knowledge) or in its first and flowing from the Godly Majesty, of which all things are created, and called in the Holy Scriptures, a nothing, because in its first unity or single state, it is not to be named by any word, of Human Language, but is to be by us obtained through the Universal Spirit of the World, by the Influences of the Stars, here and there, and every where, one will dip it up, or fetch it, attracted, or otherwise may be sought for as one will; Man fetches fish, Birds and wild beasts very often in holes; Water is used up very often from Springs or Wells, Brooks, Rivers & Seas with all sorts of Vessels, and how many ways and means are these not used, as one obtains a ripe Ear of Corn? An Experienced Huntsman knows many different Baits to draw his game to certain chosen places, & not seldom uses for his baits or traps CERTAIN PREPARED SALTS, not only to attract his own game, but others also out of his district. The FIERY SULPHUREOUS propertie of the Load Stone, attracts the Iron to itself for its food with great power. A CALCINED FLINT OR FIELD STONE HAS WONDERFUL POWER. BUT ABOVE ALL, THE PREPARATION OF THE LEPROUS SATURN, OCCASIONED THROUGH THE WORKING OF NEPTUNE, AS A WONDER SKILL OF THE SECRETS OF NATURE. But this word will not be laid hold of by every one; who can comprehend, Let him Comprehend. Math. 14. 12., that the THUNDER, LIGHTNING, HAIL & RAIN GAVE THE WISE GREAT INSIGHT & SPECULATION: Is to the over Wise & foolish, unknown, SAPIENTI SAT. By similitude and sympathy one may cure distant, Wounded, Lamé & the sick & as also through Antipathie much damage may be wrought; Yet till here, and for this time, no farther.

S. 8. To return again to the preparation of this Universal dissolvent, so is the same to be done but one Way, the Wise say: SOLVI & COAGULI; namely, when that is obtained, which the foregoing spoke of & which we called in the first part of SALT, the RED & WHITE SOLAR & LUNAR, Male and Female SULPHUR, but is called in this tractate, the above Earthly or Heavenly SULPHUR and the true Balsam of Life of all Creatures; this SULPHUR dissolves it self in its own Saltish MERCURIAL WATER, as then is it the true AURUM POTABILE, (see above S. 4.). But, O, how rare is this Paradisical Bird, this Wonder Medium heals all infirmities & Sickness for Life, till to its appointed end, (that is while the same is still Lap. P., and has not been fermented & made a Tincture) namely, till these Members (which may be compared to the Wheel & works of a watch are loose & worn out, and also of no more use to answer its purpose) are thus incapable, to receive this Noble Balsam of Life for their support and Restoration.

S. 9. The before mentioned high & wonderful Secret, whose inexpressible power & Virtue cannot be praised enough, is a Rare Bird as we have already said. And only a few extraordinary Holy ones partakes thereof. In the Old Testament we only read of Moses, Esdna & Elias. In the New Testament we know of none, as only of Christ

our Saviour, in the days (if one may say it) of his Manhood, all others since (then) are unknown. But that there may be such, who boast the same. The true MAGO CABBALI THEOSOPHIS will not Believe. While then the forementioned is so seldom to be found, the desirious hereof, by or through the Ways of Nature before their eyes, are got in another way, namely they have took this SOLVENT in a certain degree, when it is already a SPECIFICATUM, a WATER, & YET NO WATER, although it wets in a particular Way, but yet wets not the Hands, much less snaps and rises in the FIRE Like the common SALT. But otherwise suffers itself to be melted with the Metals & unites therewith, but how it is properly called, we are scarcely able to say, even so is it with the Farmers & dairy men, although these know the same very well, because it is so common, & without it no Creature would Live & Grow. We must do it comparatively or Emblematically through the Hebrew word, Neter ①, then this Neter must have a very particular power as is seen in Jer. 2. 22., where the Prophet also says, When thou shouldest even wash thy self with Neter, & useth there TOO MUCH SOAP & c. This then unknown Matter (which then is much too often plainly Named) united with a SULPHUR EMBRIONUM, or with and in such a SULPHUREOUS matter dissolved & again united through the FIRE of Nature. And fixed into a sulphureous Red Powder, is that which a True MAGO CABBALIST & THEOSOPHIUS may bring to pass & by the same may be accomplished, what they already know. This is the greatest Secret of the whole Medium, that cures all diseases & upholds Mankind, till to the appointed time & End: But so soon as this fixed Red Powder, on the Stone of the Wise is fermented with GOLD, it is no more a Medium. It is indeed SOL POTABILE in a certain degree, & easily dissolves in all Liguons. But after it is wholly Boiled it is a FIRE that flesh can't bare, but servicable to other firm or fast Bodies. But of its Circumstantial preparation with all the different necessary Manuals to give here a process thereof, we cannot, then the same is so short that the same is mentioned in the S. 8., in the beginning thereof & wholly comprehended.

S. 10. It might not be improper here to treat a little of those who are in the Roads on errors, & think that the Metallick GOLD with its SALT, (understand this right) as the most fixed & durable in the FIRE, the same of course must be the subject for the true high AURUM POTABILE; yea to their very stone of the Wise. But how far they have shot from the Mark, is too open & Manifest, firstly the GOLD is drove through the Violence of this Earthly FIRE from his Matrice or Minera, and thereby robbed of the Universal MERCURY, and is beyond dispute; then this could not be held & made durable but through its own FIRE. And this is impossible for the Compound GOLD, without that WATER which was its origin, when it was still ONE IN THREEFOLD, to bring on reduce the same to its first form or propertie: Then the GOLD through

this Wonder WATER must HAVE REPLACED, THAT WHICH WAS DRIVEN AWAY BY THE EARTHLY FIRE, & therefore without this, 'tis impossible to reduce this GOLD to its first form on Matter. Then all the Alchemical MENSTRUES are not capable nor able to give the same (the GOLD) that which it has lost in the foregoing treatment. BUT BEFORE THE GOLD IS BECOME CORPOREAL through the Elemental destroying FIRE, and is still an Embryon, it may by the skillful Hand of an Artist, as said above, & with the true SOLVENT be made or brought much easier to an incomparable SOL POTABILE.

S. 11. The corporeal GOLD, when even Reduced to the most minute particles, without any corrosiveness, is serviceable in many heavy Complaints, as all true Physicians know, particularly the Cholerick, sulphureous, arsenical & alcalish complaints, as also the same prepared SILVER in all those complaints, whose Origin is SALINE, TARTARI, phlegmatic & such like, by which we have still said, that when the SUNS Rays Penetrates a certain WATER, the said WATER is brought so far, that it fundamentally cures the piles & Fistulas, & in this preparation the GOLD loses only a little of its weight. Then Heat & Cold is the cause of all complaints & sicknesses of our whole Life; namely, cholera & phlegma & who regards truly these PRINCIPIA, will not be unsuccessful in his cures. But how Gold and silver may be dissolved without any corrosive, that it is not to be brought Back again; the poor slop-Cooks perhaps might want to know. This we will then truly Reveal to him, without a sublime style or any reserve, quite plain, firstly, I tell you, that your Wonderful & unheard of Agents & furnaces, with your Distilling Worms and things, as Retorts, Boltheads, Phials, Pelicans & Philosophical Eggs & how these foolish things may be further called, much less will you have occasion for your uncommon prepared salts; and Hellish strong Waters. A WOODEN FURNACE (don't look upon this as if it would not warm FEW COALS, a GLASS BODY WITH A HELM & RECEIVERS, WHICH IS EVEN NOT SO HIGHLY NECESSARY, & COMMON WELL OR SPRING OR RIVER WATER, BUT RAIN OR SHOW WATER IS BETTER, BUT OUR MERCURIAL WATER STILL BETTER, with a pound or more of Philosophical patience, & these things you have need of & nothing else & when you have then those things together, take GOLD or silver highly subtilized & pour upon or wet the same with all diligence and care in your Furnace, till it is wholly dissolved, then draw the Menstruum with the softest degree of FIRE from the same, so will your Metals remain on the ground or in the glass in the form of a Gum, or as an agate stone. This dissolves in all Liquids, & is truly not the least secret in medicine, according as it shall be prepared thereto. What further is to be done with it in the secret Philosophii: Those individuals well know, which has occasion for a SALT, SULPHUR & MERCURY which father has only one rise & source: God is our Witness that we have here wrote a full & perfect account, comprehensible & intelligible, & have used no manner or riddle, this is farther to be

mentioned that the SOL on LUNA Potabile may be made by any Body, Old or Young, Man, Woman or Child, without all Learning or experience; with the addition, that the most clumsy Booty is fittest for this Wonderful subtil preparation, nay the properest, capablist & fittest.

S. 12. In the foregoing 10. & 11., S., we have to oblige these who would chuse the SOL & LUNA Potabile without trouble & cost, & have slipped a little out of our way. But now will follow the way we was in before. The Reader will remind himself, that with the 9. S., the description of this high SOL POTABILE was ended & shall not remind the original particular much more of the same, but how this SOL the Red Dust APHOR is boiled through the degrees by the FIRE of Nature? And is a higher Question: But, who does diligently consider how the Sun casts her seed in the EARTH, & by the gentle warmth of the Spring first swells the same, then makes the same sprout in the form of grass; farther draws the same up with a greater heat to be a hard stalk, thirdly the flowers, & in the same way awakens the seed, fourthly & lastly, how the seed is ripened & hardened by the last degree, to its infinite Increase. The same we say, has Learnt enough, & will shew the timely preparation of this Red Dust Aphor to perfection. And the Lovers hereof must LEARN HIS DEGREES SIMPLY FROM THE COURSE OF NATURE & ALSO HE MUST LEARN FROM THE SAME HIS FIRE & FURNACE. But to say more, is truly impossible, then this, is more than too plain.

13. S. The foregoing above mentioned over Earthly SULPHUR and Balsam of Life has others as well as the abovementioned properties & Virtues, in the Human and animal Kingdom are unnumbered & past description. We have already said in the first part of SALT, that when this our Region of AIR, through the orderly seasons of the Year, Tempests or other accidents, as the Starry Influences or other hindrances God may appoint, shall be withheld from this Heavenly Balsam of Life or not be properly Impregnated therewith, then ensues all sorts of monstrous growths (or not normal) and Universal epidemical diseases: But on the other Hand, when this our AIR region is impregnated & filled with the Godly Wonder Blessing, there is not only extraordinary healthy pleasant & agreeable seasons, but also a particular thriving in all things that grow. The Truth here asserted, may be shown by a Manual with NITRE: Then when this is prepared to a magnet, and applied to all Vegetables without exception, the same occasions an astonishing Increase in the same: Take notice, we speak not altogether of the Saltpetre, sold in the shops, but of that NITRE, which Jeremiah calls NETER, it is a sulphureous ALCALI; which properly each magnet must have, although the same may be of different sorts, then Iron & the Load Stone gives also such a Magnet, as also the states of JUPITER, Gripe, and such like, though each must have in general, the properties of a SULPHUREOUS alcali in & on it self, also is the TRULY

PREPARED URINE A WONDER MAGNET, MAN, (THE LITTLE WORLD) (understand this right) as the CONCENTRI of the whole Universe, exceeds in power all comprehension. Its preparation is wonderful, then the same must BE UNITED IN A DOUBLE PROPORTION, BOTH IN QUANTITY & QUALITY, WITH THE GREAT WORLD THROUGH THE MOST SIMPLE WAY OF NATURE, and must be also that, what we have said, the four steps or degrees of its preparation, requires each time, a measure of 45 degrees: Then as the warmth of this Natural Wonder furnace ascends, even so, must it also descend, as then the Minera of this Magnet is prepared. Art thou now a true Separating Artist, on in the separation, so thou shall prepare this Magnet truly very easily. It is enough.

S. 14. But to return again to the Increasing of the Plants & Vegetables through the universal Balsam of Life know, that the same may be brought to bare two ways, firstly, that the Earth, in which you sow, may be prepared through this Magnet, to attract or draw to itself the Wonder SULPHUR; secondly that all seed without exception may be soaked in the dissolved Magnet, a proper time. And then accordingly to the experience of the Gardener, may be sown or planted. Observe, the dissolving of this universal Magnet must be done, in that well known to all the World, sourish WATER, whose sourness is occasioned by the aforementioned Sour Volatile Alcali in proper proportion of the Magnet, to the just mentioned WATER; & while this water is known to the Children, the naming it would be superfluous. But here this is to be observed, that this similitude & the above WATER, like many of our discourses points to something higher: Read & diligently read, so will the same give much enlightening. Concerning the seed, as was spoken of above with its preparation, which brings an extraordinary increase. As a Barley Corn which we sowed in a Sand-Stone, otherwise dug with a Pointed Iron bar, and moistened the hole with the above Liquor in the same manner, brought forth 40 odd stalks whose Ears were large & full of grain, and came timely & Ripe, which was seen by many of which, many are still alive, with astonishment, without mentioning other particular friends, to whom we imparted something of this Secret & what they thereby accomplished; there are many which alcalize NITER with Coals for this purpose, but which has not always the desired End, then Firstly, they know not the difference between the NITRES: 2. They miss by not knowing the true Salis Petra (Stone SALT): 3. Although this is generated through on by the sowering WATER, is so common & so well known, yet they understand not the same, nor the Reason of its Fermentation less; & therefore the true preparation of this Magnet is so scarce & almost wholly unknown, & therefore the right Increase of these Earthly plants so seldom answers their expectations. Therefore learn with all diligence to know the true, SAL PETRA, the true Stone Salt, in which there is, according to their qualities a great difference, as also learn the right sower fermentative WATER, which must be

alcalish & sulphureous, as for the rest the Art is easy, compare herewith diligently, what is said in Chap. 1. S. 32., and elsewhere is said, & this shall suffice for the Vegetables, till opportunity may furnish us with something further.

S. 15. Before in the S. 13., we mentioned, that this Wonder SULPHUR is also highly necessary for the Growth & increase of the Minerals, & this is known to all true Naturalists & those experienced, knows well enough, as the Metals & Minerals, Stones & Earth all shew themselves, which is already shown in the first part of SALT, where the Origin of Metals & Minerals is treated of. But so soon as this magnetical power is robbed or taken from them & can't attract this Wonder SULPHUR, so ceases this growth & Increase, & not only that but they die & return back again. But an artist may help this decayed One, & enable the same by its strength to increase again: But of this there may be indeed a tract found, here & there amongst those authors of Mineralogy or of Mining, but very seldom according to the ground of Nature while these people did not learn themselves much about higher things or the first beginning of Nature, or, although they may imagine they are in the right way, so are they often a few clowns steps from the same, as their daily Practice declares the same. But did but these good gentry but understand fundamentally, what was said in the foregoing 13 and 14 S., they would be brought on quite other thoughts, & would prepare their poor ones by certain degrees of FIRE, and the sower alcalish, sulphureous fermenting WATER while assisting them, (which is to be had in overplus in all Mines with little cost & trouble) that the same might in the furnace of Nature be brought to its highest increase & perfection: But as it is not here our intention properly to treat of Mines, so we shall not give here any particular process; but to those, that know to play their hum string, "is here said enough, a similitude we will here introduce of a SATURN and LUNA one, namely, such a one that is rich in SATURN and poor in LUNA, & that is mixed or blended with a VENUS fench or slag. Stamp the same dry, grossly, like unto small beans, and mix with the same, the SALT, which has been here & there taught of, & bring all together into the Furnace, made according to Nature, & give the degree of FIRE according to Nature; namely each time, 29 minutes & 34 seconds; this also prepared One, leave to the course of Nature in her Furnace, & MOISTEN IT AS IT SHALL HAVE OCCASION, WITH THE ABOVE MENTIONED WATER, TILL YOU HAVE OBTAINED YOUR POINT. And truly you will be not a little astonished at its ripening & Increasing. But take notice, that your Furnace according to Nature, is secured from the inclemency of the Weathers Tempests & Thunders, but the Influences or shining of the stars will not hurt it, as also Snow & Rain WATER; therefore understand us right, then we don't speak here exactly, but what we have said is truth, & will never fail thee, and particularly if you know to give in the Melting the proper Blast. But know

that such work must be so regulated, that you need not wait from time to time for its maturation. But when once properly regulated, you may remain constantly by the Melting of the same. If this serves thee for Instruction & veration, so turn with this Knowledge to a Mountain Work on Mine, so will you experience both in the highest degree; then the envy, hatred, grudge & old constituted customs used by these people are so little to be altered, as by Satan Himself.

S. 16. What this Wonder SULPHUR performs by the Metals & Minerals, is already said above, and that by the same all Metals & Minerals may be prepared to a Wonder Medium, for this or that disorder, as the experienced Physician knows well, & to give of each here a Rx. is not at all necessary, & which would be taken much amiss of us, from those well meaning People whose Profession, it is. What the OIL of SATURN can perform, we have experienced in ourselves, namely, on a FISTULA, which we have dragged upon us more then 19 years, & not spent a little in that time, till we had opportunity to prepare the above mentioned OIL, when this dangerous & exceeding troublesome disease was in two days brought so far, that it healed in five days perfectly, and not to the little astonishment of experienced Surgeons. What the Anserick or Auni pigment through this SULPHUR and its own MERCURIAL WATER performs in old Cancers & such like spreading things, is not to be believed, and those don't hit the nail, namely, those that believe that who has the said SULPHUR in its own MERCURIAL SALT WATER, needs no preparation of metals or minerals for this or that disease: But these are truly far from the Mark, or are much mistaken! The Almighty God has Created nothing in Vain. But that each created being should have its particular Use. We see already how the cunning ones do pricking their Ears to hit at us in our words: But their designs shall be frustrated: They will say; to what then is this so much & high tinged SOL Potabile which is said to cure all diseases fundamentally, let them be called as they will? This was well aimed, but badly hit. We must with permission first ask a question, namely, what is understood hereof of SOL? The metallick or the Mineral? Otherwise one is terribly mistaken; then one must know that all Metals & Minerals have gold in them according to the properties of its specification, as also all other thing of the creation in the other two Kingdoms, although under the name of SOL POTABILE, as there are in general comprehended. Yet there is amongst the same an amazing difference, & who knows not this, has made but small progress in the Secrets of Nature, therefore each SOL POTABILE serves not for all in general or particular. But each has its particular and Specific propertie for this or that disease in PARTICULAR, & then it is Universal for all Mankind, namely for such diseases, & in this sense is said that the SOL POTABILE is a universal medium, namely, so far as the true SOL (understand this right) is by the Almighty God separated, in all Metals & Minerals,

& has according to their several properties therein SPECIFICS. Then as impossible as it is to find among Stones many Millions of them on the Earth, two which has the EARTHLY mixture or Temperament in equal & perfect concordance or Weight, even so impossible is it, for one amongst this unnumbered universe of Mankind & their various complexions or mixtures, (without this high & Wonder secret of which we have in the foregoing S.S., in the Chapter treated of it at large) to find or obtain this Universal, although the Wise may have wrote many 1000, s of pages of paper hereof, & the EMPIRICAL may have cried themselves hoarse in asking of this Secret.

S. 17. In the foregoing S. many will sharpen or point their Pens & Tongues against the same! But this will as little concern us as the Wind now storming on the Great Tartary. Those who know the ground of Nature will herein accord with us, & will applaud those who not only has the foregoing S. in the Theory but the fundamental practice, to say or treat more of this matter is not our profession but belongs to well experienced Physicians: We cannot avoid this observation, that many Physicians have found out this on that Medium, for this on that sickness or grievings which it performs, & eradicates the disordered power and effect. But this has been again observed, that the same Medium, at other times, by other people, has not had the best effect in the same sickness; yea not seldom, has had a contrary deadly effect because they have here found quite another mixture of the Elements, as well in the great as the little World. The Plague which rages here and there in different parts of the World, has fully confirmed this, then what has here at one time has been highly serviceable, has at another time not performed the least service: Why so? Because, the Air & the Human Bodies, through the Elementary mixture is found quite different.

S. 18. This therefore remains fast; that He who truly knows the Ground of Nature, & knows the over Earthly HEAVENLY SULPHUR OR BALSAM OF LIFE, WHICH CARRIES BY ITSELF ITS OWN SALTISH MERCURIAL WATER FOR ITS DISSOLUTION, OR DISSOLVING, & KNOWS HOW TO OBTAIN IT, HE MAY BOAST, THE PREPARATION OF THE UNIVERSAL SOL POTABILE & OF CONSEQUENCE CAN OBTAIN OR PREPARE THIS UNIVERSAL, FROM ALL OTHER THINGS OF THE CREATION. In the Intrin, we will not have any disparagement or Physick Spirits, Oils, Tinctures, SALTS with all other praiseworthy Medicines & amongst the Thirty will give them their deserving praise. But then amongst those we can't name Three, which the Lustful David dipt (namely the Water) under the gate of Bethleham.

S. 19. By this matter we have still to mention, that the SOL POTABILE although is in itself but one Matter, but yet ACCIDENTLY TWO, namely Red & White, SOLAR and LUNAR, Male & Female, to the first belongs GOLD, IRON, COPPER and MERCURY SOLAR, to the other belongs SILVER, TIN, SATURN, MERCURY LUNAR; as also all those Beasts & Plants attributed to them. But to treat of this in particular is not our intention

but belongs to Learned Physicians: Yet we will compare against this the foregoing 16 & 17 S., with all diligence, the 11 S., from the beginning till near the Middle.

S. 20. We have tis' true yet much to say of this SULPHUR but we are afraid that the Reader will think us too prolix & of consequence, we shall be burthensome to him & therefore will recommend to him the Fig. 6 & 10 Chap. 1., to inspect the same as the Spiritual & Corporeal Nature with all diligence, on which He will have enough to Study till He has perfectly Learnt this Wonder Alphabet.

S. 21. But let no one be offended, if the above mentioned fig. 6., and that part of SALT, namely the first part, seems to be contrary to each other, then it is not in the least, then a true Mago Cabbalist & Godly person knows, that there is not one jot contrary to the other. In the other part we have placed before the Lovers hereof a sketch which takes to the matter, which we there intendingly would treat of & thus for their sakes for the present Matter, & therefore He who would rightly understand this, must not look upon the same as something indifferent on a bare sketch or draft, but inspect this with the highest diligence, so will He then find the partings on separations of the Upper Worlds, the Upper Heavenly Spirit & Angelick Hosts, will better comprehend the different states of the Heavenly in Eternity.

S. 22. The Angel said to the prophet Daniel, And many of them that sleep in the dust of the Earth shall awake, some to everlasting Life, some to everlasting shame and contempt. Chap. 12. 2. The Teachers shall or will shine as the brightness of the expansion or firmament, and they that turn many to righteousness, as the Stars for ever & ever. Math. 13. 43. Then shall the righteous shine forth as the Sun, in the Kingdom of their Father & c., that the Righteousness shall shine in the other world the Holy scriptures testifie, and in many more places, as also that there is a difference of this Light, glance & Glorification, therefore Christ the Lord said, John 14. 2. In My Fathers house are many Mansions, if it were not so I would have told you. I go to prepare a place for you & such like more, through the different Mansions our Saviour points to the above mentioned different degrees of Glory; at the same time, therefore the Angel said to Daniel, that the teachers would shine as the glory of the firmament. And those who have brought many to righteousness, as the Stars & c. Here is already shown a great difference & herein all true Pious Learned Godly People agrees, this then is first decreed, and we must again desire the friendly Reader to look back to the 37 S., of this part Chap. 1., and by a strict remembrance of the same, he will be better enabled to understand us in the following.

S. 23. In the foregoing S., we have said that the inward man is formed like unto the heavenly Adam, with Angelick form & Properties or qualities, Yea that the Spiritual Man, more then that has a Spirit which was immediately blown into him by God, out

of or from the quality or Nature of the High Spirits above all Worlds, and Man is also composed out of all other sensible Creatures; by the Wisdom of God, Man is also composed or set together out of all Worlds, in the most astonishing manner, therefore the Happy Man will be alone a dweller of all those Worlds, (of which also the Cp. v. Psalm 8 points although St. Paul, Heb. 2. 5. 6., may be thought to be meaning or pointing alone to Christ).

S. Before we wholly leave this Matter, we must a little remind, the Jewish casting out of Devils, by Natural things, as Josephus mentions in his transactions of the Jews, and others of their Writings, & by their Traditions may be known. If these are all True? We leave them to demonstrate & prove: But this although is manifest by the Holy Scriptures as also by a true knowledge of Nature in Light & Darkness, undeniable that the Devil in & on or for himself may not be drove out of the possessed or a Country, by Natural Elementary things; although the Witchcraft may be used by Natural things, & Magically bring or hang the same on the Necromancers Neck & yet the Devil decides in & on himself as an Arch Physico & knower of Natural things, all this alledged, then tis' impossible for the Principle of Darkness to drive away its darkness, otherwise it was not necessary, for the manifestation of the Source of Light Jesus Christ to destroy or drive away the Works of the Devil, but the true beginning must be from the true Light of which our whole work treats of, prepared to the true SULPHUR Balsam, & then rightly applied, this is then in the highest disagreeable to those hellish dark Spirits of which we will say no more. Then firstly NO MAN WHO HAS FORGOT GOD OR THE WICKED CAN POSSIBLY PREPARE THIS, which is known only to the true Wise high & Wonder Medium, Which Satan is so much against, & despises & THE SAME IS A RAY OF THE EVERLASTING LIGHT AND BECAUSE THE SAME CAN BE ONLY PARTAKEN & PREPARED OF THOSE WHICH ARE PIOUS & IN A TRUE GODLY RESIGNATION, AND SUCH A ONE WITHOUT DOUBT WILL BY ITS APPLICATION CALL UPON THE NAME OF JESUS by those which are possessed & by this Method the Devil must withdraw himself; other Virtues are also known to us of this over Earthly & Heavenly SULPHUR, Namely that this or that Metal prepared through the same, & without this Sprig or twig in the Natural as well as Spiritual Magic neither through cast or wrote Sigilla Pentaura or Talismata. There cannot be wrought the Least, as the daily experience shews from those deceivers of Country People, & this may serve them for information which makes the seals of Theophrastus Paracelsus & other wrote Seals, to deceive the Believer. To these then belongs in this Preparation two ways; the one we have already Mentioned, the other is holy & only Spiritual, and for this time this shall be enough said, the remaining shall be spared for the 3rd. part, & may be sought for in the Chapter of Astrology & Magick, in the Chap. of Astrology, but thereof may be seen the great foolishness of those Star Readers, which

in the Radix of a Nativity makes such terrible Mistakes & scarce in a hundred times in this on that point hit the mark but blindly guesses as a blind man of Colours, with which this Chapter shall be concluded.

THE THIRD CHAPTER.

OF THE NATURE AND ADVANTAGE AND USE OF THE EARTHLY SULPHUR.

S. 1. In the beginning of the foregoing Chapter we have said already that we will not infringe in this Work, on the Womens Brimstone Fabrick: But this our undertaking points to something more advantageous in this as well as in the foregoing. How the Elementary sulphur has its origin or source? Is plain enough demonstrated in the first Chapter & what is there wanting must be sought in the first part of Salt. Its inward properties are other, than the SULPHUR of Light as hid in this Earthly, even as our Soul & Spirit are in this Earthly Body. Then as we said above Chap. 1. S. 8., that there is nothing under Heaven in this Elementary Creation in which this AEsch Majim is not to be found as its Soul, & without the same a thing is likened to the everlasting death & have a form like unto Satan. This Spirit or way is in this so shut up & Bolted, that it is almost impossible to bring the same out, or make it manifest, EXCEPT TIS' WITH THE ABOVE MENTIONED SOLVENT: But as this Noble Seed of SOL is much better drawn, & had from other Bodies, as is shewn in the foregoing Chapter; & more abundantly & better is to be had, then in this Earthly Sulphur, so we will LET THIS GROSS SULPHUR FOR THE SAME REASON ALONE.

S. 2. We have said Chap. 1. & S. 7, that this earthly SULPHUR may not be withheld from any individual thing of all the three Kingdoms, not that it is Their Balsam of Life, but otherwise the cement, by which its Elemental mixt Body is bound & held together, as the common Spirits Distillers know. Then when one distills an animal or Vegetable (to a Mineral is required another Knowledge) proportion, so is observed a Phlegma, a Spirit, & a Volatile SALT, till the so called stinking oil comes over, as the SULPHUREOUS Substance, as then is the whole Corporeal Body separated or divided,

& nothing remains but a powdery ashes, without being in the least bound together, in which is the fixt SALT as the inward hidden body, which no FIRE can destroy, but may further clarify & Exalt it.

S. 3. The foregoing last words, are not altogether wrote after the common chymical way of writing, perhaps it will give us an opportunity to speak something more of it, return then again to the EARTHLY SULPHUR, and its Nature; because the same is from (or out of) the dark Elementary FIRE & composed or set together of A GROSS SALTISH MERCURIAL WATER, AND IS IN ITS SUBSTANCE A SLIMY PITCHY FAT MATTER: But because this its concentrated FIRE is the greatest Part of its substance, the same must be then of a drying Nature, therefore the common salve prepares it, mixes it with their salves for the Itch & such eruptions, not regarding what damage its soune FIRE causes to the Balsam of our Flesh, & it is still more dangerous to be used Inwardly, except indeed the greatest precaution is observed, & particularly of the Patient has damage in his Inward parts, then in such an example its destroying power would soon manifest itself, of which many examples might here be given if occasion required it: But where the ALCALI has alone the upper hand, the same may be used, provided the artist has cleared the same from its ARSENICAL properties: But how this its preparation is rightly to be done, this suits not here to relate. What the common chymical Books teaches is here of no use. Who knows how to help it in its sublimation with a fixed SULPHUR, may perform therewith some good, & so much of the Nature of common SULPHUR.

S. 4. Although this earthly SULPHUR does not perform by Mankind in general Inwardly or outwardly much good, yet has the almighty God Created the same for unnumbered other uses. Experienced Melters know what advantages the slates or crust (which is nothing but a SULPHUR) brings in general in the Furnace by SULPHUR AS ALSO THROUGH A PURE UNMETALLIC STONE, SLATE OR CRUST, all Metals, yea SOL itself may be reduced & brought back to a Metallick Stone, as also all Metallick Ones: But how this Metallic stone could be used with the highest advantages, we could fill a whole Book thereof. Who knows the true fermenting sour WATER, whose colour is Yellow, may easily be brought in the right way. The more this is impregnated with the first METALLIC PROPERTIE, the more the metal will be able to perform with this Stone in its Graduation & Increase. But such a one must be well versed in all the workings of Nature, as heat & both moist & dry, that he may not lay hold of the false instead of the true Way; as also he must be well acquainted with THE DIFFERENCE OF TIMES, as also that He regulates the FIRE and HEARTH and FURNACE ACCORDING TO NATURE as then the Artist will learn & see with the highest satisfaction what this common SULPHUR is able to perform.

S. 5. That this SULPHUR is found in different stages, the Miners Boys knows, its first stage or degree, is such as is used in the Kitchen for Lighting & for making of

Gunpowder and Fireworks, its other stage or degree is its REALGARIS, yet that the one more or less is hardened through SALT & MERCURY, Auripigment & the RED ARSENICUM have their several advantages, as well by the trades or handicrafts as also in the FIRE work, then when the same with other additions is boiled to a Ruby red stone, a true artist may perform something in particularly on LUNA. But he must know for this preparation which to get or take proper Vessels, as also the true boiling must be known to him, or else truly he will not be brought into little damage; to write here a process of this, would not mix very well with our intentions.

S. 6. The Auripigment or red Arsenick, melted with a certain saltish thing to a stone, & then united again with the mineral stone of SOL & LUNA, & then cemented in the fermenting WATER will shew its increase with the highest satisfaction. But this Work in general requires much time. We counsel no unhandy one this undertaking (in particular if the true preparation of the Mineral Stone is unknown to him) or advise him to undertake this Work. We could distribute to the Lovers hereof something of this incomparable Knowledge, if it would altogether suit here, & had we not Reason to fear an ungrateful & perhaps scoff & Ridicule from those envious people, otherwise this properly belongs to Metalolgy & which is not our intention here to treat of.

S. 7. What the SULPHUR of ANTIMONY performs in the purification of SOL, is known to the Gold Smiths Boys. But the matter mentioned in the foregoing Chap. II. AESCH STRENGTHENED THROUGH SAMECH, performs equally the Same & much quicker. But if the SOL has other impurities or contains LUNA, this SULPHUR POSA must be added, and the work will be presently DONE, & the SOL will be highly graduated, but to write here all the Manuals of those things would be an unnecessary Prolixity, the SULPHUR of ANTIMONY is not only a purifyer of the SOL but also of the human Body: But every one is faithfully & truly warned against the ANTIMONY Tinctures prepared by the common Laborants, & all such like rank Nostrums, if he regards his health and Life. There is an easy way known to us, to dissolve the SULPHUR of ANTIMONY into a red Colour, by a glass Retort, & drive the same over in the form of a red Tincture which is both in taste & Smell agreeable; that this may be a Noble Medicine no one will gain-say. By only Extraction of Spiritus Vini we also know a way to prepare from ANTIMONY an uncommon lovely Tincture Red as Blood.

S. 8. What this SULPHUR performs by all Vegetables to their Increase, when a certain thing called CALAXA is therewith SULPHURIZED, (of which we have already above mentioned) is scarce credible. But this preparation must be well understood, otherwise one will mightily miss the point. Above we have said, it must be a SULPHUREOUS ALCALI; that has this magnetical propertie, concerning which a Lover may look back & then He will better understand this. The SULPHUR (but understand this right) may

be also prepared, that it may be a Magnetical Plaster particularly in Poisonous Complaints, for which it will serve incomparably. But take notice; THAT IT IS ALMOST THE COMMON, & YET IS NOT THE COMMON, the above mentioned red stone is the true magnetical SULPHUR capable of performing this. What the common Mountebanks & Laborators prepare of the same for Medicine is openly but too much known, & it would be better if these Health Spoilers profession was wholly taken from them, & then many a person might be helped, which otherwise by these hangmans Medicines are either wholly taken from them, & then many a person might be helped, which otherwise by these hangmans Medicines are either wholly sent into the other world, or also so spoiled, that it excites ones Pity! And we have known such a Dr. Antichrist, who of a tolerable brave Man, made a blind one, as blind as a stick, instead that Christ the Lord, made the blind to See.

S. 9. That from the SULPHUR common, there is prepared by the Bell a so called Oil & Spirit? Is no secret. But that this Spirit as a high destroying, gnawing matter, and on no use, or of very little use, without doubt is by this time known to the foolish GOLD boilers, & also of their foolish Graduating WATER, BECAUSE IN THE COMMON SULPHUR THE SEED OF THE PHILOSOPHICAL SOL IS THEREIN TOO MUCH LOCKED UP, & MAY BE THEREFORE QUITE ANOTHER THING OF WHICH THOSE POOR GOLD SPOILERS SHOULD PREPARE THEIR GRADUATING WATER, THAT SO THEY MIGHT LEARN SOMETHING IN PARTICULARS, to quicken again their Hungered & with coal dust and damp consumptive Bodies. Tis' true the common SULPHUR has herein also some power of assisting: But who knows not to unite a raw MERCURY fixt in the first degree, with the SULPHUR of SATURN & wisely to apply the same on LUNA, will skim little fat from this soap, of which preparation we have already spoke of somewhere else, & through this very way may a skillful artist through the secret cementation, obtain not small profit. But take notice the same is not to be done in crucibles, cementing pots & c., much less in your foolish Wonderful Furnaces. Trustable Inclinations which are not inclined to cheat & deceive, we will communicate to them the true species of Cementation, and will easily be understood by those Chymists following Nature, yet we remind, that the whole is not to be used at once, but according as the nature of the Matter requires: A Rx. would sui our Intentions very indifferent: The species follows, SALT, NITRE, VITRIOL, ⊕ SAL AMMONIACK, TARTAR, these prepared according to the art & fixed are very serviceable; their Acidum is hurtful in the highest. The TARTAR must be exalted, and the Vitriol must be washed in its own WATER and AD RUB brought back. Further you must have the fixed oils of SALTS, as also of ANTIMONY, MARS, VENUS, but without all connoisives, & prepared THROUGH A MENSTRUUM WHICH IS COMMON & KNOWN TO ALL THE WORLD, and lastly & particularly that prepared thing of which Chap. III. S. 1., mentions; has the

Artist now all these things by Hand, so may he be assured, that He will perform in the cementation Wonders; but as is said, He must know the true art of cementation, not in Crucibles or boxes, as also the Metal which shall be cemented. Who has rightly understood, what we have said of these Species till here, will not throw away his trouble & Costs. But we are afraid, that we have not, for the generality wrote plain enough, yet we are assured, that we have spoken the truth & that in an abundant Manner.

S. 10. Above in the 4th. S., we have a little noticed, how the (thiefs) or slate (as SULPHUR fixed in the first degree) has its advantages in the Meltings, & which may be also performed with the common SULPHUR, then regarding its SALTISH MERCURIAL SUBSTANCE in the FIRE which dissolves all Metals without exception, & separates the same in the most minute particles, like unto aqua fortis or AQUA REGIA and the daily experience learns that the very SOL is not safe from its fumes & Gnawing Spirit: But even then He who then by the Melting knows not the proper ADDITION, FIRE, HEARTH, & all the Manuals & that MARS, COPPER & SULPHUR properly cemented, & the Usual way of great Melting daily observed, it gives an uncommon advantage, & is not as yet known everywhere. This work suits only for the poor ones. The Lovers hereof may make a trial of this Cementing, COPPER, MARS AND ANTIMONY and the LUNA IN A PROPER PROPORTION, in a crucible & covered with NITRE & kept in the FIRE a few Hours according to the Art, & will be seen to admiration, though He must know THE TRUE REDUCTION IN MELTING otherwise his LUNA will have damage; what this SULPHUR occasions farther in or by the ones in the roasting & Melting is enough explained of in all miners-works, therefore for this Reason they are by their ones which are very scaly & SULPHUREOUS before the melting, every way of Roasting. But the damage that is done by this Roasting in many places, the poor working people feel the most, did but these good People know to distinguish this SULPHUR in its one (namely how or what properties it has, & if it has much of the Raw & in the first degree fixt MERCURY, or otherwise what sort of a REALGAR hangs to it?) they would verily regulate their Roasting & bunning in another sort of a manner, & not send the greatest part of the Metal both in roasting & melting with the REALGARI SULPHUR into the Air. Tis' true we find in some of those Mine ant writings, as also in part by the Miners how this & that must be put to the ones, to weaken the above mentioned destroying Spirits, & with the same fix it. But while the same has not always the desired effect, one thinks no further of it, & follows the old Way, & fiddles the old tune perpetually. How comes this? Tho. good People Practice these & such like works according to their Ignorant Mechanical way, or according to the custom of the same calling. But did they but understand & better know the ways of Nature, they would follow her more in their stamping, Roast-

ing & Melting & of consequence reap a much greater advantage then what they do. Take only an example in the common SULPHUR & MERCURY & how the same is melted together & then after SUBLIMATED, and gives a fine Cinnabar, & this by the Chymists is called MERCURY bound with SULPHUR. But we ask; is the MERCURY bound through the SULPHUR or this through the other? In truth good folks you err. Then we will demonstrate through the principle of SULPHUR to you, that MERCURY is that only thing which binds the SULPHUR; then you can't gain-say, that the burning properties of SULPHUR (it is then that it is wholly held & destroyed) is by nothing to be taken away, you may begin it as foolish as you will, whether by SUBLIMATION or distillation, or has the foolish ways are otherwise called. Yet will its burning properties still remain. But when the same is made with MERCURY to a Cinnabar, so is its burning properties already without killing & destroying is mostly taken away as the Cinnabar openly manifests, therefore you must not call for want of knowing better, Black, White & White Black. All that lights, casts its rays from it, it may either have the Light from it self, or borrowed. Gen. 1. 16. The Moon is called a Light, but with this proviso, the less; the Astronomers pretend to say, the Moon has no Light, but what he receives from the Sun. And therefore the Holy Text is only to be so far understood, Namely, so far as the Moon receives her Light from the Sun. But the Holy writ says without exception, in clear and intelligible words: And God made the two Great Lights. The great Light to rule the day, and the lesser to rule the Night, as also the Stars, & c The Moon should be also the light to rule the night, the Holy Scriptures is truth, and don't use such Magnifying ways of speaking, the Moon may be observed through a Telescope as it will. Then though when the Sun shines clearly at noon day, and a small Wax taper was lighted and placed 2 or 3000 paces from one, it would be impossible to observe its light, if even one was to look at the same through a good Glass, but yet it is truth that the same burns & is a Light, even so is it with regard to the Moon which is a light, not regarding that the star observers do not observe the same as such, & which may not be denied that she may not receive her clear Increasing and decreasing Lights from the sun. As the middle point of all Light, known to us except the Heavenly Light, & by that means her own Light may be darkened & kept under. But perhaps a double sighted Willie may make this demonstration and say: That Had the Moon her Own Light, such must be observed on that part on which the sun does not shin at a time when the day light is of no kind of assistance, tis' true this Remark is not so trivial & particularly when once experience has been grounded on observations through a Telescope. But how far the same may be relied on, is not our place or intention to examine. But refer ourselves again to the Holy scriptures, and to that already said hereof above, & this is known to all the World that can see, that when

the Moon is a New Moon and by clear Weather, her whole Body and circumference may be seen in a dankish Reddish Fiery colour. And that the Moons Body may not be always seen in the same, is occasioned by its increasing & the strong Light the SOL reflects on Her and remain also fast on what the Holy Scriptures says, that the LUNA in and on it self is a Light, (namely, weak and dankish) 1. Cor. v. 25. Another Glory has the Sun, another glory has the MOON and another glory have the Stars, then one.....

S. 10., 11., 12., & 13 are missing, we will go on to S. 14. D.H.

S. 14. In the first part of SALT, we have already treated of the Pebble Stones, but are here concerned only to take those into consideration, which are found in abundance in the high Mountains, composed of many 1000 small ones of various colours, and are understood by few. What is found by the Authors here and there we will not regard. Who knows the cause of the compactness of the Earth & how it comes that these Pebbles (although they may have been often taken from a black Earth, becomes through the FIRE of so lovely a Red? He will also know the Reason how so many small pebbles are found together in a gross or coarse sand, & often also in a whitest loamy Earth, and in particular also, how the SULPHUR by MERCURY is coagulated into so high a red? The Soap Boiling Art, shews us, that with an alcali Lye all Fatness (which is fundamentally nothing but SULPHUR) is coagulated together to a hard Soap. These Mechanical demonstrations, should overturn & confute those whimsical PRINCIPIA PHYSICIA, and lead them to the true grounds of Nature. But their Imaginations shews, and particularly those who suppose themselves high Learned, an incurable Error; as we see daily on those foolish People, which through their Imaginations suppose themselves to be this or that Person, and even so, comparatively speaking is it, with the most part of Mankind when once they have laid hold of an Idea. But this trivial, comparison of Soap Boiling, did you but understand has more meaning in it then many may conceive, or did you see to what it is we would point, you would not treat the poor ones in such a way. But would learn their proper precipitation. But here the poor creatures will cry and deride us, saying, or asking where they should get all the SALT and MERCURY for (to follow our way & direction) to help all this SULPHUR in Ones? Hunny not to the pastures, you poor creatures! The Shephard knows best TO LEAD you to the proper pasture & food, then all that is green is not proper for you. There is a great difference (between Minerals); learn Nature, and those SPECIES which she has brought forth, and then you will see & understand to your own & neighbours good and advantage, and to what it does Point.

S. 15. That the embryon. SULPHUR is not easily dissolved by any fluid matter, is almost known to every one; but the same through a Lye that IS HIGHLY SHARPENED WITH LIME, (now you will surely understand of what it is we speak) may be easily & wholly

dissolved to a red Liquor, and as after, with a CERTAIN MENSTRUUM extract from this Liquor, a TINCTURE OR BALSAM, which is not altogether so common: It may be then that the true Lye is known, as also the TRUE MENSTRUUM, which unites in no means with the Lye nor even allows itself to mix therewith; nather indeed tis'easy to prepare this Balsam, and bring the same to THE THICKNESS OF HONEY, and further according to the DEGREES OF NATURE, CEMENT OR BOIL THE SAME with a Volatile LUNA, or otherwise how it may be called according to the gold makers way, one need not have small hopes & Satisfaction from this Work. What will not the above mentioned in the Chap. II. heavenly SULPHUR perform? When a true Artist should thereby proceed according to the plain & simple way of Nature? But take Notice, if you know not how to prepare the above mentioned volatile LUNA well, and after its boiling to make it again corporeal, you will have nothing but loss. Who can perform the Art, let him not betray his Master, that their wrath may not come to contempt. Because this work is in it self mean & trifling, yet some thing great is hid in it. But this work requires a good deal of time and Patience.

S. 16. Had we a desire to make ourselves known by writing of Processes, we would here mention one on SULPHUR, and how the same may be dissolved into a certain oil wholly (but stinks Hellish) then by a certain Lye, draw this oil away again, that all its slimy stinking impurities should remain behind in the same, & farther to draw from this Lye through a Noble Menstruum an Excellent Tincture. But, as already said, Process writing on working Processes is not our intention, to those experienced in the FIRE is already enough said. But to others meaning that they have already smell-ed the Sense, we assure them, that without a faithful conductor they will hardly obtain this thing. Yet it has been called by many Names, but with all it is plainly named, although perhaps not understood by everyone.

S. 17. Before we have said, that the common and in part the SULPHUR ones, is more prejudicial, than serviceable to Man, without a particular Retrogradation and preparation, because of the intolerable & unbearable Stink and corrosive quality & property, unless the same retrograded & prepared. In certain operations of the FIRE, the same may be very serviceable if it is properly Handled, and on the other Hand again very prejudicial, and this in particular so to the LUNA. But if the LUNA IS MADE VOLATILE that is to the nearest degree of MERCURY by a retrogradation, and then further AMALGAMATED with MERCURY AMALGAMA & the SULPHUR and further made to a lovely Cinnabar, will give a Matter which will not produce a small satisfaction, if namely this Cinnabar, is further known to be applyed. This Cinnabar is by the CONVULSIONS & Falling Sickness not to be thought to be incurable. In Summa, the whole Art lays herein, in the Retrogradation & returning of the Matter to its first state; who once has known

on found this Way, will at no time err.

S. 18. Further, that the SULPHUR is almost durable & incorruptable; the Charcoal proves, then that this common Coals has a very fixt SULPHUR, no one well experienced in working will deny, that a wood Coal will neither not in WATER on Earth, every one sees daily before his Eyes, neither does the Air hunt the same, the FIRE only dissolves or releases this SULPHUR, that its pure concealed light, may return again to its first pure beginning, and leaves behind only an Earth in which is the fixed SALT. (Then because the FIRE has drove the MERCURY from the fixt SALT, the coal could not withstand, & remain in its SULPHUREOUS state or form. No gnawing Spirit can hunt a Charcoal: But through a certain highly sharpened Alkali the same may be dissolved to a FIERY red Liquor; what rare & Wonder Worthy things may be further done with this Liquor, serves not this place & work. That the Soot in the Chimney is a SULPHUR, the Children knows. But to what it might serve scarcely the Doctors knows. The right glassy clear Soot, distilled in a SPIR. SALT VALAT. AMMONIACI, but one must rightly know this Spinitum SALT Ammoniaci, then in truth it is not the common, although this Likewise extracts a Blood Red Tincture, from the same, and is also good, extracts a Blood Red Tincture, this truly performed according to Art, or prepared, so is it a Medicine, which cures effectually all Agues, & the beginnings of agonizing dropsies. However easy this preparation may appear, yet be assured of the true Sp. SALT Ammoniaci Vol. is unknown. The Spirit of URINE, it is truly not, and yet it is the same; as also how the Tincture is to be made Volatile, if this is not known the preparation will not be so easy as imagined. What this Chimney soot further performs, as a flighty SULPHUR (as its Lighting property shews) to bind the flighty flying Ones? Is not altogether as yet known. To give here a Receipt would be contrary to our intentions, & shall therefore leave it, because those Miners who dwells by their old customs will scoff and Ridicule, instead of thanking us. But even then it remains true, that this Soot (because it is a SULPHUR is therefore detrimental to the Ones, which may appear a Paradox) And yet performs Wonders by the flighty Ones, the reason hereof, a true experienced Naturalist will easily Comprehend: He that knows not the true PRAXIS with the Soot, let it alone, that instead of receiving advantage you may receive Loss, scandal & derision. The Chimney Soots nearest Relation, performs also all it can by the Volatile Ones: Namely if one knows to help the one as well as the other in its necessary MERCURY propertie. But enough of this, as we are not intending to treat of Meltings. Yet we must not forget, that the common SULPHUR, in a certain way, has a propertie to increase that Copper, namely if one uses, one-quarter VENUS and 1 part SULPHUR, as then that the VENUS with the half of the SULPHUR becomes a Stone, and as after the same has by a true knowledge, become first Black, and the furthermore the

copper itself will plainly demonstrate that the VENUS has from the SULPHUR a visible Increase; this Work may give a Lover a great insight & Intelligence.

S. 19. Above in the 13. S., We have taught of the firing on lighting of the SOL & LUNA: And now in brief shall consider the ANTIMONY, when one lights on fires the same, so does its inflammable SULPHUR with the MERCURY as the causes of its sublimate fly & evaporate, and leaves its golden SULPHUR alone behind; what further may be done with the same (& particular if one knows in the lighting to catch its inflammable SULPHUR & its MERCURY) and what it performs in the FIRE, when united again with the separated Parts, and at after washed by its own ANTIMONY Vinegar. But because this ANTIMONY Vinegar is required, whose preparation is not known to every Body, we will mention no more of it.

S. 20. The ANTIMONY is not only begifted with a Noble SULPHUR, but MARS has also an excellent & already tolerable fixed SULPHUR in which most of his substance is found. His MERCURY is also very little, but of SALT he has something more, this SULPHUR of MARS has excellent properties, not only in Medicine, but in Alchemy. And Many Medicines are prepared from the same, but what a deplorable, dispicable hodge podge is often made of the same, the poor patients to their sorrow experiences: His CROCUS SOLUBILIS and Tincture are the best preparations thereof: Was Medicines our Profession, we could here lay before the Lovers hereof many curious Preparations, the Scriptures says: Let no one meddle in anothers affairs! For which reason we leave the same for those whose Profession is the same. In outward complaints, its sugar sweet Red Balsam (but without any strange foreign addition) is a Wonder; Its Minerale (one) if it is pure & clean, gives the very best Balsam. This MARTIAL SULPHUREOUS Balsam is also prepared to be used inwardly & performs all it can with great Praise. MARS has also still another Wonderful Magnetical property in itself, and from the same there may be prepared a true Wonderful Magnet, but belongs not to this Chapter. In great Forgings & Meltings, the Mineral MARS as also the already made Iron, to many and great advantages and uses, although its proper use is by the melters little known, and for this reason they have more damage than advantage, then when they use MARS to strike the PRECIPITATION (wherein the same, was it used according to the ways of Nature, is a Master) they know not how to separate it from their Stone & to kill it, then the SOL and MARS with regard to this SULPHUR, have too great a Love for each other, therefore without a particular method, the MARS is not to be separated from the SOL; from LUNA this separation without the true Ant is likewise very difficult and not without damage, because the white LUNAR SULPHUR as the Female has so great a desire & Love for the MARTIAL SULPHUR as the Manly: But he that knows the MARS Coctions & Cohobations, and how much He is Inclined to cool his Ludicrous Wanton

heat, with all sorts of Common People. He can easily prepare a Mass for Him, which according to his accustomed Licentiousness, will change him into a Hermaphrodite, whereby he looses his Noble Band: But who does not rightly understand this, let him let the Melting of MARS alone, otherwise He will to his Sorrow scratch his Ears, for the Common SULPHUR is an enemy to MARS. But if to the same, there comes to its help or assistance a SALTISH MERCURIAL matter, His Harness or armour & Valour will not be able to protect Him. To the over desirous Venus he is greatly attacked, and herein he fares worse than Hercules, who to please his beloved, put on a Shirt which she had spun for Him & put on Womens Clothes. But He MARS for Love to Venus transforms himself wholly into her flesh and Blood, so soon as he touches her, and goes with her into her Bath, to sweat with Her rightly. 'Tis' true many suppose they know this Venereal Bath very well, but they know neither the true springs of the same, nor how this Bath is to be prepared; therefore instead of thinking they have thoroughly purified MARS for her Bath, the poor Knight comes out of their Hands all Scabby, Mangy, and greatly deformed. And if one knows not to help Him by the WATER, or through the Universal Mother of all things, in a Yellow form, the good MARS will hereafter be of very little service, or will not detain ourselves longer with this Robber.

S. 21. Haster to Venus, whose substance consists mostly also in SULPHUR; but the same is only superficially for this Reason that it is greatly inclined to the Coition of all Metals, & very easily moved thereto. When the SULPHUR of Venus is united with the SULPHUR of MARS through SATURN, that MARS is also wholly animated & heated by Venus, so is it then, from this union & Conception something particularly expected, as the true Lovers of this Art knows. The Sophisters knows how to chatter a deal of this Union of MARS & VENUS: But what fruit they have produced from this conception, so many have already to their outward damage & Use as the Artists know: Yellow & white, as of arsenical Spirits, Lapis Calaminaris and Arsenic. BUT WHO KNOWS THE ASTRAL CALAMINARIS & ARSENIC: MAY CLOTHE VERY EASILY THE COPPER IN THE MOST DURABLE YELLOW AND WHITE AND BRING THE SAME TO A KINGLY STATE OR MAGNIFICIENCY. What the Mineral or One of VENUS performs by the Roasting & Melting of ones, is worthy of being more regarded than it has been hitherto. The Melters 'tis' true, may use the same, but how often improperly, of which we could say a great deal, was our intentions to treat of such things in particular. Was this Minera right, & at the right time and used by the right subject, one would observe quite another advantage; the old MIST MARK which is used in the Mine works, (and which in general is accidental, if it has the desired effect) does for the most part, more harm than good. And although they see it and handle it with their Hands, yet they will not leave their old foolish traditions & Customs. The SULPHUR of VENUS protects in the FIRE the more noble Metals, instead

of MARS Roasting the same, & which is again another proof of his Warlike disposition & Covetousness & the which is not easily taken from him. It must be then, that the same has been well understood what was said above. The VENUS is very much inclined to SOL & LUNA, and may not very easily be separated from one another, except indeed it is through SATURN, which is very much disposed thereto, the same namely the old smeary black looking SATURN mass is thereto alone capable, to unite the same with MARS; (the discourse is altogether not here of SATURN) if it will be understood, we almost doubt; we say that the SULPHUR of VENUS has already obtained or acquired a certain degree of fixedness, as is manifest, that VENUS in the Melting, nearly withstands the FIRE, and from the same, before all other Metals, may be separated through the true Art of separation the most SOL. Farther, this proves that its degree of fixation, that the same through or from the SATURNIAL MERCURIAL SULPHUR (understand this right) is not as easily reduced to flux, as MARS; and regarding this, its fixation, there is a way known to us, to reduce the same in a very short time, unto the most terrible penetrating present and Incurable Poison, the most minute particle hereof (only to touch a tooth) would cause immediate Death, as has been found in several sorts of works, and this performs what no other Poison does, namely that within 24 hours the same is not only dead, but in a full fermentation, so that the whole Corporeal Mass of the Body is like unto a froth. We have not mentioned this here, for Devilish People to ruminare upon. This Hellish Knowledge, (but are even as sure that they will find the same as difficult as to making GOLD) but have therefore mentioned it, that so we may take notice how highly prejudicial all is in Tinned Copper Hidden Vessels must be to the human constitution & health and how much one ought to avoid the use of such Vessels for boiling & c. But on the other Hand, how Iron Vessels hereto, are not only Innocent, but otherwise wholesome and serviceable; the Reason hereof must be sought for in the different properties of their Salts.

S. 22. As we have spoke a little of the advantages of the SULPHUR of VENUS in the FIRE Workings. We will not consider a little of the inward & outward uses and properties it has with Mankind; and in short shall say, that the VENUS because of its Prickly MERCURIAL SALT, is inwardly every way very dangerous, and each true Artist will know to avoid the use of it. We have said, its prickly MERCURIAL SALT is dangerous, and that is the Reason of its violent power to cause Vomiting, to understand this Plainer, the seeker must turn to the first part of SALT, where the figure of the SALT is copiously handled, and with all diligence, thou must observe, otherwise this will bring him but small satisfaction. This Prickly property which occasions the astringent Bitterness, is in no way to be taken away, unless indeed one ripens the COPPERS untimely Green, and brings the same to a constant fixed Red; we are well assured, that

without the Wonder-Solvens as also at the same time Flegme, of which was spoke above, on that, that is its nearest relation, this cannot be compleated. Who can do this, may indeed boast of it, as a Medicine which cures all Leprosies, Venereal complaints, Itch & c. That it is a Seed, when it is ascended, and laid aside its Green and come to a perfect Ripeness. To which He must not only have SOL, but fitting on proper Earth and WATER; out of Eden (namely from any other place) the WATERS are too unclean, and the Earth too dry; and not so fat as in Eden; therefore, this Earth is called ADAMAH, but the other EREZ, which is to be well observed; and although the Earth on which we now dwell on inhabit, is called in the Holy Scriptures here and there also ADAMAH, yet since the fall of Man it is only comparatively, because Mans Inconruptable Body was taken from the Earth out of Eden. But his conruptable Body from this Earth, wherein he was drove, Gen. III. 23. There is but one River of Eden, who cannot obtain to this universal Head-Spring: Let him seek for one of its off-springs PISON, which moistens the whole Land of Havila, where there is Gold, and the GOLD of that Land is good; and there is found BDELLIUM and the Stone Onyx, and is also manifest, that the true SOL whereof the Wonder Stone Onyx is prepared is only in Eden, whereof see more in Tract III. (Chap. 1 of MERCURY) otherwise called the Stone of the Wise. This SOL must be also (if the stone Onyx is to be made therefrom) added to the true Bdelium, otherwise all trouble will be to no purpose.

S. 23. The Wise speak a great deal of their universal MERCURY, but so Enigmatical and obscure, that a Witty one might even become foolish, ere he could find it out. The one calls on names it so, another again quite different, as also the Third otherwise, and so on to all the rest. Moses names it plainly, namely BDELLIUM; as also where it is wholly and orderly to be had or found? And even then so far knows it: All Mankind that are not bodily Blind sees it, Because, then it is seen by every one, and also since it is so plainly called by its name, What further circumstantial description does it require? But who wants a more minute Intelligence hereof. Must open the great Dictionary and Book of Nature, and amongst  (Sch A M) seek the original Word; so may He at the same time find those individual Words, which branches on comes from them; can't He rightly adjust this original Word, those Branching on deriving therefore will give but little satisfaction. The Ancient Persians calls the same URIM ASTHA. Learn to put these united words or Names together, and Analyze them, so may the 4 head divisions or of branches of the same be easily known, and as then, you will have no occasion that any may make a plainer description or explanation.

S. 24. That the SULPHUR is the cause of all Colours, needs no further demonstration, that ADAM signifies and means Red, is known to every one, that has but the least

knowledge in the Hebrew: Therefore ADAMAH is a Red, that is a SULPHUREOUS Earth, of which the Lord God took therefrom, the Dust (APHOR) and thereof formed Man (Adam). If one takes from this word APHOR the vowel a, and replaces it with the letter i and o, so will not be APHOR, but OPHIR. How precious and costly this Gold of Ophir must have been may be seen in Job, and other places of the Holy Scriptures. Job. xxii. v. 24. "And the Gold of Ophir as the Stones of the Brooks." And this makes no Ennon, that here we call Ophir. But it is in the Hebrew wrote, Aleph and Cholem, then by the Hebrews it was nothing uncustomary to add, and take away Letters: But one must be in this their Mystery, will acquainted & experienced. And then He will understand what Gold, 2 Chron. III. 6., the Gold of PARVAIM was? If one puts away the last syllable Vajlm, and sets an A before the P, as then is it SCHAPP APHAR; Gold dust, from the which may be comprehended, how costly and excellent Man was in Eden, before he became through the List of the Devil, EREX, that is dry Earth, which cannot be separated from Him any other way than through Putrefaction & Conuption (Hebn. MOTH death) and again became (Hebn. Thom?) that is perfection, Namely that His first un-conuptionable APHOR or Gold Dust may become seen & Manifest.

S. 25. Let no one imagine, that that what we have said from the S. 22., till now, is an unnecessary Prelude, or something by which we would only shew ourselves. But otherwise, be assured, that here is not one IOTA wrote, that does not require a serious Reflex, as those true Mago Cabbalists & Godly Leanned know very well. But who cannot understand, Or will not, let them have it unsolved. Then this is work here for the true Lovers of Wisdom. But not for the covetious Money Slaves, that Love nothing but the stinking slime for their Refreshment & Recreation. In the above S. 22., we have said: That who knows not to return the VENUS greenness into Red flower, in which the gold seed is hid, let him not use it in any inward Medicine. That Nature shews us, that Fruits in their untimely Green are very unwholesome, and prejudicial. But if the same is by the Sun (Hebrew Schamesch) (consider this word and what is said in the S. 23., of the beginning or original Word, with all Diligence) Coloured or tinged, Yellow, Red or otherwise according to their properties, they are not only nourishing and wholesome, but lovely to the Sight & Smell.

S. 26. Otherwise the Green Balsam of Copper, that is made of the purest Copper without any strange addition, is a Wonder in all eating, and Gangrene complaints, as the Cancer, Fistulas, and such like. If this Wonder FIRE is much known? We very much doubt, much less how to ripen this Green Balsam to the Redness? It prepares itself without art or dexterity; for its preparation, there is not required, Furnaces, Charcoals, nor curious Vessels. One single Vessel is sufficient: But that one understands well the times, & to give the same property, & to know to avoid that, which

hinders its dissolution, the least degree of FIRE is by this work hurtful. Because the Copper is in itself a true Wonder Magnetical FIRE. It increases itself and decreases itself as well in the ascending as descending, if Nature is not hindered in her operation. It loves that but half, what all other Vegetables, Beasts and Minerals require and love wholly, Venus is further thus disposed, to avoid the Light, for her uncharit Coctions, and loves the night for her works; the time required for the preparation of this Balsam is only a quarter of a time, which yet, the same is comprehended for its whole preparation a whole time: Is this also a quarter of a time; so is the same perfectly a half a time. With Rain, Snow, River, or other Waters, you will have no reason to water the same, to bring forth its sprouts & Prunings, which is to be well observed, and which otherwise all other plants requires. One must also have a Care that the Crucible at no time is filled above the half. If the Wonder FIRE or Greening Balsam is obtained & prepared, one may in all truth boast of a Noble Treasure, for all outward complaints: One may also call the same with all truth the most Secret FIRE or Menstruum, numinant & Reflect further upon it. So here, we have plainly described its preparation plain enough, and have forgot nothing: The Purification from its feculency is shown of itself on to be understood of course, if one only knows the Heavenly astral Influence.

S. 27. From the pure clean Minera of Copper, one may through Distillation also prepare a Balsam, which is not to be despised. But one must know truly how to prepare this MINERAM VENUS, that in the distillation, it may be able to give this Balsam from it, as also by the same way there may be distilled out of all Minerals an oil or Balsam. And in all truth this may be called the right and true way, Namely that the same without any strange addition, but only with running WATER out of Eden. But this must be rightly comprehended otherwise it (is very easy to be deceived) which is moistened & soaked therein as much as is necessary to its dissolution and Rotting. We see already that many will turn up their noses at this and the foregoing S., but we must only laugh at them, because we are more than enough assured that this and the foregoing will not be altogether so well understood by every one: But those that are not in the Ways of Sophisters & Errons, but walk in the Way of Nature, will perfectly understand all this, then the same is more than too Light & Clear demonstrated or explained. Who has prepared this Metallick Oil, may not only perform something in the Animal, but something also in the Mineral Kingdom.

S. 28. We will now pass over the SULPHURS of the other metals & Minerals for this time, as we believe the Lovers of truth will find sufficient in the foregoing. But yet we will not wholly leave the Mineral Kingdom, but turn a little to the SALTS, not particularly of the Mineral SALTS. But will take for our object, the stable Wonder

SALT OF TARTAR, which may with all might be called a middle SALT between the Vegetable & Mineral Kingdoms; that TARTAR is a SALT any country Clown knows. And the discourse is not altogether here of its saltie Substance, which is treated of in another place. But will only treat of the SULPHUR of TARTAR. That in the distillation of TARTAR the same affords much stinking Oil, is known to all Laborators. But this is by far not the Secret SULPHUR in our point of view; HOWEVER WHO KNOWS TO DISSOLVE THE GOLDEN SULPHUR OF ANTIMONII IN THIS STINKING OIL, AND BY DISTILLATION TO UNITE THEM, HE HAS NOT ONLY OBTAINED SOMETHING WHICH COMFORTABLY STRENGTHENS LUNA, BUT HAS PREPARED AN EXCELLENT MEDICINE FOR THE LEPROUS & IMPURE GOLD, and in particular so if one knows to add to this twofold Oil its own fixed Earth or Matrix, wherein the same had its beginning, and to make also from a two-fold & threefold.

S. 29. Our point in view, is wholly calculated to the hidden & secret SULPHUR of the SALT of TARTAR. But in case the Child (contrary to the common custom, when this or that Essential propertie is often named seemingly contrary) should be called by its proper Name, & how the SALT of TARTAR may be wholly & soly converted or changed into a Running pleasant Medicinal SULPHUR; this then shall be described as plain as it is possible. But what may be here left out or slipt over, an Artist must endeavour to find by manual Operations: But this we say before hand, that provided the Artist is not extraordinary expert, and in the distillation has not every POSSIBLE ADVANTAGE, and insight, will not obtain this so Excellent a Tincture to Eternity: We also further remind this, that this description is a Key to much of the foregoing, which we have purposely withheld for this place, and not only calculated for this so excellent Medicine. But that this description may be a Key to more hidden Secrets. Hasten also to the preparation. Take the best TARTAR as much as you will, pound or stamp the same grossly and put the same in a stone Retort and distill the same by open FIRE S.B.A.A. If you have not herein rightly proceeded, all further proceedings are wholly to no purpose but will be thrown away. The Manuals hereof are so many, that one can scarcely describe them. Practice makes Perfect. In this distillation you obtain first, a somewhat spiritual WATER (is generally called SPIRITUS TARTARII) & then with stronger FIRE you obtain the stinking Oil, or gross SULPHUR of TARTAR, as the Reason that this Matter was of a stony property; drive the same with a Violent FIRE till nothing more comes over, as then hold yet a couple of hours with the strongest FIRE, and then let all cool. Have you herein worked rightly, and nothing has flown away, or thy Receiver has not broke, so have you in the same the Spiritualized WATER or stinking Oil & in the Retort a coal Black Caput Mortuum.

S. 30. Separate the Oil from the Spirit with a SEPARATORIUM & rectify the Spirit once, 2 or 3 times over a part of the Caput Mortui, but in each Rectification a fresh

part of Caput Mortuum must be taken and then preserve this Spirit well, further take the calcined Caput Mortuum & extract the same with clean WATER (can it be with distilled the better) till you have your SALT of TARTAR. Rectify from the same as you proceed further your Spirit TARTAR is also once or thrice, at last rectify the same ex. N.B. from that in particular, which all mankind upon the whole face of the Earth are most desirous of. But if you know not before, how to prepare the same hereto, all your Labour is wholly for nought, which done your Spirit of TARTAR is perfectly prepared, and keep the same with all thy care.

S. 31. And after this, calcine your SALT TARTARII very well, that so all the phlegmea and moisture may wholly be done away, then pound it in a Warm Mortar, and put it hastily in a glass Body; & pour upon it Rectified Spiritus Vini. But this Spirit Vini must have been very well Rectified, and not be still a Wine. But a fruitful Brandy Wine, Lute hastily a Helm and Receiver, and from ashes, Distill this Rectification of the Spiritus Vine, repeat this to the third time. Yet that the Sal TARTAR is fresh calcined every time.

S. 32. Lastly cleanse the SALT TARTARII through the Solution, Filtration and Coagulation, till the same is snow white, take of the same q. s., and put it in a good Melting Crucible, but only half full, put the same in the FIRE, let it flow well, drive the same with strong Fire so long, till the Sal TARTARII appears Blue or Blue Green, in the mean time, another Person must put of the SPIRIT OF TARTARII RECTIFIED q. s. in a great Viol and warm the same by the fire, then pour the SALT TARTARII in a tolerable Warm Iron Mortar, and pound it hastily while it is yet warm, that so it may not attract to itself the least Air, and put it also quite warm in the already warmed Spirit Tartarii hastily, stop the Viol close, and shake it also so long, till the Spirit Tartarii has dissolved its SALT; then pour hastily so much of the already prepared Spiritus Vini rectificato also q. s. and be sure not more: Shake and mix the same well with the other, so will you obtain in the twinkling of an Eye, Blood Red extraordinary SATURI TINCTURE, not unlike congealed Blood, and towards the bottom will separate a Blueish matter, which is the remaining SALT TARTARII, coagulate this and weigh it, so will you find how much of the SALT TARTARII is become a lovely SULPHUR or Tincture, & where you will find also, that a pretty good part of the same is turned into this lovely Tincture, or flighty SULPHUR.

S. 33. This is now a true Tinctura Tartari, not according to the common method of the Apothecaries, but is prepared according to a Philosophical way, whose farther use a Physician may know; of its excellency, we will say nothing for the present, Its use will speak of it self. In the Intrin, we affirm that we have ere now performed great wonderful Cures herewith: In MALS HYPOCHONDRI and stoppages of the Menses. It is

highly praise worthy, as also in the Tantanous complaints & c.

S. 34. From all other SALTS the preparation of their Tinctures is the same way. *MUTATIS MUTANDIS*, unknown to us! Namely to bring it inward properly outward, on to manifest it flighty SULPHUR. The foregoing description and the Practice thereof, may reveal much to a desirous Artist, then to describe and mention all would be impossible. Yet notice, that with the Spirit of all other Salts, as the highest ACIDUM there is quite another property than is found by the Tartari. All other Spirits of SALTS must be sweetened, otherwise you may have nothing to hope in Eternity. This is very easily done and obtained through the Magnetical powers or strength of Nature. But how few will follow after Potent Nature with Patience? And therefore one sees so little real service or good performed: To give here a process of each is not our intention or profession; a true Artist knows this without description, but to others its no service.

S. 35. Above in the first Chapter, is already said, that no Smell is found in whole nature either agreeable or disagreeable, whose Origin is not found in the Oily particular of its corporeal form (i.e. in SULPHUR) the stink of the common SULPHUR, when it burns, is seen & known by everybody, as also that the remaining matter that is left when burned, is a very nasty and disagreeable Smell: The daily experience further shews, that the Oil which is manifest in distillation, is stinking, as the property of each individual SULPHUR, and almost unbearable, & this is the reason of all disagreeable Smells & not only in Vegetables but also in Beast & Man. But although we see before hand that for the operation, we shall be tolerably demonstrated, especially by those whose Imaginary flighty Salts must perform such Wonders. Yet this shall concern us little or nothing, as this is not our motive, for writing to give occasion for disputes. But otherwise particularly ascertain in all truth, that nothing of that kind shall ever be answered by us to Eternity. Therefore everyone may sharpen their Pens against it, and then bring the same, namely his hatched or brooded Work & Wisdom to Market, where then will never want Loving of such school Foxes & Wise, if it should be only easy. The Red Cap or Hat every body knows makes a cardinal, for that reason they not Wise people or namely the Wiser, only, as far as the imagination says in the Character; the Name & Title must only fight for the Author.

S. 36. We remain therefore hereby, that the Volatility of Salts is not the Reason of the stinking non agreeable smells, and yet in a certain Manner it is true, in so far as we consider the outward form of the Salts: But if the same shall be unlocked, as we have learnt above, the contrary will be undeniable Manifest, namely according to their Elementary forms, as a type of that Salt, whereof the 1st. Part handles at large. Then the Brains of such a one must be terribly tonnid, which, from what is there said he should not comprehend, namely that Salt (understand the true SALT) in-

wardly & at the same time is also SULPHUR and MERCURY, not each in particular or individual, but are all three at the same time, one Matter for Example: "If one takes SULPHUR alone, so is the same not to be looked upon and understood as a separated matter, but with the same is also understood as a Matter that is at the same time SALT and SULPHUR. Then in each one is particular the other two are comprehended." By the Tartar we have shown that in each corporeal matter, there is two different SULPHURS concealed, as a lovely one from the source of Light, and a stinking one whose Origin and source is from the Elementary FIRE. Who knows now the true and perfect separation: He may boast that He is a Master therein; in the foregoing we have shown in the preparation of the TINCTURE TARTARI the same comparatively (but not altogether so Philosophically perhaps as many might wish or desire). Who has in the judgement or comprehension, no defect or short sightedness will easily see, to what we would even point to.

S. 37. In the foregoing S., we have said, that there may be a Tincture prepared from all Salts, as well as from the TARTAR, on in the same manner; whereby we have still to mention, that the Tincture of common Salt is the most difficult preparation, because in the same the Fire or SULPHURS power, as the bitter astringent sourness has the predominance. Then although the Preparation of this Tincture is in all things like unto that of the Tincture Tartari: But in case one is not extraordinarily expert in the bringing back of this Subject. We assure such a one that its lovely sweet SULPHUR will not be manifest. In truth it costs nothing, but to follow the way of Nature, and thereby without force bring back or turn its astringent Sourness, to its sweet property. Who uses proper patience, may easily obtain his point, and particularly so, if one has diligently observed, that, that has been said here and there concerning the same. If this Tincture is obtained, he may then boast of having a Noble Treasure; a True Balsam of Life; and even as the common SALT is proportionally used in all our Kitchen diet, so preserves our Body from putrefaction till to its appointed time; also much more may this Tincture SOLIS or SOL Potabile of Salt (a true possessor of Wisdom will not be offended at this by-word or expression) powerfully preserve and Supports Us.

S. 38. If one has understood all that, which we have here and there treated of in this Whole Work, of this Matter or subject, the same may prepare Chymical Masterings: It would be superfluous to say more hereof; we will therefore turn ourselves to the Animal Kingdom.

S. 39. And firstly in particular to Man, as the most wonderful created being of whole Nature: But yet our Intentions are not to treat of Man in Eden, APHOR MIN HAAM-AMAH (dust of the Earth) as formed or created according to the Image and Likeness

Elohim (of God): But of this Mans or mankinds Elementary dwelling, namely, of His Body after the Fall. Concerning the substance of the Human Body, the same has no similitude or likeness of any other Creature, neither in the Air, or upon the Earth or in the Waters; with which St. Paul accords, 1. Cor. xv. 39: "All Flesh is not of the same Flesh; but there is one kind of flesh of Man, another flesh of Beasts, another of Birds, another of Fishes." This shews much more the skillful Dissolution of the Human Body in its Elementary beginning, there is no flesh under the Sun that is composed of so much or many SULPHURS and Salts and so locked together, namely, as the Human Flesh and Blood is; all other Creatures are only taken from the Elements Or PRINCIPIS SECUNDARIS PROPORTIONIS act together according to their Qualities; & the Fish and feathered Beast from the Element of Water: All Beasts, Cattle & worms or reptiles, from the Earth; & have also properly no Part in, or on the darkness, only so far as Man by his fall, brought the Curse upon whole Nature. But perdition or damnation only upon himself: THEREFORE MAN HAS OF THE PRINCIPLE OF DARKNESS AND DAMNATION, MUCH MORE ON HIMSELF, THEN ALL OTHER CREATURES, BUT ON THE OTHER HAND MAN HAS IN THIS VALE OF MISERY & DARKNESS AND DAMNATION AND PERDITION, BEFORE ALL OTHER CREATURES THAT NOBLE HEAVENLY JEWEL, SPIRIT, SOUL & BODY FROM EDEN, NAMELY SHUT UP IN THE DUST OF THE EARTH; THEREFORE THE FLESH & BLOOD OF ONE UNITED TO GOD, THROUGH THE HEAVENLY RADIATION IS MUCH MORE GLORIOUS, EXCELLENT AND SERVICEABLE, THEN ONE OF THE PRINCIPLE OF DARKNESS, AND THAT WALKS AFTER THE WAYS OF SATAN. A Similitude may be seen in the Glorious shine or glance of Moses, when he had 40 days and Nights by God on Mount Sinai, which excellent glance, could not be beheld by the Human Eye, although He had not then even laid aside his Elementary property. But Like unto all other Men Requires Meat and Drink. Farther we also see that the Bones of that so Excellent Man Elisha, even worked Wonders, and brought the Dead to Life again, 2. Kings XIII, 24., as a Glorious Type, that the death of Jesus Christ will give all those that Sleep & Happy again Life. But on the other hand, it has quite another signification, by the possessed in the Country of the Gadarences, Mark V., which had his habitation in or amongst the stinking unclean Tombs, and led a terrible dark Banner course of Life, as was a habitation for a Legion of Devils, whose Flesh and Blood, before Jesus Christ had cast them out or Redeemed Him, would have been highly detrimental to the Souls and Bodies of other people; as all Necromancers well know, who perform with such devilish Mumial Subjects, their enchantments on both Man & Beasts, and cannot be carried any other way than through the true divine Godly MUMIE, to which there is required certain subjects of particular peoples MUMIALS: by which the Enchanters charm & Enchantments may be again brought on his own Neck, that Satan with all their List, cannot hinder, namely of the FIRE OF JUDGEMENT AND

THE HUMAN MUMIA IS WELL UNDERSTOOD. BUT WHICH IS A SECRET, AND FOR CERTAIN REASONS MAY NOT NOR MUST NOT BE MENTIONED.

S. 40. How it is with Regard to the foregoing DIFFERENCE between the wholly resigned to God, and on the other Hand the wicked, even also is it between a sick person and a healthy one, and openly manifest, that the Sickness of which the Person died, hangs on the Body till to its last dissolution. But since a full explanation of this Subject, would lead us quite from our intentions. We will recommend to the Lovers of true Knowledge, THO COMPANELLORE & SULLENT TRACTAT MAGIA DE SENSU RERUM. In which He may find a full and perfect satisfaction on this subject. In the Intim those, who make so much use of the Human Mumies by their cures, may notice, this old Customary dangerous fault, as namely through such Mumial (who has wholly by sickness been brought to death) & in such cases the sick person will draw therefrom more harm than good, and particularly so, when the MUMIA with regard to the sickness it died of Sympathises with the disease of the Patient, unless the GUMMI ROSIN, or other of their Embalming Spices, may occasion another effect; which indeed could not be the effect of the mumia, unless the same had been taken of a healthy beheaded Person; that from the Soul of such a Person there may be prepared a Wonder Worthy Medium for the falling Sickness, if one can dissolve the smell without force of fire by or through Nature herself, not through the common Laborators, with the FIRES force, a Mago Cabbalists will already understand of what hereof we speak, and know to find the true FIRE and WATER. Even through the same way there may be prepared from the Body of such a person a Balsam, which cures all Contracted Members perfectly, opens the nerves and Members that so the ARCHAUS may work on circulate again, & moisten the dried Muscles again with the Balsam of Life, that so they may again become healthy.

S. 41. In the foregoing we have spoken a little as much as concerns our purpose, of the Human Flesh, Blood & Bones as in respect of the Heavenly Man is comprehended & Conceived: But now we will treat of the Excrement of the same. That amongst the Excrement of all Creatures, there is not any found so offensive and disagreeable as that of Mankind, needs no further proof. Then this substance speaks and betrays itself everywhere. But as our point in view in this Tractate is wholly calculated to the SULPHUR, we will without further Prolivity turn to the same; and say therefore that the Excrements of Man is wholly a SULPHUR. This offensive or frightful and Hellish SULPHUR is good for nothing in its unbrought Back State, as to certain Dung-hills. But should an Experienced Artist take the same in hand, and knows properly how to treat it, He may find in the same a true astonishing Wonder Subject.

S. 42. We have known many which have worked in the same, but not found one

amongst the same, that have followed the Ways of Nature; therefore they have attained little or Nothing that answered their expectation. Some have thought without further to do, to make of the same the Philosophers Stone: How absurd and contrary to Nature they have worked herein we will not speak: Yet this foolish proceeding has now & then given occasion to a good Medicine.

S. 43. That the SULPHUR of the Human Excrements Loves the SOL above measure, and who the SOL wholly Loves of its SULPHUR, any one may easily experience, if He mixes fine filed SOL with the Caput Montuum and pouns the Oil several times over the same. Otherwise what the Phlegma of this Subject, occasions by the withered plants as also to the increasing of the same; of which we could write a large Work.

S. 44. The forementioned Oil, that has drawn the SOL and SULPHUR is truly a Wonder Medicine in the Palsey and all such like complaints. But one must well understand its preparation. Tis' true, the Oils prepared after the common or indifferent manner smells very Empyreuma; this disagreeable smell may be wholly taken away.

S. 45. Who knows to apply the Phlegma of this Work, by all plants wisely, may truly work Wonders, and particularly so, if in the same its own Magnet is dissolved, is then to be used according to the way & Manner of the Gardeners.

S. 46. Who thinks to perform some thing to the purpose with this stinking SULPHUR, has two ways before him. In the one Nature works wholly alone, without the Artist laying on of Hands, in its own Furnace, turns the curse or damnation again back, and makes of the darkness again light, and changes the hellish stink again to a lovely Balsam! The Artist only requires in this case, that He understands well the times, and to know the degree of hot and cold, and then again begin, where Nature left off; further unites his SULPHUR with the SALT and MERCURY (but the Artist must know well this Paradisical Bind) in a proper Hermetical or Arithmetical proportion. But the Binding, that occasions or works this, is a high Philosophical Secret, one must know well as also how to use it, otherwise all terrible Cost and time is lost; and then with SOL, but see that you know the true pure Natural ferment & figure. And then may he think himself fortunate.

S. 47. The other way demands one well experienced in the FIRE, here belongs Art and Dexterity; to turn all impurities without any waste wholly back again, and to change the same again into a lovely property. Therefore One must learn to know his true Bath, that so this impure matter may wash and cleanse itself; & Job calls it, in, Chap. ix. - 30., Rain on Snow-Water. But we call it by a Cabbalistical Name (see Fig. II) & is the Matter, this Seed at the night time in this Sweating Bath, the Artist may make of the same what He will, yet according to the foregoing precept, Each 3 Principles as SALT, SULPHUR and MERCURY are in & on themselves Wonders

in Medicine but so much the more if they are worked in their proper proportion. The Artist will not find in any Natural thing more Wonderful than in this. His Satisfaction will not be denied provided he is dexterious and proceeds naturally, and it would be impossible to describe all the appearing Phenomena. Hereby is also found as well as in the foregoing mentioned Way that individual one calls it menstuous or MERCURIAL or otherwise what one will. That dissolves the Corporeal SOL, wholly into an oily substance, that is not to be brought back again, and much more, that Noble SOL that is spoke of elsewhere.

S. 48. The MERCURY of this subject is the most Wonderful of whole Nature; but the description thereof belongs not here, then we here intend to treat only of SULPHUR. The Colours in this Work are astonishing, and the Grass green (that is drawn out in a certain way and through a retort distills over) is the most excellent. In the whole, this matter is almost unfaithmable. Then because Man is the concentred Middle point of whole Nature, in which there is all Elements, as also those creatures from the same, as it were swallowed, digested and changed into his flesh & Blood, the same is also found in his Mumia as well as in his flesh & Blood in particular as also in his Excrements in general. We say not this, that the Lovers of true Wisdom is altogether shewn hereto, then in the first Part, as also in the foregoing of this, we have spoke of quite another thing. But we have for this reason spoken so much at large of the Human Mumia because the same with Satan amongst all Creatures is alone & wholly fallen into everlasting Death, and must have remained there forever, had not the Victorious Jesus Christ again released us, and separated us from this dark Mumia Liken Matter, also that the same through the timely death he has laid aside his impure stinking SULPHUR shell, into which he crept through the satanical Imaginations, that the same may appear in its first created with purity or glory and may be presented to God his heavenly Father by Christ Jesus. But how this will properly According to the Holy Scriptures, and light of Nature be, as also the wholly returning of the Darkness again into Light, and the times be fulfilled in the times? Shall in the following be treated, when we Remind the Reader before Hand, that no one will give themselves the trouble, to know more or to expect more of Us, then has been mentioned in this Chapter, then in truth He will loose his trouble, then this is our intention, not to Reveal the very least more, then what is mentioned in the S.S.

The End of the Third Chapter.

OPERIS MAGO CABBALISTICI

ET THEOSOPHICI

PART III.

OF MERCURIO.

CONCERNING THE ORIGIN & RISE OF THE HEAVENLY & EARTHLY
MERCURII.

S. 1. We must here again as we did in the beginning remind our Reader, that He may not be offended or think strange, that in this Tractate of MERCURY, the SALT and SULPHUR is often thought on or mentioned; when our intentions are wholly upon the MERCURY: The following of this work, will of itself, satisfy the Lovers hereof, and for that reason it requires no further explanation.

S. 2. That the MERCURY is with the salt and SULPHUR one Origin, is evidently & abundantly shown in the first part of SALT, that the MERCURY is of all Created things the AIRY part, one well acquainted with Nature needs no demonstration; that the SALT and SULPHUR may be also dissolved in such an Airy matter, a true Chymist must know. But this MERCURY is twofold, the heavenly (called the MERCURY of the Wise) and the Earthly, commonly called, Quicksilver. We will therefore make a beginning of the Origin and Rise of the first.

S. 3. In the beginning creation God Created the Heaven and the Earth, Gen. 1. And the EARTH was without form, and Void; and darkness was upon the Face of the Deep; and the Spirit of God moved upon the face of the Water; how is this to be understood? We have already shewn in the first part of SULPHUR, Chap. 1. S. 16., and further & etc. In the 3rd. , Gen. 1., God made the Light; of which see more in the two foregoing first parts. This Light is the MERCURIAL SULPHUR of which is spoke of in another place. And when God saw that the Light was good, and He separated it from the darkness, that through the same might be corrupted, the first day and night. Tom. 1 of SALT. Chap. 1.S.8. But we cannot at these words pass without a little consideration: "And the Spirit of God moved upon the face of the Water." Namely consider how most of the THEOLOGIE herein Errs; that it was the Holy Ghost that moved upon the WATERS; alone, who knows the Everlasting God, without those error making School Terminars, according to his manifest Word and Works, namely

the Creation. I will not have such little Ideas of the unmoveable Light, and would it not lead us too far from our Point, we could here fully demonstrate that, of what we have touched on that Head a little in the second part of SULPHUR, but which may perhaps be done in the Chapter of Religion.

S. 4. Moses says farther, "And God called the same Light Day, and the darkness he called Night", above in the 3rd. S., we have called this Light the MERCURIAL SULPHUR, not that this Light is properly the MERCURY, of which we are intending to treat of, No, then our MERCURY is a much lighter matter, and is carried on Sublimed much higher than this Light. The abode or residence of this Light, of which the present discourse is of, is the expansion, which in the 6th. Gen. 1., is taught of, and in the 8th. is called Heaven: But our MERCURY is the AESCH MAJIM, that is the waters above the expansion, of which there is sufficiently spoke of in the first and second Part. This is in the typical, or ARCHETYPE the first forth-going of God, from which, the Almighty God created the whole SYSTEMA UNIVERSI; namely the first spiritual World; then that this our Solar System before the fall of Lucifer (through resistance, fell & the same became Elementary) was wholly such a Spiritual World. But when Lucifer through his Pride, was separated from God, he drew with him his whole system in the outward darkness & Everlasting perdition, whereof more of this must be sought for in the first part of SALT with all Diligence. When then his three Principles SALT, SULPHUR & MERCURY that is his AESCH MAJIM was also Spoiled, and changed into a Chaos, or acid form, so Created Elohim (the mighty Judge, as in the first part Chap. 5. 37.) this visible world, out of that acidated Mass, as is manifest from the 1st. Chap. Gen., and as we have explained in the foregoing first part at large. And in this Creation is our MERCURY, that is also SALT and SULPHUR (namely Aesch Majim) as is already declared in the foregoing parts abundantly, ascended up to the highest summit, and surrounds the outward circumference not only of this, but also of all other Systems that are in the incomprehensible Abyss, namely, in compassing the whole Created UNIVERSI. See Fig. 1.

S. 5. That the first outflowing of the incomprehensible Godhead, in its first Unity to us is an incomprehensible Wonder SALT that is even in the same property also SULPHUR & MERCURY. We have abundantly shewn in the foregoing Parts. But when it is said that God made the World of Nothing, so is it said with regard to this just mentioned, & to us incomprehensible wonderful out-flowing. The Word Nothing, tis' true may be comprehended according to the composition of the Letter, as also of the tone and sound, but that does not imply that the meaning is incomprehensible, neither can it find place in Nature or God. The Almighty God, fills all things, and out of God nothing may be, but is the fullness of the Godhead & God is full of

nothing but God: Therefore there is no possibility of a Vacuity to be found neither in or out of God. Even so, is it with the so called, Nothing, which is only bred in the Imaginations of those whose heads are empty & of these only comprehended. Yet from such doctrines there Springs the most Terrible Absurdities. From the foregoing fundamental remarks we maintain fast, & positively determined that all Creatures, whether visible or invisible, Spiritual or Corporeal or Elementary are come forth from God, namely from the incomprehensible outflowing, to us, which cannot be fathomed by our understanding, nor may the same soar higher, then to the WATERS above us, and all other Systems AESCH MAJIM. That this is much purer and excellent in its original state, like unto the Aesch majim of those Solar Systems, above said, the Lovers of lasting truths may partly see, in the 2nd. part of SULPHUR Chap. 2. S. 23., 24. But while this Unit, comes quite too near to the point of Eternity, & wholly incomprehensible itself, in the Mortal Life (See Fig. 1.) we must follow the moving, rolling of this Point or Unit, (here the first Part of SALT must be well known) in a straight Line till to the Apex above our Solar System, where it remains standing on being, as well as our comprehension.

S. 6. But on from the foregoing S., the Lovers hereof, as also that which is said in the first part of SALT, will perfectly understand, what is properly the heavenly and above Earthly MERCURY? And how the same was manifest in the other state of the World (MUNDI ARCHETYPE). Whereby the Lovers hereof may further Minutely consider, the forementioned, Fig. 1., where the rest may be known to Him, which has not altogether been mentioned here. The true Mago Cabbalist here signifies this Matter, or universal MERCURY of which all things was made, also; MERCURY, that is through a whole and a half Circle with an onhanging Cross, or two whole traverse Lines. If one seeks truly the true origin of this character, so is the same as other then VITRIOL ; which origin is a circle, and this Circle originally from a point, namely the A and O, i. e., Fiat. How that from a point, a line ensues, & from this line a Circle, is plainly shewn in the first part of SALT, Chap. 3. S. 11.

S. 7. In the abovementioned 1st. Part of SALT, we have proved, that the first matter of which all things was made, was SALT, that was equally the same property and was SULPHUR and MERCURY, and from some of the Wise not improperly called , which they have also signed, see Fig. 7., from which Wonden character, the characters of all Metals and Minerals ensues, as is partly shewn in the 2nd. part of SULPHUR, S. 7. But may here be perfectly known & Comprehended, then they all follow, also, GOLD, SILVER, COPPER, LEAD, TIN, IRON, MERCURY, ANTIMONY, ARSENICK, SALT OF TARTAR. That in all Alcalies, as also FIRE, AIR, EARTH, WATER, and which is therein to be found in the same. The poor Gold Spoilers will not imagine that we here speak of

their sneaky Gnawing VITRIOL, from which they will boil the Stone of the Wise: Far from the Mark. The Vitriol of which we here are speaking is only known to the true Wise, and has with this Earthly not least resemblance, although originally it was the very same, and came from it, and still is the same light, but changed in darkness. The difference between the MERCURY and the above mentioned Vitriol of the Wise, is much too great, for the poor things to obtain their point with common MERCURY. Wherefore its necessary to learn first, to know truly, this secret, Wonderful Character.

S. 8. Commonly the Wise have represented, as well the heavenly as the Earthly MERCURY with this single Sign: Namely through a half and a whole Circle with two traverses or crosses; the same shews, that it is no other then the Red & White Saltyish SULPHUR of GOLD and SILVER. But when the same is laid again together so is it MERCURIUS, the Universal Menstruum or dissolvent, It is otherwise like unto a clean WATER, only that the same don't Wet, and also improperly called a WATER, not like to Ice, which in the heat turns to WATER and Wets. It is the Spirit of all created things, and the which he is in general: And yet not be again; till the hero comes, and upon which will be said, Apoc. XXI. 5.: See I will make all things New. Let no one Imagine, that Human Art & Wisdom may reach so far, to obtain this MERCURY, while it is still the one single AESCH MAJIM in a corporiety, then it comes to Us no other than through the expansion, which Gen. 1. 8. calls Schamajim (heaven), whereby we have occasion, to clear a little this word expansion.

S. 9. Here we must take again before us, Fig. 1; where i. k. is the expansion on the heaven MARS & JUPITER and SATURN; here the expansion on heaven COPPER & MERCURY, and m. to the heaven or expansion of the SUN. But the LUNA is, e., the Sphere of the Earth on heaven, yet the same is over itself and under itself, namely of all heavens as the expansion and separation between, majim (water) and Aesch Majim (FIERY WATERS) as the figure shews. It is to be observed that these heavens & Expansions, are not of one and the same matter or property but N.B., each in PARTICULAR, is a peculiar running or flowing matter, wholly different from each other, & therefore can in no way mix or combine with each other, just so as OLEUM VEGETABILE and OIL TARTARII DELIQ. and SPIRIT VINI not easily will mix with each other, so that one substance may be thereof, one may shake the same in a glass together how one will, it will always separate from each other again, so soon as the same has stood a little; also, the Oleum TARTARII per deliquium at the bottom, upon the Oleum Vegetable & at the top the Spirit Vini, the same has also the Nature or propertie of our Heavens or Spheres, not only in this our Solar System but also all the other innumerable SYSTEMITATIS, Namely, each fixed Star has its own flowing & Sphere, of

which it was formed, and in which He on it services, not out of the same neither above or below it because that would be contrary to its property on Nature, as the foregoing similitude may shew, and therefore this Globe, so long as it will Last, can in means move from its Position, but must constantly move on serve in the same. Perhaps something more hereof may be mentioned in the Chapter of Astrology. Which then this Virginal MERCURY may not be obtained in this mortal Life as AESCH MAJIM: But only when it firstly became BDELLION in Eder. The Text says, the GOLD of the Land is good, where also is found Bdeillion, and the Stone ONYX, it is farther to be observed, that although AESCH MAJIM penetrates or sinks through all the Spheres of the expansion into Eder, and there becomes Bdeillion & may not be altered or changed through the abovementioned Spheres, because of its Unity (or oneness of its nature) so that it was no more Aesch Majim: But it is BDELLION and even still the perfect Aesch Majim, just as the Quicksilver remains MERCURIUS, although it may have suffered a defect through that, what it is, itself. Here we have said something. And a certain discourse that we have made upon the same subject, in the 2nd. part of SULPHUR, may give a Lover hereof great insight, & which He may search for. But let no one imagine, that because we have called this Bdeillion in the foregoing S. a WATER, that we have thereby meant the WATER of the Air with which many have used to Murder themselves; nothing use. Therefore we have said: It Wets not, nor does it make Wet, even as the MERCURY wets not, although Bdeillion is a living WATER, therefore has it a comparison with a flowing, yet dry SALT (understand this very well) which flys away by the least warmth, then it likes nothing but its own FIERY WATER. And may also, only be bound with the same. Already too much said. And hereafter nothing more hereof. See Part 1., Chap. III. S. 10.

S. 10. Concerning the Origin and Rise of the Heavenly MERCURY. We have to its Lovers said enough. Its power and workings is seen by each days work of the Creation with the highest astonishment; hereof more in the following chapter. Haster also to the Origin and Rise of the Earthly MERCURY or Quicksilver. See with all attention in the 1st. Part of SALT, Chap. 1. S. 22.-25. This over already described MERCURY like to metallick WATER. Here from old times till now, made more fools than Wise Men, namely amongst those desirous of GOLD, who desired the same, more then the Kingdom of God and his Mercy, as the only true Wisdom. This Metallick WATER is a wonderful Mixture or Blending. Its outward appearance, tincture, resembles SILVER. But as the Artist knows, without any addition except the above mentioned from Nature coagulated MERCURY, to coagulate the same, it will be highly Red, which indisputably proves, that it is nothing, but a SULPHUREOUS SALT. Its dissolution into a tasteless Water, which is not altogether so well known, shows from whence

it has its Rise, and that it is an after-birth of the universal, on Heavenly MERCURY. In fact it is nothing else, as the just mentioned Mercury in a tender Loamy MATRICE, though a SOLAR SULPHUR and LUNAR SALT, coagulated in their untimely form on EMBRYONE in the first degree. And because both these working principles are near the degree of Suffering, the same are for that Reason mixt with each other, that the same may not be separated by any Art or Knowledge, namely, that each Individual of these principles, cannot be brought back again, to its first Principle, without its dissolution.

S. 11. In the foregoing we have said, that the common MERCURY is by the heavenly MERCURY, as the same has coagulated it, in a tender Whitish Loam on SULPHUR with a white SULPHUR, suffers itself to be coagulated in a Red Precipitate. The above discourse, will not be as easily understood by every one, therefore we will recapitulate the same with an addition of a few words, for the better understanding thereof, although the same may be found quite intelligible in a certain place, Chap. 2. of SULPHUR, from the Origin of the common MERCURY, see also Tom. 1., Chap. 3. S. 10., as is shown in the shortest & plainest manner in the foregoing S., should the poor Gold maker easily see, how little may be performed with the Quicksilver in this Undertaking: Then since most of its substance or matter is from the Heavenly Mercurii. And therefore there is nothing found in Nature, more light & Flighty and inseparable with the nominated SOLAR SULPHUR and LUNAR SALT, congealed in its Matrix, and flows or unites together, as easily as Solid Oil, Butter & Land does & which may not be separated (on purpose, we don't say coagulated) therefore this MERCURY cannot indure the least Earthly FIRE, and therefore all those intentions of Coagulations, Fixations and what other Whims one has in View, is lost and to no purpose. But otherwise it hastens to its Origin and Rise, the Heavenly FIRE. Its own Origin or Source can only coagulate it to a perfect fixation.

S. 12. That the inward property of the common MERCURY is according to that of SOL as also LUNA, (according as the Artists hands has dealt with) is known to all those, that knows the WATER, of which it has its Origin. And although this does not belong here, yet we must take the Text Gen. 2. 8., before Us, that so the Lovers hereof, may learn better the just mentioned WATER, and the MERCURY springing therefrom. There one Reads, also: "And the Lord God planted a Garden Eastward in Eden." (See Fig. 1.) v. 9., and in the Midst of the Garden the Tree of Life also; (Fiat, the Word), Jesus (Christ). And the Tree of the Knowledge of Good & Evil; (the free Will) v. 10. And a River went out of Eden, (the radius o. p.) towards the Garden (namely from the point of the first beginning, o,) and pours its out-flowing O, h, in all Worlds & their Created Creatures, compare this with an enlightened comprehension, to the sixth and last days work of the Creation, Tom. 1. of SALT, and the

Lovers hereof will not find Paradoxes, as it may appear at first, but otherwise an enlightening or clearing this and that, to his no small satisfaction. And from thence it was parted, so that 4 Head Streams became thus from the 4 beasts, before the Throne of God, through which the Godly forthgoing flows to all Waters. See Exekiel 1. 8., XL. viii: 32-35. And Aopr. v. 8., 9. Our Reader must here know how to compare & Unite the above mentioned place Tom. 1 of SALT, with this, otherwise he will judge we speak contrary to ourselves. V. II. the name of the first is PISON, the same that compasseth the whole Land of Havila, wherein N.B. Gold is, and which is not said of any other of the Rivers, v. 12. And that God (deceive not yourselves you poor Gold Thirsters! Then it is no Gold out of the GANGES or INDUS, as those poor seminary people dream, otherwise it is a Gold from a much higher Stream or River, of that Land is costly. There is also BDELLIUM (where this costly GOLD had its origin or beginning) and N.B. the Precious Stone ANYCHEL (which springs from this Costly Gold). See there, if we could have said or could you more? The BDELLIUM, that can only be found in the PISON, was Originally Gold, from which, the Precious Stone ANYCHEL is made, or brought to Light. Who Loves this Stone Onyx, and would gladly obtain it, let him seek for the Waters out of Pison, and in the same that Gold and BDELLIUM, so will he without fail obtain his Ends. Who now, does not understand this, let him not blame and reflect upon us, but blame himself. A True Lover hereof will have no reason to complain of Us, unless indeed in this, that he would blame us, for speaking more than too open and Plain.

S. 13. The foregoing S., will give the Wise ones something to Reason about, as their groundless Imaginations may conclude, that we have in the explanation of the above-mentioned Text; Gen. 2., spoke contrary to what we before asserted. In Tom. 1 of SALT, in the explanation of the six days Work, Chap. v., seemingly quite otherwise, then in the foregoing S., in the concisest manner. But those that are not become Blind in quarrels & Disputes and only a little proficient in the true Mago Cabbala will easily see and conceive, that we use no such contrary ways of Speaking in any of our writings, although the same may at first sight have that appearance. But otherwise the one part may explain what may be dark in the other, as a Lover of Wisdom will see by little & little.

S. 14. Seeing then, that the Holy Scriptures leads us to the greatest Wisdom, as is manifest from the Words of Christ, John v. 37; where it also stands written; search the Scriptures, for in them ye think ye have Eternal Life; and they are they which testify of Me. We will therefore once more take to our consideration, Chap. 2. Gen. where Moses says v. 4., on speaks of the Generations of the Heavens: But in the half of the 5th. v. also; "And the Lord God had not yet caused it to Rain

upon the Earth", (here the Text speaks not of Eden, as is manifest from the following). And there was not a Man to till the Ground, (till Adam was drove thence from out of the Garden). We cannot here pass by without considering, this Rain a little; namely, It cannot be proved that it Rained before the flood, in the first 1630 years of the World. And of consequence there was no clouds about this Globe, of the superfluous Moisture of the same namely SALT, SULPHUR and MERCURY. A sensible Person will not make any Sinister gross Idea hencefrom, that, the Earth was also not penetrated therewith before the flood: Then the 6th. v. says: "But there went a Damp or Mist up from the Earth, N.B., that watered the whole face of the Ground." These last words, clears the foregoing v. 5. "And there was not a Man to till the Ground," (not in the Garden of Eden) but this our Earth on Ground, therefore the 6th. v. says, watered the whole face of the Ground, which cannot be understood to be Eden: As we have shown in Tom. 1. Chap. v. In the explanation of the 6 days work of the Creation at large; whence Eden: And the Garden was, and is Still?

S. 15. This Mist which went out of the Earth, before the same was spoiled through the Flood, was the most Noble power or Virtue of Heaven, which may be further sought or looked for in Tom. 1. of SALT, sublimed or driven by the Central FIRE of this Earth in the Atmosphere, namely SALT, SULPHUR and MERCURY in a single watery Unity. An attracting binding Magnet, in the property of a Matrix impregnated in the highest, from the upper powers or Influences, to quicken this Earth with the most Fructiferous Living Fertility, that so the Spontaneous productions of the same might Herewith be made partakers: Therefore a certain Learned Man says in his small Canonologie: "before Noahs flood all mankind lived without Flesh, Fish, Vine & c., but their food was, fruit of the Trees, Roots & Vegetables, N.B., which was at that time very good and wholesome, and therefore they thought not on flesh: Also the Waters was very wholesome, and also better then, now are Aromaticks & Spices are; namely before the Kingdom of the Earth was spoiled with the flood. An Apple was at that time better, then was those of our Apothecaries Shops are, & therefore they had not much sickness and Lived so Long; from this may be seen that this damp or Mist had a much Nobler property, as the Rain which firstly appeared at the flood, and at after remained on the Earth: Namely this Mist was a pure Coagulation of the AESCH MAGIM; as the same, according to the above S. 9., comes to us in likeness of the Quicksilver or Metallick WATER, namely the common MERCURY: Which Mist was then capable of attracting its likeness from our Region of Air that compasseth this Whole Globe, to its self, and again attracted by this Earth, as the Universal Matrix of all Beasts, plants and Minerals, with great desire, to enable the same to send forth all its before mentioned reductions with power & Strength, whereof more may be seen in the

first part of SALT, that so the one may be better understood through the other. That the Rain from the time of the flood till now, has by far not such powerful workings, needs no proof, by those experienced in Nature. Then after the SOURCE SPRINGS of the great abyss on deep, Gen. VII. ii, and the Windows of Heaven were more opened, instead of the foregoing as it were congealed in the Earthly universal MERCURY, that in the Damp or Mist, Gen. 11, 6., as a Wonder Magnet of the Red and White, Male and Female, was nothing but FIRE, was drove by the central fire of the Earth to the uppermost superficies of the same, and further attracted by the SUN, is not to be compared to the foregoing Magnet or chosen Astral power, this FEMININE is not Contrary to the former, (as perhaps a disputer may imagine) to impregnate the Earth (but not so powerfully or of such Virtues as before the flood).

S. 16. In the foregoing S., we have shewn, that before the flood it did not Rain upon the Earth, as is manifest from the Text. But that this shall be no further doubted hereof. The Lord God said Gen. ix. 13. "I do set my Bow in the Cloud, and it shall be a token of a covenant between Me and the Earth & c. Now the optic proves that the Rainbow is a Reflection of the SUN in the downfalling Rain. Also had it Rained before the flood, so must from the foregoing PRINCIPLES PHYSICIS OPTICUM, Rainbows appeared or have been seen. And also the Rainbow must have been already well known to Noah and his Sons, and consequently would have been nothing New to them or uncommon. And therefore Noah would have answered God: So, this Bow I have already seen often in the days of my Life, that the same is nothing new to Me, and had consequently like Gideon, Judges vi. required several other signs of assurance. Therefore the Rainfall must have been something New & Uncommon and unseen before to Noah. That he remains steadfast in the lasting Covenant of God, unconcerned or without fear of another deluge. And began again to replenish and build the Earth. From which may be undeniably concluded again. That it did not Rain before the flood. And no Rain was thought of from the beginning of the Creation, till to the 4th. v. Gen. Chapter vii. But first appeared A.M. 1636, namely in the 600th year of Noahs Age on the seventh Day, the Rain first began to pour on the Earth; and after the violent Rain had ceased, and the Earth became again dry; and at after in the Refreshing Rains by the immediate direction of God the Rainbow first appeared to Noah, when there, God spake to Noah: I will make a Covenant with thee and all flesh, that to the Everlasting Period of the Earth, the same shall not be any more spoiled by a deluge: And I will remember this Covenant, as often as I shall see the Bow in the Clouds.

S. 17. That the Universal MERCURY, which is also SALT and SULPHUR, is to be

found in all things. Yea in the Most minutest atoms, and that the same is the Spirit and upholder of all things, must not be unknown to all those well versed in the true Art of separating, and as soon as this MERCURY is separated from any Body, there only remains a gross SALTISH SULPHUREOUS property behind, and as then the Body is killed, as is elsewhere proved and shewn, its form is Wonderful, in all Creatures, through the Earthly FIRE it fly's from all things, sometimes Visible as well as invisible and therefore it is not very easy to describe its form or figure. But yet well known to the true Wise; from the Character MERCURY a Lover hereof may soon learn to know it. And is drawn by us here and there, already in several places, yet we will once more in few Colours describe the same; (which may at first sight seem quite contrary to our former description. But which must not by the Lovers hereof seem an Error). The whole Circle hereof with a Line across, is SALT, also is it SULPHUR, as Sulphur, namely the half Circle with the under throughout on cross, and the in-hanging whole, & then remain half through-out on cross; is all together when connected; MERCURY, whereby the Lovers hereof may see, that it appears sometimes in a form of Light, is, as a Volatile Spirit, this again as a dust making SALT, and again does appear as a flaming SULPHUR. Who now can learn this Wonder Phoenix by its feathers, may easily find and prepare the Yarn (or thread) whereby this Universal & yet so seldom known Bird may be hatched. To those who has a true Knowledge of Nature, this is more than too plainly described. Yet one must also know the Colours of those just described feathers, otherwise it is very easily to be deceived. In general, its Colours are like the Rainbow, as yellow, Green, Red, on blending or uniting together & loosing in one another, according, as they take their Rise from the Ground, namely of the Wise, i. e. Light, and play in each other as may be seen in some measure in Fig. 3. Who rightly knows this, will need no further explanation. The same is not improperly called the Light SULPHUR of Nature, as the Spirit & Soul of all things, without the same there is nothing to be performed in the true Magia, and Secret Philosophie, therefore who knows the same, & can obtain it, He will not want the SALT and SULPHUR of the Wise, and then easily perform and end the Art, then the perpetual workings of Nature will easily shew the necessary FIRE and its degrees.

S. 18. This Light or MERCURY, Lucifer lost in his fall, and that the same was separated or removed from him. But it is locked up and turned inward and in its place is the Saline SULPHUREOUS Spirit or MERCURY manifest, which can no more ascend above, but like unto MERCURY in WATER sinks to the bottom. Then the Creatures of God cannot again be separated or divided from him in Eternity, but may suffer a change, as is manifest in Lucifer and all his fallen Angels. This Light or MERCURY

may not shine for him again till through the Revelation of his Grim FIRE (whose extraordinary operation Fig. 2., Tom. II. Tab. 1.) namely till the Hellish FIRE is wholly consumed in him. And He with all his fallen Angels, appears again (out of his frightful or destructible dissolution) in his first pure Angelick form. In the 2nd. Part of SULPHUR we have already shewn, how this may be done, that the Devil, and Spirit can be Martyred through FIRE, whereby we have occasion further to mention, that even as an Oil (which in truth is nothing but SULPHUR) i. e., FIRE, when the same is put in the FIRE, it lights and burns, and is subject unto a suffering; even so is it with the Devil and his Angels, namely that they in the Hellish FIRE are subject through the lighting and burning, to an Anguish and suffering and as impossible as it is for the FIRE to consume the Oil that has therein burned to a Nothing, but may well overturn its form, the Earthiness (as the darkness) is thereby separated, and its visible ESSE, namely the unconsummable Light or MERCURY is thereby cleansed, even so is it also with regard to the Hellish FIRE, as an anguish of the Devil and the damned, until they are cleansed or separated from all Devilish impurities and imaginations. And even the Devil himself becomes through the same, separated from the darkness to light. Whereof more may be seen in the foregoing part.

S. 19. That Man, when first created by God the Almighty in Eden according to his Image and Likeness, had all such an Elementary Corporeal Body, we have already shewn in the foregoing; then when Man used his free will by the insinuations of Satan, and fell from the Godly Composure, in a desirous Individuality, so soon was manifest to him this Beastly horrible deformed form, in which state he found himself, and as one may say, in the future stood between heaven and Earth, when He, namely had lost the first image and Likeness of Elohim, and had not as yet obtained any other, namely had not yet experienced having flesh, nor knew of any thing but the fruit of the Garden of Eden, whose sweet property was to uphold and Nourish his first form. But when he could not longer partake thereof, He reached after the Leaves, the Elementary sweetness of the Fig Tree (namely to satiate himself in his Lustfull sweet Liberousness, but which was not sufficient to cover his nakedness, and therefore He sought to hide Himself from the face of God in the Garden, as the Text says in Gen. 1. v. 7. Thus were both their Eyes opened, that they saw themselves Naked & c. And they made themselves Girdles (commonly Translated Aprons) but the on hanging could not give these fallen Creatures again their true form. The word Chagonsch (apron) derives from the word Chagan (a girdle) but the connection permits the word Chajinth as this means the same in the Translation as a Girdling, i. e. something that crosses, but not rightly a whole clothing, therefore the Lond

God could not behold them in this fallen situation, but gave them clothing or serving according to his fallen Imaginations, as plainly appears by the Text. And the Lord God made for Adam and his wife coats of Skins and clothed them, i. e. gave them Flesh and Skin (of Skins, i. e., a Beastly form). These Skins have still another secret meaning, as has been mentioned in the vi. Chapter Tom. 1 of SALT. He gave them an Earthly Body, because his Imagination of the Garden of Eden & in this Earthly Garden: And because this their gross Earthly Bodys could not subsist on the wholly Spiritual Fruit of the Garden of Eden, to nourish & increase their Flesh & Blood, are the same because in this our Earthly Globe Earthly, so the Lord God drove them out of Eden, into this World; (as may be seen in the iv. Esdras Chap. iii. 6., and thou brought out them in that Paradise, that thy Kingdom had Established or planted, N.B., before he came upon the EARTH) to support him with care his Earthly Body, till this wonderful MACHINE by the constant use thereof, is unassisted and no more capable of support from the Nourishment, falls again and wholly passes away, that so the first forms they had in Eden, in the Image and Thoughts of God may again be manifest; which the Lord God had formed from the dust of the EARTH out of Eden from the dust of the Red EARTH, i. e., out of a Saltish MERCURIAL Sulphur, from SALT, SULPHUR and MERCURY, not the Coal dunty, Gold covereous Alchemists Salt, Sulphur & Quicksilver, but of that, of which this whole work treats of, & which was never known to those poor creatures. It is one, and one and the same, although it may perpetually manifest itself in SALT, SULPHUR and MERCURY, a Trinity in Unity, i. e., a consuming flowing FIRE, from which through the FIAT all things in Heaven and under the Heavens were created. See Fig. 3. It is an inseparable three from one point and is flown to all parts of the Creation; out of the same there is nothing but God, for this Reason it is necessary that the same must be in all Created things, because all things without exception are made therefrom, & those will last or continue to Eternity. The truth hereof, that this matter is in all things as SALT, SULPHUR & MERCURY is also N.B., Corporal & Spiritual & a true Artist in the separation, finds the same as also with SALT, SULPHUR & MERCURY in all Earthly things; then there is nothing in or on this Globe found, which may not be separated by the true Art into, SALT, SULPHUR and MERCURY, (as we have just said before) namely brought back again. BY WHICH WE HAVE OCCASION IN PARTICULAR TO REMIND, & NOT FOR A TRIFLING REASON. That amongst all Sublunarial things or beings, MAN IS ALONE, filled THE MOST WITH THIS UNIVERSAL MERCURY. AND HE IS THE NEAREST TO ITS UNIVERSAL SOURCE. A True possessor of Wisdom, will already know, what unspeakable Wonders there may be performed from the Same; As also that the Use & Advantages arising therefrom would alone of itself fill a Large Book.

OF THE
USE AND ADVANTAGE OF THE
HEAVENLY MERCURI.

CHAPTER 2.

S. 1. In this Chapter, we shall be very Brief in this Subject seeing the Use and Advantage of the Heavenly MERCURY, is for the most part already mentioned in the first and Second Parts. Its Universal Uses and Property is, that it is in all Sublunar things, the Spirit and upholder. And as soon as this MERCURY is flown or drove away, the Body is dead. As is seen in the Vegetables, then as soon as this is separated by the Art of separation & the MERCURY or Spirit is drawn or distilled, the Vegetable is brought out of its Substance: And without this Heavenly MERCURY can also no being here on this Earth exist. We have just here called the Spirit a MERCURY, not that we would thereby have understood, the Original Heavenly, then this is quite another sort of a Kind. The Spirit of a Vegetable, Animal or Mineral Body is called a MERCURY, comparatively against that of the Heavenly, namely according to its Physical Principles wherein the Heavenly MERCURY is as it were concealed in an AIR, WATER, and like unto an high rectified Spirit which divides a Body in the most minute particles, (but does not melt the same into its first Matter which melting or dissolving is only possible to the heavenly MERCURY) also the heavenly MERCURY may dissolve all Bodys in the 3 Kingdoms without force or Violence into their first property or untimely form, as has been already said in its place of the Heavenly SULPHUR.

S. 2. From this the Sophistical Alchemists may Learn, what service their Menstruums may do them, through which the Bodys are destroyed, not natural, but like the Murthering of a hangman it is wholly destroyed. Therefore to the true Menstruum is only chosen this Wonder MERCURY, which is also Salt & Sulphur. If one intends to do the work with little Cost & Labour. But with what sort of a Net this wonderful Bird is to be caught, is a higher Question, because the same appears more in the form of a Spirit, then as a Smoke and Damp, then as FLORES, then again as SALT, as also again as a SULPHUR. An Experienced Bird Catcher is always diligent, to have at hand good Call Birds, of the same sort He intends to Catch, and places the same amongst the flock. Out of GOLD one can make GOLD, out of SATURN one can make

with a ferment MERCURII Mercurium; Like Loves its Like; by contrary things nothing is to be obtained; the One World gives this the other, that, who has this MERCURY as it is congealed in its own Minera, the same has a Magnet, through which He may obtain his End on point, and catch the Bird according to his pleasure; whether it is in the form of a Spirit, Smoke, Damp, or also as the Stone JASPER, Apoc. xx. 1. & ii.

S. 3. All the World wishes Long Life, and constant Health, and many are Labouring, to prepare a Medicine to obtain both: Because the GOLD is found the most durable and the most FIRE-PROOF matter (but one must know the true GOLD) one has not judged improperly that from the same may be prepared the most Noble Medicine for the above mentioned purpose, namely when the same is brought into a POTABILE, that so this juice or Tincture might mix with our Chyle & penetrate or pervade through the whole mass of Blood. To purge the same according to nature's FIRE, and revive & give new Life. But seeing that in this Matter there is so much spoke of GOLD, the foolish GOLD covetous Alchemists and smeary Cooks have fell upon the Corporeal GOLD, have explained the Enigmas and hidden and dark sentenances of the Wise according to their own opinions & Gold thirsty Inclinations, and thereby not only ruined themselves, but thousands of others possessed with the thirst after Gold, not only in the timely Ruin but also everlasting perdition. True it is, that the Metallick well purged Gold may be dissolved without the force of Corrosives, naturally without a single destruction or separating of its substance into a Liquor or Tincture, and is a true high and Wonderful Medicine, and performs in all Complaints all it can with great Praise & therefore it is not unreasonable to search after it: But yet it is not comparable to the true AURO POTABILE, of which search with all diligence in the 2nd. Part, Chap. II. of SULPHUR, where there is in S. 11. to the Lovers hereof, a true SOLUTIA AURO without Corrosives, through a Menstruum which no Living Creature may be without, and its preparation is thus uprightly and perfectly shown. Its true many will be offended at the terms that we make Use of, as also Wooden Furnaces. And that we have called the Menstruum as ordinary common Water. But one well acquainted in the true Art of Separation, will not thereby suffer himself to be brought into Errors. But from this poor Riddle easily learn the truth, though common MERCURY will also dissolve Gold, lessens all unserviceable & Excess ACIDUM, and drives away all imperfection by the sweat: But this is not in any respect to be compared to the former, or the former mentioned.

S. 4. In the high Philosophy, there is nothing to be obtained without the Universal MERCURY and needs no further proof. But this MERCURY is so seldom and wonderfully described by the Wise, that it requires almost more then a Prophetical Spirit,

to resolve their Riddles. And they have often not known themselves, what they would thereby point out. Then it is very demonstrative, that most part of those Authors have wrote quite contrary to Nature: But those also infatuated with gold making, knows how to deceive themselves and others of easily believing with the most insipid absurdities; and even then they will have those things Rime on harmonize: But we use no such sort, of so called Philosophical writings in our whole work, and therefore we may easily draw their fury, that we shall not remain unwearied from such sort of People: But, which will, little concern Us?

S. 5. That the Heavenly MERCURY, is the Universal Menstruum, because it is equally also, SALT & SULPHUR, is over abundantly already shown in the first and Second parts; In its first form it is a FIRE, which our Earthly Bodies cannot bear, then it would wholly resolve & dissolve the Same: But when the same is by the artists Hand brought to the form of congealed Ice, it is a Wonderful Secret in the MEDICINE. And of great Power: Naturally, it is not found in such a congealed Icey form, but is easily brought thereto, of what was said in a certain place in the 2nd. part of the Magnet, has been well Understood. Who now has the just mentioned MERCURY. He has the true SALINE Mercurial Water, which is necessary to dissolve the true GOLD for the preparation of the high Aunum Potabile; when the Metallick GOLD is therein dissolved, it is also a SOL POTABILE but a SPECIFICII, even as LUNA and all other Metals affords the same.

S. 6. Further, How much this Universal MERCURY is needful for the support of our Strength & Balsam of Life & upholding, is already enough demonstrated elsewhere; and in particular the same must be sought for in Tom. 1., with all diligence. If the Regions of our atmosphere has not the proportionable quantity or weight thereof, there ensues the most unhealthy times, as the Pestilence and other diseases, as also unfruitful Seasons & c. But on the other hand when the Air is richly filled herewith, so have we the Enjoyment of the most fruitful & healthy Seasons. Then at such times & Seasons, this SULPHUREOUS SALTISH MERCURIAL Matter falls in the Night with the Rays of the Sun & Moon in the surface of this Globe, and forms or coagulates therein in the Most wonderful Manner: And by the Magnetical power of the SUN by day, it is again drawn up in the form of the most subtil Atoms, and again by Night, then the Rays & Influences of the MOON and Stars, with the Moist Air that hovers over the face of the Earth, is again pressed or made to sink to quicken in the most surprising manner the Earth with all things in and on the same, with new Life and growth. And although should no Rain fall in a whole Summer, as the daily experience proves, that the Dew of the Night are of much more Virtue then the Rains are. It is then that the Rains falls in a thunder shower, which has the very same property as the

Dew: Then the Nitro Sulphureous damp, which is attracted by the Magnetical power of the Sun in the Air (with which COOPERI the central under earthly Fire and drives the same above like FIRE under a distilling vessel) and is a Wonderful powerful Magnet to attract to it, this MERCURY and falls with the Rain WATER upon the Earth to quicken and Revive whole Nature.

S. 7. The Lovers hereof will not be against our treating a little, of the Thunder & Lightning, of which indeed there is very sharp witted and Wonderful Philosophisings; seeing that by most it is a conjecture, how should they be otherwise then, that the true cause is seldom brought to Light. In the first place it is undeniable that the Thunder and Lightning is occasioned by the Nitro Sulphureous exhalations drawn from the Earth: Now the question is? Seeing the Clouds are a certain exhalation or damp, how this Nitrous Sulphureous Mixture can be concentrated in the water of the Clouds, to such a powerful and terrible effect as occasions the astonishing Crackling and Thundering? We must seek to explain this terrible Workings on explosions fundamentally, as something difficult, did not the PHOSPHORUS herein give us some assistance; all those experienced in the FIRE know well, that the same may be prepared three ways or 3 forms, as firstly there comes in the Distillation a Spiritual WATER, that Lights by night, (2) there comes into a charged Receiver, wherein there is already put WATER, a Matter over, which coagulates in the WATER as a Black reddish seed or Turnipseed, there comes in the Neck of the Retort, a smeary yellow Matter, and sets itself pretty fast thereon. When then the Work is performed, as to the first demonstration, namely, one takes the SECOND WORK on the coagulated matter in the WATER as the Phosphorus, stop the Receiver, a little, and set the same with its bottom on the palm of the Hand, & hold the same so long, till it warms, namely, the water in the Receiver, so will you see the seeds or coagulated Phosphorus Light now & then in the WATER, which is pleasant to behold in a dark place, and the operation is enough to convince one (that Artists or such like Persons hereof has not learned the Reason) namely how the Nitrous Sulphureous Essence & Corporality is Lighted in the WATER of the Clouds. The BUTRUUM PHOSPHORI that has settled in the Neck of the Retort, will serve as to a much stronger demonstration: Those who know how to prepare the same, are herein well satisfied and know that the same is also a FIRE that is not to be put out. But this is in no way seen, unless by friction, and then it Lights momentary & burns with force; that such a nether FIRE is scarcely to be found, & which can not be put out by any WATER. This Phosphorical property; has also the forementioned Nitrous SULPHUREOUS Moisture in the Clouds; then as long as the same is shut up or concealed in only one Cloud, it cannot take fire or Light, because there is no pressure or friction. But so soon as a single Cloud rubs on

presses against others, or Circulates & moves through each other, as may be seen by all Thunders, & that the same force & presses from every side, above & Below; till the SULPHUREOUS Matter kindles & Lightens with great force according as the same has become fired; Like unto a great Cannon or Instrument from the Cavities of the Clouds and shoots underwards, & all that it hits tears in Pieces and also kindles & destroys.

S. 8 & 9 are only a continuation of this Subject & betrays nothing more than this S., has already within it. (This is a note by Francis Barnett, isn't it great, that he should decide what we should or should not read?) D.H.

S. 10. Concerning the Snow, Hail & Ice, that falls to the Earth with a thunder Storm; as also without Thunder. He will very easily understand the same, that knows how through certain SALTS to make the WATER freeze in the Midst of Summer Heat, & will easily comprehend the Origin or cause of the same: But that in great Hail Stone and Showers of Ice, that usually falls with the same have been observed to have many figures & Characters, which indeed requires a little farther consideration of the cause thereof, that Heat, Cold, Snow & Ice & Hail is generated, is well known; But that this PHENOMENA is not altogether WATER, but also at the same time the same is from a very Subtile Virgin EARTH from a SALINE MERCURIAL EARTH, which is already well known to those experienced in Nature; therefore consider well the above Chap. 1., S. 21., and it will require no farther explanation.

S. 11. That this Universal MERCURY is highly necessary for the support & upholding of the Human form, has been already said above in the most concise Manner; even also is this MERCURY highly necessary for all Minerals, because the same is for the most part generated of SALT, SULPHUR & MERCURY, (yet not from the Common). As soon as a Mineral suffers a want of this MERCURY, it not only ceases to grow, but it moulders away & wholly spoils, as is well known to those universal on Metallick affairs. And therefore all Labours to help the poor Metallick Ones, is to no purpose, except the same is perfected through the Universal MERCURY. The common it is not, then although a MERCURY VULGI may be had from all Metals & Minerals, yea from all Things. Because the same may by the true art be reduced to a SALT, and lastly to WATER, such MERCURY is not their first matter but is as it were a third from the first. That the WATER is a PRINCIPUUM SECUNDARIUM, we have shown enough in the first part of this work; then in the pure & clean spring & Brook water there is daily generated pebbles Stone and those that and those that are already Large, may be the separation & Extraction produce GOLD & SILVER also IRON & COPPER, according to the Ideality, or the Ideas of the Virgin Earth in the Air or Stars and its properties; from which a Lover of truth may see, that it is not the Common. But the Original & Universal MERCURY, as the

Clefts or passages in the Bowels of the Earth, and there in this great work-shop, according to the quality of the already SPECIFIC Virgin Earth, through the under-Earthly FIRE, becomes SALT, that is ARSENICI (then all Metallick SALTS are ARSENICUM) SULPHUR & MERCURY boiled, and according to the three-fold proportion & weight in this or that Leim or Loam, is congealed to this or that Metal: And according as this or that principle has the upper hand, the Metal is light or heavy, tough or brittle; as is GOLD, SILVER, TIN, LEAD or QUICKSILVER has the upper hand, and are therefore heavy or then the others in COPPER, IRON and ANTIMONY, the SULPHUR predominates & are therefore lighter. By the great Melting FIRES One may find this true, then one sees from all sorts of Ores the ARSENICUM, that is their Metallick SALT, ascends as a thick Smoke in the Furnace & the roof tiles (which are to receive the Smoke or dust). But the SULPHUR burns glimmering from the Ores & Metals, in the form of a Blue, Red, green & brown Coloured flame and the same may be extracted also from the ANTIMONY & Cinnabar Ores in the true form of SULPHUR. But the MERCURY does not appear in the Minerals & Metals as Living, because the same is coagulated by the Ores or Metallick moisture or SULPHUR, but when the metal is by force of FIRE brought to Liquifaction or flows; the MERCURY is easily seen. The MERCURY may as is said before by the true Separating Art be brought out of the same that it remains in the Cold a natural Mercurii.

S. 13. For a further demonstration of the foregoing S., that namely according to the common Gold-boilers meaning, the Corporeal SALT, SULPHUR & MERCURY is not the true Principles of Metals and Minerals, hereby consider with all diligence, that the Gold Sand of certain Rivers, and which sand may have been washed to extract the GOLD as clean as possible, is in time again by the Wind and Weather again impregnated with GOLD; and gold may be washed even as before again from it; which is already mentioned in the first part. Where was, or where lay now, the Corporeal SALT, SULPHUR & MERCURY? In Sand? This lays on is contrary to sight and truth, therefore such must have been in the Aethereal (Weather) Influence, wherein the heavenly SULPHUR, MERCURY & SALT, (namely the very first PRINCIPIMUM had its dwelling). Here we could as it were point with the fingers, where the Universal Magnet is to be found, and how this wonderful Attraction; but because the same has no Name we must not say more of it. But yet must only so far say to the Lovers hereof, that the same lays before the Eyes of all Creatures & after or according to the Shower, may easily be seen & Known. SAPIENTE SAT.

S. 14. Even as the Mineral and Animal Kingdom cannot exist, without this Universal MERCURY, even also, may not the Vegetable Kingdom; then if this dew or Rain is wanting, with which this MERCURY comes to make fruitful, in the EARTH, then the

EARTH would not bring forth its productions, nor have power to drive those farther, that are already grown on sprung up, of which see with all diligence above Chap. 1. S. 14, 15, 16., as also the first part of SALT. How this Wonderful MERCURY is to be had and obtained for the increase of Vegetables, as also its Use, is shown enough in the other part of SULPHUR. The Common MERCURY Loves the Gold, and the Gold is also a powerful Magnet, to attract the MERCURY to it, who now knows the true Gold or SULPHUR, may masterly obtain this Universal MERCURY: Who knows that there is more than one Kingdom, as also knows the difference of the Kingdoms may also find this MINERA of Gold, what is obtained with difficulty in the one Kingdom, may be found with more ease in the other. A true Miners Knowledge consists amongst others, that he rightly knows the good Ones, as also to know the difference & not to take a declining one for ones in the ascension (or growing one) and not chuse a Poisonous Kobalt for a pure Gold One, and after these, he must also know how to prepare his One that so in the washing, roasting & meltings, N.B., not loose the least part of the Gold, and in its room chase only the Poisonous impurities: But has he by his skill and Art obtained the true pure SOL, which resembles a saltish Sulphur, & may comfort himself & perform the last that is mentioned in Genesis, viz. to Fruitify & increase in all three Kingdoms; and then will be given unto him that, which is so terribly shut up in all Metals, the Gold giving stream Pison, & of the Land of Havila, as also Bedellum & the Stone Onyx.

S. 15. When one melts a Metal, and when it is melted, only lets fall a single drop of common water in the same, it flys instantly in 10,000 particles, as is known to all the world. But why does not the same, an alcali Liquor which has been before well alcalized & flown in the FIRE: But it does not make the least attraction on the Metal nor does it cause it to fly or divide the same at all, but on the other hand it rather cleanses the metals in the flux & makes the same more malleable, which all Oils does. Answers will be presently ready from a super cunning one; namely, the secret thereof is the AETHERIAL Water. But from a fundamental Knowledge we see that it is hereby not once near the Mark, & much less to hit the same, though one that is well experienced in the true Art of separation accordingly knows well, that this Air water which the alcali has attracted, may by a particular Manual be again separated from the Alcali; which water works on a Metal in flux as even the above effect the same violence as much as the same water: What is then the Reason? That the common water from the AIR is like oil, cleanse the Metals in flux, we have, just now said this is true. And we doubt not but the most will imagine this to be a Vegetabilia, & already know it, & will not regard our answer. But those whose brains are not leanned with Aristotle & other such like with imaginary Learning, but other

wise have known the true ground of it, will easily with us, confess, that this is not so trifling a Matter, but this is a deep Mystery, who knows the true Reason, why such an alcali Liquor, does not cause such an effect in or on a Metal in flux, as a common water which tears & divides the same with an amazing force, and the same we say & Confess, that he has a Knowledge of that original Water & Universal Principle, of which this discourse is of throughout our work.

S. 16. To describe the matter plainer, would be indeed a folly, then as those experienced in nature knows it already without our explanation, but to others with their Imaginary Wisdom & who conceives they have already the fish by its tail, & which the work here would be labour lost: But to one who Loves truth, we say, that knowing & fathoming this Mystery he will not lose his labour, or apply them without obtaining his purpose, then that individual will be taught Anon, which we know not to call by any particular NAME, & therefore call the same SALT, SULPHUR & MERCURY. From the third Figure, it is easily known, and that it is described in other places, in another way, & a Mago Cabbalists will know properly how to compare & unite thereby. The more words, as used hereto the more obscure it may be made, then hereby the same may be as easily comprehended, as 2 and 3 makes 5. A mean and little regarded matter, as was observed before in the Liquor Alcali, is often the best & the most Learned Instructor: But observe this, that the AIR WATER which the alcali has attracted & is again separated therefrom, is not agreeable to the Metals in flux? But when the same was united with the alcali, the same was agreeable thereto, as its origin. But yet here is not meant the water attracted out of the air, nor yet the alcali: Who may comprehend it, Let him Comprehend it.

S. 17. An highly rectified Spirit of Wine, will not unite with the SALT OF TARTAR, as is known, but if this SALT OF TARTAR is highly sharpened through FIRE, and is after turned in a cellar to a Liquor, then distill the WATER from the same which it has attracted; & then calcine the same again in the Crucible, pulverized, & then again brought in the Cellar to a Liquor, as before & then again the AIR WATER abstracted from it, & so patiently repeated several times, so one obtains a Wonderful SALT OF TARTAR, which will mostly in the distillation Unite with the Spirit of Wine, and goes over with the same, & the more this Spirit is abstracted from the SALT OF TARTAR, the more of the same is united to the Spirit. But one must have well understood, what has been here said, because the same has been here mentioned without any particular order; 'tis true many curious have given themselves much trouble to unite the SALT OF TARTAR with the Spirit of Wine, and are therefore I know not of or from what principles fallen upon the distilled Vinegar, and have abstracted the same so long from the SALT OF TARTAR, till the same would not take any more vinegar

on itself, and is thereby unaltered, as then the SALT OF TARTAR is according to their meaning truly prepared to unite with the Spiritus Vini, but the effect has often demonstrated, that such have been deceived in their Meanings, had these good Gentry have only known the UNIVERSAL UNCORROSIVE, SHARPEST, NATURAL VINEGAR, they would not have sought the Union, in distilled Wine Vinegar.

S. 18. We have already observed in the foregoing part, that the true NITRUM is exceeding powerful for the growth or increase of Vegetables, which is impossible to be performed unless this Wonder Salt is firstly made itself truly fruitful. The common saying is: Where there is doves more doves will come. If one has the true prepared NITER, there will be no want of a matter to attract powerfully the true Universal dung on that which makes fruitful; the true SAL PETRA must be truly prepared & United through a SOUR MINERAL & THE SWEET NATURAL SALT; otherwise it is as true NITRE, the one is acid, and the other Laial, i.e., Alkali, as is represented in Fig. 4, when now the NITRE is thus prepared, so must the same be disposed through the true Chymical Art with Caspol gaffuiguzi, 98, (?) to a Magnetical fruitfulness, as then the true SAL PETRA is prepared, which performs such wonders in the Increase of Vegetables; there is many Curious that means to make the common NITRE to answer the same end, by the preparing of the same by the FIRE through the Coal dust for the increase of the foregoing Vegetables. 'Tis true the NITRE is in such a FIERY operation altered, but what it leaves in such an operation, will not be restored to it again, & therefore the desired effect does not follow, this has not only been observed here but elsewhere plainly, and think it needless to say more hereof.

S. 19. That a well Rectified Spirit of Wine will not mix with an Oleo Tartari, per deliquium is well known, as also that such an oil attracts or lays hold of Animals Vegetables and Minerals, and extracts their SULPHUR in a very soft uncorrosive way, which extract may easily be made through Spiritum Vini to a Medicinal Tincture. But that this extract may be obtained through a mean or low or common SALT OF TARTAR, we do not say, But the same must be prepared by the above mentioned NATURAL VINEGAR & S.V., and when this is well prepared, so may it give such an ALCHEMIST, and thereby noble Medicines, that the GOLDS SULPHUR is the most fixed is known to all the world, but when the same is well Calcined through common MERCURY and reduced to an Alcohol, & extracted by the above mentioned Oleum TARTAR per. deliq., it affords an extraordinary Tincture, and we have now from all metals & glassy states extracted thereby extraordinary Tinctures. That a Glassy state or seal is very fast on hard body, and therefore cannot be layed hold of by any corrosive, is well enough known, & yet we have from the Glassy Red & Blue states of COPPER through the above mentioned oil in a few hours extracted, the most beautiful Red & Blue Tinctures, & may be the

means of many serviceable inventions. This Liquor dissolves all Gems & Resinous things, in a Wonderful manner, which then affords the most beautiful and agreeable Tinctures: Yea the very delicate and grey (govey/) amber is dissolved herein better than in any other Menstruum, & reduced to a powerful Tincture, and concerning the dissolving of Pearls which we have hereby performed & could mention, was it not too prolix, who farther knows to drive this Tincture with Spiritus Vini per Retort, and will obtain something very particular or rare.

S. 20. What has been said in the foregoing concerning the oil of Tartar, we would not have so lightly thought of, But its working should be more maturely resolved & thought of, because an alcali namely the common does not perform such things, than if the same is dissolved in WATER, such solutions have not the least of the forementioned qualities in it, & more than that, the same mixes with S.V. & are then together a thick mush, would one use the alcali dry, & endeavours to bring the Metal hereby into flux, one would to ones loss experience that one has thrown away ones time, the Metal on any other thing mixed dryly with the alcali; and digested with S.V. would bring even as little profit; would one extract the WATER from the Oleo per del., which the same drawed from the AIR, & would use this WATER alone, one would in truth find the same to be of no more service than common WATER, from which it must consequently follow, that the working effect of the forementioned Liquor is nothing else then our MERCURY of which so often & much has been said of. BUT IT IS HIGHLY REQUISIT TO RIGHTLY UNDERSTAND THAT OF WHICH WE HAVE SPOKE OF, AS ALSO, RIGHTLY TO KNOW THE SAME, and in the next place it is requisit that one knows what sort of Net is necessary to catch this Wonder Bird! In whole nature, each love its like, & each matter flys from its contrary, (which antipathy is the proper cause of the motion of all Created Bodies) the desire or attraction (Sympathie) consists in a Magnetical power, but this, Namely, the Universal which has a desire to Created things, is not to be found any where but in the together flowing, of the whole Creature. Who knows to unite heaven and Earth together, may easily find this Magnet, & so that one diligently regards after the accomplished time, to separate with great caution the same from its gross Mineræ and misform or deformity, that so instead of the precious Stone Jaspis, which is transparent & Clear like unto a Diamond, you obtain Pebble Stones.

S. 21. From what has been said above concerning this wonder MERCURY, one will easily observe how highly necessary the same is to all creatures; from this first outflowing MERCURY, which is also SALT and SULPHUR is through the Fiat all Creatures in heaven, Stars, on and in the Earth; Sea, Waters, Yea Air & Fire Created or formed, & not only the Visible but the Invisible. This MERCURY is wholly turned

inward in Lucifer & all his fallen Angels, and on the other hand the sharpest; As-
 trigent, bitter, that is SALT and SULPHUR manifest in him, which has laid hands on
 this MERCURY and bound it, that so its noble and Glorious form of Light is wholly
 taken from it, before his fall it was a soft ascending Joyful Light, in a wonder-
 ful Unity of the first Principle SALT, SULPHUR & MERCURY. But after his fall this
 Unity of Light in fine, in the form of SALT & SULPHUR (which has swallowed the MER-
 CURY up in it) manifest, so that is no more a Joyful pleasant Light, but in its un-
 formable form SALT & SULPHUR, and is become to all the Earthly World with all of
 its Creatures, a destroying dark FIRE & will also remain in this deplorable form
 on state till this Glorious FIRE will find nothing more for its support or mainten-
 ance, and as then how also in itself destroying itself, namely in its damnable form,
 that so from the deformed Character, Figure 2., Tom. II., be again on return again
 to the Character Figure 12 on that is to its first Principle in the Joyful Light
 SALT, SULPHUR & MERCURY, and even as this Mercurial Light is Locked on shut up and
 turned inwards in the Devil, even also will it be with the damned in the great day
 of Judgement, namely that the Spirit, the Living Soul as the MERCURY will be by them
 wholly turned inwards, and as it were shut up; & on the other hand SALT & SULPHUR
 (soul and Body) will be alone Manifest, & be susceptible to the greatest pangs &
 Marters, like unto the Devil, till all Elementary Substance, or matter (is released
 from sins) which was occasioned by the fall of Lucifer, & by little & little be
 wholly consumed through the FIRE of Hell & this Terrible Imprisonment be destroyed,
 and all its Prisoners be again free, and the Darkness wholly disappear & the Saline
 Sulphurial Mercurial Light appears again in its original purity through & in the
 Whole Creation & all Creatures.

S. 22. But perhaps some one may ask, why the Sun and its Qualities was by the
 Ancient Astrologers called Mercurius? Although this matter belongs to the 4 follow-
 ing Chapters, yet we will answer this Question as much as may suit this place; first-
 ly know that the qualities of the Stars, which the long experience has confirmed,
 could be only known to the first Astrologers by a particular Revelation; because
 from this early knowledge so much may be known that this Science took its Rise by
 the Chaldeans, which in general was heathens, and had also no true knowledge of the
 Trinity or God, One & Three, or Father, Son and Holy Ghost, & therefore could not
 have the immediate Enlightenment upon the holy Ghost; and therefore the question is
 from whence had they such a Revelation? That so we may proceed in this matter fun-
 damentally, we must remind our readers, look to the 1st. part Chap. V., in the third
 days work whereby the Reader will remind himself, that we have shown in the same
 that the Almighty God has not left the Visible Elements void or empty as FIRE, EARTH,

WATER, AIR, but that the same are full of Creatures & that they are created from the most subtile matter of each Element, as the FIRE from the essence of the Fire, called Fire Men, as also the Rust from the WATER Men, from the EARTH MEN, & these of the AIR Men. With these Creatures or Elementary Spiritual Men, the Ancients knew how to obtain their familiarity, and was known to PLATONI CYTHRIGERA & under the Name of Generation, from whom they learnt the most hidden Secrets of Nature, as from the FIRE MEN, the properties and minutest Knowledge of the Heavens, the influences of the Stars, the individual property of the Elementary FIRE, the Nature of the inhabitants of the Stars, of upper Worlds & c., from the AIR MEN, the Nature of the Air, its use & property, the origin of the AIR signs, the Hail, Thunders, the fruitfulness of the Rain, and all that is wrought or performed in or by the AIR, from the WATER MEN the Nature of the Sea & all waters, or also of their created natures. But from the EARTH MEN the Nature of the Earth, & all Created things, both within & without, the growth and increasing of the Metals & also of their declension, the Changing of Silver & other Metals into GOLD, the properties of MERCURY, ANTIMONY and all other minerals, Vegetables and Animals, which comes from the Earth. In which knowledge those Sons of God was above measure not only experienced herein, but also learnt the same to the abovementioned Philosophers, & as many believe to Solomon himself, which is indeed contrary to the Scriptures, 2 Chap. 1., 10. 11. 12; and is a tradition & old Jewish fable. But the frequentation of these Spiritual Men & their Art, is now adays very scarce & secret. And in our many Years and Long Journeys we have not met with one, which would admit the frequentation of such Spirits, & which would be indeed to be reckoned amongst the very greatest follies, to boast of such a Knowledge. Yes such a one would be served right, for such an occasion of the fall into the Hands of the Inquisition, likewise unto their Informers or teachers, & like unto the old witches, who are damned to the fire. But more of this subject belongs not here & in the 8th. Chapter shall be treated of at Large. Who knows the Art, let him betray his Master. But hereby is to be observed highly, that all those who know the God Jehova, Father, Son and Holy Ghost, must avoid the ways of the Heathen, then all good gifts, (as also the Wisdom) come from above from the father of Light, Iac. 1. 5. 17. The Wisdom from God through the holy Ghost, is the most perfect, excellent, as also without damage & danger of the Soul. Sap. Sat.

S. 23. Having in the foregoing S. a little considered, that the Ancients obtained their Knowledge by a particular frequentation of the Elementary Spiritual Men, so is it decreed, that the Astronomy, as also the power and influences of the Stars & their heavens, was learnt from them & of consequence the Knowledge of the Star MERCURY, namely that this Star is like unto Quicksilver (which is attributed to

it) which is unconstant and changeable, capable of Receiving the Influences of all other heavenly Bodys with their preproperties, even as the Quicksilver reflects all those Colours (like unto a Glass). The Star MERCURY is in its Nature cold & moist in & on itself, with Sol & much fiery, like unto the quicksilver is outwardly Cold & flys all FIRE easily, & yet its inward property is wholly a FIRE. The same Property has the Universal Mercury, namely, Cold & Moist, & yet it is dry & hot. Yet penetrating & a wonderful Fire, Yet fly's all Elementary FIRE, from these properties. And similitudes of each other, one might in part judge why the before mentioned Star was called MERCURIUS, when we consider a little closer its abovementioned properties, we find what cause it stands between the Sun, Moon and MERCURY (we speak here with the sensible Copernicus) THAT IT IS FIRSTLY A POWERFUL RECEPTACLE OF OUR MERCURY, AND SECONDLY, BECAUSE THROUGH A CERTAIN CONSTELLATION (WHICH MUST BE KNOWN TO A TRUE ASTROLOGER) THE UNIVERSAL MERCURY MAY BE COLLECTED THROUGH SOMETHING LIKE UNTO ITSELF IN AN UNCOMMON MANNER. And from this and other reasons as also by the Radix of Heaven. But this the Ancients called this Star Mercurius, wherewith a Lover of Wisdom will for this time rest satisfied, till opportunity may furnish us with something more. Who has a holy desire for the Knowledge of these Spirits, Learn the God JEHOVAH, & how he has manifested himself in the Creation as also in us & in his Word, as also the secrecy, & learn himself, and his own temperament, as also that which he must care to avoid; which is to be learned from the contraries of the Elements, and lastly what each Element Loves, that is, himself, and what a true Philosopher may therein find as most Noble.

F I N I S .