

***iMac***<sup>®</sup>  
FOR  
**DUMMIES**<sup>®</sup>  
5TH EDITION

**by Mark L. Chambers**



WILEY

Wiley Publishing, Inc.



***iMac***<sup>®</sup>  
FOR  
**DUMMIES**<sup>®</sup>  
5TH EDITION

**by Mark L. Chambers**



WILEY

Wiley Publishing, Inc.

## iMac® For Dummies®, 5th Edition

Published by  
**Wiley Publishing, Inc.**  
111 River Street  
Hoboken, NJ 07030-5774

[www.wiley.com](http://www.wiley.com)

Copyright © 2008 by Wiley Publishing, Inc., Indianapolis, Indiana

Published by Wiley Publishing, Inc., Indianapolis, Indiana

Published simultaneously in Canada

No part of this publication may be reproduced, stored in a retrieval system or transmitted in any form or by any means, electronic, mechanical, photocopying, recording, scanning or otherwise, except as permitted under Sections 107 or 108 of the 1976 United States Copyright Act, without either the prior written permission of the Publisher, or authorization through payment of the appropriate per-copy fee to the Copyright Clearance Center, 222 Rosewood Drive, Danvers, MA 01923, (978) 750-8400, fax (978) 646-8600. Requests to the Publisher for permission should be addressed to the Legal Department, Wiley Publishing, Inc., 10475 Crosspoint Blvd., Indianapolis, IN 46256, (317) 572-3447, fax (317) 572-4355, or online at <http://www.wiley.com/go/permissions>.

**Trademarks:** Wiley, the Wiley Publishing logo, For Dummies, the Dummies Man logo, A Reference for the Rest of Us!, The Dummies Way, Dummies Daily, The Fun and Easy Way, Dummies.com, and related trade dress are trademarks or registered trademarks of John Wiley & Sons, Inc. and/or its affiliates in the United States and other countries, and may not be used without written permission. All other trademarks are the property of their respective owners. Wiley Publishing, Inc., is not associated with any product or vendor mentioned in this book.

**LIMIT OF LIABILITY/DISCLAIMER OF WARRANTY: THE PUBLISHER AND THE AUTHOR MAKE NO REPRESENTATIONS OR WARRANTIES WITH RESPECT TO THE ACCURACY OR COMPLETENESS OF THE CONTENTS OF THIS WORK AND SPECIFICALLY DISCLAIM ALL WARRANTIES, INCLUDING WITHOUT LIMITATION WARRANTIES OF FITNESS FOR A PARTICULAR PURPOSE. NO WARRANTY MAY BE CREATED OR EXTENDED BY SALES OR PROMOTIONAL MATERIALS. THE ADVICE AND STRATEGIES CONTAINED HEREIN MAY NOT BE SUITABLE FOR EVERY SITUATION. THIS WORK IS SOLD WITH THE UNDERSTANDING THAT THE PUBLISHER IS NOT ENGAGED IN RENDERING LEGAL, ACCOUNTING, OR OTHER PROFESSIONAL SERVICES. IF PROFESSIONAL ASSISTANCE IS REQUIRED, THE SERVICES OF A COMPETENT PROFESSIONAL PERSON SHOULD BE SOUGHT. NEITHER THE PUBLISHER NOR THE AUTHOR SHALL BE LIABLE FOR DAMAGES ARISING HEREFROM. THE FACT THAT AN ORGANIZATION OR WEBSITE IS REFERRED TO IN THIS WORK AS A CITATION AND/OR A POTENTIAL SOURCE OF FURTHER INFORMATION DOES NOT MEAN THAT THE AUTHOR OR THE PUBLISHER ENDORSES THE INFORMATION THE ORGANIZATION OR WEBSITE MAY PROVIDE OR RECOMMENDATIONS IT MAY MAKE. FURTHER, READERS SHOULD BE AWARE THAT INTERNET WEBSITES LISTED IN THIS WORK MAY HAVE CHANGED OR DISAPPEARED BETWEEN WHEN THIS WORK WAS WRITTEN AND WHEN IT IS READ.**

For general information on our other products and services, please contact our Customer Care Department within the U.S. at 800-762-2974, outside the U.S. at 317-572-3993, or fax 317-572-4002.

For technical support, please visit [www.wiley.com/techsupport](http://www.wiley.com/techsupport).

Wiley also publishes its books in a variety of electronic formats. Some content that appears in print may not be available in electronic books.

Library of Congress Control Number: 2008924085

ISBN: 978-0-470-13386-6

Manufactured in the United States of America

10 9 8 7 6 5 4 3 2 1



WILEY

# About the Author

**Mark L. Chambers** has been an author, computer consultant, BBS sysop, programmer, and hardware technician for more than 20 years — pushing computers and their uses far beyond “normal” performance limits for decades now. His first love affair with a computer peripheral blossomed in 1984 when he bought his lightning-fast 300 BPS modem for his Atari 400. Now he spends entirely too much time on the Internet and drinks far too much caffeine-laden soda.

With a degree in journalism and creative writing from Louisiana State University, Mark took the logical career choice: programming computers. However, after five years as a COBOL programmer for a hospital system, he decided there must be a better way to earn a living, and he became the Documentation Manager for Datastorm Technologies, a well-known communications software developer. Somewhere in between writing software manuals, Mark began writing computer how-to books. His first book, *Running a Perfect BBS*, was published in 1994 — and after a short decade or so of fun (disguised as hard work), Mark is one of the most productive and best-selling technology authors on the planet.

Along with writing several books a year and editing whatever his publishers throw at him, Mark has also branched out into Web-based education, designing and teaching a number of online classes — called *WebClinics* — for Hewlett-Packard.

His favorite pastimes include collecting gargoyles, watching St. Louis Cardinals baseball, playing his three pinball machines and the latest computer games, supercharging computers, and rendering 3-D flights of fancy with TrueSpace — and during all that, he listens to just about every type of music imaginable. Mark’s worldwide Internet radio station, *MLC Radio* (at [www.mlcbooks.com](http://www.mlcbooks.com)), plays only CD-quality classics from 1970 to 1979, including everything from Rush to Billy Joel to the Rocky Horror Picture Show.

Mark’s rapidly expanding list of books includes *MacBook For Dummies*; *Apple TV For Dummies*; *iMac For Dummies*, 5th Edition; *Mac OS X Leopard All-in-One Desk Reference For Dummies*; *Building a PC\_ For Dummies*, 5th Edition; *Scanners For Dummies*, 2nd Edition; *CD & DVD Recording For Dummies*, 2nd Edition; *PCs All-in-One Desk Reference For Dummies*, 2nd Edition; *Mac OS X Tiger: Top 100 Simplified Tips & Tricks*; *Microsoft Office v. X Power User’s Guide*; *BURN IT! Creating Your Own Great DVDs and CDs*; *The Hewlett-Packard Official Printer Handbook*; *The Hewlett-Packard Official Recordable CD Handbook*; *The Hewlett-Packard Official Digital Photography Handbook*; *Computer Gamer’s Bible*; *Recordable CD Bible*; *Teach Yourself the iMac Visually*; *Running a Perfect BBS*; *Official Netscape Guide to Web Animation*; and the *Windows 98 Troubleshooting and Optimizing Little Black Book*.

His books have been translated into 14 different languages so far — his favorites are German, Polish, Dutch, and French. Although he can't read them, he enjoys the pictures a great deal.

Mark welcomes all comments about his books. You can reach him at [mark@mlcbooks.com](mailto:mark@mlcbooks.com), or visit MLC Books Online, his Web site, at [www.mlcbooks.com](http://www.mlcbooks.com).

# Dedication

This book is dedicated to my youngest daughter, Rose Chambers — she of the Cleo Beast, the Book at Bedtime, and the Barbie blankets — with all the love and happiness I can give her.

# Author's Acknowledgments

A guide to Apple's iMac should be as elegantly designed and straightforward as the computer itself . . . and luckily, I had just the right mix of folks to make sure that it turned out that way!

First, my thanks are due to my technical editor, Greg Willmore, who kept watch on the accuracy of my facts, comments, and step-by-step procedures concerning both the Apple iMac and Mac OS X Leopard. As always, copy editor Teresa Artman lent both a superb eye and a ready sense of humor.

I've often said that Wiley's Production team is the best in the business, and the layout and composition of this book is proof positive — my appreciation to everyone who lent a hand with the graphics, proofing, and cover work for *iMac For Dummies*, 5th Edition.

As with all my books, I'd like to thank my wife, Anne; and my children, Erin, Chelsea, and Rose; for their support and love — and for letting me follow my dream!

Lastly, I'd like to thank the two editorial professionals at Wiley who made this book happen: my good friend Bob Woerner, the acquisitions editor who has guided my way through the jungle of technology yet again; and Paul Levesque, my hard-working project editor. Gentlemen, it's folks like you who make this the greatest career on the planet — my heartfelt thanks to you both from a very grateful Mac owner!

## **Publisher's Acknowledgments**

We're proud of this book; please send us your comments through our online registration form located at [www.dummies.com/register/](http://www.dummies.com/register/).

Some of the people who helped bring this book to market include the following:

### ***Acquisitions, Editorial, and Media Development***

**Senior Project Editor:** Paul Levesque

**Senior Acquisitions Editor:** Bob Woerner

**Senior Copy Editor:** Teresa Artman

**Technical Editor:** Greg Willmore

**Editorial Manager:** Leah Cameron

**Media Development Project Manager:**  
Laura Moss-Hollister

**Media Development Assistant Producer:**  
Angela Denny

**Editorial Assistant:** Amanda Foxworth

**Sr. Editorial Assistant:** Cherie Case

**Cartoons:** Rich Tennant  
([www.the5thwave.com](http://www.the5thwave.com))

### ***Composition Services***

**Project Coordinator:** Katherine Key

**Layout and Graphics:** Shane Johnson,  
Laura Pence, Ronald Terry,  
Christine Williams

**Proofreaders:** Cynthia Fields,  
Bonnie Mikkelson

**Indexer:** WordCo Indexing Services

**Special Help**  
Alissa D. Ellet

---

## **Publishing and Editorial for Technology Dummies**

**Richard Swadley**, Vice President and Executive Group Publisher

**Andy Cummings**, Vice President and Publisher

**Mary Bednarek**, Executive Acquisitions Director

**Mary C. Corder**, Editorial Director

## **Publishing for Consumer Dummies**

**Diane Graves Steele**, Vice President and Publisher

**Joyce Pepple**, Acquisitions Director

## **Composition Services**

**Gerry Fahey**, Vice President of Production Services

**Debbie Stailey**, Director of Composition Services



# Contents at a Glance

---

<b><i>Introduction</i></b> .....	<b>1</b>
<b><i>Part I: Know Your iMac</i></b> .....	<b>7</b>
Chapter 1: Okay, This Machine Looks Really, Really Weird .....	9
Chapter 2: Life! Give My iMac Life! .....	27
Chapter 3: Introducing the Apple of Your iMac .....	37
<b><i>Part II: Shaking Hands with Mac OS X</i></b> .....	<b>47</b>
Chapter 4: Opening and Closing and Clicking and Such .....	49
Chapter 5: A Plethora of Powerful Fun .....	69
Chapter 6: A Nerd's Guide to System Preferences .....	85
Chapter 7: Searching amidst iMac Chaos .....	101
<b><i>Part III: Connecting and Communicating</i></b> .....	<b>111</b>
Chapter 8: Let's Go on Safari!.....	113
Chapter 9: Moving to .Mac .....	129
Chapter 10: Hooking Up with Handy Helpers .....	141
<b><i>Part IV: Living the iLife</i></b> .....	<b>151</b>
Chapter 11: The Multimedia Joy of iTunes .....	153
Chapter 12: The Masterpiece That Is iPhoto .....	179
Chapter 13: Making Film History with iMovie .....	201
Chapter 14: iDVD — Your DVD Movie Factory .....	219
Chapter 15: Recording Your Hits with GarageBand .....	241
<b><i>Part V: Sharing Access and Information</i></b> .....	<b>263</b>
Chapter 16: Creating a Multiuser iMac .....	265
Chapter 17: Building (Or Joining) a Network.....	283
<b><i>Part VI: The Necessary Evils: Troubleshooting, Upgrading, Maintaining</i></b> .....	<b>305</b>
Chapter 18: It Just . . . Sits . . . There.....	307
Chapter 19: I Want to Add Stuff .....	323
Chapter 20: Tackling the Housekeeping .....	333

<b><i>Part VII: The Part of Tens</i></b> .....	<b>347</b>
Chapter 21: Ten Applications You Can't Do Without .....	349
Chapter 22: Ten Ways to Speed Up Your iMac .....	359
Chapter 23: Ten Things to Avoid Like the Plague .....	367
<b><i>Index</i></b> .....	<b>375</b>

# Table of Contents

.....

<b><i>Introduction</i></b> .....	<b>1</b>
What's Really (Not) Required .....	2
About This Book.....	2
Conventions Used in This Book .....	3
Stuff you type .....	3
Menu commands .....	3
Web addresses .....	3
For the technically curious .....	3
How This Book Is Organized.....	4
Part I: Know Your iMac .....	4
Part II: Shaking Hands with Mac OS X.....	4
Part III: Connecting and Communicating.....	4
Part IV: Living the iLife.....	4
Part V: Sharing Access and Information .....	5
Part VI: The Necessary Evils: Troubleshooting, Upgrading, Maintaining.....	5
Part VI: The Part of Tens .....	5
Icons Used in This Book.....	5
Where to Go from Here.....	6
A Final Word.....	6

## ***Part I: Know Your iMac*** ..... **7**

<b>Chapter 1: Okay, This Machine Looks Really, Really Weird</b> .....	<b>9</b>
An Introduction to the Beast .....	10
Major parts of your major appliance .....	10
Important Hidden Stuff .....	15
Choosing a Home for Your New Pet.....	16
Picking the right location .....	17
Considering the convenience factor .....	18
Unpacking and Connecting .....	18
Unpacking your iMac For Dummies .....	18
Connecting cables like a true nerd.....	19
Discovering All the Cool Things You Can Do.....	21
What software do I get? .....	21
Looking forward to fun on the Internet .....	22
Applications that rock .....	23
Would you like to play a game? .....	24
Stuff You Oughta Buy Right Now.....	24



**Chapter 2: Life! Give My iMac Life! . . . . . 27**

Throwing the Big Leaf Switch .....27  
Mark's Favorite Signs of a Healthy iMac .....28  
Harriet, It's Already Asking Me Questions! .....29  
    Setting up Mac OS X Leopard .....29  
    Registering your Mac .....31  
Importing Documents and Data from Your Old Mac .....31  
Importing Documents and Data from Windows .....35

**Chapter 3: Introducing the Apple of Your iMac . . . . . 37**

A Quick Tour about the Premises .....38  
    The Leopard Desktop.....38  
    What's going on underneath? .....41  
    Similarities with That Windows Behemoth.....42  
Calling for Help .....44  
    The Leopard built-in Help system .....44  
    The Apple Web-based support center .....45  
    Magazines .....45  
    Mac support Web sites .....45  
    Mac newsgroups on Usenet .....45  
    Local Mac user groups.....46

***Part II: Shaking Hands with Mac OS X . . . . . 47***

**Chapter 4: Opening and Closing and Clicking and Such . . . . . 49**

Working within the Finder.....49  
Mousing in a Mac World .....52  
Launching and Quitting for the Lazy iMac Owner .....53  
Juggling Folders and Icons.....56  
    A field observer's guide to icons .....56  
    Selecting items .....59  
    Copying items .....60  
    Moving things from place to place .....62  
    Duplicating in a jiffy .....62  
Keys and Keyboard Shortcuts to Fame and Fortune.....63  
    Special keys on the keyboard .....63  
    Using Finder and application keyboard shortcuts.....64  
Performing Tricks with Finder Windows .....65  
    Scrolling in and resizing windows .....65  
    Minimizing and restoring windows .....66  
    Moving and zooming windows .....67  
    Closing windows .....68

**Chapter 5: A Plethora of Powerful Fun . . . . . 69**

Home, Sweet Home Folder .....69  
Arranging Your Desktop .....72

Putting the Dock to the Test .....	74
Adding Dock icons .....	74
Removing Dock icons.....	75
Using Dock icon menus .....	75
What's with the Trash?.....	76
Working Magic with Dashboard, Exposé, and Spaces .....	77
Using Dashboard .....	77
Switching between apps with Exposé.....	79
Switching between desktops with Spaces.....	80
Printing within Mac OS X .....	82
<b>Chapter 6: A Nerd's Guide to System Preferences .....</b>	<b>85</b>
A Not-So-Confusing Introduction .....	85
Searching for Settings.....	87
Popular Preference Panes Explained.....	88
The Displays pane .....	89
The Desktop & Screen Saver pane .....	90
The Exposé & Spaces pane .....	92
The Appearance pane.....	94
The Energy Saver pane .....	95
The Dock pane .....	96
The Sharing pane.....	97
The Time Machine pane .....	98
<b>Chapter 7: Searching amidst iMac Chaos .....</b>	<b>101</b>
Spotlight Explained.....	101
Searching with Spotlight.....	103
Working with Spotlight matches .....	105
Fine-tuning Spotlight in System Preferences .....	106
Searching the Old-Fashioned Way.....	108
With Widgets, the Internet is Your Resource.....	109
<b><i>Part III: Connecting and Communicating.....</i></b>	<b>111</b>
<b>Chapter 8: Let's Go on Safari! .....</b>	<b>113</b>
It Doesn't Even Look Like That Other Web Browser .....	113
Visiting Web Sites.....	115
Basic Navigation While on Safari .....	116
Setting Up Your Home Page .....	118
Adding and Using Bookmarks .....	120
Downloading Files .....	121
Using Subscriptions and History .....	122
Tabs Are Your Browsing Friends.....	123
Saving Web Pages.....	124

Protecting Your Privacy .....	125
Yes, there are such things as bad cookies .....	125
Cleaning your cache.....	127
Handling ancient history .....	127
Avoiding those @*!^%\$ pop-up ads.....	127
<b>Chapter 9: Moving to .Mac .....</b>	<b>129</b>
Wait a Minute: Where Exactly IS My .Mac Storage? .....	129
Opening a .Mac Account .....	131
iDisk . . . iGetIt!.....	132
It's all in the folders.....	133
Mirror, mirror, on your drive . . . .....	134
Monitoring and configuring your iDisk.....	136
Backing Up Your Treasured Stuff .....	137
Installing Backup .....	137
Saving your stuff.....	137
Publishing a Web Site with HomePage .....	138
<b>Chapter 10: Hooking Up with Handy Helpers .....</b>	<b>141</b>
Connecting Printers .....	141
USB printers .....	141
Network printers .....	144
Connecting Scanners .....	144
Using Photo Booth and Front Row.....	145
Capturing the moment with Photo Booth.....	146
Controlling your iMac remotely with Front Row.....	148
Turning Your iMac into a TV — And More.....	150
<b>Part IV: Living the iLife .....</b>	<b>151</b>
<b>Chapter 11: The Multimedia Joy of iTunes .....</b>	<b>153</b>
What Can I Play on iTunes?.....	153
Playing an Audio CD .....	155
Playing Digital Audio and Video .....	156
Browsing the Library .....	158
Finding songs in your Music Library .....	159
Removing old music from the Library.....	160
Watching video .....	160
Keeping Slim Whitman and Slim Shady Apart:	
Organizing with Playlists .....	160
Know Your Songs .....	162
Setting the song information automatically.....	163
Setting or changing the song information manually.....	163
Ripping Audio Files .....	165
Tweaking the Audio for Your Ears .....	166

A New Kind of Radio Station.....	168
iTunes Radio .....	168
Tuning in your own stations .....	169
Radio stations in your Playlists .....	170
iSending iStuff to iPod .....	171
Sharing Your Media across Your Network .....	172
Burning Music to Shiny Plastic Circles.....	172
Feasting on iTunes Visuals.....	174
Buying Digital Media the Apple Way.....	176
<b>Chapter 12: The Masterpiece That Is iPhoto .....</b>	<b>179</b>
Delving into iPhoto .....	179
Working with Images in iPhoto.....	181
Import Images 101 .....	182
Organize mode: Organizing and sorting your images.....	183
Edit mode: Removing and fixing stuff the right way .....	190
Producing Your Own Coffee-Table Masterpiece.....	193
Introducing Web Gallery!.....	195
Mailing Photos to Aunt Mildred .....	198
<b>Chapter 13: Making Film History with iMovie .....</b>	<b>201</b>
Shaking Hands with the iMovie Window .....	201
A Bird's-Eye View of Moviemaking.....	204
Importing the Building Blocks .....	205
Pulling in video clips .....	205
Making use of still images .....	207
Importing and adding audio from all sorts of places.....	208
Building the Cinematic Basics .....	211
Adding clips to your movie .....	211
Removing clips from your movie .....	212
Reordering clips in your movie .....	213
Editing clips in iMovie .....	213
Transitions for the masses .....	214
Even Gone with the Wind had titles.....	215
Sharing Your Finished Classic with Others.....	216
<b>Chapter 14: iDVD — Your DVD Movie Factory .....</b>	<b>219</b>
Hey, Where's the Complex Window? .....	220
Starting a New DVD Project .....	222
Creating a new project.....	222
Opening an existing project .....	223
Automating the whole darn process.....	223
Creating a DVD from Scratch .....	224
Choosing just the right theme .....	224
Adding movies .....	226
Great! Now my audience demands a slideshow! .....	229
Now for the music . . . ..	230

Giving Your DVD the Personal Touch .....	231
Using Uncle Morty for your DVD Menu background .....	231
Adding your own titles .....	232
Changing buttons like a highly paid professional .....	232
Give my creation motion! .....	233
Previewing Your Masterpiece .....	234
A Word about Automation .....	235
One-click paradise with OneStep DVD .....	235
Exercising control with Magic iDVD .....	236
Recording a Finished Project to a Shiny Disc .....	238

## **Chapter 15: Recording Your Hits with GarageBand ..... 241**

Shaking Hands with Your Band .....	242
Composing and Podcasting Made Easy .....	244
Adding tracks .....	245
Choosing loops .....	248
Resizing, repeating, and moving loops .....	251
Using the Arrange track .....	254
Tweaking the settings for a track .....	256
Automatic Composition with Magic GarageBand .....	258
Sharing Your Songs and Podcasts .....	259
Creating MP3 and AAC files .....	259
Sending a podcast to iWeb or iTunes .....	261
Burning an audio CD .....	261

## ***Part V: Sharing Access and Information ..... 263***

### **Chapter 16: Creating a Multiuser iMac ..... 265**

Once Upon a Time (An Access Fairy Tale) .....	265
Big-Shot Administrator Stuff .....	266
Deciding who needs what access .....	267
Adding users .....	268
Modifying user accounts .....	270
I banish thee, Mischievous User! .....	272
Setting up Login Items and Parental Controls .....	273
Multiuser Rules for Everyone .....	277
Logging on and off in Leopard For Dummies .....	278
Interesting stuff about sharing stuff .....	280
Encrypting your Home folder can be fun .....	281

### **Chapter 17: Building (Or Joining) a Network ..... 283**

What Exactly is the Network Advantage? .....	283
The Great Debate: Wired versus Wireless .....	284
Sharing Internet Access .....	286
Using your iMac as a sharing device .....	286
Using a dedicated Internet sharing device .....	288



What Do I Need to Connect?.....289  
     Wireless connections .....289  
     Wired connections .....294  
 Connecting to the Network.....297  
     Verifying that the contraption works.....298  
     Sharing stuff nicely with others.....300  
 USE YOUR FIREWALL! .....303

***Part VI: The Necessary Evils: Troubleshooting, Upgrading, Maintaining .....305***

**Chapter 18: It Just . . . Sits . . . There . . . . .307**

Can You Troubleshoot? Yes, You Can!.....307  
 Basic Troubleshooting 101.....308  
     The Number One Rule: Reboot!.....308  
     Special keys that can come in handy.....310  
     All hail Disk Utility, the troubleshooter’s friend.....311  
     Mark’s iMac Troubleshooting Tree .....314  
 Okay, I Kicked It, and It Still Won’t Work .....320  
     Apple Help Online .....320  
     Local service, at your service.....320

**Chapter 19: I Want to Add Stuff . . . . .323**

More Memory Will Help .....323  
     Figuring out how much memory you have .....324  
     Installing memory modules.....325  
 Can I Upgrade My Hard Drive? .....328  
     Consider your external options.....329  
     Gotta have internal.....331  
 Attractive Add-Ons .....332  
     Game controllers .....332  
     Video controllers .....332  
     Audio hardware .....332

**Chapter 20: Tackling the Housekeeping . . . . .333**

Cleaning Unseemly Data Deposits .....333  
     Getting dirty (Or, cleaning things the manual way).....334  
     Using a commercial cleanup tool .....336  
 Backing Up Your Treasure.....337  
 Saving Files.....338  
     Backing up to an external hard drive.....338  
     Backing up to CD and DVD.....338  
 Putting Things Right with Time Machine.....339  
 Maintaining Hard Drive Health .....341

Automating Those Mundane Chores .....	342
Creating an application in Automator .....	343
Running applications at start up .....	345
Updating Mac OS X Automatically .....	345

## ***Part VII: The Part of Tens.....347***

### **Chapter 21: Ten Applications You Can't Do Without .....349**

Applications .....	349
DVDs and CDs .....	350
Management and communication .....	351
Productivity.....	353
System Stuff .....	355
Maintenance.....	355
Files .....	356

### **Chapter 22: Ten Ways to Speed Up Your iMac .....359**

Nothing Works Like a Shot of Memory.....	360
Hold a Conversation with Your iMac .....	360
Vamoose, Unwanted Fragments! .....	361
Keep Your Desktop Background Simple.....	362
Column Mode is for Power Users.....	362
Make the Dock Do Your Bidding.....	363
It All Started with Keyboard Shortcuts .....	363
Hey, You Tweaked Your Finder!.....	364
Keep in Touch with Your Recent Past .....	364
Go Where the Going Is Good.....	365

### **Chapter 23: Ten Things to Avoid Like the Plague .....367**

Man, That Is the Definition of Sluggish.....	368
Phishing Is No Phun.....	368
Put Floppy Disks to Rest .....	369
Do You Really Want a Submerged Keyboard?.....	370
Don't Use Antiquated Utility Software.....	370
Don't Endorse Software Piracy.....	371
Call It the Forbidden Account .....	371
Don't Settle for a Surge Suppressor .....	372
Refurbished Hardware Is No Deal at All .....	372
iMacs Appreciate Cleanliness.....	373

## ***Index.....375***

# Introduction

---

**S**keptical about your new anodized aluminum iMac, with that super-charged Intel Core 2 Duo processor? Perhaps you're thinking it's too doggone thin, or you're wondering where all the buttons are. Shouldn't there be places to plug cables? And where the heck is the DVD drive you paid for? (Oh, there it is, on the side, at the top right.)

Ladies and gentlemen, I have great news for you: Not only did you make The Right Decision about which computer to buy — you shot a hole in one! The aluminum iMac does indeed look much different from the boring beige and black boxes of the Windows bourgeoisie, but it also has everything a computer power user could want: speed, the latest in hardware and standards, a top-of-the-line LCD screen, and all the connectors you need to add just about any device meant for today's computers. And all packaged in a svelte, foxy form that borders on modern art. This is one looker of a computer.

In addition to your iMac Core 2 Duo having doggone nearly everything you could ever want (okay, I still don't see a frozen yogurt dispenser), here's what it doesn't have: **bulk**. Boasting the smallest *footprint* — the amount of desktop space — of any high-end computer available today, your iMac can practically fit on an end table!

I wrote this book especially for the proud Core 2 Duo iMac owner who wants to make the most of this new stunning aluminum computer, so this book is a guide to both the iMac hardware and *Leopard*, the latest version of Apple's superb Mac OS X (operating system). I start by describing the basics that every iMac owner should know and then move on to chapters devoted to the software that comes with your iMac. Along the way, you come across a generous sprinkling of power user tips and tricks that save you time, effort, and money.

Like my half-dozen other *For Dummies* titles, I respect and use the same English language you do, avoiding jargon, ridiculous computer acronyms, and confusing techno-babble whenever possible. (Plus, I try to bring out the humor that's hidden inside every computer. Discovering how to use your iMac should be fun and not a chore!)

## What's Really (Not) Required

If you're not an engineer with a degree in Advanced Thakamology — imagine that — no need to worry! Here's a reasonably complete list of what's not required to use this book:

- ✔ I make no assumptions about your previous knowledge of computers and software. I start at the beginning, where every book should start.
- ✔ Still considering buying an iMac? Heck, you don't even need the computer! If you're evaluating whether the new iMac is right for you, this book is a great choice. I introduce you to both the hardware and software you get so you can easily determine whether the iMac is the machine for you. (It is. Trust me.)
- ✔ Upgrading from the monster that is Windows XP (or the black hole that is Vista)? I've got tips, tricks, and entire sections devoted to those hardy pioneers called *Switchers!* You can see all about the similarities and differences between the two operating systems as well as how you can make the switch as easy and quick as possible.
- ✔ If your friends and family told you that you're going to spend half your life savings on software — or that no “decent” software is available for Mac computers — just smile quietly to yourself! These are two persistent myths about Mac computers, and those same folks are going to be blown away by the images, music, movies, and documents you produce. (Oh, by the way, the iMac comes complete with about a ton more software than any Windows box, and the iLife '08 suite of applications is better than anything available on a PC!) To sum it up: *You can do virtually everything in this book with the software that came with your iMac!*

So what is required? Only your aluminum iMac computer and the desire to become a *power user* (someone who produces the best work in the least amount of time, and has the most fun doing it)!



This book was written using the latest Intel Core 2 Duo iMac computer, so owners of older iMac computers might not be able to follow along with everything I cover. If you upgraded an older iMac G5 or Intel iMac with Mac OS X Leopard and the iLife '08 application suite, you should be able to use most of the book with no problem!

## About This Book

Each chapter in this book is written as a reference on a specific hardware or software topic. You can begin reading anywhere you like because each chapter is self-contained. However, I recommend that you read the book from front to back because the order of this book makes a great deal of sense.

---

## *Conventions Used in This Book*

Even with a minimum of techno-speak, this book needs to cover the special keys that you have to press or menu commands that you have to choose in order to make things work — hence this short list of conventions.

### *Stuff you type*

If I ask you to type (or enter) something, like in a text box or field, that text appears in bold, like this:

**Type me.**

If I ask you to type a command within Mac OS X, that text appears like this:

Type me.



You usually have to press the Return key before anything happens when entering a manual command.

### *Menu commands*

I list menu paths and commands, using this format:

Edit⇨Copy

This example of shorthand menu instruction indicates that you should click the Edit menu and then choose the Copy menu item.

### *Web addresses*

No up-to-date book on a computer would be complete without a bag full of Web addresses for you to check out. When you see these in the text, they look like this: [www.mlcbooks.com](http://www.mlcbooks.com).

### *For the technically curious*

Your iMac is an elegant and sophisticated machine — and as easy-to-use as a computer can be — but from time to time, you might be curious about the technical details surrounding your hardware and software. (You probably disassembled alarm clocks as a kid, like I did.) Tangential techy stuff is pre-

sented in sidebars, and you don't have to read them unless you want to know what makes things tick. (Pun by accident.)

## *How This Book Is Organized*

After careful thought (read that *flipping a coin*), I divided this book into seven major parts — plus an index, just because you deserve one! For your convenience, cross-references to additional coverage of many topics are also sprinkled liberally throughout the book.

The Seven Parts Shall Be the following.

### *Part I: Know Your iMac*

This part introduces you to the important features of your iMac — like where all the cables connect (or don't) — and helps you set up your system. I also introduce *Mac OS X Leopard*, the Apple operating system that comes preinstalled on your aluminum iMac.

### *Part II: Shaking Hands with Mac OS X*

Time to familiarize you with Leopard — how to take care of mundane chores (like moving your stuff) as well as how to customize and personalize your system until it fits like the proverbial glove! Switchers from the PC world will be especially interested in mastering the ins and outs of Mac OS X. (Psst. Friends, it ain't hard. The Mac started out easier to use than a Windows PC, and that has not changed.)

### *Part III: Connecting and Communicating*

Time to jump into the one application you're likely to use every single day: your Safari Web browser! You can also read here about Apple's .Mac Internet subscriber service and how to connect your iMac for printing, scanning, videoconferencing, and faxing. (I told you this thing was powerful, didn't I?)

### *Part IV: Living the iLife*

Ah, readers, you can begin humming happily to yourself right this second! Yep, this part provides coverage of the latest iLife '08 release, with the names that are the envy of the Windows crowd: iTunes, iPhoto, iMovie, iDVD, and

GarageBand. You see how to turn your iMac into the hub for all your digital media. Whether you listen to it, display it, compose it, or direct it, this part of the book explains it!

## *Part V: Sharing Access and Information*

In Part V, I discuss how to share your iMac among a group of people or how to connect your iMac to a network. (Wired or wireless, makes no difference to me!)

## *Part VI: The Necessary Evils: Troubleshooting, Upgrading, Maintaining*

This is the stuff my Dad used to call the “Justin Case Guide.” That is, *just in case* you want to upgrade your iMac with more memory or new hardware. If you need to troubleshoot a problem with your hardware or software, my should-be-patented troubleshooting guide resides in this part. Finally, I describe what you can do to help keep your iMac running as fast and as trouble free as the day you took it out of the box!

## *Part VII: The Part of Tens*

The three chapters that make up the famous “Part of Tens” section are served in classic Late Night style: Each chapter contains a quick reference of tips and advice on a specific iMac topic. Each list has ten concise tips, and one or two readers have told me that they make excellent tattoos. (Personally, I’m not *that* much of a Mac guru.)



If you’re dying to find out how to share data among wireless devices via Bluetooth technology and iSync — or how to broadcast your music around your house like Wolfman Jack — check out the handy Bluetooth and Wireless bonus chapter at the MLC Books Online Web Site ([www.mlcbooks.com](http://www.mlcbooks.com)).

## *Icons Used in This Book*

Like other technology authors, I firmly believe that important nuggets of wisdom should **stand out on the page!** With that in mind, this *For Dummies* book includes a number of margin icons for certain situations:



This is the most popular icon in the book, and you find these parked next to suggestions that I make to save you time and effort (and even cash!).



You don't have to know this stuff, but the technologically curious love high-tech details. (Of course, we're great fun at parties, too.)



**Always read the information for this icon first!** I'm discussing something that could actually harm your hardware or throw a plumber's helper into your software.



Consider these nuggets as highlighter stuff — not quite as universally accepted (or as important to the author) as a Mark's Maxim but good reminders nonetheless. I use these icons to reinforce what you should remember.



These nuggets are easily spotted; just look for the likeness of my rugged, iMac-lovin' mug. These are My Favorite Recommendations. In fact, I'll bet just about any iMac power user would tell you the same. Follow my Maxims to avoid the quicksand and pitfalls that I've encountered with all sorts of Macs for well over a decade!

## Where to Go from Here

My recommendations on how to proceed? You know, I just happen to have three:

- ✓ If you're thinking about buying a new iMac, the box is still unopened in your living room, or you'd like help setting things up, I would start with Part I.
- ✓ If your iMac is already running but you'd like guidance with running Mac OS X — Windows Switchers, take note — start with Part II.
- ✓ For all other concerns, use the index or jump straight to the chapter you need. (You can always return later, at your leisure.)

## A Final Word

I'd like to thank you for buying this book, and I hope that you find *iMac For Dummies*, 5th Edition, valuable! With this book in hand, I believe that you and your aluminum iMac supercomputer will bond together as I have with mine. (That sounds somewhat wrong, but it's *really* not.) And with that in mind, a concluding Mark's Maxim (and the first in the book):



Take your time. Finding out how to use your computer isn't a race. And don't worry if you're not a graphic artist, a professional photographer, a video editor, a programmer, or a mind reader. With your iMac and its software, you don't *have* to be!<sup>TM</sup>



# Part I

# Know Your iMac

The 5<sup>th</sup> Wave

By Rich Tennant



"Phillip just got a new redesigned iMac and gave me his old one to use."

## *In this part . . .*

**Y**our iMac odyssey begins with a description of the computer itself, as well as the details you need to know when unpacking and setting up your newest family member. You also find an introduction to *Mac OS X Leopard*, the latest version of Apple's super-popular operating system.

## Chapter 1

# Okay, This Machine Looks Really, Really Weird

---

### *In This Chapter*

- ▶ Identifying the important parts of your iMac
  - ▶ Locating the right home for your computer
  - ▶ Plugging stuff in and getting hooked up
  - ▶ Playing with your bundled software
  - ▶ Buying additional stuff that you might need
- 

**Y**ou bought a brand-new iMac, and there it sits, in the box. Waiting. Waiting for you.

If you're a little nervous about unpacking that shiny aluminum-and-glass rectangle, I completely understand. Face it: The latest iMac follows in the footsteps of many revolutionary iMac designs that have come before it. (In other words, it doesn't *look* like a computer at all, and that can be a bit disconcerting.) And if you're switching from a Windows PC to the Apple universe, you might find yourself floating weightlessly in your office or your living room without a familiar bulky beige box to anchor yourself. Hence the reluctance you might be feeling.

However, dear reader, let me assure you that you've indeed made The Right Choice. I commend you! The aluminum Intel iMac is the fastest, leanest, and easiest-to-use self-contained all-in-one computer ever built. Practically everything's in one shining panel (except for your keyboard and mouse). You've got one of the best liquid crystal display (LCD) screens on the planet, a super-fast processor, room for a ton of RAM (memory), and a regular laundry list of the latest technology. Best of all, you don't have to be a techno-nerd to use all that power!

In this chapter, I introduce you to your new dream machine, giving you an overview of the more important locations within iMac City. I show you how to unpack your new computer, what wires go where, and where your iMac

should set up housekeeping. I preview the awesome software that's waiting within that powerful panel. Finally, I list the accessories that help keep both you *and* your new iMac computing smoothly.

## *An Introduction to the Beast*

The Intel iMac might look like a sculpture straight out of your local museum of modern art, but it still sports everything that it needs to function as a computer. In this section, I identify the important stuff that you need to live your life — you know, write a term paper in Pages, hear the music you downloaded, or manage the affairs of those lazy Sims.

### *Major parts of your major appliance*

Every computer requires some of the same gizmos. Figure 1-1 helps you track them down. Of course, as you'd expect, a computer has a “body” of sorts in which all the innards and brains are stored (the screen, in this case), a display screen, a keyboard, a mouse/pointing device, and ports for powering and exchanging data with peripherals.

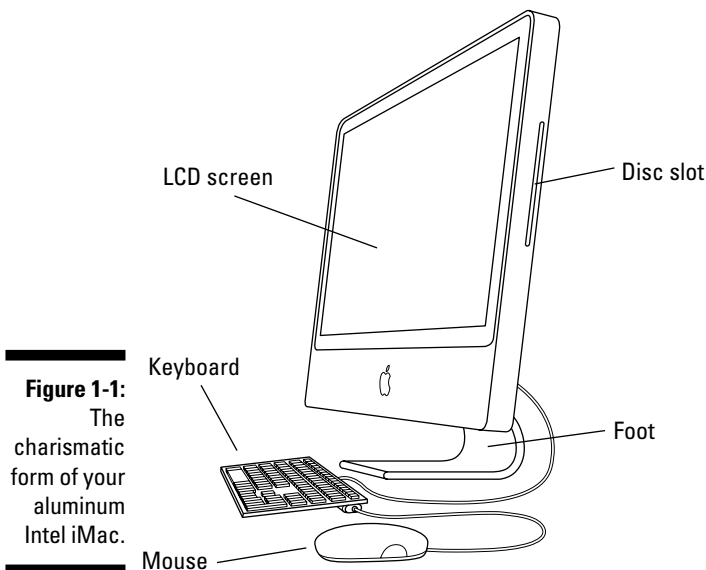

**Figure 1-1:**  
The  
charismatic  
form of your  
aluminum  
Intel iMac.

## Umm . . . my iMac isn't aluminum

Believe me, I feel your pain. It seems like only yesterday that Apple introduced its first generation of flat-panel iMac G4 models. (You know, the ones that look like a milky-white, half-basketball at the base.) The crew at Cupertino tends to update their product line pretty often, so if you have an older flat-panel iMac, you might be feeling like an Edsel owner on his way to catch *Vertigo* at the drive-in.

Ah, but friend, there's good news on your horizon: *Those first-generation flat-panel iMacs are still powerful personal platforms for productivity programs and peripherals!* Don't give up on

your older iMac yet (unless you just plain want to upgrade). You still have a great LCD screen of the same quality, a reasonably fast processor, virtually all the same ports and options, and that spiffy chrome-plated gooseneck to boot.

The same rule applies for the more recent (and much more powerful) iMac G5, which can easily run Mac OS X Leopard and handles just about anything except the latest games and the most in-depth video editing. Keep it and follow along, and you'll be able to use just about every bit this book with aplomb.

### *That magnificent screen*

Talk about efficiency: With the iMac, the 2"-thick border surrounding the display is actually your computer's case! And what a view you've got because an aluminum iMac is graced with either a 20" or 24" LCD display.



Once upon a time, LCD screens were strictly limited to notebook and laptop computers, whilst desktop computer owners were saddled with huge, heavy cathode ray tube (CRT) monitors. Luckily, the LCD panel has migrated to virtually all the Apple computer product line, so notebook owners can no longer be snobbish (at least about their screens, anyway). LCD screens use far less electricity than their antique CRT ancestors, and they emit practically no radiation.

Both sizes of iMac screens offer a *widescreen* aspect ratio (the screen is considerably wider than it is tall), which augurs well for those who enjoy watching DVD movies. (A favorite editor of mine loves it when I use the antique word *augur*, meaning *to predict or foretell*.) For example, the 24" screen boasts a whopper 1920 x 1200 resolution.



That reminds me: Throw away your printed dictionary! You won't need it because Mac OS X Leopard includes the fantastic Dictionary widget that uses the Internet to retrieve definitions from Dictionary.com. More on the Dictionary widget in Chapter 7 . . . and yes, it does contain *augur*.

### *The keyboard and mouse*

Hey, here's something novel for the Intel iMac — something *external* (outside the computer's case). Gotta have a keyboard and mouse, right? And you gotta love the options with iMac: You can fly a little cheaper and remain entangled in a corded world, or you can go nomadic . . . um, that is, wireless and free.

#### Getting wired

The iMac comes standard with a wired Apple keyboard and Mighty Mouse optical mouse. The keyboard is a particular favorite of mine because from here

- ✔ You can either control the sound volume (using the volume control buttons F11 and F12) or mute all that noise completely (using the Mute button F10).
- ✔ A handy-dandy Media Eject key lets you eject a CD or DVD.

Read about connecting your keyboard and mouse in the upcoming section, “Absolutely essential connections.”

#### Going wireless

If you're really fancy, you can opt for a truly 21st century computer and order the Apple wireless keyboard (\$79) and mouse (\$69) combo! This dynamic duo lets you sit back and relax with your keyboard in your lap, without being tied down by a cord. (Say it with me: “Death to cords, death to cords.”) Just stay within about 30 feet of your iMac screen, and sweet freedom is yours. You can also feel safe using these wireless peripherals because they offer secure 128-bit, over-the-air encryption, which helps keep sensitive information safe while you type and click away. One downside about the wireless keyboard, though: Unlike the standard Apple wired keyboard, the wireless model doesn't include any USB ports.



The wireless mouse needs a flat surface, but that's what TV trays are for, right?

### *The disc slot*

You'll notice a long groove on the right edge of your iMac. No, it's not for your credit card. (If you order online often enough, you'll memorize your card number.) This slot accepts CDs and DVDs into your optical drive. If the drive is empty, loading a disc is as simple as sliding it in an inch or so; the drive sucks in the disc automatically. (And we don't need no stinkin' floppy drive. Macs haven't had floppy drives for years now, and the PC types are just beginning to follow.)



“Luke, the printed label side of the disc should always be *facing you* when you load a disc. Always.”

### ***Yes, your computer has a foot . . . just one***

You and I — normal human beings — would say that the iMac is supported by a sturdy aluminum stand, but Apple calls it a *foot*. The foot lets you tilt the iMac LCD panel up and down for the best viewing angle. Most important, though, the foot minimizes the computer's desk space requirements (or its *footprint*). (Engineers . . . sheesh.) And yes, that foot is perfectly balanced and quite stable, so there's no danger of your treasured iMac taking a dive.

If you decide to get really snazzy and mount your 24-inch iMac to the wall, you can remove the foot and install the VESA mounting adapter (available separately for about \$30). You can use any VESA standard mounting bracket on your wall, too. You can be positioned within 30 yards or so of your wall-mounted iMac with a wireless Apple keyboard and mouse.

Hey, Hewlett-Packard or Dell, can you mount one of those monolithic PCs to the wall? *I think not.*

### ***Food for your ears***

A machine this nice had better have great sound, and the iMac doesn't disappoint. You have a couple of options for iMac audio:

- ✔ **The iMac sports built-in stereo speakers (and a microphone to boot)**
- ✔ **Use built-in ports to connect your iMac audio to either**
  - More powerful (and more expensive) external speaker systems
  - A home stereo system

### ***The power cable***

Sorry, but you can't get a wireless power system . . . yet. (Apple's working hard on that one.) If you opt for the wireless keyboard and mouse setup (see the earlier section, "Going wireless"), the power cable is actually the only required cable that you need to run your computer! Now that's *sassy*.

### ***The power button***

Yep, you've got one of these, too. It's on the back of the case.

### ***Those holes are called ports***

Our next stop on your tour of Planet iMac is Port Central — that row of holes on the back of your computer (see Figure 1-2). Each port connects a different type of cable or device, allowing you to easily add all sorts of extra functionality to your computer.

Each of these stellar holes is identified by an icon to help you identify it. Here's a list of what you'll find as well as a quick rundown on what these ports do.

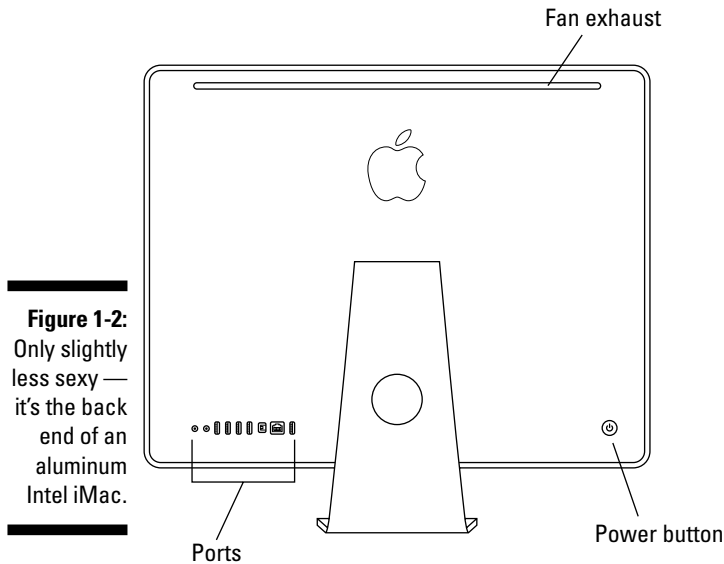

**Figure 1-2:** Only slightly less sexy — it's the back end of an aluminum Intel iMac.



- ✓ **FireWire:** These ports are the standard in the Apple universe for connecting external hard drives and DVD recorders, but they do double duty as the connector of choice for most digital video (DV) camcorders. (A *peripheral* is another silly techno-nerd term, meaning a separate device that you connect to your computer.) Note that the iMac offers two FireWire ports: one is the older FireWire 400 specification, and the other is the much-faster FireWire 800 port. The ports are shaped differently, so you can't plug a FireWire 400 device into a FireWire 800 port in error.



- ✓ **USB:** Short for *Universal Serial Bus*, the familiar USB port is the jack-of-all-trades in today's world of computer add-ons. Most external devices (such as portable hard drives, scanners, or digital cameras) that you want to connect to your iMac use a USB port. The iMac sports three USB 2.0 ports on its back, and you'll find an additional two USB ports lurking at each end of your keyboard. USB 2.0 connections are much faster than the old USB 1.1 standard.

For the specs on connecting your keyboard and mouse, see the upcoming section, "Absolutely essential connections."

For more on FireWire and USB ports, get the lowdown in Chapter 19.



- ✓ **Ethernet:** The iMac includes a standard 10/100/1000 Ethernet port, so it's ready to join your existing wired Ethernet network. (Alternatively, you can go wireless for your network connection; find more on that in the next section and in Chapter 17.)



Apple no longer includes a built-in modem on the iMac, so if you need a dialup connection to the Internet, you need an external 56K v.92 USB modem. (Apple sells a USB modem, which can send and receive faxes, too.)





- ✓ **Mini-DVI:** In case that splendid screen isn't quite big enough, you can add an adapter to this port and send the video signal from your iMac to another LCD monitor or flatscreen TV with a DVI port. (Apple also offers different adapters that can connect your iMac to standard VGA monitors, projectors, and displays that use S-video or composite jacks.)

### Connections for external audio

Your Intel iMac comes equipped with two pretty powerful stereo speakers on the bottom of the case, but you're certainly not limited to them. Apple provides a number of connectors to add a wide range of audiophile equipment to your system.



- ✓ **Headphone/Optical Output:** You can send the high-quality audio from your rectangular beast to a set of standard headphones or to an optical digital audio device, such as a high-end, home theater system.



- ✓ **Line In:** Last (but certainly not least) is the audio Line In jack, which allows you to pipe the signal from another audio device into your iMac. This one comes in particularly handy when you record MP3 files from your old vinyl albums or when you want to record loops within GarageBand, which you can read more about in Chapter 15. This jack supports both analog and digital input.

## Important Hidden Stuff

When you bought your new digital pride and joy, you probably noticed a number of subtle differences between the low-end iMac and the uber-expensive top-end model. I call these differences the *Important Hidden Stuff* (or IHS, if you're addicted to acronyms), and they're just as important as the parts and ports that you can see.

- ✓ **Hard drive:** The aluminum iMac uses the latest in hard drive technology: namely, *serial ATA* hard drives, which are significantly faster than the EIDE hard drives used in previous iMac models. (You don't need to worry about what ATA and EIDE mean here. Really.)

As I type these words, the iMac Core 2 Duo product line offers five different hard drive sizes, depending on the processor speed and screen size you choose: 250GB, 320GB, 500GB, 750GB, or an immense 1TB (yes, friends and neighbors, that means *terabyte*, or 1000GB). The bigger, the better.

- ✓ **Optical drive:** Okay, I'm cheating a little here. I mention the optical drive in an earlier section, but all you can see is the slot, so it qualifies as an IHS item. All new iMac models include a DVD-R SuperDrive (which can play and record both CDs and DVDs).





Time for a plug: If you're interested in recording your own audio and data CDs, or you've got an itch to burn DVD movies, I can highly recommend the bestselling *CD & DVD Recording For Dummies*, 2nd Edition (Wiley). (And written by yours truly; hence, the solid recommendation.) Anyway, within its pages, you'll find information on Roxio's Toast recording software. After a scant few minutes of study, you'll be using that information to burn your own shiny digital treasures.

- ✔ **Wireless Ethernet:** "Look, Ma, no wires!" As I mention earlier, your iMac can join an existing wireless Ethernet network with its built-in AirPort Extreme card. With wireless connectivity, you can share documents with another computer in another room, share a single high-speed Internet connection betwixt several computers, or enjoy wireless printing. Truly sassy!



Although Apple would want you to build your wireless wonderland with an Apple AirPort Extreme Base Station — go figure — you can actually use your iMac with any standard 802.11g or 802.11n wireless network. And yes, PCs and Macs can intermingle on the same wireless network without a hitch. (Scandalous, ain't it?)

- ✔ **Bluetooth:** Let's get the old "digital pirate" joke out of the way: "Arrgg, matey, I needs me a wireless parrot." (Engineers again . . . sheesh.) Although strangely named, Bluetooth is actually another form of wireless connectivity. This time, however, the standard was designed for accessories like your keyboard and mouse, and devices like your personal digital assistant (PDA) and cellphone. Bluetooth is now built in to every aluminum iMac.
- ✔ **Video card:** If your applications rely heavily on high-speed 3-D graphics, you'll be pleased as punch to find that your iMac comes equipped with either an ATI Radeon HD 2400 XT card (for the lower-end model) or an ATI Radeon HD 2600 Pro card (for the more expensive models). Both cards are well suited to 3-D modeling, video editing, and well, honestly, blasting the enemy into small smoking pieces with aplomb.

## Choosing a Home for Your New Pet

If you pick the wrong spot to park your new iMac, I can guarantee that you'll regret it later. Some domiciles and office cubicles obviously don't offer a choice — you've got one desk at work, for example, and nobody's going to hand over another one — but if you can select a home for your iMac, consider the important placement points in this section.

## Picking the right location

You know the mantra: Location, location, location.



- ✓ **There's always the wall.** Your iMac can disguise itself as a particularly interesting digital picture frame. With the right mounting adapter, you can hang your computer right on the wall and snub your desk altogether.

This wall-mounted solution has two big problems:

- Your VESA mounting plate must be installed safely and correctly (for example, using the studs within your walls).  
The iMac is slim and trim, but it's no lightweight, and it doesn't bounce well. You don't want it to take a high dive!
- External peripherals aren't happy campers — that includes any FireWire and USB devices, which must either camp out on the floor or on a nearby (and conspicuous) shelf. (Personally, I think the cables for external devices tend to spoil the appearance of a wall-mounted computer.)



Your iMac must be mounted at the proper height on the wall. It's not good ergonomic practice to sit more than two feet away from your iMac's screen, and the screen should be placed at (or slightly below) eye level.

I see two major requirements for a wall-mounted iMac:

- Don't plan on using any external devices. Instead, opt for a wireless network with a remote printer and remote backup storage space, like a Time Capsule unit on your network.
- Buy the wireless keyboard and mouse option when you buy your computer!

- ✓ **Keep things cool.** Your new iMac is nearly silent, but that super-fast Intel Core 2 Duo processor generates quite a bit of heat. Fans inside the case draw the heat away. (Nothing like an overheated processor to spoil an evening of Call of Duty 4.)

Follow these three rules to keep your cool. Make sure that

- The location you choose is far from heating vents.
- The location you choose is shielded from direct sunlight.
- Allow plenty of room below the machine (where the air enters the case) and above the machine (where heated air escapes from the slot at the top of the case).

Hot air from a wall-mounted iMac can discolor the wall.



## Considering the convenience factor

Technology is nothing if you can't make it convenient:



- ✓ **Outlets, outlets, outlets!** Your computer needs a minimum of at least one nearby outlet, and perhaps as many as three:
  - A standard AC outlet
  - A telephone jack (if you use an external USB modem for connecting to the Internet or sending and receiving faxes)
  - A nearby Ethernet jack (if you use the iMac's built-in Ethernet port for connecting to a wired Ethernet network)

If you prefer to send your data over the airwaves, consider wireless networking for your iMac. I discuss everything you need to know in Chapter 17.
- ✓ **Don't forget the lighting.** Let me act as your Mom. (I know that's a stretch, but bear with me.) She'd say, "You can't possibly expect to work without decent lighting! You'll go blind!" She's right, you know. At a minimum, you need a desk or floor lamp.
- ✓ **Plan to expand.** If your iMac hangs out on a desk, allow an additional foot of space on each side. That way, you have space for external peripherals, more powerful speakers, and that wired keyboard and mouse.

## Unpacking and Connecting

You are going to love this section — it's short and sweet because the installation of an aluminum iMac on your desktop is a piece of cake. (Sorry about the cliché overload, but this really *is* easy.)

### Unpacking your iMac For Dummies

Follow these guidelines when unpacking your system:



- ✓ **Check for damage.** I've never had a box arrive from Apple with shipping damage, but I've heard horror stories from others (who claim that King Kong must have been working for That Shipping Company). Check all sides of your box before you open it.

Take a photograph of any significant damage (just in case).
- ✓ **Search for all the parts.** When you're removing those chunks o' Styrofoam, make certain that you check all sides of each foam block for parts that are snuggled therein or taped for shipment.



- ✔ **Keep all those packing materials.** Do *not* head for the trash can with that box and those packing materials. Keep your box intact and also keep all packing materials for at least a year until your standard Apple warranty runs out. If you have to ship it to an Apple service center, the box and the original packing is the only way for your iMac to fly.

And now, a dramatic Mark's Maxim about cardboard containers:

Smart computer owners keep their boxes far longer than a year.™

For example, if you sell your iMac or move across the country, you'll want that box. *Trust me on this one.*

- ✔ **Store the invoice for safekeeping.** Your invoice is a valuable piece of paper, indeed.

Save your original invoice in a plastic bag, along with your computer's manuals and original software, manuals, and other assorted hoo-hah. Keep the bag on your shelf or stored safely in your desk, and enjoy a little peace of mind.



- ✔ **Read the iMac's manual.** "Hey, wait a minute, Mark — why do I have to read the manual from Apple along with this tome?" Good question, and here's the answer: There might be new and updated instructions in the documentation from Apple that override what I tell you in this book. (For example, "*Never* cut the red wire. Cut the blue wire instead." Or something to that effect.)

Besides, Apple manuals are rarely thicker than a restaurant menu.

## Connecting cables like a true nerd

The iMac makes all its connections really simple, but your computer depends on you to get the outside wires and thingamabobs where they go.

### *Absolutely essential connections*

After your new iMac is resting comfortably in its assigned spot (I assume that's a desktop), you need to make a couple of connections:

- ✔ **The power cable**

Plug the cable into the corresponding socket on the iMac first; then plug 'er in to that handy AC outlet.

- ✔ **The (wired) keyboard and mouse**

- Plug the USB cable from your keyboard into one of the USB 2.0 ports on the back of the iMac.
- Plug the mouse into one of the USB 2.0 ports on the sides of your keyboard.



See the earlier section, “Those holes are called ports,” to see how these ports are marked — and the connector fits only one way, due to a blazing moment of inspired thinking by the designers of the USB port!

If you bought your iMac equipped with the wireless keyboard and mouse options, your batteries might need to be installed. After the batteries are in, you’re set to go.

### ***Adding the Internet to the mix***

If you have Internet access or a local computer network, you need to make at least one of the following connections.



If you don’t already have *any* Internet service, you’ll probably want to start with local dialup Internet access (if you have an external USB modem for your iMac). If you decide to investigate your high-speed options immediately, your local cable and telephone companies can provide you with more information on DSL or cable Internet service.

### ***Dialup Internet access***

If you get on the Internet by dialing a standard phone number, you’ll need an external USB modem to connect your iMac. Follow these steps:

- 1. Plug your external USB modem into one of the USB ports on the back of your iMac.**
- 2. Plug one of the telephone cable’s connectors into your modem’s line port.**
- 3. Plug the other telephone cable connector into your telephone line’s wall jack.**

### ***Networks and high-speed Internet access***

If you have high-speed Internet service or if you’re in an office or school with a local computer network, you can probably connect through the iMac’s built-in Ethernet port. You make two connections:

- 1. Plug one end of the Ethernet cable into the Ethernet port on the iMac.**
- 2. Plug the other end of the Ethernet cable into the Ethernet port from your network. It’s probably one of the following:**
  - An Ethernet wall jack
  - An Ethernet hub or switch
  - A cable or DSL Internet router (or sharing device)



Will you be joining a wireless network? If so, you find all the details you need in Chapter 17 to configure Leopard for wireless networking.

## Discovering All the Cool Things You Can Do

This section answers the most common of all novice computer questions: “What the heck will I *do* with this thing?” You find additional details and exciting factoids about the software that you get for free, software you’ll want to buy, and stuff you can do on the Internet.

### *What software do I get?*

Currently, all iMac computers ship with these major software applications installed and ready to use:

- ✓ **The iLife suite:** You know you want these applications! They turn your iMac into a digital hub for practically every kind of high-tech device on the planet, including DV camcorders, digital cameras, portable music players, PDAs, and even cellphones.  
Chapters 11–15 of this book focus on the five major applications that make up iLife: iMovie, iDVD, iTunes, iPhoto, and GarageBand.
- ✓ **The iWork suite:** A *demo* version of Apple’s powerful office productivity suite is included with your iMac. You can create documents, spreadsheets, and presentations within Pages, Numbers, and Keynote. It’s much like that Other Office Suite (the one that costs a bundle) from those guys in Redmond.  
Figure 1-3 illustrates a flyer under construction in Pages.
- ✓ **Front Row:** This onscreen menu system makes it easy to watch movies, listen to your music, and display your favorite photos on that gorgeous iMac screen . . . all remotely, using the supplied Apple Remote! I go into the details of Front Row in Chapter 10.



The installed software on your iMac might change as new programs become available.

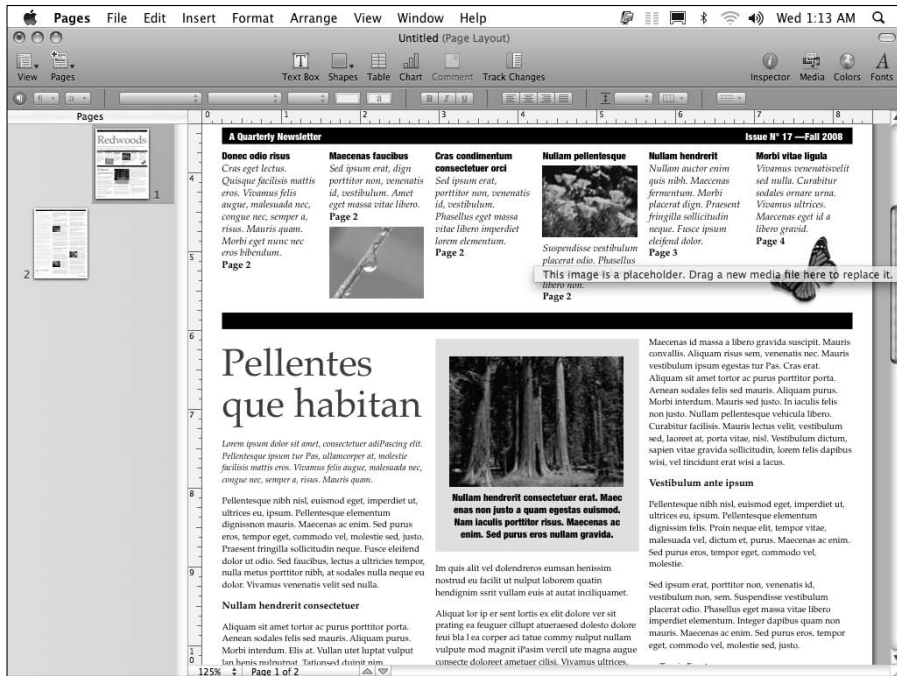

**Figure 1-3:**  
Pages is a  
great tool  
for home  
and office.

## Looking forward to fun on the Internet

What is a modern computer without the Internet? Apple gives you great tools to take full advantage of every road sign and offramp on the Information Superhighway, right out of the box:

- **Web surfing:** I use Leopard's Safari Web browser every single day. It's faster and better designed than Internet Explorer, with unique features like tabbed browsing and built-in RSS feeds.
 

If *tabbed browsing* and *RSS feeds* sound like ancient Aztec to you, don't worry. Chapter 8 is devoted entirely to Safari.
- **Web searches:** Your Dashboard widgets can search the entire Internet for stocks, movie listings, business locations, and dictionaries.
- **Chat:** *iChat* lets you use your iMac to chat with others around the world for free via the Internet — by keyboard, voice, or (with your built-in iSight Web camera) full-color video. This is awesome stuff straight out of Dick Tracy and Buck Rogers. If you've never seen a video chat, you'll be surprised by just how good your friends and family look!

Always wear a shirt when videoconferencing.





- ✓ **E-mail:** Soldier, Apple's got you covered. The Mail application is a full-featured e-mail system, complete with defenses against the torrent of junk mail awaiting you. (Imagine a hungry, digital, saber-toothed tiger with an appetite for spam.) Send pictures and attached files to everyone else on the planet, and look doggone good doing it.

## Applications that rock

Dozens of small applications are built into Mac OS X. I mention them in later chapters, but here are three good examples to whet your appetite:

- ✓ **iCal:** Keep track of your schedule and upcoming events, and even share your calendar online with others in your company or your circle of friends. See how to keep your life in order in Figure 1-4.
- ✓ **DVD Player:** Put all that widescreen beauty to work and watch your favorite DVD movies with DVD Player! You have all the features of today's most expensive standalone DVD players, too, including a spiffy onscreen control that looks like a remote.
- ✓ **Address Book:** Throw away that well-thumbed collection of fading addresses. Leopard's Address Book can store, search, and recall just about any piece of information on your friends, family, and acquaintances.

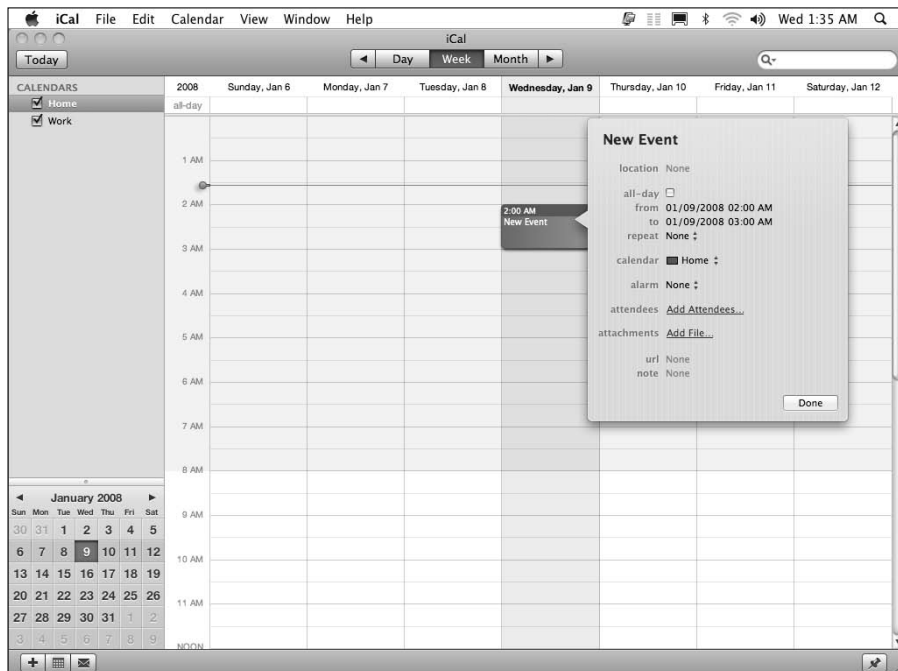

**Figure 1-4:**  
Hey, isn't  
that iCal  
running on  
your iMac?  
You are  
iTogether!



You can use the data you store in your Address Book in other Apple applications that are included with Leopard, such as Apple Mail and iChat.

## *Would you like to play a game?*

“All productivity and no play. . . .” Hey, Steve Jobs likes a good challenging game as much as the next guy, so you can look forward to playing Chess on your iMac right out of the box — ah, but this isn’t the chessboard your Dad used! Play the game of kings against a tough (and configurable) opponent — your iMac — on a beautiful 3-D board. Heck, your iMac even narrates the game by speaking the moves!

## *Stuff You Oughta Buy Right Now*

No man is an island, and no computer is either. I always recommend the same set of stuff for new PC and Mac owners. These extras help keep your new computer clean and healthy (and some make sure you’re happy as well):



✓ **Surge suppressor or UPS (uninterruptible power supply):** Even an all-in-one computer like your iMac can fall prey to a power surge. I recommend one of these:

- A *basic surge suppressor* with a fuse can help protect your iMac from an overload.
- A *UPS* costs a little more, but it does a better job of filtering your AC line voltage to prevent brownouts or line interference from reaching your computer.

A UPS provides a few minutes of battery power during a blackout so you can save your documents and safely shut down your iMac.

✓ **Screen wipes:** Invest in a box of premoistened screen wipes. Your iMac’s screen can pick up dirt, fingerprints, and other unmentionables faster than you think.

Make sure your wipes are especially meant for LCD or laptop computer screens.

✓ **Blank CDs and DVDs:** Depending on the type of media you’re recording — like computer data CDs, DVD movies, or audio CDs — you’ll want blank discs for

- CD-R (record once)
- CD-RW (record multiple times)



- DVD-R (record once)
- DVD-RW (record multiple times)

✓ **Cables:** Depending on the external devices and wired network connectivity you'll be using, these are

- A standard Ethernet cable (for wired networks or high-speed Internet)
- FireWire or USB cables for devices you already have

Most hardware manufacturers are nice enough to include a cable with their products, but there are exceptions, especially USB printers. *Shame on those cheapskates!*

✓ **A wrist rest for both your keyboard and mouse:** You might have many reasons to buy a new iMac, but I know that a bad case of carpal tunnel syndrome is *not* one of them. Take care of your wrists by adding a keyboard and mouse rest (even for a wireless keyboard/mouse combo, even on a TV tray).



## Chapter 2

# Life! Give My iMac Life!

---

### *In This Chapter*

- ▶ Turning on your iMac
  - ▶ Checking your iMac for proper operation
  - ▶ Setting up Mac OS X Leopard
  - ▶ Registering your iMac
  - ▶ Using Migration Assistant
  - ▶ Copying information from a Windows PC
- 

**I**f you've already been through Chapter 1, you got as far as unpacking your iMac and connecting a number of cables to it. And unless you solely bought this computer as a work of modern art, it's time to actually turn on your iMac and begin living The Good Life. (Plus, you still get to admire that Apple design whilst using iTunes.) After you get your new beauty powered on, I help you here with an initial checkup on your iMac's health.

I also familiarize you with the initial chores that you need to complete — such as using Mac OS X Setup as well as moving the data and settings from your existing computer to your iMac — before you settle in with your favorite applications.

In this chapter, I assume that Mac OS X Leopard (version 10.5) was preinstalled on your iMac or that you just completed an upgrade to Leopard from an earlier version of Mac OS X. (If you're upgrading, your iMac is already turned on, and you can skip the next section!)

## *Throwing the Big Leaf Switch*

Your iMac's power switch is located on the back of the computer, at the lower-left corner of the case (as you look at the screen). Press it now to turn on your iMac, and you hear the pleasant startup tone that's been a hallmark of Apple computers for many years now. Don't be alarmed if you don't immediately see anything onscreen because it takes a few seconds for the initial Apple logo to appear.



In my experience, a simple quick press of the power button on some iMacs sometimes just doesn't do it. Instead, you actually have to hold down the button for a count of two or so before the computer turns on. However, if your iMac ever locks up tight (and you can't quit an application, as I demonstrate in Chapter 4), the power button gives you another option. Just hold it down for a count of five, and your iMac shuts off. (Yep, this trick works even if your iMac is locked up tight.)

While the Apple logo appears, you see a twirling, circular high-tech progress indicator appear that looks like something from a *Star Wars* movie. That's the sign that your iMac is loading Leopard and checking your internal drive for problems. Sometimes the twirling circle can take a bit longer to disappear. As long as it's twirling, though, something good is happening.

Next, Leopard displays the soon-to-be-quite-familiar Aqua Blue (yup, that's its name) background while it loads certain file sharing, networking, and printing components (and such). This time, you get a more conservative progress bar, but the end result is the same. Just wait patiently a bit longer.

At last, your patience of a whole 10–15 seconds is rewarded, and after a short (but neat) video, you see the Leopard Setup Assistant appear.

## *Mark's Favorite Signs of a Healthy iMac*

Before you jump into the fun stuff, don't forget an important step — a quick prelim check of the signs that your iMac survived shipment intact and happy. (Although the shipping box that Apple uses for the aluminum iMac series is one of the best I've ever encountered in 20-plus years of shipping computer hardware, your computer could still have met with foul play.)

If you can answer Yes to each of these questions, your iMac likely made the trip without serious damage:

### **1. Does the computer's chassis appear undamaged?**

It's pretty easy to spot damage to your iMac's svelte metal and glass design. Look for scratches, puncture damage, and misalignment of the screen.

### **2. Does the LCD screen work, and is it undamaged?**

I'm talking about obvious scratches or puncture damage to your screen. Additionally, you should also check whether any individual dots (or *pixels*) on your LCD monitor are obviously malfunctioning. Bad pixels either appear black or in a different color than everything surrounding them.



Techs call these irritating anarchists *dead pixels*. Unfortunately, many new LCD screens include one or two. After all, a 20" iMac screen sports literally more than one million pixels.

### 3. Can you feel a flow of air from the vent on top?

Your iMac's Intel processor generates quite a bit of heat, so the fan system never turns off completely. If you don't feel warm air from the fan system after your iMac has been on for a minute or two, you might have a problem.

### 4. Do the keyboard and mouse work?

Check your iMac's USB (Universal Serial Bus) ports by moving the mouse; the cursor should move on your screen. To check the keyboard, press the Caps Lock key on the left and observe whether the green Caps Lock light turns on and off.

If you do notice a problem with your iMac (and you can still use your Safari browser and reach the Web), you can make the connection to an Apple support technician at [www.apple.com](http://www.apple.com). If your iMac is lying on its back with its foot in the air and you can't get to the Internet, you can check your phone book for a local Apple service center, or call the AppleCare toll-free number at 1-800-275-2273. Chapter 18 also offers troubleshooting information.

## *Harriet, It's Already Asking Me Questions!*

After your iMac is running and you've given it the once-over for obvious shipping damage, your next chore is to set up your iMac. Unlike other tasks in this book, I won't cover the setup process step by step. Apple constantly "tweaks" the questions that you see during setup on a regular basis, and the questions are really very easy to answer. Everything is explained onscreen, complete with onscreen Help if you need it.

However, I do want you to know what to expect as well as what information you need to have at hand. I also want you to know about support opportunities, such as the AppleCare Protection Plan and the Apple .Mac Internet services. Hence this section: Consider it a study guide for whatever your iMac's setup procedure has to throw at you.

## *Setting up Mac OS X Leopard*

After you start your iMac for the first time — or if you just upgraded from an earlier version of Mac OS X — your iMac will likely automatically launch the Leopard set-up procedure. (Note that some custom install options, like

the Archive and Install option, might not launch the Setup procedure.) The set-up process takes care of a number of different tasks:



✔ **Setup provides Leopard with your personal information.**

As I mention in Chapter 1, your iMac ships with a bathtub full of different applications, and many of those use your personal data (like your address and telephone number) to automatically fill out your documents.

If that personal stored information starts you worrying about identity theft, I congratulate you. If you're using your common sense, it should. However, in this case, Apple doesn't disseminate this information anywhere else, and the applications that use your personal data won't send it anywhere, either. And *Safari*, the Apple Web browser, fills out forms on a Web page automatically only if you give your permission.

✔ **Setup configures your language and keyboard choices.**

Mac OS X is a truly international operating system, so Setup offers you a chance to configure your iMac to use a specific language and keyboard layout.

✔ **Setup configures your e-mail accounts within Apple Mail.**

If you already have an e-mail account set up with your Internet service provider (ISP), keep that e-mail account information that the ISP provided handy to answer these questions. (The list should include the incoming POP3 and outgoing SMTP mail servers you'll be using, your e-mail address, and your login name and password. Don't worry about those crazy acronyms — your ISP will know exactly what you mean when you ask for this information.) Leopard can even automatically configure many Web-based e-mail accounts for you (including Google Mail, Yahoo! Mail, and AOL Mail) if you supply your account ID and password. *Sweet.*

✔ **Setup allows you to open a trial subscription with Apple's .Mac service.**

A .Mac subscription service provides you with online file storage, iSync capability across multiple computers, backups to your online storage, Apple e-mail accounts (through both Web mail and the Apple Mail application), and your own acre of Web site on the Internet. I go into all these in detail in Chapter 9. For now, just sign up and take the opportunity to feel smug about owning an Apple computer.

✔ **Setup sends your registration information to Apple.**

As a proud owner of an iMac, take advantage of the year of hardware warranty support and the free 90 days of telephone support. You have to register to use 'em, but rest assured that all this info is confidential.

✔ **Setup launches Migration Assistant.**

This assistant guides you through the process of *migrating* (an engineer's term for *moving*) your existing user data from your old Mac or PC to your new iMac. Naturally, if your iMac is your first computer, you can skip this step with a song in your heart! (Read more on Migration Assistant in the section, "Importing Documents and Data from Your Old Mac.")



## Registering your Mac

I'll be honest here: I know that many of us, myself included, don't register every piece of computer hardware we buy. For example, I didn't register my wireless Bluetooth adapter that I bought for my older iBook because the total expenditure cost was only around \$40, the gizmo has no moving parts, and I'm never likely to need technical support to use it or get it fixed.

However, your iMac is a different kettle of fish altogether, and I *strongly* recommend that you register your purchase with Apple during the setup process. You spent a fair amount on your computer, and it's an investment with a significant number of moving parts.

Even the hardest of techno-wizards would agree with this important Mark's Maxim:



If you don't register your iMac, you can't receive support.™

And rest assured that Apple is not one of those companies that constantly pesters you with e-mail advertisements and near-spam. I've registered every Apple computer I've owned, and I've never felt pestered. (And I have an extremely low tolerance for pester.)

## Importing Documents and Data from Your Old Mac

If you're upgrading from an older Mac running Mac OS X to your new iMac, I have great news for you: Apple includes the Migration Assistant utility application that can help you copy (whoops, I mean, *migrate*) all sorts of data from your old Mac to your new machine. The list of stuff that gets copied over includes

- ✔ **User accounts:** If you set up multiple user accounts (so that more than one person can share the computer), the utility ports them all to your new iMac.
- ✔ **Network settings:** Boy, howdy, this is a real treat for those with manual network settings provided by an ISP or network administrator! Migration Assistant can re-create the entire network environment of your old Mac on your new iMac.
- ✔ **System Preferences settings:** If you're a fan of tweaking and customizing Mac OS X to fit you like a glove, then rejoice. The Assistant actually copies over all the changes that you've made within System Preferences on your old Mac! (Insert sound of angelic chorus of cherubim and seraphim: *Hallelujah!*)

- ✔ **Documents:** The files in your Documents folder(s) are copied to your new iMac.
- ✔ **Applications:** Migration Assistant tries its best to copy over the third-party applications that you've installed in your Applications folder on the older Mac. I say *tries its best* because you might have to reinstall some applications, anyway. Some developers create applications that spread out all sorts of files across your hard drive, and the Assistant just can't keep track of those nomadic files. Too, some other applications make the trek just fine, but you might have to reenter their serial numbers.



Setup launches its Migration Assistant automatically if you indicate that you need to transfer stuff during the Setup process, but you can always launch Migration Assistant manually at any time. You'll find it in the Utilities folder inside your Applications folder; just double-click the Migration Assistant icon.

To use Migration Assistant to copy your system from your older Mac, you need a FireWire 400 cable (compatible with most Macs made within the last five years or so) to connect the computers. If you don't already have one, you can pick up a standard FireWire cable at your local Maze o' Wires electronics store or at your computer store. (This cable will probably come in handy in the future as well, so it's not a one-use wonder.)

Follow these steps to use Migration Assistant:

### 1. Click Continue on the opening screen.

Migration Assistant prompts you for your account name and password that you create during the Setup procedure, as shown in Figure 2-1. Your account is an *admin account*, meaning that you have a higher security level that allows you to change things within Leopard. (Much more detail on user accounts is covered in Chapter 16.)



**Figure 2-1:** Enter your admin password to use Migration Assistant.



**2. Type your account name and password and then click OK.**

Characters in your password are displayed as bullet characters for security. After you've successfully entered your admin account name and password, this dialog disappears and you get to play in the real Migration Assistant dialog.



**3. Select the From Another Mac radio button and then click Continue.**

You can also restore your iMac's data from a Time Machine backup drive, using Migration Assistant.

**4. Connect a FireWire cable between the two computers and click Continue.**

**5. Restart your older Mac while holding down the T key.**

This restarts your older computer in *FireWire Target Disk mode*, in which your older Mac essentially becomes a huge external FireWire hard drive. (Neat trick.)



You must hold down the T key until you see the FireWire symbol (which looks like a stylized Y) appear on your older machine.

**6. Click Continue.**

**7. Select the check boxes next to the user accounts that you want to transfer from your older machine (as shown in Figure 2-2) and then click Continue.**

The Assistant displays how much space is required to hold the selected accounts on your iMac's hard drive.

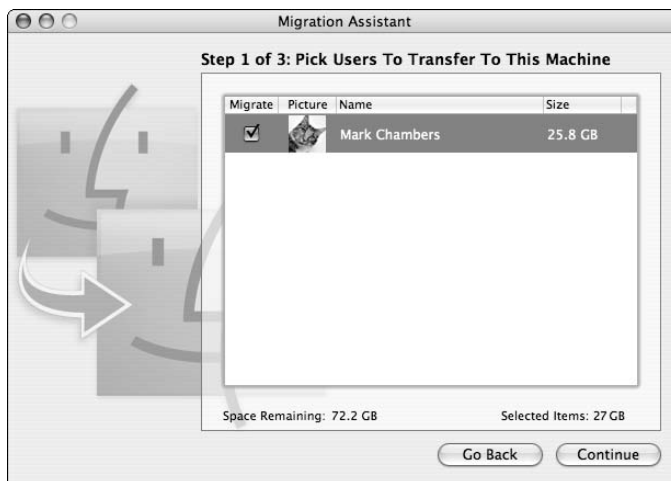

**Figure 2-2:**  
Select  
the user  
accounts  
you want  
to migrate.

8. Select the check boxes next to the applications and files that you want to copy (see how in Figure 2-3) and then click Continue.

**Figure 2-3:**  
Would you like applications and files with that migration?

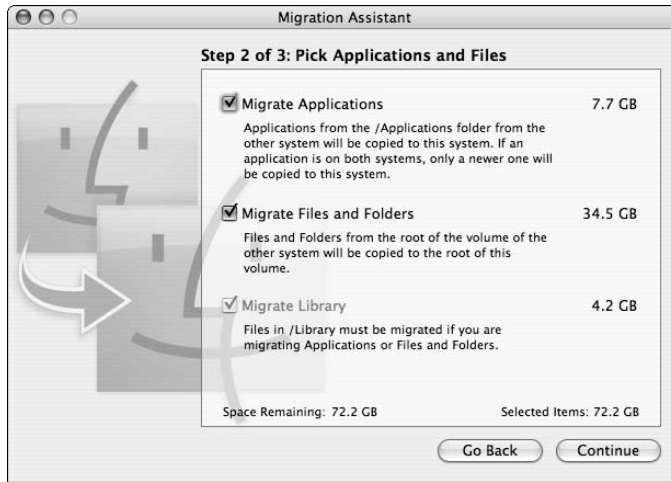

9. Select the check boxes next to the settings that you want to transfer (as shown in Figure 2-4).

Typically, you want to migrate all three of these settings groups: Network Settings, Time Zone, and Sharing Settings.

10. Click the Migrate button.
11. After everything is copied, you can press and hold the power button on your older Mac to shut it off. Then disconnect the FireWire cable.

**Figure 2-4:**  
Copy your Mac OS X settings with Migration Assistant.

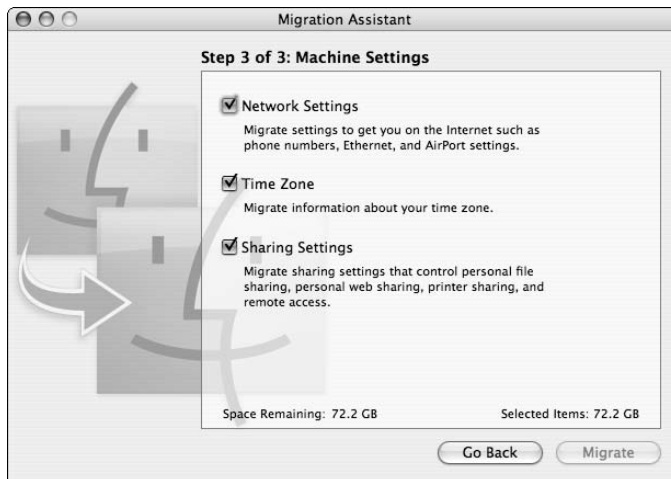

## Importing Documents and Data from Windows

If you're a classic Windows-to-Mac *Switcher*, you made a wise choice, especially if you're interested in the creative applications within the iLife '08 suite! Although you can choose to start your Apple computing life anew, you probably want to migrate some of your existing documents and files from that tired PC to your bright, shiny, new iMac.

Unfortunately, no Windows Migration Assistant exists within Mac OS X. However, if you're moving from a Windows PC to an iMac, you can copy your files manually from a CD or DVD, from a USB Flash drive, or over a network. (Note, however, that the iMac doesn't come with a floppy drive. And trust me, you wouldn't want to use one to move anything that matters, anyway.)



The Mac OS X Help system contains an entire subsection on specific tricks that you can use when switching from Windows to Mac, including how to connect to a Windows network and how to directly connect the two computers.

Because Leopard can't run Windows programs (at least, not without extra software), moving applications (think Paint Shop Pro) won't do you any good. In general, however, you can move documents, movies, photos, and music without a problem. Table 2-1 illustrates what can be moved between Windows and Mac OS X as well as the application that you use in Leopard to open those files and documents.

### Switching from a PC to . . . an Apple PC?

With the Leopard Boot Camp feature, you can actually create a full Windows XP or Vista system on your Intel iMac. Yup, Windows and Leopard coexist peacefully *on the same computer*. As you can read later in the book in Chapter 21, you have to reboot your computer to use your iMac as a Windows system.

This brings a whole new meaning to the term *Switcher* because some iMac owners are moving their stuff from Windows (running on their old PC) to . . . well, Windows (running

on their new iMac) rather than Leopard. If you do decide to create a Windows system on your iMac by using Boot Camp, the files and folders on your existing PC can be copied directly by using the Files and Settings Transfer Wizard (in Windows XP) or the Windows Easy Transfer utility (in Windows Vista). In effect, you're copying your settings and data between your old PC and your new Apple-based PC! (That sounds a little skewed, but die-hard Apple apostles will have to forgive me.)

<i>File Type</i>	<i>Windows Location</i>	<i>Mac OS X Location</i>	<i>Mac Application</i>
Music files	My Music folder	Music folder	iTunes
Video and movie files	My Videos folder	Movies folder	QuickTime/ DVD Player
Digital photos	My Pictures folder	Pictures folder	iPhoto
Office documents	My Documents folder	Documents folder	Mac Office/ iWork

If you don't mind investing around \$50, try using the Move2Mac software utility, which does most of the work of Migration Assistant for those switching from a Windows PC. From Detto Technologies ([www.detto.com/mac-file-transfer.html](http://www.detto.com/mac-file-transfer.html)), Move2Mac comes complete with a special USB-to-USB cable that connects your two computers for high-speed copying. With Move2Mac, you can choose what you want to transfer to your new iMac (use Table 2-1 as a guide), and the copying is done automatically for you. Plus, Move2Mac also transfers goodies like your home page and bookmarks from Internet Explorer, desktop backgrounds, and even your Address Book contacts and account settings from Outlook Express. Move2Mac makes switching much easier, and I can highly recommend it.

## Chapter 3

# Introducing the Apple of Your iMac

---

### *In This Chapter*

- ▶ Introducing Mac OS X Leopard
  - ▶ Appreciating the Unix core underneath Leopard
  - ▶ Recognizing similarities between Windows XP and Leopard
  - ▶ Getting help while exploring Leopard
- 

**I**n the other books that I've written about Mac OS X Leopard, I use all sorts of somewhat understated phrases to describe my operating system of choice, such as *elegantly reliable*, *purely powerful*, and *supremely user friendly*.

But *why* is Leopard such a standout? To be specific, why do creative professionals and computer techno-wizards across the globe hunger for the very same Mac OS X that runs your iMac? Why is Leopard so far ahead of Windows Vista in features and performance? Good questions, all!

In this chapter, I answer those queries and satisfy your curiosity about your new big cat. I introduce the main elements of the Leopard Desktop, and I show you the fearless Unix heart that beats underneath Leopard's sleek exterior. I also point out the most important similarities between Leopard and Windows Vista, and I outline the resources available if you need help with Mac OS X.

Oh, and I promise to use honest-to-goodness English in my explanations, with a minimum of engineer-speak and indecipherable acronyms. (Hey, you've got to boast about Leopard in turn to your family and friends. Aunt Harriet might not be as technologically savvy as we are.)

## A Quick Tour about the Premises

Leopard is a special type of software called an *operating system*. You know, *OS*, as in *Mac OS X*? That means that Leopard essentially runs your iMac and also allows you to run all your other applications, such as iTunes or Photoshop CS3. It's the most important computer application — or *software* — that you run.



Think of a pyramid, with Leopard as the foundation and other applications running on top.

You're using the OS when you aren't running a specific application, such as these actions:

- ✓ Copying files from a CD to your hard drive
- ✓ Choosing a different screensaver

Sometimes, Leopard even peeks through an application while it's running. For example, actions like these are also controlled by Leopard:

- ✓ The Open, Save, and Save As dialogs that you see when working with files in Photoshop CS3
- ✓ The Print dialog that appears when you print a document in Microsoft Word

In this section, I escort you personally around the most important hotspots in Leopard, and you meet the most interesting onscreen thingamabobs that you use to control your iMac. (I told you I wasn't going to talk like an engineer!)

### *The Leopard Desktop*

This particular desktop isn't made of wood, and you can't stick your gum underneath. However, your Leopard Desktop does indeed work much like the surface of a traditional desk. You can store things there, organize things into folders, and take care of important tasks like running other applications. Heck, you've even got a clock and a trash can.

Gaze upon Figure 3-1 and follow along as you venture to your Desktop and beyond.







I cover the Dock in more detail in Chapter 5.

The Dock is highly configurable:

- ✓ It can appear at different sides of the screen.
- ✓ It can disappear until you move your mouse pointer to the edge to call it forth.
- ✓ You can resize it larger or smaller.

### ***Dig those crazy icons***

By default, Leopard always displays at least one icon on your Desktop: your Mac's internal hard drive. To open a hard drive and view or use the contents, you double-click the icon. Other icons that might appear on your Desktop can include

- ✓ CDs and DVDs
- ✓ An iPod
- ✓ External hard drives or USB Flash drives
- ✓ Applications, folders, and documents
- ✓ Files you downloaded from the Internet
- ✓ Network servers you access

Chapter 4 provides the good stuff on icons and their uses within Leopard.

### ***There's no food on this menu***

The Finder menu isn't found in a restaurant. You find it at the top of the Desktop, where you can use it to control your applications. Virtually every application that you run on your iMac has a menu.



To use a menu command, follow these steps:

- 1. Click the menu group (like File or Edit).**
- 2. Choose the desired command from the list that appears.**



Virtually every Macintosh application has some menu groups, such as File, Edit, and Window. You're likely to find similar commands within these groups. However, only two menu groups are in *every* Mac OS X application:

- ✓ The *Apple menu* (which is identified with that jaunty Apple Corporation icon, .
- ✓ The *application menu* (which always bears the name of the active application). For instance, the DVD Player menu group appears when you run the Leopard DVD Player, and the Word menu group appears when you launch Microsoft Word.



I cover these two common groups in more detail in Chapters 4 and 5.

You can also display a contextual menu — regular human beings call it a *right-click menu* — by right-clicking your Leopard Desktop, or on an application, folder, or file icon. I discuss right-click menus in detail in the next chapter.

### ***There's always room for one more window***

You're probably already familiar with the ubiquitous window itself. Both Leopard and the applications that you run use windows to display things like

- ✓ The documents that you create
- ✓ The contents of your hard drive

The window in Figure 3-1 is a Finder window, where Leopard gives you access to the applications, documents, and folders on your system.

Windows are surprisingly configurable. I cover them at length in Chapter 4.

## ***What's going on underneath?***

How the core is designed makes more of a difference than all the visual bells and whistles, which tend to be similar between Windows XP and Mac OS X Leopard (and Linux as well, for that matter). Time for a Mark's Maxim:



Sure, Leopard's elegant exterior is a joy to use, but Mac OS X is a better OS than Windows because of the unique Unix muscle that lies underneath!<sup>TM</sup>

### **Isn't Windows Vista the latest thing?**

You've seen highly customized "pocket rocket" compact cars with the flashy paint jobs, huge noisy mufflers, and aerodynamic fiberglass stuff. You might think that these cars are real road racers, but what's underneath is different. The 4-cylinder engine that you *don't* see is completely stock. These cars don't perform any better than a mundane model straight from the factory.

The same holds true for Microsoft Windows Vista, which was another attempt by the folks at Redmond to put a modern face on an antique OS. Forget the flashy colors and the visual effects: Windows Vista is simply more of the same (at

least it's newer than Windows XP, which was beginning to creak). Sure, it's more reliable and faster than older versions of Windows, but there's not a boatload of innovative features in Vista. (Unfortunately, if you're running PC hardware, the only other practical choice for a computing novice is Linux, which is still regarded as too complex by major manufacturers like Dell and Hewlett-Packard. Therefore, with a PC, you're usually stuck with Windows XP or Windows Vista — or you've picked up a very expensive paperweight.)

So what should you and I look for in an OS? Keep in mind that today's computer techno-wizard demands three requirements for a truly high-powered software wonderland — and Mac OS X Leopard easily meets all three:

- ✓ **Reliability:** Your OS has to stay up and running reliably for as long as necessary — I'm talking *months* here — without lockups or error messages. If an application crashes, the rest of your work should remain safe, and you should be able to shut down the offending software.
- ✓ **Performance:** If your computer has advanced hardware, your OS must be able to use those resources to speed things up big-time. The OS has to be highly configurable, and it has to be updated often to keep up with the latest in computer hardware.

“Mark, what do you mean by advanced hardware?” Well, if you're already knowledgeable about state-of-the-art hardware, examples include

- True 64-bit computing
- Multiple processors (like more than one Intel chip in your computer)
- A huge amount of RAM (4GB on the iMac, or far more on today's Power Mac computers)
- Enough hard drive space to make use of a RAID array

If all that sounds like ancient Sumerian, gleefully ignore this technical drabble and keep reading.

- ✓ **Ease of use:** All the speed and reliability in the world won't help an OS if it's difficult to use.

DOS was the PC OS of choice before the arrival of Windows. It was doomed because it wasn't intuitive or easy to master, requiring a PC owner to remember all sorts of commands that looked like hieroglyphics. (This is one of the reasons why the Macintosh was so incredibly popular in the days of DOS-based PCs. Macs had a mouse, and they were a snap to master and use.)



## *Similarities with That Windows Behemoth*

You might have heard of the *Windows Switcher*: a uniquely intelligent species that's becoming more and more common these days. Switchers are former PC owners who have abandoned Windows and bought a Macintosh, thereby joining the Apple faithful running Mac OS X. (Apple loves to document this migration on its Web site.) Because today's Macintosh computers are significantly faster than their PC counterparts — and you get neat software, such as Leopard and the iLife suite when you buy a new Mac — switching makes perfect sense.



## It's Apple to the rescue!

Unix is the established, super-reliable OS that powers most of the high-performance servers that make up the Internet. Unix has built-in support for virtually every hardware device ever wrought by the hand of Man (including all the cool stuff that came with your iMac), and Unix is well designed and highly efficient.

Unfortunately, standard Unix looks as hideous as DOS, complete with a confusing command line, so ease-of-use for normal human beings like you and me goes out the door. Enter the genius types at Apple, who understood several years ago that all Unix needed was a state-of-the-art, novice-friendly interface! To wit: Mac OS X was developed with a Unix foundation (or *core*), so it shares the same reliability and performance as Unix. However, the software engineers at Apple (who know a thing or two about ease-of-use) made it good-looking and easy to use.

This is the secret to the worldwide fever over Mac OS X: It blends the best of Unix with the best of earlier Macintosh operating systems like Mac OS 9. Mac OS X is not only easy to use, but

it also runs tight, concentric *sassy* rings around anything that Microsoft has to offer today.

That's as far as I delve into the foundation of Leopard in this volume — understandably, because there's lots more iMac to cover! It's my job to help you use the features and controls within Leopard, not turn you into a bearded Unix nerd with a pocket protector and suspenders. In fact, you never see the Unix running underneath Leopard (unless you want to, by running the Terminal application). Instead, iMac owners can stay safely in the elegant world of drag-and-drop and point-and-click.

If you're interested in all the details about what makes Mac OS X tick, as well as its settings and features, I can heartily recommend another of my books, the bestselling (and extremely heavy) *Mac OS X Leopard All-in-One Desk Reference For Dummies* (Wiley). It comprehensively covers everything Leopard — over 700 pages devoted entirely to Mac OS X and its companion applications!

Switchers aren't moving to totally unfamiliar waters. Windows XP, Windows Vista, and Leopard share a number of important concepts. Familiarizing yourself with Leopard takes far less time than you might think.

Here's an overview of the basic similarities between the two operating systems:

- ✔ **The Desktop:** The Leopard Desktop is a neat representation of a real physical desktop, and Windows uses the same idea:
  - You can arrange files, folders, and applications on your Desktop to help keep things handy.
  - Application windows appear on the Desktop.
- ✔ **Drives, files, and folders:** Data is stored in files on your hard drive(s), and those files can be organized in folders. Both Leopard and Windows use the same file/folder concept.

- ✓ **Specific locations:** Both Windows and Leopard provide every user with a set of folders to help keep various types of files organized. For example, the My Videos folder that you can use in Windows XP corresponds to the Movies folder that you find in your Home folder within Leopard.
- ✓ **Running programs:** Both Leopard and Windows run programs (or applications) in the same manner:
  - Double-clicking an application icon launches that application.
  - Double-clicking a document runs the corresponding application and then automatically loads the document.
- ✓ **Window control:** Yep, both operating systems use windows, and those windows can be resized, hidden (or minimized), and closed in similar fashions. (Are you starting to see the connections here?)
- ✓ **Drag-and-drop:** One of the basics behind a GUI (a ridiculous acronym that stands for *graphical user interface*) like Windows and Leopard is the ability to drag documents and folders around to move, delete, copy, and load them. Drag-and-drop is one of the primary advantages of both of these operating systems because copying a file by dragging it from one window to another is intuitive and easy enough for a kid to accomplish.
- ✓ **Editing:** Along the same lines as drag-and-drop, both Leopard and Windows offer similar cut-and-paste editing features. You've likely used Cut, Copy, and Paste for years, so this is familiar stuff.

## Calling for Help

You can call on these resources if you need additional help while you're discovering how to tame the Leopard.



Some of the help resources are located on the Internet, so your Web browser will come in handy.

## The Leopard built-in Help system

Sometimes the help you need is as close as the Help group on the menu. You can get help for either

- ✓ **A specific application:** Just click Help. Then, click in the Search box and type a short phrase that sums up your query (such as *startup keys*). You'll see a list of help topics appear on the menu. Just click a topic to display more information.

- ✓ **Actions and functions (topics):** Click a Finder window and then click Help on the menu. Again, you'll see the Search box, and you can enter a word or phrase to find within the Help system. To display the Help viewer window, click the Mac Help item under the Search box.

## *The Apple Web-based support center*

Apple has online product support areas for every hardware and software product that it manufactures. Visit [www.apple.com](http://www.apple.com) and click the Support tab at the top of the Web page.



The Search box works just like the Mac OS Help system, but the Knowledge Base that Apple provides online has a *lot* more answers.

## *Magazines*

Many magazines (both in print and online) offer tips and tricks on using and maintaining Mac OS X Leopard.

My personal online favorites are Macworld ([www.macworld.com](http://www.macworld.com)) and MacAddict ([www.maclife.com](http://www.maclife.com)).

## *Mac support Web sites*

A number of private individuals and groups offer support forums on the Web, and you can often find help from other Mac owners on these sites within a few hours of posting a question.

I'm very fond of MacFixIt ([www.macfixit.com](http://www.macfixit.com)), Mac OS X Hints (<http://forums.macosxhints.com>), and MacMinute ([www.macminute.com](http://www.macminute.com)).

## *Mac newsgroups on Usenet*

If you're familiar with Usenet newsgroups, you can find lots of help (typically dispensed with a healthy dose of opinion) in newsgroups like `comp.sys.mac.system` and `comp.sys.mac.applications`. Simply post a message and then check back within a few hours to read the replies.

## *Local Mac user groups*

I'd be remiss if I didn't mention your local Mac user group. Often, a user group maintains its own Web site and discussion forum. If you can wait until the next meeting, you can even ask your question and receive a reply from a real-live human being . . . quite a thrill in today's Web-riffic world!



# Part II

# Shaking Hands with Mac OS X

The 5th Wave

By Rich Tennant

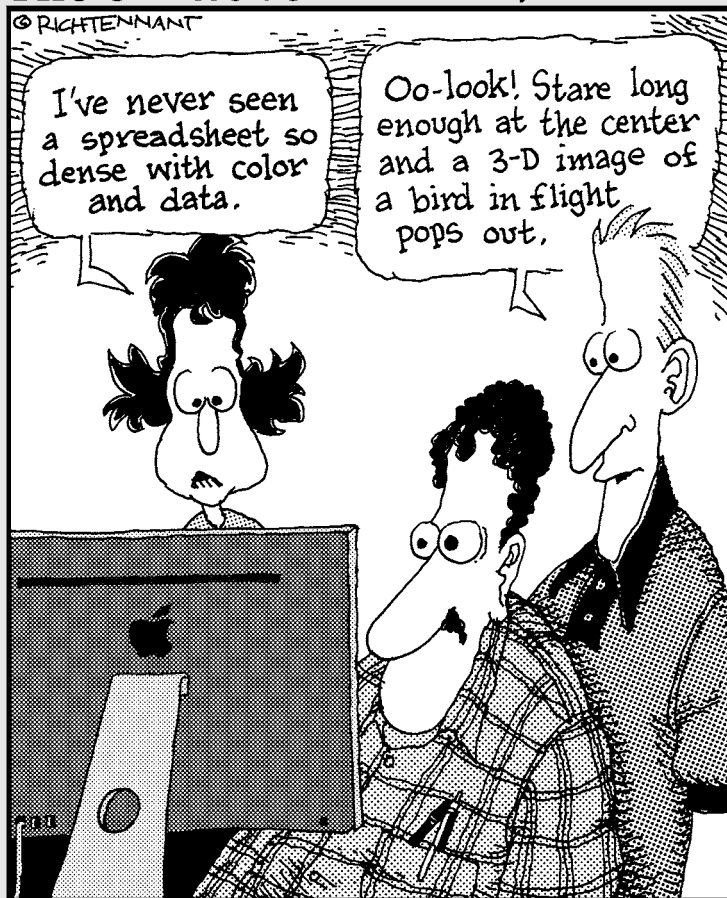

## *In this part . . .*

**I**n this part, you delve deeper into the works of Mac OS X Leopard. I show you how to perform all sorts of common tasks as well as how to customize your system, how to change settings in System Preferences, where your personal files are stored, and how to use the latest Spotlight search technology to find *anything* you've stored on your iMac!

## Chapter 4

# Opening and Closing and Clicking and Such

---

### *In This Chapter*

- ▶ Introducing the highlights of the Finder
  - ▶ Discussing that missing mouse button
  - ▶ Launching and quitting applications
  - ▶ Identifying and selecting icons
  - ▶ Using keyboard shortcuts to speed things up
  - ▶ Managing windows in Leopard
- 

**A**h, the Finder — many admire its scenic beauty, but don't ignore its unsurpassed power nor its many moods. And send a postcard while you're there.

Okay, so Leopard's Finder might not be *quite* as majestic as the mighty Mississippi River, but it's the basic toolbox that you use every single day while piloting your iMac. The Finder includes the most common elements of Mac OS X: window controls, common menu commands, icon fun (everything from launching applications to copying files), network connections, keyboard shortcuts, and even emptying the Trash. In fact, one could say that if you master the Finder and find how to use it efficiently, you're on your way to becoming a power user! (My editor calls this the Finder "window of opportunity." She's a hoot.)

That's what this chapter is designed to do: This is your Finder tour guide, and we're ready to roll.

## *Working within the Finder*

This is a hands-on tour, with none of that, "On your right, you'll see the historic Go menu" for you! Time to get off the bus and start the tour with Figure 4-1, in which I show you around the most important elements of the Finder. (In the





If you're brand new to computers, a *menu* is simply a list of commands. For example, you click the File menu and then choose Save to save a document. When you click a menu, it extends down so that you can see the commands it includes. While the menu is extended, you can choose any enabled menu item (just click it) to perform that action. You can tell that an item is enabled if its name appears in black. Conversely, a menu command is disabled if it is grayed out — clicking it does nothing.



When you see a menu path, like this example — File⇨Save — it's just a visual shortcut that tells you to click the File menu and then choose Save from the drop-down menu that appears.

- ✓ **The Desktop:** Your Desktop serves the same purpose as your physical desktop: You can store stuff here (files, alias icons, and so on), and it's a solid, stable surface where you can work comfortably. Application windows appear on the Desktop, for example, as do other applications, such as your Stickies notes and your DVD player. Just click an application there to launch it.



Your Desktop is easily customized in many ways. For example, you can use your own images to decorate the Desktop, organize it to store new folders and documents, arrange icons how you like, or put the Dock in another location. Don't worry — I cover all this in other areas of the book — I just want you to know that you don't have to settle for what Apple gives you as a default Desktop.

- ✓ **All sorts of icons:** This is a Macintosh computer, after all, replete with tons of make-your-life-easier tools. Check out the plethora of icons on your Desktop as well as icons within the Finder window itself. Each icon is a shortcut of sorts to a file, folder, network connection, or device in your system, including applications that you run and documents that you create. Refer to Figure 4-1 to see the icon for my iMac's hard drive icon, labeled Wolfgang. (I'm a huge Mozart fan.) Sometimes you click an icon to watch it do its thing (like icons in the Dock, which I cover next), but usually you double-click an icon to make something happen.
- ✓ **The Dock:** The Dock is a launching pad for your favorite applications, documents, folders, network connections, and Web sites. You can also refer to it to see what applications are running. Click an icon there to open the item. For example, the postage stamp icon represents the Apple Mail application, and clicking the spiffy compass icon launches your Safari Web browser.
- ✓ **The Finder window:** Finally! The basic Finder window in Figure 4-1 displays the contents of my Applications folder. You use Finder windows to launch applications; perform disk chores, such as copying and moving files; and navigate your hard drive.

## Mousing in a Mac World

Leopard takes a visual approach to everything, and what you see in Figure 4-1 is designed for point-and-click convenience because the mouse is your primary navigational tool while you're using your iMac. You click an item, it opens, you do your thing, and life is good. If you've grazed on the other side of the fence — one of Those Who Were Once Windows Users — you're probably accustomed to using a mouse with at least two buttons. This brings up the nagging question: "Hey, Mark! Where the heck is the right mouse button?"

In a nutshell, the right mouse button on your iMac's Mighty Mouse is the entire right side of the mouse! Although you won't see any separate buttons for right or left click, your Mighty Mouse can tell when you're pushing down on the left or right side of the mouse. There are also two discrete buttons on either side of the Mighty Mouse that perform the same action when you click them — press either one, and you're performing a third action.

Unlike older Apple ancestors of your Mighty Mouse, you even have a scrolling ball that allows you to move in any direction within a document window . . . and the scroll ball acts as a fourth mouse button, too! (So while you're rolling the scroll ball to move up and down through the pages of a document or to move up and down through a long Web page, you can also press down on the ball to perform another action.)

Clicking the right mouse button performs the same default function in Leopard that it does in Windows. Namely, when you click the right mouse button on most items — icons, documents, even your Desktop — you get a *contextual menu* of things. That is, you get more commands specific to that item. (Boy, howdy, I hate that word *contextual*, but that's what engineers call it. I call it the right-click menu, and I promise to refer to it as such for the rest of the book.)

Figure 4-2 illustrates a typical convenient right-click menu within a Finder window. I have all sorts of cool items at my disposal on this menu because of the applications I installed that make use of a right-click menu.



To configure everything Mighty Mouse — including all your buttons and your double-click/tracking/scrolling speeds — visit the Keyboard & Mouse pane within System Preferences. You can also configure your wireless mouse from here as well. (More on the System Preferences window in the next section.)



**Figure 4-2:**  
Well-adjusted folks call this a right-click menu.

## Launching and Quitting for the Lazy iMac Owner

Now it's time for you to pair your newly found mouse acumen with Leopard's Finder window. Follow along this simple exercise. Move your mouse cursor over the iTunes icon in the Dock (this icon looks like an audio CD with a green musical notes on it) and click once. Whoosh! Leopard *launches* (or starts) the iTunes application, and you see a window much like the one in Figure 4-3.



If an application icon is already selected (which I discuss in the next section), you can simply press  $\text{⌘}+\text{O}$  to launch it. The same key shortcut works with documents, too.



Besides the Dock, you have several other ways to launch an application or open a document in Leopard:

- ✓ **From the Apple menu (🍏):** A number of different applications can always be launched anywhere within Leopard from the Apple menu:
  - *System Preferences:* This is where you change all sorts of settings, such as your display background and how icons appear.
  - *Software Update:* This uses the Internet to see whether update patches are available for your Apple software, as I discuss in Chapter 20.
  - *Mac OS X Software:* This launches the Safari browser and displays software that you can download for your iMac.
- ✓ **From the Desktop:** If you have a document that you created or an application icon on your Desktop, you can launch or open it here by *double-clicking* that icon (clicking the mouse twice in rapid succession when the mouse cursor is on top of the icon).





Double-clicking a device or network connection on your Desktop opens the contents in a Finder window. This works for CDs and DVDs that you've loaded as well as for external hard drives and USB Flash drives. Just double-click 'em to open them and display their contents in a Finder window. Applications and documents launch from a CD, a DVD, or an external drive just like they launch from your internal drive (the one that's named Macintosh HD), so you don't have to copy stuff from the external drive just to use it. (You can't change the contents of most CDs and DVDs; they're read-only, so you can't write to them.)

- ✔ **From the Recent Items selection:** When you click the Apple menu and hover your mouse over the Recent Items menu item, the Finder displays all the applications and documents that you used over the past few computing sessions. Click an item in this list to launch or open it.
- ✔ **From the Login Items list:** Login Items are applications that Leopard launches automatically each time you log in to your user account.  
I cover Login Items in detail in Chapter 16.
- ✔ **From the Finder window:** You can also double-click an icon within the confines of a Finder window to open it (for documents), launch it (for applications), or display the contents (for a folder).



The Quick Look feature that debuted with Leopard can display the contents of just about any document or file — without actually opening the corresponding application! *Sweet.* To use Quick Look from a Finder window, click a file to select it and then click the Quick Look button (which bears an eye icon) on the Finder window toolbar.

After you finish using an application, you can quit that application to close its window and return to the Desktop. Here are a number of different ways to quit an application:

- ✔ **Press ⌘+Q.** This keyboard shortcut quits virtually every Macintosh application on the planet. Just first make sure that the application that you want to quit is active!
- ✔ **Choose the Quit command from the application's menu.** To display the Quit command, click the application's name — its menu — from the menu bar. This menu is always to the immediate right of the Apple (🍏) menu. For example, Safari displays a Safari menu, and that same spot in the menu is taken up by iCal when iCal is the active application. In Figure 4-3, look for the iTunes menu, right next to 🍏.
- ✔ **Choose Quit from the Dock.** You can Control-click (or right-click) an application's icon on the Dock and then choose Quit from the right-click menu that appears.



A running application displays a small black triangle under its icons on the Dock.



- ✓ **Click the Close button on the application window; refer to Figure 4-3.** Some applications quit entirely when you close their window, like the System Preferences window or the Apple DVD Player. Other applications might continue running without any window, like Safari or iTunes; to close these applications, you have to use another method in this list.
- ✓ **Choose Force Quit from the Apple menu. *This is a last-resort measure!*** Use this only if an application has frozen and you can't use another method in this list to quit. Force-quitting an application doesn't save any changes to any open documents within that application!

## *Juggling Folders and Icons*

Finder windows aren't just for launching applications and opening the files and documents that you create. You can also use the icons within a Finder window to select one or more specific items or to copy and move items from place to place within your system.

### *A field observer's guide to icons*

Not all icons are created equal. Earlier in this chapter, I introduce you to your iMac's hard drive icon on the Desktop, but here is a little background on the other types of icons that you might encounter during your iMac travels:

- ✓ **Hardware:** These are your storage devices (such as your hard drive and DVD drive) as well as external peripherals (such as your iPod and printer).
- ✓ **Applications:** These icons represent the applications (or programs) that you can launch. Most applications have a custom icon that incorporates the company's logo or the specific application logo, so they're very easy to recognize, as you can see in Figure 4-4. Double-clicking an application usually doesn't load a document automatically; you typically get a new blank document, or an Open dialog box from which you can choose the existing file you want to open.
- ✓ **Documents:** Many of the files on your hard drive are documents that can be opened within the corresponding application, and the icon usually looks similar to the application's icon. Double-clicking a document automatically launches the required application (that is, as long as Mac OS X recognizes the file type).

**Figure 4-4:**  
A collection  
of some of  
my favorite  
application  
icons.



✓ **Files:** Most of the file icons on your system are mundane things (such as preference and settings files, text files, log files, and miscellaneous data files), yet most are identified with at least some type of recognizable icon that lets you guess what purpose the file serves. You also come across generic file icons that look like a blank sheet of paper (used when Leopard has no earthly idea what the file type is).

✓ **Aliases:** An *alias* acts as a link to another item elsewhere on your system. For example, to launch Adobe Acrobat, you can click an Adobe Acrobat alias icon that you can create on your Desktop rather than clicking the actual Acrobat application icon. The alias essentially acts the same way as the original icon, but it doesn't take up the same space — only a few bytes for the icon itself, compared with the size of the actual application. Plus, you don't have to go digging through folders galore to find the original application icon. (Windows Switchers know an alias as a *shortcut*, and the idea is the same although Macs had it first. Harrumph.) You can always identify an alias by the small curved arrow at the base of the icon, and the icon might also sport the tag `alias` at the end of its name.

You have two ways to create an alias. Here's one:

a. *Select the item.*

The following section has details about selecting icons.

b. *Choose File⇨Make Alias, or press ⌘+L.*

Figure 4-5 illustrates a number of aliases, arranged next to their linked files.



**Figure 4-5:**  
No, not the famous girl-spy TV show. These are alias icons in Leopard.



Here's another way to create an alias:

- a. Hold down  $\text{⌘} + \text{Option}$ .
- b. Drag the original icon to the location where you want the alias.

Note that this funky method doesn't add the `alias` tag to the end of the alias icon name!



So why bother to use an alias? Two good reasons:

**Launch an application or open a document from anywhere on your drive.** For example, you can start Pages directly from the folder where you store the documents for your current Pages project. Speed, organization, and convenience . . . life is good.

**Send an alias to the Trash without affecting the original item.** When that school project is finished, you can safely delete the entire folder without worrying about whether Keynote will run the next time you double-click the application icon!



If you move or rename the original file, Leopard is actually smart enough to update the alias, too! However, if the original file is deleted (or if the original is moved to a different volume, such as an external hard drive), the alias no longer works. (Go figure.)

## Selecting items

Often, the menu commands or keyboard commands that you perform in the Finder need to be performed on something: Perhaps you're moving an item to the Trash, or getting more information on the item, or creating an alias for that item. In order to identify the target of your action to the Finder, you need to select one or more items on your Desktop or in a Finder window. In this section, I show you just how to do that.

### Selecting one thing

Leopard gives you a couple of options when selecting just one item for an upcoming action:

- ✓ **Move your mouse pointer over the item and click.** A dark border (or *highlight*) appears around the icon, indicating that it's selected.
- ✓ **If an icon is already highlighted on your Desktop or within a window, move the selection highlight to another icon in the same location by using the arrow keys.** To shift the selection highlight alphabetically, press Tab (to move in order) or press Shift+Tab (to move in reverse order).



Selecting items in the Finder doesn't actually *do* anything to them by itself. You have to perform an action on the selected items to make something happen.

### Selecting a whole bunch of things

You can also select multiple items with aplomb by using one of these methods:

- ✓ **Adjacent items**
  - *Drag a box around them.* If that sounds like ancient Sumerian, here's the explanation: Click a spot above and to the left of the first item; then hold down the mouse button and drag down and to the right. (This is *dragging* in Mac-speak.) A box outline like the one in Figure 4-6 appears, indicating what you're selecting. Any icons that touch or appear within the box outline are selected when you release the mouse button.
  - *Click the first item to select it and then hold down the Shift key while you click the last item.* Leopard selects both items and everything between them.
- ✓ **Nonadjacent items:** Select these by holding down the ⌘ key while you click each item.



**Figure 4-6:**  
Drag a box  
around  
icons to  
select them.



Check out the status line at the bottom of a Finder window. It tells you how much space is available on the drive you're working in as well as how many items are displayed in the current Finder window. When you select items, it shows you how many you highlighted.

## Copying items

Want to copy items from one Finder window to another, or from one location (like a CD-ROM) to another (like your Desktop)? *Très* easy. Just use one of these methods:

### ➤ On the same drive

- *To copy one item to another location:* Hold down the Option key (you don't have to select the icon first) and then click and drag the item from its current home to the new location.



To put a copy of an item within a folder, just drop the item on top of the receiving folder. If you hold the item that you're dragging over the destination folder for a second or two, Leopard opens up a new window so you can see the contents of the target.

- *To copy multiple items to another location:* Select them all first (see the earlier section, “Selecting a whole bunch of things”), hold down the Option key and then drag and drop one of the selected items where you want it. All the items that you selected follow the item you drag. (Rather like lemmings. Nice touch, don’t you think?)

To help indicate your target when you’re copying files, Leopard highlights the location to show you where the items will end up. (This works whether the target location is a folder or a drive icon.) If the target location is a window, Leopard adds a highlight to the window border.

✓ **On a different drive**

- *To copy one or multiple items:* Click and drag the icon (or the selected items if you have more than one) from the original window to a window you open on the target drive. (No need to hold down the Option key whilst moving.) You can also drag one item (or a selected group of items) and simply drop the items on top of the drive icon on your Desktop.

The items are copied to the top level, or *root*, of the target drive.

If you try to move or copy something to a location that already has an item with the same name, Figure 4-7 illustrates the answer: You get a dialog that prompts you to decide whether to replace the file or to stop the copy/move procedure and leave the existing file alone. Good insurance, indeed.



## My, what an attractive Sidebar . . . and so useful!

The Sidebar, which occupies the left side of every Finder window, is a pane of links to common locations and devices that you can use to jump like a flash to a specific spot on your hard drive. For example, click the Applications link under the Places heading, and you’re there in an instant. The Sidebar also contains a Search For heading that displays the applications, files, and folders that you accessed today, yesterday, and during the past week. (Heck, you can even search for all the images, movies, and documents on your system from this same Search For section!)

Here’s a great example of Sidebar magic: I like as few icons on my Desktop as possible, so each book I’m working on gets its own folder. All the items for that project that might otherwise end up on my Desktop are saved into that folder instead. In fact, I make a point of adding my current book project folder to my Finder window Sidebar so that it’s available immediately from any Finder window. To do this, just drag the folder into the column at the left side of the Finder window and drop it under the Places heading in the Sidebar’s list.



**Figure 4-7:**  
Replace  
the existing  
file only if  
you're sure.

## *Moving things from place to place*

Moving things from one location to another location on the same drive is the easiest action you can take. Just drag the item (or selected items) to the new location. The item disappears from the original spot and reappears in the new spot.

## *Duplicating in a jiffy*

If you need more than one copy of the same item within a folder, use the Leopard Duplicate command. I use Duplicate often when I want to edit a document but ensure that the original document stays pristine, no matter what. I just create a duplicate and edit that file instead.

To use Duplicate, you can

- ✓ Click an item to select it and then choose **File⇧Duplicate**.
- ✓ Right-click the item and choose **Duplicate** from the menu.
- ✓ Hold down the **Option** key and drag the original item to another spot **in the same window**. When you release the mouse button, the duplicate file appears like magic!



The duplicate item has the word `copy` appended to its name. A second copy is named `copy2`, a third is `copy3`, and so on.



Duplicating a folder also duplicates all the contents of that folder, so creating a duplicate folder can take some time to create if the original folder was stuffed full. The duplicate folder has `copy` appended to its name, but the contents of the duplicate folder keep their original names.

## Keys and Keyboard Shortcuts to Fame and Fortune

Your iMac keyboard might not be as glamorous as your mouse, but any Macintosh power user will tell you that using keyboard shortcuts is usually the fastest method of performing certain tasks in the Finder, such as saving or closing a file. I recommend committing these shortcuts to memory and putting them to work as soon as you begin using your iMac so that they become second nature to you as quickly as possible.

### Special keys on the keyboard

The Apple standard keyboard has a number of special keys that you might not recognize — especially if you’ve made the smart move and decided to migrate from the chaos that is Windows to Mac OS X! Table 4-1 lists the keys that bear strange hieroglyphics on the Apple keyboard as well as what they do.

<i>Action</i>	<i>Symbol</i>	<i>Purpose</i>
Media Eject	⏏	Ejects a CD or DVD from your optical drive
Audio Mute	⏏	Mutes (and restores) all sound produced by your iMac
Volume Up	⏏)	Increases the sound volume
Volume Down	⏏)	Decreases the sound volume
Command	⌘	Primary modifier for menus and keyboard shortcuts
Del	⌫	Deletes selected text
Option	⌥	Modifier for shortcuts

## Using Finder and application keyboard shortcuts

The Finder is chock-full of keyboard shortcuts that you can use to take care of common tasks. Some of the handiest shortcuts are in Table 4-2.



But wait, there's more! Most of your applications also provide their own set of keyboard shortcuts. While you're working with a new application, display the application's Help file and print out a copy of the keyboard shortcuts as a handy cheat sheet.

<i>Key Combination</i>	<i>Location</i>	<i>Action</i>
⌘+A	Edit menu	Selects all (works in the Finder too)
⌘+C	Edit menu	Copies the highlighted item to the Clipboard
⌘+H	Application menu	Hides the application
⌘+M	Window menu	Minimizes the active window to the Dock (also works in the Finder)
⌘+O	File menu	Opens an existing document, file, or folder (also works in the Finder)
⌘+P	File menu	Prints the current document
⌘+Q	Application menu	Exits the application
⌘+V	Edit menu	Pastes the contents of the Clipboard at the current cursor position
⌘+X	Edit menu	Cuts the highlighted item to the Clipboard
⌘+Z	Edit menu	Reverses the effect of the last action you took
⌘+?	Help menu	Displays the Help system (works in the Finder, too)
⌘+Tab	Finder	Switches between open applications
⌘+Option+M	Finder	Minimizes all Finder windows to the Dock
⌘+Option+W	Finder	Closes all Finder windows



If you've used a PC before, you're certainly familiar with three-key shortcuts — the most infamous being Ctrl+Alt+Delete, the beloved shut-down shortcut nicknamed the Windows Three-Finger Salute. Three-key shortcuts work the same way in Leopard (but you'll be thrilled to know you won't need to reboot by using that notorious Windows shortcut)! If you're new to computing, just hold down the first two keys simultaneously and then press the third key.



You're not limited to just the keyboard shortcuts listed above, either. Within System Preferences, visit the Keyboard & Mouse pane and then click the Keyboard Shortcuts button to change an existing shortcut or add another.

## Performing Tricks with Finder Windows

In this section of your introduction to Mac OS X, I describe basic windows management within Leopard: how to move things around, how to close windows, and how to make 'em disappear and reappear like magic.

### Scrolling in and resizing windows

Can you imagine what life would be like if you couldn't see more than a single window's worth of stuff? Shopping would be curtailed quite a bit — and so would the contents of the folders on your hard drives!

That's why Leopard adds *scroll bars* that you can click and drag to move through the contents of the window. You can either

- ✓ Click the scroll bar and drag it.
- ✓ Click anywhere in the empty area above or below the bar to scroll pages one at a time.
- ✓ Hold down the Option key and click anywhere in the empty area above or below the bar to scroll to that spot in the window.



Of course, you can also use the scroll wheel on your Mighty Mouse to scroll the contents of a window (both vertically and horizontally). To control the scroll wheel's behavior, open System Preferences, click the Keyboard & Mouse pane, and then click the Mouse button.

Figure 4-8 illustrates both vertical and horizontal scroll bars in a typical Finder window.

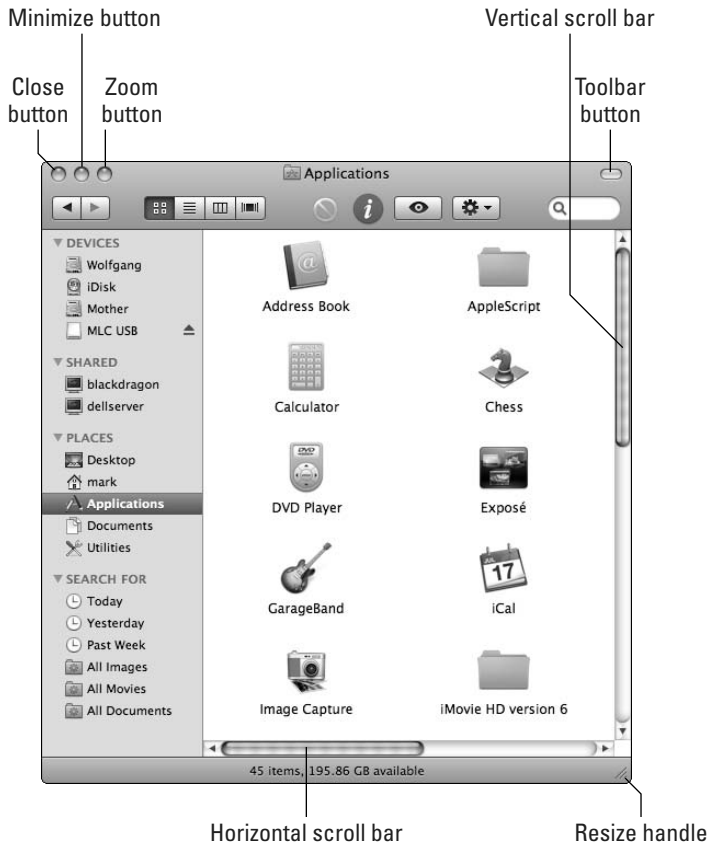

**Figure 4-8:**  
A plethora  
of helpful  
window  
controls.



Often, pressing your Page Up and Page Down keys moves you through a document one page at a time. Also, pressing your arrow keys moves your insertion cursor one line or one character in the four compass directions.

You can also resize most Finder and application windows by enlarging or reducing the window frame itself. Move your mouse pointer over the Resize handle in the lower-right corner of the window (which smartly bears a number of slashed lines to help it stand out) and then drag the handle in any direction until the window is the precise size you need.

## *Minimizing and restoring windows*

Resizing a window is indeed helpful, but maybe you simply want to banish the doggone thing until you need it again. That's a situation for the Minimize button, which also appears in Figure 4-8. A *minimized* window disappears

from the Desktop but isn't closed: It simply reappears in the Dock as a miniature icon. Minimizing a window is easy: Move your mouse pointer over the Minimize button at the top-left corner of the window — a minus sign appears in the button to tell you that you're on target — and then click.



Hold down the Shift key whilst you minimize, and prepare to be amazed when the window shrinks in slow motion like Alice in Wonderland!

To restore the window to its full size again (and its original position on the Desktop), just click its window icon on the Dock.

## Moving and zooming windows

Perhaps you want to move a window to another location on the Desktop so you can see the contents of multiple windows at the same time. Click the window's *title bar* (that's the top frame of the window, which usually includes a document or application name) and drag the window anywhere you like. Then release the mouse button. (Don't click the icon in the center of the title bar, though. You won't move the window, just the icon itself.)



Many applications can automatically arrange multiple windows for you. Choose Window⇨Arrange All menu item (if it appears).

To see all that a window can show you, use the Zoom feature to expand any Finder or application window to its maximum practical size. Note that a zoomed window can fill the entire screen, or (if that extra space isn't applicable for the application) the window might expand only to a larger part of the Desktop. To zoom a window, move your mouse pointer over the button (as shown in the earlier Figure 4-8) at the top-left corner of the window. When the plus sign appears in the Zoom button, click to claim the additional territory on your Desktop. (You can click the Zoom button again to automatically return the same window to its original dimensions.)



### Only one can be active at once™

Yes, here's a very special Mark's Maxim in the Mac OS X universe.

**Only one application window can be active in Leopard at any time.™**

You can always tell which window is active:

✓ **The active window is on top of other windows.**

*Tip:* You can still use a window's Close, Minimize, and Zoom buttons when it's inactive.

✓ **Any input you make by typing or by moving your mouse appears in the active window.**

✓ **Mac OS X *dims* inactive windows that you haven't minimized.**

## toggling toolbars the Leopard way

Time to define a window control that's actually *inside* the window for a change. A *toolbar* is a strip of icons that appears under the window's title bar. These icons typically perform the most common actions within an application; the effect is the same as if you use a menu or press a keyboard shortcut. Toolbars are very popular these days. You see 'em within everything from the Finder window to most application windows.

You can banish a window's toolbar to make extra room for icons, documents, or whatever it happens to be holding. Just click the little lozenge-shaped button at the right corner of the window. (You guessed it — the Toolbar button is also shown in Figure 4-8.) **Note:** If you toggle the Finder toolbar off, you also lose the Finder window Sidebar.

## Closing windows

When you're finished with an application or no longer need a window open, move your mouse pointer over the Close button at the top-left corner of the window. When the X appears in the button, click it. (And yes, I can get one more reference out of Figure 4-8, which I'm thinking of nominating as Figure of the Year.)



TIP

If you have more than one window open in the same application and you want to close 'em all in one swoop, hold down the Option key whilst you click the Close button on any of the windows.



REMEMBER

If you haven't saved a document and you try to close that application's window, Leopard gets downright surly and prompts you for confirmation. "Hey, human, you don't really want to do this, do you?" If you answer in the affirmative — "Why, yes, machine. Yes, indeed, I do want to throw this away and not save it." — the application discards the document that you were working on. If you decide to keep your document (thereby saving your posterior from harm), you can either save the document under the same filename or under a new name.

## Chapter 5

# A Plethora of Powerful Fun

---

### *In This Chapter*

- ▶ Making the most of your Home folder
  - ▶ Arranging your Desktop for greater efficiency
  - ▶ Adding timesavers to the Dock
  - ▶ Using the Trash (and rescuing precious stuff from it)
  - ▶ Using Exposé, Spaces, and Dashboard to perform Desktop magic
  - ▶ Printing documents
- 

**W**hen you're no longer a novice to Leopard and the basics of the Finder, turn your attention to a number of more advanced topics 'n tricks to turn you into an iMac power user — which, after all, is the goal of every civilized consciousness on Planet Earth.

Consider this chapter a grab bag of Leopard knowledge. Sure, I jump around a little, but these topics are indeed connected by a common thread: They're all surefire problem-solvers and speeder-uppers. (I can't believe the latter is really a word, but evidently it is. My editors told me so.)

## *Home, Sweet Home Folder*

Each user account that you create within Leopard is actually a self-contained universe. For example, each user has a number of unique characteristics and folders devoted just to that person, and Leopard keeps track of everything that user changes or creates. (In Chapter 16, I describe the innate loveliness of multiple users living in peace and harmony on your iMac.)

This unique universe includes a different system of folders for each user account on your system. The top-level folder uses the short name that Leopard assigns when that user account is created. Naturally, the actual folder name is different for each person, so Mac techno-types typically refer to this folder as your *Home folder*.

Each account's Home folder contains a set of subfolders, including

- ✓ Movies
- ✓ Music
- ✓ Pictures
- ✓ Downloads (for files you download via Safari)
- ✓ Sites (for Web pages created by the user)
- ✓ Documents (created by the user)

Although you can store your stuff at the *root* (top level) of your hard drive, that gaggle of files, folders, and aliases can get very crowded and confusing very quickly. Here's a Mark's Maxim to live by:



Your Home folder is where you hang out and where you store your stuff. Use it to make your computing life *much* easier!<sup>TM</sup>



Create subfolders within your Documents folder to organize your files and folders even further. For example, I always create a subfolder in my Documents folder for every book that I write so that I can quickly and easily locate all the documents and files associated with that book project.

I discuss security within your Home folder and what gets stored where in Chapter 16. For now, Figure 5-1 shows how convenient your Home folder is to reach because it appears in the Finder window Sidebar. One click of your Home folder, and all your stuff is in easy reach.

In addition to the Finder window Sidebar, you can also reach your Home folder in other convenient ways:

- ✓ **From the Go menu:** Choose Go⇨Home to display your Home folder immediately from the Finder window. Alternatively, you can press ⌘+Shift+H to accomplish the same thing.
- ✓ **From within Open and Save dialogs:** Leopard's standard File Open and File Save dialogs also include the same Home folder (and subfolder) icons as the Finder window Sidebar.
- ✓ **Within any new Finder window you open:** If you like, you can set every Finder window that you open to open automatically within your Home folder.
  - a. Choose Finder⇨Preferences to display the dialog that you see in Figure 5-2.
  - b. Click the arrow button at the right side of the New Finder Windows Open pop-up menu.

A menu pops up (hence, the name).



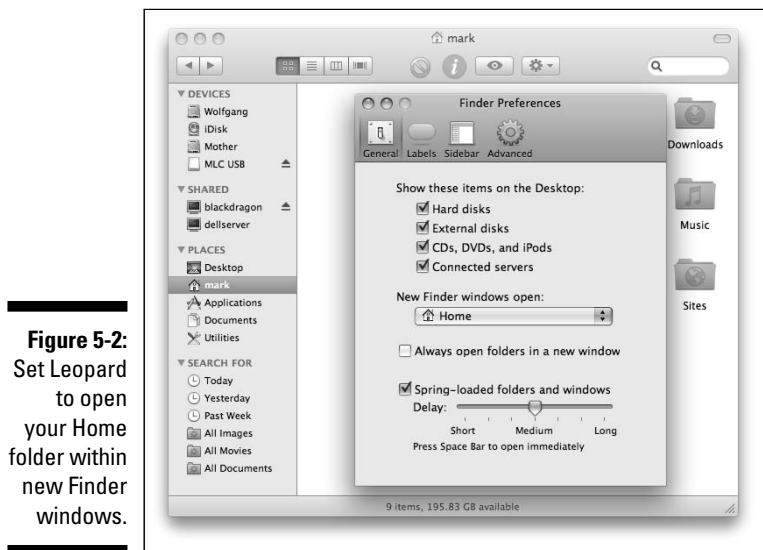
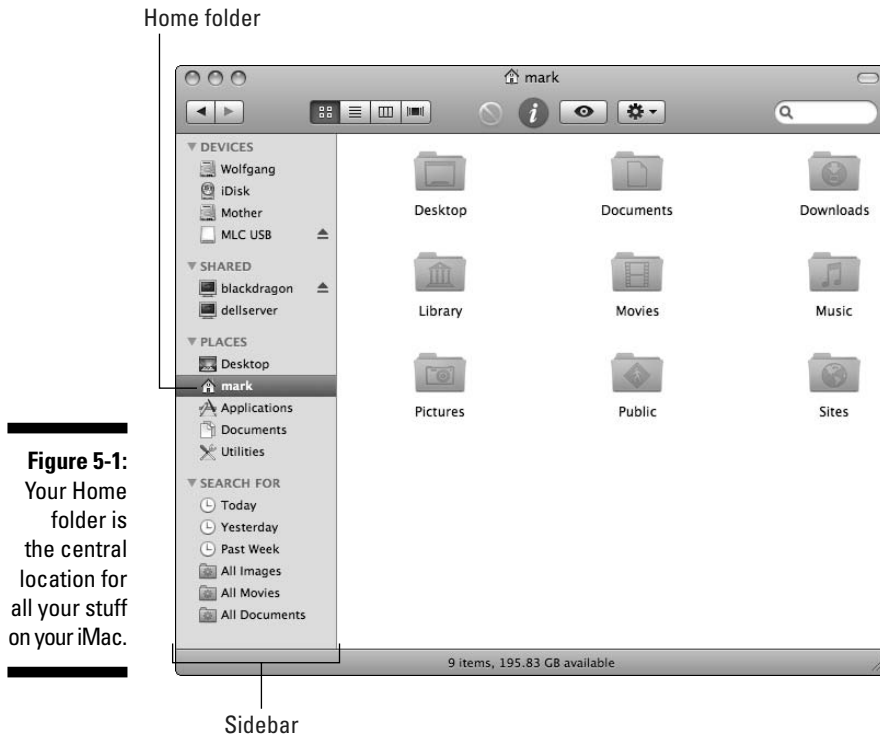

- c. Click the Home entry in the menu.
- d. Click the Close button at the top-left corner of the dialog.

You're set to go. From now on, every Finder window you open displays your Home folder as the starting location!



Here's another reason to use your Home folder to store your stuff: Leopard expects your stuff to be there when you migrate your files from an older Mac to a new Mac.

## Arranging Your Desktop

Most folks put all their documents, pictures, and videos on their Leopard Desktop because the file icons are easy to locate! Your computing stuff is right in front of you . . . or *is* it?

Call me a finicky, stubborn fussbudget — go ahead, I don't mind — but I prefer a clean Leopard Desktop without all the iconic clutter. In fact, my Desktop usually has just three or four icons even though I use my iMac several hours every day. It's an organizational thing; I work with literally hundreds of applications, documents, and assorted knickknacks daily. Sooner or later, you'll find that you're using that many, too. When you keep your stuff crammed on your Desktop, you end up having to scan your screen for one particular file, an alias, or a particular type of icon, which ends up taking you more time to locate it on your Desktop than in your Documents folder!

Plus, you'll likely find yourself looking at old icons that no longer mean anything to you or stuff that's covered in cobwebs that you haven't used in years. Stale icons . . . *yuck*.

I recommend that you arrange your Desktop so you see only a couple of icons for the files or documents that you use the most. Leave the rest of the Desktop for that cool image of your favorite actor or actress.

Besides keeping things clean, I can recommend a number of other favorite tweaks that you can make to your Desktop:

### ✔ Keep Desktop icons arranged as you like.

- a. From the Finder menu, choose View⇨Show View Options.
- b. Select the Arrange By check box.
- c. From the pop-up menu, choose the criteria that Leopard uses to automatically arrange your Desktop icons, including the item name, the last modification date, or the size of the items.

I personally like things organized by name.

✔ **Choose a favorite background.**

- a. Hold down the Control key while you click any open spot on your Desktop. (Or, if you use a pointing thing with a right mouse button, click that instead.)
- b. From the right-click menu that appears, choose *Change Desktop Background*.

You see the Desktop & Screen Saver pane appear, as shown in Figure 5-3. Browse through the various folders of background images that Apple provides or use an image from your iPhoto library.

✔ **Display all the peripherals and network connections on your system.**

- a. Choose *Finder* → *Preferences*.
- b. Make sure that all four of the top check boxes (*Hard Disks*; *External Disks*; *CDs, DVDs, and iPods*; and *Connected Servers*) are enabled.

If you're connected to an external network or you've loaded an external hard drive or device, that shows up on your Desktop. You can double-click that Desktop icon to view your external stuff.



**Figure 5-3:**  
Choose a  
Desktop  
background  
of more  
interest.

## Putting the Dock to the Test

If the Dock seems like a nifty contraption to you, you're right again — it's like one of those big control rooms that NASA uses. From the *Dock* — that icon toolbar at the bottom of Leopard's Desktop — you can launch an application, monitor what's running, and even use the pop-up menu commands to control the applications that you launch. (Hey, that NASA analogy is even better than I thought!)



By default, the Dock hangs out at the bottom of your screen, but you can move it to another edge, change the size of the icons, or even hide it until it's necessary. (You can find more details on customizing your Dock in Chapter 6.)

When you launch an application — either by clicking an icon on the Dock or by double-clicking an icon in a Finder window or the Desktop — the icon begins to bounce hilariously on the Dock to indicate that the application is loading. (So much for my Mission Control analogy.) After an application is running, the application icon appears on the Dock with a shiny blue dot underneath. Thusly, you can easily see what's running at any time just by glancing at the Dock.



You can hide most applications by pressing  $\text{⌘}+\text{H}$ . Although the application itself is still running, it might not appear on the Dock.



Some applications run in the *background* — that is, they don't show up on the Dock. You generally don't even know that these applications are working for you. However, if you need to see in detail what's going on, you can always use the Activity Monitor utility to view everything that's happening on your iMac. (For example, an Apple support technician might ask you to run Activity Monitor to help troubleshoot a problem.) To run the Activity Monitor

1. **Open a Finder window.**
2. **Click the Applications folder in the Sidebar.**
3. **Double-click the Utilities folder to open it.**
4. **Double-click the Activity Monitor icon.**

## Adding Dock icons

Ah, but there's more: The Dock can offer more than just a set of default icons! You can add your own MIS (or *Most Important Stuff*) to the Dock, making it the most convenient method of taking care of business without cluttering up your Desktop. You can add



- ✓ **Applications:** Add any application to your Dock by dragging the application icon into the area to the left of the *separator line* (the vertical dotted line on the Dock which appears between applications and folders or documents). The existing Dock icons move aside so that you can place the new neighbor in a choice location.

Do not try to add an application anywhere to the right of the separator line. You can't put applications there — and Leopard might even think that you want the application dumped in the Trash!



- ✓ **Folders:** Here's where you want to add things to the area to the right of the separator line. A folder or volume icon that you drag to the Dock is called a *Stack* in Leopard, and you can display the contents with a single click. (The contents of the folder “fan out” into a half-circle or grid arrangement, depending on the number of items in the folder.) To open or launch an item, just click it in the Stack display.

Leopard already includes two Stacks in the Dock by default: your Documents folder and your Downloads folder.

- ✓ **Web URLs:** Sure, you can add your favorite Web site from Safari! Drag it right from the Safari Address bar into the area to the right of the separator line. When you click the URL icon, Safari opens the page automatically.

## Removing Dock icons

You can remove an icon from the Dock at any time (as long as the application isn't running). In fact, I always recommend that every Leopard user remove the default icons that never get used to make more room available for your favorite icons. The only two icons you can't remove are the Finder and the Trash icons. To remove an icon from the Dock, just click and drag it off the Dock. You're rewarded with a ridiculous puff of smoke straight out of a Warner Brothers cartoon! (One of the Mac OS X developers was in a fun mood, I guess.)



When you delete an icon from the Dock, all you delete is the Dock icon: The original application, folder, or volume is not deleted.

## Using Dock icon menus

From the Dock menu, you can open documents, open the location in a Finder window, set an application as a Login Item, control the features in some applications, and other assorted fun, depending on the item.

To display the right-click Dock menu for an icon

1. **Move your mouse over the icon.**
2. **Right-click.**

Note that you can also press the Control key and click the icon, or even hold down the left mouse button for a second or two.



I cover the Dock settings that you can change within System Preferences in Chapter 6. You can also change the same settings from the Apple menu if you hover your mouse over the Dock item, which displays a submenu with the settings.

## What's with the Trash?

Another sign of an iMac power user is a well-maintained Trash bin. It's a breeze to empty the discarded items you no longer need, and you can even rescue something that you suddenly discover you still need!

The Leopard Trash bin resides on the Dock, and it works just like the Trash has always worked in Mac OS X: Simply drag selected items to the Trash to delete them.



Note one very important exception: If you drag an external device or removable media drive icon on your Desktop to the Trash (such as an iPod, iPhone, DVD, or an external hard drive), the Trash bin icon automatically turns into a giant Eject icon, and the removable device or media is ejected or shut down — not erased. Repeat, *not erased*. (That's why the Trash icon changes to the Eject icon — to remind you that you're not doing anything destructive.)

Here are other methods of chunking items you select to go to the wastebasket:

- ✓ Choose File⇨Move to Trash.
- ✓ Click the Action button on the Finder toolbar and choose Move to Trash from the list that appears.
- ✓ Press ⌘+Delete.
- ✓ Right-click the item and choose Move to Trash from the right-click menu.

You can always tell when the Trash contains at least one item because the basket icon is full of crumpled paper! However, you don't have to unfold a wad of paper to see what the Trash holds: Just click the Trash icon on the Dock to display the contents of the Trash. To rescue something from the Trash, drag the item(s) from the Trash folder to the Desktop or to any other folder in a Finder window. (If you're doing this for someone else who's not familiar with Leopard, remember to act like it was a lot of work, and you'll earn big-time DRP, or *Data Rescue Points*.)

When you're sure that you want to permanently delete the contents of the Trash, use one of these methods to empty the Trash:

✓ **Choose Finder → Empty Trash.**

✓ **Choose Finder → Secure Empty Trash.**

If security is an issue around your iMac and you want to make sure that no one can recover the files you've sent to the Trash, using the Secure Empty Trash command takes a little time but helps to ensure that no third-party hard drive repair or recovery program could resuscitate the items you discard.

✓ **Press ⌘+Shift+Delete.**

✓ **Right-click the Trash icon on the Dock and then choose Empty Trash from the right-click menu.**

## *Working Magic with Dashboard, Exposé, and Spaces*

iMac power users tend to wax enthusiastic over the convenience features built into Leopard. In fact, we show 'em off to our PC-saddled friends and family. Three of the features that I've demonstrated the most to others are Leopard's Dashboard display, the brand-new Spaces Desktop manager, and the amazing convenience of Exposé. In this section, I show 'em off to you as well. (Then you can become the Leopard evangelist on *your* block.)

### *Using Dashboard*

The idea behind Dashboard is deceptively simple yet about as revolutionary as it gets for a mainstream personal computer operating system. *Dashboard* is an alternate Desktop that you can display at any time by using the keyboard or your mouse; the Dashboard desktop holds *widgets* (small applications that each provide a single function). Examples of default widgets that come with Leopard include a calculator, a world clock, weather display, and a dictionary/thesaurus.

Oh, did I mention that you're not limited to the widgets that come with Leopard? Simply click the plus button at the bottom of the Dashboard display and drag new widgets to your Dashboard from the menu at the bottom of the screen. To remove a widget while you're in this mode, click the X icon that appears next to each widget. When you're done with your widgets — that sounds a bit strange, but I mean no offense — press the Dashboard key again to return to your Desktop.

## Previewing images and documents the Leopard way

Leopard's new Quick Look feature (available on the Finder window toolbar) has garnered a lot of attention within the technology press, and rightly so. Just select a file and click the Quick Look button (or just press the space bar), and Leopard instantly displays the contents of the document or image, *without opening the application*. Heck, I've been waiting for such a magic lamp for two decades now!

However, don't forget that Mac OS X has always offered a Swiss Army knife application for viewing image files and documents: namely, Preview. You can use Preview to display digital photos in several popular image formats, including TIFF, GIF, PICT, PNG, JPEG, and Windows Bitmap.

I know, if that were the sum total of Preview's features, it wouldn't deserve coverage here. So, what else can it do? Here's a partial list (just my favorites, mind you):

- ✔ **Use Preview to add a bookmark at the current page within a PDF document by choosing Bookmarks⇨Add Bookmark.**
- ✔ **Fill out a form in a PDF document by choosing Tools⇨Text Tool.**

Click an area that's marked as an input field, and you can type text into that field. After you complete the form, you can fax or print it.

- ✔ **Take a screen snapshot (saving the contents of your screen as a digital photo) by choosing File⇨Grab⇨Timed Screen.**

Preview launches the Grab utility, which displays an onscreen timer and then snaps the image for you after ten seconds. (This gives you time to get things just right before saying, "Cheese!")

- ✔ **Convert an image into another format or into a PDF file by choosing File⇨Save As.**

If a PDF document can be edited, you can delete or insert pages at will.

- ✔ **Resize or rotate an image by using the commands on the Tools menu.**

Leopard automatically loads Preview when you double-click an image in a format that it recognizes or when you double-click a PDF file. It also acts as the Print Preview window, as you can read elsewhere in this chapter. However, if you want to launch Preview manually, open a Finder window, click the Applications folder in the Sidebar, and then double-click the Preview icon.



Widgets can also be rearranged any way you like by dragging them to a new location.

Simple applications like these are no big whoop — after all, Mac OS X has always had a calculator and a clock. What's revolutionary is how you access your widgets. You can display and use them anywhere in Leopard, at any time, by simply pressing the Dashboard key. The default key is F12 although you can change the Dashboard key via the Exposé & Spaces pane within System Preferences (or even turn it into a key sequence, like Option+F12). You can also click the Dashboard icon on the Dock to summon your Dashboard widgets and then banish the Dashboard when you're done.





Click the scroll ball on your Mighty Mouse to display your Dashboard.

A WebClip widget can include text, graphics, and links, which Dashboard updates every time you display your widgets. Think about that for a second: Dynamic displays, such as weather maps, cartoons, and even the Free Music Download image from the iTunes Store are all good sources of WebClip widgets! (That last one is a real timesaver.)

Leopard even allows you to create your own Dashboard widgets! That's right, this new feature is sure to be a winner amongst the In Crowd. Follow these steps to create a new WebClip Dashboard widget from your favorite Web site:

1. **Run Safari and navigate to the site you want to view as a widget.**
2. **Click the Open This Page in Dashboard button on the Safari Toolbar, which bears a pair of scissors and a dotted box.**
3. **Select the portion of the page you want to include in your widget.**

Most Web pages use frames to organize and separate sections of a page, so this step allows you to choose the frame with the desired content.

4. **Drag the handles at the edges of the selection border to resize your widget frame to the right size and then click Add.**

Bam! Leopard displays your new WebClip widget within Dashboard.

When you click a link in a WebClip widget, Dashboard loads the full Web page in Safari, so you can even use WebClips for surfing chores with sites you visit often.

## *Switching between apps with Exposé*

In Chapter 4, you can read about using the  $\mathbb{C}$ +Tab keyboard shortcut switches between your open applications. If you've moved to the iMac from a PC running Windows, you might think this simple shortcut is all there is to it. Ah, dear reader, you're in Leopard territory now!

Exposé is a rather racy-sounding feature, but (like Dashboard) it's really all about convenience. If you typically run a large number of applications at the same time, Exposé can be a real timesaver, allowing you to quickly switch between a forest of different application windows (or display your Desktop instantly without those very same windows in the way). The feature works in three ways:

- ✓ **Press the All Windows key (or key sequence) to display all your application windows on a single screen, as shown in the truly cool Figure 5-4. (By default, F9 is the All Windows key.)**

Then just click the window that you want to make active.

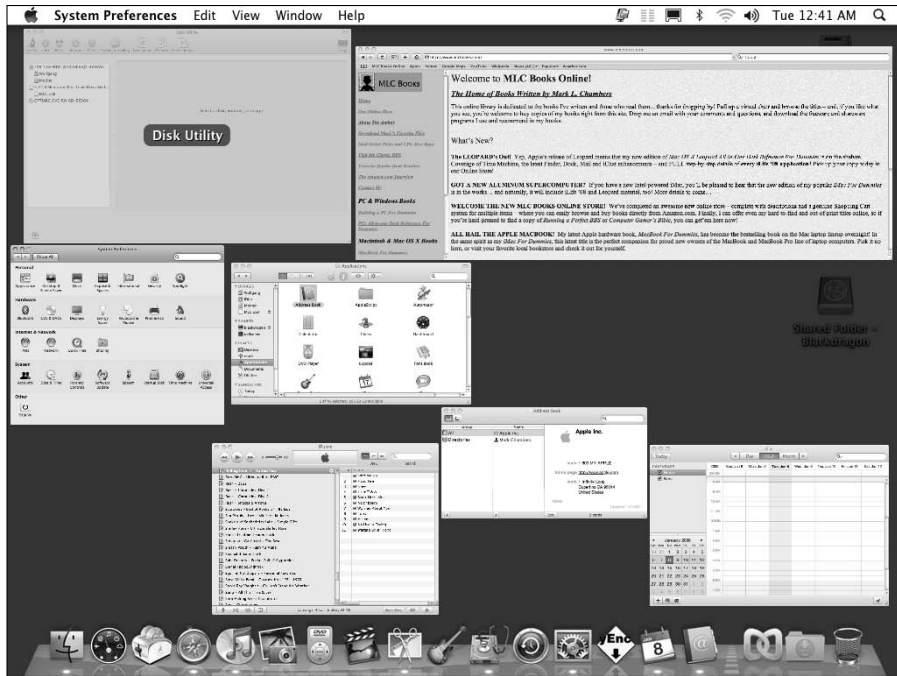

**Figure 5-4:**  
With  
Exposé,  
you can  
instantly see  
every open  
application's  
window(s).

- **Press the Application Windows key (or key sequence) to display all the windows that have been opened by the active application. (By default, F10 is the Application Windows key.)**

This comes in handy with those mega-applications, such as Photoshop Elements or FileMaker Pro, in which you often have three or four windows open at one time. Again, you can click the window that you want to make active.

- **Press the Desktop key (or key sequence) to move all your application and Finder windows to the sides of your Desktop so you can access your Desktop icons. (The default Desktop key is F11.)**

After you're done with your Desktop and you want to restore your windows to their original locations, press the Desktop key (F11) again to put things back.

## *Switching between desktops with Spaces*

Ah, but what if you want to switch to an entirely different *set* of applications? For example, suppose that you're slaving away at your pixel-pushing job, designing a magazine cover with Pages. Your page design desktop also includes Photoshop and Aperture, which you switch between often using one of the

techniques I just described. Suddenly, however, you realize you need to schedule a meeting with others in your office using iCal, and you also want to check your e-mail in Apple Mail. What to do?

Well, you could certainly launch those two applications on top of your graphics applications, and then minimize or close them. With Leopard's new *Spaces* feature, though, you can press the Control+← or Control+→ sequences to switch to a completely different “communications” desktop, with iCal and Apple Mail windows already open and in your favorite positions! Figure 5-5 illustrates the Spaces screen, showing two available desktops.

After you're done setting up your meeting and answering any important e-mail, simply press Control+← or Control+→ again to switch back to your “graphics” desktop, where all your work is exactly as you left it!

Now imagine that you've also created a custom “music” desktop for GarageBand and iTunes . . . or perhaps you joined iWeb, Safari, and iPhoto as a “Webmaster” desktop. See why everyone's so excited? (Let's see Windows Vista do *that* out of the box.)

Unlike Exposé, Spaces has to be enabled and configured before you can use it. You can create new desktops, customize your desktops, and even choose a different set of key sequences to activate Spaces from within System Preferences. For the complete story on configuring Spaces, see Chapter 6.

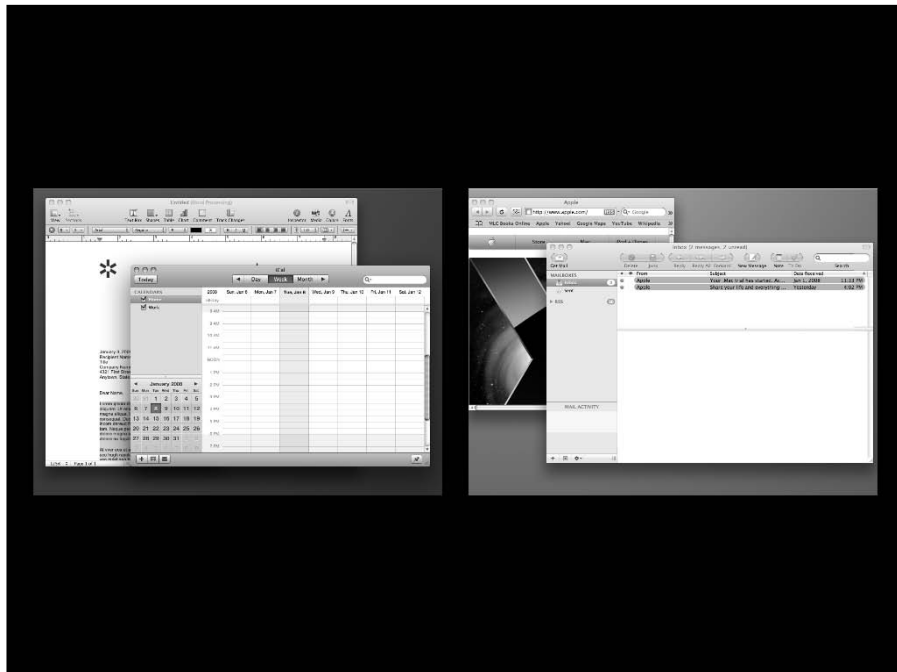

**Figure 5-5:**  
With Spaces, you can instantly switch between multiple desktops!



You can activate Exposé, Spaces, and Dashboard by using your mouse instead of the keyboard:

1. **Click the System Preferences icon on the Dock.**
2. **Click the Exposé & Spaces icon to display the settings.**
3. **Click the desired Screen Corner pop-up menu to choose what function that screen corner will trigger.**
4. **Press ⌘+Q to save your changes and then exit System Preferences.**

When you move your mouse pointer to that corner, the feature you've specified automatically kicks in.

## *Printing within Mac OS X*

Leopard makes document printing a breeze. Because virtually all Mac printers use a Universal Serial Bus (USB) port, setting up printing couldn't be easier. Just turn on your printer and connect the USB cable between the printer and your iMac; Leopard does the rest.



Printer manufacturers supply you with installation software that might add cool extra software or fonts to your system. Even if Leopard recognizes your USB printer immediately, I recommend that you still launch the manufacturer's Mac OS X installation disc. For example, my new Epson printer came with new fonts and a CD/DVD label application, but I wouldn't have 'em if I hadn't installed the Epson software package.

After your printer is connected and installed, you can use the same procedure to print from within just about every Mac OS X application on the planet! To print with the default page layout settings — standard 8 1/2-x-11" paper, portrait mode, no scaling — follow these steps:

1. **Within the active application, choose File⇨Print or press the ⌘+P shortcut.**

Mac OS X displays the Print sheet, as shown in Figure 5-6.

2. **From this dialog, you can**

- *Print from a different printer connected to your iMac or print over a network connection to a shared printer on another computer.*

Click the Printer pop-up menu. In this pop-up menu, Leopard displays all the printers that you can access.



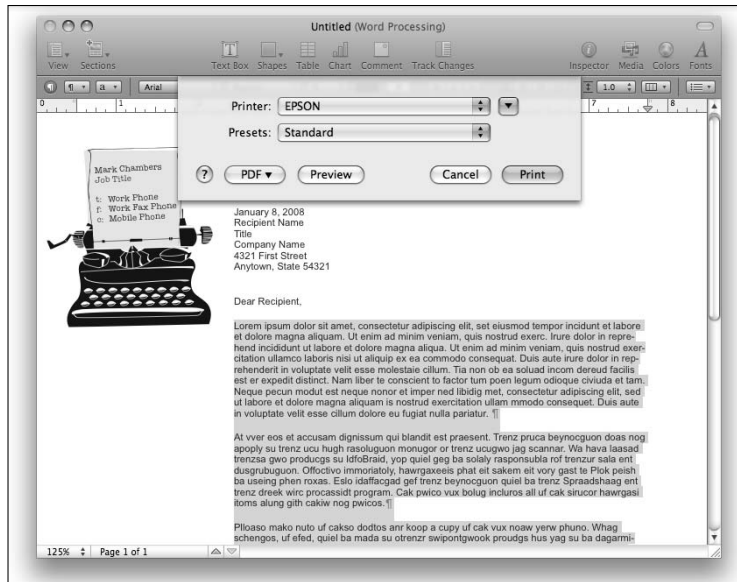

**Figure 5-6:**  
Preparing  
to print  
the Great  
American  
Novel.

- Check what the printed document will look like.

Click Preview to open it within the very same Preview application I discuss earlier in this chapter.

If you have to make changes to the document or you need to change the default print settings, click Cancel to return to your document. (You have to repeat Step 1 again to display the Print dialog again.)



If everything looks good at this point and you don't need to change any settings (like multiple copies or to print only a portion of the document), click Print — you're done! If not, click the Expand button next to the Printer pop-up menu. (It bears a downward-pointing arrow.) Now you can proceed with these steps:



1. **(Optional)** For more than one copy, click in the Copies field and type the number of copies that you need.

Collation (separating copies) is also available, and it doesn't cost a thing!

2. **(Optional)** To print a range of selected pages, select the From radio button and then enter the starting and ending pages.

To print the entire document, leave the default Pages option set to All.

- 3. (Optional) If the application offers its own print settings, such as col-  
lating and grayscale printing, make any necessary changes to those  
settings.**

To display these application-specific settings, click the pop-up menu in the Print dialog and choose the desired settings pane that you need to adjust. (You can blissfully ignore these settings and skip this step entirely if the defaults are fine.)

- 4. When you're set to go, click Print.**



You can also save an electronic version of a document in the popular Adobe Acrobat PDF format from the Print dialog — without spending money on Adobe Acrobat. (*Slick.*)

- 1. Click the PDF button to display the destination pop-up menu.**
- 2. Click Save as PDF.**

Leopard prompts you with a Save As dialog, where you can type a name for the PDF document and specify a location on your hard drive where the file should be saved.

Heck, if you like, you can even fax a PDF (with an external USB modem) or send it as an e-mail attachment! Just choose these options from the destination list rather than Save as PDF.

## Chapter 6

# A Nerd's Guide to System Preferences

---

### *In This Chapter*

- ▶ Navigating System Preferences
  - ▶ Searching for specific controls
  - ▶ Customizing Leopard from System Preferences
- 

**R**emember the old TV series *Voyage to the Bottom of the Sea*? You always knew you were on the bridge of the submarine Seaview because it had an entire wall made up of randomly blinking lights, crewmen darting about with clipboards, and all sorts of strange and exotic-looking controls on every available surface. You could fix just about anything by looking into the camera with grim determination and barking out an order. After all, you were On The Bridge. That's why virtually all the dialog and action inside the sub took place on that one (expensive) set: It was the nerve center of the ship, and a truly happenin' place to be.

In the same vein, I devote this entire chapter to the System Preferences window and all the settings within it. After all, if you want to change how Leopard works or customize the features within our favorite operating system, this one window is the nerve center of Mac OS X, and a truly happenin' place to be. (Sorry, no built-in wall of randomly blinking lights — but there are exotic controls just about everywhere.)

## *A Not-So-Confusing Introduction*

The System Preferences window (as shown in Figure 6-1) is a self-contained beast, and you can reach it in a number of ways:

- ✓ Click the Apple menu (🍏) and choose the System Preferences menu item.
- ✓ Click the System Preferences icon in the Dock.

- ✓ Click the Apple menu (), choose Dock, and then choose the Dock Preferences menu item.
- ✓ Click the Time and Date display in the Finder menu and then choose the Open Date and Time menu item.
- ✓ Control-click (or right-click) any uninhabited area of your Desktop and then choose Change Desktop Background.
- ✓ Click most of the Finder menu status icons and then choose the Open Preferences menu item. (This includes the Bluetooth, AirPort, Display, Modem, and Clock icons.)

When the System Preferences window is open, you can click any of the group icons to switch to that group's *pane*; the entire window morphs to display the settings for the selected pane. For example, Figure 6-2 illustrates the Sound pane, which allows you to set a system alert sound, configure your iMac's built-in microphone, and choose from several different output options.

Many panes also include a number of tabbed buttons at the top — in this case, Sound Effects, Output, and Input. You can click these tabs to switch to another *panel* within the same pane. Many panes within System Preferences have multiple panels. This design allows our friends at Apple to group a large number of related settings together in the same pane (without things getting too confusing).

To return to the top-level System Preferences panel from any pane, just click the Show All button (top left) or press  $\mathbb{A}+L$ . You can also click the familiar Previous and Next buttons to move backward through the panes you've already visited and then move forward again, in sequence. (Yep, these buttons work just like the browser controls in Safari. Sometimes life is funny that way.)

You won't find an OK button that you have to click to apply any System Preference changes — Apple's developers do things the right way. Your changes to the settings in a pane are automatically saved when you click Show All or when you click the Close button on the System Preferences window. You can also press  $\mathbb{A}+Q$  to exit the window and save all your changes automatically . . . a favorite shortcut of mine.



If you see an Apply button in a pane, you can click it to immediately apply any changes you made, without exiting the pane. This is perfect for some settings that you might want to try first before you accept them, like many of the controls on the Network pane. However, if you're sure about what you changed and how those changes will affect your system, you don't have to click Apply. Just exit the System Preferences window or click Show All as you normally would.



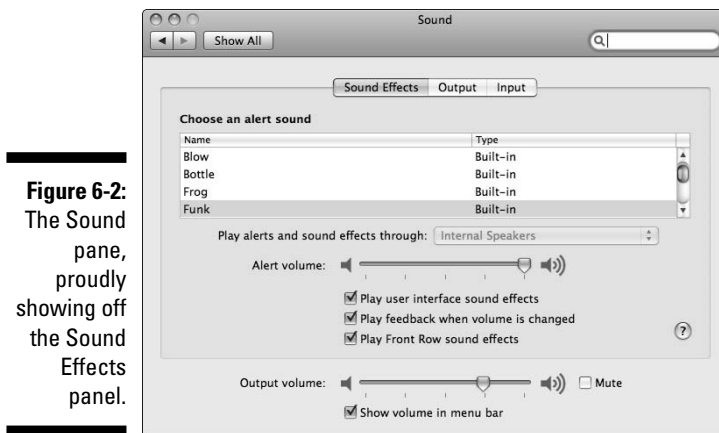
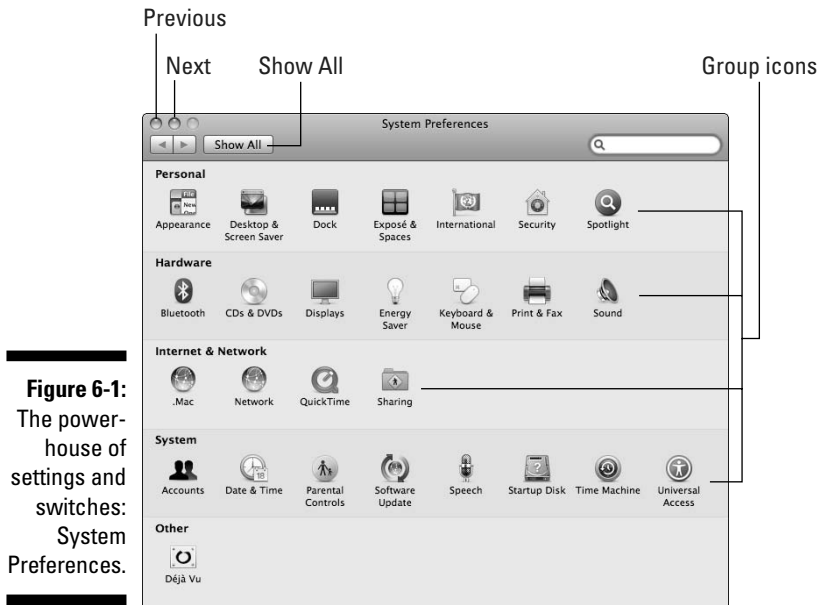

## Searching for Settings

Hey, wouldn't it be great if you could search through all the different panes in System Preferences — with all those countless radio buttons, check boxes, and slider controls — from one place? Even when you're not quite sure exactly what it is you're looking for?

Figure 6-3 illustrates exactly that kind of activity taking place. Just click in the System Preferences Spotlight Search box (upper right, with the magnifying glass icon) and type in just about anything. For example, if you know part of the name of a particular setting you need to change, type that. Leopard highlights the System Preferences panes that might contain matching settings. And if you're a *Switcher* from the Windows world, you can even type in what you might have called the same setting in Windows XP or Vista!



**Figure 6-3:** Searching for specific settings is a breeze with the Search box.

The System Preferences window dims, and the group icons that might contain what you're looking for stay highlighted. *Slick.*



You can also search for System Preferences controls by using the Spotlight menu and Spotlight window. Find more on this cool feature in Chapter 7.

If you need to reset the Search box to try again, click the X icon that appears at the right side of the box to clear it.

## Popular Preference Panes Explained

Time to get down to brass tacks. Open up the most-often-used panes in System Preferences to see what magic you can perform! I won't discuss every pane because I cover many of them in other chapters. (In fact, you might never need to open some System Preferences panes at all, like the .Mac pane.) However, this chapter covers just about all the settings that you're likely to use on a regular basis.

## The Displays pane

If you're a heavy-duty game player or you work with applications like video editing and 3-D modeling, you probably find yourself switching the characteristics of your monitor on a regular basis. To easily accomplish switching, visit the Displays pane (see Figure 6-4), which includes two panels:



- ✓ **Display:** Click a screen resolution to choose it from the Resolutions list on the left. Leopard displays the number of colors (or *color depth*) allowed at that resolution, and you can pick a color depth from the Colors pop-up menu. (Typically, it's a good idea to use the highest resolution and the highest number of colors.) If you have an external monitor connected to your iMac, click the Detect Displays button to scan for that monitor. Because iMacs running Leopard have a flat-panel LCD, the refresh rate is disabled. However, if you're using a CRT display, I recommend choosing the highest refresh rate allowed. Drag the Brightness slider to change the brightness level of your display.

When you enable (mark) the Show Displays in Menu Bar check box, you can switch resolutions and color levels right from the Finder menu!

- ✓ **Color:** Your iMac can use a *color profile* file that controls the colors on your display. This setting comes in handy for graphic artists and illustrators who need color output from their printers that closely matches the colors displayed by the iMac. Click the Calibrate button to launch the Display Calibrator, which can create a custom ColorSync profile and calibrate the colors that you see on your monitor.

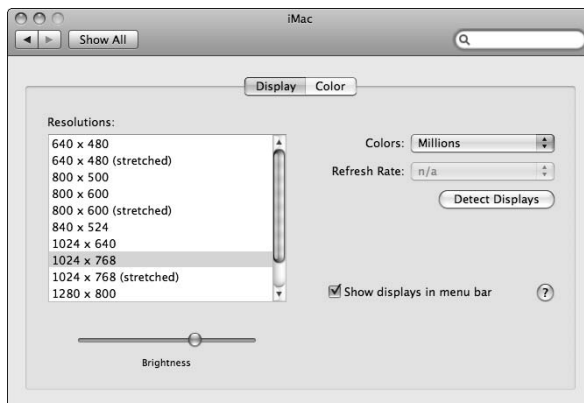

**Figure 6-4:**  
The Displays pane also comes in a handy Finder menu bar size!

## The Desktop & Screen Saver pane

Hey, no offense to the awesome Aurora background (new with Leopard), but who doesn't want to choose their own background? And what about that nifty screen saver you just downloaded from the Apple Web site? You can change both your background and your screen saver by using these options on the Desktop & Screen Saver pane.

The settings on the Desktop panel (as shown in Figure 6-5) include

- ✓ **Current Desktop picture:** To change your Desktop background, click a thumbnail. You can also drag a picture from a Finder window or the desktop and drop it into the *well* (the fancy Apple word for the square box with the sunken look). Leopard automatically updates your Desktop so you can see the results. To open another collection of images from Apple, click the desired collection folder in the list on the left of the panel. (I recommend the stunning images in the Nature folder.) If you want to open a different folder with your own images, click the Add button (which bears a plus sign) at the lower left of the panel and then navigate to that folder.
- ✓ **Arrangement:** You can automatically fit an image to your screen, *tile* your background image (repeat it across the Desktop), center it, and stretch it to fill the screen. Because the images from Apple are all sized correctly already, the Arrangement control appears only when you're using your own pictures.

**Figure 6-5:**  
Show The  
Man who's  
boss and  
pick your  
own  
Desktop  
background.

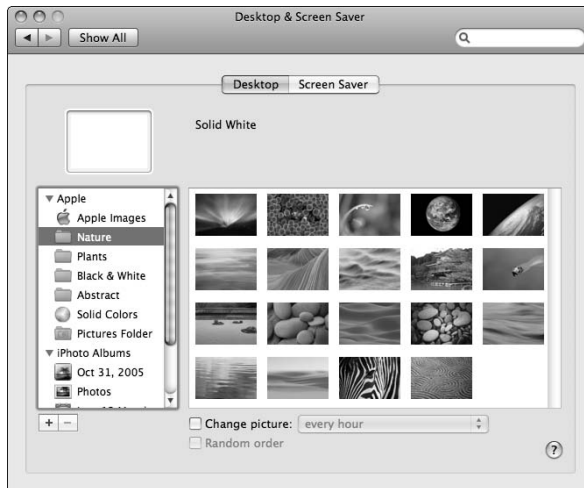

- ✔ **Change Picture:** If you like a bit of automatic variety on your Desktop, select the Change Picture check box. You can click the drop-down list box to set the delay period. The images in the current collection or folder are then displayed in the sequence in which they appear in the thumbnail list.
- ✔ **Random Order:** Select this check box to throw caution utterly to the wind and display random screens from the current collection or folder!

The settings on the Screen Saver tab include



- ✔ **Screen Savers:** Click the screen saver that you want to display from the Screen Savers list. Leopard displays an animated preview of the selected saver on the right. You can also click the Test button to try out the screen saver in full-screen mode. (Move your mouse a bit to end the test.)  
If the selected screen saver has any settings you can change, the Options button displays them.
- ✔ **Start Screen Saver:** Drag this slider to choose the period of inactivity that triggers the screen saver. Choose Never to disable the screen saver entirely.
- ✔ **Use Random Screen Saver:** Another chance to rebel against conformity! Enable this check box, and Leopard picks a different screen saver each time.
- ✔ **Show With Clock:** Enable this check box, and Leopard adds a smart clock display to your screen saver. (A great help for those of us who spend many minutes on the phone.)
- ✔ **Hot Corners:** Click this button to display a drop-down sheet, and then click any of the four pop-up menus at the four corners of the screen to select that corner as an *activating hot corner*. (Moving your mouse pointer there immediately activates the screen saver.) You can also specify a corner as a *disabling hot corner* — as long as the mouse pointer stays in that corner, the screen saver is disabled. Note that you can also set the Dashboard, Spaces, and Exposé activation corners from here. (Read on for the entire lowdown.)



For additional security, check out the Security pane in System Preferences, where you'll find the Require Password to Wake This Computer from Sleep or Screen Saver check box. Enable the check box, and Leopard will require your user account password before allowing anyone to turn off the screen saver.

## The Exposé & Spaces pane

The pane you see in Figure 6-6 illustrates the settings that control Leopard's Spaces, Dashboard, and Exposé features (features I discuss in more detail in Chapter 5). The settings on the Exposé tab include

✓ **Active Screen Corners:** The screen corners pop-up menus that I describe in the preceding section operate just like those in the Screen Savers panel. Click a corner's list box to set it as

- An Exposé *All Windows* corner (displays all windows on your Desktop).
- An Exposé *Application Windows* corner (displays only the windows from the active application).
- An Exposé *Desktop* corner (moves all windows to the outside of the screen to uncover your Desktop).
- A *Spaces* corner (activates the Spaces Desktop selection feature).
- A *Sleep Display* corner (immediately turns off your display, putting your screen in Sleep mode).
- A *Dashboard* corner (displays your Dashboard widgets). *Widgets* are small applications that each perform a single task; they appear when you invoke the awesome power of Dashboard.

These pop-up menus can also set the Screen Saver activate and disable hot corners.

✓ **Keyboard and mouse shortcuts:** Pretty straightforward stuff here. Click each pop-up menu to set the key sequences (and mouse button settings) for all three Exposé functions as well as Dashboard.

If you hold down a modifier key (Shift, Control, Option, or ⌘) while a shortcut pop-up menu is open, Leopard adds that modifier key to the selections you can choose! (Perfect for those folks who already have the F11 key in use by another application. Make your Desktop shortcut key the Shift+F11 key sequence instead.)



One of Leopard's hottest new features is *Spaces*, which is the system you use to configure and control multiple "prefabricated" desktops that you can switch between at will! The settings on the Spaces tab include

✓ **Enable Spaces:** Enable this check box to use Spaces. (Go figure.)

✓ **Show Spaces in Menu Bar:** When this check box is enabled, Leopard displays the Spaces desktop number you're currently using in the Finder menu bar. You can click the number in the menu bar to switch to another Spaces desktop or to open the Spaces Preferences pane.

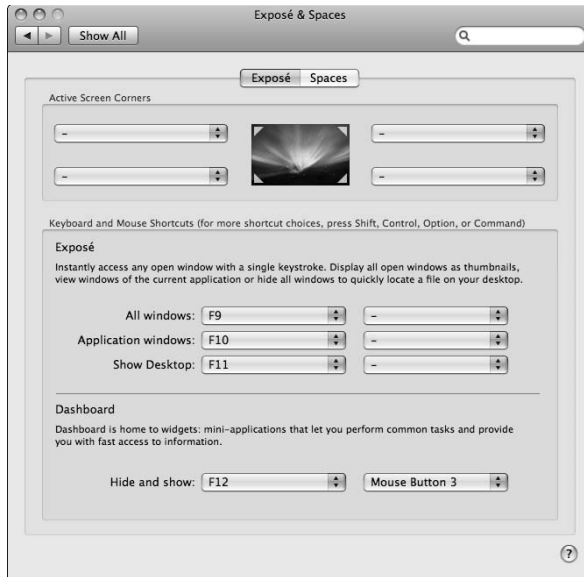

**Figure 6-6:**  
The Exposé  
& Spaces  
pane in  
System  
Preferences.



- ✓ **Rows buttons:** To add a row of Spaces desktops to the Spaces grid, click the Add button with the plus sign. (By default, Spaces starts with two desktops enabled, so new rows and columns are numbered beginning with three.) To delete a row, click the Delete button (which bears a minus sign).

- ✓ **Columns buttons:** To add a column of Spaces desktops to the Spaces grid, click the Add (plus) button. Click the Delete (minus) button to remove a column from the grid.

If you choose to remove a column or row, Leopard alerts you that the *bindings* (the specific applications linked to the deleted columns or rows) will be reassigned.

- ✓ **Add/Remove Application:** Click the Add Application button (the button with the plus sign under the Application Assignments list) to add an application to one of your Spaces desktops. You can select which desktop should include an application by clicking the up/down arrows next to the Space column for that application's entry — just click the desired desktop from the pop-up menu that appears. To remove an application, click it in the Application Bindings list to select it and then click the Remove Application button (which sports a minus sign).

Spaces can even add an application to all your desktops — choose Every Space from the pop-up menu.





- ✓ **Keyboard and mouse shortcuts:** Click each pop-up menu to set the key sequences (and mouse button settings) for all three Spaces functions.

Like with Dashboard and Exposé keyboard and mouse shortcuts, you can press Shift, Control, Option, and ⌘ keys while the box is open to display modified choices.

## The Appearance pane

The talented Appearance pane (as shown in Figure 6-7) determines the look and operation of the controls that appear in application windows and Finder windows. It looks complex, but I cover each option here.

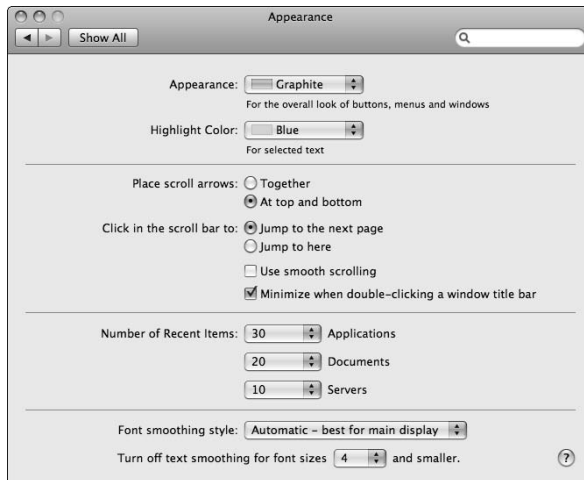

**Figure 6-7:** Appearances might not be everything, but they're easy to find here.

The settings include

- ✓ **Appearance:** Click this pop-up menu to specify the color Leopard uses for buttons, menus, and windows.
- ✓ **Highlight Color:** Click this pop-up menu to choose the color that highlights selected text in fields, pop-up menus, and drop-down list boxes.
- ✓ **Place Scroll Arrows:** Select a radio button here to determine whether the arrows that control the scroll bar in a window appear together at the bottom of the scroll bar, or separately at the top and bottom of the scroll bar.





- ✔ **Click in the Scroll Bar To:** By default, Leopard scrolls to the next or previous page when you click in an empty portion of the scroll bar. Select the Jump to Here radio button to scroll the document to the approximate position in relation to where you clicked. (Smooth scrolling slows down scrolling, which some people prefer.)

You can minimize a Finder or application window by simply double-clicking the window's title bar. To enable this feature, mark the Minimize When Double Clicking a Window Title Bar check box.

- ✔ **Number of Recent Items:** By default, Leopard displays ten recent applications, documents, and servers within Recent Items in the Apple menu. Need more? Just click the corresponding pop-up menu and specify up to 50 items.
- ✔ **Font Smoothing Style:** This feature performs a little visual magic that makes the text on your monitor or flat panel look more like the text on a printed page. Most iMac owners should choose Automatic or Medium (for a typical flat-panel LCD display).
- ✔ **Turn Off Text Smoothing for Font Sizes:** Below a certain point size, text smoothing doesn't help fonts look any smoother onscreen. By default, any font displayed at 8 point or smaller isn't smoothed, which is a good choice for an iMac with a flat-panel LCD screen.

## The Energy Saver pane

I'm an environmentalist — it's surprising how many techno-types are colored green — so these two panels are pretty doggone important. When you use them correctly, you not only save electricity but also even invoke the Power of Leopard to automatically start and shut down your iMac whenever you like!

The panels (as shown in Figure 6-8) include

- ✔ **Sleep:** To save electricity, drag the Put the Computer to Sleep When It Is Inactive For slider to a delay period that triggers sleep mode when you're away from the keyboard for a significant period of time. (I prefer 30 minutes.) If your iMac must always remain alert and you want to disable sleep mode entirely, choose Never. You can set the delay period for blanking your monitor separately from the sleep setting with the Put the Display to Sleep When the Computer Is Inactive For slider. To conserve the maximum juice and cut down on wear, enable the Put the Hard Disk(s) to Sleep When Possible check box to power-down your hard drives when they're not needed. (This might cause a delay of a second or two while loading or saving files because the drives must spin back up.)



You can set Leopard to start or shut down your iMac at a scheduled time. Click the Schedule button and then select the desired schedule (the Start Up or Wake check box and the Shut Down/Sleep pop-up menu) to enable them. Set the trigger time by clicking the up and down arrows next to the time display for each schedule. Click OK to return to the Energy Saver pane.

- ✔ **Options:** From this panel, you can specify events that can awake your iMac from sleep mode, like a ring signal from your modem. If you prefer to send your iMac to sleep by pressing the Power button, enable the Allow Power Button to Sleep the Computer check box. By default, your iMac's display will dim to indicate that sleep mode is approaching, but you can disable the Automatically Reduce the Brightness of the Display check box to maintain full brightness until sleep mode actually kicks in. Leopard can also restart your iMac automatically after a power failure — a good feature for those running Apache Web server, because your Web site will automatically come back online after power is restored.

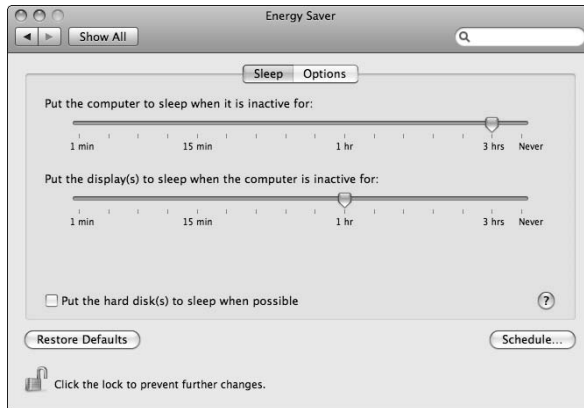

**Figure 6-8:**  
Reduce your iMac's power consumption from the Energy Saver pane.

## The Dock pane

I'll come clean: I think the Dock is the best thing since sliced bread! (I wonder what people referred to before sliced bread was invented?) You can use the settings, as shown in Figure 6-9, to configure the Dock's behavior until it fits your personality like a glove:

- ✔ **Size:** Pretty self-explanatory. Just drag the slider to change the scale of the Dock.
- ✔ **Magnification:** When you select this check box, each icon in your Dock swells like a puffer fish when you move your mouse cursor over it. (Just how much it magnifies is determined by the Magnification slider.) I really like this feature because I resize my Dock smaller, and I have a large number of Dock icons.



✔ **Position on Screen:** Select a radio button here to position the Dock on the left, bottom, or right edge of your iMac's Desktop.

✔ **Minimize Using:** Leopard includes two cool animations that you can choose from when shrinking a window to the Dock (and expanding it back to the Desktop). Click the Minimize Using pop-up menu to specify the genie-in-a-bottle effect or a scale-up-or-down-incrementally effect.

If animation isn't your bag or you want to speed up the graphics performance of an older G4 or G5 iMac, you can turn off these minimizing effects.

✔ **Animate Opening Applications:** Are you into aerobics? How about punk rock and slam dancing? Active souls who like animation likely get a kick out of the bouncing application icons in the Dock. They indicate that you've launched an application and that it's loading. You can turn off this bouncing behavior by disabling this check box.

✔ **Automatically Hide and Show the Dock:** Select this check box, and the Dock disappears until you need it. (Depending on the size of your Dock, the Desktop that you gain can be significant.) To display a hidden Dock, move your mouse pointer over the corresponding edge of the Desktop.

**Figure 6-9:**  
Customize  
your Dock  
by using  
these  
controls.

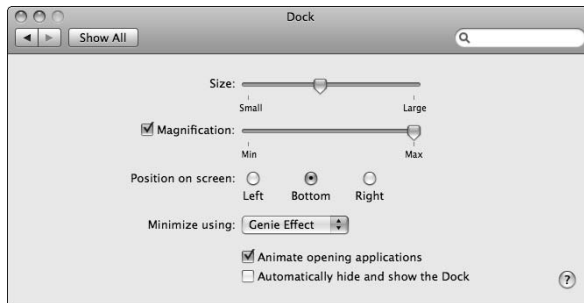

## The Sharing pane

So you're in a neighborly mood, and you want to share your toys with others on your local wired or wireless network. Perhaps you'd like to start your own Web site, or protect yourself against the Bad Guys on the Internet. All these fun diversions are available from the Sharing pane in System Preferences, as shown in Figure 6-10.

Click the Edit button to change the default network name assigned to your iMac during the installation process. Your current network name is listed in the Computer Name text field.

Each entry in the services list controls a specific type of sharing, including Screen Sharing, File Sharing (with other Macs and PCs running Windows), Printer Sharing, Web Sharing, Remote Login, Remote Management (using Apple Remote Desktop), Remote Apple Events, Xgrid Sharing, Internet Sharing and Bluetooth Sharing. To turn on any of these services, enable the On check box for that service. To turn off a service, click the corresponding On check box to disable it.

From a security standpoint, I highly recommend that you enable only those services that you actually use — each service you enable automatically opens your Leopard firewall for that service. (Chapter 17 discusses your firewall in more detail.) A Mark's Maxim to remember:



Poking too many holes in your firewall is *not* A Good Thing.™



When you click one of the services in the list, the right side of the Sharing pane changes to display the settings you can specify for that particular service. To display all the details on these options, click the Help button at the lower-right corner of the System Preferences dialog.



**Figure 6-10:** Share your toys with others by using the controls on the Sharing pane.

## The Time Machine pane

Mac users are excited about the new Time Machine automatic backup feature that debuts with Leopard, and you can easily configure how Time Machine handles your backups from this pane (as shown in Figure 6-11). Chapter 20 covers how to use Time Machine — of course, you'll need an external hard drive (or a Time Capsule wireless backup station) for the best backup security. Note that Time Machine won't work with your CD or DVD rewriteable drive . . . it's got to be a hard drive.



It *is* actually possible to use a second partition on your existing internal hard drive to hold your Time Machine data, but what happens if your internal hard drive is hit with a hardware failure? You'd lose both your original data *and* your backup in one fell swoop! For this reason, I **strongly** recommend that you add an external hard drive to your iMac for use with Time Machine. (I don't know why Apple even made this an option . . . sigh.)

**Figure 6-11:**  
Put Time Machine to work, and your data is always backed up.



To enable Time Machine, click the **Back Up This Computer** check box to enable it and then click the **Choose** button to select a disk (or partition) that holds your Time Machine backup data. You have the option of encrypting your backup for extra security, but remember that this slows down the backup and restore process slightly.

You can specify the amount of time that your backup data remains on the target drive with the **Keep Backups** pop-up menu, which appears at the bottom of the pane after you've turned on Time Machine and selected a target drive or partition. Note that the **Indefinitely** option provides an ongoing backup, allowing you to restore your files and folders from any point after you enable Time Machine.

Time Machine can automatically begin a backup session whenever necessary (working in the background), or you can choose to back up at scheduled times. Click the **Back Up** pop-up menu to set a schedule.



Your Mac must be turned on to allow a scheduled backup to run!



If you're running low on hard drive space to store your backup data (or you want to minimize the amount of time required for a backup), click the **Do Not Backup System Files** check box to enable it. Time Machine will back up only those items that you created or edited yourself — for example, your documents, digital media, and applications you installed.

By default, Time Machine backs up all the hard drives on your system; however, you might not need to back up some hard drives or folders on your iMac. To save time and hard drive space, Time Machine allows you to exclude specific drives and folders from the backup process. Click the Options button; then click the Add button (with the plus sign) to select the drives or folders you want to exclude, and they appear in the Do Not Back Up list.



To remove an exclusion, select it in the list and click the Delete button (with the minus sign); note the Total Included figure increases, and Time Machine adds the item you deleted from the list to the next backup.

After you make your changes, you can elect to back up your Mac immediately by clicking the Back Up Now button.

## Chapter 7

# Searching amidst iMac Chaos

---

### *In This Chapter*

- ▶ Understanding how Spotlight works
  - ▶ Searching for data, files, and folders via Spotlight
  - ▶ Using the results you get from a Spotlight search
  - ▶ Searching with the Find dialog and the Search box
  - ▶ Searching for stuff on the Internet with Dashboard widgets
- 

**W**hat would you say if I told you that you could search your entire system for every single piece of data connected with a person — and in only the short time it takes to type that person’s name? And I’m not just talking about files and folders that might include that person’s name. I mean *every* e-mail message and *every* iCal calendar or event that references that person — and even that person’s Address Book card to boot? Heck, how about if that search could dig up every occurrence of the person’s name inside your electronic PDF documents?

You’d probably say, “That makes for good future tech — I’ll bet I can do that in five or ten years. It’ll take Apple at least that long to do it . . . and just in time for me to buy a new iMac! (Harrumph.)”

Don’t be so hasty: You can do all this, right now. The technology is the Mac OS X feature named *Spotlight*, built right into Leopard. In this chapter, I show you how to use it like an iMac power guru. I also show you how to take advantage of Internet search widgets you can display within Dashboard. (From what I hear, there’s good stuff on the Internet, too.)

## *Spotlight Explained*

Invoking the magic of Spotlight is a snap. As you can see in Figure 7-1, the Spotlight search field always hangs out on the right side of the Finder menu bar. You can either click once on the magnifying glass icon or just press ⌘+spacebar. Either way, Leopard displays the Spotlight search box.





Preferences panes, such as *printer sharing* or *Dashboard*. Of course, Spotlight includes matching files and folders — like that other operating system — but it does it in the blink of an eye.

Spotlight matches all the items that include all your search text: Therefore, if you enter just the word *horse*, you're likely to get far more matches than if you enter a word string, such as *horse show ticket*.



If you add *metadata* to your documents — such as a Comment field in a Word document (which you can display in the Get Info dialog box) or keywords embedded in a Photoshop image — Spotlight matches that information as well. Other recognized file formats include iWork documents, Excel spreadsheets, Keynote presentations, and third-party applications that offer a Spotlight plug-in.



Spotlight works so seamlessly — and so doggone fast — because it's literally built into the core of Leopard (unlike that other operating system that begins with a W, which uses a separate program to search and can take a couple of minutes to return just matching filenames). Spotlight's integration into the heart of Leopard allows those high-IQ Apple developers (and even smart folks outside the company) to easily use it elsewhere within Leopard — more on this later in the chapter.

## Searching with Spotlight

To begin a Spotlight topic search, display the Spotlight box and start typing. As soon as your finger presses the first key, you see matching items start to appear. Check out Figure 7-2, in which I only typed a single character (L). (No need to press Return to start the process, by the way.) When you type more characters, Spotlight's results are updated in real time to reflect those more-restrictive qualifiers. (Of course, if I had typed three characters, like *Leo*, my results would be far more specific: everything from *Leopard* to *Leonard Bernstein*, for example.)

Spotlight displays what it considers the top 20 matching items within the Spotlight menu itself. These most relevant hits are arranged into categories, such as Documents, Images, and Folders. You can change the order in which categories appear (via the Spotlight pane within System Preferences, which I cover a bit later in this chapter).



With its internal magic, Spotlight presents the category Top Hit (with what it considers the single, most-relevant match) at the top of the search results, as also shown in Figure 7-2. You'll find that the Top Hit is often just what you're looking for. To open or launch the Top Hit item from the keyboard, click the entry or press the down-arrow key (↓) to select Top Hit; then press Return.

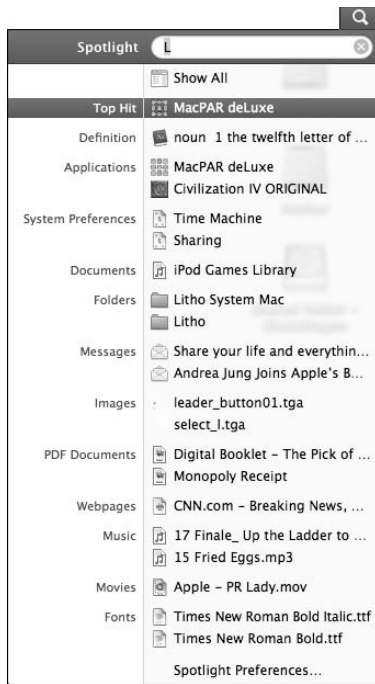

**Figure 7-2:**  
A Spotlight  
menu  
search  
takes as  
little as one  
character.

Didn't find what you were after? Click the X icon that appears at the right side of the Spotlight box to reset the search box and then start over.

If all you know about the item you're searching for is what type of file it is — for example, you know it's a QuickTime movie, but you know nothing about the title — just prefix the keyword with the text *kind:* in front of the file type — for example, *kind:movies* — in the Spotlight field. This trick also works with image files (*kind:images*), contacts (*kind:contacts*), applications (*kind:applications*), and audio files (*kind:music*), too.



TIP

Here's another trick that's built into Spotlight: You can type in a date a file was created or received — such as *modified:=>01/01/08* — to match all items modified on or after January 1 of 2008. Heck, you can even combine criteria — such as *kind:music created:07/18/07* (note the space between the criteria) — and Spotlight matches every audio file that was created on that date. One-hundred-percent *sassy!*

To allow even greater flexibility in your searches, Apple has added those helpful Boolean friends that you may already be familiar with: AND, OR, and NOT. For example, in Leopard, you can perform Spotlight searches, such as

✓ *Horse AND cow:* Collects all references to both those barnyard animals into one search

- ✔ *Batman* OR *Robin*: Returns all references to either Batman or Robin, but not both
- ✔ *Apple* NOT *PC*: Displays all references to Apple that don't include any information on dastardly PCs

## Working with Spotlight matches

After you run a fruitful search, and Spotlight finds the proverbial needle in your system's haystack, what's next?

Just click the item — that's all it takes. Depending on the type of item, Leopard does one of four things:

- ✔ Launches an application
- ✔ Opens a specific pane in System Preferences (if the match is the name of a setting or contained in the text on a Preferences pane)
- ✔ Opens a document or data item, such as an Address Book card
- ✔ Displays a folder within a Finder window

To see all sorts of useful info about each Spotlight menu item (*filtering*), click the Show All item (above the Top Hit listing; refer to Figure 7-2) to expand your Spotlight menu into the Results window, as shown in Figure 7-3. From the keyboard, you can press the Results window shortcut key, which you can set from System Preferences (more on this in a page or two).

### Is Spotlight secure?

So how about all those files, folders, contacts, and events that you *don't* want to appear in Spotlight? Say you're sharing your Mac as a multiuser computer, or accessing other Macs remotely. Can other folks search for and access your personal information through Spotlight?

**Definitely not!** The results displayed by Spotlight are controlled by file and folder permissions as well as your account login, just like the applications that create and display your personal data. For example, you can't access other users' calendars by using iCal, and they can't see your Mail messages. Only *you* have

access to *your* data, and only after you log in with your username and password. Spotlight works the same way. If a user doesn't normally have access to an item, it simply doesn't appear when that user performs a Spotlight search. (In other words, only you get to see your stuff.)

However, you can even hide certain folders and disks from your own Spotlight searches if necessary. Perhaps you'd prefer keeping your tax and financial records away from Spotlight's all-searching eye? Check out the last section of this chapter for details on setting private locations on your system.

**Figure 7-3:**  
The Spotlight Results window offers more ways to group and sort your matches.

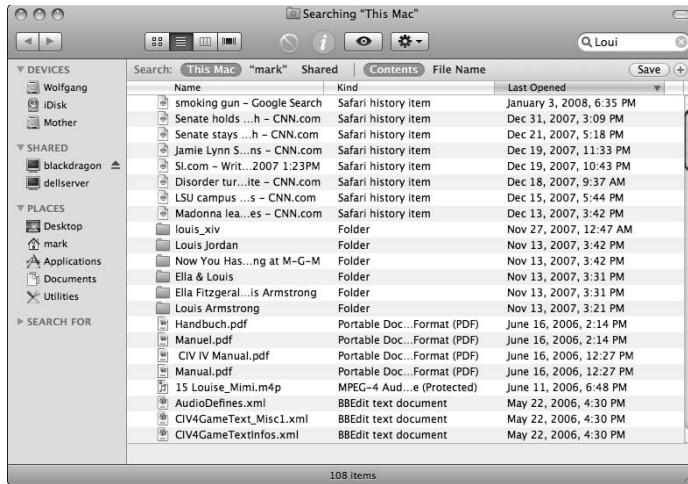

To further filter the search, click one of the buttons on the Spotlight Results window toolbar or create your own custom filter. Click the button with the plus sign to display the search criteria bar and then click the pop-up menus to choose from criteria, such as the type of file, text content, or the location on your system (such as your hard drive, your Home folder, or a network server). You can also filter your results listing by the date when the items were created or last saved. To add or delete criteria, click the plus and minus buttons at the right side of the search criteria bar. To save a custom filter that you created, click Save.

After you locate the item you want, click it to open, launch, or display it, just like you would in the Spotlight menu.



Heck, Spotlight can even look for matching items on *other* Macs on your network — but only if those remote Macs are configured correctly. To allow another Mac to be visible to Spotlight on your system, enable File Sharing on the other Mac within the Sharing pane in System Preferences. (Oh, and remember that you need an admin-level account on that Mac to enable file sharing — or access to a good friend who has an admin-level account on that Mac.)

## *Fine-tuning Spotlight in System Preferences*

The System Preferences window boasts a Spotlight pane, which you can use to customize what search matches you see and how they are presented. To adjust these settings, click the System Preferences icon on the Dock (look for the Three Gears of Justice) and then click the Spotlight icon (under Personal).

### Configuring the Search Results settings

Figure 7-4 illustrates the Search Results tab of the Spotlight Preferences pane. From here, you can

- ✓ **Pick your categories.** To disable a category (typically because you don't use those types of files), select the check box next to the unnecessary category to clear it.
- ✓ **Specify the order that categories appear within Spotlight.** Drag the categories into the order that you want them to appear in the Spotlight menu and Results window.
- ✓ **Select new Spotlight menu and Spotlight Results window keyboard shortcuts.** In fact, you can enable or disable either keyboard shortcut, as you like. Click the pop-up menu to choose a key combination.



**Figure 7-4:**  
These settings control how your matches are presented within Spotlight.

### Marking stuff off-limits

Click the Privacy tab (as shown in Figure 7-5) to add disks and folders that should never be listed as results in a Spotlight search. The disks and folders that you add to this list won't appear even if they actually match your search string. This safeguard can come in handy for organizations (such as hospitals) that are required by law to protect their patient or client data. However, you can select a removable hard drive here, which is often stored in a safe after business hours.



**Figure 7-5:**  
Some things  
should never  
be seen;  
specify  
them within  
Spotlight.

To add a private location, click the Add button (which bears a plus sign) and navigate to the desired location. Then click the location to select it and click Choose. (If you already have the location open in a Finder window, you also can drag folders or disks directly from the window and drop them into the list.)

## Searching the Old-Fashioned Way

The Finder window toolbar has featured a Search box for a few years now (and Leopard includes a Find dialog), but even the older Search features within Leopard have been updated to take advantage of Spotlight technology. Now you can even use file types (such as *image* or *movie*) and relative time periods (such as *yesterday* and *last week*) in the Finder window Search box and Find displays!

Typically, I use the Finder window Search box if I need to do a simple file or folder name search: It works the same as using the Spotlight search field. Just begin typing. To reset the field and start anew, click the X button in the Search box. To choose a specific location for your search — say, your Home folder or a hard drive volume — click the desired button along the top of the Search results display. The Finder window automatically turns into a Results display.

Leopard also includes the oldest Search method in the book: the Find display. (It used to be a dialog all by itself, but Find controls are now displayed in the Finder window, so it's more of an extension to the Finder window.) Choose File⇧Find or press ⌘+F to display the Find controls. From here, you can click pop-up menus to choose a specific filename or portion of a filename. Other

modifiers include the file type, content, the label color you assign to a file, file size, and the most recent date when the file was opened. Again, click the location buttons at the top of the window to choose where to search.

The Find display, however, is a little more sophisticated than the toolbar Search box. You can click the plus (+) button next to a search criterion field in the Find display to add another field, allowing for matches based on more than one condition. Click the minus (-) button next to a search criterion field to remove it.

After you find a match, both older Search methods work the same: Click the item once to display its location, or double-click it to launch or open it. Files can also be moved or copied, respectively, from the Results and Find displays with the standard drag or Option+drag methods. You can return to the more mundane Finder window display by clicking the Back button on the toolbar.



These older Search methods can also do one thing that Spotlight doesn't offer: You can use them to create a new *Smart Folder* (a folder with contents that Leopard automatically updates according to the criteria you set). Click the Save button in either the Finder window Search Results or Find display. You're prompted to specify the name and location for the new Smart Folder and whether it should appear in the Finder window Sidebar. After you create the folder, Leopard automatically updates the contents of the Smart Folder with whatever items match the criteria you saved. You never have to search by using the same text or criteria again because the search is saved as part of the Smart Folder! (Each icon in a Smart Folder is a link to the actual file or folder, so nothing gets moved, and no extra space is wasted with multiple copies of the same items.) You can work with the files and folders inside a Smart Folder as if they were the actual items themselves.

## With Widgets, the Internet is Your Resource

No chapter on searching within Mac OS X would be complete without the Internet resources available through your Leopard Dashboard. (I describe widgets in illuminating detail in Chapter 5.) Figure 7-6 illustrates many of these widgets:

- ✓ **Dictionary:** This multipurpose widget can display the Oxford American dictionary or thesaurus entry for the word you enter.
- ✓ **Weather:** Check out the six-day forecast for a specific ZIP code or city/state combination at a glance.



To enter the location data, click the tiny *i* button that appears when you mouse over the right corner of the widget. This trick works with just about every widget, allowing you to set any options it offers.

- ✔ **Flight Tracker:** Keep tabs on the arrival and destination time for the flight you specify.
- ✔ **Google:** Yep, it's a shortcut to the King of all Internet search engines. Just type in the words you want to search for and then press Return. The widget automatically launches Safari with the results!
- ✔ **Business:** Put your local Yellow Pages to work by typing in a business name or category. This widget displays matching telephone numbers and addresses. Click an entry to get directions or a map from the Web.



Okay, I know you're going to roll your eyes, but I have to remind you that you need an Internet connection to use these widgets. Otherwise, Business and Flight Tracker are about as useful as a pair of swim fins in the Sahara Desert.

Naturally, you'll find countless other Internet-enabled widgets on the Apple Web site, in the Download area. For all the details on adding built-in widgets to your Dashboard, visit Chapter 5.

**Figure 7-6:**  
These widgets use the Internet to help you search for answers to Life's Persistent Questions.

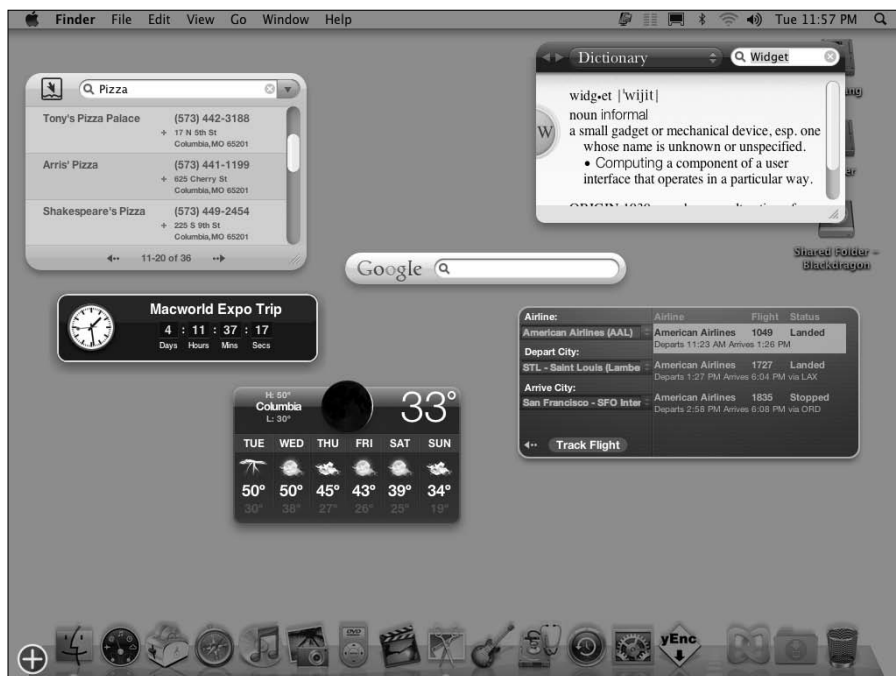



# Part III

# Connecting and Communicating

The 5<sup>th</sup> Wave

By Rich Tennant

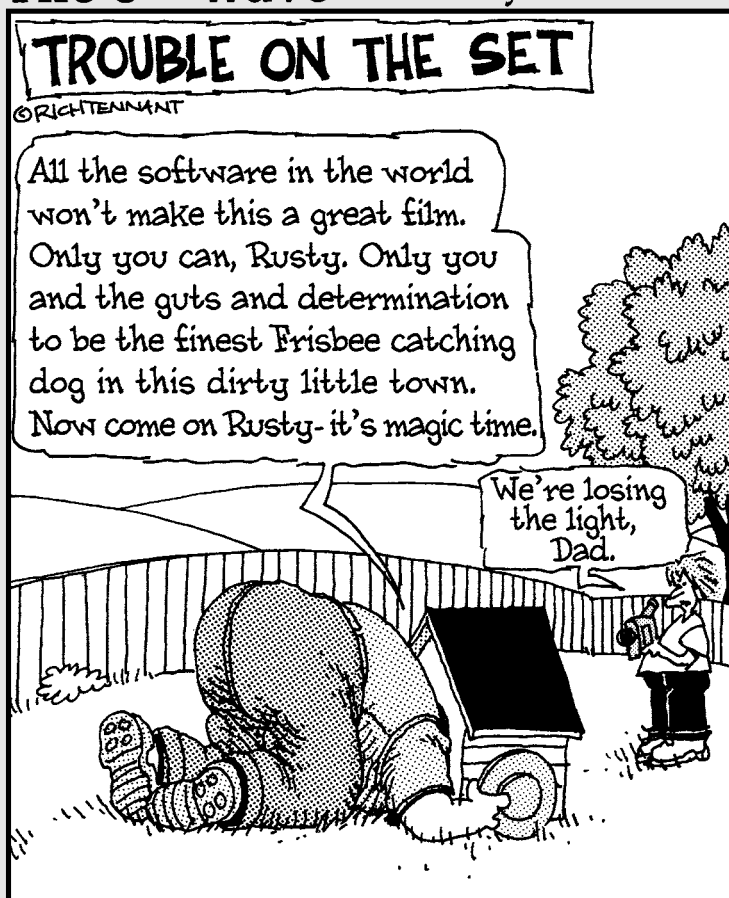

## *In this part . . .*

**Y**ou want to do the Internet thing, don't you? Sure you do — and in this part, I describe and demonstrate your Safari Web browser. You also get to know all about Apple's .Mac Internet subscription service, and how you can store, back up, and synchronize your data online. Finally, this part fills you in on connecting important stuff like printers and scanners, and how you can use that cool-looking Apple Remote.

## Chapter 8

# Let's Go on Safari!

---

### *In This Chapter*

- ▶ Introducing the Safari window and controls
  - ▶ Visiting Web sites with Safari
  - ▶ Moving between sites
  - ▶ Creating and using bookmarks
  - ▶ Receiving files with Safari
  - ▶ Surfing with your tabs showing
  - ▶ Saving Web pages to disk
  - ▶ Protecting your privacy on the Web
  - ▶ Blocking those irritating pop-ups
- 

**L**ooking for that massive Microsoft monster of a Web browser on your iMac? You know, the one that practically everyone uses in the Windows world. What's it called? I forget the name.

You see, I use an iMac, and I proudly surf the Web via a lean, mean — and *very* fast — browser application. That's Safari, of course, and it just keeps getting better with each new version of Mac OS X. Safari delivers the Web the right way, without the wait.

If you need a guide to Safari, this is your chapter. Sure, you can start using it immediately, but wouldn't you rather read a few pages in order to surf like a power user?

## *It Doesn't Even Look Like That Other Web Browser*

Figure 8-1 illustrates the Safari window. You can launch Safari directly from the Dock, or you can click the Safari icon (which looks like a compass dial) within your Applications folder.

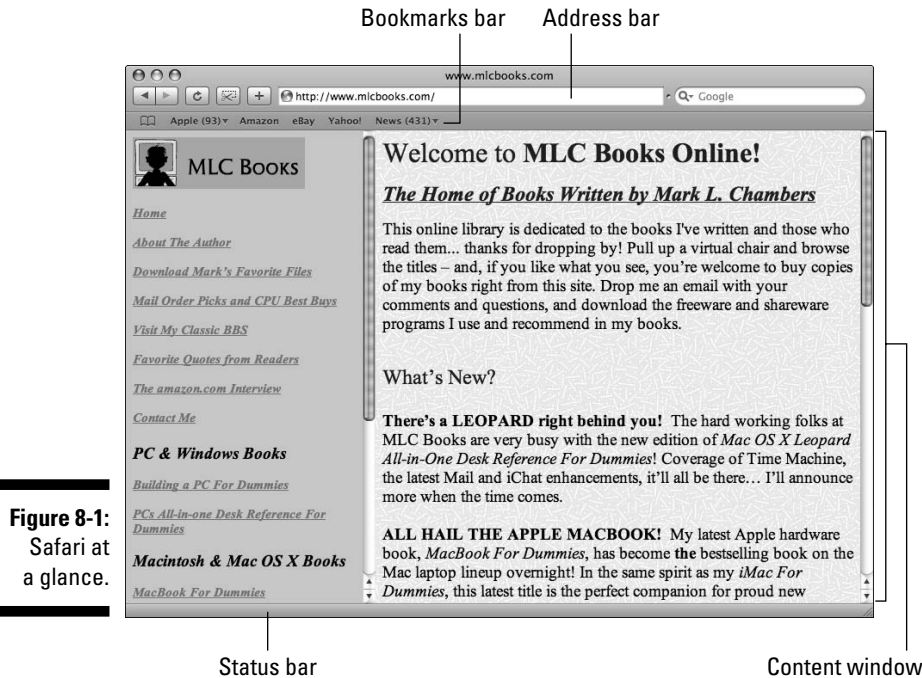

**Figure 8-1:**  
Safari at  
a glance.

Major sections of the Safari window include

- ✓ **The Toolbar:** You find the most-often-used commands on this toolbar for everyday tasks, such as navigation, adding bookmarks, and searching Google. Plus, here, you can type or paste the address for Web sites that you'd like to visit. You can hide the Toolbar to open up more real estate in your browser window for Web content. To toggle hidden mode, press  $\mathbb{C}+\mid$  (the vertical bar right above the backslash) or choose View $\rightarrow$ Hide/Show Toolbar.
- ✓ **The Bookmarks bar:** Consider this a toolbar that allows you to jump directly to your favorite Web sites with a single click. I show you later, in the section “Adding and Using Bookmarks,” how to add and remove sites from your Bookmarks bar. For now, remember that you can toggle the display of the Bookmarks bar by choosing View $\rightarrow$ Hide/Show Bookmarks Bar, or by pressing  $\mathbb{C}+\text{Shift}+\text{B}$ .
- ✓ **The Content window:** Congratulations! At last, you waded through all the pregame show and reached the area where Web pages are actually displayed. Like any other window, the Content window can be scrolled; when you minimize Safari to the Dock, you get a *thumbnail* (minimized) image of the Content window.



The Content window often contains underlined text and graphical icons that transport you to other pages when you click them. These underlined words and icons are *links*, and they make it easy for you to move from one area of a site to another or to a completely different site.

- ✓ **The status bar:** The status bar displays information about what the mouse pointer is currently resting upon, like the address for a link or the name of an image; it also updates you on what's happening while a page is loading. To hide or display the status bar, press  $\mathbb{X}+$  (forward slash).

## Visiting Web Sites

Sure, you're likely saying, "Mark, I already know this stuff. I can operate a Web browser blindfolded — while listening to *The Best of Air Supply*, even." I agree wholeheartedly, but I get paid by the word, and some folks might just not be aware of all the myriad ways of visiting a site. You can load a Web page from any of the following methods:

- ✓ **Type (or paste) a Web site address into the Toolbar and then press Return.**

If you're typing in an address and Safari recognizes the site as one that you already visited, it helps by completing the address for you. If this is a new site, just keep typing.

- ✓ **Click a Bookmarks entry within Safari.**
- ✓ **Click the Home button, which takes you to the home page that you specify.**

More on this in the section, "Setting Up Your Home Page," later in this chapter.

- ✓ **Click a page link in Apple Mail or another Internet-savvy application.**
- ✓ **Click a page link within another Web page.**
- ✓ **Use the Google box in the Toolbar.**

Click in the Google box, type the contents that you want to find, and then press Return. Safari presents you with the search results page on Google for the text that you entered. (In case you've been living under the Internet equivalent of a rock for the last couple of years, *Google.com* is the preeminent search site on the Web. People use Google to find everything from used auto parts to ex-spouses.)

- ✓ **Click a Safari page icon on the Dock or in a Finder window.**

For example, Mac OS X sports an icon in the default Dock that takes you to the Mac OS X page on the Apple Web site. Drag a site from your



Bookmarks bar and drop it on the right side of the Dock. Clicking the icon that you add launches Safari and automatically loads that site.

This trick works only on the side of the Dock to the right of the vertical line.

If you minimize Safari to the Dock, you see a thumbnail of the page with the Safari logo. Click this thumbnail in the Dock to restore the page to its full glory.

## Basic Navigation While on Safari

A typical Web surfing session is a linear experience — you bop from one page to the next, absorbing the information that you want and discarding the rest. However, after you visit a few sites, you might find that you need to return to where you've been or head to the familiar ground of your home page. Safari offers these navigational controls on the Toolbar:

- ✓ **Back:** Click the Back button (the left-facing arrow) on the toolbar to return to the last page that you visited. Additional clicks take you to previous pages, in reverse order. The Back button is disabled if you haven't visited at least two sites.
- ✓ **Forward:** If you've clicked the Back button at least once, clicking the Forward button (the right-facing arrow) takes you to the next page (or through the pages) where you were, in forward order. The Forward button is disabled if you haven't used the Back button.
- ✓ **Home:** Click this button (look for the little house) to return to your home page.



Not all these buttons and controls might appear on your Toolbar. To display or hide Toolbar controls, choose View⇨Customize Toolbar. The sheet that appears works just like the Customize Toolbar sheet within a Finder window: Drag the control you want from the sheet to your Toolbar, or drag a control that you don't want from the Toolbar to the sheet.

- ✓ **AutoFill:** If you fill out a lot of forms online — when you're shopping at Web sites, for example — you can click the AutoFill button (which looks like a little text box and a pen) to complete these forms for you. You can set what information is used for AutoFill by choosing Safari⇨Preferences and then clicking the AutoFill toolbar button.



To be honest, I'm not a big fan of releasing *any* personal information to *any* Web site, so I don't use AutoFill often. If you do decide to use this feature, make sure that the connection is secure (look for the padlock icon in the upper-right corner of the Safari window) and read the site's Privacy Agreement page first to see how your identity data will be treated.

- ✔ **Text Size:** Use this to shrink or expand the text on the page, offering smaller, space-saving characters (for the shrinking crowd) or larger, easier-to-read text (for the expanding crowd). Hence the button, which is labeled with a small and large letter A.
- ✔ **Stop/Reload:** Click Reload (which has a circular arrow) to *refresh* (reload) the contents of the current page. Although most pages remain static, some pages change their content at regular intervals or after you fill out a form or click a button. By clicking Reload (look for the curvy arrow), you can see what's changed on these pages. (I use Reload every hour or so with CNN.com, for example.) While a page is loading, the Reload button turns into the Stop button — with a little X mark — and you can click it to stop the loading of the content from the current page. This is a real boon when a download takes *foorrevverr*, which can happen when you're trying to visit a very popular or very slow Web site (especially if you're using a dialup modem connection to the Internet). Using Stop is also handy if a page has a number of very large graphics that are going to take a long time to load.
- ✔ **Open in Dashboard:** Click this button to create a Dashboard widget using the contents of the currently displayed Web page. Safari prompts you to choose which clickable section of the page to be included within the widget's borders (like the local radar map on your favorite weather Web site). Click Add, and Dashboard loads automatically with your new widget. (More on widgets in Chapter 5.)
- ✔ **Add Bookmark:** Click this Toolbar button (which carries a plus sign) to add a page to your Bookmarks bar or Bookmarks menu. (More on this in a tad.)
- ✔ **Google Search:** As I mention earlier, you can click in this box, type text that you want to find on the Web via the Google search engine, and then press Return to display the results. To repeat a recent search, click the down arrow in the Google Search box and select it from the pop-up menu.
- ✔ **Print:** Click this convenient button to print the contents of the Safari window. Dig that crazy printer icon!
- ✔ **Report Bug:** A rather strange creature, the Safari Bug button makes it easy to alert Apple when you encounter a page that doesn't display properly in Safari. (Software developers call such glitches bugs: hence, the name.) When you click the Bug button, you see a sheet with the settings shown in Figure 8-2; there, you can enter a short description of the problem that you're having. (I also enable the Send Screen Shot of Current Page and the Send Source of Current Page check boxes to give the Apple folks more to work with while they're debugging Safari.) Then click the Submit button to send the bug report to Apple.

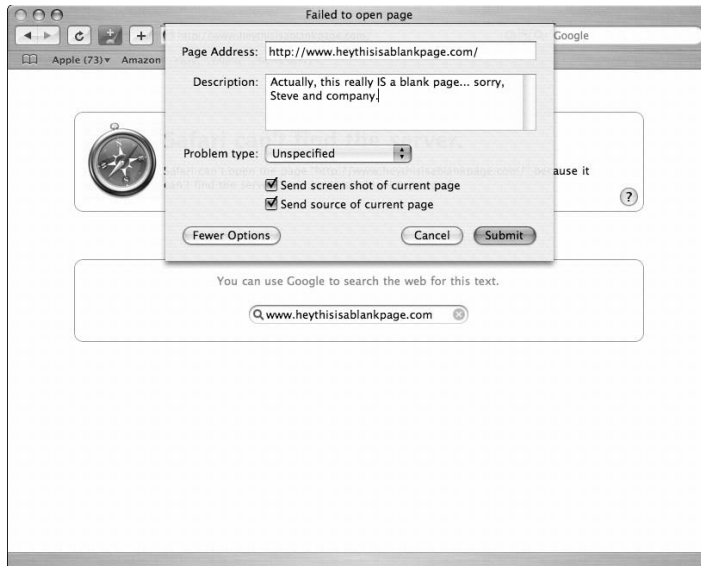

**Figure 8-2:**  
Have at thee,  
troublesome  
buggy page!

## Setting Up Your Home Page

Choosing a *home page* — the page that initially appears when you launch Safari — is one of the easiest methods of speeding up your Web surfing, especially if you're using a dialup modem connection. However, a large percentage of the Mac owners with whom I've talked have never set their own home page, simply using the default home page provided by their browser! With Safari running, take a moment to follow these steps to declare your own freedom to choose your own home page:



- 1. Display the Web page you want as your new home page, in Safari.**

I recommend electing a page with few graphics or a fast-loading popular site.

- 2. Choose Safari⇨Preferences or press ⌘+, (comma).**

- 3. Click the General button.**

You see the settings shown in Figure 8-3.

- 4. Click the Set to Current Page button.**

- 5. Alternatively, click the New Windows Open With pop-up menu and choose Empty Page if you want Safari to open a new window with a blank page.**

This is the fastest choice of all for a home page (and a good choice for those using a dialup modem connection because Safari doesn't have to download anything upfront).





**Figure 8-3:**  
Adding your  
own home  
page is  
an easy  
change you  
can make.



**6. Click the Close button to exit the Preferences dialog.**

Visit your home page at any time by pressing the Home button on the Toolbar.

## Lean, fast, and mean — That's RSS

Well, maybe not *mean* — after all, I don't want you to be afraid of RSS (RDF Site Summary, or really simple syndication) pages! RSS Web sites display updated information by using a shortened list format, rather like a newspaper headline, without unnecessary graphics or silly advertisements. You can tell when a Web site has RSS pages available because Safari displays an RSS icon at the right side of the Address box. (When you click the RSS icon, the Web address switches to a `feed://` prefix — another indication that you're not in Kansas reading HTML pages anymore.)

To display more information about a news item on an RSS page, click the item headline. Safari opens the corresponding Web page — yep, once again you're back in the world of HTML —

where you can read the full story. To return to the RSS feed, click the Back button on the Toolbar. Naturally, RSS feed pages can be bookmarked. In fact, Apple gives you a number of RSS sites that you can explore immediately.

To customize your RSS display, choose Safari → Preferences and then click the RSS tab. By default, Safari checks for updated RSS headlines on your bookmarked feeds every 30 minutes, but you can change this to an hourly or daily check. (Of course, you can also check for updates manually by reloading the RSS page, just like you would any other Web page.) New articles can be assigned any color you like, and you can specify the amount of time an item should remain on the RSS page after it's published.

## Adding and Using Bookmarks

No doubt about it: Bookmarks make the Web a friendly place. When you set bookmarks in Safari, you can immediately jump from one site to another with a single click of the Bookmarks menu or the buttons on the Bookmarks bar. (The Bookmarks menu opens up in a separate pane on the left side of the Safari window, and the Bookmarks bar appears right below the Toolbar. The method you use is up to your preference.)

To add a bookmark, first navigate to the desired page and then do any of the following:

✓ **Choose Bookmarks → Add Bookmark.**

✓ **Press the ⌘+D keyboard shortcut.**

Safari displays a sheet where you can enter the name for the bookmark and also select where it appears (on the Bookmarks bar or the Bookmarks menu).

✓ **Drag the icon next to the Web address from the Toolbar to the Bookmarks bar.**



You can also drag a link on the current page to the Bookmarks bar, but note that doing this only adds a bookmark for the page corresponding to the link — not the current page.

To jump to a bookmark

✓ **Choose it from the Bookmarks menu.**

If the bookmark is contained in a folder, which I discuss later in this section, move your mouse pointer over the folder name to show its contents and then click the bookmark.

✓ **Click the bookmark on the Bookmarks bar.**

If you've added a large number of items to the Bookmarks bar, click the More icon on the edge of the Bookmarks bar to display the rest of the buttons.

✓ **Click the Show All Bookmarks button (which looks like a small, opened book) on the Bookmarks bar and then click the desired bookmark.**

The Bookmarks window that you see in Figure 8-4 appears, where you can review each collection of bookmarks at leisure.



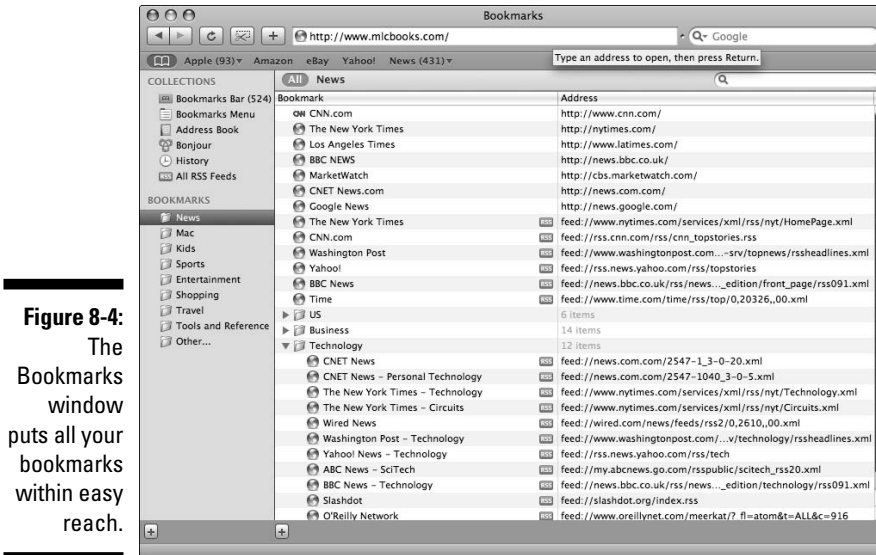

**Figure 8-4:**  
The Bookmarks window puts all your bookmarks within easy reach.

The more bookmarks that you add, the more unwieldy the Bookmarks menu and the Bookmarks window become. To keep your bookmarks organized, choose Bookmarks → Add Bookmark Folder and then type a name for the new folder. With folders, you can organize your bookmarks into *collections*, which appear in the column at the left of the Bookmarks window (or as separate submenus within the Bookmarks menu). You can drag bookmarks into the new folder to help reduce the clutter.

To delete a bookmark or a folder from the Bookmarks window, click it and then press Delete.

## Downloading Files

A huge chunk of the fun that you find on the Web is the ability to download images and files. If you've visited a site that offers files for downloading, you typically just click the Download button or the download file link, and Safari takes care of the rest. You see the Downloads status window, which keeps you updated with the progress of the transfer. While the file is downloading, feel free to continue browsing or even download additional files; the status window helps you keep track of what's going on and when everything will be finished transferring. To display the Download status window from the keyboard, press ⌘+Option+L.

By default, Safari saves any downloaded files to your Mac OS X Download folder on the Dock, which I like and use. To specify the location where downloaded files are stored — for example, if you'd like to scan them automatically with an antivirus program — follow these steps:

1. **Choose Safari⇨Preferences or press ⌘+, (comma).**
2. **Click the General tab and then click the Save Downloaded Files To pop-up menu.**
3. **Choose Other.**
4. **Navigate to the location where you want the files stored.**
5. **Click the Select button.**
6. **Click the Close button to exit Preferences.**

To download a specific image that appears on a Web page, move your mouse pointer over the image and hold down Control while you click (or right-click, if you've got the button to spare). Then choose Download Image to Disk from the pop-up menu that appears. Safari prompts you for the location where you want to store the file.

You can choose to automatically open files that Safari considers safe — things like movies, text files, and PDF files that are **very** unlikely to store a virus or a damaging macro. By default, the Open “Safe” files After Downloading check box is enabled on the General pane. However, if you're interested in preventing anything you download from running until you manually check it with your antivirus application, you can disable the check box and breathe easy.



Luckily, Safari has matured to the point that it can seamlessly handle virtually any multimedia file type that it encounters. However, if you've downloaded a multimedia file and Safari doesn't seem to be able to play or display it, try loading the file within QuickTime. QuickTime is the Swiss Army knife of multimedia players, and it can recognize a huge number of audio, video, and image formats.

## *Using Subscriptions and History*

To keep track of where you've been, you can display the History list by clicking the History menu. To return to a page in the list, just choose it from the History menu. Note that Safari also arranges older history items by the date you visited the site, so you can easily jump back a couple of days to that page you forgot to bookmark!

In fact, Safari also searches the History list automatically, when it fills in an address that you're typing. That's the feature I mention in the earlier section, "Visiting Web Sites."

If you're worried about security and you'd rather not keep track of where you've been online, I show you how to clear the contents of the History file in the upcoming section, "Handling ancient history."

## Tabs Are Your Browsing Friends

Safari also offers *tabbed browsing*, which many folks use to display (and organize) multiple Web pages at one time. For example, if you're doing a bit of comparison shopping for a new piece of hardware between different online stores, tabs are ideal.

When you hold down the ⌘ key and click a link or bookmark using tabs, a tab representing the new page appears under the Bookmarks bar. (Choose File⇨New Tab or press ⌘+T to work the same magic.) Just click the tab to switch to that page. (If you don't hold down ⌘, things revert to business as usual, and Safari replaces the contents of the window with the new page.) Figure 8-5 illustrates a number of pages that I opened in Safari, using tabs.

To turn on tabbed browsing, choose Safari⇨Preferences to display the Preferences dialog; then click Tabs. From here, select the ⌘-Click Opens a Link in a New Tab check box to enable it. After you turn on tabs, your browsing experience will never be the same.



Done with a page? You can remove a tabbed page by clicking the X button next to the tab's title.

### Searching for pointed sewing implements

Looking for a certain word or phrase on a huge Web page that seems to be 47 screens long? Don't despair! You can always press ⌘+F (or choose Edit⇨Find⇨Find) to display the Find bar (which appears directly under the Safari toolbar). Type the word or phrase that you're looking for in the Find box — no need to press Return — and Safari highlights any matches that it finds!

Click the Next button in the Find bar to advance to each spot within the page in order, all the way to the bottom of the page. To search upward to the top of the page, click Previous. When you're finished searching, click the Done button to banish the Find bar.

Convenient, indeed. Consider that needle found!

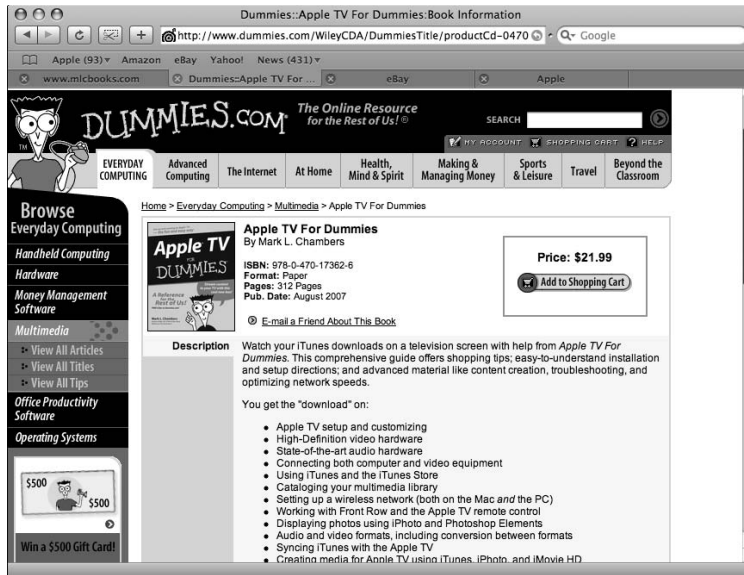

**Figure 8-5:**  
Hang on,  
Martha!  
We've  
struck tabs!

## Saving Web Pages

If you encounter a page that you'd like to load later, you can save it to disk in its entirety as a Web archive (which stores all the page content, including the text and images). Follow these steps:

1. **Display the desired page.**
2. **Choose File→Save As, or press ⌘+S.**
3. **In the Export As text field, type a name for the saved page.**
4. **From the Where field, navigate to the location where you want to store the file on your system.**

To expand the sheet to allow navigation to any location on your system, click the button with the downward arrow.
5. **Click the Format pop-up menu to choose the format for the saved page.**

Usually, you'll want to choose a Web Archive, which saves the entire page and can be displayed just as you see it. However, if you want to save just the HTML source code, choose Page Source.

6. **Click Save to begin the download process.**

After the Save file is created, double-click it to load it in Safari.

A quick word about printing a page within Safari: Some combinations of background and text colors might conspire together to render your printed copy practically worthless. In a case like that, use your printer's grayscale setting (if it has one). Alternatively, you can simply click and drag to select the text on the page, press ⌘+C to copy it, and then paste the text into Word or Pages, where you can print the page on a less-offensive background (while still keeping the text formatting largely untouched).



If you'd rather mail the contents of a Web page to a friend — or just a link to the page, which is faster to send over a dialup Internet connection — choose File⇨Mail Contents of this Page/Mail Link to this Page. (From the keyboard, press ⌘+I to send the contents in an e-mail message, or press ⌘+Shift+I to send a link in e-mail.) Mail loads automatically, complete with a prepared e-mail message. Just address it to the recipients and then click Send!

## Protecting Your Privacy

No chapter on Safari would be complete without a discussion of security, both against outside intrusion from the Internet and prying eyes around your Mac. Hence, this last section, which covers protecting your privacy.



Although diminutive, the tiny padlock icon that appears in the top-right corner of the Safari window when you're connected to a secure Web site means a great deal! A *secure site* encrypts the information that you send and receive, making it much harder for those of unscrupulous ideals to obtain things like credit card numbers and personal information.

## Yes, there are such things as bad cookies

First, a definition of this ridiculous term: A *cookie*, a small file that a Web site automatically saves on your hard drive, contains information that the site will use on your future visits. For example, a site might save a cookie to preserve your site preferences for the next time or — in the case of a site such as Amazon.com — to identify you automatically and help customize the offerings that you see.

In and of themselves, cookies aren't bad things. Unlike a virus, a cookie file isn't going to replicate itself or wreak havoc on your system, and only the original site can read the cookie that it creates. However, many folks don't appreciate acting as a gracious host for a slew of little snippets of personal information. Also, if you do a large amount of surfing, cookies can occupy a significant amount of your hard drive space over time. (Not to mention that some cookies have highly suggestive names, which could lead to all sorts of conclusions. End of story.)

You can choose to accept all cookies — the default — or you can opt to disable cookies altogether. You can also set Safari to accept cookies only from the sites you choose to visit. To change your *Cookie Acceptance Plan* (or CAP, for those who absolutely crave acronyms), follow these steps:

1. **Choose Safari⇨Preferences.**
2. **Click the Security toolbar button.**

Safari displays the preference settings shown in Figure 8-6.



**Figure 8-6:**  
Specifying  
who's  
welcome  
in my  
cookie jar.

3. **Choose how to accept cookies via these radio button choices:**

- *Never*: Block cookies entirely.
- *Always*: Accept all cookies.
- *Only from Sites You Navigate To*: Personally, I use this default option, which allows sites like Amazon.com to work correctly without allowing a barrage of illicit cookies.

4. **To view the cookies currently on your system, click the Show Cookies button.**

If a site's cookies are blocked, you might have to take care of things manually, such as providing a password on the site that used to be read automatically from the cookie.

5. **Click the Close button to save your changes.**





## *Cleaning your cache*

Safari speeds up the loading of Web sites by storing often-used images and multimedia files in a temporary storage, or *cache*, folder. Naturally, the files in your cache folder can be displayed (hint), which could lead to assumptions (hint, hint) about the sites you've been visiting (hint, hint, hint). (Tactful, ain't I?)

Luckily, Safari makes it easy to dump the contents of your cache file. Just choose Safari⇨Empty Cache; then click Empty to confirm that you want to clean up your cache.

## *Handling ancient history*

As you might imagine, your History file leaves a very clear set of footprints indicating where you've been on the Web. To delete the contents of the History menu, choose History⇨Clear History.

The latest version of Safari also allows you to specify an amount of time to retain entries in your History file. Open the Safari Preferences dialog, click the General tab, and then click the Remove History Items pop-up menu to specify the desired amount of time. Items can be rolled off daily, weekly, biweekly, monthly, or yearly.

## *Avoiding those @\*!^%/\$ pop-up ads*

I hate pop-up ads, and I'm sure you do, too. To block most of those pop-up windows with advertisements for everything from low-rate mortgages to "sure-thing" Internet casinos, click the Safari menu and verify that Block Pop-Up Windows is checked. (If it's not checked, click the menu item to toggle the menu item on.)



From time to time, you might run across a Web site that actually does something *constructive* with pop-up windows, like present a download or login prompt. If you need to temporarily deactivate pop-up blocking, press ⌘+Shift+K to toggle it off. Then press ⌘+Shift+K again to turn pop-up blocking back on after you've finished with the site.



## Chapter 9

# Moving to .Mac

---

### *In This Chapter*

- ▶ Understanding online storage
  - ▶ Opening a new .Mac account
  - ▶ Using your iDisk
  - ▶ Backing up your hard drive by using .Mac
  - ▶ Publishing Web pages the .Mac way
- 

**R**eaders often ask me to name my favorite reasons why they should switch — that is, why should a Windows user who *thinks* all is well move to the Apple universe? Of course, I always mention the superior hardware and how much better of a job Leopard does as an operating system. Here's my favorite selling point: "Apple simply does things right the first time, and everyone else plays catch-up."

And then I pose this question: "What if you could reach a hard drive with 10GB of your files over any Internet connection — anywhere in the world — and it just *showed up* on your Desktop automatically?" Usually, I get a thoughtful silence after that one, and another person decides to find out more — about the Apple .Mac online hosting service, that is.

In this chapter, I save you the trouble of researching all the benefits of .Mac. Heck, that's one of the reasons why you bought this book, right?

## *Wait a Minute: Where Exactly IS My .Mac Storage?*

Yep, that's the question everyone asks. Best that I answer this one first.

I'll begin with a definition. The online hard drive offered to .Mac subscribers (read about subscribing in the following section) is an *iDisk*, and it's well integrated into Mac OS X. In fact, if you didn't know the background, you might

think that iDisk were simply another internal hard drive. Figure 9-1 illustrates my iDisk icon on my Desktop. The Finder window displays the contents; notice the folders visible there. (More on these folders later in the chapter.)

**Figure 9-1:**  
My iDisk  
at work.  
Looks like  
a normal  
hard drive,  
doesn't it?

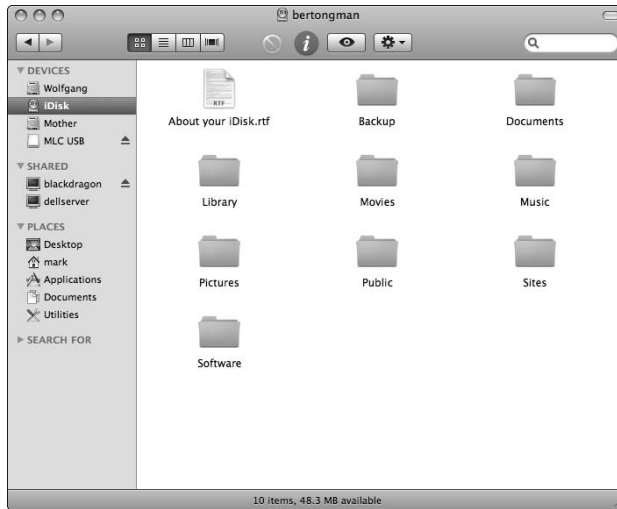

The files that I add to my iDisk are stored on an Apple server, location unknown. Literally. The physical storage (a massive file server that holds uncounted gigabytes of data) could be in Cupertino, or it might be in Timbuktu. There's a whole bunch of 'em, too. You and I don't need to care about the where part because

- ✔ **Your iDisk is always available.** Oh, yes. 24/7, your files are waiting for you.
- ✔ **Your iDisk is secure.** Apple goes to great lengths to guarantee the security of your data, encrypting the transfer of files and folders whenever you use your iDisk. You can also password-protect any data that you want to offer to others, just in case.
- ✔ **Your iDisk works even when you aren't on the Internet.** Yep, you read that right: You can create new documents and modify files to your heart's content while you're on a flight or relaxing on the beach. iDisk automatically updates whatever's changed the next time you connect to the Internet.

Now that I've piqued your interest (and answered the most common question about iDisk), return to the .Mac service for a moment so I can show you how to set up your account.

## Opening a .Mac Account

If you haven't already opened your .Mac account, you get a chance to sign up when you turn on your iMac for the first time and also when you install (or upgrade) Mac OS X. However, if you decided to pass on .Mac at that time, you can always join in the fun by following these steps:

1. Click the **System Preferences icon on the Dock.**
2. Click the **.Mac icon.**
3. Click the **Learn More button.**

This launches Safari and displays the Apple .Mac Welcome page ([www.mac.com/dotmac](http://www.mac.com/dotmac)). Click Free Trial and then follow the onscreen instructions to choose a member name and password.

When you're done with the clicking and you're rewarded with your login information, close Safari and then enter your name and password into the text boxes in the .Mac System Preferences pane.

Figure 9-2 illustrates an example login that I created.

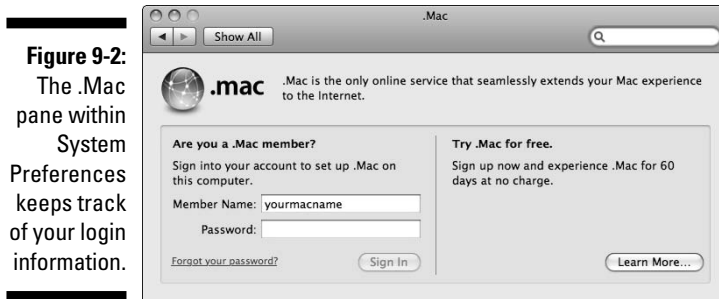

**Figure 9-2:**  
The .Mac pane within System Preferences keeps track of your login information.

Like the convenient operating system that it is, Leopard handles all your .Mac login chores automatically from this point on.



If you're a dialup Internet user, you were likely dreading this moment, but here it is. I'm truly sorry, but in my opinion, a high-speed broadband connection is a real requirement in order to take full advantage of a .Mac subscription. You can certainly still use all the functionality of .Mac with any type of Internet connection, but you're going to spend from now until the next *Gone With the Wind* sequel waiting for files to copy and things to happen.

If you decide to sign up for a full year's .Mac membership, I salute you for your discerning taste in online services. However, you can opt for a 60-day trial subscription at this point, which is only fair because Apple wants you to check out things at your leisure. Table 9-1 shows the major differences between a free trial subscription and a full \$100 yearly subscription to .Mac.

<i>Status</i>	<i>iDisk/E-Mail Storage</i>	<i>Time Provided</i>	<i>Data Transfer</i>	<i>Backup Storage</i>
Trial	100MB total	60 days	3GB per month	100MB total
Member	10GB total	1 year	100GB per month	10GB total



A .Mac subscription also allows you to synchronize your e-mail, Address Book contact information, and your Safari bookmarks between multiple Macs. What a real boon if you spend time on the road with a MacBook or a MacBook Pro laptop!



Both trial and subscriber .Mac users can read .Mac e-mail through the Web-based browser offered on the .Mac Web site. That's neat, certainly, and you can use Web mail from any computer with an Internet connection. However, you can also send and receive .Mac e-mail seamlessly from Leopard's Mail application, which is the preferred method of checking your messages. In fact, Leopard automatically creates a matching Mail account for your trial .Mac account!

If you decide that you want the extra functionality of a .Mac subscription, upgrading is easy. When you open the .Mac pane within System Preferences and click the Account button, Leopard displays a countdown reminder telling you how many days remain on your trial period. To upgrade, visit the .Mac Web site at any time and click the Join Now button.

## *iDisk . . . iGetIt!*

So how do you open your iDisk? Leopard gives you a number of different avenues:

- ✓ **Choose Go⇒iDisk from the Finder menu and then choose My iDisk from the submenu.**

Keyboard types can press ⌘+Shift+I instead.

- ✓ **Click the iDisk icon in the Finder window Sidebar.**

## Is .Mac an ISP?

.Mac is many things, but it isn't an ISP (techno-nerd shorthand for *Internet Service Provider*). You need to join an ISP first because you need an existing Internet connection to use the services and features included in .Mac membership. This makes a lot of sense, considering that most of us already have Internet access. (Plus, Apple doesn't have to worry with all the support and hardware headaches that an ISP has to deal with.)

.Mac works with the ISP that you already have, so you don't have to worry about AOL or EarthLink conflicting with .Mac. (However, I can't guarantee that your system administrator at work will allow .Mac traffic across his or her pristine network. Perhaps a steak dinner would help your argument.)

### ✔ Click the iDisk button on your Finder toolbar.

It's easy to add an iDisk button. Open a Finder window, click View, and then click Customize Toolbar. Drag the iDisk icon up to the toolbar and click Done.

After you open your iDisk, an iDisk volume icon also pops up on your Desktop. You can open the little scamp later in your computing session by simply double-clicking the Desktop icon. The Desktop iDisk icon hangs around until you log out, restart, eject the iDisk, or shut down your iMac.

## *It's all in the folders*

Your iDisk contains a number of different folders. Some of them are similar to the subfolders in your Home folder, and others are unique to the structure of your iDisk. In this section, I provide the details on the iDisk folder family.

### *iDisk storage folders*

Although you can store files and create folders in the *root* (or top level) of an iDisk, the same organizational tips apply as those dealing with the root of your iMac's internal hard drive. In other words, most things that you copy to or create on your iDisk should be stored in one of these six folders (refer to Figure 9-1 to see them):

- ✔ **Documents:** Store the documents that you create with your applications in this folder, which only you can access.
- ✔ **Movies:** This folder stores your QuickTime movies (including any that you might use in your .Mac Web pages).
- ✔ **Music:** iTunes music and playlists go here.

- ✓ **Pictures:** The digital images that you store in this folder can be used with other .Mac services (like your Web pages) or within iPhoto.
- ✓ **Public:** The files that you store in this folder are meant to be shared with other people (as well as offered on your .Mac Web pages). You can also allow others to copy and save files to your Public folder as well (more on this later in this section).
- ✓ **Sites:** You can use HomePage to create Web pages in this folder, or you can add Web pages that you've created with your own applications. You can read more about *HomePage*, the Apple Web page-creation application, in the upcoming section, "Publishing a Web Site with HomePage."

These folders can be opened in a Finder window just like any typical folder on your iMac's internal hard drive, and you can open and save documents to your iDisk folders, using all your applications. In other words, these six iDisk folders act just like normal, everyday folders. Pretty doggone neat!

### *Funky specialized iDisk folders*

Your iDisk contains three folders that you *can't* use to store stuff (directly, anyway):



- ✓ **Backup:** This is the storage vault for the backup files created with the .Mac Backup application.  
Because you have Read access to the Backup folder, you can copy the backup files from this folder to a CD, DVD, or removable drive on your iMac. (I cover backing up later in this chapter.)
- ✓ **Library:** Like the Library folders that you find in the root of your hard drive (and in your Home folder), this folder stores all sorts of configuration settings for the .Mac features that you're using, like your Backup settings.
- ✓ **Software:** This read-only folder is a special case. Apple stuffs this folder full of a wide variety of the latest in freeware and shareware as well as commercial demo software. You can copy whatever you like from the Software folder to your iMac's Desktop and then install your new toy from that local copy. (Oh, and the contents of the Software folder don't count against your total storage space limit.) Enjoy!

## *Mirror, mirror, on your drive . . .*

You can use your iDisk even if you aren't connected to the Internet. This magic is accomplished through a *mirror*, or local copy of your iDisk, that's stored on your local hard drive. ("Hey, wasn't I supposed to be getting *away*



from storing things locally?") If you choose to use a mirror — and you can enable this feature if you like. The next time you connect to the Internet, Leopard automatically synchronizes any files that you created or changed on your local iDisk copy. This is a great feature if you have more than one Mac in different locations because you can update and synchronize your iDisk files from any of your computers — all automatically!



Without a mirror, you *must* have an active Internet connection to use your iDisk.

To enable (or disable) the mirror feature, open System Preferences, click the .Mac icon, and then click the iDisk tab to display the settings you see in Figure 9-3. Click the Start button, and — after a moment of preparation, complete with its own dialog — the text above the button reads iDisk Syncing On.



**Figure 9-3:**  
Configure  
iDisk within  
System  
Preferences.



If you use a local copy of your iDisk — and I recommend it — choose to synchronize automatically. This ensures that your files get updated even if you're somewhat forgetful, like I am.



A mirror makes things much faster when you browse your iDisk or when you save and load documents from your iDisk. Leopard actually uses your local copy from your hard drive, and then updates your remote iDisk files in the background while you work. (Leopard is updating your iDisk whenever you see that animated circular-yin-yang-thinglet rotating next to your iDisk icon in the Finder window. You'll know it when you see it.)

## *Monitoring and configuring your iDisk*

The iDisk pane in System Preferences groups together all the configuration settings you can make to your iDisk and your .Mac account. In this section, I review the controls that you can find here.

### *Disk space*

Concerned about how much of your 100MB (for trial users) or 10GB (for subscribers) remains? The iDisk panel (refer to Figure 9-3) includes the Disk Space bar graph, which always displays how much of your iDisk space is free. (The bar actually totals only half of your storage because the other half of your iDisk is reserved for e-mail use.)

### *Public folder*

The Finder Go menu includes a shortcut to access another .Mac member's Public folder.

### Password

I strongly recommend that you set a password to protect the contents of your Public folder.

This password must be entered by anyone trying to open your Public folder. If you haven't supplied that person with the proper password, he can't open your Public folder. Just that simple. (There's nothing more embarrassing than discovering the bikini shots from your vacation are available for every .Mac user to peruse.)



Here's one drawback to this extra level of security: If you password-protect your Public folder, it can't be used to store anything that you offer on your .Mac Web pages.

### Settings

While you're in the iDisk panel, you can configure your Public folder security settings. You can decide whether others should be able to

✓ **Only read the contents of your Public folder.**

By default, the Public folder is set to read-only.

✓ **Copy documents to your Public folder.**

To give others the ability to save and copy, select the Read & Write radio button.

## Backing Up Your Treasured Stuff

My editors have heard me drone on and on long enough about how important it is to back up your hard drive. They probably rub their eyes when they encounter yet another instance of my preaching about *the wages of backup sloth* and *losing everything but hindsight*.

Well, you're lucky, because I was just about to launch into another round of backup warnings. .Mac subscribers get a great utility application called Backup when they join the club. Backup is a great application that saves a copy of your treasured data on just about any media on the planet, including

- ✓ Your iDisk (using the Backup folder that I discuss earlier in this chapter)
- ✓ An external USB or FireWire hard drive
- ✓ Recordable CD or DVD media
- ✓ Network servers
- ✓ Your iPod



Before you get too enthusiastic about backing up to your iPod, heed this: You can indeed back up to your iPod (or I wouldn't have listed it as an option), but your iPod's tiny hard drive isn't meant to handle the same serious thrashing as a full-size external hard drive. Personally, I've never used my iPod as a backup destination, and I don't recommend that you do, either, unless no other recording media is handy and you absolutely have to have a backup.



If you'd like an offline copy of your data that would survive a catastrophe like a fire or theft, consider using both Time Machine and Backup. That way, your stuff is covered in the WCS (short for *worst case scenario*).

## Installing Backup

Backup isn't built into Leopard; you have to download it from the .Mac site at [www.mac.com/dotmac](http://www.mac.com/dotmac). After the image file is mounted on your Desktop, you see the Backup installation folder. Double-click the `Backup.pkg` file to begin the installation. After installation is complete, you can find Backup in your Applications folder.

## Saving your stuff

Nothing is more important to a proud iMac owner than a secure backup; in this section, I demonstrate how you can produce both *manual* backups

(produced whenever you like) and *automated* backups (which are scheduled at regular intervals). **Do it!**



Remember, you're limited to 100MB with a trial membership! (We're still talking about several hundred JPEG images that can fit in 100MB, but that total isn't much when you consider digital video or your iTunes Library.)

Beginning a backup is as easy as marking the check boxes next to the items that you want to safeguard. These are the default Backup Plans available, and they are already scheduled to start automatically.

After you enable the check boxes for the items you want to back up, follow these steps to start a manual backup:

**1. Click Continue to display the Backup main window.**

Notice that each backup plan you selected on the previous screen has a scheduled time assigned to it for automatic operation.

**2. Click the plan you want to select it; then click Back Up.**

The rest is cake as your irreplaceable stuff is saved to your iDisk.

If you ever need to restore from your backup, click the desired plan to select it, and then click the Restore button. Backup leads you through the restore process with the same aplomb.

The Backup application itself doesn't need to be running for the automated backup to kick off, but keep in mind that your iMac must remain awake! Make sure that

- You're logged in.
- Sleep mode is completely disabled on the Energy Saver pane within System Preferences.
- Your computer has an active Internet connection.

## *Publishing a Web Site with HomePage*

HomePage is a very popular feature for .Mac members. Most iMac owners aren't Web page designers, after all, and HomePage is extremely easy to use. Apple is smart enough to let trial .Mac members use HomePage; you can try it before you decide to invest in a .Mac subscription.

Follow these steps to create a new Web page on your .Mac site with HomePage:

**1. Launch Safari and visit [www.apple.com/dotmac](http://www.apple.com/dotmac).**

2. Click the **Log In** link, and enter your .Mac member name and password when prompted.
3. Click the **HomePage** link at the top of the .Mac Welcome page.

The HomePage top-level page that you see in Figure 9-4 appears.

4. Choose a theme for your page from the tabbed display at the left of the screen.

Some of the categories are specially designed for certain chores. For example, the Photo Album theme collection is perfect for showing off your digital photographs online, and the File Sharing category presents an easy downloading format for your visitors. Each of these different categories displays different onscreen instructions that are specific to their use.

For an elegant site where you show off your best photography online, click the Formal frame in the Photo Album category.

5. Choose the folder with the photos you want to include on the page.

This can be either your iDisk Pictures folder or a subfolder that you created within it.

6. Click **Choose**.

HomePage loads all the images in the selected folder.



**Figure 9-4:**  
Good call —  
you're about  
to create a  
.Mac Web  
page.

7. Mark the Show check box for each image that you want to appear.
8. Drag the image thumbnails to the order that you want.
9. Click in the text boxes to add

- The Web page title
- An introductory sentence (or two)
- The titles for each photo



You can display a *counter* (which tallies how many visitors came to your page) and an e-mail button (so your visitors can send a message to your .Mac e-mail account). To use either of these features, just mark the corresponding Show check box to enable it.

10. Click **Preview in the toolbar at the top of the page to see what your page will look like.**



If the page you see in Preview mode isn't up to snuff, click the Back button on the Safari Toolbar to edit it.

11. **If you like what you see, click the Publish button.**

Huzzah! You're a Web page designer! (Insert sound of champagne cork popping here.)

HomePage displays your new Web page address, which you can click to jump directly to your new work of art.



The steps to create a page vary by category. However, the only category that really requires any rocket science is the Advanced tab, which allows you to use your own HTML files that you copy to your iDisk Sites folder. Not to worry, though: Just follow the onscreen instructions for creating a Web site with your own HTML files, and you'll be fine.

## Chapter 10

# Hooking Up with Handy Helpers

---

### *In This Chapter*

- ▶ Adding a printer or a scanner to your system
  - ▶ Using Photo Booth
  - ▶ Putting your Apple Remote to work
  - ▶ Watching cable or satellite TV on your iMac
- 

**T**his chapter is all about getting interesting things into — and out of — your iMac. Some are more common (almost mundane these days) and pretty easy to take care of, such as scanners and printers. Then I might surprise you with something new to you, like your iMac's built-in video camera.

I also show you how to turn your iMac into a photo booth, and how to use that wonderful Apple Remote that came with your computer. Heck, I'll even describe how you can pull that fancy satellite or cable TV signal into your iMac.

It's perfectly okay to tell everyone else that you're watching the financial channel. But watching a little football never hurt anyone. . . .

## *Connecting Printers*

All hail the USB port! It's the primary connection point for all sorts of goodies. In this section, I concentrate on adding a local USB printer and the basics of adding a network printer to your system. (Find more on connecting a wireless Bluetooth printer in the Bonus Chapter at [www.mlcbooks.com](http://www.mlcbooks.com).)

### *USB printers*

Connecting a USB printer to your iMac is duck soup. Don't you wish all things in life were this easy? You might very well be able to skip most of the steps in this section entirely, depending on whether your printer came with an

installation disc. (Virtually all do, of course, but you might have bought yours used, say from eBay.)

Your printer needs to be fully supported within Mac OS X:

- ✓ If the software is designed for earlier versions of Mac OS X (say, v. 10.3 or v. 10.4), it probably works with Leopard.
- ✓ I always recommend visiting the manufacturer's Web site to download the latest printer driver and support software *before* you install your printer. That way, you know that you're up to date. (Don't forget to check the Read Me file that accompanies your new software to make sure there are no new system requirements!)



Save and close open files and applications before installing your printer. You might have to restart your iMac to complete the installation.

The physical connections for your printer are pretty simple:

- ✓ Make sure that your printer's USB cable is plugged in to both your iMac and the printer itself. (For a printer, I recommend using one of the iMac's USB ports on the back of the computer.)
- ✓ After the USB connection is made, plug the printer in to an AC wall socket and turn it on.



Don't forget to add the paper and check the ink cartridge(s)!

The finishing printer installation steps depend on whether you have a manufacturer's installation CD for your printer.

### ***Sure, I've got the install disc***

If your printer comes with its manufacturer's installation disc, follow these steps when everything is connected and powered on:



#### **1. Insert the installation disc in the iMac.**

The disc contents usually appear in a Finder window. If they don't, double-click the installation disc icon on the Desktop to open the window.

#### **2. Double-click the installation application to start the ball rolling.**

#### **3. Follow the onscreen instructions.**

Files get copied to your hard drive.

You might have to restart your iMac.

You're ready to print!





Don't forget to visit your printer manufacturer's Web site to check whether any driver updates are available for your particular model.

### ***Whoops, I've got diddly-squat (Software-wise)***

Didn't get an installation CD? Try installing the printer without software, or download the software from the manufacturer's Web site.

#### ***Installing without software***

If you didn't get an installation CD with your printer, you might be lucky enough that your printer's driver was included in your installation of Mac OS X. First, press  $\text{⌘}+\text{P}$  within an application to display the Print dialog, where you can check to see whether the printer you connected is already recognized.

If it's not displayed, here's how to check for that pesky driver after you connect the printer and switch it on:

- 1. Open the System Preferences window.**
- 2. Click the Print & Fax icon.**
- 3. Click the Add button (which sports a plus sign).**
- 4. Check the Printer list in the Printer Setup Utility window to see whether your printer has already been added automatically within Leopard.**

If your printer appears here, dance a celebratory jig. You can close System Preferences and choose that printer from the Print dialog in your applications. (You can even set it as the default from the System Preferences Print & Fax pane. Just click the Default Printer pop-up menu to select your new printer.)

#### ***Downloading software***

If you don't have installation software and your iMac doesn't automatically match your USB printer with a driver, it's time to check the Internet to locate a Leopard-compatible driver for your printer.

Check the manufacturer's Web site for your printer's software. Look for



#### **✔ Special software drivers that the printer might need**

Install any drivers you find *before* you run an installation application. Otherwise, the installation app might not be able to recognize or configure the printer if the driver hasn't been installed first.

#### **✔ Installation application**

If the manufacturer offers an installation application for your printer, download the application and run it.

## *Network printers*

Your wired or wireless Ethernet network provides a quick-and-easy way to share any printer that's connected to your iMac. Follow these steps to share your printers across the network with others:

1. **Click the System Preferences icon on the Dock.**
2. **Click the Sharing icon.**
3. **Select the On check box next to the Printer Sharing service entry.**
4. **Click Close to exit System Preferences.**

In most cases, a printer that you share automatically appears in the Print dialog on other computers connected to your network. Therefore, if you want to access a printer being shared by another Mac across your network, open the Print dialog within your application and click the Printer pop-up menu to select it.

If the remote printer isn't listed automatically, you can dig a little further. To add a printer that another Mac on your network is sharing to your list of printers, follow these steps:

1. **Click System Preferences on the Dock.**
2. **Click the Print & Fax icon.**
3. **Click the Add button (which carries a plus sign).**
4. **Click the Default button on the toolbar.**

Leopard displays all the available local shared printers. Click the desired printer and then click Add.

## *Connecting Scanners*

USB and FireWire scanners practically install themselves. As long as the model is listed as Mac OS X-compatible and it supports the TWAIN device standard (just about all scanners do), things really *are* plug-and-play. (Not sure if a scanner is Mac OS X-compatible? Check the system requirements on the scanner's box or on the manufacturer's Web site.)

If you have the scanner manufacturer's installation disc, go ahead and use it. However, most scanners don't require specialized drivers, so even that orphan model that you picked up from Uncle Milton last year should work (if it's

recognized by Mac OS X). It doesn't hurt to check the manufacturer's Web site to see whether any of the software has been updated since the disc was produced.



If Mac OS X doesn't support your older scanner, a third-party application might be able to help. Get thee hence to Hamrick Software at [www.hamrick.com](http://www.hamrick.com) and download a copy of the latest version of VueScan. This great scanning application supports over 750 scanner models, including a number that don't work with Leopard otherwise. At \$40, it's a world-class bargain to boot.

Ready to go? Make sure that your scanner is powered on and connected to your iMac (and that you load a page or photograph to scan). If your scanner's installation disc provided you with a proprietary scanning application, I recommend that you use that application to test your scanner. In fact, it's Mark's Maxim time!



If your printer or scanner includes bundled applications, *use them!*<sup>TM</sup>

Sure, Mac OS X has the Print & Fax pane within System Preferences for printers and the Image Capture application for scanners and digital cameras, but these are bare-bones tools compared with the print manager and image acquisition software that comes bundled with your hardware. I turn to Leopard's built-in hardware handling stuff only when I don't have anything better.

Hey, I'm not saying that anything's wrong with Image Capture, which is in your Applications folder, if you need to use it. However, don't expect Image Capture to support any specialized features offered by your scanner (like one-button e-mail or Web publishing). You have to use the application especially designed for your manufacturer and model to take advantage of any extras that it offers.

## Using Photo Booth and Front Row

Many Apple switchers and first-time owners quickly notice two rather unusual items that accompany the latest iMacs: One appears to be a tiny square lens and LED light at the top of the iMac's svelte frame, and the other looks like a stick of chewing gum sporting buttons. What gives?

First, allow me to identify these toys. The former is the lens of your iMac's built-in iSight camera, which allows you to capture video or snap a quick fun series of photos via Leopard's Photo Booth application. The latter is your Apple Remote, which you can use to control your iMac from the comfort of your lounge chair or breakfast nook via Leopard's Front Row software.

## Capturing the moment with Photo Booth

What's that you say? You've never used a computer video camera? Well then, good reader, you've come to the right place!

The iSight camera's indicator light glows green whenever you're taking a snapshot or recording video . . . which, when you think about it, is A Good Thing (especially if you prefer chatting at home in Leisure Mode).



If you need a quick picture of yourself for use on your Web page, or perhaps your iChat icon needs an update to show off your new haircut, use Photo Booth to capture images at 640 x 480 resolution and 32-bit color. Although today's digital cameras can produce a much higher-quality photo, you can't beat the built-in convenience of Photo Booth for that quick snapshot!

To snap an image in Photo Booth, follow these steps:

**1. Launch Photo Booth from the Dock or from the Applications folder.**

Check out that glowing LED!

**2. (Optional) Click the Effects button to choose an effect you'd like to apply to your image.**

Photo Booth displays four screens of thumbnail preview images (see Figure 10-1) so that you can see how each effect changes the photo. To move through the thumbnail screens, click the Previous and Next arrow buttons that appear around the Effects button.

You can produce some of the simple effects you might be familiar with from Photoshop, such as a black-and-white image or a fancy, colored pencil filter . . . but it can also deliver some mind-blowing distortion effects, and even an Andy Warhol-style pop-art image!

Of course, you can always launch your favorite image editor afterward to use a filter or effect on a photo — for example, the effects available in iPhoto — but Photo Booth can apply these effects automatically as soon as you take the picture.

**3. (Optional) Click a thumbnail to select the desired effect.**

To return the display to normal, click the Normal thumbnail, which appears in the center. (Um, that would be Paul Lynde's spot, for those of you old enough to remember *Hollywood Squares*.)

**4. Click the Camera button.**



**Figure 10-1:** Photo Booth does one thing particularly well—candid photography.

The image appears in the film strip at the bottom of the window. Photo Booth keeps a copy of all the images you take in the film strip so that you can use them later. After you click a photo in the filmstrip, a series of buttons appear, inviting you take any one of a series of actions, including

- ✓ Sending the photo in an e-mail message
- ✓ Saving the photo directly to iPhoto
- ✓ Using the image as your Leopard user account icon
- ✓ Using the image as your iChat Buddy icon



To delete an image from the Photo Booth filmstrip, click the offending photo and then click the X button that appears underneath.

If you're itching to connect a USB digital camera for use with iPhoto, let me redirect you to Chapter 12, where I cover the iPhoto experience in depth.

To capture a video clip, click the Movie Clip button (which bears frames from an old-fashioned movie reel) at the lower left of the Photo Booth window. Click the Big Red Movie Button to start recording, and click again to end the clip.

## Controlling your iMac remotely with Front Row

Okay, you've seen some neat stuff so far, but things get *really* cool about now! With Apple's Front Row software, you can turn your iMac into a multimedia presentation center that can show off all your digital media to your adoring public (and friends and family to boot). In fact, with the Apple Remote, you don't even have to leave the comfort of the couch to start the show.

The Front Row application performs four different functions:

- ✓ **Watching DVD movies with DVD Player:** If you already loaded a DVD into your optical drive, you can watch it. (Sorry, your iMac doesn't load the DVD for you. I guess *some* things have to remain manually driven for a few years yet.)
- ✓ **Viewing photos and slideshows:** Front Row calls upon iPhoto so that you can see your albums, film rolls, and slideshows.
- ✓ **Displaying videos in QuickTime Player:** You can choose any video you download from the iTunes Music Store or save to your Movies folder.
- ✓ **Coaxing your favorite music, podcasts, and TV shows from your iTunes library:** Find your media and playlists available from Front Row.

All this is accomplished by using the awesome, infrared Apple Remote you see in Figure 10-2. If your last computer — the beige box — didn't *have* a remote control, don't panic. It's as simple to use as an iPod Shuffle!

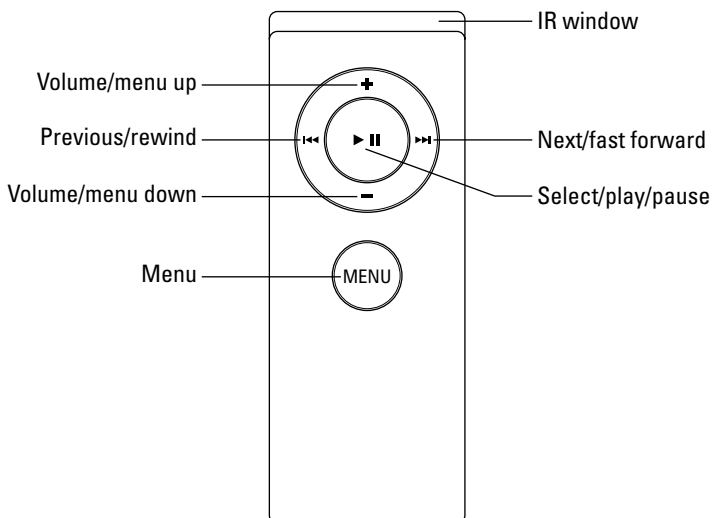

**Figure 10-2:**

Is it an  
older iPod  
Shuffle?  
No, it's the  
Apple  
Remote!



To launch the application, press the Menu button on the remote. As long as your iMac is on, Front Row runs automatically. To put your iMac to sleep after a night of fun, press and hold the Select/Play/Pause button.

Table 10-1 includes the important functions of the Apple Remote in Front Row.

<b>Table 10-1 Using the Apple Remote in Front Row</b>	
<i>Action</i>	<i>Purpose</i>
Menu	Press to launch Front Row or to return to the previous menu.
Volume/Menu Down	Press to navigate down through menu options or to lower the volume while media is playing.
Volume/Menu Up	Press to navigate up through menu options or to raise the volume while media is playing.
Select/Play/Pause	Press to select a menu item, or play or pause media from within iTunes, DVD Player, QuickTime, or iPhoto.
Next/Fast Forward	Press to skip to the next song or DVD chapter, or hold down to fast-forward through a song.
Previous/Rewind	Press to skip to the previous song or DVD chapter, or hold down to rewind a song.

You can also go the mundane route and use keyboard shortcuts to control Front Row (but it's nowhere near as cool). Table 10-2 explains the keyboard shortcuts.

<b>Table 10-2 Using the Keyboard in Front Row</b>	
Action	Keyboard Equivalent
Menu	⌘+Esc to enter the menu; Esc to exit it
Volume/Menu Down	Down arrow (↓)
Volume/Menu Up	Up arrow (↑)
Select/Play/Pause	Spacebar or Return
Next/Fast Forward	Right arrow (→)
Previous/Rewind	Left arrow (←)



Note that Front Row has no complex configuration. Front Row is what designers call a *front-end application*; that is, it launches the Leopard applications necessary to display or play the media you select. (There is a simple Settings menu in Front Row, offering you the chance to toggle your screen saver and menu sound effects off or on. Both options are turned on by default.)



Your Apple Remote isn't designed to work with any other third-party applications at the time of this writing. For example, you can't use it as a presentation aide in PowerPoint. However, some Apple applications do recognize the Apple Remote (like Keynote), and it's a sure bet that Apple will continue to add functionality to the Apple Remote in the future. Check the Apple Remote section of Leopard's online Help system to keep tabs on what's happening!

## Turning Your iMac into a TV — And More

Your iMac's beautiful LCD screen would seem to be the perfect artist's canvas for watching cable or satellite TV broadcasts, but there's no co-ax input on the back of your computer. Therefore, unless you invest in some additional hardware, you're restricted to watching DVD movies.

Such an obvious need is going to be filled quickly, and a number of different hardware manufacturers have produced external devices that can merge your iMac and your TV signal. Most are USB or FireWire peripherals, and many have all the features of today's TiVo and digital video recorders.

My favorite example is the EyeTV Hybrid, from Elgato Systems ([www.elgato.com](http://www.elgato.com)), which uses a USB connection. Check out what this superstar includes for your investment of \$150:

- ✓ Built-in NTSC (analog) and ATSC (digital TV) tuners, cable-ready with a coaxial connector
- ✓ The ability to pause, fast-forward, record, or even edit the video you stored on your iMac's hard drive
- ✓ Capability to schedule recordings with an onscreen program guide
- ✓ Full-screen TV display or in a window anywhere on your Desktop
- ✓ No external power supply required

I really love the ability to fast-forward through commercials, and I can take anything that I record on my iMac and use it in iDVD and iMovie. The addition of TV under your control sorta finalizes the whole digital hub thing, now doesn't it?



# Part IV

## Living the iLife

The 5<sup>th</sup> Wave

By Rich Tennant

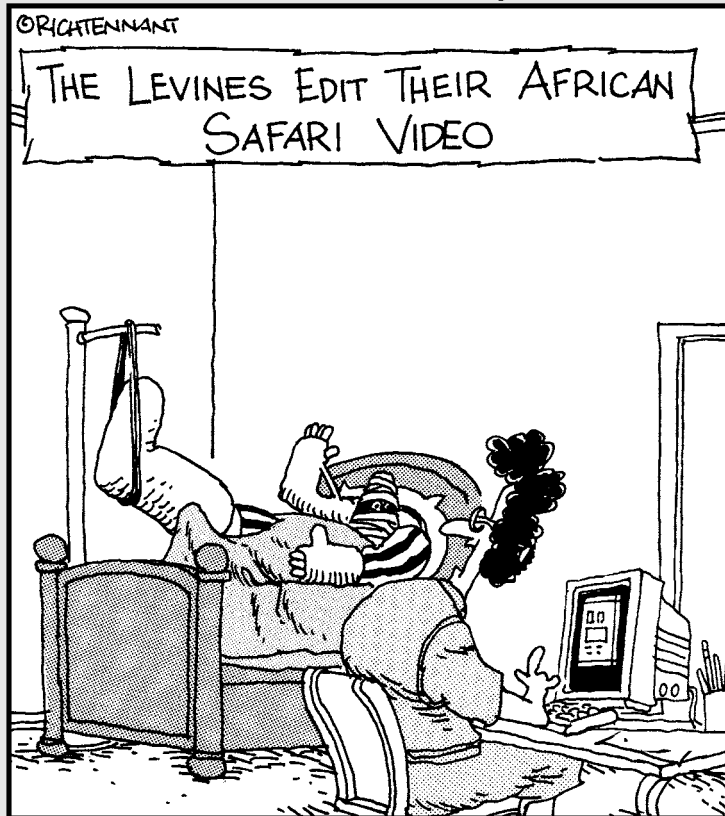

"Do you think the 'Hidden Rhino' clip should come before or after the 'Waving Hello' video clip?"

## *In this part . . .*

**H**ere they are, the applications that everyone craves: This part covers iTunes, iPhoto, iMovie, iDVD, and GarageBand like your Grandma's best quilt. You find out how to share your images, music, and video clips between the major iLife '08 applications on your iMac, and how to create everything from your own DVDs to a truly awesome hardcover photo album!

## Chapter 11

# The Multimedia Joy of iTunes

### *In This Chapter*

- ▶ Playing music with your iMac
- ▶ Arranging and organizing your music collection
- ▶ Tuning into the world with Internet radio
- ▶ Sharing your songs across a network
- ▶ Creating eye candy with the Visualizer
- ▶ Buying the good stuff from the iTunes Store

**S**ometimes, words just aren't enough. iTunes is that kind of perfection.

To envision how iTunes changes your iMac, you have to paint the picture with *music* — music that's easy to play, easy to search, and easy to transfer from place to place. Whether it be classical, alternative, jazz, rock, hip-hop, or folk, I can guarantee you that you won't find a better application than iTunes to fill your life with your music. And podcasts. And video. And TV shows. And Internet radio. (See how hard it is to pin down this wonderful application? Along with your iMac, iTunes really does form the hub of your digital lifestyle.)

In this chapter, I lead you through all the features of my absolute favorite member of the iLife suite . . . and it's going to be pretty doggone obvious how much I appreciate this one piece of software.

## *What Can I Play on iTunes?*

Simply put, *iTunes* is a media player: It plays audio and video files. These files can be in many different formats. Some of the more common audio formats that iTunes supports are

- ✓ **MP3:** The small size of MP3 files has made them popular for file trading on the Internet. You can reduce MP3 files to a ridiculously small size (albeit at the expense of audio fidelity), but a typical CD-quality, three-minute pop song in MP3 format has a size of 3–5MB.



- ✓ **AAC:** AAC (short for Advanced Audio Coding) is an audio format that's very similar to MP3; in fact, AAC files offer better recording quality at the same file sizes. However, this format also supports a built-in, copy-protection scheme that prevents AAC music from being widely distributed on Macs. (Luckily, you can still burn AAC tracks to an audio CD, just like MP3 tracks.) The tracks that you download from the iTunes Store are in AAC format.

The iTunes Store's recently introduced iTunes Plus tracks are also in AAC format, but these tracks are not copy-protected, and they're encoded at a higher-quality 256 Kbps rate. You can listen to your iTunes Plus tracks on as many Macs as you like.

- ✓ **Apple Lossless:** Another format directly from Apple, *Apple Lossless* format provides the best compromise between file size and sound quality. These tracks are encoded without loss of quality (hence, the name, as opposed to *lossy* compression schemes, such as MP3). However, Apple Lossless tracks are somewhat larger than AAC files, so they're generally the favorite of the most discerning audiophile for their entire music library.
- ✓ **AIFF:** This standard Macintosh audio format produces sound of the absolute highest quality. This high quality, however, also means that the files are pretty doggone huge. A typical pop song in AIFF format has a size of 30–50MB.
- ✓ **WAV:** Not to be outdone, Microsoft created its own audio file format (WAV) that works much like AIFF. It can reproduce sound at higher quality than MP3, but the file sizes are very large, like AIFF.
- ✓ **CD audio:** iTunes can play audio CDs. Because you don't usually store CD audio anywhere but on an audio CD, file size is no big whoop.
- ✓ **Movies and video:** You can buy and download full-length movies, TV shows, music videos, and movie trailers from the iTunes Store. And, with an Apple TV unit connected to your home theater system, you can watch those movies and videos from the comfort of your sofa on the other side of your house.
- ✓ **Podcasts:** These relatively new programs are like radio programs for your iPod, but iTunes can play and organize them, too. Some podcasts also include video and photos, to boot.
- ✓ **Audiobooks:** No longer do you need cassettes or audio CDs to enjoy your spoken books. iTunes can play them for you, or you can send them to your iPod for listening on the go.
- ✓ **Streaming Internet radio:** You can listen to a continuous broadcast of songs from one of tens of thousands of Internet radio stations, with quality levels ranging from what you'd expect from FM radio to the full quality of an audio CD. You can't save the music in iTunes, but it's still great fun. (In fact, I run my own station . . . more on MLC Radio later in the chapter.)

## Playing an Audio CD

Playing an audio CD in iTunes is simple. Just insert the CD in your computer's disc tray, close the tray, start iTunes by clicking its icon on the Dock, and click the Play button. (Note that your iMac might be set to automatically launch iTunes when you insert an audio CD.) The iTunes interface resembles that of a traditional cassette or CD player. The main playback controls of the iTunes interface are Previous Song, Play, Next Song, and the volume slider, as shown in Figure 11-1.

Click the Play button to begin listening to a song. While a song is playing, the Play button toggles to a Pause button. As you might imagine, clicking that button again pauses the music. If you don't feel like messing around with a mouse, you can always use the keyboard. The spacebar acts as the Play and Pause buttons. Press the spacebar to begin playback; press it again to stop.

Click the Next Song button to advance to the next song on the CD. The Previous Song button works like the Next Song button but with a slight twist: If a song is playing and you click the Previous Song button, iTunes first returns to the beginning of the current song (just like an audio CD player). To advance to the previous song, double-click the Previous Song button. To change the volume of your music, click and drag the volume slider.

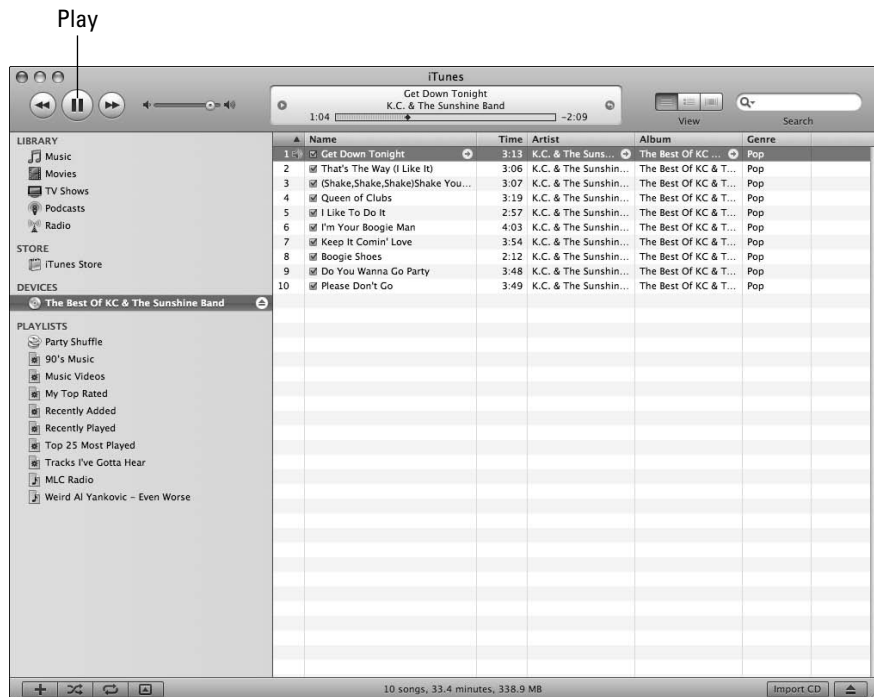

**Figure 11-1:**  
The main  
playback  
controls:  
Play,  
Previous,  
and Next.

Like other Macintosh applications, you can control much of iTunes with the keyboard. Table 11-1 lists some of the more common iTunes keyboard shortcuts. (Note that iTunes must be the active application for these shortcuts to work.)

<i>Press This Key Combination</i>	<i>To Do This</i>
Spacebar	Play the selected song if iTunes is idle.
Spacebar	Pause the music if a song is playing.
Right-arrow key (→)	Advance to the next song.
Left-arrow key (←)	Go back to the beginning of a song. Press a second time to return to the previous song.
⌘+up-arrow key (↑)	Increase the volume.
⌘+down-arrow key (↓)	Decrease the volume.
⌘+Option+down-arrow key (↓)	Mute the audio, if any is playing. Press again to play the audio.

## *Playing Digital Audio and Video*

In addition to playing audio CDs, iTunes can also play the digital audio files that you download from the Internet or obtain from other sources in the WAV, AAC, Apple Lossless, AIFF, and MP3 file formats. Enjoying a digital audio file is just slightly more complicated than playing a CD. After downloading or saving your audio files to your iMac, open the Finder and navigate to wherever you stored the files. Then simply drag the music files (or an entire folder of music) from the Finder onto the Music entry in the iTunes Source list, on the left side of the iTunes window. (The added files appear in the iTunes Music Library. Think of the Library as a master list of your music.

To view the Music Library, select the Music entry in the left-hand column of the iTunes player, as shown in Figure 11-2. Go figure.) Heck, you can also drag a song file from a Finder window and drop it on the iTunes icon in the Dock, which adds it to your Music Library as well.



If you drop the file on top of a playlist name in the Source list, iTunes adds it to that particular playlist as well as the main Library. (More about playlists in a bit.)



**Figure 11-2:**  
The Music Library keeps track of all your audio files.

To play a song, just double-click it in the Music Library list. Alternatively, you can click the song once to select it and use the playback controls (Previous Song, Play, and Next Song) that I discuss earlier in this chapter. (Refer to Figure 11-1.)



The Source list of iTunes can list up to six possible sources for audio:

- ✓ **Library:** This section includes Music, Movies, TV Shows, Podcasts, Audiobooks, iPod Games, and Radio. (Think *Internet radio*, which I discuss further in the section, “iTunes Radio.”)
- ✓ **iPod:** If an iPod is connected, it appears in the list. (And yes, Virginia, other models of MP3 players from other companies also appear in the list if they support iTunes.)
- ✓ **iTunes Store:** I discuss this later in the section, “Buying Digital Media the Apple Way.”
- ✓ **Audio CD:** A standard audio CD . . . anything from the Bee Gees to Fall Out Boy.
- ✓ **Shared music:** If another Mac on your local network is running iTunes and is set to share part (or all) of its library, you can connect to the other computer for your music. (Shared music on another Mac appears as a separate named folder in the Source list.) Of course, you can elect to share your music with others as well.
- ✓ **Playlists:** Think of playlists as folders that you use to organize your music. (More on playlists later in this chapter.)



If you've invested in an Apple TV, it will appear in the list, but it doesn't actually provide media for you to enjoy on your iMac. Instead, content flows in the other direction, with iTunes streaming or synchronizing media to your Apple TV, which in turn sends it to your EDTV or HDTV.

Notice also that the Library lists information for each song that you add to it, such as

- ✓ **Name:** The title of the song
- ✓ **Time:** The length of the song
- ✓ **Artist:** The artist who performs the song
- ✓ **Album:** The album on which the song appears

Most MP3 files have embedded data — title, album, or artist information, for example — that iTunes can read, but don't panic if those fields are blank or generic right now. If a song doesn't include any data, you can always add the information to these fields manually. I show you how later in the section, "Setting or changing the song information manually."



Clicking any of the column headings in the Library causes iTunes to reorder the Library according to that category. For example, clicking the Name column heading alphabetizes your Library by song title (and another click reverses the order). I click the Time heading often to sort my Library according to the length of the songs. Oh, and you can drag column titles to reorder them any way you like.

iTunes can display your Music Library in three ways: By default, the application uses the list view that you see in Figure 11-1, where each song is one entry. Click the second View button (at the top of the iTunes window) to group tracks together by album. Click the third View button (Cover Flow), and you're browsing by album cover, complete with reflective surface!



In fact, you can even browse full-screen in Cover Flow mode. Click the Full-Screen button at the lower right of the cover pane — it looks like a box with arrows at each corner — and iTunes switches to full-screen mode, complete with those familiar play controls.

## *Browsing the Library*

After you add a few dozen songs to iTunes, viewing the Library can become a task. Although a master list is nice for some purposes, it becomes as cumbersome as an elephant in a subway tunnel if the list is very long. To help out, iTunes can display your Library in another format, too: namely, browsing mode. To view the Library in browsing mode, click the Browse button at the lower-right corner of the iTunes window, which carries an eye icon.



The Browse mode of iTunes displays your library in a compact fashion, organizing your tunes into four sections:

- ✓ Genre
- ✓ Artist
- ✓ Album
- ✓ Name

Selecting an artist from the Artist list causes iTunes to display that artist's albums in the Album list. Select an album from the Album list, and iTunes displays that album's songs in the bottom section of the Browse window. (Those Apple software designers . . . always thinking of you and me.) Note that the Browse button is disabled in Cover Flow view mode.

## *Finding songs in your Music Library*

After your collection of audio files grows large, you might have trouble locating that Swedish remix version of "I'm Your Boogie Man." To help you out, iTunes has a built-in Search function. To find a song, type some text into the search field of the main iTunes window. While you type, iTunes tries to find a selection that matches your search text. The search is quite thorough, showing any matching text from the artist, album, song title, and genre fields in the results. For example, if you type **Electronic** into the field, iTunes might return results for the band named *Electronic* or other tunes that you classified as *electronic* in the Genre field. (The upcoming section, "Know Your Songs," tells you how to classify your songs by genre, among other options.) Click the magnifying glass at the left side of the Search field to restrict the search even more: by Artists, Albums, Composers, and Songs.

### **Will I trash my Count Basie?**

Novice iTunes users, take note: iTunes watches your back when you trash tracks.

To illustrate: Suppose you try to delete a song from the Library that's located only in the iTunes music folder (which you didn't copy into iTunes from another location on your hard drive). That means you're about to delete the song entirely, with no copy remaining on your iMac. Rest assured, though, that iTunes will prompt you to make sure that you really want to move the file to the Trash. (I get fearful e-mail messages all

the time from readers who are loath to delete anything from iTunes because they're afraid they'll trash their digital music files completely.)

**Remember:** If you delete a song from the Library that exists elsewhere on your hard drive (outside the reach of the iTunes music folder), it isn't deleted from your hard drive. In fact, if you mistakenly remove a song that you meant to keep, just drag it back into iTunes from the Finder, or even from the Trash. 'Nuff said.

## *Removing old music from the Library*

After you spend some time playing songs with iTunes, you might decide that you didn't really want to add 40 different versions of "Louie Louie" to your Library. (Personally, I prefer either the original or the cast from the movie *Animal House*.) To remove a song from the Library, click the song to select it and then press the Delete key on your keyboard. (If that sounds a bit daunting, check out the sidebar earlier in the chapter, titled "Will I trash my Count Basie?")

## *Watching video*

Watching video in iTunes is similar to listening to your music. To view your video collection, click one of these entries in the Source list:

- ✓ **Movies**
- ✓ **Music Videos**
- ✓ **Video Podcasts**
- ✓ **TV Shows**

If you select Movies or TV Shows, iTunes displays your videos as thumbnails. Music Videos appear as a standard playlist.

From your collection, you can

- ✓ **Double-click a video thumbnail or an entry in the list.**
- ✓ **Drag any QuickTime-compatible video clip from the Finder window to the iTunes window.**

These typically include video files ending in `.mov` or `.mp4`.

iTunes plays video full-screen, but when you move your mouse, a control strip appears, sporting a standard slider bar that you can drag to move through the video (as well as a volume control and Fast Forward/Reverse buttons). You can also pause the video by clicking the Pause button.

## *Keeping Slim Whitman and Slim Shady Apart: Organizing with Playlists*

Given time, your iTunes Music Library can quickly become a fearsomely huge beastie. Each Library can contain thousands upon thousands of songs: If your Library grows anywhere near that large, finding all the songs in your

lifelong collection of Paul Simon albums is not a fun task. Furthermore, with the Library, if you just click Play, you're stuck listening to songs in the order that iTunes lists them.

To help you organize your music into groups, use the iTunes playlist feature. A *playlist* is a collection of some of your favorite songs from the Library. You can create as many playlists as you want, and each playlist can contain any numbers of songs. Whereas the Library lists all available songs, a playlist displays only the songs that you add to it. Further, any changes — deleting a song, for example — that you make to a playlist affect only that playlist, leaving the Library intact.

For example, suppose that you want to plan a party for your polka-loving friends. Instead of running to your computer after each song to change the music, you could create a polka-only playlist. Select and start the playlist at the beginning of the party, and you won't have to worry about changing the music the whole night. (You can concentrate on the accordion.)

To create a playlist, you can do any of the following:

- ✓ **Choose File⇨New Playlist.**
- ✓ **Press ⌘+N.**
- ✓ **Choose File⇨New Playlist from Selection.** This creates a new playlist and automatically adds any tracks that are currently selected in the Library. iTunes also attempts to name the playlist automatically for you.
- ✓ **Click the New Playlist button in the iTunes window** (the plus sign button in the lower-left corner). You get a newly created empty playlist (the toe-tappin' *untitled playlist*).

All playlists appear in the Source list. To help organize your playlists, it's a good idea to . . . well . . . *name* them. (Aren't you glad now that you have this book?) To load a playlist, select it in the Source list; iTunes displays the songs for that playlist. Click the playlist entry in the source list again to type a new name for the playlist.

To add a song from the Library to your new playlist, click the Library and find the song you want to include, and then drag it to the desired playlist entry in the Source list.

The same song can appear in any number of playlists because the songs in a playlist are simply pointers to songs in your Music Library — not the songs themselves. Add and remove them at will to any playlist, secure in the knowledge that the songs remain safe in the Library. As for removing playlists themselves, that's simple, too. Just select the playlist in the Source list and then press Delete.



Removing a playlist doesn't actually delete any songs from your Library.

## Some playlists are smarter than others

From the File menu, take a look at a menu command for creating a smart playlist. The contents of a *smart playlist* are automatically created from a specific condition or set of conditions that you specify via the Smart Playlist dialog: You can limit the track selection by mundane things, such as album, genre, or artist; or, you can get funky and specify songs that were played last, or by the date you added tracks, or even by the sampling rate or total length of the song. For example, iTunes can create a playlist packed with songs that are shorter than three minutes, so you can fill your iPod Shuffle with more stuff! Ah, but wait! You're not limited to a single criterion. If you want to add other criterion, click the plus sign at the right side of the dialog, and you get another condition field to refine your selection even further.

You can choose the maximum number of songs to add to the smart playlist; or limit the size of the playlist by the minutes or hours of play, or the number of megabytes or gigabytes the playlist will occupy. (Again, great for automatically gathering as much from your KISS collection that will

fit into a specific amount of space on a CD or your iPod.) Mark the Live Updating check box for the ultimate in convenience. iTunes automatically maintains the contents of the smart playlist to keep it current with your conditions at all times in the future. (If you remove tracks manually from a smart playlist, iTunes adds other tracks that match your conditions.)

Now think about what all these settings mean when combined . . . *whoa*. Here's an example yanked directly from my own iTunes library. I created a smart playlist that selects only those songs in the Rock genre. It's limited to 25 songs, selected by least often played, and live updating is turned on. The playlist is named "Tracks I've Gotta Hear" because it finds the 25 rock songs (from my collection of 1,654 songs) that I've heard least often! After I listen to a song from this smart playlist, iTunes automatically "freshens" it with another song, allowing me to catch up on the tracks I've been ignoring. Completely, unbelievably *sweet*— and another reason why iTunes is the best music player on Planet Earth!



Click the Party Shuffle playlist, and you encounter a random selection of songs taken from your iTunes Music Library — perfect for your next party! You can change the order of the songs in the Party Shuffle playlist, add songs from your Library, or delete songs that don't fit the scintillating ambience of your gathering. Enjoy!

## Know Your Songs

Besides organizing your music into Elvis and non-Elvis playlists, iTunes gives you the option to track your music at the song level. Each song that you add to the Music Library has a complete set of information associated with it. iTunes displays this information in the Info dialog, including

- ✓ **Name:** The name of the song
- ✓ **Artist:** The name of the artist who performed the song

- ✓ **Composer:** The name of the astute individual who actually wrote the song
- ✓ **Album Artist:** The name of the artist responsible for a compilation or tribute album
- ✓ **Album:** The album where the song appears
- ✓ **Grouping:** A group type that you assign
- ✓ **Year:** The year the artist recorded the song
- ✓ **BPM:** The beats per minute (which indicates the song's tempo)
- ✓ **Track Number:** The position of the song on the original album
- ✓ **Disc Number:** The original disc number in a multi-CD set
- ✓ **Comments:** A text field that can contain any comments on the song
- ✓ **Genre:** The classification of the song (such as rock, jazz, or pop)

You can display this information by clicking a song name and pressing ⌘+I — the fields appear on the Info tab. Alternately, you can click File⇨Get Info.

## Setting the song information automatically

Each song that you add to the iTunes Music Library might have song information included with it. If you add music from a commercial audio CD, iTunes connects to a server on the Internet and attempts to find the information for each song on the CD. If you download a song from the Internet, it often comes with some information embedded in the file already; the amount of included information depends on what the creator supplied. (And believe me, it's often misspelled as well — think *Leenard Skeenard*.) If you don't have an Internet connection, iTunes can't access the information and displays generic titles instead.



Internet connection restored? You can download the information on a CD at any time by choosing Advanced⇨ Get CD Track Names.

## Setting or changing the song information manually

If iTunes can't find your CD in the online database or someone gives you an MP3 with incomplete or inaccurate information, you can change the

information yourself — believe me, you want at least the artist and song name! To view and change the information for a song, perform the following steps:

1. Select the song in either the Music Library list or a playlist.
2. Press **⌘+I** or choose **File**→**Get Info**.
3. Edit the song's information on the **Info** tab, as shown in Figure 11-3.

Keep in mind that the more work you put into setting the information of the songs in your Music Library, the easier it is to browse and use iTunes. Incomplete song information can make it more difficult to find your songs in a hurry. If you prefer, you don't have to change all information about a song. (It just makes life easier later if you do.) Normally, you can get away with setting only a song's title, artist, and genre. The more information you put in, however, the faster you can locate songs and the easier they are to arrange. iTunes tries to help by automatically retrieving known song information, but sometimes you have to roll up your sleeves and do a little work. (Sorry, but the Data Elves are out to lunch.)

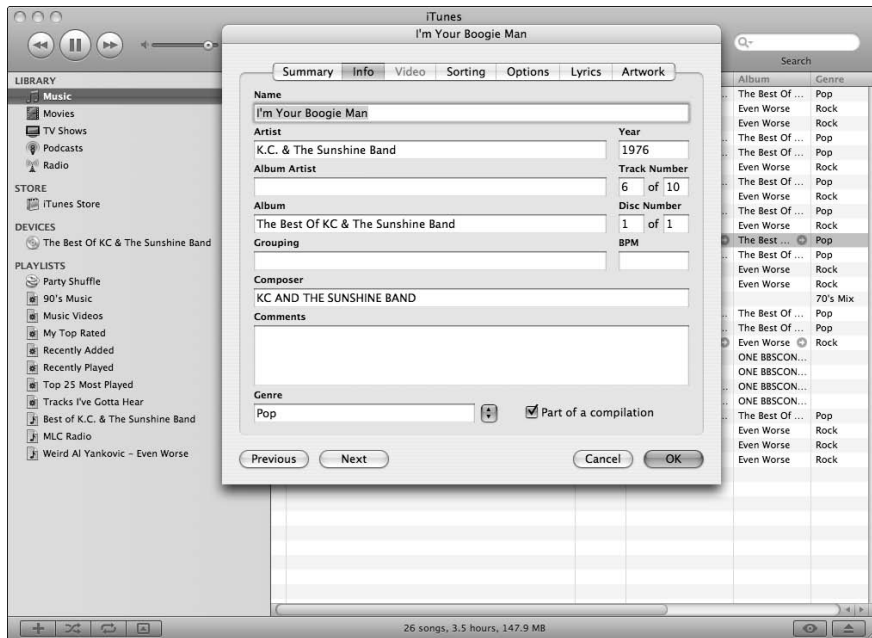

**Figure 11-3:**  
View and  
edit song  
information  
here.

“What about cover art, Mark?” Well, I’m overjoyed that you asked! iTunes displays the artwork in a number of different places (including Album view and Cover Flow view), and the application can try to locate artwork automatically for the tracks you select. (Note that adding large images can significantly increase the size of the song file.) Follow these steps:

1. **Select the desired songs from the track list.**
2. **Choose Advanced ⇨ Get Album Artwork.**



You can set iTunes to automatically attempt the addition of album artwork every time you rip tracks from an audio CD, or when you add songs without artwork to your Music Library. Click iTunes and choose Preferences. Click the General button and then select the Automatically Download Missing Album Artwork check box to enable it.



Unfortunately, the Get Album Artwork feature often doesn’t pull in any artwork for little-known artists. Luckily, you can always add album covers to your song info manually! Select one (or all) of the songs from a single album in the track list, display the Info dialog, and click the Artwork tab. Now launch Safari, visit Amazon.com, and do a search on the same album. Drag the cover image from the Web page right into the Info dialog and then drop it on top of the image well. When you click OK, the image appears in the Summary pane, and you can display it while your music is playing by pressing ⌘+G, or by pressing the Show or Hide Song Artwork button at the lower left of the iTunes window! (Again, adding large images can significantly increase the size of the song file.)

By the way, if you buy tracks or an album from the iTunes Store, Apple always includes album covers automatically. Thanks, Steve!

## Ripping Audio Files

You don’t have to rely on Internet downloads to get audio files: You can create your own MP3, AAC, Apple Lossless, AIFF, and WAV files from your audio CDs with iTunes. The process of converting audio files to different formats is *ripping*. (Audiophiles with technical teeth also call this process *digital extraction*, but they’re usually ignored at parties by the popular crowd.)

Depending on what hardware or software you use, you’re likely to encounter differences in formats. For example, most iPod owners prefer MP3 or AAC files, but your audio CDs aren’t in that format. Being able to convert files from one format to another is like having a personal translator in the digital world. You don’t need to worry if you have the wrong format: You can simply convert it to the format that you need.

The most common type of ripping involves converting CD audio to MP3 format. To rip MP3s from an audio CD, follow these simple steps:

**1. Launch iTunes by clicking its icon on the Dock.**

Alternatively, you can locate it in your Applications folder.

**2. Choose iTunes → Preferences.**

**3. In the Preferences window that appears, click the Advanced toolbar button.**

**4. Click the Importing tab.**

**5. Choose MP3 Encoder from the Import Using pop-up menu.**

**6. Choose High Quality (160 Kbps) from the Setting pop-up menu and then click OK.**

This bit rate setting provides the best compromise between quality (better than CD quality, which is 128 Kbps) and file size. (Tracks that you rip will be significantly smaller than “audiophile” bit rates, such as 192 Kbps or higher.)

**7. Load an audio CD into your iMac.**

The CD title shows up in the iTunes Source list, which is on the left side of the iTunes interface. The CD track listing appears on the right side of the interface.



If iTunes asks you whether you want to import the contents of the CD into your Music Library, you can click Yes and skip the rest of the steps. However, if you disabled this prompt, just continue with the remaining two steps.

**8. Clear the check box of any song that you don't want to import from the CD.**



All songs on the CD have a check box next to their title by default. Unmarked songs aren't imported.

Notice that the Browse button changes to Import CD.

**9. After you select the songs that you want added to the Library, click the Import CD button.**

## *Tweaking the Audio for Your Ears*

Besides the standard volume controls that I mention earlier in this chapter, iTunes offers a full equalizer. An *equalizer* permits you to alter the volume of various frequencies in your music, allowing you to boost low sounds, lower high sounds, or anything in between. Now you can customize the way that your music sounds and adjust it to your liking.



To open the Equalizer (as shown in Figure 11-4), do one of the following.

- Choose **Window**⇨**Equalizer**.
- Press **⌘+Option+2**.
- Choose **View**⇨**Show Equalizer**.

The Equalizer window has an impressive array of 11 sliders. Use the leftmost slider (Preamp) to set the overall level of the Equalizer. The remaining sliders represent various frequencies that the human ear can perceive. Setting a slider to a position in the middle of its travel causes that frequency to play back with no change. Move the slider above the midpoint to boost that frequency; conversely, move the slider below the midpoint to reduce the volume of that frequency.

Continue adjusting the sliders until your music sounds how you like it. When you close the Equalizer window, iTunes remembers your settings until you change them again. If you prefer to leave frequencies to the experts, the iTunes Equalizer has several predefined settings to match most musical styles. Click the pop-up menu at the top of the Equalizer window to select a genre.

After you adjust the sound to your satisfaction, close the Equalizer window to return to the iTunes interface and relax with those funky custom notes from James Brown.



**Figure 11-4:**  
Use the  
Equalizer  
sliders to  
tweak the  
sound of  
your music.

## A New Kind of Radio Station

Besides playing back your favorite audio files, iTunes can also tune in Internet radio stations from around the globe. You can listen to any of a large number of preset stations, seek out lesser-known stations not recognized by iTunes, or even add your favorite stations to your Playlists. This section shows you how to do it all.

### *iTunes Radio*

Although it's not a radio tuner in the strictest sense, iTunes Radio can locate virtual radio stations all over the world that send audio over the Internet — a process usually dubbed *streaming* amongst the “In” Internet crowd. iTunes can track down hundreds of Internet radio stations in a variety of styles with only a few mouse clicks.

To begin listening to Internet radio with iTunes, click the Radio icon located beneath the Library icon in the Source list. The result is a list of more than 20 types of radio stations, organized by genre.

When you expand a Radio category by clicking its triangle, iTunes queries a tuning server and locates the name and address of dozens of radio stations for that category. Whether you like Elvis (or those passing fads, such as new wave, classical, or alternative), something's here for everyone. The Radio also offers news, sports, and talk radio.

### **What's with the numbers next to the station names?**

When choosing an Internet radio station, keep your Internet connection speed in mind. If you're using a broadband DSL or cable connection — or if you're listening at work over your company's high-speed network — you can listen to stations broadcasting at 128 Kbps (or even higher). The higher the bit rate, the better the music sounds.

At 128 Kbps, for example, you're listening to sound that's as good as an audio CD.

However, if you're listening over a dialup modem connection, iTunes can't keep up with audio streaming at higher bit rates, so you're limited to stations broadcasting at 56 Kbps or lower.

After iTunes fetches the names and descriptions of radio stations, double-click one that you want to hear. iTunes immediately jumps into action, loads the station, and begins to play it.

## *Tuning in your own stations*

Although iTunes offers you a large list of popular radio stations on the Web, it's by no means comprehensive. Eventually, you might run across a radio station that you'd like to hear, but it's not listed in iTunes. Luckily, iTunes permits you to listen to other stations, too. To listen to a radio station that iTunes doesn't list, you need the station's Web address.

In iTunes, choose **Advanced** ⇨ **Open Stream** (or press ⌘+U). In the Open Stream dialog that appears (as shown in Figure 11-5), enter the URL of your desired radio station and then click **OK**. Within seconds, iTunes tunes in your station, and the station name is added as an entry in your Library.

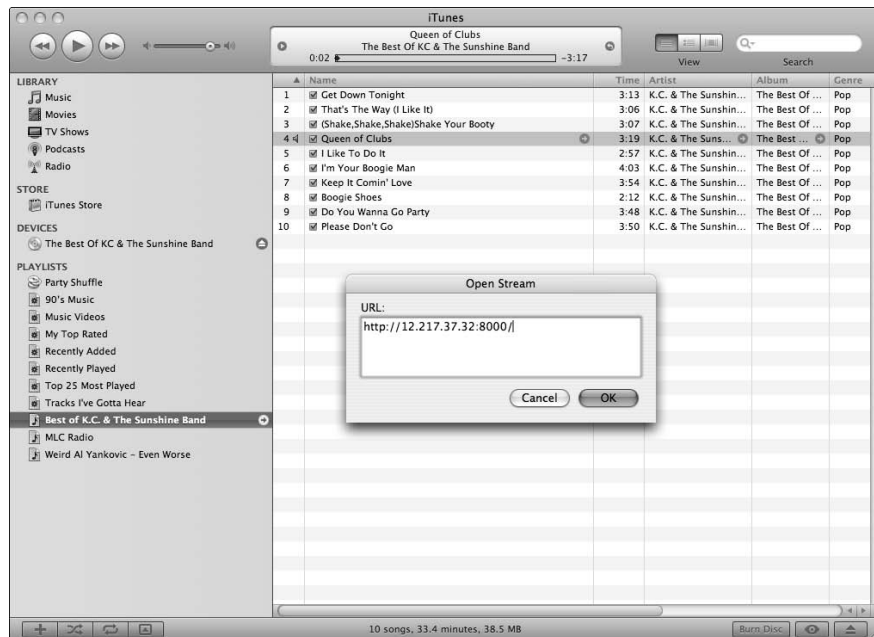

**Figure 11-5:** Tuning into MLC Radio, my Internet radio station.

## I have an itch to hear “Kung Fu Fighting”!

This particular technology author has a preference for a certain hot Net jam spot: *MLC Radio*, the Internet radio station I’ve been running for several years now. I call my station a ‘70s Time Machine because it includes hundreds of classic hits from 1970–1979, inclusive. You hear everything from “Rock and Roll Hoochie Koo” by Rick Derringer to “Moonlight Feels Right” by Starbuck. (Hey, I’m summing up a decade here,

so be prepared for both Rush and the Captain and Tennille, too.) The station broadcasts at 128 Kbps (audio CD quality), so you need a broadband connection to listen. For the radio’s Internet address or help connecting to MLC Radio, visit my Web site at [www.mlcbooks.com](http://www.mlcbooks.com) — then follow the steps in the next section to add MLC Radio to your playlists!

## Radio stations in your Playlists

If you find yourself visiting an online radio station more than once, you’ll be glad to know that iTunes supports radio stations in its Playlists. To add a radio station to a Playlist, do the following:

1. **Open the category that contains the station that you want to add to your Playlist.**
2. **Locate the station that you want to add to your Playlist and drag it from the Radio list to the desired Playlist on the left.**



If you haven’t created any Playlists yet, see the section, “Keeping Slim Whitman and Slim Shady Apart: Organizing with Playlists,” earlier in this chapter to find out how.

Adding a radio station that doesn’t appear in the Radio list is a bit trickier but possible nonetheless. Even though iTunes allows you to load a radio station URL manually by using the Open Stream command in the Advanced menu, it doesn’t give you an easy way to add it to the Playlist. Follow these steps to add a specific radio station to a Playlist:

1. **Add any radio station from the Radio list to your desired Playlist.**

Any station in the list will do because you’ll immediately change both the station’s URL and name to create your new station entry in the Playlist.
2. **Press ⌘+I or choose File→Get Info to bring up the information dialog for that station.**
3. **Click the Summary section and change the URL by clicking the Edit URL button.**

4. Enter the desired URL and then click OK.
5. Click the Info tab, type the new station name, and then click OK.

## *iSending iStuff to iPod*

If you're lucky enough (like me) to own an iPod, you'll be happy to know that iTunes has features for your personal audio and video jukebox as well. *iPods*, Apple's MP3 players, comprise an entire family of portable devices (ranging from \$79 to about \$399) that can hold anywhere from about 300 songs to literally thousands of songs, as well as podcasts, photos, and video. This great gadget has become known worldwide as *the* preferred portable digital media player.

You connect your iPod to any Macintosh with USB 2.0 ports with the included cable. After the iPod is connected, iTunes automatically synchronizes the media on your iPod to match the Playlists in iTunes. The iPod and the iTunes software communicate with each other and figure out what items are in your iTunes Library (as compared with the iPod Library). If they discover songs, podcasts, and video in your iTunes Library that are missing from your iPod, the items automatically transfer to the iPod. Conversely, if the iPod contains stuff that's no longer in iTunes, the iPod automatically removes those files from its drive.



Go back and reread that last sentence above about the iPod **automatically removing** files from its drive. (I'll wait here.) Apple added this feature in an effort to be attentive to copyright concerns. The reasoning is that if you connect your iPod to your friend's computer, you can't transfer songs from the iPod to that computer. Of course, you could always look at it from the marketing perspective as a feature that makes sure your iMac and iPod are always in total sync. Whatever the case, pay close attention and read all warning dialogs when connecting to a Mac other than your own, or you might wipe out your iPod's library.

The best thing I can say about the iPod and iTunes combination is . . . well . . . that there *isn't* anything else to say about them. The auto-sync feature is so easy to use, you forget about it almost immediately. You can also specify what types of media are synced, and even whether specific playlists are transferred.



This chapter — even as long as it is — just can't explain all the ins and outs of the iTunes/iPod relationship! For a complete look at both iTunes and the iPod, I can heartily recommend a fellow Dummies book, *iPod & iTunes For Dummies*, 5th Edition, by Tony Bove and Cheryl Rhodes (Wiley).

## Sharing Your Media across Your Network

Ready to share your music, podcasts, and video — *legally*, mind you — with other folks on your local network? You can offer your digital media to other iTunes users across your home or office. Follow these steps:

1. **Choose iTunes → Preferences to open the Preferences dialog.**
2. **Click Sharing.**
3. **Select the Share My Library on My Local Network check box.**
4. **Specify whether you want to share your entire library or only selected playlists and files.**

Sharing selected playlists is a good idea for those Meatmen and Sex Pistols fans who work at a cubicle farm in a big corporation.

5. **If you want to restrict access to just a few people, select the Require Password check box; then type a password in the text box.**
6. **Click OK.**

Your shared folder appears within the Source list for all iTunes users who enabled the Look for Shared Libraries check box on the same pane of the Preferences dialog. Note that the music you share with others can't be imported or copied, so everything stays legal.



TIP

Want to change that frumpy default name for your shared media library to something more exotic, like “Dan’s Techno Beat Palace?” No problem. Just display the Preferences dialog again, but this time, click the General button, and select the Shared Name text box. Edit your network entertainment persona to your heart’s content.



TIP

Have you picked up an Apple TV for your home entertainment system? This new device can send your digital media wirelessly from iTunes on your iMac or PC straight to your widescreen TV and high-tech audio system. In fact, there’s enough to cover there for a whole book . . . hence, my Mac how-to guide, *Apple TV For Dummies*, (Wiley) by yours truly! If you need help understanding every Apple TV cable and configuration setting, pick up a copy today.

## Burning Music to Shiny Plastic Circles

Besides being a great audio player, iTunes is adept at creating CDs, too. iTunes makes recording songs to a CD as simple as a few mouse clicks — now, putting together the modern version of a compilation (or *mix*) tape is easier than getting a kid to eat ice cream. iTunes lets you burn CDs in one of three formats:

- ✔ **Audio CD:** This is the typical kind of commercial music CD that you buy at a store. Most typical music audio CDs store 700MB of data, which translates into about 80 minutes of music.
- ✔ **Data CD or DVD:** A standard CD-ROM or DVD-ROM is recorded with the audio files. This disc can't be played in any standard audio CD player (even if it supports MP3 CDs, which I discuss next). Therefore, you can listen to these songs only by using your iMac and an audio player, like iTunes or a PC running Windows.
- ✔ **MP3 CD:** Like the ordinary computer CD-ROM that I describe, an MP3 CD holds MP3 files in data format. However, the files are arranged in such a way that they can be recognized by audio CD players that support the MP3 CD format (especially boom boxes, personal CD players, and car stereos). Because MP3 files are so much smaller than the digital audio tracks found on traditional audio CDs, you can fit as many as 160 typical, four-minute songs on one disc. These discs can also be played on your iMac via iTunes.



MP3 CDs aren't the same as the standard audio CDs that you buy at the store, and you can't play them in older audio CD players that don't support the MP3 CD format. Rather, this is the kind of archival disc that you burn at home for your own collection.

First things first: Before you burn, you need to set the recording format. Open the iTunes Preferences dialog by choosing iTunes⇨Preferences. Click the Advanced button, click the Burning tab, and select the desired disc format by enabling the corresponding radio button. Click OK to close the Preferences window when you're finished.

## Sending music elsewhere with AirTunes

If your iMac has built-in AirPort Extreme wireless hardware (all recent models do) and you're using an AirPort Express portable wireless Base Station, you can ship your songs right to your Base Station from within iTunes — and from there to your home stereo or boom box! (I get into some serious discussion of AirPort Express in Chapter 17.)

After your AirPort Express Base Station is plugged in and you connect your home stereo (or a boom box, or a pair of powered stereo speakers) to the stereo mini-jack on the Base

Station, you see a Speakers pop-up list button appear at the bottom of the iTunes window. (If the Speakers button doesn't appear, choose iTunes⇨Preferences to open the Preferences dialog and click the Advanced tab. Make sure that the Look for Remote Speakers Connected with AirTunes check box is enabled.)

Click the Speakers button, and you can choose to broadcast the music you're playing in iTunes across your wireless network. Ain't technology truly *grand*?

The next step in the CD creation process is to build a playlist (or select an existing playlist that you want to record). If necessary, create a new playlist and add to it whatever songs you would like to have on the CD. (See the earlier section, “Keeping Slim Whitman and Slim Shady Apart: Organizing with Playlists,” if you need a refresher.) With the songs in the correct order, select the playlist. Click the Burn Disc button at the bottom of the iTunes window to commence the disc burning process. iTunes lets you know when the recording is complete.

## Feasting on iTunes Visuals

By now, you know that iTunes is a feast for the ears, but did you know that it can provide you with eye candy as well? With just a click or two, you can view mind-bending graphics that stretch, move, and pulse with your music, as shown in Figure 11-6.

To begin viewing iTunes visuals, choose View⇨Turn On Visualizer (or press ⌘+T). Immediately, most of your iTunes interface disappears and begins displaying groovy lava lamp-style animations (like, *sassy*, man). To stop the visuals, choose View⇨Turn Off Visualizer (or press ⌘+T again). The usual sunny aluminum face of iTunes returns.

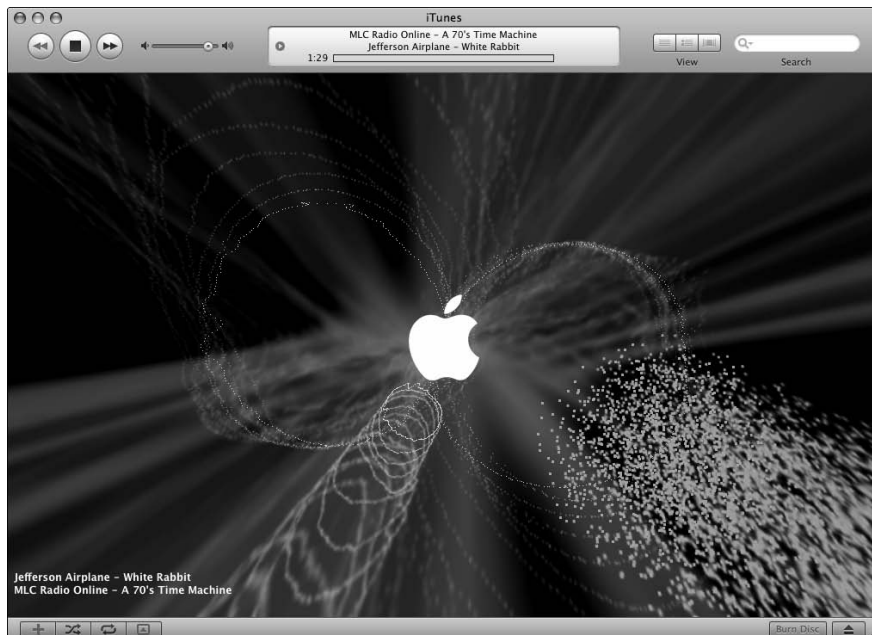

**Figure 11-6:**  
iTunes can display some awesome patterns!



## Backing up within iTunes

iTunes offers a built-in backup feature for your media library. (I told you this was the best media player ever designed!) Choose **File**⇒**Back Up to Disc** to start the process. You can choose to back up your entire iTunes library and all your playlists (which I recommend) or just the content you purchased from the iTunes Store. Personally, if I lost everything in my collection except for what I've bought from the iTunes Store, I'd be just as crushed. Back it all up, and you won't be sorry.

Click **Back Up**, and iTunes will prompt you for blank CDs or DVDs. If you need to restore from your completed backup, just launch iTunes and load the first backup disc into your drive.

How often is often enough when it comes to backing up your content? That depends completely on how often your media library changes. The idea is to back up often enough so that you always have a recent copy of your media files close by.

You can also change the viewing size of the iTunes visuals in the **View** menu. From the **View** menu item, choose **Full Screen** (or press **⌘+F**). To escape from the **Full Screen** mode, click the mouse or press **Esc**.



You can still control iTunes with the keyboard while the visuals are zooming around your screen. See Table 11-1, earlier in this chapter, for a rundown on common keyboard shortcuts.

The iTunes Visualizer has many hidden features. While viewing the Visualizer, press **H** for **Help** to see a list of hidden Visualizer settings. Press **H** again (or **?**), and the list changes to reveal more hidden functions.

But wait, more Easter eggs are to be found! Again, while viewing the Visualizer, press one of following keys:

- ✓ **A**: Changes the Visualizer pattern
- ✓ **Z**: Changes the Visualizer color scheme

Press either of these keys repeatedly to cycle through the various patterns and color schemes lurking deep within the Visualizer. (Personally, I'm a random Visualizer guy . . . with so many patterns and schemes, I just let my iMac do all the work, and spend my time gazing at that beautiful 20-inch widescreen display.) Additionally, you'll find third-party Visualizer plug-ins available for downloading on Apple's Web site and other Mac-related download sites.

## Buying Digital Media the Apple Way

Before we wave goodbye to the happy residents of iTunes iSland, I won't forget to mention the hottest spot on the Internet for buying music and video: the iTunes Store, which you can reach from the cozy confines of iTunes. (That is, as long as you have an Internet connection. If you don't, it's time to turn the page to a different chapter.)

Figure 11-7 illustrates the lobby of this online audio/video store. Click the iTunes Store item in the Source list, and after a few moments, you're presented with the latest offerings. Click a link in the Store list to browse according to media type; or, click the Power Search link to search by song title, artist, album, or composer. The Back/Forward buttons at the top of the iTunes Store window operate much like those in Safari, moving you backward or forward in sequence through pages that you've already seen. Clicking the Home button (which, through no great coincidence, looks like a miniature house) takes you back to the Store's main page.

To display the details on a specific album or track, just click it. If you're interested in buying just certain tracks (for that perfect road warrior mix), you get to listen to 30 seconds of any track — for free, no less, and at full sound quality. To add an item to your iTunes Store shopping cart, click the Add Song/Movie/Album/Video/Podcast button (sheesh!). When you're ready to buy, click the Shopping Cart item in the Source list and then click the Buy Now button. (At the time of this writing, tracks are 99 cents a pop, and an entire album is typically \$9.99 . . . what a bargain! As I mention earlier in the chapter, Apple now offers iTunes Plus tracks, which are higher in quality and aren't hobbled with copy protection. These tracks are also 99 cents each.)

The iTunes Store creates an account for you based on your e-mail address, and it also keeps secure track of your credit card information for future purchases. After you use the iTunes Store once, you never have to log in or retype your credit card information again — iTunes identifies you by your user account, and saves your buying method and information for future purchases.

The tracks and files that you download are saved to a separate playlist called Purchased. After the download is finished, you can play 'em, move 'em to other playlists, burn 'em to CD or DVD, share 'em over your network, or ship 'em to your iPod, just like any other item in your iTunes Library.

Remember all those skeptics who claimed that buying digital audio and video could never work over the Internet because of piracy issues and high costs? Well, bunkie, hats off to Apple: Once again, our favorite technology leader has done something the *right* way!



**Figure 11-7:**  
 Hmm . . .  
 Now  
 where's that  
 Liberace  
 section?



## Chapter 12

# The Masterpiece That Is iPhoto

---

### *In This Chapter*

- ▶ Importing pictures from your hard drive or digital camera
  - ▶ Organizing images with iPhoto
  - ▶ Tweaking the appearance of photographs
  - ▶ Sharing photos with your friends
- 

**V**irtually every Mac owner is likely to have a digital camera or a scanner. Digital video (DV) camcorders have certainly grown more plentiful over the past three or four years, and the iPod is the hottest piece of music hardware on the planet at the time of this writing. The digital camera, however, has reached what those funny (strange) marketing people refer to as *saturation*, and iPhoto was written to address the needs of every person with a digital camera and an iMac!

With iPhoto, you organize, edit, and even publish your photographs. (It sports more features than a handful of Swiss Army knives.) After you shoot your photos with a digital camera, you can import them into iPhoto, edit them, and publish them. You're not limited to photos that you take yourself, either; you can edit, publish, and organize all kinds of digital image files. You can even create a photo album and use the iPhoto interface to order a handsome hard-bound copy shipped to you.

To sum it all up, I'm willing to bet that iPhoto is either the first or the second iLife application that you fall in love with (running neck and neck with iTunes). In this chapter, I show you how you can work digital image magic with true Apple panache!

## *Delving into iPhoto*

In Figure 12-1, you can see most of the major controls offered in iPhoto. Other controls automatically appear when you enter different modes, I cover them in upcoming sections of this chapter.

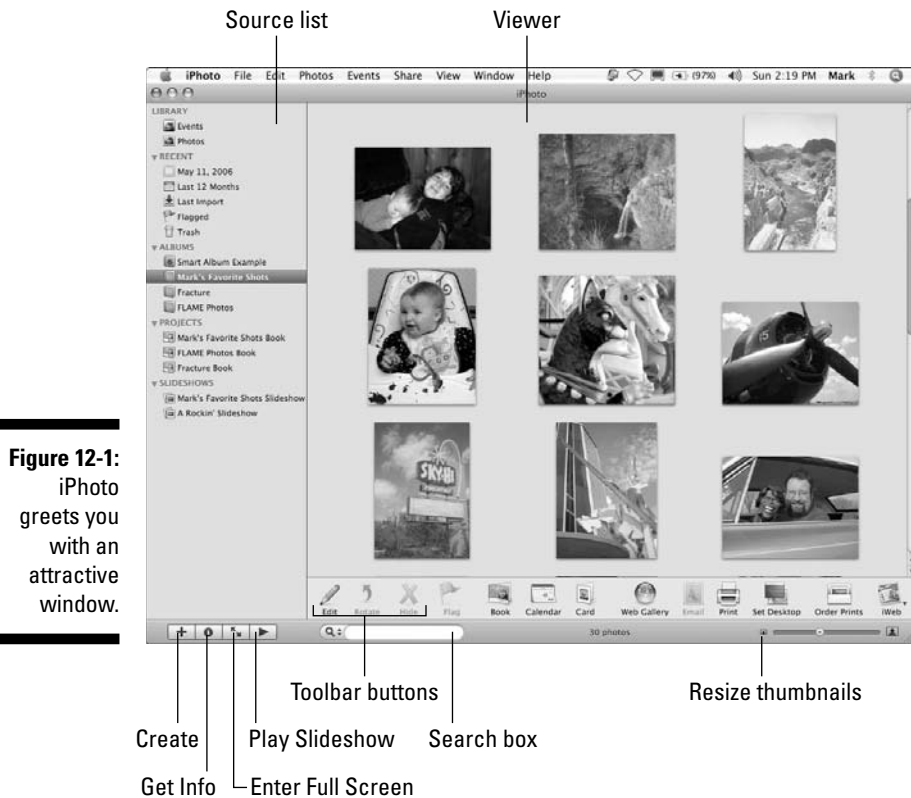

**Figure 12-1:**  
iPhoto  
greet you  
with an  
attractive  
window.

Although I cover these controls as well as the various parts of the window in more detail in the following sections, here's a quick rundown of what you're looking at:

➤ **Source list:** This list of image locations determines which photos iPhoto displays.

- You can choose to display either your entire image library or just the last “roll” of digital images that you downloaded from your camera.
- You can display photos grouped by *events* — for example, a birthday party or family vacation. Each event covers a specific period of time.
- You can create new *albums* of your own that appear in the source list; albums make it much easier to organize your photos.
- You can create books, calendars, cards, and slideshows as well.



- ✔ **Viewer:** This pane displays the images from the selected photo source. You can drag or click to select photos in the Viewer for further tricks, such as assigning keywords and image editing.
- ✔ **Create button:** Click this button to add a new blank album, book, calendar, Web Gallery (for .Mac subscribers), greeting card, postcard, or slideshow to your source list.
- ✔ **Get Info button:** Click this button to display information on selected photos.
- ✔ **Enter Full Screen button:** Click this button to switch to a full-screen display of your photos. In full-screen mode, the images in the selected album appear in a film strip across the top of the screen, and you can click one to view that image using your iMac's entire screen real estate. You can also use the same controls that I discuss later in this chapter for editing and adjusting images. Just move the mouse cursor to the top edge of the full-screen display to show the menu or to the bottom edge to show the toolbar.
- ✔ **Play Slideshow button:** Select an event, album, book, or slideshow in the Source list and then click this button to start a full-screen slideshow using those images.
- ✔ **Search box:** Click the button next to the Search text box to locate photos by specific criteria, or just click in the box and start typing to search by description and title.
- ✔ **Toolbar buttons:** This group of buttons selects an operation that you want to perform on the images you select in the Viewer.
- ✔ **Thumbnail Resize slider:** Drag this slider to the left to reduce the size of the thumbnails in the Viewer. This allows you to see more thumbnails at once, which is a great boon for quick visual searches. Drag the slider to the right to expand the size of the thumbnails, making it easier to differentiate details between similar photos in the Viewer.

## Working with Images in iPhoto

Even a superbly designed image display and editing application (like iPhoto) would look overwhelming if everything were jammed into one window. Thus, Apple developers provide different operation *modes* (such as editing and book creation) that you can use in the one iPhoto window. Each mode allows you to perform different tasks, and you can switch modes at just about any time by clicking the corresponding toolbar button.

In this section, I discuss three of these modes — import, organize, and edit — and what you can do when you're in them. Then I conclude the chapter with sections on publishing and sharing your images.

## Import Images 101

In *import* mode, you're ready to download images directly from your digital camera — that is, as long as your specific camera model is supported in iPhoto. You can find out which cameras are supported by visiting the Apple iPhoto support page at

[www.apple.com/iphoto/compatibility](http://www.apple.com/iphoto/compatibility)

Follow these steps to import images:

### 1. Connect your digital camera to your iMac.

Plug one end of a USB cable into your camera and the other end into your iMac's USB port, and then prepare your camera to download images.

### 2. Launch iPhoto.

Launch iPhoto by clicking its icon on the Dock (or in your Applications folder). Note that iPhoto will automatically launch by itself if your camera or media card reader is recognized. Thumbnails of the images on your camera or card reader appear in the iPhoto window, and the bottom of the window displays the Import text fields and buttons.



The first time that you launch iPhoto, you have the option of setting its auto-launch feature. I recommend this feature, which starts iPhoto automatically whenever you connect a camera to your iMac.

### 3. Click in the Event Name field at the bottom of the window and type an event name for the imported photos, such as Birthday Party or Godzilla Ravages Tokyo.



Keep in mind that the images you're seeing on your screen haven't actually been copied over to your iMac yet — the photos are still on your camera or card reader.

### 4. Click in the Description box and type a description for the event.

### 5. To allow iPhoto to automatically separate images into events based on the date they were taken, select the Autosplit Events after Importing check box to enable it.

If you want to keep all these photos in a single event — even though the event spans multiple days — leave the Autosplit Events After Importing check box disabled.

### 6. Click the Import button to import your photographs from the camera.

The images are added to your Photo Library, where you can organize them into individual albums or Events.



To select specific images to import, hold down the ⌘ key and click each desired photo. Then click Import Selected rather than Import All.



**7. Specify whether the images you're importing should be deleted from the camera afterward.**

If you don't expect to download these images to another computer or another device, you can choose to delete the photos from your camera automatically by clicking Delete Originals. This saves you a step and helps eliminate the guilt that can crop up when you nix your pix. (Sorry, I couldn't resist.)

If you prefer to keep your images on your camera as a safeguard, click the Keep Originals button. Nothing's deleted, and you can delete the photos later by using your camera's built-in delete feature.

"What's that about an Event, Mark?" After you download the contents of your digital camera, those contents count as a virtual *Event* in iPhoto, based on the date they were taken. For example, you can always display the last images you imported by clicking Last Import. If you want to see photos from your son's graduation, they appear as a separate Event. (Both of these organizational tools will appear in the source list). Think about that . . . it's pretty tough to arrange old-fashioned film prints by the moment in time that they document, but iPhoto makes it easy for you to see just which photos are part of the same group! I'll explain more about Events in the next section.

## *Organize mode: Organizing and sorting your images*

In the days of film prints, you could always stuff another shoebox with your latest photos or buy another sticky album to expand your library. Your digital camera, though, stores images as files instead, and many folks don't print their digital photographs. Instead, you can keep your entire collection of digital photographs and scanned images well ordered and easily retrieved in

### **Importing images from your hard drive**

If you have a folder of images that you collected on your hard drive, a CD, a DVD, an external drive, or a USB Flash drive, adding them to your library is easy. Just drag the folder from a Finder window and drop it into the source list in the iPhoto window. iPhoto automatically creates a new album using the folder name, and you can sit back while the images are imported into that new album. iPhoto recognizes images in several formats: JPEG, GIF, RAW, PNG, PICT, and TIFF.

You can drag individual images as well. Select the images in a Finder window and then drag them into the desired album in the source list. To add them to the album displayed in the Viewer, drag the selected photos and drop them in the Viewer instead.

If you'd rather import images via a standard Mac Open dialog box, choose File⇨Import to Library. Simplicity strikes again!

iPhoto organize mode. Then you can display them as a slideshow, print them to your system printer, use them as Desktop backgrounds, or burn them to an archive disc.

The two methods of organizing photos are the *album*, which you might be familiar with from older versions of iPhoto; and *Events*, which is new in iPhoto '08.

### *A new kind of photo album*

The key to organizing images in iPhoto is the album. Each album can represent any division you like, be it a year, a vacation, your daughter, or your daughter's ex-boyfriends. Follow these steps:

#### 1. Create a new album.

Choose File⇒New Album or click the plus (+) button at the bottom of the source list. The New Album sheet appears, as shown in Figure 12-2.

#### 2. Type the name for your new photo album.

If you want to create an empty album (without using any images that might be selected), make sure you deselect the Use Selected Items in New Album check box to disable it.



**Figure 12-2:**  
Add a new  
album in  
iPhoto.

### 3. Click Create.

iPhoto also offers a special type of album — a *Smart Album* — which you can create from the File menu. A Smart Album contains only photos that match certain criteria that you choose, using the keywords and rating that you assign to your images. Other criteria include recent film rolls, text within photo filenames, dates when the images were added to iPhoto, and any comments you might have added. Now here's the really nifty angle: iPhoto automatically builds and maintains Smart Albums for you, adding new photos that match the criteria (and deleting those that you remove from your Photo Library)! Smart Albums carry a gear icon in the source list.

You can display information about the selected item in the information panel under the source list. Just click the Show Information button at the bottom of the iPhoto window, which sports the familiar *i*-in-a-circle logo. You can also type a short note or description in the Description box that appears in the Information pane. For more in-depth information, select the desired item and then press  $\mathbb{B}+I$ .



You can also change information on an image by selecting it in the Viewer and clicking the Show Information button. Click on any of the headings in the pane (Title, Date and Time) to display a text edit box. Then simply click in the box to make your edits: Type in a new name, for example, or alter the photo's date stamp.

You can drag images from the Viewer into any album you choose. For example, you can copy an image to another album by dragging it from the Viewer to the desired album in the Source list.

To remove an album photo that has fallen out of favor, follow these steps:

1. **In the Source list, select the desired album.**
2. **In the Viewer, select the photo (click it) that you want to remove.**
3. **Press Delete.**



When you remove a photo from an album, you don't actually remove the photo from your collection (which is represented by the Photos entry under the Library heading in the source list). That's because an album is just a group of links to the images in your collection. To completely remove the offending photo, click the Photos entry under the Library heading to display your entire collection of images and delete the picture there, too.

To remove an entire album from the source list, just click it in the source list to select it — in the Viewer, you can see the images that it contains — and then press Delete.

To rename an album, click the entry under the Albums heading in the Source list to select it, and then click again to display a text box. Type the new album name and then press Return.



Change your mind? Daughter's ex is back in the picture, so to speak? iPhoto comes complete with a handy-dandy Undo feature. Just press  $\text{⌘}+\text{Z}$ , and it's like your last action never happened. (A great trick for those moments when you realize you just deleted your only image of your first car from your Library.)

### Arranging stuff by Events

As I mention earlier, *Events* are essentially a group of images that you shot at the same time. iPhoto figures that those images belong together (which is usually a pretty safe assumption). Figure 12-3 illustrates the Events that I created in my iPhoto collection.



Like an album, an Event can be renamed just by using a different procedure. Click the Events entry under the Library heading in the Source list to display your Events in the Viewer, and then click the existing Event name in the caption underneath the thumbnail. A text box appears in which you can type a new name. Then press Return to update the Event.

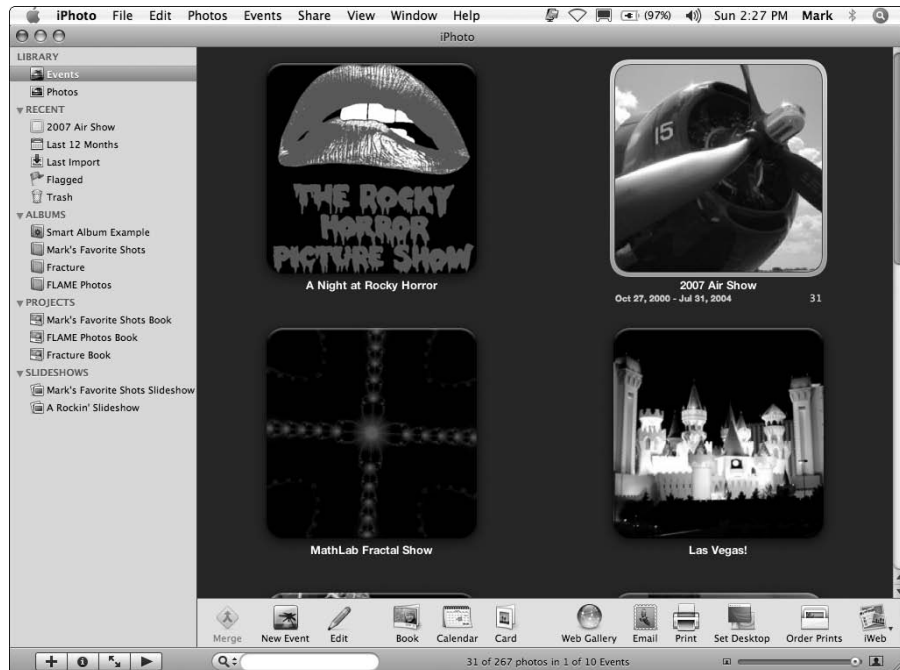

**Figure 12-3:** Events help you organize by what happened, not when it happened.

Try moving your mouse cursor over an Event thumbnail in the Viewer, and you'll see that iPhoto displays the date range when the images were taken as well as the total number of images in the Event. Ah, but things get *really* cool when you move your mouse cursor back and forth over an Event with many images. The thumbnail animates and displays all the images in the Event, without using old-fashioned scroll bars or silly arrows! (Why can't I think of this stuff? This is the future, dear readers.)

To display the contents of an Event in the Viewer, just double-click the Event thumbnail. To return to the Events thumbnails, click the All Events button at the top of the Viewer.



Decided to merge those Prom Event pictures with your daughter's Graduation Event? No problem! You could drag one Event thumbnail on top of another, but that's the easy way. Alternatively, click the Events entry under the Library heading in the Source list to display your Events and then hold down ⌘ while you click the Events that you want to merge. Click the Merge button in the toolbar at the bottom of the window, or choose Events⇨Merge Events. (Forgot about that menu bar, didn't you?) Click Merge in the confirmation dialog that appears.



While you're organizing, you can create a brand-new empty Event by choosing Events⇨Create Event. Feel free to drag photos from albums, other Events, or your Photo library into your new Event.

### ***Organizing with keywords***

"Okay, Mark, iPhoto albums and Events are great ideas, but do you really expect me to look through 20 albums just to locate pictures with specific people or places?" Never fear, good iMac owner. You can also assign descriptive *keywords* to images to help you organize your collection and locate certain pictures fast. iPhoto comes with a number of standard keywords, and you can create your own as well.

To illustrate, suppose you'd like to identify your images according to special events in your family. Birthday photos should have their own keyword, and anniversaries deserve another. By assigning keywords, you can search for Elsie's sixth birthday or your silver wedding anniversary (no matter what Event or album they're in), and all related photos with those keywords appear like magic! (Well, *almost* like magic. You need to choose View⇨Keywords, which toggles the Keyword display on and off in the Viewer.)

iPhoto includes a number of keywords that are already available:

- ✓ **Favorite**
- ✓ **Family**
- ✓ **Kids**

- ✓ Vacation
- ✓ Birthday
- ✓ Checkmark



What's the Checkmark all about, you ask? It's a special case. Adding this keyword displays a tiny check mark icon in the bottom-right corner of the image. The Checkmark keyword comes in handy for temporarily identifying specific images because you can search for just your check-marked photos.

To assign keywords to images (or remove keywords that have already been assigned), select one or more photos in the Viewer. Choose **Window**⇧**Show Keywords** or press **⌘+K** to display the Keywords window, as shown in Figure 12-4.

Click the keyword buttons that you want to attach to the selected images to mark them. Or, click the highlighted keyword buttons that you want to remove from the selected images to disable them.

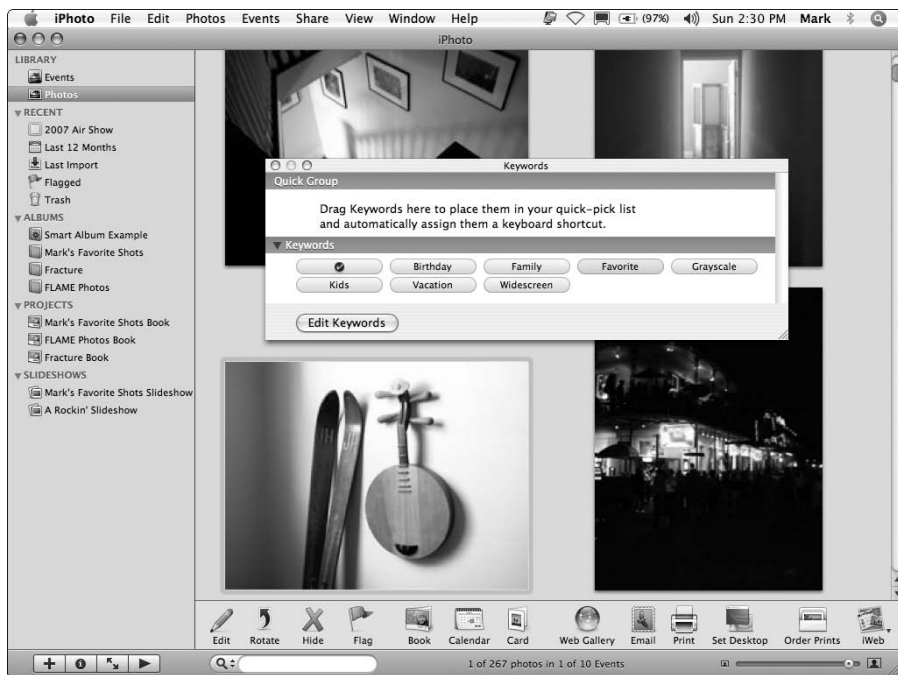

**Figure 12-4:**  
Time to add  
keywords  
to these  
selected  
images.

## You're gonna need your own keywords

I'll bet you take photos of other things besides just kids and vacations — and that's why iPhoto allows you to create your own keywords. Display the iPhoto Keywords window by pressing ⌘+K, click the Edit Keywords button in the toolbar, and then click Add (the button with the plus sign). iPhoto adds a new unnamed keyword to the list as an edit box, ready for you to type its name.

You can rename an existing keyword from this same window, too. Click a keyword to select it

and then click Rename. Remember, however, that renaming a keyword affects *all the images that were tagged with that keyword*. That might be confusing when, for example, photos originally tagged as Family suddenly appear with the keyword Foodstuffs. To remove an existing keyword from the list, click the keyword to select it and then click the Delete button, which bears a minus sign.

### *Digging through your library with keywords*

Behold the power of keywords! To sift through your entire collection of images by keywords, click the magnifying glass button next to the Search box at the bottom of the iPhoto window and then choose Keyword from the pop-up menu. iPhoto displays a pop-up Keywords panel, and you can click one or more keyword buttons to display just the photos that carry those keywords.



The images that remain in the Viewer after a search must have *all* the keywords that you specified. For example, if an image is identified by only three of four keywords you chose, it isn't a match and won't appear in the Viewer.



To search for a photo by title, or by words in its description (which you can add by clicking the Info button at the lower-left corner of the window), just click in the Search box and start typing. You can also click that same magnifying glass by the Search box to search through your images by date and rating as well. (And speaking of ratings. . . .)

### *Playing favorites by assigning ratings*

Be your own critic! iPhoto allows you to assign any photo a rating of anywhere from zero to five stars. I use this system to help me keep track of the images that I feel are the best in my library. Select one (or more) image and then assign a rating by using one of the following methods:

- ✓ Choose Photos⇨My Rating and then choose the desired rating from the pop-up submenu.
- ✓ Use the ⌘+0 (for your average snapshot) through ⌘+5 (front-page material) shortcuts.

### *Sorting your images just so*

The View menu provides an easy way to arrange your images in the Viewer by a number of different criteria. Choose View⇨Sort Photos and then click the desired sort criteria from the pop-up submenu. You can arrange the display by date, keyword, title, or rating. If you select an album in the source list, you can also choose to arrange photos manually, which means that you can drag and drop thumbnails in the Viewer to place them in the precise order you want them.



Naturally, iPhoto allows you to print selected images, but you can also send photos directly to iWeb for use on your .Mac Web site. Click the iWeb button in the toolbar and choose either a Photo page or a Blog page. iPhoto automatically sends the selected images or album to iWeb and launches the application! You can also use the iPhoto Web Gallery feature to get your photos on the Web. (Find more on the Web Gallery at the end of this chapter.)

## *Edit mode: Removing and fixing stuff the right way*

Not every digital image is perfect. Just look at my collection if you need proof. For those shots that need a pixel massage, iPhoto includes a number of editing tools that you can use to correct common problems.

The first step in any editing job is to select the image you want to fix in the Viewer. Then click the Edit button on the iPhoto toolbar to switch to the Edit panel controls, as shown in Figure 12-5. Now you're ready to fix problems, using the tools that I discuss in the rest of this section. (If you're editing a photo that's part of an Event or an album, note the spiffy scrolling photo strip at the top, which allows you to switch to another image to edit just by clicking.)

### *Rotating tipped-over shots*

If an image is in the wrong orientation and needs to be turned to display correctly, click the Rotate button to turn it once in a counterclockwise direction. Hold down the Option key while you click the Rotate button to rotate in a clockwise direction.

### *Crop 'til you drop*

Does that photo have an intruder hovering around the edges of the subject? You can remove some of the border by *cropping* an image, just like folks once did with film prints and a pair of scissors. (We've come a long way.) With iPhoto, you can remove unwanted portions of an image, which is a great way to get Uncle Milton's stray head (complete with toupee) out of an otherwise perfect holiday snapshot.





**Figure 12-5:**  
iPhoto is  
now in edit  
mode.  
Watch out,  
image  
problems!

Follow these steps to crop an image:

1. **Click the Crop button in the Edit panel.**
2. **Select the portion of the image that you want to keep.**

In the Viewer, click and drag the handles on the square to outline the part of the image that you want. Remember, whatever's outside this rectangle disappears after the crop is completed.



When you drag a corner or edge of the outline, a semiopaque grid (familiar to amateur and professional photographers as the nine squares from the Rule of Three) appears to help you visualize what you're claiming. (Check it out in Figure 12-6.)

3. **(Optional) Choose a preset aspect ratio.**

If you want to force your cropped selection to a specific aspect ratio — such as 4 x 3 for an iDVD project — select the Constrain check box and then select the size from the Constrain pop-up menu.

4. **Click the Apply button.**

Oh, and don't forget that you can use iPhoto's Undo feature if you mess up and need to try again — just press **⌘+Z**.



**Figure 12-6:**  
Select the  
stuff that  
you want  
to keep in  
your photo.



iPhoto features multiple Undo levels, so you can press  $\mathbb{⌘}+Z$  several times to travel back through your last several changes.

### ***Enhancing images to add pizzazz***

If a photo looks washed out, click the Enhance button to increase (or decrease) the color saturation and improve the contrast. Enhance is automatic, so you don't have to set anything.

### ***Removing rampant red-eye***

Unfortunately, today's digital cameras can still produce the same "zombies with red eyeballs" as traditional film cameras. *Red-eye* is caused by a camera's flash reflecting off the retinas of a subject's eyes, and it can occur with both humans and pets.

iPhoto can remove that red-eye to turn frightening zombies back into your family and friends. Click the Red-Eye button and then select a demonized eyeball by clicking in the center of it. To complete the process, click the X in the button that appears in the image.

### *Retouching like the stars*

The iPhoto Retouch feature is perfect for removing minor flecks or lines in an image (especially those images from scanned prints). Click Retouch, and the mouse cursor turns into a crosshair. Just drag the cursor across the imperfection. (Actually, you're matching the pixels in the selected area with the pixels surrounding it, which "smooths" out the imperfection.)

### *Switching to black and white, or sepia*

Ever wonder whether a particular photo in your library would look better as a black-and-white (*grayscale*) print? Or perhaps an old-fashioned sepia tone in shades of copper and brown? Just click the Effects button to convert an image from color to shades of gray or shades of brown, respectively. (To return to the original image, just click in the center square of the Effects window.)

### *Adjusting brightness and contrast manually*

Click Adjust to perform manual adjustments on brightness and contrast (the light levels in your image). To adjust the brightness and contrast, make sure that nothing's selected in the image and then drag the Brightness/Contrast sliders until the image looks the way that you want.



While you're editing, you can use the Next button to move to the next image in the current album (and the Previous button to revert to the previous image).

## *Producing Your Own Coffee-Table Masterpiece*

Book mode unleashes what I think is probably the coolest feature of iPhoto: the chance to design and print a high-quality, bound photo book! After you complete an album — all the images have been edited just the way you want, and the album contains all the photos you want to include in your book — iPhoto can send your images as data over the Internet to a company that prints and binds your finished book for you. (No, they don't publish *For Dummies* titles, but then again, I don't get high-resolution color plates in most of my books, either.)

At the time of this writing, you can order many different sizes and bindings, including an 8½ x 11" softcover book with 20 double-sided pages for about \$20 and a hardbound 8½ x 11" keepsake album with 10 double-sided pages for about \$30 (shipping included for both). Extra pages can be added for 70 cents and \$1 per pop, respectively.

iPhoto '08 can also produce and automatically order calendars and greeting cards, using a process similar to the one I describe in this section for producing a book. Who needs that stationery store in the mall anymore?



If you're going to create a photo book, make sure that the images have the highest quality and highest resolution. The higher the resolution, the better the photos look in the finished book. I personally always try to use images with more than 1,000 pixels in both the vertical and horizontal dimensions. Check your camera's manual for instructions on how to choose the maximum quality and resolution settings.

To create a photo book, follow these steps:

- 1. Click the desired album in the source list to select it.**
- 2. Click the Book toolbar button.**
- 3. Select the size of the book and a theme.**

Your choices determine the number of pages and layout scheme, as well as the background graphics for each page.

- 4. Click Choose.**

iPhoto displays a dialog box indicating that you can lay out your photos manually or allow iPhoto to do everything automatically (by clicking the Autoflow button on the toolbar). Automatic mode is fine, but I'm a thorough guy, so I'll lay out this book manually. You see the controls shown in Figure 12-7.

In Book mode, the Viewer changes in subtle ways. It displays the current page at the bottom of the display and adds a scrolling row of thumbnail images above it. This row of images represents the remaining images from the selected album that you can add to your book. You can drag any image thumbnail into one of the photo placeholders to add it to the page. You can also click the Page button at the left of the thumbnail strip — it looks like a page with a turned-down corner — to display thumbnails of each page in your book. (To return to the album image strip, click the Photos button under the Page button.)

- 5. Rearrange the page order to suit you by dragging the thumbnail of any page from one location to another in the strip.**
- 6. In the Book toolbar below the page view, you can adjust a variety of settings for the final book, including the book's theme, background, page numbers, and text fonts.**

At this point, you can also add captions and short descriptions (about a dozen words) to the pages of your photo album. Click any one of the text boxes in the page display and begin typing to add text to that page.

- 7. When you're ready to publish your book, click the Buy Book button.**

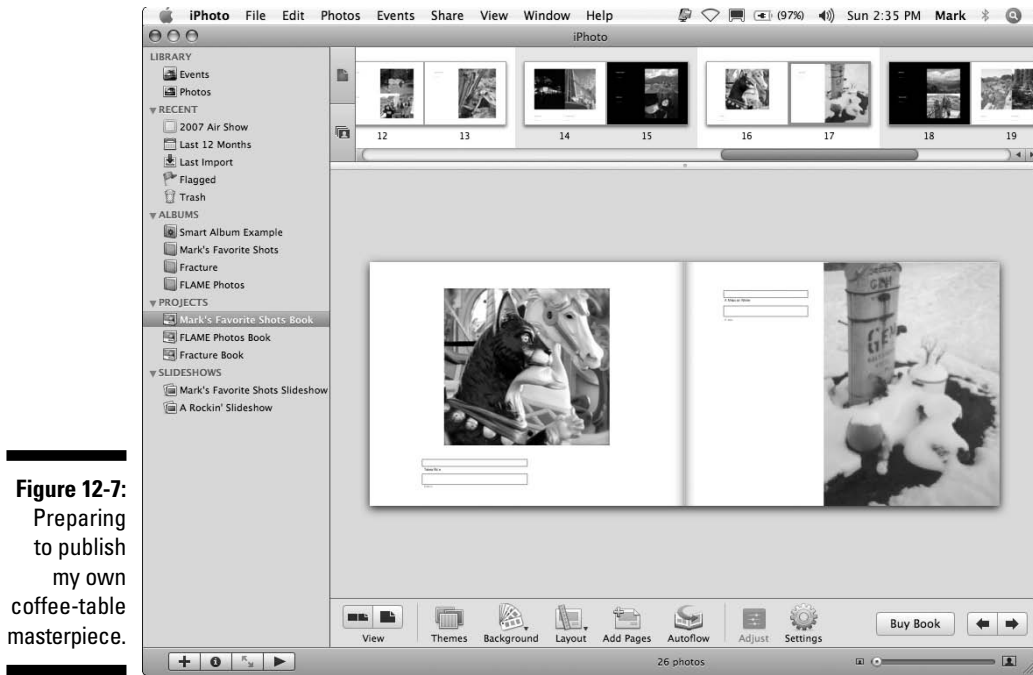

**Figure 12-7:**  
Preparing  
to publish  
my own  
coffee-table  
masterpiece.

**8. In a series of dialog boxes that appear, iPhoto guides you through the final steps to order a bound book.**

Note that you're asked for credit card information



I wouldn't attempt to order a book through a dialup modem connection. The images are likely far too large to be sent successfully. If possible, use a broadband or network connection to the Internet while you're ordering. If your only connection to the Internet is through a dialup modem, I recommend saving your book in PDF format and having it printed at a copy shop or printing service instead. (Choose File→Print and then click the Save as PDF button.)

## Introducing Web Gallery!

iPhoto '08 introduces a new feature — *Web Gallery* — that does for images what podcasting does for audio: You can share your photos with friends, family, business clients, and anyone else with an Internet connection! (Your adoring public doesn't even require a Mac; they can use That Other Kind of Computer.) iPhoto automatically uploads the selected images and leads you through the process of creating a new Web page to proudly display your

## I really need a slideshow

You can use iPhoto to create slideshows! Click the album you want to display. Click the Add button to display the Add sheet. Choose Slideshow from the sheet toolbar, and then click Create; iPhoto adds a Slideshow item in the Source list. The same scrolling thumbnail strip appears at the top of the Viewer — this time, displaying the images in the album. Click and drag the thumbnails so that they appear in the desired order.

The toolbar at the bottom of the iPhoto window now displays slideshow-specific buttons. (Go figure.) To choose background music for your slideshow, click the Music button in the Slideshow toolbar to display the tracks and playlists from your iTunes library. Choose a single track or a playlist to select it, and then click OK to accept your music.

By default, iPhoto uses a familiar dissolve effect during the transitions between photos — however, click the Transition pop-up menu, and you can choose from a number of alternate transitions. Select Random from the menu to use a different transition between every photo, or turn off transitions altogether by choosing None.

To configure your slideshow, click the Settings button in the Slideshow toolbar. In the sheet that

appears, you can specify the amount of time that each slide remains on the screen, as well as an optional title and rating displays. I can recommend the Automatic Ken Burns effect — yep, the same one as in iMovie — which lends an animated movement to each image. Savvy iMac owners (like yourself) appreciate the Slideshow Format pop-up menu, which allows you to choose a 16:9 widescreen display for your slideshow.

Click the Adjust button to modify the settings for a specific slide (useful for keeping a slide onscreen for a longer period of time or for setting a different transition than the default transition you choose from the Slideshow toolbar).

To display a preview of a single slide and its transitions, click the desired slide and then click Preview. This is a handy way of determining whether your delay and transition settings are really what you want for a particular slide. When you're ready to play your slideshow, click the Play button, and iPhoto switches to full-screen mode. You can share your completed slideshow by clicking Share in the iPhoto menu, from which you can send the slideshow to iDVD (for later burning onto a DVD), export it as a QuickTime movie, or send it through e-mail.

photos. However, you *must* be a .Mac subscriber to use the Web Gallery feature. If you haven't heard the news on the Apple .Mac service yet, see Chapter 9 for the details.

To create a Web Gallery, you designate one or more albums to share by selecting them in the source list and then clicking the Add button at the bottom left of the iPhoto window. (Hold down  $\mathbb{W}$  while you click to select multiple albums.) Click the Web Gallery toolbar button in the sheet that appears to display the Web Gallery settings, as shown in Figure 12-8.

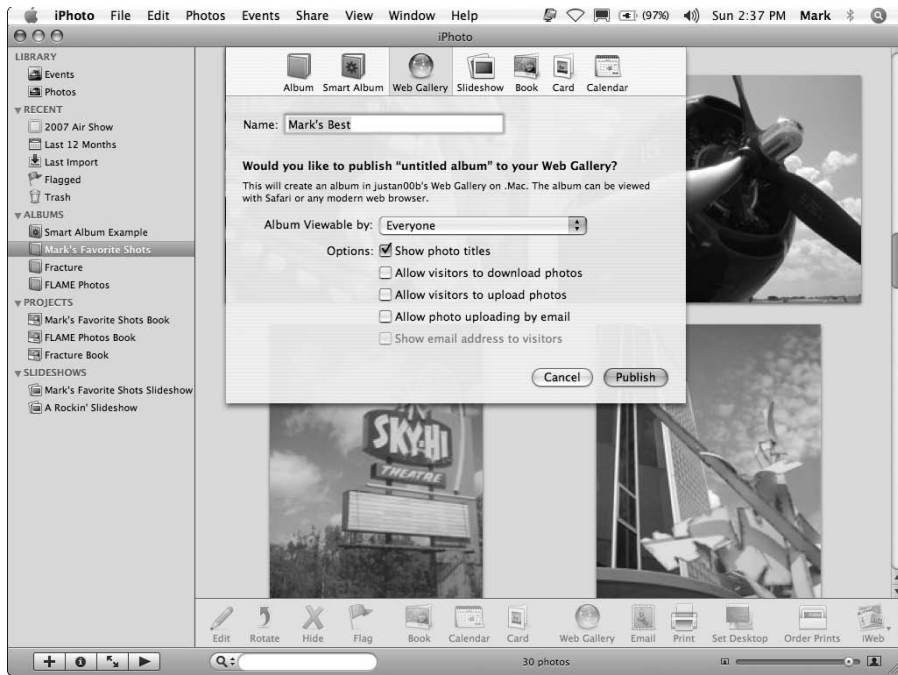

**Figure 12-8:**  
Treat others  
to your  
soccer  
photos,  
automatic-  
ally!

Type a name for your new Web Gallery. You can elect to show the title of each photo, allow your visitors to download your images or upload their own, and even allow photos to be uploaded by other Mac owners using Apple Mail!



By default, any visitor to your .Mac Web site can see your gallery. But what if you prefer a little security for those images? In that case, click the Album Viewable By pop-up menu, where you can limit your viewing audience. (You can even require that your visitors enter a login name and password before they can receive your photos.)

Click Publish, and you see that iPhoto indicates your images are being uploaded with a cool twirling progress icon to the right of the album in the source list. When the process is complete, iPhoto indicates that the album is being “photocasted” with a special networky-looking icon to the right of the album, and even a new Web Gallery heading in the Source list. You’re on the air!

Now for the other side of the coin: By selecting your Web Gallery in the Source list and clicking Tell a Friend in the iPhoto toolbar, iPhoto automatically prepares an e-mail message in Apple Mail that announces your new Web Gallery! Just add the recipient names and click Send. This spiffy message includes instructions for

- ✔ **Folks using iPhoto '08 on a Mac:** As you can imagine, this is the easiest Receive option to configure. After these folks are subscribed, they get an automatically updated album of the same name that appears in their source list, and they can use those images in their own iPhoto projects. From within iPhoto, your visitors can subscribe to your Web Gallery by choosing File⇨Subscribe to Photo Feed and entering the subscription URL from the e-mail message.
- ✔ **Folks using Windows or an older version of iPhoto:** These subscribers can use any Web browser with really simple syndication (RSS) support (like the Safari browser that comes with Leopard) or any RSS reader. (In effect, your Web Gallery becomes an RSS feed for those without iPhoto '08.)



By default, any changes you make to the contents of the albums in your Web Gallery are updated automatically on your .Mac account, and in turn, are updated automatically to everyone who receives your images. You can turn this feature off, however, if you have a large number of images and you update often (which can result in your sister's computer downloading a lot of data). To display the Check for New Photos setting for Web Gallery, choose iPhoto⇨Preferences and then click the Web Gallery button on the Preferences window toolbar. (You can also change the title for your Gallery and monitor your iDisk usage from this pane.)

## *Mailing Photos to Aunt Mildred*

iPhoto can help you send your images through e-mail by automating the process. The application can prepare your image and embed it automatically in a new message.

To send an image through e-mail, select it and then click the Email button in the toolbar. The dialog shown in Figure 12-9 appears, allowing you to choose the size of the images and whether you want to include their titles and comments as well.



Keep in mind that most Internet service provider (ISP) e-mail servers don't accept an e-mail message that's larger than 1MB or 2MB, so watch that Size display. If you're trying to send a number of images and the size goes over 2MB, you might have to click the Size pop-up menu and choose a smaller size (reducing the image resolution) to get them all embedded in a single message.

When you're satisfied with the total file size and you're ready to create your message, click the Compose button. iPhoto automatically launches Apple Mail (or whatever e-mail application you specify) and creates a new message containing the images, ready for you to click Send!





**Figure 12-9:** Preparing to send an image through Apple Mail.



## Chapter 13

# Making Film History with iMovie

---

### *In This Chapter*

- ▶ Taking stock of the iMovie window
  - ▶ Importing and adding media content
  - ▶ Using transitions in your movie
  - ▶ Putting text titles to work
  - ▶ Sharing your movie with others
- 

**R**emember those home movies that you used to make in high school? They were entertaining and fun to create, and your friends were impressed. In fact, some kids are so downright inspired that you're not surprised when you discover at your high school reunion that they turn out to be graphic artists, or they're involved in video or TV production.

iMovie, part of the iLife '08 suite, makes moviemaking as easy as those home-made movies. Apple simplified all the technical stuff, such as importing video and adding audio, leaving you free to concentrate on your creative ideas. In fact, you won't find techy terms such as *codecs* or *keyframes* in this chapter at all. I guarantee that you'll understand what's going on at all times. (How often do you get a promise like that with video editing software?)

With iMovie, your digital video (DV) camcorder, and the other parts of the iLife suite, you can soon produce and share professional-looking movies, with some of the same creative transitions and titles used by Those Hollywood Types every single day.

If you turn out to be a world-famous Hollywood Type Director in a decade or so, don't forget the little people along the way!

## *Shaking Hands with the iMovie Window*

If you've ever tried a professional-level, video editing application, you probably felt like you were suddenly dropped in the cockpit of a jumbo jet. In iMovie, though, all the controls you need are easy to use and logically placed.



Video editing takes up quite a bit of desktop space. In fact, you can't run iMovie at resolutions less than 1024 x 768, nor would you want to.

To launch iMovie, click the iMovie icon on the Dock. (It looks like a star from Hollywood's Walk of Fame, which I find very fitting.) You can also click the Application folder in any Finder window Sidebar and then double-click the iMovie icon.

To follow the examples that I show you here, follow these strenuous steps and create a new movie project:

1. **Click the Create a New Project button (the one with the plus sign) located under the Project Library list.**

iMovie displays the window that you see in Figure 13-1.

2. **Type a name for your project.**

3. **Select the aspect ratio (or screen dimensions) for your movie.**

You can select a widescreen display (16:9), a standard display (4:3), or a display especially suited for an iPhone (3:2). If compatibility with the familiar SDTV format is important, I always recommend that you choose the standard (4:3) ratio.

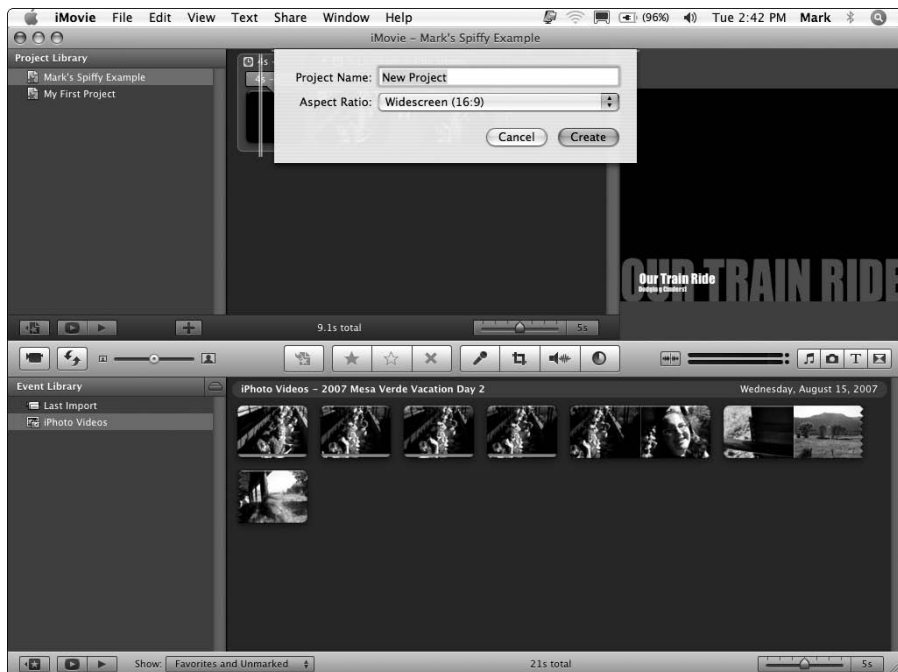

**Figure 13-1:**  
Creating a  
new movie  
project  
within  
iMovie.

#### 4. Click Create.

You're on your way! Check out Figure 13-2: This is the whole enchilada, in one window.

Here are the controls and displays that you'll use most often:

- ✓ **Monitor:** Think of this as being just like your TV or computer monitor. Your video clips, still images, and finished movie play here.
- ✓ **Browser toolbar:** This row of buttons allows you to switch between your media clips (video clips, photos, and audio) and the various tools that you use to make your film. The selected items fill the browser pane below the toolbar. For example, Figure 13-2 illustrates the Transitions browser pane, which appears when you click the Transitions Browser button (go figure).
- ✓ **Event pane:** All the video clips that you use to create your movie are stored in the Event pane.

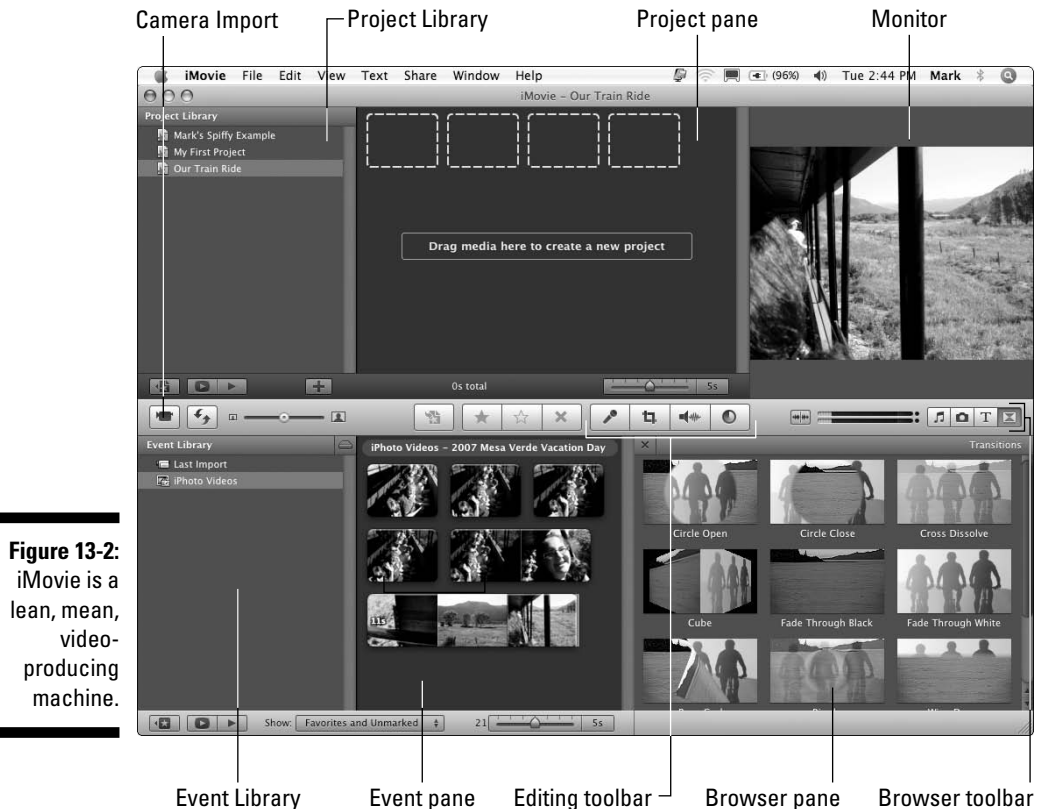

- ✔ **Project pane:** In this pane, iMovie displays the elements that you add to your movie project.
- ✔ **Playhead:** The red vertical line that you see in the Event and the Project panes is the *playhead*, which indicates the current editing point while you're creating your movie. When you're playing your movie, the playhead moves to follow your progress through the movie.
- ✔ **Editing toolbar:** This strip of buttons allows you to control editing functions such as cropping, audio and video adjustments, voiceovers, and selecting items.
- ✔ **Camera Import button:** Click this switch to import DV clips from your DV camcorder or iSight camera.

Those are the major highlights of the iMovie window. A director's chair and megaphone are optional, of course, but they do add to the mood.

## *A Bird's-Eye View of Moviemaking*

I don't want to box in your creative skills here — after all, you can attack the moviemaking process from a number of angles. (Pun unfortunately intended.) However, I've found that my movies turn out the best when I follow a linear process, so before I dive into specifics, allow me to provide you with an overview of moviemaking with iMovie.

Here's my take on the process, reduced to seven steps:

1. Import your video clips into iMovie, directly from your DV camcorder, your iSight camera, or your hard drive.
2. Drag your new selection of clips from the Event pane to the Project pane and arrange them in the desired order.
3. Import or record audio clips (from iTunes; GarageBand; or external sources, such as audio CDs or audio files you recorded) and add them to your movie.
4. Import your photos (directly from iPhoto or from your hard drive) and place them where needed in your movie.
5. Add professional niceties — such as audio, transitions, effects, and text — to the project.
6. Preview your film and edit it further if necessary.
7. Share your finished film with others through the Web, e-mail, or a DVD that you create and burn with iDVD.

That's the first step-by-step procedure in this chapter. I doubt that you'll even need to refer to it, however, because you'll soon see just how easy it is to use iMovie.

## Importing the Building Blocks

Sure, you need video clips to create a movie of your own, but don't panic if you have but a short supply. You can certainly turn to the other iLife applications for additional raw material. (See, I told you that integration thing would come in handy.)

Along with video clips you import from your DV camcorder, iSight camera, and hard drive, you can also call on iPhoto for still images (think credits) and iTunes for background audio and effects. In this section, I show you how.

### *Pulling in video clips*

Your iMac is equipped already with the two extras that come in handy for video editing: namely, a large hard drive and a FireWire port. Because virtually all DV camcorders today use a FireWire connection to transfer clips, you're all set. (And even if your snazzy new DV camcorder uses a USB 2.0 connection, you're still in the zone!) Oh, and of course your iMac has an iSight camera on board, so you're a self-contained movie studio!

Here's the drill if your clips are on your DV camcorder:



- 1. Plug the proper cable into your Mac.**
- 2. Set the DV camcorder to VTR (or VCR) mode.**

Some camcorders call this Play mode.
- 3. Click the Camera Import button (labeled in Figure 13-2).**

iMovie opens a new window.
- 4. Click the Camera pop-up menu and select your DV camcorder or iSight camera.**

Playback controls appear under the Camera Import window, mirroring the controls on your DV camcorder. This allows you to control the unit from iMovie. *Keen!* You also get Import All and Import Checked buttons as a bonus.



**5. To import selected clips, set the Automatic/Manual switch to Manual.**

To import all clips, set the Automatic/Manual switch to Automatic, and click Import All.

**6. Select the check boxes next to the clips that you don't want to import to disable them.**

**7. Click the Import Checked button.**

**8. Click the Save To pop-up menu and choose the drive that should store your clips.**

You can choose to add the new clips to an existing Event, or create a new Event. Heck, if the Event spanned more than one day, you can create a new Event for each day. (How do they think up these things?)

**9. Click OK and admire your handiwork.**

iMovie begins transferring the footage to your Mac and automatically adds the imported clips to your Event Library. Note that the footage remains pristine on your camera, and is **not** deleted.



If your clips are already on your hard drive, rest assured that iMovie can import them, including those in high-definition video (HDV) format. iMovie also recognizes a number of other video formats, as shown in Table 13-1.

**Table 13-1 Video Formats Supported by iMovie**

<i>File Type</i>	<i>Description</i>
DV	Standard digital video
MOV	QuickTime movies
HDV	High-definition (popularly called <i>widescreen</i> ) digital video
MPEG-4	A popular format for streaming Internet and wireless digital video

To import a movie file, follow this bouncing ball:

**1. Choose File⇨Import Movies.**

**2. If you're importing 1080i video clips, choose the quality setting.**

The Large setting (960 x 540 resolution) will save you a significant amount of hard drive space. (If you're not importing 1080i video, use the default Large setting and click OK.)



If you are indeed importing 1080i (HD, or high definition) video and you want to take advantage of the whopping 1920 x 1080 resolution it provides, choose the Full setting. (And prepare to lose a nice-sized patch of free space on your hard drive!)

- 3. Click the Save To pop-up menu and choose the drive that should store your clips.**
- 4. Specify whether you want to add the imported video to an existing Event, or whether you'd like to create a new Event.**

If you want to add the video to an existing Event, click the pop-up menu and choose an Event.

- 5. Specify whether you want to copy the video (leaving the original movie intact), or whether the original movie should be deleted after a successful import.**
- 6. Click Import.**

Alternatively, you can also drag a video clip from a Finder window and drop it in the Project pane.

## *Making use of still images*

Still images come in handy as impressive-looking titles or as ending credits to your movie. (Make sure you list a gaffer and a best boy to be truly professional.) However, you can also use still images to introduce scenes or to separate clips according to your whim. For example, I use stills when delineating the days of a vacation within a movie or different Christmas celebrations over time.

Here are two methods of adding stills to your movie:

- ✓ **Adding images from iPhoto:** Click the Photo Browser button on the Browser toolbar (or press ⌘+2), and you'll experience the thrill that is your iPhoto library, right from iMovie (as shown in Figure 13-3). You can elect to display your entire iPhoto library or more selective picks, such as specific albums or Events. When you find the image you want to add, just drag it to the right spot in the Project pane.
- ✓ **Importing images from your hard drive:** If you're a member of the International Drag-and-Drop society, you can drag TIFF, JPEG, GIF, PICT, PNG, and PSD images directly from a Finder window and drop them into the Project pane as well.



**Figure 13-3:**  
Pulling still  
images from  
iPhoto is  
child's play.

## *Importing and adding audio from all sorts of places*

You can pull in everything from Wagner to Weezer as both background music and sound effects for your movie. In this section, I focus on how to get those notes into iMovie and then how to add them to your movie by dragging them to the Project pane.

You can add audio from a number of sources:

- ✓ **Adding songs from iTunes:** Click the Show Music and Sound Effects button on the Browser toolbar (or press ⌘+1) to display the contents of your iTunes library. Click the desired playlist in the scrolling list, like the Dinah Washington playlist I selected in Figure 13-4. (If you've exported any original music you composed in GarageBand to your iTunes Library, you can use those songs in your own movie!) You can add a track to your movie by dragging the song entry from the Music and Sound Effects browser to the desired spot in the Project pane.

**Figure 13-4:**  
Calling on  
my iTunes  
Library to  
add Dinah  
Washington  
to my  
iMovie.



- ✓ **Adding sound effects:** Yep, if you need the sound of a horse galloping for your Rocky Mountain vacation clips, click the Show Music and Sound Effects button and then click either the iMovie '08 Sound Effects or iLife Sound Effects folders at the top of the scrolling list. To add a sound effect, drag it to the perfect spot in the Project pane.



If you have several gigabytes of music in your iTunes Library, it might be more of a challenge to locate “Me and Bobby McGee” by Janis Joplin, especially if she’s included in a compilation. Let your Mac do the digging for you! Click in the Search box below the track list and begin typing a song name. iMovie narrows down the song titles displayed to those that match the characters you type. To reset the search box and display all your songs in the library or selected playlist, click the X icon that appears to the right of the box.

- ✓ **Ripping songs from an audio CD:** Load an audio CD and then choose Audio CD from the scrolling list. iMovie displays the tracks from the CD, and you can add them at the current playhead position the same way that you would an iTunes songs.
- ✓ **Recording directly from a microphone:** Yep, if you’re thinking voiceover narration, you’ve hit the nail on the head. Check out the sidebar, “Narration the easy way,” for the scoop.

## Narration the easy way

Ready to create that award-winning nature documentary? You can add voiceover narration to your iMovie project that would make Jacques Cousteau proud. In fact, you can record your voice while you watch your movie playing, allowing perfect synchronization with the action! To add narration, follow these steps:

- 1. Click the Voiceover button on the Editing toolbar — it sports a microphone icon — to open the Voiceover window.**
- 2. Click the Record From pop-up menu and select the input device.**

Your iMac sports a decent internal microphone, but you can always add a USB microphone to your system.

- 3. Drag the input volume slider to a comfortable level.**

You can monitor the volume level of your voice with the left and right input meters. Try to keep the meters at 50% or so for the proper volume level.

- 4. To block out ambient noise levels around you, drag the Noise Reduction slider to the right if necessary.**

If you'd like iMovie to enhance your voice electronically for a more professional sound, select the Voice Enhancement check box. If you need to hear the audio from your movie project while you speak, select the Play Project Audio While Recording check box. Note, however, that you need to listen to the audio while using a set of headphones (plugged into your iMac's headphone jack) to avoid feedback problems.

- 5. Click in the desired spot within the Project pane where the narration should begin.**
- 6. Begin speaking when prompted by iMovie.**
- 7. Watch the video while you narrate so that you can coordinate your narration track with the action.**
- 8. Click anywhere in the iMovie window to stop recording.**
- 9. Click the Close button in the Voiceover window.**

iMovie adds a purple icon to the Project pane underneath the video with the voiceover.



You can fine-tune both the audio within a video clip or the audio clips that you add to your project. With the desired clip selected, click the Adjust Audio button on the Editing toolbar. The Audio Adjustments window that appears includes an array of audio controls that allow you to change the volume of the selected clip, or give that audio priority over other audio playing simultaneously (such as a sound effect that needs to be clearly heard over background music and the video clip).

If your clips dramatically vary in volume, follow along:

- 1. Click the Normalize Clip Volume button.**
- 2. Select each clip that you want to set to the same volume.**
- 3. Click Normalize Clip Volume again for each clip.**



#### 4. When you're done tweaking, click Done.

You can always return the clip to its original volume. Just open this window again and click Revert to Original.

## Building the Cinematic Basics

Time to dive in and add the building blocks to create your movie. Along with video clips, audio tracks, and still images, you can add Hollywood-quality transitions, optical effects, and animated text titles. In this section, I demonstrate how to elevate your collection of video clips into a real-life furshlug-giner movie.

### Adding clips to your movie

You can add clips to your movie by using the Project pane and the Event pane. The Dynamic Duo work like this:

- ✓ **Project pane:** This pane displays the media you added to your project, allowing you to rearrange the clips, titles, transitions, and still images in your movie.
- ✓ **Event pane:** This pane displays your video clips arranged by *Event* (the date they were shot), acting as the source repository for all your clips. Movies pulled into iMovie, imported to iPhoto, or added manually from the Finder appear here.

To add a clip to your movie

#### 1. Move your mouse pointer across clips in the Event pane to watch a preview of the video.

The clip's thumbnail actually displays the video in real time as you move your pointer across it. *Nice.*

#### 2. When you decide what to add to your project, you can add the entire clip or a selection:

- *To select an entire clip:* Right-click the clip thumbnail and choose Select Entire Clip from the menu that appears.
- *To select a portion of a clip:* Drag your mouse cursor across the thumbnail. A yellow frame appears around your selection.

To change the length of the selected video, drag the handles that appear on either side. If you make a mistake while selecting video, just click any empty space within the Event pane to remove the selection frame, and then try again.

**3. Drag the selection from the Event pane to the spot where it belongs in the Project pane.**

Alternatively, you can press the E key, or click the Add to Project button (the first button on the Editing toolbar).

Do this several times, and you have a movie, just like the editors of old used to do with actual film clips. This is a good point to mention a moviemaking Mark's Maxim:



Preview your work — and do it often.™

iMovie offers two Play Full Screen buttons: one under the Event Library, and one under the Project Library. Select the project or Event you want to play, and then click the corresponding button. You can also choose View→Play Full Screen to watch the selection. Press the space bar to pause, and press the Esc to return to iMovie. You can also move your mouse to display a filmstrip that you can click to skip forward or backward in the project or Event.

To play a selection from the Playhead position, press ⌘+G. (If you've ever watched directors at work on today's movie sets, they're constantly watching a monitor to see what things will look like for the audience. You have the same option in iMovie!)



While you're moving through clips in the Event pane, you might decide that a certain clip has a favorite scene . . . or that another clip has material you don't want, like Uncle Ed's shadow puppets. (Shudder.) iMovie '08 introduces *Favorite* and *Rejected* scenes, allowing you to view and use your best camera work (and ignore the worst stuff). To mark video, select a range of frames or an entire clip; then click the Mark as Favorite button on the Editing toolbar. Click the Reject button to hide the selected video or frames from view. (You can always unmark a Favorite scene by using the Unmark button on the Editing toolbar.)

## *Removing clips from your movie*

Don't like a clip? Begone! To banish a clip from your movie project

- 1. Click the offending clip in the Project pane to select it.**
- 2. Press Delete.**

Alternatively, you can right-click the clip (or a selection you made by dragging) and choose either Delete Entire Clip or Delete Selection from the menu that appears.

The clip disappears — only from the project, *not* from your hard drive — and iMovie automatically rearranges the remaining clips and still images in your movie.

If you remove the wrong clip, don't panic. Instead, use the iMovie Undo feature (press  $\text{⌘}+\text{Z}$ ) to restore it.

## *Reordering clips in your movie*

If Day One of your vacation appears after Day Two in your movie, you can easily reorder your clips and stills by dragging them to the proper space in the Project pane. When you release the mouse, iMovie automatically moves the rest of your movie aside with a minimum of fuss and bother.

## *Editing clips in iMovie*

If a clip has extra seconds of footage at the beginning or end, you don't want that superfluous stuff in your masterpiece. Our favorite video editor gives you the following functions:

- ✓ **Crop:** Removes unwanted material from a video clip or still image, allowing you to change the aspect ratio of the media
- ✓ **Rotate:** Rotates a clip or image on its center axis
- ✓ **Trim:** Trims frames from a video clip

Before you can edit, however, you have to select a section of a clip:

1. **Click a clip or image in either the Project pane or the Event pane to display it in the Monitor (refer to Figure 13-2).**
2. **To select the entire clip or image, simply click it.**
3. **Drag your mouse cursor across the thumbnail to select the section of the media you want to edit.**

Some editing functions automatically apply to the entire clip, such as Crop and Rotate.

The selected region is surrounded by a yellow frame. You're ready to edit that selected part of the clip.

Note the handles that appear at the beginning or ending of the selection. You can make fine changes to the selected section by dragging them.



- ✓ **To crop:** Click the Crop button on the Editing toolbar to display the frame in the Monitor pane, and then click Crop at the top of the Monitor pane. Drag the edges of the frame and the handles to select the section you want to keep. To preview your selection, click the Play button at the top of the monitor. When you're ready, click Done, and everything but the selected region is removed.
- ✓ **To rotate:** Click the Crop button on the Editing toolbar, and then click one of the two rotation buttons (which carry a curved arrow icon). Each click rotates the media 90 degrees in that direction. Click Done when the clip or image is properly oriented.
- ✓ **To trim:** Choose Edit⇨Trim to Selection. iMovie removes the frames from around the selected video.



Edits that you make to one clip or still image can actually be copied to multiple items! Select the edited clip and choose Edit⇨Copy from the iMovie menu. Then you can select one or more clips and use the Edit⇨Paste Adjustments menu to apply Video, Audio, or Crop edits. (To apply all three types of edits, just choose All.)

## Transitions for the masses

Many iMovie owners approach transitions as *visual bookends*: They merely act as placeholders that appear between video clips. Nothing could be farther from the truth, though, because judicious use of transitions can make or break a scene. For example, which would you prefer after a wedding ceremony — an abrupt, jarring cut to the reception or a gradual fadeout to the reception?



Today's audiences are sensitive to transitions between scenes. Try not to overuse the same transition. Also weigh the visual impact of a transition carefully.

iMovie includes a surprising array of transitions, including old favorites (such as Fade In and Dissolve) and some nifty stuff you might not be familiar with (such as Cube and Page Curl). To display your transition collection (see Figure 13-5), click the Show Transitions button on the Browser toolbar (or press ⌘+4).

To see what a particular transition looks like, move your mouse pointer over the thumbnail to display the transition in miniature.



**Figure 13-5:**  
Add  
transitions  
for flow  
between  
clips in  
iMovie.



Adding a transition couldn't be easier: Drag the transition from the list in the Transitions Browser pane and drop it between clips or between a clip and a still image in the Project pane. In iMovie '08, transitions are applied in real time — you don't end up checking your mail or tapping your fingers on your desk waiting for a transition to *render* (a fancy word for *calculate*, which means that older versions of iMovie required you to wait while a transition was generated).

## *Even Gone with the Wind had titles*

The last stop on our iMovie Hollywood Features Tour is the Titles Browser, as shown in Figure 13-6. You find it by clicking the Title button on the Browser toolbar (which bears a big capital T), or by pressing  $\text{⌘}+3$ . You can add a title with a still image, but iMovie also includes everything you need to add basic animated text to your movie.

Most of the controls you can adjust are the same for each animation style. You can change the font, size, and color of the text.



**Figure 13-6:**  
Add titles  
for your next  
silent film.

To add a title

1. Select an animation thumbnail from the browser pane and drag it to the desired spot in the Project pane.
2. Click the Show Fonts button to make any changes to the fonts or text attributes.
3. Click in a text box to type your own line of text.
4. Click the Play button to preview your title.

iMovie displays a preview of the effect in the monitor with the settings that you choose.

5. Click Done.

The title appears in the Project pane.

## *Sharing Your Finished Classic with Others*

Your movie is complete, you saved it to your hard drive, and now you're wondering where to go from here. Click Share on the application menu bar, and you'll see that iMovie can unleash your movie upon your unsuspecting family and friends (and even the entire world) in a number of ways:

- ✓ **iTunes:** Send your movie to your iTunes Library as a movie. iMovie offers recommended settings for your iPod, iPhone, Apple TV, and viewing on your iMac.
- ✓ **.Mac Web Gallery:** Share your movie with the world at large by posting it within a Web Gallery on your .Mac Web site. (I provide more .Mac details to chew on in Chapter 9.)
- ✓ **Media Browser:** Make your iMovie project available within other iLife '08 applications, in four different sizes suited to different display devices.
- ✓ **Export Movie:** Create a copy of your movie on your hard drive, in one of four different sizes.
- ✓ **Export via QuickTime:** You can create a QuickTime movie with your project by using the QuickTime encoding engine, which allows you greater control over the export process and the attributes of the finished movie file.



If you use this option, any computer with an installed copy of QuickTime can display your movies, and you can use QuickTime movies in Keynote presentations as well.

- ✓ **YouTube:** Yep, you read right, you can send your iMovie directly to the YouTube Web site! Can it get more convenient than that? (I think not.)
- ✓ **Export to Final Cut XML:** If you'd like to transfer your iMovie '08 project to Final Cut Pro, use this option to create a compatible XML file.

When you choose a sharing option, iMovie displays the video quality for the option, and makes automatic changes to the movie attributes. For example, choosing Tiny will reduce the finished movie as far as possible in file size, and the audio is reduced to mono instead of stereo.



Need to take a movie offline or stop sharing it? You can also remove a project from iTunes, your iLife Media Browser, your .Mac Web site, or the YouTube Web site from the Sharing menu as well. Just click the corresponding Remove menu item. (Of course, you can share the project again at any time.)



If you're worried about permanently reducing the quality of your project by sharing it in a smaller size, fear not! When you choose a sharing option to export your movie, your original project remains on your hard drive, unchanged, so you can share a better quality version at any time in the future!

After you adjust any settings specific to the desired sharing option, click Publish (or Save) to start the ball rolling.



## Chapter 14

# iDVD — Your DVD Movie Factory

---

### *In This Chapter*

- ▶ Traversing the iDVD window
  - ▶ Starting a new iDVD project
  - ▶ Tweaking and adjusting your DVD Menu
  - ▶ Previewing your (nearly) finished DVD
  - ▶ Doing things automatically with OneStep DVD and Magic iDVD
  - ▶ Burning a DVD for your friends and family
- 

**H**ow does the old adage go? Oh, yes, it's like this:

Any DVD movie must be a pain to create. You'll need a ton of money for software, too. And you'll have to take hours of training that will cause your brain to explode.

Funny thing is, *DVD authoring* — designing and creating a DVD movie — really was like that for many years. Only video professionals could afford the software and tackle the training needed to master all the intricacies of DVD Menu design.

Take one guess as to the company that changed all that. (No, it wasn't Coca-Cola.) Apple's introduction of iDVD was (quite literally) a revolution in DVD authoring. Suddenly you, your kids, and Aunt Harriet could all design and burn DVD movies and picture slideshows. Dear reader, this iDVD thing is *huge*.

Plus, you'll quickly find out that iDVD '08 is tightly connected to all the other slices of your digital hub. In plain English, you can pull content from iTunes, iPhoto, and iMovie as easily as a politician makes promises. And that, friends and neighbors, is the quintessential definition of *cool*.

In this chapter, I show you how your iMac can take on Hollywood as well as how you can produce a DVD movie with content that's as good as any you'd rent at the video store!

## Hey, Where's the Complex Window?

Figure 14-1 shows iDVD in all its glory. The iDVD '08 window was designed by the same smart people who brought you the iMovie window. You have to supply your own digital video clips, background audio, and digital photographs, of course.

Take a moment to appreciate iDVD — no half-a-dozen secondary windows to fiddle with or silly palettes strung out everywhere. (Can you tell that I've had my fill of old-style DVD authoring applications?) Allow me to list the highlights of the iDVD window:

- ✓ **Menu display:** This section takes up the largest part of the iDVD window, with good reason. You create your project here. In this case, *Menu* refers to your DVD Menu, **not** the menu at the top of your Mac's display.
  - ✓ **Media pane:** You add video, still images, and audio to your project from here, as well as tweak and fine-tune things. The Media pane actually comprises three separate panes. To choose a new pane, click one of these buttons at the bottom of the screen:
    - *Themes:* You apply themes (such as Travel Cards, Wedding White, and Baby Mobile) to your DVD Menu to give it a certain look and feel.
    - *Buttons:* These options apply to the selected item, such as drop shadows on your text titles or the appearance of your menu buttons.
    - *Media:* From here, you can add media items, such as video clips and photos, to your menu.
  - ✓ **Add button:** Clicking this opens a pop-up menu (which sports a dapper plus sign) from which you can choose one of three types of buttons to add to a project. The choices are
    - *Add Submenu:* Choose this item to add a new submenu button to your DVD Menu. The person using your DVD Menu can click a button to display a new submenu that can include additional movies or slideshows. (If that sounds like ancient Greek, hang on. All becomes clearer later in the chapter in the section, "Adding movies.")
- In iDVD '08, a Menu can hold up to 12 buttons, so submenus let you pack more content on your DVD. (Older versions of the application only allowed 6 buttons, so don't feel too cheated.) Anyway, each submenu you create can hold another 12 buttons.



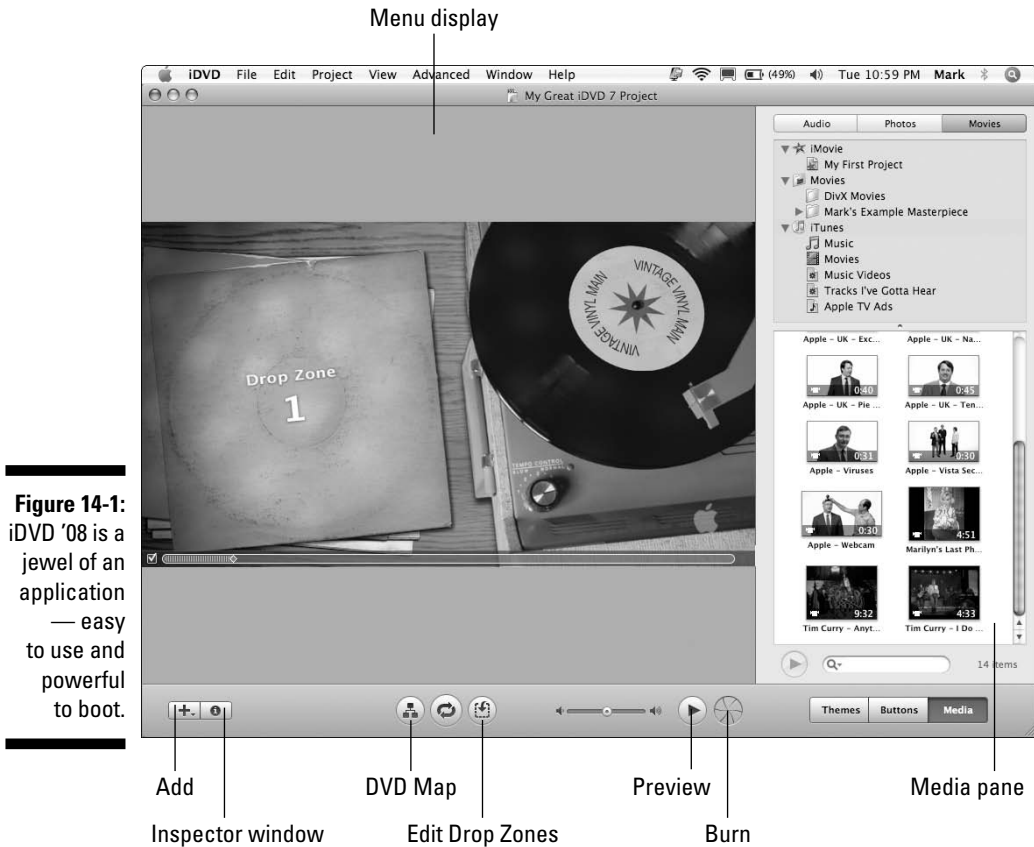

- **Add Movie:** Yep, this is the most popular button in the whole shooting match. Click this menu item to add a new movie clip to your menu.
  - **Add Slideshow:** If you want to add a slideshow to your DVD — say, using photos from your hard drive or pictures from your iPhoto library — click this menu item.
- **Inspector button:** Click this button to display the Inspector window for the current menu or a highlighted object. From this window, you can change the look of an individual submenu button or an entire menu.
- **Motion:** Click this button (which bears two arrows in a circular shape) to start or stop the animation cycle used with the current iDVD theme. The animation repeats (just like it will on your finished DVD) until you click the Motion button again.



Need a visual indicator of the length of your menu's animation cycle? Just follow the animation *playhead*, which moves below the Menu display to indicate where you are in the animation cycle. Like other playheads in the iLife suite, you can click and drag the diamond-shaped playhead button to move anywhere in the animation cycle. Choose View⇨Hide Motion Playhead to turn off the playhead display.

- ✓ **DVD Map:** Click the DVD Map button to display the organizational chart for your DVD Menu. Each button and submenu that you add to your top-level DVD Menu is displayed here, and you can jump directly to a particular item by double-clicking it. Use this road map to help design the layout of your DVD Menu system or to get to a particular item quickly. To return to the Menu display, click the DVD Map button again.
- ✓ **Edit Drop Zones:** Clicking this button allows you to edit the look and contents of a drop zone on your menu. Don't worry; I explain more about drop zones in the sidebar titled, "Taking advantage of drop zones," later in this chapter.
- ✓ **Preview:** To see how your DVD Menu project looks when burned to a DVD, click Preview. You get a truly nifty onscreen remote control that you can use to navigate your DVD Menu, just as if you were watching your DVD on a standard DVD player. To exit Preview mode, click the Stop button on the remote control. Read more about this control in the upcoming section, "Previewing Your Masterpiece."
- ✓ **Burn:** Oh, yeah, you know what this one is for — recording your completed DVD movie to a blank disc.

That's the lot! Time to get down to the step-by-step business of making movies.

## Starting a New DVD Project

When you launch iDVD '08 for the first time (or if you close all iDVD windows), you get the sporty menu shown in Figure 14-2. Take a moment to discover more about these four choices.

### Creating a new project

If you choose Create a New Project, iDVD prompts you to type a name for your new DVD project and to set a location where the project files should be saved. By default, the very reasonable choice is your Documents folder. You also get to choose whether your project will display in a Standard (full-screen) aspect ratio of 4:3, or a Widescreen aspect ratio of 16:9. If you've been watching DVD movies for some time, you recognize these two terms.



**Figure 14-2:**  
Will that  
be create  
or edit,  
manual or  
automatic?



You'll probably crave Widescreen format if you have a widescreen TV — go figure — but both formats will display on both types of televisions.

Click Create, and the iDVD window appears in all its glory.

## *Opening an existing project*

If you've used iDVD and had a DVD project open the last time you quit the application, iDVD automatically loads the DVD project you were working on. However, you can open any DVD you created by clicking Open an Existing Project. (To choose a different existing project from the iDVD window, press **⌘+O**, or choose **File⇨Open Recent**.)

## *Automating the whole darn process*

If you're a fan of click-it-and-forget-it (or are in a hurry), you can throw caution to the wind and allow iDVD to create your latest epic for you! iDVD offers two automated methods of creating a DVD movie disc.

### *Using OneStep DVD*

With OneStep, iDVD does most of the work automatically by using the media clips and photos that you specify. To allow iDVD to help you create a movie, click the OneStep DVD button on the top-level menu (refer to Figure 14-2). If

you already opened a project, choose File⇒OneStep DVD from the application menu bar (to import clips directly from your camera) or File⇒OneStep DVD from Movie (to select a clip to import from your hard drive). I tell you more about the OneStep DVD feature later in the section, “A Word about Automation.”

### ***Using Magic iDVD***

Magic iDVD is the newcomer on the block, and it falls neatly between total automation (with OneStep DVD) and total manual control. Click the Magic iDVD button on the top-level menu (as shown in Figure 14-2). If you already opened a project, you can choose File⇒Magic iDVD from the menu bar to choose a theme, drop specific movies and specific photos into filmstrips, and choose an audio track.

Unlike OneStep DVD, you get to preview the finished product. If it's to your liking, you can choose to either burn the disc directly or save a full-blown iDVD project to your hard drive with the results. *Sweet.*

You can find out more about the new Magic iDVD feature later in the section, “A Word about Automation.”

## ***Creating a DVD from Scratch***

Doing things the old-fashioned, creative, and manual way (following the examples in this section) involves four basic steps:

1. Design the DVD Menu.

Choose a theme and any necessary buttons or links.

2. Add media.

You can drag movie files from iMovie HD, still images from iPhoto, and music from iTunes.

3. Tweak.

Adjust and fine-tune your DVD Menu settings.

4. Finish things up.

Preview and burn your DVD, or save it to your hard drive.

### ***Choosing just the right theme***

The first step to take when manually designing a new DVD Menu system is to add a theme. In the iDVD world, a *theme* is a preset package that helps determine the appearance and visual appeal of your DVD Menu, including a

background image, menu animation, an audio track, and a group of settings for text fonts and button styles.

iDVD helps those of us who are graphically challenged by including a wide range of professionally designed themes for all sorts of occasions, ranging from old standbys such as weddings, birthdays, and vacations to more generic themes with the accent on action, friendship, and technology. To view the included themes, click the Themes button in the lower-right corner of the iDVD window (see Figure 14-3).

To choose a theme for your project — or to see what a theme looks like on your menu — click any thumbnail and watch iDVD update the Menu display.



If you decide while creating your DVD Menu that you need a different theme, you can change themes at any time. iDVD won't lose a single button or video clip that you add to your DVD Menu. You'll be amazed at how the look and sound of your DVD Menu completely changes with just the click of a theme thumbnail.



**Figure 14-3:**  
Select a  
new theme  
from the  
Themes  
pane.

## Taking advantage of drop zones

Most of Apple's animated themes include special bordered areas marked as drop zones. These locations have nothing to do with skydiving; rather, a *drop zone* is a placeholder in the Menu that can hold a single video clip or photograph. When you drag a video clip or an image to a drop zone, that clip or picture is added to the animation in Apple's theme! Think about that for a moment; I know I did. You can actually personalize a Hollywood-quality animated DVD menu with *your own photos and video!*

Most of the themes included with iDVD '08 include at least one drop zone, and some are practically jampacked with drop zones. For example, the amazing Forever theme has a whopping six drop zones! If you think a menu looks just fine without anything in a drop zone, however, you don't have to put anything there. The words *Drop Zone* disappear when you preview or burn your DVD. (Empty frames do tend to look a bit silly in some themes, though.)

To add a video clip or image to a drop zone, simply drag the clip or photo from a Finder window and drop it on the desired drop zone. You can also drag clips or photos from other sources, including the Movie and iPhoto panes in iDVD, the iMovie window, or the iPhoto window.

(Remember, Apple is anything but strict on these matters.) Remember, drop zones don't act as links or buttons to other content; the stuff you add to a menu's drop zones appears only as part of the theme's animation cycle. You can even drag an iPhoto event or album to a drop zone, and it will continuously cycle through the images. *Wowzers!*

To see all the drop zones at one time (without cycling through the animation), click the new Edit Drop Zones button at the bottom center of the iDVD window; you see a thumbnail display of each zone. You can drag items to these thumbnails, or you can jump right to one in the animation by clicking on the thumbnail. To delete the contents of a drop zone, click the thumbnail in the editor and press Delete.

If you're adding something to a *dynamic* drop zone (which disappears and reappears during the menu animation cycle), click the Motion button to activate the animation and then click it again to stop the animation cycle. Now click and drag the animation playhead until the desired drop zone is in view. To delete the contents of a dynamic drop zone, Control-click (or right-click) the drop zone and choose Clear Drop Zone Contents.

## Adding movies

Drop zones and themes are cool, but most folks want to add video to their DVD. To accomplish this, iDVD uses buttons as links to your video clips. In fact, some iDVD Movie buttons display a preview of the video they'll display! To play the video on a DVD player, you select the Movie button with the remote control, just like you do for a commercial DVD.

To add a Movie button, drag a QuickTime movie file from the Finder and drop it onto your DVD Menu display. (Note that only MPEG-4 QuickTime movies are supported. MPEG-1 and MPEG-2 movie clips may be rejected, or converted when possible.) Alternatively, drag a clip from the iDVD media pane into the iDVD window, or click the Add button and choose Add Movie from the pop-up menu.



iDVD and iMovie are soul mates, so you can also display the iDVD Media pane and then click Movies from the pop-up menu. Now you can drag clips from your Movies folder.

No matter the source of the clip, when you drop it onto your DVD Menu, iDVD adds a Movie button, as you can see in Figure 14-4. Note that some buttons appear as text links rather than actual buttons. The appearance of a Movie button in your DVD Menu is determined by the theme you choose.



A Movie button doesn't have to stay where iDVD places it! By default, iDVD aligns buttons and text objects on an invisible grid. However, if you don't want such order imposed on your creativity, just drag the object wherever you'd like to turn on Free Positioning. (You can also right-click the object and choose the Free Positioning item from the menu that appears.) iDVD '08 even provides cool new automatic guides that help you align objects when you're using Free Positioning. You see them as yellow lines that appear when objects are aligned along a vertical or horizontal plane.

As I mention earlier, you can have up to 12 buttons on your iDVD Menu. To add more content than 12 buttons allow, add a submenu by clicking the Add button and choosing Add Submenu from the pop-up menu. Now you can click the submenu button to jump to that screen and drag up to another 12 movie files into it.



**Figure 14-4:**  
A new  
Movie  
button  
appears  
on your  
pristine  
DVD Menu.



Keep in mind your target audience while you create your DVD. Standard TV sets have a different *aspect ratio* (height to width) and *resolution* (number of pixels on the screen) than a digital video clip, and a standard TV isn't as precise in focusing that image on the tube. If you select the Standard aspect ratio when you create the project, you can make sure that your DVD content looks great on a standard TV screen by following these steps:

- 1. Click View on the old-fashioned iDVD menu (the one at the top of the screen).**

- 2. Choose the Show TV Safe Area command.**

You can also press the convenient ⌘+T shortcut. iDVD adds a smaller rectangle within the iDVD window to mark the screen dimensions of a standard TV.

- 3. Place your content within the safe area.**

If you take care that your menu buttons and (most of) your background image fit within this smaller rectangle, you're assured that folks with a standard television can enjoy your work.

To toggle off the TV Safe Area rectangle, press ⌘+T again.

If your entire family is blessed with a fleet of HDTVs (or you chose the Widescreen aspect ratio for this project), leave the Show TV Safe Area option off. Today's widescreen displays can handle just about any orientation.

## A word on image dimensions

For best playback results on a standard TV, make sure that your background image has the same dimensions as standard digital video — 640 x 480 pixels. If the dimensions of your image don't match the dimensions of digital video, iDVD will stretch or shrink the image to fit, which might have undesirable effects. When your image is stretched and skewed to fit the DVD Menu, Aunt Harriet might end up looking like Shrek (or perhaps Fiona).

You can use QuickTime player or iPhoto to change the dimensions of your background image for import into iDVD. For example, you can use the iPhoto crop feature to alter the overall shape of the image and then resize it within iPhoto. Use the Size setting when you export the image from iPhoto; then save the file in the

Pictures folder located in your Home folder so that you can find it easily later. (For more on working in iPhoto, see Chapter 12.)

If you enjoy a cutting-edge widescreen (16:9) or HD (high-definition) TV display, you naturally might not have the same problem. And because iDVD '08 supports HD video and 16:9 video with a number of widescreen themes, be prepared to kiss the phrases *pan-and-scan* and *full-screen* goodbye and forget about the Show TV Safe Area feature. If your completed DVD projects are purely for your own enjoyment, that's a great idea. However, don't forget that if you distribute your discs to others with old-fashioned TVs dating back to the archaic 1980s and 1990s, they might not be pleased with what they see!

## *Great! Now my audience demands a slideshow!*

Many Mac owners don't realize that iDVD can use not only video clips but also digital photos as content. In fact, you can add a group of images to your DVD Menu via the Slideshow buttons, which allow the viewer to play back a series of digital photographs. iDVD handles everything for you, so there's no tricky timing to figure out or weird scripts to write. Just click the Add button at the bottom of the iDVD window and choose Add Slideshow. iDVD places a Slideshow button on your DVD Menu.

After the Slideshow button is on tap, add the content — in this case, by choosing the images that iDVD adds to your DVD Menu. Follow these steps to select your slideshow images:

1. **Double-click the Slideshow Menu button — the one you just added to the menu — to open the Slideshow display (see Figure 14-5).**
2. **Click the Media button (bottom right of the screen).**
3. **Click the Photos button (top right of the screen) to display your iPhoto library and photo albums.**

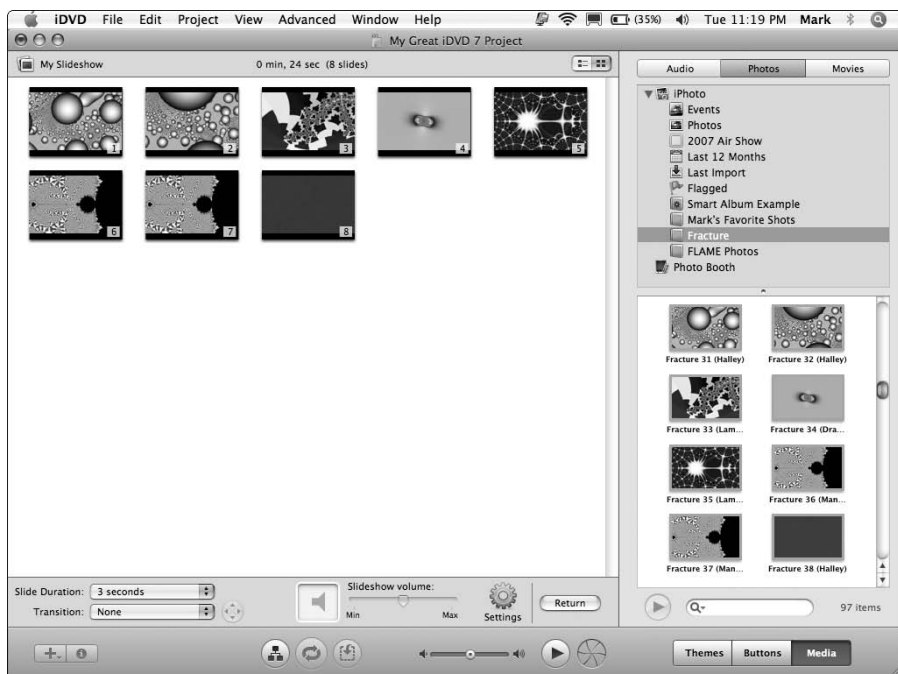

**Figure 14-5:**  
Who needs  
a projector  
anymore?  
iDVD can  
create  
a great  
slideshow!



4. **Drag your favorite image thumbnails from the Photos list and drop them into the My Slideshow window.**

You can also drag images straight from a Finder window or the iPhoto window itself. (Those Apple folks are soooooo predictable.)

5. **Drag around the photos in the My Slideshow window to set their order of appearance in your slideshow.**
6. **To add audio to these pictures, drag your favorite audio file from the Finder and drop it in the Audio well in the My Slideshow window.**

The *Audio well* is the box bearing the speaker icon, next to the volume control below the My Slideshow window.

Alternatively, click the Audio button (top right of the screen) to select an audio track from your iTunes library, iTunes playlists, or GarageBand creations.

7. **Click the Return button to return to your DVD Menu.**



If you're using a menu with animated buttons that display an image (rather than text buttons), you can choose which image you want to appear on the Slideshow button. Click the Slideshow button that you added and see the slider that appears above the Slideshow button. Drag this slider to scroll through the images you added. When you find the image that you want to use for the Slideshow button in the DVD Menu, click the Slideshow button again to save your changes.

## *Now for the music. . . .*

Most of the Apple-supplied themes already have their own background music for your menu, so you might not even need to add music to your DVD Menu. However, if you want to change the existing background music (or if your menu currently doesn't have any music), adding your own audio to the current menu is child's play!

1. **Click the Media button.**
2. **Click the Audio button to reveal the musical Shangri-La, as shown in Figure 14-6.**
3. **Drag an audio file from the iTunes playlist or GarageBand folder display and drop it on the menu background.**

iDVD '08 accepts every sound format that you can use for encoding in iTunes: AIFF, MP3, AAC, Apple Lossless, and WAV audio files.

4. **Click the Motion button to watch your DVD Menu animation cycle set to the new background audio.**
5. **Click the Motion button again to stop the animation and return to serious work.**





**Figure 14-6:**  
Will it be  
the Beach  
Boys or  
the B-52s?

## *Giving Your DVD the Personal Touch*

You can easily make changes to the default settings provided with the theme you choose. iDVD offers all sorts of controls that allow you to change the appearance and behavior of buttons, text, and the presentation of your content. In this section, I show you how to cast out iDVD's (perfectly good) defaults and then tweak things to perfection.

### *Using Uncle Morty for your DVD Menu background*

Hey, Uncle Morty might not be a supermodel, but he has birthdays and anniversaries, and iDVD is more than happy to accommodate you in documenting those milestones! Follow these steps to change the background of your DVD Menu:

1. Click the **Inspector** button (refer to Figure 14-1).

iDVD displays the Menu Info dialog.

**2. Get an image, using one of the following methods:**

- *Drag an image from the Finder* and drop it into the Background well, which appears as a square with a white outline at the top of the Menu Info dialog.
- *Drag the image directly into the Menu display.*
- *Use an image from your iPhoto library* by clicking the Media button, choosing Photos, and then dragging the desired image into the Menu display.

iDVD updates the DVD menu to reflect your new background choice.

## *Adding your own titles*

The one tweak you'll probably have to perform in every iDVD project is changing titles. Unfortunately, the default labels provided by iDVD are pretty lame, and they appear in two important places:

- ✓ **Menu title:** Your large main title usually appears at the top of the DVD Menu.
- ✓ **Button captions:** Each Submenu, Movie, and Slideshow button that you add to your menu has its own title.

To change the text in your Menu title or the titles below your buttons, follow these steps:

- 1. Select the text by clicking it.**
- 2. Click it again to edit it.**

A rectangle with a cursor appears to indicate that you can now edit the text.

- 3. Type the new text and then press Return to save the change.**

## *Changing buttons like a highly paid professional*

Customizing Movie buttons? You can do it with aplomb! Follow these steps:

- 1. Click Buttons.**
- 2. Click any Movie button from the DVD Menu to select it.**

A slider appears above the button, which you can drag to set the thumbnail picture for that button in your DVD Menu. (Naturally, this is only for animated buttons, not text buttons.)



Enable the Movie check box to animate the button.

3. **To create a Movie button with a still image, drag a picture from a Finder window or the Media pane and drop it on top of the button.**
4. **To adjust the properties for the button, click the Inspector button.**

Table 14-1 describes the button properties. Note that some properties won't appear for text buttons.

<b>Table 14-1 Button Settings You Can Customize</b>	
<i>Movie Button Property</i>	<i>What It Does</i>
Label Font	Changes the label font, text size, color and attributes.
Label Attributes	Specifies the position of the label and whether it has a shadow.
Custom Thumbnail	Allows you to select the image that will appear on the button. Drag an image to the Custom Thumbnail well. For Slideshow buttons, drag the Thumbnail slider to select the image that will appear on the button.
Transition	Determines the transition that occurs when the button is clicked (before the action occurs).
Size	Adjusts the size of the button. Move the slider to the right to increase the button size.

## *Give my creation motion!*

Earlier in this chapter, you can read how to use a different image for your background, but what about using an animated background? You can use any QuickTime movie from your iMovie library to animate your DVD Menu background! Didn't I tell you that this iDVD thing was *huge*?



Keep in mind that your background movie should be a short clip; 20–30 seconds is optimal. A clip with a fade-in at the beginning and a fade-out at the end is the best choice because iDVD loops your background clip continuously, and your animated background flows seamlessly behind your menu.



I'm not talking drop zones here. (See the sidebar, "Taking advantage of drop zones.") You can add a movie to a drop zone, of course, but by using a movie clip as a background, you're replacing the entire animation sequence rather than just a single area of the background.

Follow these steps to add a new animated background:

**1. Click your old friend, the Inspector button (refer to Figure 14-1).**

Make sure that no individual objects are highlighted so that the Inspector window displays the Menu properties instead.

**2. Drag a movie from the Finder and drop it into the Background well.**

You can click the Movies button in the Media pane to instantly display your iMovie collection.

**3. Click the Motion button in the iDVD window to try out your new background.**

**4. Click the Motion button again to stop the animation cycle.**

## Previewing Your Masterpiece

Figure 14-7 captures the elusive Preview remote control — truly an awesome sight. When you click Preview, the Media pane disappears, and your DVD Menu appears exactly as it will on the finished DVD.



**Figure 14-7:**  
Preview  
mode — an  
incredible  
simulation  
indeed.

Ah, but appearances aren't everything: You can also use your DVD Menu! Click the buttons on the remote control to simulate the remote on your DVD player, or think outside the box and click a menu button directly with your mouse pointer. iDVD presents the video clip, runs the slideshow, or jumps to a submenu, just as it will with the completed disc.

This is a great time to test-drive a project before you burn it to disc. To make sure you don't waste a blank DVD, make certain that everything you expect to happen actually happens. Nothing worse than discovering that Aunt Edna's slideshow from her Hong Kong trip actually displays your family's summer trip to the zoo (whoops). If you made a mistake or something needs tweaking, click the Exit button on the controller, and you're back to the iDVD window proper, where you can edit or fine-tune your project.



iDVD '08 allows you to save your project as a standard Mac OS X disc image rather than as a simple project file (or a physical DVD) — a good idea if you're out of blank media, because you can use the Apple Disk Utility to open and mount the disc image as if it were a burned disc. To save an iDVD project as a disc image, choose File⇨Save as Disc Image (or press ⌘+Shift+R).



Interested in tweaking settings across your entire project? Perhaps you'd like to improve the quality of your recorded video, or you'd like to switch video modes from NTSC to PAL for a DVD that's to be sent overseas. If you'd like to view or change the overall settings for your entire DVD, click Project⇨Project Info to display the Project Info dialog. Heck, you can even switch aspect ratios, or change the project name. . . . Thanks, Apple!

## *A Word about Automation*

At the beginning of the chapter, I mention the easy way to produce an iDVD disc or project, using either OneStep DVD (for complete automation) or Magic iDVD (for partial automation). In this section, I provide you with the details.

### *One-click paradise with OneStep DVD*

If you're in a hurry to create a DVD from clips on your DV camcorder and you don't mind losing your creative input, OneStep DVD is just the ticket. In short, iDVD '08 allows you to plug in your DV camcorder, answer a question or two, and then sit back while the application does all the work. iDVD '08 imports the DV clips, creates a basic menu design, and burns the disc automatically!

Using OneStep DVD will appeal to any iMac owner. Why not produce a DVD right after a wedding or birthday that you can give as a gift? Photographers who cover those same special events might consider selling a DVD made with OneStep DVD. If you happen to capture something incredibly unique — say, a UFO landing or an honest politician — you can use OneStep DVD to create an instant backup of the clips on your DV camcorder. You could even keep your friends and family up to date with the progress of your vacation by sending them a daily DVD of your exploits! (You gotta admit that even Grandma would consider that eminently *sassy!*)

Follow these steps to start the OneStep DVD process:

1. **Click the OneStep DVD button on the iDVD '08 top-level menu (refer to Figure 14-2).**

Alternatively, choose File→OneStep DVD. iDVD displays the dialog shown in Figure 14-8.

**Figure 14-8:**  
Connect your DV camcorder, and OneStep DVD does the rest.



If you want to use OneStep DVD with an existing movie on your iMac's hard drive, choose File→OneStep DVD from Movie instead. iDVD prompts you for the video clip to use.

2. **Following the prompts, connect the FireWire cable from your DV camcorder; then turn on the camcorder and set it to VCR mode.**
3. **Click OK.**
4. **Load a blank DVD when prompted.**

## *Exercising control with Magic iDVD*

Got a little extra time? For those who prefer to make just a few choices and let iDVD do the rest, the new Magic iDVD feature just plain rocks! However, you can't import clips directly from your DV camcorder like you can with OneStep DVD. Instead, you select the following:

- ✓ **An iDVD theme**
- ✓ **Video clips** you created with iMovie HD or that you dragged from the Finder
- ✓ **Photos** from your iPhoto library or dragged from the Finder
- ✓ **Audio** from your iTunes playlist or dragged from the Finder

Follow these steps to start the OneStep DVD process:

1. **Click the Magic iDVD button on the iDVD '08 top-level menu (refer to Figure 14-2).**

iDVD displays the window you see in Figure 14-9.

2. **Click in the DVD Title box and type a name for your disc (or project).**
3. **Click to select a theme from the Theme strip.**
4. **Click the Movies button and drag the desired clips into the Drop Movies Here strip.**
5. **To add a slideshow, click the Photos button and drag the desired photos into the Drop Photos Here strip.**

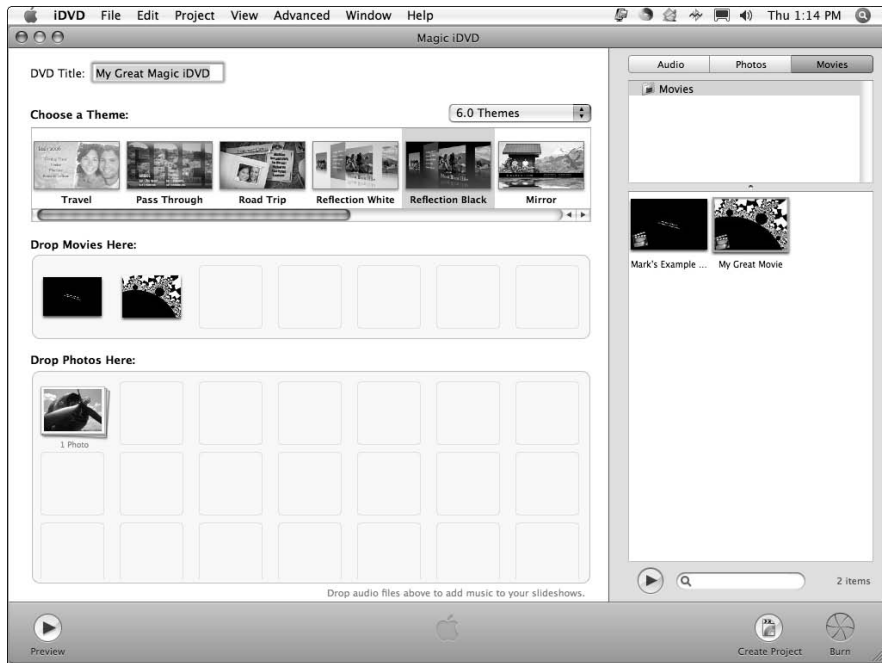

**Figure 14-9:** With Magic iDVD, you make some basic choices, and iDVD does the work.



6. **To add audio for your slideshow, click the Audio button and drag the desired song into the Drop Photos Here strip.**

No, there is no Drop Audio Here strip, but a speaker icon does appear in the first cell of the Drop Photos Here strip to indicate that you added a soundtrack.

7. **Click Preview to see a preview of the finished project, complete with remote control. To exit Preview mode, click Exit.**

8. **To open the project in its current form in the main iDVD window, click Create Project.**

Opening your Magic iDVD work as a full iDVD project gives you full creative control over what's been completed so far. (In effect, Magic iDVD has acted as an assistant and helped you to quickly build the foundation for an iDVD project.)

9. **To record your completed project directly to DVD, load a blank DVD, and then click Burn.**

To return to the iDVD main window at any time, just click the Close button on the Magic iDVD window.

## Recording a Finished Project to a Shiny Disc

When you're ready to record your next Oscar-winning documentary on family behaviors during vacation, just follow these simple words.

1. **Click the Burn button at the bottom of the iDVD window.**

I have to admit, the Burn button that appears has to be my favorite single control in all my 20-plus years of computing! It looks powerful, it looks sexy . . . it wants to *burn*. (Sorry about that. Rather wanton of me.)

2. **After iDVD asks you to insert a blank DVD-R into the SuperDrive, load a blank DVD-R, DVD-RW, DVD+R, or DVD+RW (depending on the media your Mac can handle).**



Your SuperDrive might be able to burn and read a DVD+R, DVD-RW, or DVD+RW, but what about your DVD player? Keep in mind that only DVD-Rs are likely to work in older DVD players. The latest generation of DVD players are likely DVD+R compatible as well, but I've seen only a handful of DVD players that can handle rewriteable media at the time of this writing. Therefore, remember the destination for the discs you burn and choose your media accordingly.

After a short pause, iDVD begins burning the DVD. The application keeps you updated with a progress bar.





Hey, while you're waiting, how about a timely book recommendation? If you want to discover how to burn all sorts of data, audio, and exotic CD and DVD formats, I can heartily recommend another of my books, *CD & DVD Recording For Dummies*, 2nd Edition (Wiley). It's a comprehensive manual for recording on the Mac. You'll find coverage of the popular Toast Titanium recording application from Roxio, too.

When the disc is finished, you're ready to load it into your favorite local DVD player, or you can load it back into your iMac and enjoy your work, using the Apple DVD Player.

Either way, it's all good!



## Chapter 15

# Recording Your Hits with GarageBand

---

### *In This Chapter*

- ▶ Navigating the GarageBand window
  - ▶ Adding tracks and loops to your song
  - ▶ Repeating loops and extending your song
  - ▶ Building arrangements
  - ▶ Adding effects to instruments
  - ▶ Exporting your work to iTunes and iWeb
  - ▶ Burning your song to an audio CD
- 

**D**o you dream of making music? I've always wanted to join a band, but I never devoted the time nor learned to play the guitar. You know the drill: Those rock stars struggled for years to gain the upper hand over an instrument, practicing for untold hours, memorizing chords, and. . . Wait a second. I almost forgot. You don't need to do *any* of that now!

Apple's GarageBand '08 lets a musical wanna-be (like yours truly) make music with an iMac — complete with a driving bass line, funky horns, and a set of perfect drums that never miss a beat. In fact, the thousands of prerecorded loops on tap in this awesome application even allow you to design your music to match that melody running through your head, from techno to jazz to alternative rock.

Oh, and did I mention that you can also use GarageBand '08 to produce podcasts? That's right! You can record your voice and easily create your own show, and then share it with others from your iWeb site! Heck, add photos if you like. You'll be the talk of your family and friends and maybe even your Mac user group.

This chapter explains everything you need to know to create your first song. I also show you how to import your hit record into iTunes so you can listen to it on your iPod with a big silly grin on your face (like I do) or add it to your next iMovie or iDVD project as a royalty-free soundtrack.

Don't be too smug when you think of all that practicing and hard work you missed out on. What a shame!

## Shaking Hands with Your Band

As you can see in Figure 15-1, the GarageBand window isn't complex at all, and that's good design. In this section, I list the most important controls so you know your Play button from your Loop Browser button.

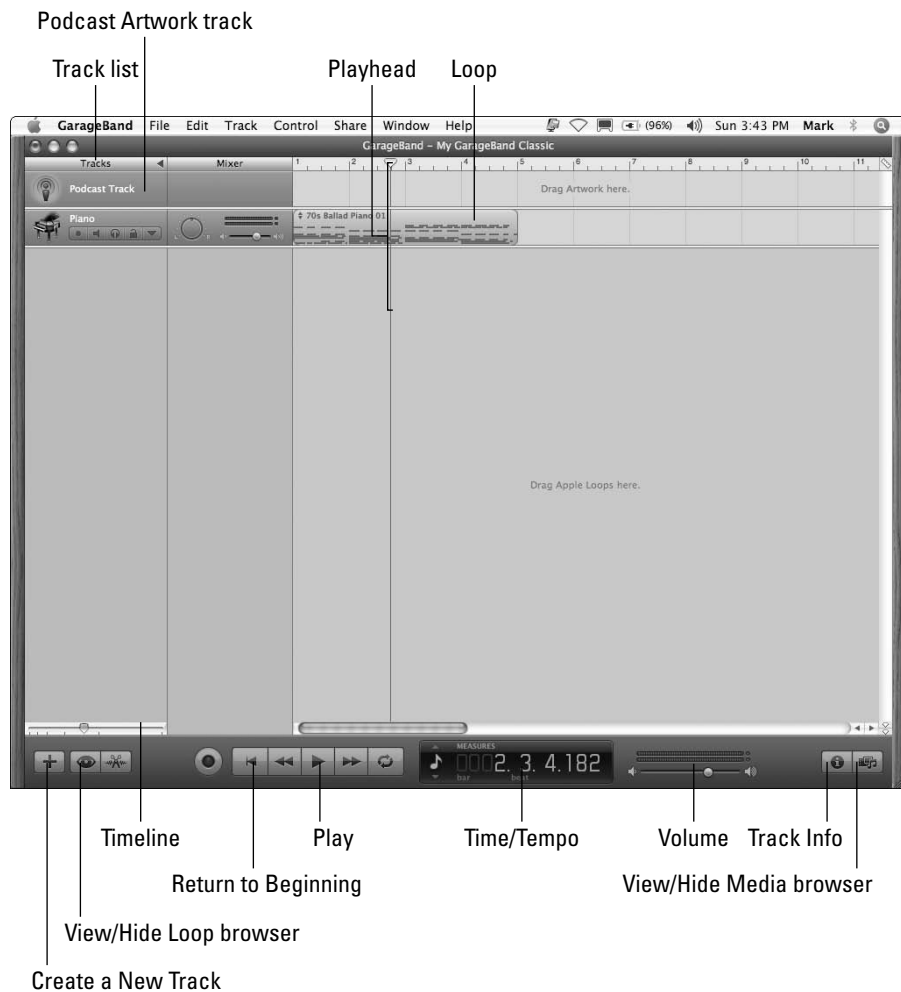

**Figure 15-1:**  
The  
GarageBand  
window —  
edged in  
wood grain,  
no less.

Your music-making machine includes



- ✓ **Track list:** In GarageBand, a *track* is a discrete instrument that you set up to play one part of your song. For example, a classical piece for string quartet would have four tracks — one each for violin, viola, cello, and bass. This list contains all the tracks in your song arranged so that you can easily see and modify them, like the rows in a spreadsheet. A track begins in the list, stretching out to the right all the way to the end of the song. As you can see in the upper left of Figure 15-1, I already have one track defined — a Grand Piano.

If you're creating a podcast, a *Podcast Artwork track* like the one you see at the very top of the list in Figure 15-1 can also appear.

- ✓ **Timeline:** This scrolling area holds the loops (see the following bullet) that you add or record, allowing you to move and edit them easily. When a song plays, the timeline scrolls to give you a visual look at your music. (Bear with me; you'll understand that cryptic statement in a page or two.)
- ✓ **Loop:** This is a prerecorded clip of an instrument being played in a specific style and tempo. *Loops* are the building blocks of your song. You can drag loops from the loop browser to a track and literally build a bass line or a guitar solo. (It's a little like adding video clips to the timeline in iMovie HD to build a film.)
- ✓ **Playhead:** This vertical line is a moving indicator that shows you the current position in your song while it scrolls by in the timeline. You can drag the playhead to a new location at any time. The playhead also acts like the insertion cursor in a word processing application: If you insert a section of a song or a loop from the Clipboard, it appears at the current location of the playhead. (More on copying and inserting loops later, so don't panic.)
- ✓ **Create a New Track button:** Click this button to add a new track to your song.
- ✓ **Track Info button:** If you need to display the instrument used in a track, click the track to select it and then click this button. You can also control settings, such as Echo and Reverb, from the dialog that's displayed.
- ✓ **View/Hide Loop Browser button:** Click the button with the striking eye icon to display the Loop Browser at the bottom of the window; click it again to close it. You can see more tracks at a time without scrolling by closing the Loop Browser.
- ✓ **View/Hide Media Browser button:** Click this button (which bears icons of a filmstrip, slide, and musical note) to display the Media Browser at the right side of the window; click it again to close it. When you close the media browser, you can see more of your tracks. If you're already familiar with iDVD or iMovie HD, you recognize this pane in the GarageBand window. Use it to add media (in this case, still images or video clips) to your GarageBand project for use in a podcast.



- ✓ **Return to Beginning button:** Clicking this button immediately moves the playhead back to the beginning of the timeline.
- ✓ **Play button:** Hey, old friend! At last, a control that you've probably used countless times before, and it works just like the same control on an audio CD player. Click Play, and GarageBand begins playing your entire song. Notice that the Play button turns blue. To stop the music, click Play again; the button loses that sexy blue sheen, and the playhead stops immediately. (If playback is paused, it begins again at the playhead position when you click Play.)
- ✓ **Time/Tempo display:** This cool-looking LCD display shows you the current playhead position in seconds. You can also click the time/tempo indicator (the blue LED numeric display at the bottom of the window) to change the tempo (or speed) of your song.  
  
GarageBand '08 expands the abilities of the default Time/Tempo display. Click the icon at the left of the display to choose other modes, such as Time (to show a more precise absolute time display) and Project (to show the key, tempo, and signature for the song). The signature is often mistaken for a fraction, but it's actually shorthand describing the rhythm of a song — the top number indicates the number of beats in each bar, and the bottom number indicating the beat as a division of a whole note. (Luckily, you won't be tested on this, and GarageBand automates as much of the music theory required for composition as possible!)
- ✓ **Volume slider:** Here's another familiar face. Just drag the slider to raise or lower the volume.

Of course, more controls are scattered around the GarageBand window, but these are the main controls used to compose a song . . . which is the next stop!

## *Composing and Podcasting Made Easy*

In this section, I cover the basics of composition in GarageBand, working from the very beginning. Follow along with this running example:

### 1. Press **⌘+N**.

GarageBand displays the Project Select dialog.

### 2. Click **Create New Music Project to create a new song**.

GarageBand displays the New Project dialog, as shown in Figure 15-2.

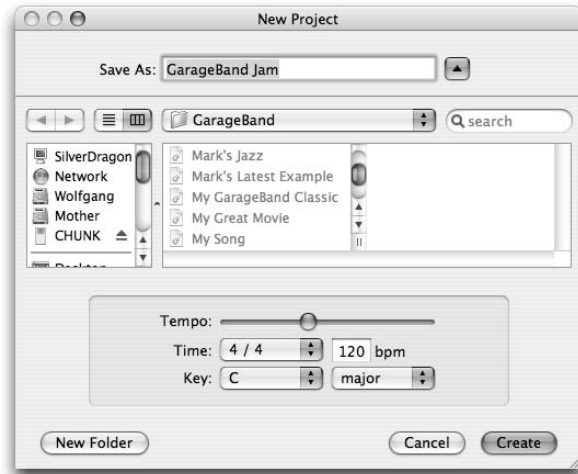

**Figure 15-2:**  
Start  
creating  
your new  
song here.



3. Type a name for your new song and then drag the Tempo slider to select the beats per minute (bpm).

A GarageBand song can have only one *tempo* (or speed) throughout, expressed as beats per minute.

4. If you want to adjust the settings for your song, you can select the
  - *Time signature*: The Time pop-up
  - *Key*: The Key pop-ups

If you're new to *music theory* (the rules/syntax by which music is created and written), just use the defaults. Most of the toe-tappin' tunes that you and I are familiar with fit right in with these settings.



5. Click the **Create** button.

You see the window shown in Figure 15-1. (The Ballad Piano 01 section in the middle of Figure 15-1 — which I show you how to add in the next section — is an example of a typical loop.)

## Adding tracks

Although I'm not a musician, I am a music lover, and I know that many classical composers approached a new work in the same way you approach a new song in GarageBand: by envisioning the instruments that you want to hear. (I imagine Mozart and Beethoven would've been thrilled to use GarageBand, but I think they did a decent job with pen — quill? — and paper, too.)

If you've followed along to this point, you've likely noticed two problems with your GarageBand window:

- ✓ **The tiny keyboard in the middle of your GarageBand window ain't the greatest.** You can record the contents of a software instrument track by “playing” the keyboard: that is, clicking the keys with your mouse. (As you might imagine, this isn't the best solution.) If you're a musician, the best method of recording your own notes is with a MIDI instrument, which I discuss later in the chapter. For now, you can banish the keyboard window by clicking the window's Close button. To display it again at any time, press  $\mathbb{E}+K$ .



Even if you're not interested in using the point-and-click keyboard, GarageBand now offers a musical typing keyboard, where you press the keys on your keyboard to simulate the keys on a musical keyboard. (Hey, if you don't have a MIDI instrument, at least it's better than nothing.) To display the musical typing keyboard window, press Shift+ $\mathbb{E}+K$ . You can toggle between the regular piano keyboard and the musical keyboard by clicking on the buttons at the top left of the keyboard window.

- ✓ **The example song has only one track.** If you want to write the next classical masterpiece for Grand Piano (the default track when you create a new song in GarageBand), that's fine. Otherwise, you could start with a clean slate by choosing Track→Delete Track on the GarageBand menu bar. It's up to you, you're the composer!



These are the four kinds of tracks you can use in GarageBand '08:

- ✓ **Software instrument tracks:** These tracks aren't audio recordings. Rather, they're mathematically precise algorithms that your iMac *renders* (builds) to fit your needs. If you have a MIDI instrument connected to your aluminum supercomputer, you can create your own software instrument tracks — more on MIDI instruments later in this chapter.  
  
In this chapter, I focus on software instrument tracks, which are the easiest for a non-musician to use.
- ✓ **Real instrument tracks:** A real instrument track is an actual audio recording, such as your voice or a physical instrument without a MIDI connection. (Think microphone.)
- ✓ **Podcast artwork track:** You get only one of these, which holds photos that appear on a video iPod (or a window on your iWeb site) when your podcast is playing.
- ✓ **Video tracks:** The video sound track appears if you're *scoring* (adding music) to an iMovie movie. Along with the video sound track, you get a cool companion video track that shows the clips in your movie. (More on this in the sidebar, “Look, I'm John Williams!,” later in this chapter.)



Time to add a software instrument track of your very own. Follow these steps:

1. Click the **Create a New Track** button (which carries a plus sign, labeled in Figure 15-1).

GarageBand displays the New Track sheet.

2. In the **New Track** sheet, select the **Software Instrument Track** radio button and then click **Create**.

The New Track sheet disappears, and you're presented with all those great instruments in the Track Info pane on the right.

3. Choose the **general instrument category** by clicking it.

I chose Drum Kits.

4. From the **right column**, choose your specific style of weapon, such as **Jazz Kit** for a jazzy sound.

If you haven't installed the extra kits along with GarageBand, note that you may see disabled instruments appear in the list. Click the right arrow to install the complete set of instruments and loops.

Figure 15-3 illustrates the new track that appears in your list when you follow these steps.

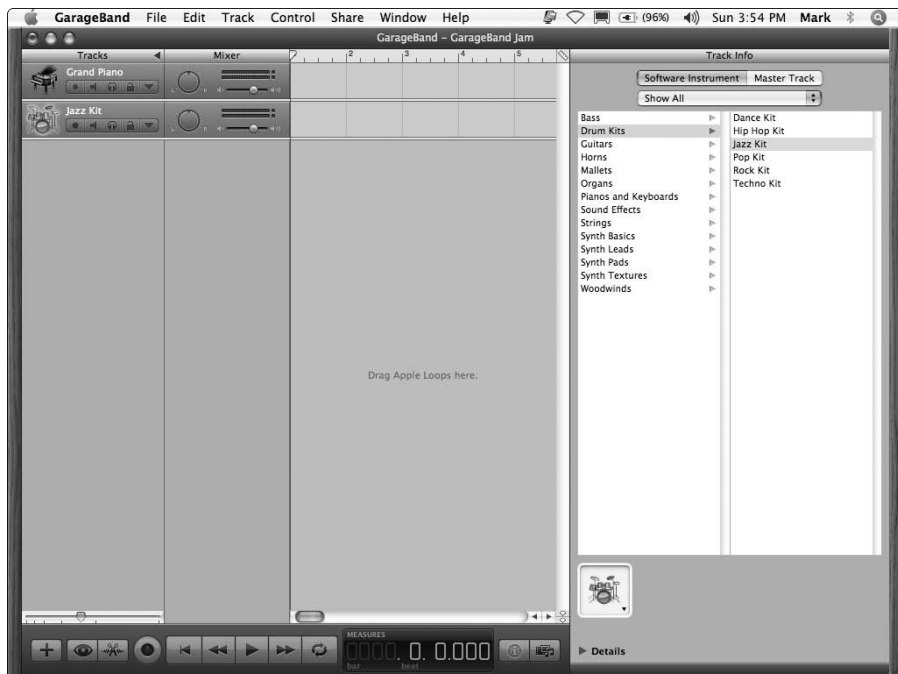

**Figure 15-3:**  
The new track appears, ready to rock.

If you're creating a podcast and you want to add a series of still images that will appear on a video iPod's screen (or on your iWeb page), follow these steps:

1. **Click the View Media Browser button (labeled in Figure 15-1).**
2. **Click the Photos button.**

GarageBand displays all the photos in your iPhoto library and film rolls.

3. **Drag an image from your iPhoto library in the media browser to the Track list.**

The Podcast track appears at the top of the Track list, and you can add and move images in the list at any time, just like the loops that you add to your instrument tracks. (More on adding and rearranging the contents of a track later in this section.)

## Choosing loops

When you have a new, empty track, you can add something that you can hear. You do that by adding loops to your track from the Loop Browser — Apple provides you with thousands of loops to choose from — and photos from your Media Browser. Click the Loop Browser button (which bears the all-seeing eye) to display your collection, as shown in Figure 15-4.



If your browser looks different from what you see in Figure 15-4, that's because of the view mode you're using, just like the different view modes available for a Finder window. The three-icon button in the lower-left corner of the Loop Browser toggles the browser display between column, musical button, and podcast sounds views. Click the middle of the three buttons to switch to button mode.

### *Looking for just the right loop*

The track in this running example uses a jazz drum kit, but I haven't added a loop yet. (Refer to Figure 15-3.) Follow these steps to search through your loop library for just the right rhythm:

1. **Click the button that corresponds to the instrument you're using.**

In this example, use the Kits button (which appears as the second button in the second row within the Loop Browser). Click it, and a list of different beats appears in the pane to the right of the browser window. (Check out Figure 15-4 for a sneak peek.)

2. **Click one of the loops with a green, music note icon.**

Go ahead; this is where things get fun! GarageBand begins playing the loop nonstop, allowing you to get a feel for how that particular loop sounds.

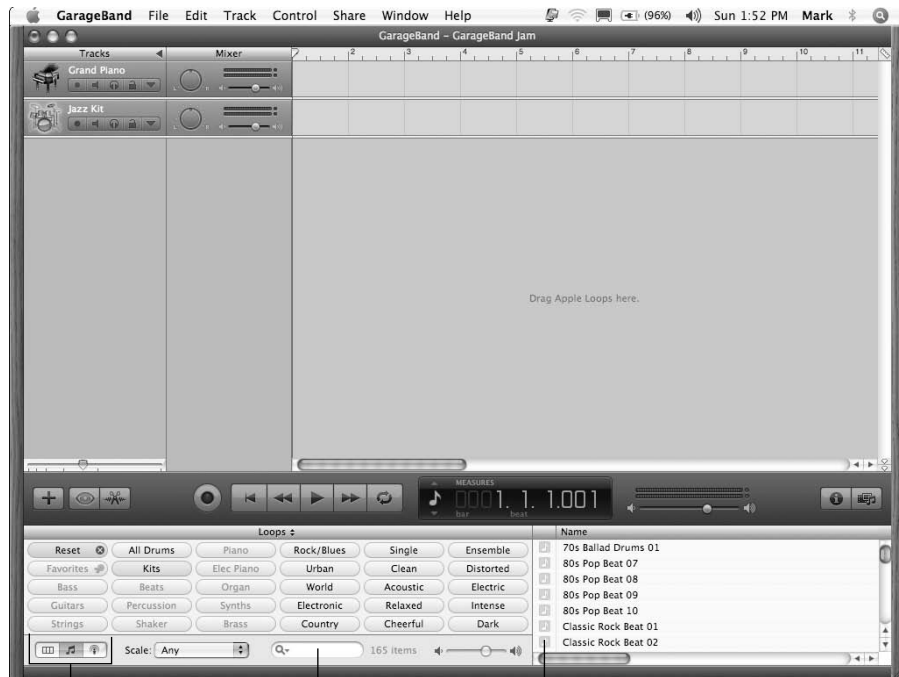

**Figure 15-4:**  
The Loop  
Browser,  
shown in  
button view.

Search

Software instrument loop icon

View: Column/Button/Podcast sounds



Because I'm using only software instruments in this track (and in examples throughout this chapter), you should choose only software instrument loops, which are identified with a green, music note icon.

- 3. Click another entry in the list, and the application switches immediately to that loop.**

Now you're beginning to understand why GarageBand is so cool for both musicians and the note-impaired. It's like having your own band, with members that never get tired and play whatever you want while you're composing. (Mozart would've *loved* this.)



If you want to search for a particular instrument, click in the Search field (labeled in Figure 15-4) and type the text you want to match. GarageBand returns the search results in the list.

- 4. Scroll down the list and continue to sample the different loops until you find one that fits like a glove.**

For this reporter, it's Lounge Jazz Drums 01.

**5. Drag the entry to your Jazz Kit track and drop it at the very beginning of the timeline (as indicated by the playhead).**

Your window will look like Figure 15-5.

If you want that same beat throughout the song, you don't need to add any more loops to that track (more on extending that beat in the next section). However, if you want the drum's beat to change later in the song, you add a second loop after the first one in the same track. For now, leave this track as is.



Whoops! Did you do something that you regret? Don't forget that you can undo most actions in GarageBand by pressing the old standby  $\text{⌘}+\text{Z}$  immediately afterward.

***Second verse, same as the first***

When you compose, you can add additional tracks for each instrument that you want in your song:

- ✓ Each track can have more than one loop.
- ✓ Loops don't have to start at the beginning; you can drop a loop anywhere on the timeline.

For example, in Figure 15-6, you can see that my drum kit kicks in first, but my bass line doesn't begin until some time later (for a funkier opening).

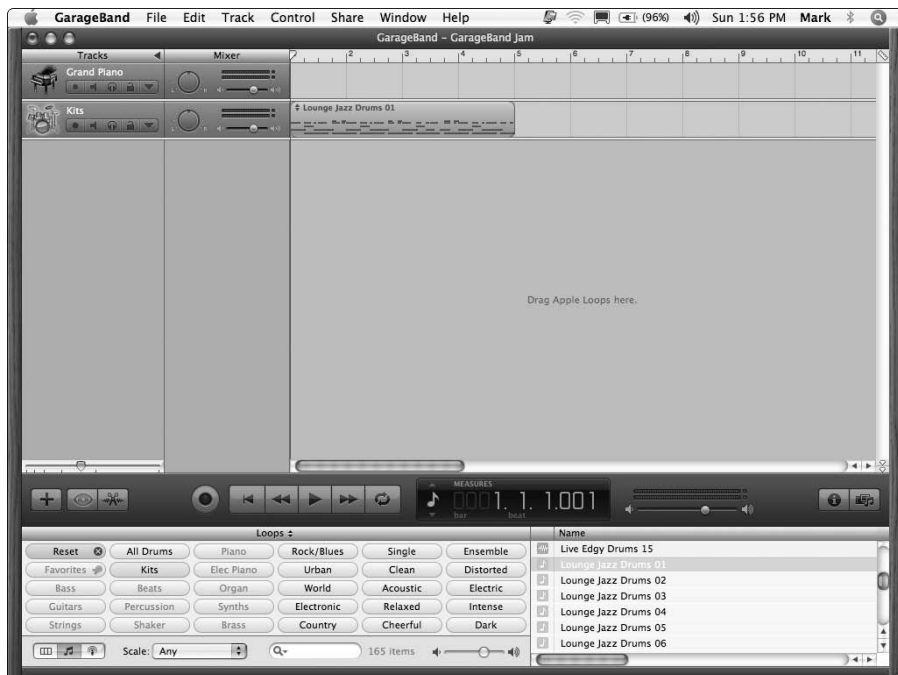

**Figure 15-5:**  
A track with  
a loop  
added.

**Figure 15-6:**  
My timeline  
with a jazz  
piano and  
an upright  
smooth  
bass  
onboard.  
Cool,  
Daddy-o!

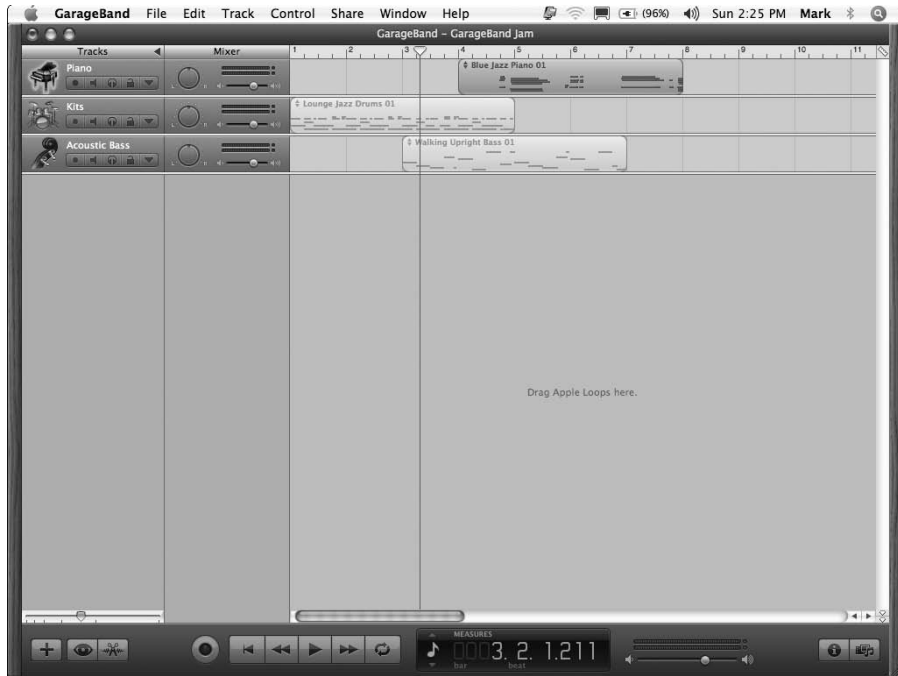

You put loops on separate tracks so they can play simultaneously on different instruments. If all your loops in a song are added on the same track, you hear only one loop at any one time, and all the loops use the same software instrument. By creating multiple tracks, you give yourself the elbow room to bring in the entire band at the same time. It's uber-convenient to compose your song when you can see each instrument's loops and where they fall in the song.



Click the Reset button in the loop browser to choose another instrument or genre category.

## *Resizing, repeating, and moving loops*

If you haven't already tried listening to your entire song, try it now. You can click Play at any time without wreaking havoc on your carefully created tracks. Sounds pretty good, doesn't it?

But wait: I bet the song stopped after about five seconds, right? (You can watch the passing seconds by using either the Time/Tempo display or the second rule that appears at the very top of the timeline.) I'm sure that you want your song to last more than five seconds! After the playhead moves past the end of the last loop, your song is over. Click Play again to pause the playback; then click the Return to Beginning button (labeled in Figure 15-1) to move the playhead back to the beginning of the song.

## Look, I'm John Williams!

You, too, can be a famous composer of soundtracks. Well, perhaps not quite as famous as Mr. Williams, but even he had to start somewhere. To add a GarageBand score to an iMovie, click the Track menu and then click Show Movie Track to display the Movie track in the list. Choose a movie to score from the familiar confines of the Media Browser, and drag it to the Movie track. (Note that your project can't have both a Movie track and a Podcast track at the same time.)

At this point, you add and modify instrument tracks and loops just like you would any other GarageBand project. The existing sound for the

iMovie project appears in the Movie Sound track. A Video Preview pane appears on top of the Track Info pane on the right side of the GarageBand window. When you click the Play button, the video is shown as well so that you can check your work and tweak settings (as I describe later in the chapter).

After you finish composing, click Share on the menu bar and choose whether to export your work to iDVD, as a QuickTime movie directly to your hard drive, or to iTunes as a movie. Note that you can't return to iMovie with your project, so scoring should be a final step in the production of your movie.

The music stops so soon because your loops are only so long. Most are five seconds in length, and others are even shorter. To keep the groove going, you have to do one of three things:

- ✓ **Resize the loop.** Hover your mouse cursor over either the left or right edge of most loops, and an interesting thing happens: Your cursor changes to a vertical line with an arrow pointing away from the loop. That's your cue to click and drag — and while you drag, most loops expand to fill the space you're making, repeating the beats in perfect time. By resizing a loop, you can literally drag the loop's edge as long as you like.
- ✓ **Repeat the loop.** Depending on the loop that you chose, you might find that resizing it won't repeat the measure. Instead, the new part of the loop is simply dead air. In fact, the length of many loops is limited to anywhere from one to five seconds. However, if you move your cursor over the top-right corner of a loop that you want to extend, it turns into a vertical line with a circular arrow, which tells you that you can click and repeat the loop. GarageBand actually adds multiple copies of the same loop automatically, for as far as you drag the loop. In Figure 15-7, I repeat the bass loop in Figure 15-6.
- ✓ **Add a new loop.** You can switch to a different loop to change the flow of the music. Naturally, the instrument stays the same, but there's no reason why you can't use a horn riff loop in your violin track (as long as it sounds good played by a violin)! To GarageBand, a software instrument track is compatible with any software instrument loop that you add from the Loop Browser as long as that loop is marked with our old friend, the green music note.

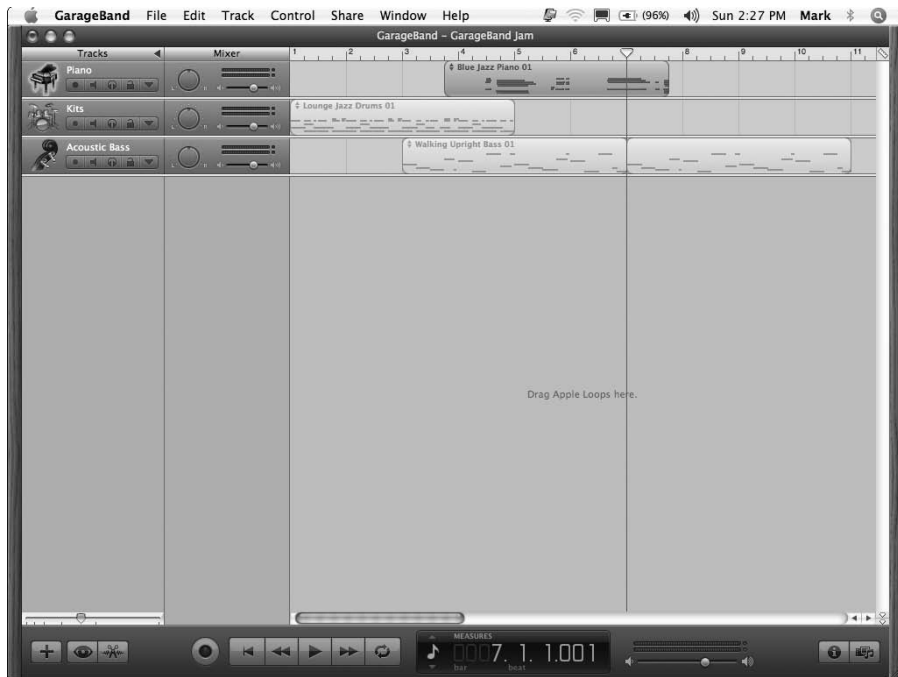

**Figure 15-7:**

By repeating the bass loop, you can keep the thump flowing.



You can also use the familiar cut ( $\text{⌘}+\text{X}$ ), copy ( $\text{⌘}+\text{C}$ ) and paste ( $\text{⌘}+\text{V}$ ) shortcuts to cut, copy, and paste loops from place to place, both on the timeline and from track to track. Hold down Option and drag a loop to repeat it, and click a loop and drag it anywhere to move it. After all, you're working under Mac OS X — the Leopard breed of cat.

Each track can be adjusted so that you can listen to the interplay between two or more tracks or hear how your song sounds without a specific track:

- ✓ Click the tiny speaker button under the track name in the list, and the button turns blue to indicate that the track is muted. To turn off the mute, click the speaker icon again.
- ✓ You can change the volume or balance of each individual track by using the mixer that appears next to the track name. This comes in handy if you want an instrument to sound louder or confine that instrument to the left or right speaker.

A track doesn't have to be filled for every second with one loop or another. As you can see in Figure 15-8, my first big hit — I call it *Turbo Techno* — has a number of repeating loops with empty space between them as different instruments perform solo. Not bad for an air guitarist who can barely whistle. Listen for it soon at a rave near you!

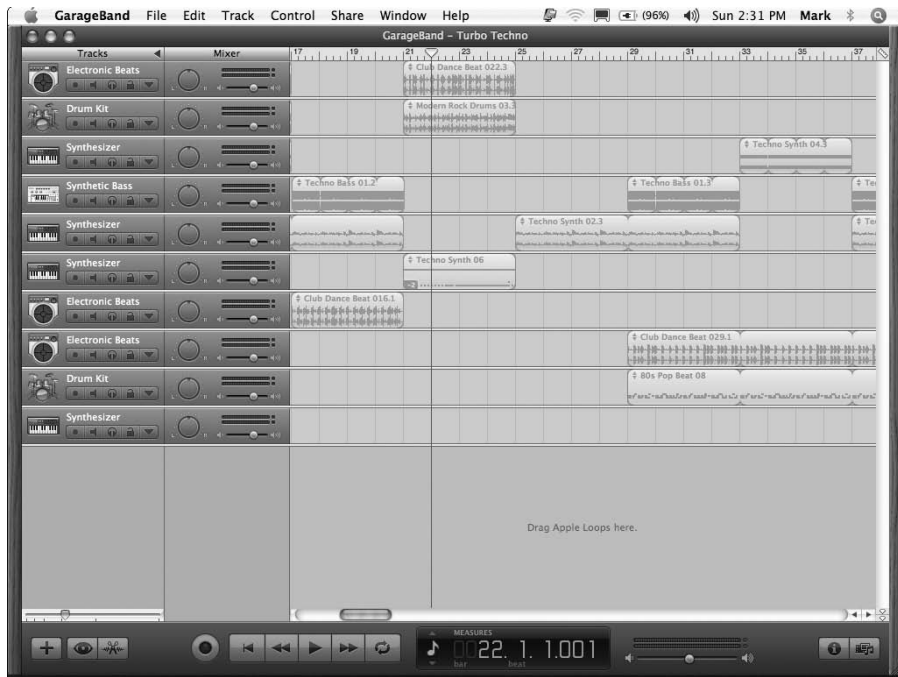

**Figure 15-8:**  
The author's  
upcoming  
techno  
hit—  
produced  
on an iMac,  
naturally.

## Using the Arrange track

GarageBand '08 adds another method you can use to monkey with your music: Use the *Arrange track* to define specific sections of a song, allowing you to reorganize things by selecting, moving, and copying entire sections. For example, you're probably familiar with the chorus (refrain) of a song, and how often it appears during the course of the tune. In an Arrange track, you can reposition the entire chorus within your song, carrying all the loops and settings within the chorus along with it! If you need another chorus, just copy that arrangement.

To use an Arrange track, display it by choosing **Track** ⇨ **Show Arrange Track**. It appears as a thin strip at the top of the track list. Click the **Add Region** button in the Arrange track (which carries a plus sign), and you see a new untitled region appear (as shown in Figure 15-9). You can drag the right side of the Arrange region to resize it, or drag it to move it anywhere in the song.





**Figure 15-9:**  
I add a new  
region in  
my song's  
Arrange  
track.



Who wants an arrangement full of regions named *untitled*? To rename an Arrangement region, click the word *untitled* to select it (the Arrange track turns blue), and then click the title again to display a text box. Type a new name for the region and then press Return.

Now, here's where arrangement regions get cool:

- ✓ **To move an entire arrangement region**, click the region's title in the Arrange track and then drag it anywhere you like within the song.
- ✓ **To copy an arrangement region**, hold down the Option key and drag the desired region's title to the spot where you want the copy to appear.
- ✓ **To delete an arrangement region**, select it and press  $\mathbb{C}$ +Option+Delete.
- ✓ **To replace the contents of an arrangement region with those of another arrangement region**, hold down the  $\mathbb{C}$  key and drag the desired region's title on top of the offending region's title.
- ✓ **To switch two arrangement regions in your song** — swapping the contents completely — drag one of the arrangement region titles on top of the other and then release the mouse button.

## Tweaking the settings for a track

You don't think that John Mayer or U2 just "play and walk away," do you? No, they spend hours after the recording session is over, tweaking their music in the studio and on the mixing board until every note sounds just like it should. You can adjust the settings for a track, too. The tweaks that you can perform include adding effects (pull a Hendrix, and add echo and reverb to your electric guitar track) and kicking in an equalizer (for fine-tuning the sound of your background horns).

To make adjustments to a track, follow these steps:

1. Click the desired track in the track list to select it.
2. Click the Track Info button (labeled in Figure 15-1).
3. Click the Details triangle at the bottom to expand the pane and show the settings shown in Figure 15-10.
4. Select the check box of each effect you want to enable.

Each of the effects has a modifier setting. For example, you can adjust the amount of echo to add by dragging its slider.



**Figure 15-10:**  
Finesse your tune by tweaking the sound of a specific track.



GarageBand '08 provides a new Visual Equalizer window that you can use to create a custom equalizer setting for each track. You can display the Visual EQ window by clicking the Edit button at the far right of the Visual EQ controls in the expanded Track Info pane. To change the Bass, Low Mid, High Mid, or Treble setting for a track, click and drag the equalizer waveform in the desired direction. And, yep, you can do this while your song is playing, so you can use both your eyes *and* ears to define the perfect settings!

5. **To save the instrument as a new custom instrument (so that you can choose it the next time you add a track), click the Save Instrument button.**
6. **Click the Track Info button again to return to GarageBand.**

Time for a Mark's Maxim:



*Save your work often* in GarageBand, just like in the other iLife applications. One power blackout, and you'll never forgive yourself. Press **⌘+S**, and enjoy the peace of mind.<sup>TM</sup>

## Join in and jam . . . or talk!

As I mention elsewhere in this chapter, GarageBand is even more fun if you happen to play an instrument! (And yes, I'm envious, no matter how much I enjoy the techno and jazz music that I create. After all, take away my iMac, and I'm back to playing the kazoo.)

Most musicians use MIDI instruments to play music on the computer. That pleasant-sounding acronym stands for *Musical Instrument Digital Interface*. A wide variety of MIDI instruments are available these days, from traditional MIDI keyboards to more exotic fun, such as MIDI saxophones. For example, Apple sells a 49-key, M-Audio MIDI keyboard for around \$100, which uses a USB connection to your iMac.

Most MIDI instruments on the market today use a USB connection. If you have an older instrument with traditional MIDI ports — they're round, so you'll never confuse them with a USB connector — you need a USB-to-MIDI converter. You can find this type of converter on the Apple

Web site for around \$50. (If you're recording your voice for a podcast, things are easier because you can use your iMac's built-in microphone.)

After your instrument is connected, you can record tracks by using any software instrument. Create a new software instrument track as I demonstrate in this chapter, select it, and then play a few notes. Suddenly, you're playing the instrument you chose! (If nothing happens, check the MIDI status light — which appears in the time display — to see whether it blinks with each note you play. If not, check the installation of your MIDI connection and make sure that you loaded any required drivers.)

Drag the playhead to a beat or two before the spot in the timeline where you want your recording to start. This gives you time to match the beat. Then click the big red Record button and start jamming or speaking! When you're finished, click the Play button to stop recording.

## Automatic Composition with Magic GarageBand

In a hurry? Too rushed to snag loops and tweak effects? Never fear, GarageBand '08 can even compose a song automatically! The new Magic GarageBand feature provides a wide range of eight different genres of music to choose from — everything from blues to reggae to funk and rock.

To create a new song automatically, follow these steps:

**1. Press ⌘+N to start a new project.**

If you're working on a song, GarageBand prompts you to save it before closing the window.

**2. Click the Magic GarageBand button on the Project Select dialog.**

You see an imposing curtain, with a button for each song genre.

**3. Click the desired genre button.**

**4. To hear the entire song with the default instruments, click Entire Song and then click the Play button.**

Alternatively, to hear a short sample of the song, click Snippet and then click the Play button.

**5. Click Audition to switch instruments or use the default musical arrangement.**

The curtains open (as shown in Figure 15-11), and you see each individual instrument on stage. To choose a different musical style for an instrument (or a different variation of the instrument), click it, and then select the desired sound from the menu below the stage.

Click My Instrument (the empty space in the middle of the stage) to add your own voice or instrumental, using a microphone or MIDI instrument.

**6. After the song fits like a glove, click Create Project to open the song as a project in GarageBand.**

Now you can edit and tweak the song to your heart's delight like any other GarageBand project, adding other software or real instrument tracks as necessary.





**Figure 15-11:** Creating my own arena rock classic with Magic Garage Band.

## *Sharing Your Songs and Podcasts*

After you finish your song, you can play it whenever you like through GarageBand. But then again, that isn't really what you want, is it? You want to share your music with others with an audio CD or download it to your iPod so that you can enjoy it yourself while walking through the mall!

iTunes to the rescue! Just like the other iLife applications that I cover in this book, GarageBand can share the music you make through the digital hub that is your iMac.

## *Creating MP3 and AAC files*

You can create digital audio files in MP3 or AAC format from your song or podcast project in just a few simple steps:

- 1. Open the song that you want to share.**
- 2. Choose Share → Send Song to iTunes.**

GarageBand displays the settings you see in Figure 15-12.

3. Click in each of the four text boxes to type the playlist, artist name, composer name, and album name for the tracks you create.

You can leave the defaults as is, if you prefer. Each track that you export is named after the song's name in GarageBand.

4. From the **Compress Using pop-up menu**, choose the encoder that GarageBand should use to compress your song file.

The default is AAC, but you can also choose MP3 encoding for greater compatibility.

5. From the **Audio Settings pop-up menu**, choose the proper audio quality for the finished file.

The higher quality, the larger the file.

GarageBand displays the approximate file size and finished file information in the description box.

6. Click **Share**.

After a second or two of hard work, your iMac opens the iTunes window and highlights the new (or existing) playlist that contains your new song.

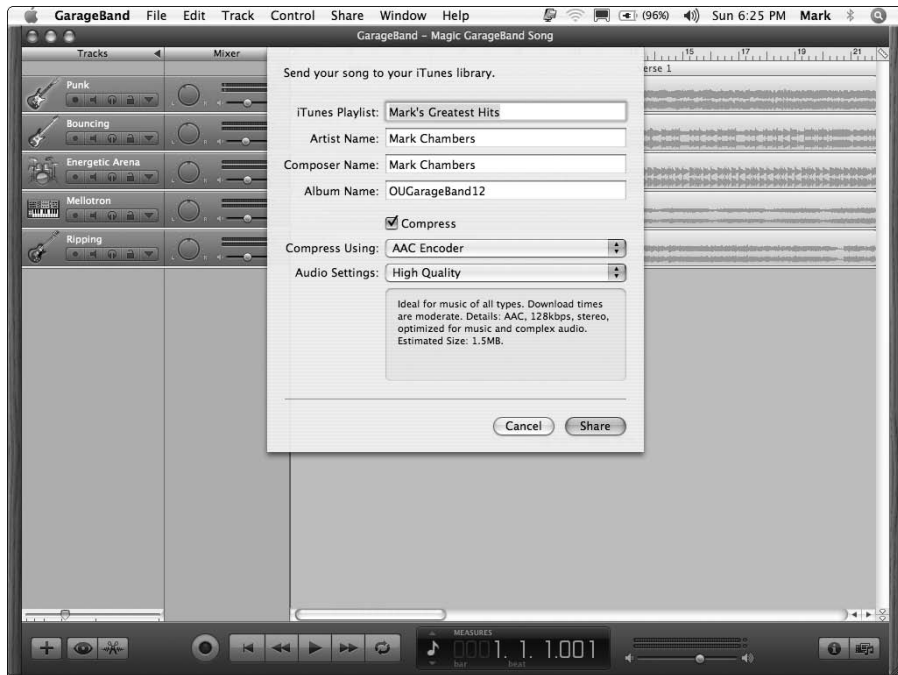

**Figure 15-12:**  
Tweaking  
settings  
for iTunes  
song files.

## *Sending a podcast to iWeb or iTunes*

If you've prepared a new podcast episode in GarageBand, you can send it automatically to iWeb or iTunes by following these steps:

- 1. Open the podcast that you want to export to iWeb.**

Make sure that the Podcast track is displayed — if necessary, choose Track⇨Show Podcast Track to display it.

- 2. Choose Share⇨Send Podcast to iWeb (or Share⇨Send Podcast to iTunes).**

- 3. From the Compress Using pop-up menu, choose the encoder GarageBand should use to compress your podcast file.**

Your choices are AAC or MP3 format.

- 4. From the Audio Settings pop-up menu, choose the proper audio quality for the finished file.**

- 5. Click Share.**

## *Burning an audio CD*

Ready to create a demo CD with your latest GarageBand creation, using your iMac's built-in optical drive? Follow these steps to burn an audio disc from within GarageBand:

- 1. Open the song that you want to record to disc.**

- 2. Choose Share⇨Burn Song to CD.**

- 3. Load a blank disc into your optical drive.**



GarageBand includes an entire book's worth of features, settings, and other stuff, so there just isn't enough space in a single chapter of this iMac-driven tome to cover it all. If you'd like to dive in to everything that GarageBand offers, I heartily recommend *GarageBand For Dummies* (Wiley), written by fellow Mac guru Bob LeVitus. He can take you from one end of GarageBand to the other in no time flat!





# Part V

## Sharing Access and Information

The 5<sup>th</sup> Wave

By Rich Tennant

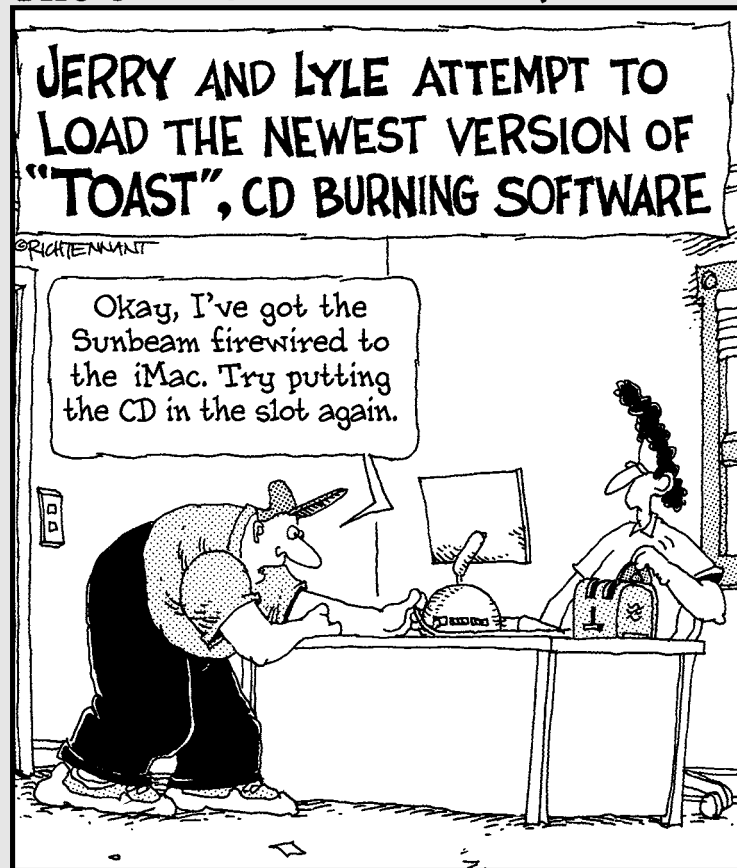

## *In this part . . .*

**R**eady to share your iMac among all the members of your family? If you want to provide access to your beloved iMac to those near and dear to your heart, or you've decided to build a wireless home network, you've come to the right place. In this part, I show you how to provide others with access to your documents and data — securely, mind you, and with the least amount of hassle.

## Chapter 16

# Creating a Multiuser iMac

---

### *In This Chapter*

- ▶ Enjoying the advantages of a multiuser iMac
  - ▶ Understanding access levels
  - ▶ Adding, editing, and deleting user accounts
  - ▶ Restricting access for managed accounts
  - ▶ Configuring your login window
  - ▶ Sharing files with other users
  - ▶ Securing your stuff with FileVault
- 

**E**verybody wants a piece. (Of your iMac, that is.)

Perhaps you live in a busy household with kids, significant others, grandparents, and a wide selection of friends — all of them clamoring for a chance to spend time on the Internet, take care of homework, or enjoy a good game.

On the other hand, your iMac might occupy a classroom or a break room at your office — someplace public, yet everyone wants his own Private iDaho on the iMac, complete with a reserved spot on the hard drive and his own hand-picked attractive Desktop background.

Before you throw your hands up in the air in defeat, read this chapter and take heart! Here you find all the step-by-step procedures, explanations, and tips to help you build a *safe* multiuser iMac that's accessible to all.

(Oh, and you still get to use it, too. That's not being selfish.)

## *Once Upon a Time (An Access Fairy Tale)*

Okay, so you don't have Cinderella, Snow White, or that porridge-loving kid with the trespassing problem. Instead, you have your brother Bob.

Every time Bob visits your place, it seems he needs to do “something” on the Internet, or he needs a moment with your iMac to bang out a quick message, using his Web-based e-mail application. Unfortunately, Bob’s forays onto your iMac always result in stuff getting changed, like your Desktop settings, Address Book, and Safari bookmarks.

What you need, good reader, is a visit from the Account Fairy. Your problem is that you have but a single user account on your system, and Leopard thinks that Bob is *you*. By turning your iMac into a multiuser system and giving Bob his own account, Leopard can tell the difference between the two of you, keeping your druthers separate!

With a unique user account, Leopard can track all sorts of things for Bob, leaving your computing environment blissfully pristine. A user account keeps track of stuff such as

- ✓ Address Book contacts
- ✓ Safari bookmarks and settings
- ✓ Desktop settings (including background images, screen resolutions, and Finder tweaks)
- ✓ iTunes libraries, just in case Bob brings his own music (sigh)
- ✓ Web sites that Bob might ask you to host on your computer (resigned sigh)

Plus, Bob gets his own reserved Home folder on your iMac’s hard drive, so he’ll quit complaining about how he can’t find his files. Oh, and did I mention how user accounts keep others from accessing *your* stuff? And how you can lock Bob out of where-he-should-not-be, such as certain applications, iChat, Mail, and Web sites (including that offshore Internet casino site that he’s hooked on)?

Naturally, this is only the tip of the iceberg. User accounts affect just about everything you can do in Leopard and on your iMac. The moral of my little tale? A Mark’s Maxim to the rescue:



Assign others their own user accounts, and let Leopard keep track of everything. Then you can share your iMac with others and still live happily ever after!<sup>TM</sup>

## Big-Shot Administrator Stuff

Get one thing straight right off the bat: *You* are the administrator of your iMac. In network-speak, an *administrator* (or *admin* for short) is the one with the power to Do Unto Others — creating new accounts, deciding who gets access to what, and generally running the multiuser show. In other words, think of yourself as the Monarch of Mac OS X. (The ruler, not the butterfly.)



I always recommend that you have only one (or perhaps two) accounts with administrator-level access on any computer. This makes good sense because you can be assured that no one can monkey with your iMac while you're away from the keyboard. So why might you want a second admin account? Well, if you're often away on business, you might need to assign a second administrator account to a *trusted* individual who knows as much about your iMac as you do. (Tell 'em to buy a copy of this book.) That way, if something breaks or an account needs to be tweaked in some way, the other person can take care of it whilst you're gone (but without giving that person access to your personal data).

In this section, I explain the typical duties of a first-class iMac administrator.

## *Deciding who needs what access*

Leopard provides three levels of individual user accounts:

- ✓ **Admin (administrator):** See the beginning of this section.
- ✓ **Standard level:** Perfect for most users, these accounts allow access to just about everything but don't let the user make drastic changes to Leopard or create new accounts.
- ✓ **Managed with Parental Controls level:** These are standard accounts with specific limits that are assigned either by you or by another admin account.

Another Mark's Maxim is in order:



Assign other folks standard-level accounts and then decide whether each new account needs to be modified to restrict access as a managed account. *Never* assign an account admin-level access unless you deem it truly necessary.<sup>TM</sup>

Standard accounts are quick and easy to set up, and I think they provide the perfect compromise between access and security. You'll find that standard access allows your users to do just about anything they need to do, with a minimum of hassle.

Managed accounts (with Parental Controls) are highly configurable so you can make sure that your kids don't end up trashing the hard drive, sending junk mail, or engaging in unmonitored chatting. (**Note:** Parents, teachers, and those folks designing a single public access account for a library or organization — this means *you*.)



Leopard also provides Group and Sharing Only accounts, but shy away from these advanced levels. Stick with the Big Three levels to ensure that everyone has the proper access to your iMac.

## Adding users

All right, Mark, enough pregame jabbering — show this good reader how to set up new accounts! Your iMac already has one admin-level account set up for you (created during the initial Leopard set-up process), and you need to be logged in with that account to add a user. To add a new account, follow these steps:

1. Click the **System Preferences icon on the Dock** and then click the **Accounts icon to display the Accounts pane** that you see in **Figure 16-1**.
2. Click the **New User button** — the one with the plus sign at the bottom of the accounts list — to display the new user sheet shown in **Figure 16-2**.



**Figure 16-1:**  
Add new  
user  
accounts  
here.



**Figure 16-2:**  
Fill out those  
fields, and  
you have a  
new user.



If your New User button is grayed out, your Accounts pane is locked. Remember that you can toggle the padlock icon at the lower-left corner of most of the panes in System Preferences to lock or allow changes. To gain access, do the following:

- a. Click the padlock icon to make changes to the Accounts pane.
- b. When Leopard prompts you for your admin account password (the account you're currently using), enter it.
- c. Click OK.

Now you can click the New User button.

**3. Click the New Account pop-up menu and specify the account level status.**

Choose from Administrator, Standard, or Managed with Parental Controls.



You should have only one or two administrator-level users, and your account is already an admin account.

**4. Type the name that you want to display for this account in the Name text box. Press Tab to move to the next field.**

Leopard displays this name on the Login screen, so behave! (For example, Bob has only one "o" the last time I checked.)



**5. (Optional) Although Leopard automatically generates the user's *short name* (for use in iChat, and for naming the user's Home folder), you can type a new one. (No spaces, please.) Press Tab again.**

**6. In the Password text box, type the password for the new account. Press Tab to move to the next field.**

Generally, I recommend a password of at least six characters, using a mixture of alpha and numeric characters.

Run out of password ideas? No problem! Click the key button (to the right of the Password text box) to display the Password Assistant, from which Leopard can automatically generate password suggestions of the length you specify. Click the Suggestion pop-up menu, or type directly into the field, and Leopard automatically adds the password you've generated into the Password field.

**7. In the Verify text box, retype the password you chose. Press Tab again to continue your quest.**

**8. (Optional) Leopard can provide a password hint after three unsuccessful login attempts. To offer a hint, type a short question in the Password Hint text box.**



From a security standpoint, password hints are taboo. (Personally, I **never** use 'em. If someone is having a problem logging in to a computer I administer, you better believe I want to know *why*.) Therefore, despite the recommendation Leopard shows here, I strongly recommend that you skip this field — and if you *do* offer a hint, **keep it vague!** Avoid hints like, “Your password is the name of the Wookiee in Star Wars.” *Geez.*

**9. Click the Create Account button.**

The new account shows up in the list at the left of the Accounts pane.

Each user’s Home folder has the same default subfolders, including Movies, Music, Pictures, Sites, and such. A user can create new subfolders within his or her Home folder at any time.

Here’s one more neat fact about a user’s Home folder: No matter what the account level, most of the contents of a Home folder can’t be viewed by other users. (Yes, that includes admin-level users. This way, everyone using your iMac gets her own little area of privacy.) Within the Home folder, only the Sites and Public folders can be accessed by other users — and only in a limited fashion. More on these folders later in this chapter.

## *Modifying user accounts*

Next, consider the basic modifications that you can make to a user account, such as changing existing information or selecting a new picture to represent that user’s unique personality.

To edit an existing account, log in with your admin account, display the System Preferences window, and click Accounts to display the account list. Then follow these steps:



**1. Click the account that you want to change.**

Don’t forget to unlock the Accounts pane if necessary. See the earlier section, “Adding users,” to read how.

**2. Edit the settings that you need to change.**

For example, you can reset the user’s password, or (if absolutely necessary) upgrade the account to admin level.

**3. Click the Picture well and then click a thumbnail image to represent this user (as shown in Figure 16-3).**





**Figure 16-3:**  
Pick the  
image that  
best  
represents  
a user.



An easy way to get an image is to use one from your hard drive. Click Edit Picture and then drag a new image from a Finder window into the Picture well. (Alternatively, you could click Edit Picture and then click the Snapshot button — which bears a tiny camera — to grab a picture from your iSight video camera. After you capture the essence of your subject as a photo, click Set to return to the Accounts pane.)

Leopard displays this image in the Login list next to the account name.

**4. When everything is correct, press  $\text{⌘}+\text{Q}$  to close the System Preferences dialog.**

Remember, there's no need to save your changes (as a separate step) within System Preferences. Leopard does that automatically when you close the System Preferences window.



Standard-level users have some control over their accounts — they're not helpless, ya know. Standard users can log in, open System Preferences, and click Accounts to change the account password or picture, as well as the *My Card* assigned to them in Leopard Address Book. All standard users can also set up Login Items, which I cover later in this chapter. Note, however, that managed users might not have access to System Preferences at all, so they can't make changes. (Read about this in the upcoming section, "Managing access settings for an account.")

## *I banish thee, Mischievous User!*

Not all user accounts last forever. Students graduate, co-workers quit, kids move out of the house (at last!), and Bob might even find a significant other who has a faster cable modem. We can only hope.

Anyway, no matter what the reason, you can delete a user account at any time. Log in with your admin account, display the Accounts pane in System Preferences, and then follow these steps to eradicate an account:

1. Click the account that you want to delete.
2. Click the Delete User button (which bears the Minus Sign of Doom). Refer to Figure 16-2.

Leopard displays a confirmation sheet, as shown in Figure 16-4. By default, the contents of the user's Home folder are saved in a disk image file — which you can restore with Disk Utility — in the Deleted Users folder. (This safety is a good idea if the user might return in the future, allowing you to retrieve their old stuff. However, this option is available only if you have enough space on your hard drive to create the Home folder image file.)

**Figure 16-4:** This is your last chance to save the stuff from a deleted user account.



3. To clean up completely, select the Delete the Home Folder radio button and then click OK.

Leopard wipes everything connected with the user account off your hard drive.

4. Press  $\text{⌘}+\text{Q}$  to close the System Preferences dialog.



Time once again for a Mark's Maxim:

*Always* delete unnecessary user accounts. Otherwise, you're leaving holes in your iMac's security.™

## *Setting up Login Items and Parental Controls*

Every account on your iMac can be customized. Understandably, some settings are accessible only to admin-level accounts, and others can be adjusted by standard-level accounts. In this section, I introduce you to the things that can be enabled (or disabled) within a user account.

### *Automating with Login Items*

*Login Items* are applications or documents that can be set to launch or load automatically as soon as a specific user logs in — for example, Apple Mail or Address Book. In fact, a user must be logged in to add or remove Login Items. Even an admin-level account can't change the Login Items for another user.



A user must have access to the Accounts pane within the System Preferences window in order to use Login Items. As you can read in the following section, a user can be locked out of System Preferences, which makes it more difficult for Login Items to be added or deleted for that account. (Go figure.)

To set Login Items for your account, follow these steps:

- 1. Click the System Preferences icon on the Dock and then click the Accounts icon.**
- 2. Click the Login Items tab to display the settings that you see in Figure 16-5.**
- 3. Click the Add button (with the plus sign) to display a file selection sheet.**
- 4. Navigate to the application you want to launch each time you log in, click it to select it, and then click Add.**  
  
If you're in the mood to drag and drop, just drag the applications you want to add from a Finder window and drop them directly into the list.
- 5. Press ⌘+Q to quit System Preferences and save your changes.**



Login Items are launched in the order that they appear in the list, so feel free to drag the items into any order you like.

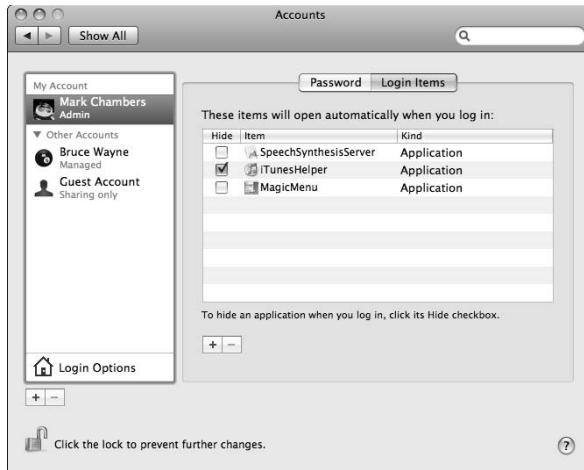

**Figure 16-5:**  
Add apps to  
your Login  
Items list.

### *Managing access settings for an account*

A standard-level account with restrictions is a managed account. (You can read about these accounts earlier in this chapter.) With these accounts, you can restrict access to many different places within Leopard and your iMac's applications via *Parental Controls*. (Naturally, admin-level accounts don't need Parental Controls because an admin account has no restrictions.)



In short, Parental Controls come in handy in preventing users — family members, students, co-workers, friends, or the public at large — from damaging your computer, your software, or Leopard itself. If an account has been restricted with Parental Controls, the account description changes from Standard to Managed in the Accounts list.

To display the Parental Controls for a standard account, start here:

- 1. Log in with an admin-level account.**
- 2. Open System Preferences and then click Accounts.**
- 3. Click the Standard account in the list and then select the Enable Parental Controls check box.**

Now click the Open Parental Controls button to display the specific categories (tabs) that you see in Figure 16-6:

- ✓ **System:** These settings (which I discuss in more detail in a second) affect what the user can do within Leopard as well as what the Finder itself looks like to that user.

✔ **Content:** These settings control the Dictionary and Safari applications. If you prefer that profane terms be hidden within the Dictionary for this user, select the Hide Profanity in Dictionary check box to enable it. Leopard also offers three levels of control for Web sites:

- *Allow Unrestricted Access:* Select this radio button to allow unfettered access for this user.
- *Try to Limit Access:* You can allow Safari to automatically block Web sites that it deems “adult.” To specify particular sites that Safari should allow or deny, click the Customize button.
- *Allow Access to Only These Websites:* Select this radio button to specify which Web sites that the user can view. To add a Web site, click the Add button (which bears a plus sign); Leopard then prompts you for a title and the Web site address.

✔ **Mail & iChat:** Select the Limit Mail and the Limit iChat check boxes to specify the e-mail and instant-messaging addresses that this user can communicate with. To add an address that the user can e-mail or chat with, click the Add button.

If you want a notification if the user is attempting to send an e-mail to someone not in the list, select the Send Permission Requests To check box to enable it and then type your e-mail address in the text box.



**Figure 16-6:**  
You don't have to be a parent to assign Parental Controls!

- ✔ **Time Limits:** Parents, click the Time Limits button, and you'll shout with pure joy! You can limit an account to a certain number of hours of usage per weekday (Weekday Time Limits), limit to a specified number of hours of usage per weekend day (Weekend Time Limits), and set a bedtime computer curfew time for both weekdays and weekend days.
- ✔ **Logs:** Leopard keeps a number of different types of *text log files* (which track where the user goes on the Internet, which applications are launched by the account, and the contents of any iChat conversations where the user was a participant). From this central pane, you can monitor all the logs for a particular account. Note that these logs are enabled or disabled from other locations within Leopard: For example, the log showing the Web sites visited and blocked is enabled from the Content panel that I describe a little earlier, whereas the applications log is enabled from the System panel. iChat logging is turned on from the Preferences dialog within the iChat application.



You can always tell whether an account has been assigned Parental Controls because the account description changes from Standard to Managed in the Accounts list.

Of particular importance are the System controls. Click the System tab to modify these settings:

- ✔ **Use Simple Finder:** The Simple Finder is a great idea for families and classrooms with smaller children. For the ultimate in restrictive Leopard environments — think public access or kiosk mode — you can assign the Simple Finder to an account. Even the Dock itself is restricted, sporting only the Finder icon, Trash, the Dashboard, and those folders that allow users to access their documents and applications.
- ✔ **Only Allow Selected Applications:** When this option is enabled, you can select the specific applications that appear to the user. These restrictions are in effect whether the user has access to the full Finder or just the Simple Finder.
  - *To allow access to all the applications of a specific type:* Select the check box next to the desired group heading to enable it. This includes iLife, iWork, Internet, Widgets, Other, and Utilities.
  - *To restrict access to all applications within a group:* If a group heading check box is enabled and you want to deny access to all the applications in that group, clear the check box next to the heading to disable it.
  - *To toggle restriction on and off for specific applications within these groups:* Click the triangle icon next to each group heading to expand its list and then either mark or clear the check box next to the desired applications. Leopard denotes partial access within a group — a mixture of full and restricted applications — with a dash mark in the group heading check box.



To locate a specific application, click in the Search box and type the application name.

- *To add a new application to the Allow list:* Drag its icon from the Finder and drop it in the list within the Other group. After you add an application, it appears in the Other group, and you can toggle access to it on and off like the applications in the named groups.

✔ **Can Administer Printers:** With this check box enabled, the user can modify the printers and printer queues within the Print & Fax pane in System Preferences. If disabled, the user can still print to the default printer and switch to other assigned printers, but can't add or delete printers.

✔ **Can Burn CDs and DVDs:** Disable this check box to prevent the user from recording CDs or DVDs via the built-in disc recording features in Mac OS X. (**Note:** If you load a third-party recording program, such as Toast, the user can still record discs with it.)

✔ **Can Change Password:** Enable this check box to allow the user to change the account password.



If you're creating a single standard-level account for an entire group of people to use — for example, if you want to leave the machine in kiosk mode in one corner of the office or if everyone in a classroom will use the same account on the machine — I recommend disabling the ability to change the account password. (Oh, and please do me a favor . . . *don't* create a system with just one admin-level account that everyone is supposed to use! Instead, keep your one admin-level account close to your bosom and create a standard-level account for the Unwashed Horde.)

✔ **Can Modify the Dock:** Enable this check box, and the user can add or remove applications, documents, and folders from the Dock in the full Finder. (If you don't want the contents of the Dock changing according to the whims of other users, it's a good idea to disable this check box.)

## Multiuser Rules for Everyone

After you're hip on user accounts and the changes you can make to them, turn to a number of topics that affect all users of your iMac — things like how they log in, how a user can share information with everyone else on the computer, and how each user account can be protected from unscrupulous outsiders with state-of-the-art encryption. (Suddenly you're James Bond! I told you Leopard would open new doors for you.)

## Logging on and off in Leopard For Dummies

Hey, how about the login screen itself? How do your users identify themselves? Time for another of my “Shortest books in the *For Dummies* series” special editions. (The title’s practically longer than the entire book.)

Leopard offers four methods of logging folks in to your multiuser iMac:



- ✓ **The username and password login:** This is the most secure type of login screen you’ll see in Leopard because you have to actually type your account username and your password. (A typical hacker isn’t going to know all the usernames on your iMac.) Press Return or click the Log In button to complete the process.

When you enter your username and password, you see bullets instead of your password because Leopard displays bullet characters to ensure security. Otherwise, someone could simply look over your shoulder and see your password.

- ✓ **The list login:** This login screen offers a good middle of the road between security and convenience. Click your account username in the list and type your password when the login screen displays the password prompt. Press Return or click the Log In button to continue.
- ✓ **Fast User Switching:** This feature, as shown in Figure 16-7, allows another user to sit down and log in while the previous user’s applications are still running in the background. This is perfect for a fast e-mail check or a scan of your eBay bids without forcing someone else completely off the iMac. When you turn on Fast User Switching, Leopard displays the currently active user’s name at the right side of the Finder menu bar.

To switch to another account

- Click the current user’s name in the Finder menu (refer to Figure 16-7).
- Click the name of the user who wants to log in.

Leopard displays the login window, just as if the iMac had been rebooted.

The previous user’s stuff is still running, so you definitely shouldn’t reboot or shut down the iMac!

To switch back to the previous user

- Click the username again in the Finder menu.
- Click the previous user’s name.

For security, Leopard prompts you for that account’s login password.





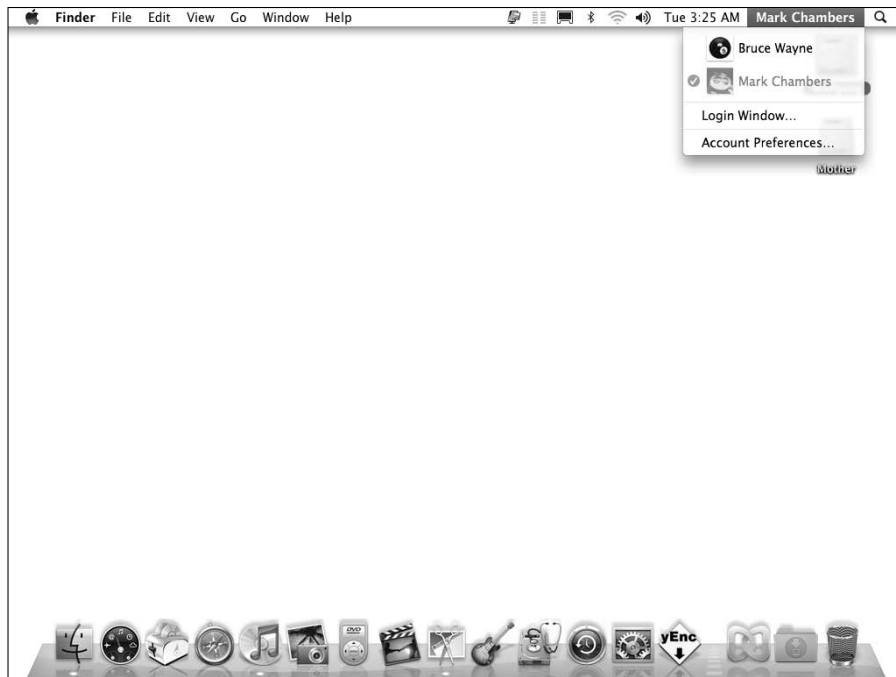

**Figure 16-7:**  
The Fast  
User  
Switching  
menu,  
unfurled for  
all to see.



➤ **Auto login:** This is the most convenient method of logging in but offers no security whatsoever. Leopard automatically logs in the specified account when you start or reboot your iMac.

I *strongly recommend* that you use auto login only if

- Your iMac is in a secure location.
- You are the only one using your iMac.
- You're setting up a public-access iMac, in which case you want your iMac to immediately log in with the public account.

Working in a public environment? **Never** set an admin-level account as the auto login account. This is the very definition of ASDI, or *A Supremely Dumb Idea*.

To set up a username/password or list login, open System Preferences, click the Accounts icon, and then display the Login Options settings (see Figure 16-8). Select the List of Users radio button for a list login screen, or select the Name and Password radio button to require your users to type their full username and password.

To enable Fast User Switching, mark the Enable Fast User Switching check box (as shown in Figure 16-8).

To set Auto Login, choose the account that Leopard should use from the Automatic Login pop-up menu (as shown by the now-legendary Figure 16-8).

Logging out of Leopard all the way (without Fast User Switching) is a cinch. Just click the Apple menu (🍏) and then choose Log Out. (From the keyboard, press ⌘+Shift+Q.) A confirmation dialog appears that will automatically log you off in one minute — but don't forget that if someone walks up and clicks Cancel, he'll be using your iMac with your account! Your iMac returns to the login screen, ready for its next victim. Heed this Mark's Maxim:



*Always click the Log Out button on the logout confirmation dialog before you leave your iMac.™*



**Figure 16-8:** Configure your login settings from the Login Options pane.

## Interesting stuff about sharing stuff

You might wonder where shared documents and files reside on your iMac. That's a good question. Like just about everything in Leopard, there's a simple answer. The Users folder on your iMac has a *Shared* folder within it. To share a file or folder, it should be placed in the Shared folder.



You don't have to turn on File Sharing in the Sharing pane of System Preferences to use Shared folders on your iMac. Personal File Sharing affects only network access to your machine by users of other computers.

Each user account on your iMac also has a *Public* folder within that user's Home folder. This is a read-only folder that other users on your iMac (and across the network) can access: They can only open and copy the files that it contains. (Sorry, no changes to existing documents from other users, or new documents from other users.) Every user's Public folder contains a *Drop Box* folder, where other users can copy or save files but can't view the contents. Think of the Drop Box as a mailbox where you drop off stuff for the other user.

## *Encrypting your Home folder can be fun*

Allowing others to use your iMac always incurs a risk — especially if you store sensitive information and documents on your computer. Although your login password should ensure that your Home folder is off limits to everyone else, consider an extra level of security to prevent even a dedicated hacker from accessing your stuff.

To this end, Leopard includes *FileVault*, which automatically encrypts the contents of your Home folder. Without the proper key (in this case, either your login password or your admin's master password), the data contained in your Home folder is impossible for just about anyone to read. (I guess the FBI or NSA would be able to decrypt it, but they're not likely a worry at your place!)

The nice thing about FileVault is that it's completely transparent to you and your users. In other words, when you log in, Leopard automatically takes care of decrypting and encrypting the stuff in your Home folder for you. You literally won't know that FileVault is working for you — which is how computers are *supposed* to work.

To turn on FileVault protection for a specific account, follow these steps:

- 1. Click the System Preferences icon on the Dock and then click the Security icon.**
- 2. Click the FileVault button.**
- 3. If necessary, click Set Master Password to create a master password.**



You need to be logged in with an admin-level account to set a master password. However, this needs to be done only once, no matter how many accounts you're hosting on your iMac. Using this master password, any admin-level user can unlock any Home folder for any user.



Before you move to Step 4, note that you must be logged in using the account that requires the FileVault protection. (Therefore, if you had to log in using your admin-level account to set a master password, you have to log out and log in again using the account you want to protect. Arrgh.)

4. Click the **Turn on FileVault** button.
5. Enter your account's login password when prompted and then click **OK**.
6. Click the **Turn on FileVault** button on the confirmation screen.
7. After Leopard encrypts your Home folder and logs you out, log in again normally.

You're done!



Remember those passwords. Again, **do not forget** your account login password, and make doggone sure that your admin user never forgets the master password! If you forget these passwords, you can't read anything in your Home folder, and even the smartest Apple support technician will tell you that nothing can be done.

## Chapter 17

# Building (Or Joining) a Network

---

### *In This Chapter*

- ▶ Considering the benefits of a network
  - ▶ Choosing between wired and wireless networks
  - ▶ Sharing an Internet connection
  - ▶ Gathering the stuff you need to network
  - ▶ Making the network connection
  - ▶ Using your network
  - ▶ Protecting your iMac with a firewall
- 

**I**n my book, network access ranks right up there with air conditioning and the microwave oven. Like other “I can’t imagine life without them” kinds of technologies, it’s hard to imagine sharing data from your iMac with others around you without a network. Sure, I’ve used a *sneakernet* (the old-fashioned term for running back and forth between computers with a floppy disk), but these days, Apple computers don’t even *have* floppy drives.

Nope, networking is here to stay. Whether you use it to share an Internet connection, challenge your friends to a nice relaxing game of WWII battlefield action, or stream your MP3 collection to other computers that use iTunes, you’ll wonder how you ever got along without one. In this chapter, I fill you in on all the details you need to know to get your iMac hooked up to a new (or an existing) network.

## *What Exactly Is the Network Advantage?*

If you have other family members with computers or if your iMac is in an office with other computers (including those rascally PCs), here’s just a sample of what you can do with a network connection:

- ✔ **Share an Internet connection.** This is *the* major reason why many families and most small businesses install a network. Everyone can simultaneously

use the same digital subscriber line (DSL) or cable Internet connection on every computer on the network.

- ✔ **Share a printer.** You say your fellow employee — or even worse, your big sister — has a great printer connected to their computer? Luckily, that printer can be shared with anyone across your network.
- ✔ **Copy and move files of all sizes.** Need to get a large iDVD project from one Mac to another? With a network connection, you can accomplish this task in just minutes. Otherwise you'd have to burn that file to a DVD-R or use an external hard drive. A network connection makes copying as simple as dragging the project folder from one Finder window to another.
- ✔ **Share documents across your network.** Talk about a wonderful collaboration tool. For example, you can drop a Word document or Keynote presentation file in your Public folder and ask for comments and edits from others in your office.
- ✔ **Stream music and video.** With iTunes, you can share your audio and video media collection on your iMac with other Macs and PCs on your network. Your eyes and ears can't tell the difference!
- ✔ **Play multiplayer games.** Invite your friends over and tell 'em that you're hosting a *LAN party* (the techno-nerd term for a large gathering of game players, connected through the same network, all playing the same multiplayer game. (Suddenly you'll see firsthand just how devious a human opponent can be.) Each participant needs to buy a copy of the same game, naturally, but the fun you'll have is worth every cent you spend. Don't forget the chips!

If your iMac isn't within shouting distance of an existing network or you don't plan on buying any additional computers, stop right here — a lone iMac hanging out in your home with no other computers around won't need a network.



If you have just your iMac and an Internet connection (either through a dialup modem or a high-speed DSL/cable modem) and you have no plans to add another computer or a network printer, a network isn't necessary.

## The Great Debate: Wired versus Wireless

After you decide that you indeed need a network for your home or office, you have another decision to make: Should you install a *wired* network (running cables between your computers) or a *wireless* network? Heck, should you throw caution completely to the wind and build a combination network with both wireless and wired hardware?

Your first instinct is probably to choose a wireless network for convenience. After all, this option allows you to eliminate running cables behind furniture (or in the ceiling of your office building). Ah, but I must show you the advantages to a wired network as well. Table 17-1 shows the lowdown to help you make up your mind.

<i>Factor</i>	<i>Wireless Networks</i>	<i>Wired Networks</i>
Speed	Moderate	Much faster
Security	Moderate	Better
Convenience	Better	Worse
Compatibility	Confusing standards	Easier to understand
Cables	Few (or none)	Required

As I call it, here are the advantages of choosing a wired or a wireless network setup:

✔ **Wired:** Using a wired network offers two significant perks over a wireless network:

- *Faster speeds:* In general, wired networks that are compatible with your iMac are many times faster than the fastest 802.11n wireless connections.

The performance of a wireless connection can be compromised by interference (from impeding structures, such as concrete walls; and from household appliances, such as some wireless phones and microwave ovens) and by distance.

- *Better security:* A wired network doesn't broadcast a signal that can be picked up outside your home or office, so it's more secure.

Hackers can attack through your Internet connection. Hence the section, "USE YOUR FIREWALL," later in this chapter.

✔ **Wireless:** A wireless connection really has only one advantage, but it's a big one: *convenience* (which, in this case, is another word for *mobility* for all your networked devices).

Accessing your network anywhere within your home or office — without cables — is so easy. You can also easily connect a wireless printer. And when using an AirPort Express mobile Base Station, even your home stereo can get connected to your MP3 collection on your iMac. Read more about Base Stations later on.



## Grafting wireless access to a wired network

Maybe you're caught in the middle, choosing between wired and wireless networking? Or perhaps you're already using a wired network but would be absolutely thrilled by the idea of sitting on your deck in the sunshine whilst checking your e-mail on your laptop, untethered. By combining both technologies, you can get the faster transfers of a wired network between all the computers in your office and the freedom you crave.

That is the configuration I use in my home office. I use a wireless base station that also includes a built-in wired switch, which is a very common feature in today's wireless routers and base stations. My family gets all the convenience a wireless network offers, and everyone can connect to the Internet from anywhere in our house. On the other hand, my office computers have the faster performance and tighter security of a wired network. *Sassy indeed!*

## Sharing Internet Access

Time to see what's necessary to share an Internet connection. In this section, I cover two methods of connecting your network to the Internet. (And before you open your wallet, keep in mind that you might be able to use your iMac to share your broadband connection across your network!)

### Using your iMac as a sharing device

Figure 17-1 illustrates how you can use your iMac to provide a shared Internet connection across a simple wireless network, using either

- ✓ A broadband DSL or cable connection
- ✓ An external USB dialup modem



I recommend sharing a dialup modem Internet connection *only* if you have no other option. A dialup modem connection really can't handle the data transfer speeds for more than one computer to access the Internet comfortably at one time. (In plain English, an external USB modem that you add to your iMac isn't fast enough for both you and your significant other to surf the Web at the same time.) Sharing a dialup connection just isn't practical.



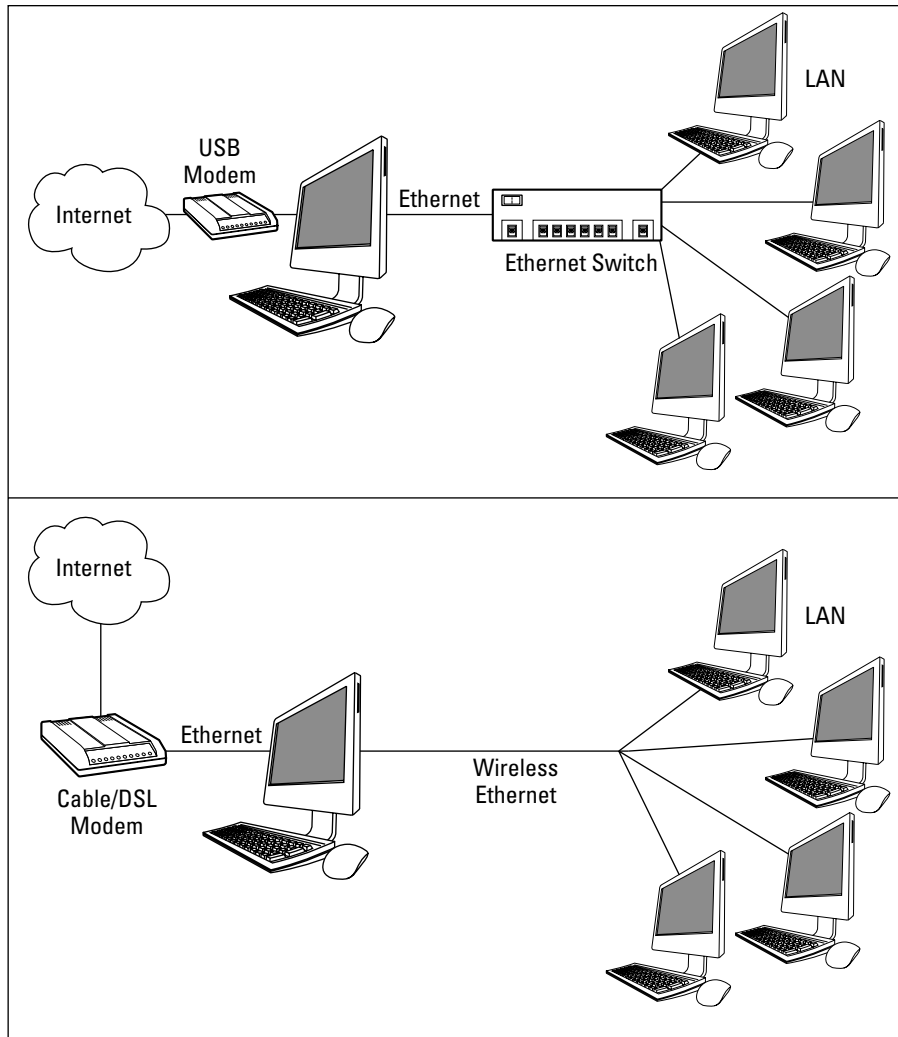

**Figure 17-1:** Share an Internet connection wirelessly via your iMac.

In either configuration, your iMac uses the Mac OS X Leopard built-in Internet connection-sharing feature to get the job done, *but your iMac must remain turned on to allow Internet sharing*. I show you how to do this in the upcoming section, “Network Internet connections,” later in this chapter.

## Using a dedicated Internet sharing device

Figure 17-2 illustrates how a broadband connection works if you use a dedicated Internet sharing device (often called an *Internet router*) to connect to your cable or DSL modem. You have to buy this additional hardware, but your iMac doesn't have to remain turned on just so everyone can get on the Internet.

Internet routers usually include either wired or wireless network connections — and many include both.

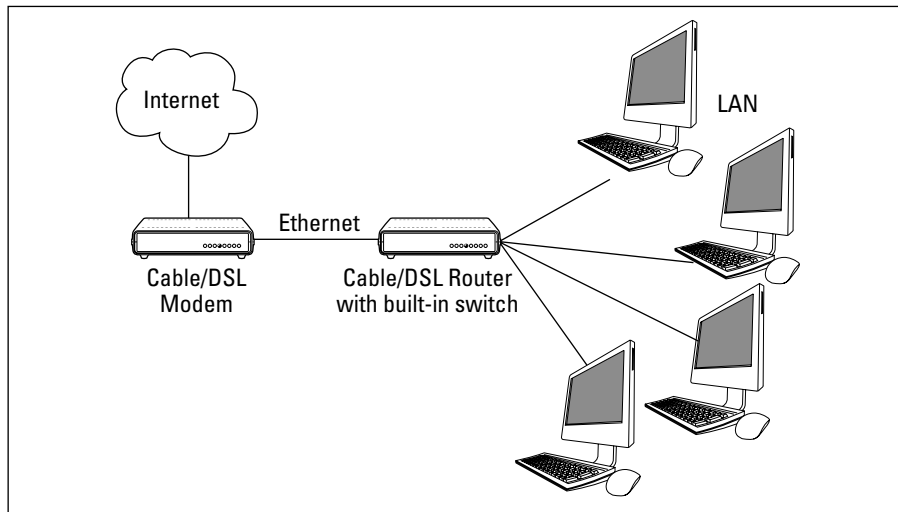

**Figure 17-2:**  
Share an Internet connection by using an Internet router.

Setting up an Internet router is usually a pretty simple matter, but the configuration depends on the device manufacturer and usually involves a number of different settings in System Preferences that vary according to the model of router you're installing. Grab a diet cola, sit down with the router's manual, and follow the installation instructions you'll find there. (In some cases, you may need to set up your cable or DSL modem as a *bridge* between your ISP and your router, which should be covered in your modem and router manuals as well.)



Most Internet routers offer a DHCP server, which automatically assigns Internet protocol (IP) addresses, and I **strongly** recommend that you turn on this feature! (You can read more on DHCP later in the chapter, in the sidebar titled, “The little abbreviation that *definitely* could.”)

## What Do I Need to Connect?

Most *normal* folks — whom I define as those who have never met a network system administrator, and couldn't care less — think that connecting to a network probably involves all sorts of arcane chants and a mystical symbol or two. In this section, I provide you with the shopping list that you need to set up a network — or connect to a network that's already running.

### Wireless connections

Today's iMacs come complete with a built-in AirPort Extreme wireless card, so if you already have an AirPort Extreme or Express Base Station, you're set to go. Otherwise, hold on tight while I lead you through the hardware requirements for wireless networking. (Kinda ironic, don't you think?)



The maximum signal range — and effectiveness — of any wireless network can be impeded by intervening walls or by electrical devices, such as microwave ovens and some wireless phones, all of which can generate interference.

#### **Connecting an iMac to an existing wireless network**

Connecting an Intel iMac to an existing wireless network requires no extra hardware because your hardware is already built in. (Whew. That was easy!)

#### **Using a base station to go wireless**

If you decide that you want to build your own wireless network, you eschew cables, or you want to add wireless support to your existing wired network, you need a *base station*. The base station can act as a bridge between computers using wireless and your existing wired network. Such a wireless base station will have either

- ✓ A port that can connect to your existing wired network's switch
- ✓ A full built-in switch for wired connectivity (which means you can sell your old wired Ethernet switch to your sister in Tucson)

And, of course, a base station can simply act as a central switch for your wireless network (with no support for a wired network at all).

You can use either a cool Apple Base Station or a boring 802.11n generic wireless base station; however, the Apple hardware requires less configuration and tweaking. (Sounds like a Mark's Maxim!)



If you don't want the hassle of tweaking PC hardware to accommodate your aluminum iMac, buy Apple hardware and software.™

### ***Apple Base Station models***

As listed in Table 17-2, your iMac can work with four different Apple Base Station models for wireless networking:

#### ✓ **AirPort Extreme**

I recommend using AirPort Extreme if your network needs an enhanced antenna, which provides greater range. You can read about connectivity ranges in the upcoming Table 17-2.

#### ✓ **AirPort Express (as shown in Figure 17-3)**

I recommend using AirPort Express if you want to

- *Carry your wireless base station with you.* Express is much smaller than the other Apple Base Station models. (Think “party on the patio” or a LAN gaming get-together at a friend’s house.)
- *Connect your home stereo for wireless music streaming.* You can use the AirTunes feature in iTunes.

**Figure 17-3:**  
The AirPort  
Express  
portable  
Base  
Station.

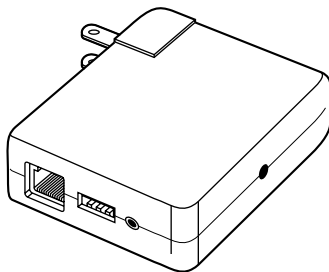

#### ✓ **Time Capsule**

Apple's Time Capsule unit isn't just a wireless remote hard drive: It can also act as a full AirPort Extreme Base Station. In fact, the wireless specifications for a Time Capsule unit and an AirPort Extreme Base Station are almost identical.

#### ✓ **AirPort (discontinued)**

You might find an original 802.11b or 802.11g AirPort Base Station on eBay or at a garage sale. Go ahead and pick it up if you want to save cash *unless* you're considering multiplayer gaming or using high-speed file transfers over your wireless network.



The 802.11n standard used by the AirPort Extreme, Time Capsule, and AirPort Express Base Stations delivers a connection that's several times faster than the old AirPort Base Station's 802.11b/802.11g standards. 802.11n is also compatible with *all* the older standards — 802.11b/a/g — so I highly recommend that you stick with 802.11n in the future. It plays well with others, and at warp speed to boot!

<i>Feature</i>	<i>AirPort Extreme/ Time Capsule</i>	<i>AirPort Express</i>	<i>AirPort</i>
Price	\$180/\$299	\$99	\$40 (used)
Users (maximum)	50	10	50
802.11n support	Yes	No	No
802.11g support	Yes	Yes	No
802.11b support	Yes	Yes	Yes
LAN Ethernet jack (high-speed Internet connection)	Yes	Yes	Yes
WAN Ethernet jack (wired computer network)	Yes	No	No
Stereo mini-jack	No	Yes	No
USB printer port	Yes	Yes	No
Maximum signal range (approximate)	150 feet (standard) 250 feet (with add- on antenna)	150 feet	100 feet
AC adapter	Separate on AirPort Extreme/ built-in on Time Capsule	Built-in	Separate



The names of the Apple Base Stations are irritatingly similar; Apple usually does a better job differentiating their product names. Jot down the name of your model on a Stickey on your iMac's Desktop just so you don't get confused.

Installing an Apple Base Station is simple:

1. **If you have a DSL or cable modem, connect it to the Ethernet LAN port on the Base Station with an Ethernet cable.**
2. **If you have an existing wired Ethernet computer network using a switch or router, connect it to the WAN (wide area network) port on the Base Station with an Ethernet cable.**



Only the AirPort Extreme and Time Capsule stations have a WAN port.

3. **If you have a USB printer, connect it to the USB port on the Base Station.**

As I mention in Table 17-2, older AirPort base stations didn't have USB ports.

I cover the steps to share a printer in the upcoming section, "Sharing a network printer."



4. **Connect the power cable from the AC power adapter.**

The AirPort Express and Time Capsule units have a built-in AC adapter, so if you're using one of these models, just plug the device itself into the wall.

5. **Switch on your Base Station.**

6. **Run the installation software provided by Apple on your iMac.**

### Using non-Apple base stations

If any company other than Apple manufactured your wireless base station, the installation procedure is almost certainly the same. (Naturally, you should take a gander at the manufacturer's installation guide just to make sure, but I added many different brands of these devices and used the same steps for each one.)

However, I should note that Apple wireless hardware uses a slightly different security encryption standard than most PC wireless hardware, which results in an extra hurdle when connecting to a non-Apple base station with your iMac. (More on this in the next section. For now, just remember that I recommend using Apple wireless hardware with your iMac whenever possible. It's just a little easier!)

### Joining a wireless network

As far as I'm concerned, the only two types of base stations on the planet are Apple and non-Apple (which includes all 802.11n and 802.11g Base Stations and access points). In these two sections, I relate what you need to know to get onboard, using either type of hardware.

### Apple AirPort Base Stations

To join a wireless network that's served by any flavor of Apple Base Station, follow these steps on each Mac with wireless support:

1. Click the **System Preferences icon on the Dock.**
2. Click the **Network icon.**
3. **From the Connection list on the left, click AirPort.**
4. **Mark the Show AirPort Status in Menu Bar check box.**
5. **Click the Apply button.**
6. **Press ⌘+Q to quit System Preferences and save your settings.**
7. **Click the AirPort status icon (which looks like a fan) on the Finder menu bar.**
8. **From the AirPort menu, choose an existing network connection that you'd like to join.**



The network name is the same as the network name you chose when you set up your AirPort Base Station.

9. **If you set up a secure network, enter the password you assigned to the network during setup.**

By the way, security is always A Good Thing, and I strongly recommend that you enable the password encryption features of your Apple Base Station while installing it! (Luckily, the Apple Base Station setup application leads you through this very process.) In the words of an important Mark's Maxim



Keep uninvited guests out of your network! Use your base station's security features and encrypt your data!™

Some wireless networks might not appear in your AirPort menu list. These are *closed networks*, which can be specified when you set up your AirPort Base Station. You can't join a closed network unless you know the exact network name (which is far more secure than simply broadcasting the network name). To join a closed network, follow these steps:

1. **Select Join Other Network from the AirPort menu.**

To open the menu, click the AirPort status icon (which looks like a fan) on the Finder menu bar.
2. **Type the name of the network.**
3. **If the network is secured with WEP or LEAP encryption — the two most popular security standards for protecting your data through encryption — click the Security pop-up menu and select which type of encryption is being used.**
4. **Enter the network password, if required.**

To disconnect from an AirPort network, click the AirPort menu and either

- ✓ **Choose Turn AirPort Off.**
- ✓ **Connect to another AirPort network.**

In other words, if you choose another available AirPort network from the AirPort menu, your iMac will automatically drop the previous connection. (You can only be connected to one wireless network at a time, which makes Good Sense.)

### *Using non-Apple Base Stations*

If you're using your iMac to connect to a non-Apple base station, you might need to follow a specific procedure that takes care of the slightly different password functionality used by standard 802.11b/g/n hardware.

Leopard can take care of many potential wireless “language barriers” caused by security encryption — the two most common forms are WEP and LEAP — so whether you need to massage your password to connect to your non-Apple base station depends on the specific hardware and encryption system that it uses.

To read or print the latest version of this procedure, fire up Safari and visit <http://kbase.info.apple.com/index.html>, searching on the number 106250. (This is the Apple Knowledge Base article number, which you can type in the first search field.) This article provides the details on how to convert a standard wireless encrypted password to a format that your AirPort Extreme hardware can understand.

## *Wired connections*

If you're installing a wired network, your iMac already comes with most of what you need for joining your new cabled world. You just connect the hardware and configure the connection. Don't forget that you also need cables (check the sidebar, “Can I save money by making my own cables?”) and an inexpensive Ethernet switch. (If you're using an Internet router or other hardware sharing device, it almost certainly has a built-in 4 or 8-port switch.)

### *Connecting iMac hardware to a wired network*

Your Ethernet 10/100/1000 port (which looks like a slightly oversized modem port) is located in the line of ports on the back of your iMac, ready to accept a standard Ethernet Cat5/Cat5E cable with RJ-45 connectors. If you're connecting to an existing wired network, you need a standard Cat5/Cat5E Ethernet cable of the necessary length. I recommend a length of no more than 25 feet because cables longer than 25 feet are often subject to line interference (which can slow down or even cripple your connection). You also need a live Ethernet port from the network near your iMac. Plug the cable into your iMac, and then plug the other end into the network port.



### *Wired network hardware*

If you don't know your switch from your NIC, don't worry. Here, I provide you with a description of the hardware that you need for your wired network.

### *Wired network components*

If you're building your own wired network, you need



- ✓ **A switch:** This gizmo's job is to provide more network ports for the other computers in your network. They typically come in 4- and 8-port configurations.

As I mention earlier in this chapter, most Internet routers (sometimes called *Internet sharing devices*) include a built-in switch, so if you've already invested in an Internet router, make doggone sure that it doesn't already come equipped with the ports you need before you go shopping for a switch!

- ✓ **A number of Ethernet cables:** Exactly how many cables you need is determined by how many computers you're connecting. If you're working with a gigabit Ethernet system, you need Cat5E or Cat6 cables. Cat6 cables provide better performance, but they are more expensive.



## Can I save money by making my own cables?

You can either purchase premade Cat5 cables (or Cat5E for gigabit Ethernet), or you can **try** to make your own. However, you most definitely *don't* save money by making your own cables — at least, not if you're connecting computers that are located within 25 feet or so of one another. I strongly recommend that you buy premade Cat5/5E Ethernet cables (which come in a number of standard lengths) for two very important reasons:

- ✓ **You can be guaranteed that your cables work.**
- ✓ **You don't have to build the things yourself.**

Nothing is harder to troubleshoot than a shorted or faulty Ethernet cable — that's the voice of experience talking there.

If you're wiring multiple rooms in your house or office, you have to install your own cabling. That's when I suggest you either call your local computer store for help or enlist the aid of someone you know who has successfully installed Ethernet cable. If you're building a home, you can get your home wired for an Ethernet network at the same time as the AC wiring is installed. (This route is expensive, but if you're a computer maven, you'll budget that cost!)



Naturally, if you're using a broadband Internet connection, you also have a DSL or cable modem. These boxes always include a port for connecting to your wired Ethernet network. (If you have one of the new breed of *wireless* modems — which acts as a wireless base station — don't panic because it should also have a wired port for connecting to your existing switch.)

### ***Wired network connections***

After you assemble your cables and your router or switch, connect the Ethernet cables from each of your computers to the router or switch, and then turn on the device. (Most need AC power to work.) Check the manual that comes with your device to make sure that the lights you're seeing on the front indicate normal operation. (Colors vary by manufacturer, but green is usually good.)

Next, connect your cable or DSL modem's Ethernet port to the WAN port on your switch with an Ethernet cable. If your modem isn't already on, turn it on now and check for normal operation.

When your router or switch is powered on and operating normally, you're ready to configure Mac OS X for network operation. Just hop to the upcoming section, "Connecting to the Network." (How about that? Now you can add network technician to your rapidly growing computer résumé!)

### ***Joining a wired Ethernet network***

After all the cables are connected and your central connection gizmo is plugged in and turned on, you've essentially created the hardware portion of your network. Congratulations! (Now you need a beard and suspenders.)

With the hardware in place, it's time to configure Leopard. In this section, I assume that you're connecting to a network with an Internet router or switch that includes a DHCP server. (Jump to the sidebar, "The little abbreviation that *definitely* could," for more on DHCP.)

Follow these steps on each Mac running Mac OS X that you want to connect to the network:

- 1. Click the System Preferences icon on the Dock.**
- 2. Click the Network icon (under Internet & Network).**
- 3. From the Connection list on the left, click Ethernet.**
- 4. Click the Configure pop-up menu (see Figure 17-4) and choose Using DHCP.**

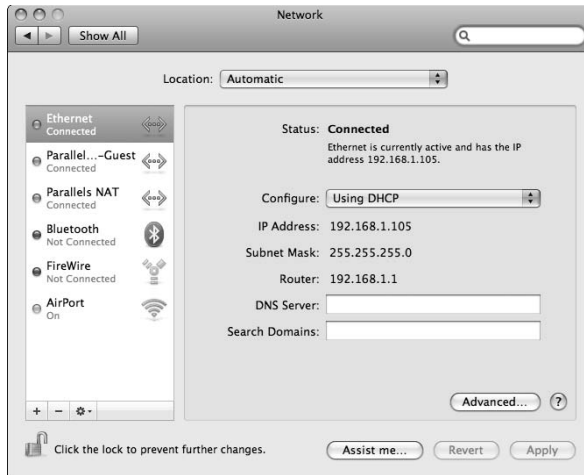

**Figure 17-4:**  
All hail  
DHCP, the  
magical  
networking  
fairy!

#### 5. Click the Apply button.

The Apply button is grayed out in the figure because my Status (in this dialog) is Connected.



Enjoy the automatic goodness as Mac OS X connects to the DHCP server to obtain an IP address, a subnet mask, a gateway router IP address, and a Domain Name System (DNS) address. (Without a DHCP server, you'd have to add all this stuff manually. Ugh.)

A few seconds after clicking the Apply button, you should see the information come up. You might also notice that the DNS Server field is empty, but fear not because Mac OS X is really using DNS Server information provided by the DHCP server.

#### 6. Press **⌘+Q** to quit System Preferences and save your settings.

You're on!

## Connecting to the Network

All right! The hardware is powered up, the cables (if any) are installed and connected, and you configured Leopard. You're ready to start (or join) the party. In this section, I show you how to verify that you're connected as well as how to share data and devices with others on your network.

## The little abbreviation that *definitely* could

You know, some technologies are just *peachy*. (So much for my uber-tech image.) Anyway, these well-designed technologies work instantly, you don't have to fling settings around like wrapping paper on Christmas day, and every computer on the planet can use them: Mac, Windows, Linux, and even the laptops used by funny-looking folks from Roswell, New Mexico.

*Dynamic Host Configuration Protocol*, or DHCP for short, is about as peachy as it gets. This protocol enables a computer to automatically get all the technical information necessary to join a network. Let me hear you say, "*Oh yeah!*" Just about every network device on the planet can use DHCP these days, including Internet routers, hubs, switches, and (go figure) Mac OS X. Today's networking hardware and operating systems provide a *DHCP server*, which flings the proper settings at every computer on the network all by itself. Your Mac just accepts the settings and relaxes in a placid networking nirvana.

In this book, you can bet the farm that I assume you want to use DHCP and that your network hardware supports it as well. That way, I won't spend 30 pages of this book leading you through the twisting alleyways of manual network settings. (If you're really into such things, I spend those 30 pages and explain every single technomagic detail in my book *Mac OS X Leopard All-in-One Desk Reference For Dummies*, [Wiley]. It's about 800 pages long — hence the comprehensive angle.)

If you're connecting to an existing network, tell the network administrator that you're taking the easy route and using DHCP. One word of warning, however: Adding more than one DHCP server on a single network causes a civil war, and your system will lock up tight. Therefore, before adding hardware with a DHCP server to an existing network, ask that network administrator to make sure that you aren't making a mistake.

## Verifying that the contraption works

After you have at least two computers on a wired or wireless network, test whether they're talking to each other over the network by *pinging* them. (No, I didn't make up the term, honest.) Essentially, pinging another computer is like yelling, "Are you there?" across a crevasse.

To ping another computer on the same network from any Mac running Leopard, follow these steps:

1. **Open a Finder window, click Applications, and then click Utilities.**
2. **Double-click the Network Utility icon to launch the application.**
3. **Click the Ping tab; see upcoming Figure 17-5.**
4. **In the Please Enter the Network Address to Ping text field, enter the IP address of the computer that you want to ping.**

- If you're pinging another Mac running Mac OS X, you can get the IP address of that machine by simply displaying its Network pane within System Preferences, which always displays the IP address.
- If you're trying to ping a PC running Windows and you don't know the IP address of that machine, follow these steps:
  - a. Click Start, right-click My Network Places (XP)/Network (Vista) and then choose Properties.
  - b. From the Network Connections window, right-click your Local Area Network connection icon and then choose Status.
  - c. Click the Support tab.

The IP address of that PC is proudly displayed.

**5. Select the Send Only x Pings radio button and enter 5 in the text field.**

**6. Click the Ping button.**

- *Yay!* If everything is working, you should see results similar to those shown in Figure 17-5, in which I'm pinging my Windows server at IP address 192.168.1.103, across my wired Ethernet network.

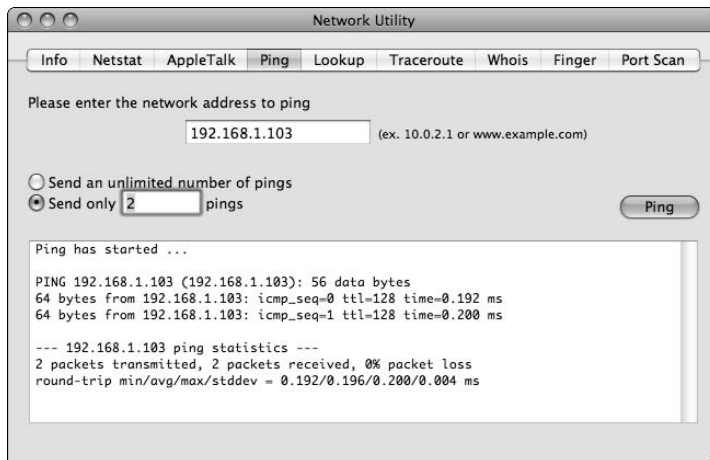

**Figure 17-5:**  
Look, Ma,  
I'm pinging!



The address 192.168.1.xxx is a common series of local network IP addresses provided by Internet routers, hubs and switches with DHCP servers, so don't freak if you have the same local IP address.

- *Nay!* If you *don't* get a successful ping, check your cable connections, power cords, and Mac OS X settings. Folks using a wireless connection might have to move closer to the network base station to connect successfully, especially through walls.

## *Sharing stuff nicely with others*

It works . . . by golly, it works! Okay, now what do you *do* with your all-new shining chrome network connection? Ah, my friend, let me be the first to congratulate you, and the first to show you around! In this section, I cover the most popular network perks. (And the good news is that these perks work with both wired and wireless connections.)

### *Network Internet connections*

If your DSL or cable modem plugs directly into your iMac (rather than a dedicated Internet sharing device or Internet router), you might ponder just how the other computers on your network can share that spiffy high-speed broadband connection. If you're running a wireless network, it comes to the rescue!

Follow these steps to share your connection wirelessly:

- 1. Click the System Preferences icon on the Dock.**
- 2. Click the Sharing icon (under Internet & Network).**
- 3. Click the Internet Sharing entry in the Services list to the left of the pane.**
- 4. From the Share Your Connection From pop-up menu, choose Ethernet.**
- 5. Mark the AirPort check box (in the To Computers Using list).**

Leopard displays a warning dialog stating that connection sharing could affect your Internet service provider (ISP) or violate your agreement with your ISP. I've never heard of this actually happening, but if you want to be sure, contact your ISP and ask the good folks there.

- 6. Click Start in the warning dialog to continue.**
- 7. Select the On check box next to the Internet Sharing entry in the Services list.**
- 8. Click the Close button to exit System Preferences.**



Sharing an Internet connection (without an Internet router or dedicated hardware device) through Mac OS X requires your iMac to remain on continuously. This is no big deal if you're using your iMac as a Web server — and your iMac has absolutely no problem remaining on ad infinitum — but tell others in your office or your home that the svelte iMac must remain on, or they'll lose their Internet connection!



If your iMac has an external USB modem, you can indeed share a dialup modem Internet connection. Just don't be too surprised if you quickly decide to shelve the idea. Those dinosaurs are s-l-o-w beyond belief.

Don't forget that you won't need to configure Internet sharing if your DSL or cable modem connects to a dedicated sharing device or router. That snazzy equipment automatically connects your entire network to the Internet.

### *Network file sharing*

You can swap all sorts of interesting files with other Macintosh computers on your network. When you turn on Personal File Sharing, Leopard lets all Macs on the network connect to your iMac and share the files in your Public folder. (**Note:** Sharing across a network is different from sharing a single computer betwixt several people. I cover that environment in Chapter 16.)

Follow these steps to start sharing files and folders with others across your network:

- 1. Click the System Preferences icon on the Dock.**
- 2. Click the Sharing icon.**
- 3. Select the On check box next to the File Sharing service entry to enable the connections for Mac and Windows sharing.**

Other Mac users can connect to your computer by clicking Go in the Finder menu and choosing the Network menu item. The Network window appears, and your iMac is among the choices. If the other Macs are running Leopard, your iMac's shared files and folders appear in a Finder window, and they're listed under the Shared heading in the Sidebar.

Windows XP users should be able to connect to your Mac from their My Network Places window, and Vista users can use the Network window. (Users of pre-XP versions of Windows, head to the Network Neighborhood.) Those lucky Windows folks also get to print to any shared printers you've set up. (The following section covers shared printers.)

- 4. Click the Close button to exit System Preferences.**



Leopard conveniently reminds you of the network name for your iMac at the bottom of the Sharing pane.

### *Sharing a network printer*

Boy, howdy, do I love describing easy procedures, and sharing a printer on a Mac network ranks high on the list! You can share a printer that's connected to your iMac (or your AirPort Extreme, Time Capsule, or AirPort Express Base Station) by following these very simple steps:

- 1. Click the System Preferences icon on the Dock.**
- 2. Click the Sharing icon.**

3. Select the **On** check box next to the **Printer Sharing** service entry.
4. From the list at the right of the **System Preferences** window, select the printer you want to share.
5. Click the **Close** button to exit **System Preferences**.

A printer that you share automatically appears in the Print dialog on other computers connected to your network.

### *Running a Web site from a network*

Web jockeys tell you that Mac OS X is a great platform for running a Web site that you can access from either the Internet or your local network. In fact, it's ridiculously easy to engage the mind-boggling power of Leopard's built-in Apache Web server. (Keep in mind, however, that your iMac must always be on and connected to the Internet, or your Web pages won't be available to your folks in Schenectady.)

To begin serving Web pages, follow these steps:

1. Click the **System Preferences** icon on the **Dock**.
2. Click the **Sharing** icon.
3. Select the **On** check box next to the **Web Sharing** service entry.
4. Click the **Close** button to exit **System Preferences**.

To check out the default HTML page that ships with Apache, open the System Preferences Sharing pane again and click the link that appears under the heading **Your Computer's Website**. Note that Leopard also creates a personal Web site under your username, which is different from the default Web site created by Apache. Click the link under the heading **Your Personal Website** to display this page.

To add pages to your Web server, navigate to the **Sites** folder that resides in your **Home** folder. Because this is the root of your Apache Web server, the files that you add to this folder are accessible from your Web server.



Don't forget that folks connecting to your Web site across the Internet must use your public IP address! Your iMac's IP address appears in the Built-in Ethernet description on the Network pane in System Preferences. If you're using an Internet router or Internet connection sharing device, your *public* IP address might be different, so the links on the Web Sharing pane might not work for folks outside your local network. Check the documentation for the device to determine how to find your actual public IP address. Also, your router or sharing device might require you to specify which computer on your network is to receive HTTP (Web) page requests and send the pages. Again, this should be covered in the device manual.



# USE YOUR FIREWALL!

Yep. That's the only heading in this entire book that's all upper case. It's that important.

The following Mark's Maxim, good reader, isn't a request, a strong recommendation, or even a regular Maxim — consider it an **absolute commandment** (right up there with *Get an antivirus application now*).



Turn on your firewall ***now***.™

When you connect a network to the Internet, you open a door to the outside world. As a consultant to several businesses and organizations in my hometown, I can tell you that the outside world is chock-full of malicious individuals who would *dearly love* to inflict damage on your data or take control of your iMac for their own purposes. Call 'em hackers, call 'em delinquents, or call 'em something I can't repeat, but *don't let them in!*

Leopard comes to the rescue again with the built-in firewall within Mac OS X. When you use this, you essentially build a virtual brick wall between you and the hackers out there (both on the Internet, and even within your local network). Follow these steps:

1. **Click the System Preferences icon on the Dock.**
2. **Click the Security icon.**
3. **Click the Firewall tab.**
4. **Select the Allow Only Essential Services radio button to activate your firewall.**
5. **Click the Advanced button.**
6. **Select the Enable Stealth Mode check box.**

This is an important feature that prevents hackers from *trolling* for your iMac on the Internet — or, in normal-speak, searching for an unprotected computer — so it's much harder for them to attack you.

7. **Click OK.**
8. **Click the Close button to exit System Preferences.**

Leopard even keeps track of the Internet traffic that you *do* want to reach your iMac, such as Web page requests and file sharing. When you activate one of the network features that I demonstrate in the preceding section, Leopard automatically opens a tiny hole (called a *port* by net-types) in your firewall to allow just that type of communication to your iMac.

For example, if you decide to turn on Web Sharing (as I demonstrate earlier), Leopard automatically allows incoming Web access.

You can also add ports for applications that aren't on the firewall's Allow list. This includes third-party Instant Messaging clients, multiplayer game servers, and the like. Depending on the type of connection, Leopard will often automatically display a dialog prompting you for confirmation before allowing certain traffic, so most folks won't need to do anything manually.

However, you *can* add a program manually to your list of allowed (or blocked) Firewall ports. Follow these steps:

- 1. Click the System Preferences icon on the Dock.**
- 2. Click the Security icon.**
- 3. Click the Firewall tab.**
- 4. Click the Add button.**

Leopard displays a standard File browsing sheet.

- 5. Browse to the application that requires access to the outside world — or the application that you want to block from outside communication — and click it to select it.**
- 6. Click the Add button in the File sheet.**

The application appears in the Firewall list. By default, it's set to Allow Incoming Connections.

- 7. If you want to block any incoming communication to the application, click the Allow Incoming Connections pop-up menu and choose Block Incoming Connections instead.**
- 8. Click the Close button to exit System Preferences.**

## Part VI

# The Necessary Evils: Troubleshooting, Upgrading, Maintaining

The 5<sup>th</sup> Wave

By Rich Tennant



"It all started when I began surfing the Web  
for 'Baked Alaska' and frozen custards..."

## *In this part . . .*

**N**o computer is *completely* trouble-free — and if your iMac starts acting strangely, the troubleshooting tips you find in this part can help you get your favorite machine back to normal. I also provide you with all the guidance you need to maintain your iMac properly, and step-by-step instructions for upgrading your computer with goodies like additional RAM or external devices.

## Chapter 18

# It Just . . . Sits . . . There

---

### *In This Chapter*

- ▶ Avoiding the blame (righteously)
  - ▶ Putting basic troubleshooting precepts to work
  - ▶ Using Mark's Troubleshooting Tree
  - ▶ Getting help
- 

**I**wish you weren't reading this chapter.

Because you are, I can only surmise that you're having trouble with your iMac, and that it needs fixing. (The other possibility — that you just like reading about solving computer problems — is more attractive, but much more problematic.)

Consider this chapter a crash course in the logical puzzle that is computer *troubleshooting*: namely, the art of finding out What Needs Fixing. You also see what you can do when you just plain can't fix the problem by yourself.

Oh, and you're going to encounter a lot of Tips and Mark's Maxims in this chapter — all of them learned the hard way, so I recommend committing them to memory on the spot!

## *Can You Troubleshoot? Yes, You Can!*

Anyone can troubleshoot. Put these common troubleshooting myths to rest:

- ✓ **It takes a college degree in computers to troubleshoot.** Tell that to my troubleshooting kids in junior high. They'll think it's a hoot because they have Apple computers of their own in the classroom. You can follow all the steps in this chapter without any special training.
- ✓ **I'm to blame.** Ever heard of viruses? Failing hardware? Buggy software? Any of those things can be causing the problem. Heck, even if you do



something by accident, I'm willing to bet it wasn't on purpose. It's Mark's Maxim time:

Don't beat yourself up — your iMac can be fixed.™

- ✓ **I need to buy expensive utility software.** Nope. You can certainly invest in a commercial testing and repair utility if you like. My favorite is TechTool Pro from Micromat ([www.micromat.com](http://www.micromat.com)), but a third-party utility isn't a requirement for troubleshooting. (I would, however, consider an antivirus application as a must-have, and you should have one already. Hint, hint.)
- ✓ **There's no hope if I can't fix it.** Sure, parts fail, and computers crash, but your Apple Service Center can repair just about any problem. And (ahem) if you backed up your iMac (like I preach throughout this book), you'll keep that important data (even if a new hard drive is in your future).
- ✓ **It takes forever.** Wait until you read the Number One Rule in the next section; the first step takes but 30 seconds and often solves the problem. Naturally, not all problems can be fixed so quickly, but if you follow the procedures in this chapter, you should fix your iMac (or at least know that the problem requires outside help) in a single afternoon.

With those myths banished for good, you can get down to business and start feeling better soon.

## *Basic Troubleshooting 101*

In this section, I walk you through my Should-Be-Patented Troubleshooting Tree as well as the Leopard built-in troubleshooting application, Disk Utility. I also introduce you to a number of keystrokes that can make your iMac jump through hoops.

### *The Number One Rule: Reboot!*

Yep, it sounds silly, but the fact is that rebooting your iMac can often solve a number of problems. If you're encountering these types of strange behavior with your iMac, a reboot might be all you need to heal

- ✓ Intermittent problems communicating over a network
- ✓ A garbled screen, strange colors, or screwed-up fonts
- ✓ The Swirling Beach Ball of Doom that won't go away after several minutes
- ✓ An application that locks up
- ✓ An external device that seems to disappear or can't be opened



To put it succinctly, here's a modest Mark's Maxim:

Always try a reboot before beginning to worry. *Always.*<sup>TM</sup>



If you're in the middle of a document, try to save all your open documents before you reboot. That might not be possible, but try to save what you can.

If you need to force a *locked* application (one that's not responding) to quit so you can reboot, follow these steps to squash that locked application:

**1. Click the Apple () menu and choose Force Quit.**

The dialog that you see in Figure 18-1 appears on your screen.

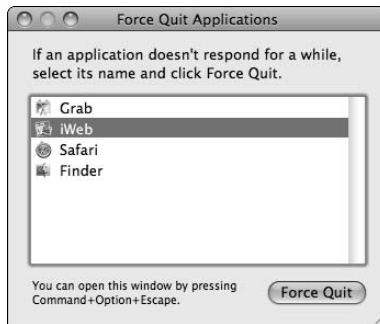

**Figure 18-1:**  
Force a  
recalcitrant  
application  
to take off.

**2. Click the offending application and then click the Force Quit button.**

If you can get everything to quit, you should be able to click the Apple menu and choose Shut Down (not Restart) without a problem.

If your iMac simply won't shut down (or you can't get the offending application to quit), then do what must be done:

**1. Press and hold your iMac Power button until it shuts itself off.**

You have to wait about four seconds for your iMac to turn itself off.

**2. Wait about ten seconds.**

**3. Press the Power button again to restart the computer.**



Note that you should not simply pull your iMac's power cord out of the AC socket (or turn off your power strip) to turn it off — pressing and holding the power switch on your iMac is a less destructive path to the same end.



## Why is rebooting so darned effective?

Rebooting fixes problems because it resets *everything*. Your network connection, for example, might be acting up or have timed out, and rebooting restores it. Rebooting also fixes problems due to brownouts or those notorious AC

power flickerings that we all notice from time to time. Such interruptions in constant juice might not bother you or me (or your less-intelligent toaster), but they can play tricks on your iMac that rebooting will fix.

After everything is back up, check whether the problem is still apparent. If you use your iMac for an hour or two and the problem doesn't reoccur, you likely fixed it!

## Special keys that can come in handy

A number of keys have special powers over your iMac. No, I'm not kidding! These keys affect how your iMac starts up, and they can really come in handy whilst troubleshooting.

### Using Safe Boot mode

You can use Safe Boot mode to force Leopard to run a directory check of your boot hard drive and disable any Login Items that might be interfering with Leopard. Use the Shut Down menu item from the Apple () menu to completely turn off your iMac, press the Power button to start the computer. Then press and hold down the Shift key immediately after you hear the startup tone. After Leopard has completely booted, restart your iMac again (this time without the Shift key) to return to normal operation.

### Startup keys

Table 18-1 provides the lowdown on startup keys. Hold the indicated key down either *when you push your iMac Power button* or *immediately after the screen blanks during a restart*. (As I just mentioned, the Shift key is the exception; it should be pressed and held down after you hear the startup tone.)

Table 18-1 Startup Keys and Their Tricks	
Key	Effect on Your iMac
C	Boots from the CD or DVD that's loaded in your optical drive
Media Eject	Ejects the CD or DVD in your optical drive



<b>Key</b>	<b>Effect on Your iMac</b>
Option	Displays a system boot menu, allowing you to choose the operating system
Shift	Prevents your Login Items from running; runs a directory check
T	Starts your iMac in FireWire Target Disk mode
⌘+V	Show Mac OS X Console messages
⌘+S	Starts your iMac in Single User mode
⌘+Option+P+R	Resets Parameter RAM (PRAM)

Some of the keys/combinations in Table 18-1 might never be necessary for your machine, but you might be instructed to use them by an Apple technician. I'll warrant that you'll use at least the C startup key fairly often.

## *All hail Disk Utility, the troubleshooter's friend*

Leopard's *Disk Utility* is a handy tool for troubleshooting and repairing your hard drive. You can find it in the Utilities folder within your Applications folder.

Fire up Disk Utility and click the First Aid tab to bring up the rather powerful-looking window shown in Figure 18-2.



### **Danger, Will Robinson!**

Many Disk Utility functions can actually **wipe your hard drives clean of data** instead of repairing them! These advanced functions aren't likely to help you with troubleshooting a problem with your existing volumes anyway.

**Remember:** *Don't* use these Disk Utility functions unless an Apple technician *tells* you to use them:

- ✓ Partitioning and erasing drives
- ✓ Setting up RAID arrays
- ✓ Restoring files from disk images

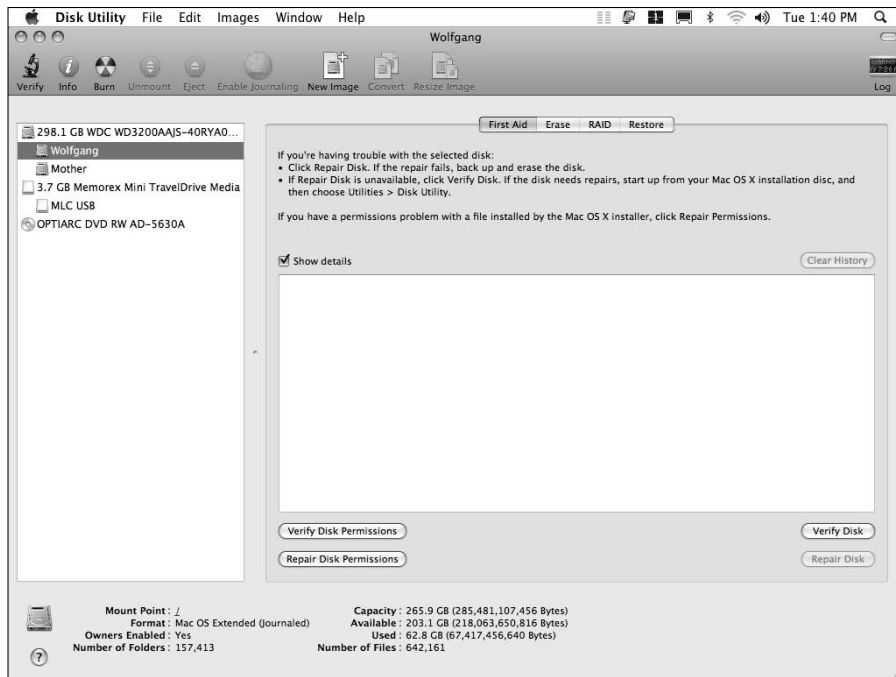

**Figure 18-2:**  
The  
physician  
of hard  
drives —  
Leopard's  
Disk Utility.

In the left column of the Disk Utility window, you can see



- ✓ **The *physical* hard drives in your system (the actual hardware)**
- ✓ **The *volumes* (the data stored on the hard drives)**
- ✓ **Any CD or DVD loaded on your iMac**
- ✓ **USB or FireWire Flash drives**

For example, in Figure 18-2, I have one hard drive (the 298.1GB entry) and one USB Flash drive (the 3.7GB entry). The hard drive has two volumes (Wolfgang and Mother), and the USB drive has one volume (MLC USB).



The information at the bottom of the Disk Utility window contains the specifications of the selected drive or volume . . . things like capacity, free space, and the number of files and folders for a volume, or connection type and total capacity for a drive.

### ***Repairing disk permissions***

Because Leopard is built on a Unix base, lots of permissions can apply to the files on your drive — that is, who can open (or read or change) every application, folder, and document on your hard drive. Unfortunately, these permissions

are often messed up by wayward applications or power glitches or application installers that do a sub-par job of cleaning up after themselves. And if the permissions on a file are changed, often applications lock up or refuse to run altogether.



I recommend repairing your disk permissions with Disk Utility once weekly. Figure 18-3 shows a permissions repair sweep on my internal hard drive's volume.

Use these steps to repair permissions on your iMac's hard drive:

1. **Make sure that you're logged in with an admin account.**
2. **Save and close any open documents.**
3. **Double-click the Disk Utility icon in the Utilities folder.**
4. **Click the volume that you want to check.**
5. **Click the Repair Disk Permissions button.**

I don't worry about verifying. If something's wrong, you end up clicking Repair Disk Permissions, anyway. Just click Repair Disk Permissions; if nothing pops up, that's fine.

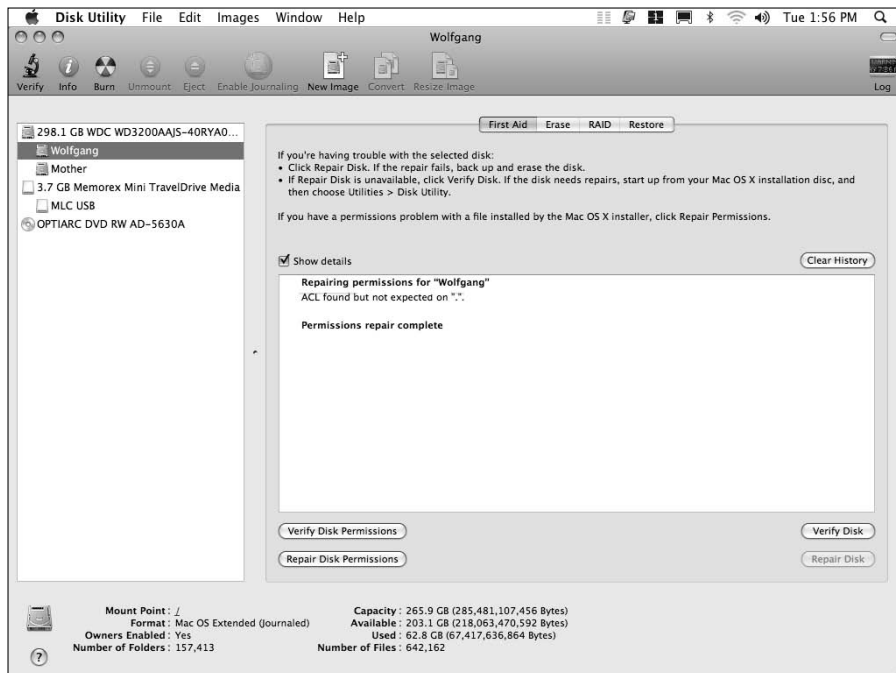

**Figure 18-3:**  
A  
successful  
run, using  
Repair Disk  
Permissions.

**6. To finish the process, always reboot after repairing permissions.**

This shows you whether a problem has been corrected!

### *Repairing disks*

Disk Utility can check the format and health of both hard drives and volumes with Verify Disk — and, if the problem can be corrected, fix any error with Repair Disk.



Using Disk Utility to repair your hard drive carries a couple of caveats:

- ✓ **You can't verify or repair the boot disk or the boot volume.** This actually makes sense because you're using that disk and volume right now.

To verify or repair your boot hard drive, you need to boot from your Mac OS X installation disc by using the C startup key. (Refer to Table 18-1 for keys that come in handy.) After your iMac boots from the Mac OS X installation disc, choose the Utilities menu and click Disk Utility.

You should be able to select your boot hard drive or volume, and the Verify Disk and Repair Disk buttons should be enabled.

- ✓ **You can't repair CDs and DVDs.** CDs and DVDs are read-only media and thus can't be repaired at all (at least by Disk Utility).

If your iMac is having trouble reading a CD or DVD, wipe the disc with a soft cloth to remove dust, oil, and fingerprints. Should that fail, invest in a disc-cleaning contrivance of some sort.

If you need to verify and repair a disk or volume, follow these steps:

- 1. If you need to repair your *boot drive and volume*, save all your open documents and reboot from either *an external drive or your Mac OS X Installation disc*.**
- 2. Double-click the Disk Utility icon in the Utilities folder.**
- 3. In the list at the left side of the Disk Utility window, click the disk or volume that you want to check.**
- 4. Click the Repair Disk button.**
- 5. If changes were made (or if you had to boot from a disc or external drive), reboot after repairing the disk or volume.**

## *Mark's iMac Troubleshooting Tree*

As the hip-hop artists say, “Alright, kick it.” And that’s just what my iMac Troubleshooting Tree is here for. If rebooting your iMac hasn’t solved the problem, follow these steps in order (until either the solution is found, or you run out of steps — more on that in the next section).

## Should I reinstall Mac OS X?

This question seems to get a lot of attention on Mac-related Internet discussion boards and Usenet newsgroups — and the answer is a definitive *perhaps*. (I know. That's really helpful.)

Here's the explanation. You *shouldn't* lose a single byte of data by reinstalling Mac OS X, so it's definitely okay to try it. However, reinstalling Mac OS X isn't a universal balm that fixes all software errors because the problem that you're encountering might be due to a buggy application, or a hard drive that's going

critical, or a video card with faulty memory modules. If the trouble you're having is due to a corrupted Mac OS X System folder, reinstalling Leopard might or might not fix the problem.

Therefore, the debate rages on. I would certainly follow the iMac Troubleshooting Tree all the way to the end before I would even consider reinstalling Leopard, and I would recommend contacting an Apple support technician via the Apple Web site before you take this step.

### Step 1: Investigate recent changes

This is a simple step that many novice Mac owners forget. Simply retrace your steps and consider what changes you made recently to your system. Here are the most common culprits:



- ✔ **Did you just finish installing a new application?** Try uninstalling it by removing the application directory and any support files that it might have added to your system. (And keep your applications current with the most recent patches and updates from the developer's Web site.)

From time to time, an application's *preference file* — which stores all the custom settings you make — can become corrupted. Although the application itself is okay, it might act strangely or refuse to launch. To check your preference files for signs of corruption, try scanning your iMac applications with Preferential Treatment, a freeware AppleScript utility by Jonathan Nathan, available from his Web site at [www.jonn8.com/html/pt.html](http://www.jonn8.com/html/pt.html). (Preferential Treatment will flag any dicey preference files, setting them up for a quick trip to the Trash.)

- ✔ **Did you just apply an update or a patch to an application?** Uninstall the application and reinstall it without applying the patch. If your iMac suddenly works again, check the developer's Web site or contact its technical support department to report the problem.
- ✔ **Did you just update Leopard by using Software Update?** Updating Leopard can introduce problems within your applications that depend on specific routines and system files. Contact the developer of the application and look for updated patches that bring your software in line with the Leopard updates. (And use Software Update in automatic mode to check for Mac OS X updates at least once weekly.)

- ✔ **Did you just make a change within System Preferences?** Return the options that you changed back to their original settings; then consult Chapter 6 for information on what might have gone wrong. (If the setting in question isn't in Chapter 6, consider searching Leopard's online Help or the Apple support Web site for more clues.)
- ✔ **Did you just connect (or reconnect) an external device?** Try unplugging the device and then rebooting to see whether the problem disappears. Remember that many peripherals need software drivers to run — and without those drivers installed, they won't work correctly. Check the device's manual or visit the company's Web site to search for software that you might need.

If you didn't make any significant changes to your system before you encountered the problem, proceed to the next step.

### ***Step 2: Run Disk Utility***

The preceding section shows how to repair disk permissions on your Leopard boot drive.



If you're experiencing hard drive problems, consider booting from your Mac OS X Installation CD or DVD to run a full-blown Repair Disk checkup on your boot volume.

### ***Step 3: Check your cables***

Cables work themselves loose, and they fail from time to time. Check all your cables to your external devices — make sure that they're snug — and verify that everything's plugged in and turned on. (Oh, and don't forget to check for crimps in your cables or even Fluffy's teeth marks.)



If a FireWire or USB device acts up, swap cables around to find whether you have a bad one. A faulty cable can leave you pulling your hair out in no time.

### ***Step 4: Check your Trash***

Check the contents of your Trash to see whether you recently deleted files or folders by accident. Click the Trash icon on the Dock once to display the contents. If something's been deleted by mistake, drag it back to its original folder, and try running the application again.

I know this one from personal experience. A slight miscalculation while selecting files to delete made an application freeze every time I launched it.

### ***Step 5: Check your Internet and network connections***

Now that always-on DSL and cable modem connections to the Internet are common, don't forget an obvious problem: Your iMac can't reach the Internet because your ISP is down, or your network is no longer working!

A quick visual check of your DSL or cable modem will usually indicate whether there's a connection problem between your modem and your ISP — for example, my modem has a very informative activity light that I always glance at first. However, if your iMac is connected to the Internet through a larger home or office network and you can't check the modem visually, you can check your Internet connection by pinging `www.apple.com`, as shown in Figure 18-4.

1. **Open your Utilities folder (inside your Applications folder).**
2. **Double-click Network Utility.**
3. **Click the Ping button.**
4. **Enter `www.apple.com` in the Address box.**
5. **Click Ping.**

You should see successful ping messages similar to those in Figure 18-4. If you don't get a successful ping *and* you can still reach other computers on your network, your ISP is likely experiencing problems. If you can't reach your network at all, then the problem lies in your network hardware or configuration.

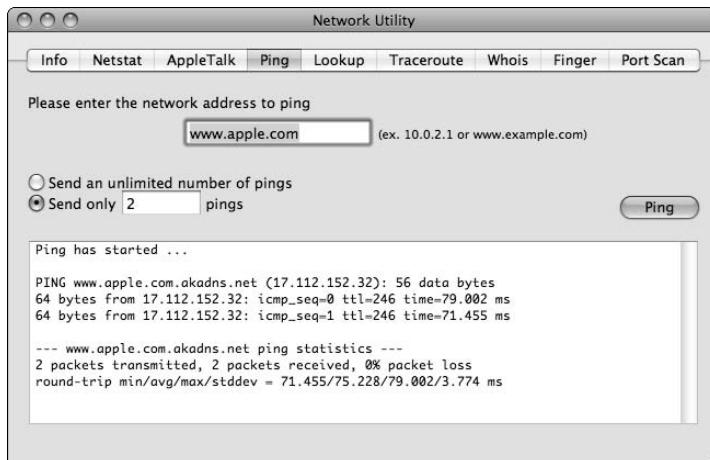

**Figure 18-4:**  
Ping  
`apple.com`  
to check  
your  
Internet  
connection.

### **Step 6: Think virus**

If you made it to this point, it's time to run a full virus scan — and make sure that your antivirus application has the latest updated data files, too. Figure 18-5 illustrates my antivirus application of choice, Virus Barrier X from Intego ([www.intego.com](http://www.intego.com)), performing a full system scan. (If a virus is detected and your antivirus application can't remove it, try *quarantining* it instead, which basically disables the virus-ridden application and prevents it from infecting other files.)

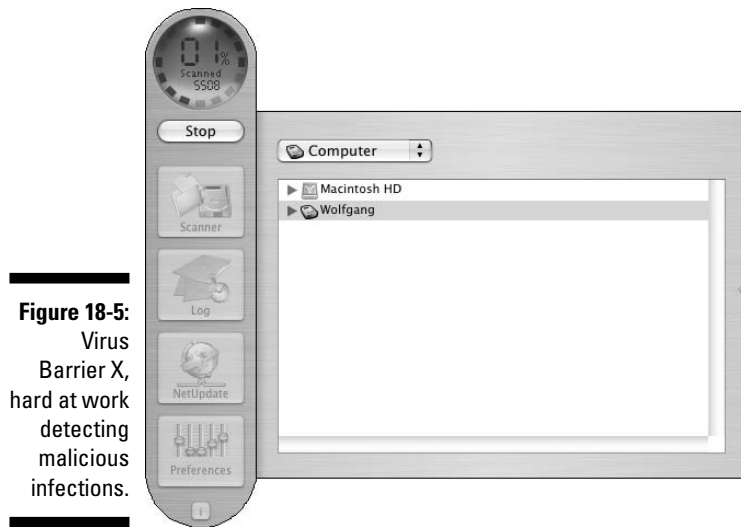

**Figure 18-5:**  
Virus  
Barrier X,  
hard at work  
detecting  
malicious  
infections.

### ***Step 7: Disable your Login Items***

Mac OS X might encounter problems with applications that you've marked as Login Items within System Preferences. In this step, I show you how to identify login problems and how to fix 'em.

#### ***Checking for problems***

It's time to use another nifty startup key (refer to Table 18-1). This time, hold down Shift after you hear the startup tone.

This trick disables your account's Login Items, which are run automatically every time you log in to your iMac. If one of these Login Items is to blame, your iMac will simply encounter trouble every time you log in.

#### ***Finding the Login Item that's causing trouble***

If your iMac works fine with your Login Items disabled, follow this procedure for each item in the Login Items list:

- 1. Open System Preferences, click Accounts, and then click the Login Items button.**
- 2. Delete the item from the list; then reboot normally.**

You can delete the selected item by clicking the Delete button, which bears a minus sign.

When your iMac starts up normally with Login Items enabled, you discovered the perpetrator. You'll likely need to delete that application and reinstall it. (Don't forget to add each of the *working* Login Items back to the Login Items list!)



**Step 8: Turn off your screen saver**

This is a long shot, but it isn't unheard of to discover that a faulty, bug-ridden screen saver has locked up your iMac. (If you aren't running one of the Apple-supplied screen savers and your computer never wakes up from Sleep mode or hangs while displaying the screen saver, you found your prime suspect.)

Open System Preferences, click Desktop & Screen Saver, click the Screen Saver button, and then either *switch to an Apple screen saver* or *drag the Start slider to Never*.



If this fixes the problem, you can typically remove the screen saver completely by deleting the offending saver application in the Screen Savers folder inside your Mac OS X Library folder. If you can't find the screen saver application, try typing the saver name in the Spotlight search box.

**Step 9: Run System Profiler**

Ouch. You reached Step 9, and you still haven't uncovered the culprit. At this point, you narrowed the possibilities to a serious problem, like bad hardware or corrupted files in your Mac OS X System Folder. Fortunately, Leopard provides System Profiler, which displays real-time information on the hardware in your system. Click the Apple menu and choose About This Mac; then click More Info. Figure 18-6 illustrates a typical healthy result from one of the Hardware categories, Disc Burning. Click each one of the Hardware categories in turn, double-checking to make sure that everything looks okay.

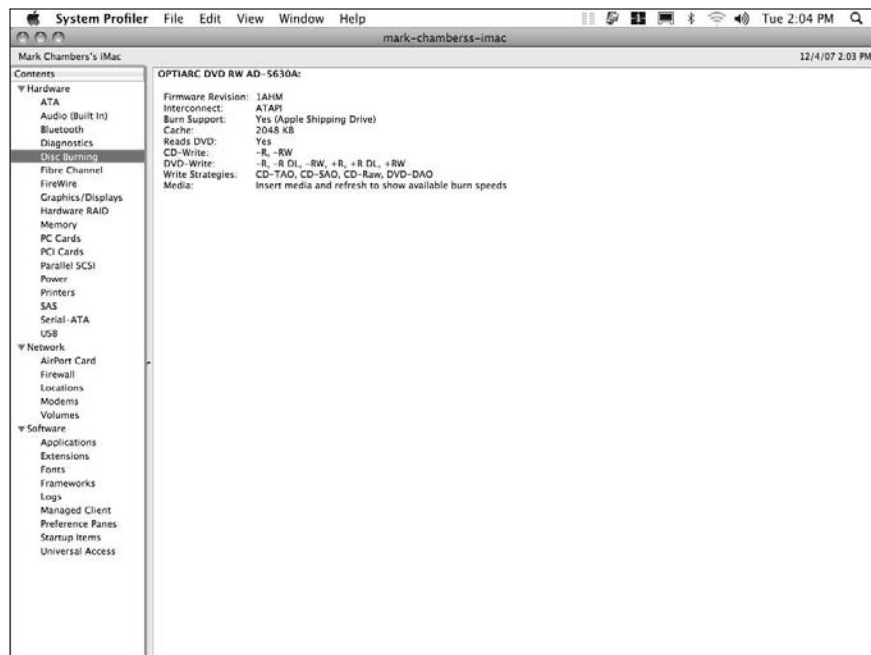

**Figure 18-6:**  
Check your  
iMac  
hardware  
from System  
Profiler.



You don't have to understand all the technical hieroglyphics. If a Hardware category doesn't return what you expect or displays an error message, though, that's suspicious. (If your iMac doesn't have a specific type of hardware onboard — including Bluetooth, Fibre Channel, PC Cards, PCI Card, or Parallel SCSI hardware — you won't get information from those categories.)



Diagnostics shows whether your iMac passed the Power On self-test.

## *Okay, I Kicked It, and It Still Won't Work*

Don't worry, friendly reader. Just because you've reached the end of my iMac tree doesn't mean you're out of luck. In this section, I discuss the online help available on the Apple Web site as well as local help in your own town.

### *Apple Help Online*

If you haven't visited the Apple iMac Support site yet, run — don't walk — to [www.apple.com/support/imac](http://www.apple.com/support/imac), where you can find

- ✓ **The iMac Troubleshooting Assistant**, which queries you on the symptoms being displayed by your iMac and offers possible solutions
- ✓ **The latest patches, updates, and how-to tutorials** for the iMac
- ✓ **iMac and Mac OS X discussion boards**, moderated by Apple
- ✓ **Tools** for ordering spare parts, checking on your remaining warranty coverage, and searching the Apple Knowledge Base
- ✓ **Do-it-yourself instructions** (PDF files) that you can follow to repair or upgrade your iMac

### *Local service, at your service*

In case you need to take in your iMac for service, an Apple Store or Apple Authorized Service Provider is probably in your area. To find the closest service, launch Safari and visit

<http://www.apple.com/buy/locator/service/>

That's the Find Service page on the Apple Web site. You can search by city and state or ZIP code. The results are complete with the provider's mailing address, Web site address, telephone number, and even a map of the location!

Always call your Apple service provider before you lug your (albeit light-weight) iMac all the way to the shop. Make sure that you know *your iMac's serial number* (which you can display in System Profiler) and *which version of Mac OS X you're using*.



## Chapter 19

# I Want to Add Stuff

---

### *In This Chapter*

- ▶ Adding memory
  - ▶ Upgrading your hard drive
  - ▶ Adding USB and FireWire devices
  - ▶ Reviewing what add-ons are available
- 

**“N**o iMac is an island.” Somebody famous wrote that, I’m sure.

Without getting too philosophical — or invoking the all-powerful Internet yet again — the old saying really does make sense. All computer owners usually add at least one *peripheral* (external device), such as a joystick, an iPod, a backup drive, or a scanner. I talk about the ports on your iMac in Chapter 1. Those holes aren’t there to just add visual interest to the back end of your treasured iMac. Therefore, I cover your USB and FireWire ports (and what you can plug into them) in detail in this chapter.

Ah, but what about the stuff *inside* your aluminum supercomputer? That’s where things get both interesting and scary at the same time. In this chapter, I describe what you can add to the innards of your computer as well as how to get inside there if you work up the courage to go exploring. (Don’t tell your family or your friends, but adding memory to an aluminum iMac is as simple as loosening a screw and pulling on a plastic tab. There’s actually nothing to fear whatsoever.)

Here’s the trick: Just make it sound like an adventure from *Mission: Impossible*, and folks will crown you their new resident techno-wizard!

## *More Memory Will Help*

Hey, wait a second. No *however* stuck on the end? You mean for once, there isn’t an exception? Aren’t all computers different? Hard as it is to believe, just keep in mind this Mark’s Maxim:



More memory helps.™

*Period.* End of statement. No matter what type of computer you own, how old it is, or what operating system you use, adding more memory to your system (to the maximum it supports) significantly improves the performance of your operating system (and practically every application that you run).



Memory maximizes the power of your computer: The more memory you have, the less data your iMac has to temporarily store on its hard drive. Without getting into virtual memory and other techno-gunk, just consider that extra memory as extra elbowroom for your applications and your documents. (You can read how in Chapter 22.) Believe me, both Mac OS X and Windows XP/Vista efficiently make use of every kilobyte of memory that you can provide.

## *Figuring out how much memory you have*

To see how much memory you have in your computer, click the Apple menu () and choose About This Mac. Figure 19-1 shows the dialog.



**Figure 19-1:**  
Find out  
how much  
memory  
your iMac  
has.

At the time of this writing, the current crop of iMacs has sockets for two PC2-5300 DDR2 SDRAM memory modules. (Don't fret over what all the abbreviations mean. Rest assured that this memory type is fast.) Each module can range up to 2GB of memory, so you can install as much as 4GB of memory on your iMac.

How you plan memory upgrades depends on how much memory you want. If your iMac uses the single default 1GB module supplied by Apple, you have a couple of options:



- ✓ **Add up to 2GB of RAM** by inserting a 1GB or a 2GB memory module in the empty slot. At the time of this writing, a gigabyte memory module should set you back about \$100 or so.

2GB of memory is plenty for running applications from the iLife and iWork suites as well as any of the applications bundled with Leopard.

- ✓ **Install up to 4GB of total memory** by removing the standard 1GB module and inserting high-capacity 2GB modules in both slots.

If your primary applications include video editing, game playing, or image editing, you can use all the memory your iMac can hold.

Unfortunately, Apple's prices for RAM are . . . well . . . *outrageous*. (As in, "Boy howdy, I can't afford that!") Therefore, I can heartily recommend any one of these online sources that cater to Mac owners:

- ✓ MacMall ([www.macmall.com](http://www.macmall.com))
- ✓ CDW ([www.cdw.com/content/brands/apple/default.aspx](http://www.cdw.com/content/brands/apple/default.aspx))
- ✓ Newegg ([www.newegg.com](http://www.newegg.com))

## Installing memory modules

I'm happy to report that adding extra memory to your system is one of the easiest internal upgrades that you can perform. Therefore, I recommend that you add your own memory yourself unless you simply don't want to mess with your iMac's internal organs. Your local Macintosh service specialist will be happy to install new RAM modules for you (for a price).

### Getting inside your iMac

Apple designed the world's best all-in-one computer. That even includes making it EZ-Open. (Forgive me if your treasured work of art now reminds you of a longneck beer bottle. Come to think of it, the level of technical knowledge required to gain access to either one is about the same.)

Unlike earlier "picture frame" iMac models, however, you can't remove the back completely.

In fact, Apple allows the owner of an iMac to perform only one kind of upgrade, and there's only one opening you need to worry about. (**Note:** You'll void your warranty by removing the back of your iMac, so don't even think about it.) Naturally, an Apple repair technician can get deeper into the machine, but I hope that you never need aid from those folks.

## Let's get grounded!

Follow one cardinal rule when the unguarded insides of any computer are in easy reach: *Always ground yourself before you touch anything!* Your body can carry enough static electricity to damage the RAM you're installing or removing, and touching those modules without grounding yourself is an invitation for disaster.

Grounding yourself is easy to do: Just touch any metal surface around your work table, such as a chair leg or your local metal sink. After you

ground yourself, you can then safely handle RAM chips that you remove (if any) as well as the new ones that you're installing.

If you walk anywhere in the room — say, hunting for a screwdriver, or taking a sip of liquid reinforcement that you stashed a comfortable and safe distance away — you *must* ground yourself again before you get back to work.

**Remember:** You can actually pick up a static charge by simply walking. Go figure.

To add memory modules to an aluminum iMac, follow these steps:

### 1. Get ready to operate.

- a. *Spread a clean towel on a stable work surface, like your kitchen table.* The towel helps protect your screen from scratches.
- b. *Find a Phillips screwdriver.*
- c. *Shut down your iMac.*
- d. *Unplug all cables from the computer.*

### 2. Tilt the computer over and lay the screen flat (face-down) on top of the towel.

### 3. Loosen the screw at the bottom of the computer's case.

Apple thought of everything! There's only one tiny screw, and you can't lose said screw because it's *captive*. It actually stays in the door, so don't try to remove it completely.

### 4. Remove the RAM access door.

### 5. Stow the RAM access door safely out of reach of kids and cats.

Tah-dah! That wasn't much of a challenge, was it? Here's your chance to gaze with rapt fascination at a small portion of the bare innards of your favorite computer.

### 1. Ground thyself!

Check out the sidebar, "Let's get grounded!"







**2. If you need to remove a module for your upgrade, untuck the tab over the existing module.**

**3. Gently pull on the tab to remove the module (as shown in Figure 19-2).**

Save the old module in the static-free packaging that held the new module. Your old RAM (which you can now sell on eBay) will be protected from static electricity.

**4. Position the new module(s) in the socket(s).**

*a. Line up the module's copper connectors toward the socket.*

*b. Line up the notch in the module aligned with the matching spacer in the socket. See what I mean in Figure 19-3.*

**5. Press gently (but firmly) on both ends of the module until the module's tabs click into place on both ends of the socket.**

**6. Tuck any loose tabs back into the body of your iMac.**

**7. Replace the RAM access door, reversing Steps 3–5 of the preceding step list.**

Waxing nostalgic: This is rather like changing the oil on my Dad's 1970 Ford pickup truck.

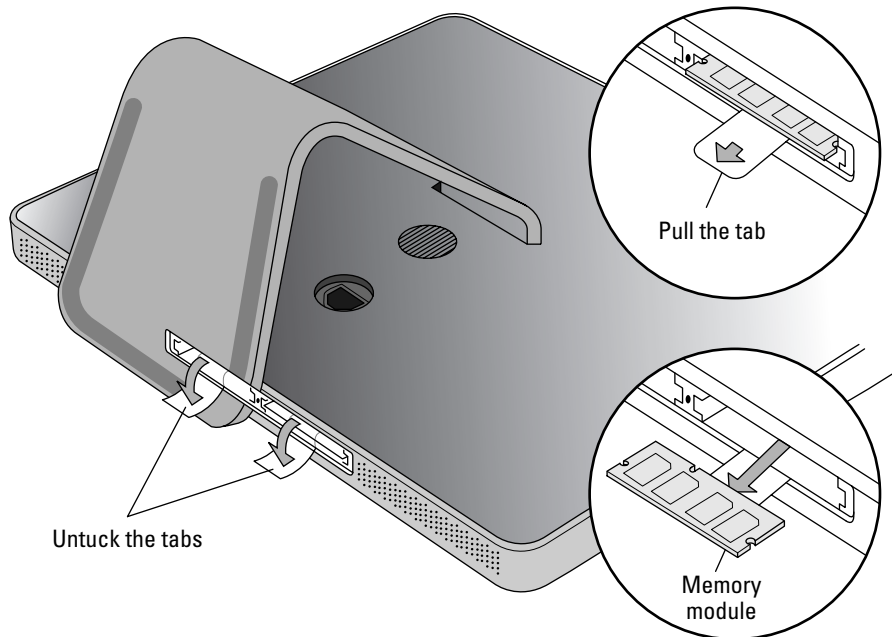

**Figure 19-2:**  
Remove a  
memory  
module  
like a pro.

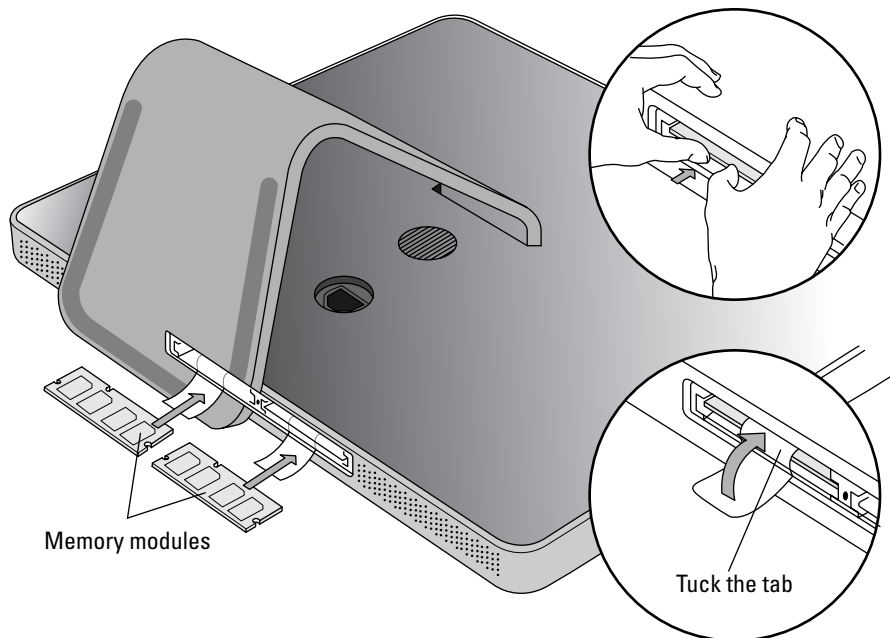

**Figure 19-3:**  
Installing the new modules is a snap (pun intended)!

Congratulations! You've done it — you're now an iMac memory guru! To verify that all is well with your iMac, boot the computer and once again click the Apple menu and choose About This Mac. Your iMac should report the additional memory.

## Can I Upgrade My Hard Drive?

Asking whether you can upgrade your hard drive is a trick question. Yes, you certainly can upgrade your hard drive. But before you start cruisin' the Internet for a 500GB monster, though, I have two suggestions:

✔ **Be sure you really need a hard drive upgrade.**

Apple is pretty generous when configuring hard drive storage for its base systems. (Current models run with anywhere from a 250GB to a whopping 1TB drive — yep, that's 1 *terabyte*, or 1000GB! Something tells me that your prized walnut brownie recipe will have plenty of elbow room on a 1TB drive, as will a huge amount of digital video.)

I'll be honest here: Most folks simply don't need more than 250GB of hard drive space. You're likely to find that you still have plenty of wide open spaces for a typical family's needs on your hard drive unless you're heavily into

- Digital video (DV)
- Cutting-edge video games
- Tons of high-quality digital audio

✓ **If you decide that you do need to upgrade, don't install your internal hard drive yourself.**

Read more about this in the upcoming section, "Gotta have internal."



If you're short on hard drive space, clean up your existing hard drive by deleting all the crud you don't need, such as game and application demos, duplicate or "work" copies of images and documents, archived files you downloaded from the Internet, and the contents of your Trash. You can read how in Chapter 20.

## *Consider your external options*

If you *do* need additional hard drive space, I recommend using an external drive! Use a high-speed FireWire or USB port to connect a second hard drive the quick and easy way.

Most of today's FireWire and USB peripherals don't even require the driver software that Mac old-timers remember with such hatred. You simply plug in a FireWire or USB device, and it works. You can move your external drive between different Macs with a minimum of fuss and bother.

An external hard drive can do anything that your internal hard drive can do. You can boot from it, for example, or install a different version of Mac OS X (great for beta testers like me).



Apple's Time Capsule unit is an external hard drive with a difference — it stores the huge Time Machine backup files created by the Macs running Leopard on your network, and it uses a wireless connection to transfer data! (In fact, if you're thinking of adding a wireless base station to your wired network, your Time Capsule actually acts as a full AirPort Extreme base station, complete with USB port for connecting a USB printer.) At the time of this writing, Time Capsule is available with either a 500GB (\$299) or 1TB (\$499) drive.



Here's one problem with external drives: Data transfers more slowly this way than via an internal drive (even with a FireWire 800 connection). That's why most Mac owners use their external drives for storing little-used documents and applications. Their favorite applications and often-used documents are housed on the internal drive.

### ***Putting a port to work***

An aluminum iMac carries three kinds of high-speed ports, any of which is a good match for connecting any external device.

#### **USB 2.0**

The USB standard is popular because it's just as common in the PC world as in the Mac world. (Most PCs don't have a FireWire port.) Your iMac carries its USB 2.0 ports on the back of the case and on the ends of the keyboard. Hardware manufacturers can make one USB device that works on both types of computers.



I heartily recommend that you avoid using any USB 1.1 devices (except, perhaps, a USB 1.1 keyboard or mouse). USB 1.1 is very slow compared with the USB 2.0 standard although you can connect a USB 1.1 device to a USB 2.0 port with no problem at all. You should buy only USB 2.0 external hard drives, CD/DVD recorders, or Flash drives. 'Nuff said.

#### **FireWire 400**

The original FireWire (also called *IEEE 1394*) is the best port for most digital video camcorders. Use your FireWire port for connecting external devices to your iMac — you'll find it on the back of your iMac's case.

#### **FireWire 800**

A FireWire 800 drive offers much better performance than either a FireWire 400 or a USB 2.0 drive, and today's FireWire 800 drives are getting cheaper every day. Your iMac proudly sports a FireWire 800 port on the back.



The physical FireWire 800 connector is shaped differently than the FireWire 400 port, so don't try to force the wrong connector into the wrong port!

### ***Connecting an external drive***

With FireWire or USB, you can install an external hard drive without opening your iMac's case. With your iMac turned on and the external drive disconnected from the AC outlet, follow these steps:

- 1. Connect the FireWire or USB cable betwixt the drive and your computer.**
- 2. Plug the external drive into a convenient surge protector or UPS (uninterruptible power supply).**
- 3. Switch on the external drive.**

#### 4. If the drive is unformatted (or formatted for use under Windows), partition and format the external drive.

The drive comes with instructions or software for you to do this. (Don't worry, your external drive comes from the factory completely empty, and you won't damage anything by formatting it.) Partitioning divides the new drive into one (or more) volumes, each of which is displayed as a separate hard drive under Leopard.



If the drive comes preformatted for use with a Windows PC, I strongly suggest reformatting it for use with Mac OS X — this will result in faster performance and more efficient use of space.

After the drive is formatted and partitioned, it immediately appears on the Desktop. Shazam!

## Gotta have internal

If you decide that you have to upgrade your existing internal hard drive — or if your internal drive fails and needs to be replaced — you must take your iMac to an authorized Apple service center and allow the techs there to sell you a drive and make the swap. Here are four darned good reasons why:

- ✓ **Warranty:** As I mention in the sidebar, “Getting inside your iMac,” you’re very likely to void your iMac’s warranty by attempting a drive upgrade yourself.
- ✓ **Selection:** If you’re worried about picking the proper drive, an Apple technician can order the right drive type and size for you . . . no worries.
- ✓ **Difficulty:** Swapping a hard drive in your iMac is nothing like adding RAM modules. It’s complex and involves breaking into your iMac — not A Good Thing, even for the knowledgeable Mac guru.
- ✓ **Backup:** That very same Apple service technician can back up all the data on your existing drive and move it to the new drive, saving you from losing a single document. That will save you time and possible angst.



To those who *truly* won't be satisfied with their lives until they upgrade an internal drive in an iMac: Yes, I'm sure you can find a magazine article that purports to show you how. Even better, I've seen many how-to articles on the Web that will lead you down a rosy path to a hard drive upgrade. Here's my take on those savvy instructions: You're walking into a field of land mines with someone else's map, so you had better have *complete* faith in your tech skills. (And a darn good backup.)

## *Attractive Add-Ons*

The USB and FireWire toys I cover in this section might add a cord or two to your collection at the back of your iMac, but they're well worth the investment. And they can really revolutionize how you look at technologies, such as television, digital audio, and computer gaming.

### *Game controllers*

If you're ready to take a shot at the enemy — whether they be Nazi soldiers, chittering aliens, or the latest jet fighters — you'll likely find your keyboard and mouse somewhat lacking. (And if that enemy happens to be a friend of yours playing across the Internet, you'll be ruthlessly mocked while you're fumbling for the right key combination.) Instead, either pick up a USB joystick (for flying games) or a gamepad (for arcade and first-person shooting games)!

### *Video controllers*

For armchair directors, specialized USB digital video controllers make editing easier. The ShuttleXpress from Contour Design ([www.contourdesign.com](http://www.contourdesign.com)) provides a five-button jog control that can be configured to match any DV editor. For \$60, you'll have the same type of editing controller as do those dedicated video-editing stations that cost several thousand dollars.

### *Audio hardware*

Ready to put GarageBand to the test with your favorite version of *Chopsticks*? You need a USB piano keyboard, and I recommend the Keystation 49e from M-Audio ([www.m-audio.com](http://www.m-audio.com)), which retails for a mere \$130. It provides 49 keys and uses a USB connection.

Another neat audio favorite of mine is the USB-powered radio SHARK 2 from Griffin Technology ([www.griffintechnology.com](http://www.griffintechnology.com)), which allows you to add AM/FM radio to your iMac, complete with recording capability, a pause feature, and scheduled recording, all for \$50.

## Chapter 20

# Tackling the Housekeeping

---

### *In This Chapter*

- ▶ Cleaning unnecessary stuff off your hard drive
  - ▶ Backing up your data
  - ▶ Fixing permission errors
  - ▶ Automating tasks in Leopard
  - ▶ Updating Mac OS X automatically
- 

**N**othing runs better than a well-oiled machine, and your iMac is no exception. With a little Leopard maintenance, you can ensure that your iMac is performing as efficiently as possible.

In this chapter, I demonstrate how you can make good use of every byte of storage space provided by your hard drive, as well as how to back up and restore that hard drive to an external drive, using Time Machine. Your hard drive also benefits from a periodic scan for permission errors.

Leopard's Automator application is a great housekeeping tool: It allows your iMac to perform tasks automatically that used to require your attention. I show you how you can create Automator applications and set them up to run by themselves. (It sounds a little spooky, but you'll have a ball!)

And it's important to never forget about updating Mac OS X itself. But then again, if you configure Software Update to run automatically, you can live life free and easy, watching your favorite soaps and eating ice cream (or yogurt — your pick).

## *Cleaning Unseemly Data Deposits*

*Criminy!* Where does all this stuff *come* from? Suddenly that spacious 250GB hard drive has 19GB left, and you start feeling pinched.

Before you consider buying a new internal or external hard drive (which you can read about in Chapter 20), take the smart step: “Sweep” your hard drive clean of unnecessary and space-hogging software.

## *Getting dirty (or, cleaning things the manual way)*

If you’re willing to dig into your data a little, there’s no reason to buy additional software to help you clean up your hard drive. All you really need is the willpower to announce, “I simply don’t need this application any longer.” (And, sometimes, that’s tougher than it might seem.)

### *Unnecessary files and unneeded folders*

Consider all the stuff that you probably don’t really need:

- ✓ Game demos and shareware that you no longer play (or even remember)
- ✓ Movie trailers and other QuickTime video files that have long since passed into obscurity
- ✓ Temporary files that you created and promptly forgot
- ✓ Log files that chronicle application installations and errors
- ✓ StuffIt archives that you downloaded and no longer covet
- ✓ iTunes music that no longer appeals to your ear

How hard is it to clean this stuff off your drive? Easier than you might think!

- ✓ You can easily delete files.
- ✓ You can get rid of at least the lion’s share of any application (often the whole application) by deleting its application folder that was created during the installation process.

Removing an application or file from your hard drive is usually two simple steps:

**1. Display the file or application folder in a Finder window.**

**2. Delete the file or folder with one of these steps:**

- Drag the icon to the Trash.
- Press ⌘+Delete.
- Right-click the icon and choose Move to Trash.
- Select the icon and click the Delete button on the Finder toolbar (if you added one).



Truly, no big whoop.



Mac owners like you and me can once again feel superior to the XP and Vista Zombies because most Mac OS X applications don't need a separate, silly "uninstall" program. In fact, Macintosh software developers have always followed a simple general rule: All (or virtually all) of an application's support data should reside in a single folder.



Don't forget to actually *empty* the Trash, or you'll wonder why you aren't regaining any hard drive space. (Leopard works hard to store the contents of the Trash until you manually delete it, just in case you want to undelete something.) To get rid of that stuff permanently and reclaim the space, do the following:

1. **Click the Trash icon on the Dock and hold down the mouse button — or right-click — until the pop-up menu appears.**
2. **Choose Empty Trash.**

### ***Associated files in other folders***

Some applications install files in different locations across your hard drive. (Applications in this category include Microsoft Office and Photoshop.) How can you clear out these "orphan" files after you delete the application folder?

The process is a little more involved than deleting a single folder, but it's still no big whoop. Here's the procedure:

1. **Click the Search text box in a Finder window.**

You can read more about Search and Finder windows in Chapter 7.

2. **Type the name of the application in the Search text box.**

Figure 20-1 shows this search. I want to remove Toast Titanium, so I search for every file with the word *toast* in its name.

3. **Decide which of these files belong to the to-be-deleted application.**

Be sure that the files you choose to delete are part of the deleted application. For example, a text file with the name *Instructions on Making a Perfect Piece of Toast* might not be part of Toast Titanium.

Many associated files either

- Have the same icon as the parent application
- Are in the Preferences, Caches, or Application Support folders



**Figure 20-1:**  
Mine your  
hard  
drive for  
additional  
files to  
delete.

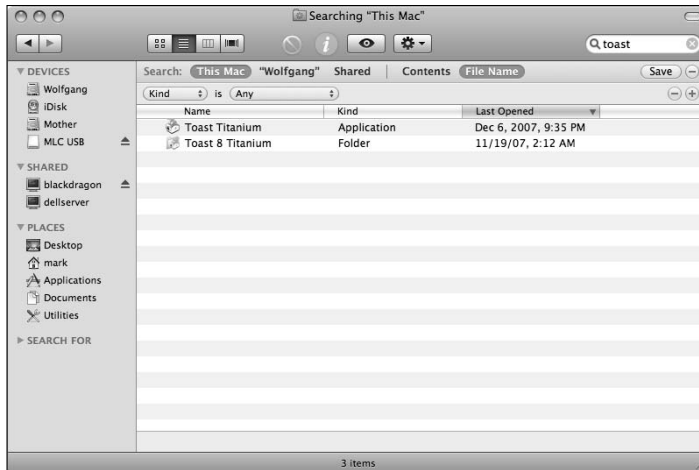

- In the Search Results window, click the associated file(s) that you want to delete and just drag them to the Trash.**



Don't empty the Trash immediately after you delete these files. Wait a few hours or a day. That way, if you realize that you deleted a file that you truly need, you can easily restore it from the Trash.

## *Using a commercial cleanup tool*

If you'd rather use a commercial application to help you clean up your hard drive, a number of them are available, but most are shareware and perform only one task. For example, Tidy Up! from Hyperbolic Software ([www.hyperbolicsoftware.com](http://www.hyperbolicsoftware.com)) finds only duplicate files on your hard drive, matching by criteria such as filename, size, and extension. It's a good tool at \$30.

For a truly comprehensive cleanup utility, I recommend Spring Cleaning, from Smith Micro Software ([my.smithmicro.com](http://my.smithmicro.com)), the same company that produces the archiving utility StuffIt. Figure 20-2 illustrates the main menu of Spring Cleaning, which sells for \$50. Not much crud squeaks by all those search routines, including duplicates, orphan preference files, and log files. Spring Cleaning even includes a separate feature called MacUninstaller that can help automate the steps that I cover in the preceding section.



**Figure 20-2:**  
Spring  
Cleaning  
helps keep  
your data  
ranch  
squeaky  
clean.

## Backing Up Your Treasure

### Do it.

I'm not going to lecture you about backing up your hard drive . . . well, perhaps just for a moment. Imagine what it feels like to lose *everything* — names, numbers, letters, reports, presentations, saved games, photographs, and music. Then ask yourself, “Self, isn’t all that irreplaceable stuff worth just a couple of hours every month?”

Time for a Mark’s Maxim:



*Back up.* On a regular basis. Then store those DVDs or that external backup device somewhere safe, away from calamities.<sup>TM</sup>

Take my word for it — you will thank me some day!

You can back up your files either by saving them to external media or by using Leopard’s awesome new Time Machine feature.

## *Saving Files*

The simplest method of backing up files is simply to copy the files and folders to an external hard drive or a CD or DVD. Nothing fancy, but it works.

### *Backing up to an external hard drive*

If you have an external hard drive on your iMac, you can easily drag backup files to it from your internal hard drive:

- 1. Open separate Finder windows for**
  - The external hard drive
  - The internal hard drive
- 2. Select the desired files that you want to back up from your internal drive.**
- 3. Drag the selected files to the external drive window.**



Chapter 19 covers external hard drives.

### *Backing up to CD and DVD*

You can burn backup files to a recordable CD or DVD.

#### *Burning backups from the Finder*

To use the Finder's Burn feature with a CD or DVD, follow these steps:

- 1. Load a blank disc into your iMac's optical drive.**

If you're using the default settings in the CDs & DVDs pane in System Preferences, a dialog asks you for a disc name.
- 2. Into the disc's Finder window, drag the files and folders that you want to back up.**

They can be organized any way you like. Don't forget that the total amount of data shouldn't exceed 4GB or so (on a standard recordable DVD) or 8GB (on a dual-layer recordable DVD). You can see how much free space remains on the disc at the bottom of the disc's Finder window.

**3. Click File and then choose Burn Disc from the menu.**

You can also click the Burn button on the Recordable DVD bar — it appears at the top of the disc's Finder window.

**4. Choose the fastest recording speed possible.**

**5. Click Burn.**

***Burning backups from other recording applications***

If you've invested in Toast Titanium from Roxio ([www.roxio.com](http://www.roxio.com)) or another CD/DVD recording application, you can create a new disc layout to burn your backup disc. (Think of a layout as a "road map" indicating which files and folders Toast should store on the backup.)



You can save that disc layout and use it again. This simplifies the process of backing up the same files in the future (if you don't move folders or files from their current spot).

## ***Putting Things Right with Time Machine***

If you enable backups via Leopard's new Time Machine feature, you can literally move backward through the contents of your iMac's hard drive, selecting and restoring all sorts of data. Files and folders are ridiculously easy to restore — and I mean easier than *any* restore you've ever performed, no matter what the operating system or backup program. Time Machine can even handle such deleted items as Address Book entries or photos you sent to the Trash from iPhoto!

Because Time Machine should be an important and integral part of every Mac owner's existence, the Time Machine icon is included on the Dock. (Apple is not messing around!)



Apple's Time Capsule device is designed as a wireless storage drive for your Time Machine backup files — if you're interested in a single Time Machine backup location for multiple Macs across your wireless network, Time Capsule is a great addition to your home or office.



Before you can use Time Machine, it must be enabled within the Time Machine pane in System Preferences. I cover the Time Machine configuration settings (and how to turn the feature on) in more detail in Chapter 6.

Here's how you can turn back time, step by step, to restore a file that you deleted or replaced in a folder.

1. Open the folder that contained the file you want to restore.
2. In a separate window, open your Applications folder and launch the Time Machine application, or click the Time Machine icon on the Dock (which bears a clock with a counter-clockwise arrow).

The oh-so-ultra-cool Time Machine background appears behind your folder, complete with its own set of buttons at the bottom of the screen (as shown in Figure 20-3). On the right, you see a timeline that corresponds to the different days and months included in the backups that Leopard has made.

3. Click within the timeline to jump directly to a date (displaying the folder's contents on that date).

Alternatively, use the Forward and Back arrows at the right to move through the folder's contents through time. (You should see the faces of Windows users when you “riffle” through your folders to locate something you deleted several weeks ago!)

The backup date of the items you're viewing appears in the button bar at the bottom of the screen.

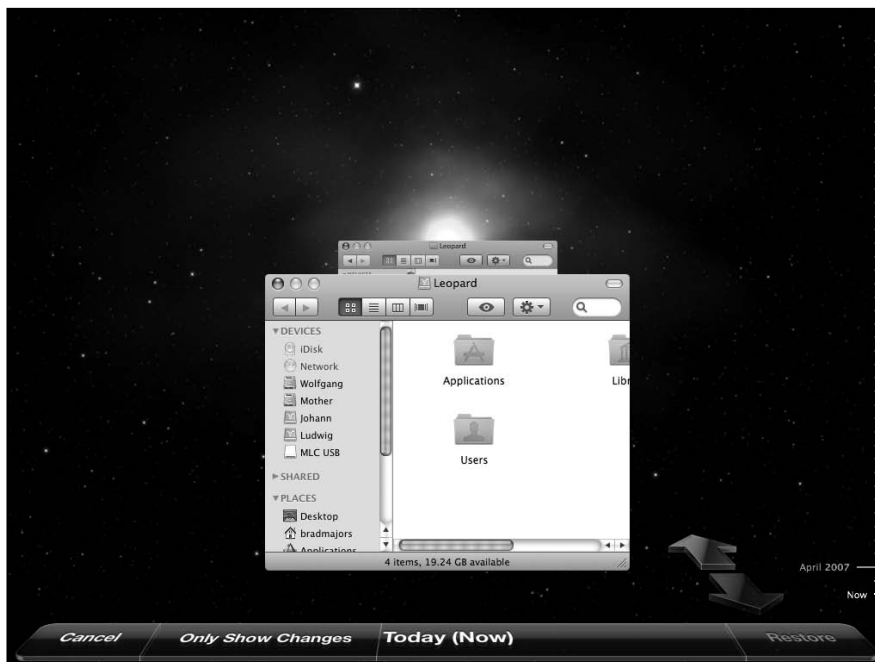

**Figure 20-3:**  
Yes, Time  
Machine  
really *does*  
look like  
this!

4. After you locate the file you want to restore, click it to select it.
5. Click the Restore button at the right side of the Time Machine button bar.

If you want to restore all the contents of the folder, click the Restore All button instead.

Time Machine returns you to the Finder, with the newly restored file now appearing in the folder. *Out-standing!*



To restore specific data from your Address Book or images from iPhoto, launch the desired application first and then launch Time Machine. Instead of riffling through a Finder window, you can move through time within the application window.

For simple backup and restore protection, Time Machine is all that a typical Mac owner at home is likely to ever need. Therefore, a very easy Mark's Maxim to predict:



Turn on Time Machine. *Do it now.* Don't make a humongous mistake.™

## Maintaining Hard Drive Health

Shifty-eyed, sneaky, irritating little problems can bother your hard drive: *permissions errors*. Incorrect disk and file permissions can

- ✓ Make your iMac lock up
- ✓ Make applications act screwy (or refuse to run at all)
- ✓ Cause weird behavior within a Finder window or System Preferences

To keep Leopard running at its best, I recommend that you fix permissions errors at least once per week.

To fix any permissions errors on your system, follow these steps:

1. Open a Finder window, click Applications, and then click Utilities.
2. Double-click the Disk Utility icon.
3. Click the volume at the left that you want to check. (*Volume is just computer-speak for a named partition, like Macintosh HD, which appears under your physical hard drive.*)
4. Click the Repair Disk Permissions button.

Disk Utility does the rest and then displays a message about whatever it has to fix. (When will someone invent a *car* with a Repair Me button?)

## What causes permissions errors?

Permission errors are usually introduced on your system when a faulty installer makes a mistake copying files to your system. Sometimes, the application itself has a bug that produces errors when it tries to open or close files or use Mac OS X system functions. Fortunately, you don't really have to investigate what causes a permission

error. (That's good because you and I aren't likely to understand such techno-gibberish, anyway.) You just need to know that Disk Utility fixes the errors.

Didn't I *tell* you this operating system was the best on planet Earth?

## Automating Those Mundane Chores

One popular feature in Leopard — Automator — has generated a lot of excitement. You use Automator (as shown in Figure 20-4) to create applications with a compiled form of AppleScript. (In case you're not familiar with AppleScript, it's the simple programming language that you can use to automate tasks and applications within Leopard.)

Of course, that might sound daunting — akin to building your own nuclear submarine single-handedly over a long weekend — but Automator is actually easy to use. Heck, you might find it downright *fun*!

You can also create *workflows*, which are sequential (and repeatable) operations that are performed on the same files or data, and then your Automator application can automatically launch whatever applications are necessary to get the job done.

Here's a great example: You work with a service bureau that sends you a CD every week with new product shots for your company's marketing department. Unfortunately, these images are flat-out *huge* — taken with a 12-megapixel camera — and they're always in the wrong orientation. Before you move them to the Marketing folder on your server, you have to laboriously resize each image and rotate it, and then save the smaller version.

With help from Automator, though, you can build a custom application that automatically reads each image in the folder, resizes it, rotates it, and even generates a thumbnail image or prints the image, and then moves the massaged images to the proper folder. You'd normally have to manually launch Preview to perform the image operations and then use a Finder window to move the new files to the right location. But now, with Automator, a single double-click of your custom application icon does the trick.



**Figure 20-4:** Automator is a dream come true for those who hate repetitive tasks.

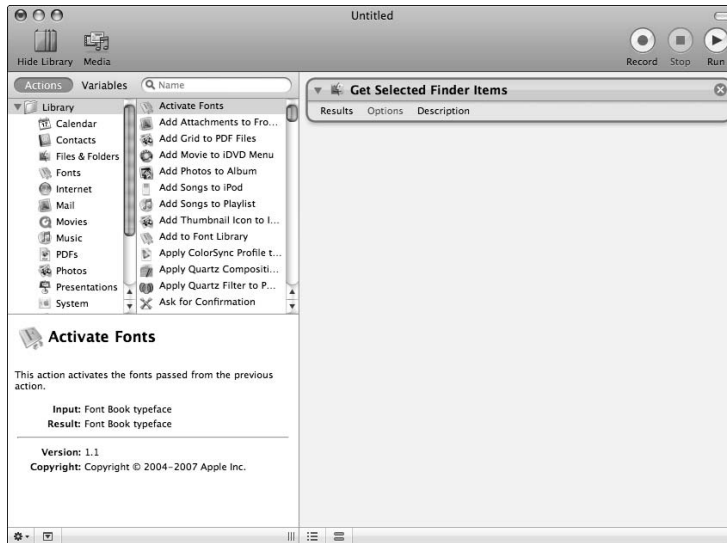

You'll find Automator in your Applications folder. Currently, Automator can handle specific tasks within about 30 or 40 applications (including the Finder), but both Apple and third-party developers are busy adding new Automator task support to all sorts of new and existing applications.

## *Creating an application in Automator*

To create a simple application with Automator, launch the application and follow these steps:

- 1. Select Custom and click Choose.**
- 2. Click the desired item in the Library list.**

Automator displays the actions available for the item you've selected. Some of these items are media files, while others include Address Book contacts, files and folders in the Finder, PDF documents and even Apple Mail messages.
- 3. Drag the desired action from the Library window to the workflow window.**
- 4. Modify any specific settings provided for the action you chose.**
- 5. Repeat Steps 1–3 to complete the workflow.**



**6. Click Run (upper right) to test your script.**

Use sample files while you're fine-tuning your application lest you accidentally do something deleterious to an original (and irreplaceable) file!

Figure 20-5 illustrates an application that will take care of the earlier example — resizing and rotating a folder full of images, and then moving them to the Pictures folder.

**7. When the application is working as you like, press ⌘+Shift+S to save it.**

**8. In the Save dialog that appears, type a name for your new application.**

**9. Click the Where pop-up menu and specify a location where the file should be saved.**

**10. Click the File Format pop-up menu and choose Application.**

**11. Click Save.**

Your new Automator application icon appears, sporting an Automator robot standing on a document.

Why, most normal human beings would now call you a *programmer*, so make sure you're inscrutable from now on! If you're going to use your new Automator application often, don't forget that you can make it more convenient to use by dragging the application icon to your Dock, or to your desktop.



To find all the actions of a certain type within the Library list, click in the Search box at the bottom of the Library window and type in a keyword, such as **save** or **burn**. You don't even need to press Return!

**Figure 20-5:**  
Now I'm ready to handle 10 or 1,000 images in a folder — my application does the work!



## Running applications at start up

If your Automator application should run every time you log in, follow these steps to set it up as a Login Item:

1. **Open System Preferences.**
2. **Display the Accounts pane.**
3. **Click the Login Items button.**
4. **Click the plus button at the bottom of the list.**
5. **Navigate to the location of your new Automator application.**
6. **Click Add.**

Now your Automator application is *really* automatic. Watch your significant other gape in amazement as your iMac begins to work without you touching the keyboard! (If you've added the application icon to your Dock, you can also simply right-click on the icon and choose Open at Login from the right-click menu that appears. Either way, your iMac gets the message.)



Many third-party applications have their own Automator actions after installation. Check the developer's Web site often to see whether additional Automator applications have been added that you can download.

## Updating Mac OS X Automatically

I prefer my iMac to take care of cleaning up after itself, so updating Leopard should be automatic as well. In Mac OS X Leopard, operating system updates are performed by the Software Update application.



Software Update uses the Internet, so you need an Internet connection to shake hands with the Apple server and download any updates.

Software Update can be found in two convenient spots:

- ✓ **The Apple menu:** Click the Apple menu () and then click Software Update, which displays the Update dialog and alerts you to anything new that's available.
- ✓ **System Preferences:** Click the Software Update icon to display the Software Update pane that you see in Figure 20-6.



If you take the System Preferences route, you can set Software Update to check for updates automatically:

- a. Mark the *Check for Updates* check box to enable it.
- b. Choose the time period from the *Check for Updates* pop-up menu.

Software Update covers every Apple application, so I usually check once daily just to make sure that I don't miss anything.

If something needs to be updated, the program alerts you, either automatically downloading the update(s) or displaying a dialog letting you know what you can update (depending on the settings you choose in the System Preferences Software Update pane).

You can even check for updates immediately from System Preferences. That, dear reader, is just plain thoughtful design.



**Figure 20-6:**  
Setting up  
Software  
Update  
to launch  
itself, all  
by itself.

# Part VII

## The Part of Tens

The 5<sup>th</sup> Wave

By Rich Tennant



"Everyone here at the museum loves the new iMacs, except the ornithologists. They get a little freaky around the glossy monitors and start attacking their reflection in the screen."

## *In this part . . .*

**A**h, what book in the *For Dummies* series is truly complete without the infamous Part of Tens? Here you find lots of this author's raw opinion: my recommendations for the best Mac applications, the best tips for boosting your computer's performance, and even Ten Things to Avoid Like the Plague.

## Chapter 21

---

# Ten Applications You Can't Do Without

---

### *In This Chapter*

- ▶ Improving Leopard's performance
  - ▶ Running Windows applications in Leopard
  - ▶ Repairing and maintaining disks
  - ▶ Inoculating your system against viruses
  - ▶ Reaching Unix inside Leopard
- 

**A**pplications make the world go around! It's the truth! And although Leopard gets much of the glory for its elegant design and power, you can't really do much productivity-wise from your Desktop without a snappy application. I'm sure that the Laws of Gravity, Magnetism, and Murphy are all controlled somewhere in the cosmos by one heck of a piece of software. (Who owns the Celestial Supercomputer, I don't know . . . but I'll bet it uses an Intel Core 2 Duo processor.)

I dedicate this Part of Tens chapter to listing those applications every Mac owner should know about. Even if you don't use one or two of these great tools now, you'll likely realize that you need and want them in the future.

## *Applications*

This section presents a regular smorgasbord of six applications, running the gamut from DVD entertainment to productivity software. (I've even heard tell that you can run Windows XP or Vista on your iMac, *without* requiring a reboot like the Leopard Boot Camp feature.)

Some of these applications are built in to Mac OS X — read that as *free* — whilst others you must buy. I note here which is which and give you a ballpark price for the commercial stuff.

## *DVDs and CDs*

Half the time we're watchin' 'em, and half the time we're burnin' 'em — DVDs, that is. Apple has always had superior support for DVD hardware; after all, the SuperDrive has been a feature (or featured upgrade) for Macintosh computers for years now. Come explore the best two DVD applications around for your Leopard machine.

### *Watching DVD movies with aplomb*

Face it — that gorgeous widescreen 20" or 24" flat-panel monitor on your Core 2 Duo iMac is perfect for watching DVD movies. (Psst . . . it's okay . . . you can fib to your significant other and your friends that you're using your new super-computer for work. I own an iMac, too, so I understand. *It's an iMac thing.*)

Thanks to our good friends in Cupertino, you'll find that the Leopard DVD Player does a great job at screening all your favorite DVD films:

- ✔ You can display your movie in a window or use the entire screen (especially nice for widescreen titles).
- ✔ If your movie includes different audio tracks, subtitles, and camera angles, you can control them all from the spiffy remote control that appears onscreen whenever you move your mouse.
- ✔ You can step through the video frame by frame or in slow motion to see the martial arts action that you missed in the theater.

By default, DVD Player runs automatically when you load a DVD-Video (DVD-V), including those that you create yourself with iDVD or Roxio Toast.



I especially like the feature that remembers whether you viewed a disc already and also gives you the opportunity to restart the film where you left off.

### *Yes, they really named it Toast*

Until the advent of Mac OS X and the iLife suite, recording audio and data CDs or DVD-Vs on your Mac required using a third-party application. The Cadillac of recording software for the Mac was, is, and will likely always be the unlikely named Toast, from Roxio ([www.roxio.com](http://www.roxio.com)). The latest version is Toast 8 Titanium, available online for about \$80.



The built-in recording features in iTunes and iDVD are certainly fine, and the discs that these two applications produce are compatible with any audio CD player or DVD player that you're likely to find. However, you'll need Toast to

✔ **Produce specialized types of discs.**

This includes

- Hybrid discs that store both Mac and PC data
- ISO 9660 discs for Unix and Linux machines
- Mixed-mode and enhanced CDs that carry both audio and data
- Video CDs and Super Video CDs

✔ **Directly copy an existing CD or unprotected DVD.**

✔ **Mount a DVD image as if it were a physical disc that you loaded into your iMac's optical drive.**

This is definitely a plus if you

- Play games.
- Restore from backup images.

✔ **Recognize older external optical drives that might not be supported within Leopard or the iLife suite.**

For a comprehensive guide to using Toast to create all these types of specialized discs, look no farther than my book *CD & DVD Recording For Dummies*, 2nd Edition (Wiley). It covers Toast Titanium like a layer of syrup.

## *Management and communication*

Both iCal and Apple Mail are mighty applications, bent on organizing things: your time, calendar, and/or your Internet e-mail traffic. (They do a great job, too.) Apple provides both in Mac OS X, so you can keep your credit card in your pocket or purse.



Coverage of iLife applications isn't in this chapter because I cover 'em in depth elsewhere in the book. See all the chapters in Part IV.

### *Staying on top of things with iCal*

iCal is one of those oddities in the computer world. Unlike iTunes or iMovie, it's not particularly sexy (in a multimedia way), and it doesn't get oodles of coverage in the glossy Macintosh magazines. Still, everybody eventually ends up using it. Sooner or later, every Mac owner appreciates iCal as an unsung hero. (And a free unsung hero to boot.)

Unfortunately, iCal can't enter events for you. And take my word for it: The Data Elves aren't going to show up and magically type for you, so you have to create events manually. After they're in the iCal database, however, you can

- ✓ Set alarms for specific events.
- ✓ Add notes for each event.
- ✓ Print a calendar.
- ✓ Import some data automatically from Mail messages and iChat text.
- ✓ Set repeating events on a regular schedule.

By default, iCal includes two calendars — Home and Work — but you can set up as many separate calendars as you like, for scheduling everything from soccer seasons to DVD releases.

Oh, and don't forget about the To Do items, which keep you focused on the tasks that really matter. You can easily sort To Do items by priority or due date; you can also hide items with due dates outside the current calendar page.



If you're a .Mac member, you can publish any calendar online that other folks can then subscribe to (great for clubs and organizations). Or, you can publish your calendar on any Web server that supports WebDAV functionality. Check with your site's Webmaster (or call your Internet service provider; ISP) to see whether you can offer an iCal calendar on your Web site. I discuss the Apple .Mac service at length in Chapter 9.

### ***One doggone good e-mail application***

Ask yourself this question: "Am I taking my e-mail application for granted?" Sure, e-mail might not take center stage in the computer magazines these days, but consider what your life would be like with a substandard, whip-and-buggy e-mail application — almost as bad as no e-mail at all.

The best e-mail applications (like Apple Mail) have powerful, trainable spam filters that improve automatically as you manually check your junk mail. A first-class performer (like Apple Mail) offers fully automated scripting for common tasks, snazzy backgrounds, fonts and colors, and the ability to create HTML-format messages with embedded images and objects. Are you seeing a pattern here?



One of my favorite recent additions to Apple Mail is the ability to organize your messages by threads. (In plain English, a *thread* groups replies so that they can be read as an actual discussion.) Anyone who frequents Usenet newsgroups or Web discussion sites recognizes a threaded view as easier to read than a traditional sequential display, especially when your mail is heavy on replies and includes ongoing conversations with several folks involved.

It's free, it's fun, and it's fashionable — go, Apple Mail, go!

## Productivity

Sooner or later, you're going to need the ability to create grown-up, respectable documents from your iMac, or you might need to run an absolutely-gotta-have-it-application-that's-not-available-for-Macs. (I actually run into very few of those.) In this section, I cover two of my favorite productivity applications — Parallels Desktop and iWork '08 — and the serious stuff they can do.

### *Sweet! Windows Vista on my iMac without rebooting!*

Okay, even I'll admit that there are fewer applications available to Macs than PCs running Windows, and practically every Mac owner on the planet has one or two PC programs that make life easier. Sure, you can use the Leopard Boot Camp feature to set up an XP or a Vista system on your iMac, but you have to reboot to use Windows, and it's very difficult to share Mac data with your Windows applications (even though they're actually on the same computer). More information on Boot Camp is always available from the Mac OS X Help system, but you can start the ball rolling by double-clicking the Boot Camp Assistant icon in your Utilities folder (which is tucked inside your Applications folder). The Assistant provides step-by-step onscreen instructions. Just make sure that you have your Windows XP Service Pack 2 or Windows Vista installation discs handy.

What if you don't want to reboot, and you want to share data easily between your Mac and Windows applications? Luckily, Parallels offers a solution: Parallels Desktop for Mac ([www.parallels.com](http://www.parallels.com)). The program sells for about \$80, but this doesn't include a licensed copy of Windows XP or Vista. (Yeah, you have to provide your own.) However, this nifty program can easily run virtually all Windows XP and Windows Vista programs — *without* rebooting your iMac — complete with support for external USB devices, Ethernet networks, the Internet, and your iMac printer.



Windows programs don't even know the difference because Parallels Desktop simulates an entire PC (complete with a "software-based" — *virtual* — video card and sound card), all while using your iMac's Intel processor, USB keyboard, and mouse!

Parallels Desktop also makes it very easy to share files and data between your Mac and Windows applications because your aluminum supercomputer is still running Leopard. Copying files from one system to another is as easy as drag-and-drop, or you can use the shared folder created on your XP or Vista desktop to pick up your Mac goodies.

Parallels Desktop does have some limitations, though:

- ✔ **You won't be running the latest 3-D games.** To run PC games at their full speed, you have to use Boot Camp and reboot into a native Windows system.
- ✔ **Parallels Desktop requires a fair chunk of your iMac's hard drive space to store your Windows "hard drive-in-a-file."**
- ✔ **Your Windows applications will run slightly slower compared with a Boot Camp installation of XP or Vista.**

However, with the Core 2 Duo processor in your iMac and at least a gigabyte of memory, Parallels Desktop runs surprisingly well. And it's better than rebooting every time you need to run that must-have Windows program, right?



The more memory you install in your iMac, the better Parallels Desktop will run!

You can install

- ✔ **More than one version of Windows**  
I have Windows XP, Windows Vista, and Windows 2000 running within Parallels Desktop, each with its own machine.
- ✔ **Almost any other operating system that's ever been produced for the PC**  
I have a Red Hat Linux drive as well.

Parallels Desktop for Mac makes it easy to shut down a simulated computer — akin to a laptop computer going into hibernation — while keeping your open documents intact. When you reload your “virtual” Windows machine, you're right back at the exact same point when you shut down.

### ***You can quote me: I like the iWork '08 Suite***

I wish I had a dime for every time I've read or heard about how the Macintosh version of Office is so indispensable to every Mac owner and how it should be an automatic purchase at the moment you buy your computer. I admit that the applications that make up Office are superb — I'm writing with Word at this moment — but every new Mac owner should try iWork '08 *before* jumping onto the Microsoft productivity bandwagon.

Why? Well, to be honest, most computer owners simply don't use or need all the features and hoo-hah that's built into the Mac Office applications! For example, if all you produce on paper are simple letters, typical schoolwork, or brochures for your home business, Word might be an expensive case of overkill.



As an author, I confess that I use all the power that Word has to offer — and my publisher requires me to use it, so I shelled out the cash. However, I exchange Word documents all the time with my friends who use the Pages word processing application, which is part of the iWork suite.

The same goes for Excel and PowerPoint. Respectively, Numbers and Keynote are powerful alternatives to their Microsoft counterparts. In fact, all iWork '08 applications offer the same ease-of-use and simplicity you've come to expect from Mac OS X Leopard and iLife '08 programs such as iPhoto, iTunes, and iDVD.



The only core Mac Office application that iWork doesn't match is Entourage, but the combination of Apple Mail, iCal, and Address Book does the same job.



iWork applications offer templates and assistants that are similar to those in Office, so creating all sorts of specialized business and personal documents is easy. New templates and clip art are always available online as well.

So go ahead — visit your Applications folder and give iWork '08 a try. It's fast, it's inexpensive, and I think you'll be pleasantly surprised.

## System Stuff

Ah, utilities. . . I love 'em almost as much as I crave games. I think that most iMac power users would agree with me when I say that a well-maintained Mac is a wonderful machine. To that end, the utilities you find in this last section help keep your hardware, software, and files in tiptop shape.

## Maintenance

Although I devote Chapter 20 to the joys of maintenance, I want to mention the following two applications again, just to make sure you remember them. (The alternative is a tattoo, which is probably overkill.)

### ***Disk repair and so very much more***

If you're not already using Disk Utility, you should. On a regular basis. *Really.*

Most Mac owners think of Disk Utility only for checking internal and external hard drives. But don't forget the most important function (in my opinion) that Disk Utility offers: the ability to fix file and folder permission problems. This is why I recommend that you launch Disk Utility and check your Mac OS

X startup drive on a weekly basis. Permission problems can cause your applications to act like they're on mind-altering drugs or even lock you out of using those applications altogether! (Chapter 18 shows you how to squash permission errors.)

Of course, there's more to Disk Utility, but you're not likely to use heavy-duty functions very often, such as partitioning or RAID management. These are advanced features that one typically uses only when initializing a new hard drive.

### ***"Back, you viruses! Stay back!" I say!***

Blah, blah, blah. . . Unless you've been living in a cave in the Himalayas for the last decade, you already know what I'm going to say about how important it is to protect your iMac from viral infection. I'll save the keystrokes for the next application.

Get yourself an antivirus application — one that automatically checks the discs that you load as well as the stuff that you download. I use VirusBarrier X4 from Intego ([www.intego.com](http://www.intego.com), about \$80 online). Set it to automatically download the latest virus definition files from the Internet and scan your entire system once monthly.

Now you can relax.

## ***Files***

Care to compress a folder full of files to save space on your hard drive or maybe send them via e-mail? Perhaps you'd like to use the keyboard and the power of Unix to perform file manipulation miracles that are practically impossible by using the mouse. Either way, the applications in this final section have you covered.

### ***When a Zip file isn't enough***

In the Windows universe, the WinZip archive file is king, followed by WinRAR and a host of other different archiving formats. Leopard has built-in support for compressing and decompressing Zip archives.

However, for Mac owners Zip files have never been hot stuff (horrible pun intended). Leopard can unarchive a Zip file when necessary — just double-click the archive icon — and you can right-click a file or folder and then choose Compress from the menu to create a Zip archive.

## Archives explained in a small space

An *archive* is a single file that can hold data in a compressed format. Archives offer these advantages:

- ✔ **Take less disk space**
- ✔ **Download faster**
- ✔ **Can hold multiple files and folders**

This is great for easily creating backups or sending a number of images through e-mail as a single attachment.

When you're ready to use the data, you simply *unarchive* the file, which expands the items and restores them to their original form.

"So what do you recommend, Mark?" Easy call, good reader: the smallest and most Mac-friendly archive format has long been the Stuffit format, from Allume Systems ([www.stuffit.com](http://www.stuffit.com)).

The latest version 12 of Stuffit Deluxe will set you back \$80, but it's worth every penny for the convenience and flexibility that archives bring to your Desktop:

- ✔ **Smaller archive file sizes than comparable Zip archives**
- ✔ **Industrial-strength data encryption to secure your archives**
- ✔ **Support for files that normally don't compress well, like JPEG images**
- ✔ **Archive browsing without actually expanding (a real timesaver)**
- ✔ **Direct burn of archived data to CD or DVD**

Oh, by the way, Stuffit Deluxe also opens and creates Zip files. You know, just in case you have to share files with The Great Unwashed Windows Horde.

### *Doing the command line dance*

This must-have application is a little different from the others: You have to type your commands manually, and there are no icons or fancy graphics. You're in the character-based *Twilight Zone*, and only the bravest of Mac novices will venture there.

However, when you launch the Terminal application, you open a window into the Unix core that lies underneath Mac OS X. Suddenly you can do wondrous things that you can't do from the Finder menu:

- ✔ You can manipulate hidden and hard-to-reach files, like preference files.
- ✔ You can work with Unix applications like File Transfer Protocol (FTP) and the Apache Web server.

✓ If you're familiar with wildcards and the command line hieroglyphics that make up Unix, you can manage your files with a speed that no graphical user interface (GUI) can match. (That's a DOS feature I still miss.)



Before you make your move into Unix, I highly recommend that you grab a companion and guide for the journey. A good pick is *UNIX For Dummies*, 5th Edition, by John R. Levine and Margaret Levine Young (Wiley). Without a learning tool that you can use to teach yourself, Terminal is a very lonely window indeed.



## Chapter 22

# Ten Ways to Speed Up Your iMac

---

### *In This Chapter*

- ▶ Adding memory
  - ▶ Using spoken commands
  - ▶ Defragmenting your drive
  - ▶ Banishing the desktop background
  - ▶ Using column mode
  - ▶ Customizing the Dock
  - ▶ Using keyboard shortcuts
  - ▶ Customizing your Finder windows
  - ▶ Launching recent applications and documents
  - ▶ Using the Go menu
- 

**E**ven an iMac with a Core 2 Duo processor can always go just a bit faster . . . or *can* it? There's actually a pretty short list of tweaks that you can apply to your iMac's hardware to speed it up, and these suggestions are covered in this chapter.

You can also work considerably faster within Leopard (the latest Mac OS X version) by customizing your Desktop and your Finder windows, which makes it easier to spot and use your files, folders, and applications. That's in this Part of Tens chapter, too.

Finally, you can enhance your efficiency and make yourself a power user by tweaking yourself. (Sounds a bit tawdry or even painful, but bear with me, and you'll understand.) If you haven't delved into the realm of keyboard shortcuts, the Recent menu, and the Go menu, you'll find that you're taking a number of extra steps that you can eliminate. Soon, you'll be the fastest

component in your whole system! I recommend how you can speed yourself up in this chapter as well.

## *Nothing Works Like a Shot of Memory*

Okay, maybe *shot* is the wrong word, but adding additional memory to your iMac (by either replacing or adding a memory module) is the single surefire way to speed up the performance of your entire system. That includes every application as well as Leopard itself.

Why does additional memory provide such a boost? With more memory, your iMac can hold more of your documents and data in memory, and thus has to store less data temporarily on your hard drive. It takes your iMac much less time to store, retrieve, and work with data when that data is in RAM (short for *random access memory*) rather than on your hard drive. That's why your system runs faster when you can fit an entire image in Photoshop CS3 in your iMac's system memory.



By the way, this tweak works on any computer running Mac OS X, Windows XP/Vista, or Linux/Unix — they all automatically take advantage of as much memory as you can toss their way. My aluminum iMac has a full 4GB of memory, and you can sure tell the difference from the 1GB that it originally shipped with. It's like comparing a Humvee with a Ferrari! (For details on installing more memory, visit the friendly confines of Chapter 19.)

## *Hold a Conversation with Your iMac*

Your iMac can speak any text to you through the Services menu, but that's generally not a big timesaver. (Neat for the kids, I admit, just like spoken alerts — more on this later in this section.) However, many Mac owners will attest that you *can* significantly increase your own efficiency by using the Speakable Items feature, which allows you to speak common commands within applications and Finder windows. Your voice is indeed faster than either your mouse or your fingers! Common commands in the Speakable Items folder include “Log me out,” “Get my mail,” “Hide this application,” and “Open my browser.” You won't find them on your local radio station's Top 40 countdown, but they're popular among the Mac set.

To enable Speakable Items, choose System Preferences⇨Speech and then select the On radio button next to Apple Speakable Items to enable speech recognition. You see the feedback window appear, which includes a convenient sound level meter that you can use to adjust the volume of your voice. Remember, by default, that the speech recognition system is active only when you press and hold the Esc key.

It takes a little practice to enunciate the King's English properly — your iMac is a bit finicky when it comes to recognizing a Texas drawl — but the effort pays off when you realize just how much faster things are moving when you're sitting at your computer.



When you're looking at the Speech pane, click the Text to Speech tab and then select the Announce When Alerts Are Displayed check box to enable it. This activates spoken alerts. I think they're cool. (Any message that's displayed in a dialog will now be spoken automatically.) Enable the Speak Selected Text When the Key is Pressed check box to specify a key that will speak highlighted text in your applications, which is perfect for messing with your co-worker's minds in the office.

## *Vamoose, Unwanted Fragments!*

Apple would probably prefer that I not mention disk fragmentation because Leopard doesn't come with a built-in defragmenting application. (Go figure.)

To keep your hard drive running as speedily as possible, I recommend defragmenting at least once monthly. You can use third-party applications like Micromat's TechTool Pro ([www.micromat.com](http://www.micromat.com)) to defragment your drive.

### **Defraggle rocks**

What's fragmentation? Here's the short version: The longer you use your hard drive (and the more often you create and delete files), the more fragmented those files become on your hard drive, and the longer they take to read. A disk-defragmenting application reads all the files on your drive and rewrites them as continuous,

contiguous files, which your machine can read significantly faster. (In other words, your iMac doesn't have to "piece together" the contents of a file to read it.)

I understand this because I have no patience with puzzles myself.

## *Keep Your Desktop Background Simple*

It's funny that I still include this tip in a chapter dedicated to improving performance. After all, I recommended using a solid color background in my first books on Mac OS 8 and Windows 98! Just goes to show you that some things never change.

Even with the high-powered video cards in today's iMacs, it still takes time for Leopard to redraw your Mac OS X background when you close or hide an application window. And if you're running a number of heavy-duty applications (like Final Cut Pro and Photoshop CS3), you can actually see the block of video memory "blank out" for a few seconds while things grind along. The slowdown is worse when you're using a huge true-color image as a background at 1920 x 1200 on your iMac with the 24-inch screen. Think about all those pixels, and you'll likely get a headache, too.

Therefore, if you're interested in running your system as fast as it will go, choose a solid-color background from the Desktop & Screen Saver pane in System Preferences. (In fact, there's even a separate category that you can pick called Solid Colors.)

## *Column Mode Is for Power Users*

One of my favorite features of Mac OS X is the ability to display files and folders in column view mode. Just click the Column button in the standard Finder window toolbar, and the contents of the window automatically align in well-ordered columns.

So why is column mode so doggone fast? Just imagine drilling through several layers of folders to get to a specific location on your hard drive — for example, `Users/mark/Music/iTunes/iTunes Music`, which I visit on a regular basis. If you use icon view, you have to double-click so often that you'll have to give your mouse button a rest. List view really isn't that much better because the folder contents keep expanding, and you have those doggone expanding/collapsing triangles to deal with.

In column mode, however, a single click drills a level deeper, and often you won't even have to use the Finder window's scroll bars to see what you're looking for. Files and folders appear in a logical order (unlike icon mode) without changing the layout of the window (unlike list mode). Plus, it's much easier to move a file (by dragging it from one location on your hard drive to another) in column mode. I think you'll find column mode both faster and less confusing, which will move you a little closer to your ultimate goal of power-user status.

## Make the Dock Do Your Bidding

Every Mac owner considers the Mac OS X Dock a good friend: It's a control center, a status display, and an organizer all rolled into one. But when's the last time you customized it — or have you ever made a change to it at all?

You can drag files and folders to the Dock, as well as Web URLs, applications, and network servers. You can also remove applications and Web URLs just as easily by dragging the icon from the Dock and releasing it on your Desktop (producing that cool puff of animated smoke that someone in Cupertino is likely still very proud of to this very day).

I find that I make a significant change to my Dock icons at least once every week. I find nothing more convenient than placing a folder for each of my current projects on the Dock or adding applications to the Dock that I might be researching for a book or demonstrating in a chapter.



You can position the Dock at either side of the Desktop or even hide the Dock from sight entirely to give yourself an extra strip of space on your Desktop for application windows. Click the Apple menu () and choose Dock. From the submenu that appears, you can choose either Position on Left or Position on Right, or you can choose Turn Hiding On to instruct the Dock to perform its vanishing act. You can also toggle the Dock's magnifying feature on and off from this menu.

## It All Started with Keyboard Shortcuts

Ask a computing dinosaur like me (who started computing before the arrival of the IBM-PC) how you can spot a *true* power user, and you're likely to get the same answer: Watch how the person uses keyboard shortcuts. A real power user makes use of every keyboard shortcut available, committing those key sequences to memory.

Heck, keyboard shortcuts have been around since the days of WordStar and VisiCalc, back when a mouse was still a living rodent. Although selecting a command from a menu might be intuitive, it's also very time-consuming compared with a simple press of a few keys. The same action gets performed, but if you add up all those seconds of mouse-handling that you save by using keyboard shortcuts, you'll see that you can save hours of productive time every year.

You're likely already using some keyboard shortcuts, like the common editing shortcuts ⌘+C (Copy) and ⌘+V (Paste). When I'm learning a new application, I often search through the application's online help to find a keyboard shortcut table and then print out that table as a quick reference. Naturally, you can also view keyboard shortcuts by clicking each of the major menu groups within an application. Shortcuts are usually displayed alongside the corresponding menu items.

## *Hey, You Tweaked Your Finder!*

Here's another speed enhancer along the same lines as my earlier tip about customizing your Dock: You can also reconfigure your Finder windows to present you with just the tools and locations that you actually use (rather than what Apple *figures* you'll use).

For example, you can Control-click (or right-click) the toolbar in any Finder window and choose Customize Toolbar. By default, Leopard's Finder toolbar includes only the default icon set that you see at the bottom of the sheet, but you can drag and drop all sorts of useful command icons onto the toolbar: Burn (for CDs and DVDs), Delete (which sends the highlighted files or folders to the Trash), and Get Info (the same result as pressing ⌘+I). You can save space by displaying small-sized icons, too.



The Sidebar — which hangs out at the left side of every Finder window — is a healthy, no-nonsense repository for those locations that you constantly visit throughout a computing session. For example, I have both a Games folder and a Book Chapters folder that I use countless times every day — it's important to balance work with pleasure, you know — and I've dragged both of those folders to the Sidebar. Now I can immediately jump to either folder from any Finder window or Open/Save File dialog with a single click of the mouse . . . speedy indeed!

## *Keep in Touch with Your Recent Past*

Click that Apple menu (🍏) and use that Recent Items menu! I know that sounds a little *too* simple, but I meet many new Apple computer owners every year who either don't know that the Recent Items menu exists or forget to use it. You can access both applications and documents that you've used within the last few days.

Most computer users turn to the same applications over and over, and to the same documents several times in each computing session. You can put these items in your Dock or your Sidebar, but they're also available from the Recent Items menu (and you don't have to physically drag things willy-nilly around your Desktop). Consider the Dock and Finder Sidebar as permanent or semi-permanent solutions, and the Recent Items menu as more of a temporary solution to finding the stuff that you're working on right now.

## *Go Where the Going Is Good*

To round out this Part of Tens chapter, I recommend another little-known (and under-appreciated) Finder menu feature (at least among Macintosh novices): the Go menu, which is located on the Finder menu.

The Go menu is really a catchall, combining the most important locations on your system (like your Home folder and your iDisk) with folders that you've used recently. Plus, the Go menu is the place where you can connect to servers or shared folders across your local network or across the Internet.

Pull down the Go menu today — and don't forget to try out those spiffy keyboard shortcuts you see listed next to the command names. (For example, press  $\text{⌘}+\text{Shift}+\text{H}$  to immediately go to your Home folder.) And if a Finder window isn't open at the moment, a new window opens automatically — such convenience is hard to resist!





## Chapter 23

# Ten Things to Avoid Like the Plague

---

### *In This Chapter*

- ▶ Prehistoric USB hardware
  - ▶ Phishing (without a pole)
  - ▶ The ancient floppy disk
  - ▶ Liquid Mac meltdowns
  - ▶ Antique utility software
  - ▶ Illegal software
  - ▶ That nasty root account
  - ▶ Cheap surge protectors
  - ▶ Refurbished stuff
  - ▶ Just plain dirt
- 

**I**f you've read other books that I've written in the *For Dummies* series, you might recognize the title of this chapter: It's a favorite Part of Tens subject of mine that appears often in my work. I don't like to see any computer owner fall prey to pitfalls. Some of these pitfalls are minor — like keeping your iMac clean — but others are downright catastrophic, like providing valuable information over the Internet to persons unknown.

All these potential mistakes, however, share one thing in common: They're *easily prevented* with a little common sense — as long as you're aware of them. That's my job. In this chapter, I fill in what you need to know. Consider these pages as experience gained easily!

## Man, That Is the Definition of Sluggish

Let's see, what could I be talking about? Oh, yes . . . **only** a USB 1.1 external hard drive or CD-ROM drive could be as slow as a turtle on narcotics.

Unfortunately, you'll still find countless examples of USB 1.1 storage hardware hanging around. eBay is stuffed to the gills with USB 1.1 hard drives, and your family and friends will certainly want to bestow that old 4X CD-RW drive to you as a gift. (This is one that you should politely refuse immediately, just like your Aunt Harriet's woebegone fruitcake.) These drives were considered cool in the early days of the colorful iMac G3, when USB was a brand-new technology. Today, however, a USB 1.1 hard drive is simply a slow-as-maple-syrup-in-January embarrassment.

Plenty of great USB 1.1 devices are still around these days (such as joysticks, keyboards, mice, and other controllers), along with printers and scanners that work just fine with slower transfer rates. But if a peripheral's job is to store or move data *quickly* — I'm talking hard drives, network connections, CD-ROM drives, and USB Flash drives — then give any USB 1.1 connection a wide berth, opting instead for a USB 2.0 or FireWire device.

## Phishing Is No Phun

No, that's not a misspelling. In the latest Internet lingo, *phishing* refers to an attempt by unsavory characters to illegally obtain your personal information. If that sounds like an invitation to identity theft, it is — and thousands of sites have defrauded individuals like you and me (along with banks and credit card companies) out of billions of dollars.

A phishing scam works like this: You get an e-mail purporting to be from a major company or business, such as eBay, a government agency, or a major credit card company. The message warns you that you have to update your login or financial information to keep it current, or that you have to validate your information every so often — and even provides you with a link to an official-looking Web page. After you enter information on that bogus page, it's piped directly to the bad guys, and they're off to the races.

Here's a Mark's Maxim that every Internet user should take to heart:



No *legitimate* company or agency will solicit your personal information through an e-mail message!<sup>TM</sup>



**Never respond to these messages.** If you smell something phishy, open your Web browser and visit the company's site (the *real* one) by typing in the address directly; then contact the company's customer support department. (**Remember: Don't use the link provided in the phishing e-mail!**) They'll certainly want to know about the phishing expedition, and you can help by providing them with the e-mail and Web addresses used in the scam.

In fact, sending any valuable financial information through unencrypted e-mail — even to those whom you know and trust — is a bad idea. E-mail messages can be intercepted or can be read from any e-mail server that stores your message.

## Put Floppy Disks to Rest

Did you know that the Apple iMac was the first model produced by a major computer manufacturer that didn't include a floppy drive? Apple always looks ahead five years when it develops a new computer model, and the good folks in Cupertino accurately predicted the demise of the stodgy 1.44MB floppy disk. Why kill off such a computing icon? For a number of very good reasons:

- ✓ **Like the weather:** Floppy disks are downright unreliable because they are easily demagnetized.
- ✓ **Compatibility:** A floppy disk that reads and writes fine on one machine might not be readable in another.
- ✓ **Capacity:** Floppies don't store much, either.
- ✓ **Germ-ridden:** Floppies make great "tour buses" for viruses.
- ✓ **Lack of speed:** Oh, and don't forget that floppies are the slowest form of storage around.

Unfortunately, most PC owners have a shoebox full of floppies with data that might (or might not) still be important, so the floppy continues to persist, like the human appendix. I'm just doing my part to help the evolution of the personal computer by letting you know just how lousy the floppy really is.

If you still need a portable storage bin of some sort to carry from computer to computer, I heartily recommend that you pick up a USB Flash drive. These drives hold anywhere from 128MB to 8GB, and they work in any USB port. (And they're downright warp-drive fast when compared with a floppy disk, especially the USB 2.0 variety.)

## *Do You Really Want a Submerged Keyboard?*

Your answer should be an unequivocal “No!” — and that’s why everyone should make it a rule to keep all beverages well out of range of keyboards, speakers, mice, backup drives, and any other piece of external hardware. Especially when kids or cats are in close proximity to your iMac.

Cleaning up a hazardous soda spill is hard enough in the clear, but if that liquid comes in contact with your iMac, you’re likely to be visited with intermittent keyboard problems (or, in the worst-case scenario, a short in an external peripheral or your iMac’s motherboard).

Suffice it to say that 12 inches of open space can make the difference between a simple cleanup and an expensive replacement!

## *Don’t Use Antiquated Utility Software*

Older iMacs running earlier versions of Mac OS X can use utility software that’s a generation or two back, but if you’re using Leopard you should turn in your older utility programs — for example, an older copy of a disk repair application that supports only Mac OS X Panther. These older disk utility applications can actually do more damage than good to a hard drive under Mac OS X Leopard.

A number of things changed when Apple made the leap to Leopard, including subtle changes to disk formats, memory management within applications, and the maximum supported size of a hard drive. With an out-of-date utility, you could find yourself with corrupted data. Sometimes a complete operating system reinstall is necessary.

Now that you’re using Mac OS X Leopard, make sure that you diagnose and repair disk and file errors by using only a utility application that’s specifically designed to run in Leopard, like TechTool Pro from Micromat ([www.micromat.com](http://www.micromat.com)). Your iMac’s hard drive will definitely thank you.

(Oh, and while you’re at it, don’t forget to check the manufacturer’s Web site for any updates to drivers or application software for your third-party external hardware! ’Nuff said.)

## *Don't Endorse Software Piracy*

This one's a real no-brainer — remember, Apple's overall market share among worldwide computer users currently weighs in at little more than 10 percent. Software developers know this, and they have to expect (and *receive*) a return on their investment, or they're going to find something more lucrative to do with their time. As a shareware author, I can attest to this firsthand.

Pirated software seems attractive — the price is right, no doubt about it — but if you use an application without buying it, you're cheating the developer, who will find Macintosh programming no longer worth the time and trouble. An iMac is a great machine, and Leopard is a great operating system, but even the best hardware and the sexiest desktop won't make up for an absence of good applications. Pay for what you use, and everyone benefits.

## *Call It the Forbidden Account*

You might never have encountered the *root*, or *System Administrator*, account within Mac OS X — and that's always A Good Thing. Note that I'm not talking about a standard administrator (or admin) account here. Every iMac needs at least one admin account (in fact, it might be the only visible account on your computer), and any standard user account can be toggled between standard and admin status with no trouble at all.

The root account, though, is a different beast altogether, and that's why it's disabled by default. All Unix systems have a root account; because Leopard is based on a Unix foundation, it has one, too. Anyone logging in with the root account can do *anything* on your system, including deleting or modifying files in the System folder (which no other account can access). Believe me: Deliberately formatting your hard drive is about the only thing worse than screwing up the files in your System folder.

Luckily, no one can accidentally access the root/System Administrator account. In fact, you can't assign the root account with System Preferences; you must use the Terminal application in Utilities (within your Applications folder). Unless an Apple support technician tells you to enable and use it, you should promptly forget that the root account even exists.

## *Don't Settle for a Surge Suppressor*

Technically, there's nothing wrong with using a surge suppressor to feed power to your iMac and all your external peripherals, but it doesn't do the *entire* job. Your system is still wide open to problems caused by momentary brownouts, not to mention a full-fledged blackout. Losing power in the middle of a computing session will likely lead to lost documents and might even result in disk or file errors later. With a uninterruptible power supply (UPS), you can rest easy knowing that your iMac will have a few minutes more of "ilife," running on battery power until you can close your documents normally and shut down your computer without trauma.

Most Mac owners know about the backup battery power that a UPS provides, but they don't know about the extra work performed by most UPS units: namely, filtering your AC current. Without a filtering UPS, your iMac's power is susceptible to electronic noise (think about a vacuum being used next to a TV set) and momentary current spikes that can eventually cause problems over time. A simple surge suppressor doesn't provide this feature.

These days, you'll find good UPS models for under \$100, so there's no reason not to give your iMac the AC power protection that it deserves!

## *Refurbished Hardware Is No Deal at All*

Boy, howdy, do I hate refurbished stuff. To quote someone famous, "If the deal sounds too good to be true, it probably is."

Examine what you get when you buy a refurbished external hard drive. It's likely that the drive was returned as defective, of course, and was then sent back to the factory. There, the manufacturer probably performed the most cursory of repairs (just enough to fix the known problem), perhaps tested the unit for a few seconds, and then packed it back up again. Legally, retailers can't resell the drive as a new item, so they have to cut the price so low that you're willing to take the chance.

Before you spend a dime on a bargain that's *remanufactured* — I can't get over that term — make sure that you find out how long a warranty you'll receive, if any. Consider that the hardware is likely to have crisscrossed the country at least once, and that it's likely to have picked up a few bumps and bruises during its travels. Also, you have no idea how well the repairs were tested or how thoroughly everything was inspected.

I don't buy refurbished computers or hardware, and most of the tales that I've heard of such behavior have ended badly. Take my advice and spend the extra cash on trouble-free, brand-new hardware that has a full warranty.

## *iMacs Appreciate Cleanliness*

Clean your machine. Every computer (and every piece of computer hardware) appreciates a weekly dusting. Remember, many older iMac models didn't have internal fans, so a shroud of insulating dust (or cooling vents blocked by accumulated crud) could raise the internal temperature to a dangerous level. Even with a fan, dust is an insidious enemy within the confines of your computer's case; I know Mac owners who celebrate each passing year by opening up their machines to blow them clean of dust bunnies with a can of compressed air. (I'm one of them, as a matter of fact.)



Adding memory to your aluminum iMac, as I demonstrate in Chapter 19? Take advantage of the chance and use that trusty can of compressed air to clean up things.

On the outside of your iMac, your screen should be cleaned at least once every two or three days — that is, unless you like peering through a layer of dust, fingerprints, and smudges. Never spray anything — cleaners, water, **anything!** — directly on your screen or your iMac's case. I highly recommend using premoistened LCD cleaning wipes typically used for notebook computers, which safely clean your iMac monitor.

Your iMac case really doesn't need a special cleaning agent — in fact, you shouldn't use any solvents at all — but a thorough wiping job with a soft cloth should keep your case in spotless shape. Those cleaning wipes do a great job on a keyboard too, but it's a good idea to turn your Aluminum Supercomputer off first so that a stray keyboard shortcut doesn't wreak havoc with your system.





# Index

## • Symbols •

⌘+/, 115  
⌘+?, 64  
⌘+!, 114  
⌘ key, 59, 63  
⌘+A, 64  
⌘+B, 114  
⌘+C, 64  
⌘+D, 120  
⌘+Delete, 76  
⌘+F, 108  
⌘+H, 64, 74  
⌘+L, 57, 86  
⌘+M, 64  
⌘+O, 53, 64  
⌘+Option, 58  
⌘+Option+L, 121  
⌘+Option+M, 64  
⌘+Option+W, 64  
⌘+P, 64  
⌘+Q, 55, 64  
⌘+Shift+Delete, 77  
⌘+Shift+H, 70  
⌘+Tab, 64  
⌘+V, 64  
⌘+X, 64  
⌘+Z, 64

## • A •

AAC (Advanced Audio Coding) format, 154, 259–260  
access  
to e-mail/iChat, 275  
Internet, 20, 131, 286–288, 300  
to selected applications, 276–277  
to specific Web sites, 275  
to user accounts, 267, 271, 274–276  
accessories, recommended, 24–25  
activating hot corner, 91  
active window, 67  
Activity Monitor utility, 74  
Add Application button, 93  
Add Bookmark button, 117  
Add button (iDVD), 220, 221  
Address Book, 23, 24  
adjacent items, selecting, 59, 60  
administrator account, 32, 266–273  
Advanced Audio Coding (AAC) format, 154, 259–260  
advanced hardware, 42  
AIFF format, 154  
air flow, 29  
AirPort Base Stations, 290–294  
AirPort Express, 290–292  
AirPort Extreme, 16, 173, 290–292, 329  
album covers, 158, 164, 165  
albums, photo, 180, 184–186, 195–198  
alerts, spoken, 361  
aliases, 57–58  
All Windows key, 79  
Allume Systems, 357  
Animate Opening Applications, 97  
animated buttons, 232–233  
animated themes, 226  
animation, 221, 230, 233–234  
antivirus application, 308, 317–318  
Appearance pane, 94–95  
Apple Authorized Service Provider, 320–321  
Apple Base Station, 289–294  
Apple iMac Support, 320  
Apple Knowledge Base, 294  
Apple Lossless format, 154  
Apple Mail, 30, 51, 352  
Apple menu  
in every Mac OS X application, 40  
forcing quit via, 56  
generally, 50  
launching applications from, 54  
launching System Preferences from, 85, 86  
Apple Remote, 145, 148–150  
Apple service center, 29, 331  
Apple Store, 320  
Apple TV, 158, 172

- Apple TV For Dummies* (Chambers), 172
- Apple Web-based support center, 45
- AppleScript, 342
- application icons, 56, 57, 74, 75
- application menu, 40
- Application Windows key, 80
- applications
  - adding, 93
  - copying, 32, 34
  - deleting, 93, 334–335
  - deleting associated files for, 335–336
  - preference file of, 315
  - restricting access to, 276–277
  - running, in background, 74
  - switching between, 79–80
  - troubleshooting, 315
  - updating, 315
- Apply button, 86
- Aqua Blue background, 28
- archives, 357
- arranging
  - Dashboard widgets, 78
  - Desktop, 72
  - GarageBand tracks, 254–255
  - Library folder, 158
  - photos by events, 186–187
  - video clips, 213
  - windows, 67
- arrow keys, 66
- aspect ratio, 11, 202, 222, 228
- audio, for movies, 208–211
- Audio Adjustments window, 210–211
- audio CDs, 154–157, 173, 261
- audio connections, 15
- audio files, ripping, 165–166
- audio formats, 153–154, 165–166
- audio hardware, 332
- Audio Mute key, 63
- audio options, 13
- audio ports, 13
- Audio well, 230
- audiobooks, 154
- Audition instruments, 258
- Authorized Service Provider, 320–321
- Auto login, 279–280
- AutoFill button, 116
- auto-launch iPhoto, 182
- Automator, 342–345
- Autosplit Events, 182
- **B** •
- Back button, 116
- background
  - animated, 233–234
  - applications running in, 74
  - Aqua Blue, 28
  - Desktop, 73, 86, 90
  - iDVD, 231–233
  - random images for, 91
  - tiled, 90
  - timing of changing images for, 91
- backup(s)
  - to CDs/DVDs, 338–339
  - excluding items from, 100
  - to external hard drives, 338
  - importance of regular, 337
  - installing, 137
  - iTunes, 175
  - manual/automated, 137–138
  - retention of, 99
  - scheduling, 99
  - with Time Machine, 98–100
- backup folder, iDisk, 134
- base stations, 173, 289–294
- batteries, 20, 372
- beat, music, 250
- Birthday (keyword), 188
- black-and-white, switching to, 193
- Block Pop-Up Windows, 127
- Bluetooth, 16
- bookmarks, 78, 117, 120–121
- Bookmarks bar, 114
- Boot Camp, 353
- boot disk or volume, 314
- boot from CD or DVD, 310
- Bove, Tony, 171
- bridge, 288, 289
- brightness, 89, 96, 193
- browser toolbar, iMovie, 203
- browsers, 217, 243. *See also* Safari Web browser
- browsing, 123, 124, 158–159
- bug report, 117–118
- bundled applications, 145
- Burn button (iDVD), 222
- business search, 110
- button captions, 232–233
- buttons, 220, 232–233

## • C •

- cable connection, 286–288, 296, 316
- cables, 13, 19–20, 25
- cache, cleaning, 127
- calendar, 351–352
- camera(s), 145, 146, 179, 183
- Camera Import button, 205
- Caps Lock key, 29
- Cat5/Cat5E cables, 294, 295
- Cat6 cables, 295
- cathode ray tube (CRT) monitors, 11
- CD & DVD Recording For Dummies* (Chambers), 16, 239, 351
- CD-R, 24
- CD-RW, 24
- CDs
  - allowing user to burn, 277
  - backing up to, 338–339
  - blank, 24
  - burning GarageBand music to, 261
  - burning music to, 172–174
  - cleaning, 314
  - disk slot for, 12
  - displaying, 73
  - iTunes support for audio, 154
  - playing audio, 155–156
  - ripping audio, 165–166, 209
  - Toast for special functions with, 350–351
- CDW, 325
- Chambers, Mark, 16, 43, 172, 239, 298, 351
- Change Desktop Background, 73, 86
- Change Pictures, setting time period for, 91
- chassis, computer, 28
- chat, 22, 275
- Checkmark (keyword), 188
- chess, 24
- cleanliness, 373
- cleanup, 334–337
- clock display, with screen saver, 91
- Close button, 56, 68
- close shortcut, 64
- closed networks, 293
- closing windows, 68
- collation, 83
- color, 89, 94
- color profile, 89
- column mode, 362
- Columns buttons, 93
- Command key, 63
- command line, 357–358
- compressed air, 373
- compressing files, 356–357
- computer manuals, 19
- Connected Servers, 73
- connecting your iMac, 19–20
- connection speed, 168
- Content, Parental Controls for, 275
- Content window, 114–115
- contextual menu, 41, 52
- Contour Design, 332
- contrast, 193
- Control-click, 55
- Control+←, 81
- Control+→, 81
- convenience, 18
- cookies, 125–126
- cooling, 17, 29
- copies, number of, 83
- copy shortcut, 64
- copying
  - to different drive, 61
  - documents, 32
  - in Finder, 60–62
  - multiple items, 61
  - network settings, 31
  - on same drive, 60
  - settings, 34
  - System Preferences, 31, 34
  - user accounts, 31, 33
- copy-protection schemes, 154
- copyright, 171
- counter, Webpage, 140
- Cover Flow mode, 158, 164
- Create button (iPhoto), 181
- cropping, 190–192, 214
- CRT (cathode ray tube) monitors, 11
- cut shortcut, 64
- cut-and-paste, 44

## • D •

- damage, checking for, 18
- Dashboard, 77–79, 82, 109–110, 117
- Dashboard corner, 92
- data CDs or DVDs, 173
- data storage, 43
- data transfer, 330

- date, system, 86
- dead pixels, 29
- defragmentation, 361
- Del key, 63, 76, 77
- deleting
  - album photos, 185
  - applications, 93, 334–336
  - bookmarks, 121
  - Dock icons, 75
  - files/folders, 334–335
  - images from camera after importing, 183
  - iPod files automatically, 171
  - movie clips, 212–213
  - playlists, 161
  - songs, 159, 160
  - text, 63
  - user accounts, 272–273
- Desktop
  - about, 38
  - arranging, 72
  - background for, 73, 86, 90
  - Dock on, 39–40
  - Exposé, 92
  - icons on, 40, 51
  - illustration of, 39
  - launching applications from, 54–55
  - menu of, 40–41
  - performance based on simplicity of, 362
  - purpose of, 51
  - shortcuts for. *See* aliases
  - on Windows and iMac, 43
- Desktop key, 80
- Desktop pane, 90–91
- desktops, switching between, 80–82
- Detect Displays button, 89
- Detto Technologies, 35
- DHCP (Dynamic Host Configuration Protocol) server, 288, 296–298
- dialup Internet access, 20, 131, 286, 300
- Dictionary, 109, 275
- digital audio files, 156–160
- digital cameras, 179
- digital extraction, 165
- digital photo files, 35
- digital subscriber line (DSL),
  - 284, 286–288, 296
- digital video files, 160
- digital video (DV) format, 179, 206
- disabling hot corner (term), 91
- disc layout, 339
- disc slot, 10, 12
- discussion boards, 320
- disk permissions, 312–314, 341, 355–356
- disk space, 136
- Disk Utility, 311–314, 316, 355–356
- disks, 73, 314, 355, 369
- display
  - color/resolution of, 89
  - of drives, 73
  - of iPods, 73
  - of Music Library, 158
  - of network connections, 73
  - of peripherals, 73
  - of screen saver clock, 91
  - in Sleep mode, 92
  - of time/date, 86
  - of time/tempo, 244
  - of Trash contents, 76
  - of widgets, 92
  - of windows, 41, 92
- Display Calibrator, 89
- Displays pane, 89
- Dock
  - allowing changes to, 277
  - animating opening applications on, 97
  - configurability of, 40
  - customizing, 363
  - hiding/showing, 97
  - purpose of, 51
  - quitting from, 55
  - screen position of, 97
  - size/magnification of, 96
  - visiting Web sites from, 115–116
- Dock icons, 39, 74–75
- Dock pane, 96–97
- Dock Preferences, 86
- document icons, 56
- documents, 32, 78, 284
- Documents folder, 133
- do-it-yourself instructions, 320
- double-clicking, 44, 54–55, 95
- Download status window, 121
- downloading, 121–122, 143
- drag-and-drop, 44, 61, 62
- dragging, 59
- Drop Box folder, 281
- drop zones, 222, 226
- duplicating items, 62–63

dust, 373  
 DV (digital video) format, 179, 206  
 DVD Map button, 222  
 DVD player, 23, 148, 350  
 DVD-R, 25, 238  
 DVD-R SuperDrive, 15  
 DVD-RW, 25  
 DVDs  
   allowing user to burn, 277  
   backing up to, 338–339  
   blank, 25  
   burning, 238–239  
   cleaning, 314  
   data, 173  
   disk slot for, 12  
   displaying, 73  
   Toast for special functions with, 350–351  
 DVI port, 15  
 dynamic drop zones, 226  
 Dynamic Host Configuration Protocol  
   (DHCP) server, 288, 296–298

## ● **E** ●

ease of use, 42  
 Edit Drop Zones button, 222  
 editing, 44, 190–193, 213–214, 222  
 Editing toolbar, 205  
 Effects button, 193  
 802.11 standard, 289–292  
 eject CDs, 12, 63, 310  
 eject external devices, 76  
 electronic noise, 372  
 Elgato Systems, 150  
 e-mail, 23, 132, 197–199, 275, 352  
 e-mail accounts, 30  
 e-mail button, 140  
 embedded data, 158  
 emptying trash, 77, 335  
 encryption, 12, 281–282, 293, 294  
 Energy Saver pane, 95–96  
 enhanced CDs, 351  
 enhancing images, 192  
 equalizer, volume, 166–167, 257  
 Ethernet, wireless, 16  
 Ethernet 10/100/1000 port, 294  
 Ethernet cable, 20, 25, 292, 294, 295  
 Ethernet jack, 18  
 Ethernet networks, joining wired, 296–297

Ethernet port, 14  
 Ethernet switch, 294, 295  
 Event pane, iMovie, 203, 211–212  
 events, 96, 180, 182, 183, 186–187  
 exit shortcut, 64  
 Expand button, 83  
 expansion, room for, 18  
 exporting movies, 217  
 Exposé, 79–80, 82  
 Exposé & Spaces pane, 92–94  
 Exposé All Windows corner, 92  
 Exposé Application Windows, 92  
 Exposé Desktop corner, 92  
 external devices, 73, 76, 316  
 external hard drive(s), 99, 329–331, 338  
 EyeTV Hybrid, 150

## ● **F** ●

F10 key, 80  
 F11 key, 80  
 F12 key, 78  
 Family (keyword), 187  
 fans, 17, 29  
 fast forward, 149  
 Fast User Switching, 278–280  
 Favorite (keyword), 187  
 Favorite movie scenes, 212  
 file icons, 57  
 file storage, online, 30  
 files  
   application preference, 315  
   audio, 156–160  
   command-line manipulation of, 357–358  
   compressing, 356–357  
   deleting, 171, 334–335  
   downloading, 121–122  
   importing video, 35  
   log, 276  
   MP3/AAC, 259–260  
   orphan, 335–336  
   photo, 35  
   replacing existing, 61, 62  
   restoring, 311, 339–341  
   saving, 257  
   sharing, 284, 301  
   video, 160  
   on Windows and iMac, 43

Files and Settings Transfer Wizard

(Windows XP), 36

FileVault, 281–282

filtering, 105, 106, 372

Final Cut Pro, 217

Find display, 108–109

Finder menu bar, 50

Finder toolbar, 68, 123

Finder window(s)

active, 67

closing, 68

copying items in, 60–62

customizing, 364

duplicating items in, 62–63

icons in, 56–58

illustration of, 50

keyboard shortcuts for, 63–65

launching applications from, 53–55

minimizing/restoring, 66–67

mouse use in, 52–53

moving, 67

moving items in, 62

purpose of, 51

quitting applications in, 55–56

resizing, 66

scrolling in, 65

searching from, 108–109

selecting items in, 59–60

Sidebar of, 61

Simple, 276

togglng, 68

zooming, 67

firewalls, 303–304

FireWire 400 ports, 330

FireWire 800 ports, 330

FireWire cable, 25, 32

FireWire ports, 14

FireWire symbol, 33

FireWire Target Disk mode, 311

flight tracker, 110

floppy disks, 369

folder(s)

aliases for, 58

copying items to, 60–61

deleting, 334–335

duplicating, 63

Home. *See* Home folder

iDisk, 133–134

Library. *See* Library folder

Movies, 133

Music, 133

Pictures, 134

Public, 134, 136, 281

restoring, 339–341

sharing, across networks, 280–281

Sites, 134

Smart, 109

on Windows and iMac, 43, 44

folder icons, 75

font smoothing, 95

foot, iMac, 10, 13

force-quitting, 56, 309

formatting drives, 331

forms, 78, 116

Forward button, 116

fragmentation, 361

Free Positioning, 227

Front Row, 21, 148–150

front-end application, 150

full-screen mode, iPhoto, 181

## • G •

game controllers, 332

games, 24

GarageBand

about, 241

adding tracks with, 245–248

adjusting track settings in, 256–257

arranging tracks in, 254–255

automatic composition, 258

burning to CD with, 261

creating with, 244–245

features of, 242–244

illustration of, 242

looping in, 248–251

Magic, 258–259

MIDI instruments with, 257

MP3/AAC files in, 259–260

podcasting from, 261

resizing/repeating/moving loops in,  
251–254

saving files in, 257

scoring movies with, 252

sharing, 259–261

*GarageBand For Dummies* (LeVitus), 261

Get Info button, 181

Go menu, 70, 365

Google, 110, 115  
 Google Search, 117  
 Grab utility, 78  
 graphical user interface (GUI), 44  
 grayed-out items, 51  
 grayscale, 125  
 Griffin Technology, 332  
 grounding, 326  
 Group accounts, 267  
 group applications access, 276–277  
 Group pane, 86  
 GUI (graphical user interface), 44

## • H •

Hamrick Software, 145  
 hard drives  
   cleaning up, 329  
   displaying, 73  
   external, 329–331  
   iMac, 15  
   importing images from, 183, 207  
   importing movies from, 206–207  
   internal, 331  
   partitioning/erasing, 311  
   permission errors on, 341–342  
   repairing, 314  
   repairing permissions for, 312–314, 355–356  
   in Sleep mode, 95  
   upgrading, 328–331  
 hardware, 30, 42, 372  
 hardware icons, 56  
 HDV (high-definition video) format, 206, 228  
 headphone output, 15  
 health checkup for new iMac, 28–29  
 Help, 44–46  
 Help System shortcut, 64  
 hide shortcut, 64, 74  
 hiding, 97, 164, 243, 275  
 high-definition video (HDV) format, 206, 228  
 highlight color, 94  
 highlighted item, 59, 61  
 high-speed Internet access, 20  
 History, Safari, 122–123, 127  
 Home button, 116, 119  
 Home folder, 69–72, 270, 281–282  
 Home page, 115, 118–119  
 HomePage feature, 138–140  
 Hot Corners button, 91

how-to tutorials, 320  
 hybrid discs, 351  
 Hyperbolic Software, 336

## • I •

iCal, 23, 351–352  
 iChat, 22, 275  
 icon(s)  
   adding, 74–75  
   alias, 57–58  
   application, 56, 57  
   in book, 5–6  
   deleting, 75  
   on Desktop, 40, 51  
   on Dock. *See* Dock icons  
   document, 56  
   file, 57  
   hardware, 56  
   iDisk, 130, 133  
   padlock, 125, 269  
   postage stamp, 51  
   Web URL, 75  
 icon mode, 362  
 iDisk, 129–134, 136  
 iDisk icon, 130, 133  
 iDVD  
   about, 219  
   animating background, 233–234  
   background image, 231–232  
   burning project to DVD, 238–239  
   creating new project in, 222–224  
   customizing movie buttons, 232–233  
   drop zones, 226  
   features of, 220–222  
   illustration of, 221  
   image dimensions, 228  
   Magic, 224, 236–238  
   movies, adding, 226–228  
   music, adding, 230–231  
   OneStep, 223–224, 235–236  
   opening existing project in, 223  
   previewing, 222, 234–235  
   saving, 235  
   slideshow images, 229–230  
   theme selection, 224–226  
   titles, adding, 232  
 IEEE 1394, 330  
 iLife suite, 21

**iMac**

- accessories recommended for, 24–25
- audio connections for, 15
- audio options for, 13
- Bluetooth in, 16
- connecting, 19–20
- disc slot for, 12
- foot/wall adapter for, 13
- games on, 24
- hard drive in, 15
- health checkup for new, 28–29
- iCal/DVD player/Address Book features of, 23–24
- installing software on, 21–22
- Internet features of, 22–23
- keyboard/mouse for, 12
- LCD screen for, 11
- location factors with, 16–18
- opening up your, 325
- optical drive in, 15–16
- parts diagram for, 10
- ports on, 13–15
- power button on, 13
- power cable for, 13
- registering, 31
- support site, 320
- turning on, 27–28
- unpacking, 18–19
- video card in, 16
- Windows XP/Vista on, 36
- wireless Ethernet in, 16

**iMac discussion boards, 320****iMac G4 model, 10****iMac G5 model, 10****iMac Troubleshooting Assistant, 320****images**

- background, 91
- converting, 78
- dimensions, 228
- downloading, 122
- information with, 185
- previewing, 78
- resize/rotate, 78
- still, in movies, 207–208
- tile, 90
- viewing, 148

**iMovie**

- adding media clips, 211–212
- audio in, 208–211

- controls/displays in, 202–204
- deleting media clips, 212–213
- editing clips, 213–214
- illustration of, 203
- importing video clips, 205–207
- launching, 201–202
- moviemaking steps used in, 204
- previewing in, 212
- reordering clips, 213
- sharing, 216–217
- still images in, 207–208
- titles, adding, 215–216
- transitions in, 214–215
- voiceover narration in, 210
- widescreen versus standard display in, 202

**importing**

- images from hard drives, 183, 207
- iMovie video clips, 205–207
- iPhoto images, 182–183, 207
- from iTunes, 208–209
- from Mac computers, 31–34
- Migration Assistant for, 30
- from Windows, 35–36

**indexing, 102****Inspector button (iDVD), 221****instrument tracks, 246****Intego, 317****internal drives, 331****Internet connection, 283–284, 300–301, 316–317****Internet protocol (IP) addresses, 288, 302****Internet router, 288****Internet service provider (ISP), 30, 133, 300****Internet sharing, 283–288, 300–301****Internet tools, 22–23****invoices, 19****IP (Internet protocol) addresses, 288, 302****iPhoto**

- about, 179
- albums organization in, 184–186
- book mode in, 193–195
- brightness/contrast in, 193
- controls in, 179–181
- cropping images in, 190–192
- editing images in, 190–193
- e-mailing images from, 198–199
- enhancing images in, 192
- events organization in, 186–187
- exporting to iMovie, 207



illustration of, 180  
 images organization in, 183–190  
 importing images in, 182–183  
 keywords organization in, 187–189  
 ratings assignment in, 189  
 red-eye removal in, 192  
 retouching images in, 193  
 rotating images in, 190  
 sorting images in, 190  
 switching to black-and-white/sepia in, 193  
 Web Gallery feature of, 195–198  
*iPod & iTunes For Dummies* (Bove and Rhodes), 171  
 iPods, 73, 137, 157, 171  
 iSight camera, 145, 146  
 ISO 9660 discs, 351  
 ISP (Internet service provider), 30, 133, 300  
 iSync, 30  
 iTunes  
   audio formats supported on, 153–154  
   backing up, 175  
   broadcasting, 173  
   burning CDs from, 172–174  
   buying music for, 176–177  
   connecting to iPod, 171  
   deleting songs from, 159, 160  
   equalizing, 166–167  
   exporting to iMovie, 208–209  
   Library on, 158–160  
   movies in, 217  
   network sharing, 172  
   playing CDs with, 155–156  
   playing digital audio/video on, 156–160  
   playlists on, 160–162  
   radio on, 168–171  
   ripping audio files with, 165–166  
   sending podcasts to, 261  
   songs on, 162–165  
   visuals for, 174, 175  
   watching videos with, 160  
 iTunes Plus tracks, 154, 176  
 iTunes Radio, 168, 169  
 iTunes Store, 157, 176–177  
 iWeb, 261  
 iWork suite, 21, 22, 354–355

## • K •

key(s)  
   modifier, 92  
   music, 245  
   special, 63  
   startup, 310–311, 318  
 keyboard(s), 10, 12, 25, 29, 370  
 Keyboard & Mouse pane, 52, 65  
 keyboard cable, 19  
 keyboard shortcuts  
   for applications, 363–364  
   in Front Row, 149  
   in iTunes, 156  
   in Leopard, 64  
   reason for using, 63  
   setting, 92, 94  
   three-key, 65  
 Keystation 49e (keyboard), 332  
 keyword(s), 102, 187–189  
 Kids (keyword), 187

## • L •

launching applications, 53–55, 58  
 LCD screen, 10, 11, 24, 28–29, 373  
 LEAP encryption, 293, 294  
 Leopard Boot Camp, 36  
 Leopard operating system  
   Desktop of, 38–41  
   Help system of, 44–46  
   older utility-software problems with, 370  
   preinstalled, 27  
   reliability/performance/ease of use  
     with, 42  
   setting up, 29–30  
   Unix advantage of, 41, 43  
   updates to, 315, 345–346  
   Windows' similarities to, 42–44  
 Levine, John R., 358  
 LeVitus, Bob, 261  
 Library folder, 134, 157, 158–159, 172, 217  
 lighting, 18  
 Line In jack, 15  
 links, 115  
 Linux, 41

- list mode, 362
  - Live Updating, 162
  - local user groups, 46
  - location factors, 16–18
  - locked application, 309
  - log files, 276
  - logging out, 280
  - login(s), 278–280
  - Login Items
    - Automator applications as, 345
    - disabling, 310, 311, 318
    - launching applications with, 55
    - setting up, 273
  - Loop Browser button, 243
  - loops
    - defined, 243
    - resizing/repeating/moving, 251–254
    - selecting, 248–251
  - lossless format, 154
- M •**
- .Mac accounts, 131–132
  - Mac computers, importing, 31–34
  - .Mac online hosting service
    - accounts, opening, 131–132
    - backup of, 137–138
    - defined, 129
    - HomePage publisher with, 138–140
    - iDisk icon, 130
    - iDisk usage with, 132–136
    - Web Gallery on, 195–198
  - Mac OS X, 43, 54, 315
  - Mac OS X Console messages, 311
  - Mac OS X discussion boards, 320
  - Mac OS X Hints, 45
  - Mac OS X Leopard (version 10.5), 27. *See also* Leopard
  - Mac OS X Leopard All-in-One Desk Reference For Dummies* (Chambers), 43, 298
  - .Mac subscription service, 30
  - Mac support Web sites, 45
  - MacAddict* magazine, 45
  - MacFixIt, 45
  - MacMall, 325
  - MacMinute, 45
  - MacUninstaller, 336
  - Macworld* magazine, 45
  - magazines, 45
  - Magic GarageBand, 258–259
  - Magic iDVD, 224, 236–238
  - magnification, 96
  - Mail application, 23, 275
  - Mail Contents of this Page, 125
  - Managed user accounts, 267, 271, 274–276
  - map, of DVD layout, 222
  - master password, 281–282
  - M-Audio, 332
  - media, iDVD, 220
  - Media Browser, 217
  - Media Browser button, 243
  - Media Eject key, 12, 63
  - media formats, iTunes, 153–154
  - Media pane, iDVD, 220
  - memory, 323–328, 360
  - menu bar, 92
  - menu commands, 3, 40
  - Menu display, iDVD, 220
  - menu path, 51
  - menus, 40, 41, 51
  - merge events, 187
  - metadata, 103
  - Micromat, 308, 370
  - microphone, 209–210
  - MIDI instruments, 257
  - Migration Assistant, 30–34
  - mini-DVI port, 15
  - minimize all windows shortcut, 64
  - Minimize button, 67
  - Minimize Using menu, 97
  - minimizing window, 64, 66–67, 95
  - mirror feature, 134–135
  - mixed-mode CDs, 351
  - MLC Radio, 169, 170
  - modems, 14, 20
  - modifier keys, 92, 94
  - monitor display, iMovie, 203
  - Motion button (iDVD), 221
  - mouse, 10, 12, 25, 29, 52
  - mouse cable, 19
  - mouse pointer, 115
  - mouse shortcuts, setting, 92, 94
  - MOV format, 206
  - Move2Mac software, 35, 36
  - movie scores, 252

moviemaking steps, 204–205  
 movies, 35, 154, 221, 226–228  
 Movies folder, 133  
 moving  
   items, 62  
   items, to Trash, 76  
   loops, 253  
   windows, 67  
 MP3 format, 153, 165–166, 173, 259–260  
 MPEG-4 format, 206, 226  
 multiplayer games, 284  
 multiuser iMac, 266, 277–282  
 music, 35, 230–231, 284  
 Music folder, 133  
 Music Library, 156–160  
 mute track, 253  
 mute volume, 12, 63, 156

## • N •

narration, movie, 210  
 Nathan, Jonathan, 315  
 navigation, Safari, 116–118  
 network(s)  
   advantages of, 283–284  
   connecting to, 297–302  
   file sharing on, 301  
   firewalls with, 303–304  
   Internet access on, 286–288, 300–301  
   printer sharing on, 301–302  
   sharing folders across, 280–281  
   sharing media across, 172  
   specifying, 97  
   Spotlight Search on, 106  
   verifying connection to, 298–299  
   Web sites run from, 302  
   wired connections to, 294–297  
   wired versus wireless, 284–286  
   wireless connections to, 289–294  
 network access, 20  
 network connections, 73, 316–317  
 network printers, 144  
 network settings, 31  
 New Finder window, 70–72  
 Newegg, 325  
 newsgroups, 45  
 next, 156  
 Noise Reduction, 210

nonadjacent items, selecting, 59  
 Normalize Clip Volume button, 210–211  
 notifications, of non-allowed e-mail requests, 275

## • O •

Office documents, importing, 35  
 OneStep DVD, 223–224, 235–236  
 online file storage, 30  
 Open dialog, 70  
 Open in Dashboard button, 117  
 Open Preferences menu, 86  
 open shortcut, 64  
 operating system (OS)  
   Leopard. *See* Leopard operating system  
   Mac OS X. *See* Mac OS X  
   reliability/performance/ease of use in, 42  
 optical drives, 12, 15–16, 351  
 optical output, 15  
 Option key, 62, 63  
 Option+Close button, 68  
 organizational chart, 222  
 organize mode, iPhoto, 183–190  
 orphan files, 335–336  
 OS. *See* operating system (OS)  
 outlets, 18

## • P •

packing materials, 19  
 padlock icon, 125, 269  
 page ranges, printing, 83  
 Pages, 21, 22, 355  
 Parallels Desktop for Mac, 353–354  
 parameter RAM (PRAM), 311  
 Parental Controls, 267, 274–276  
 partitioning drives, 311, 331, 356  
 parts, iMac, 10, 18  
 Party Shuffle playlist, 162  
 password(s)  
   allowing changes to, 277  
   encrypted network, 293, 294  
   for iDisk Public folder, 136  
   as login requirement, 278  
   master, 281–282  
   for new accounts, 269  
   for turning off screen saver, 91

- Password Assistant, 269
  - Password Hint, 269–270
  - paste shortcut, 64
  - patches, 315, 320
  - pause, 149
  - PDF documents, 78, 84
  - performance, 42, 324
  - performance enhancement, 360–365
  - peripherals, 14, 73
  - permission errors, 341–342
  - permissions, 30, 312–314, 341, 355–356
  - personal information, 30
  - phishing scams, 368–369
  - photo books, 193–195
  - Photo Booth, 145–147
  - photos. *See* images; slideshows
  - physical hard drives, 312
  - Pictures folder, 134
  - pinging, 298–299, 317
  - piracy, 371
  - pixels, 28–29
  - Places heading, 61
  - play, 149
  - Play button (GarageBand), 244
  - playhead, 205, 212, 222, 243
  - playlists, 157, 160–162, 170–171
  - podcast artwork tracks, 246
  - podcasts, 154, 248, 261
  - pop-up ads, 127
  - ports, 13–15, 19, 303–304, 330
  - positioning, 227
  - postage stamp icon, 51
  - power button, 13, 27–28
  - power cable, 13, 19
  - power users, 2
  - PRAM (parameter RAM), 311
  - preference files, 315
  - Preferential Treatment, 315
  - Preview mode, 234
  - previewing
    - iDVD, 222, 234–235
    - in Leopard, 78
    - movies, 212
    - printed documents, 83
    - slideshows, 196
    - Web pages, 140
  - previous, 149, 156
  - Print button, 117
  - print shortcut, 64
  - printer drivers, 142, 143
  - printers, 82, 141–144, 277, 284, 301–302
  - printing, 82–84, 125
  - privacy, Web, 125–127
  - Privacy Agreement, 116
  - Privacy tab, 107–108
  - profanity, 275
  - Project Info dialog, 235
  - Project pane, iMovie, 204, 211
  - Public folder, 134, 136, 281
  - public IP address, 302
  - publishing Web pages, 138–140
- *Q* •
- quarantine, virus, 317
  - Quick Look, 55, 78
  - QuickTime, 122, 206, 217
  - Quit command, 55
  - quitting, 55–56, 309
- *R* •
- radio, 154, 168–170
  - RAID arrays, 311
  - RAID management, 356
  - RAM (random access memory), 325
  - random access memory (RAM), 325
  - Random Screen Saver, 91
  - ratings, photo, 189
  - RDF Site Summary (RSS) pages, 119
  - real instrument tracks, 246
  - really simple syndication (RSS) pages, 119
  - reboot, 308–310
  - Recent Items, 55, 95, 364–365
  - red-eye, removing, 192
  - refresh, 117
  - refresh rate, 89
  - refurbished hardware, 372
  - registering your iMac, 31
  - registration information, 30
  - Rejected movie scenes, 212
  - reliability, 42
  - Reload button, 117
  - remanufactured, 372
  - Remove Application button, 93
  - Repair Disk Permissions, 312–314, 341, 355–356

Report Bug button, 117–118  
 Resize handle, 66  
 resizing, 66, 252  
 resolution, 89, 194, 206–207, 228  
 restoring window, 67  
 Retouch feature, 193  
 reverse shortcut, 64  
 rewind, 149  
 Rhodes, Cheryl, 171  
 right-click menu, 41, 52, 53, 55  
 ripping audio files, 165–166, 209  
 RJ-45 connectors, 294  
 root, 61  
 root account, 371  
 rotating images, 190, 214  
 router, 288  
 Rows buttons, 93  
 Roxio, 239, 339, 350  
 RSS (RDF Site Summary or really simple syndication) pages, 119  
 running programs, on Windows and iMac, 44

## • S •

Safari Web browser  
 bookmarks on, 120–121  
 downloading files with, 121–122  
 Find feature of, 123  
 History list on, 122–123  
 home page in, 118–119  
 illustration of, 114  
 Internet Explorer versus, 22  
 launching, 113  
 mailing from, 125  
 navigating with, 116–118  
 personal-information permission for, 30  
 printing from, 125  
 privacy on, 125–127  
 RSS Web sites from, 119  
 saving Web pages with, 124  
 sections of, 114–115  
 tabbed browsing with, 123, 124  
 Web site access from, 115–116  
 Safe Boot mode, 310  
 Save dialog, 70

saving  
 documents, 68  
 in GarageBand, 257  
 in iDVD, 235  
 original software, 19  
 Web pages, 124  
 scanners, 144–145  
 scheduling  
 backups, 99  
 start up/shut down, 96  
 screen, LCD. *See* LCD screen  
 screen position, 97  
 screen saver, 91, 319  
 screen snapshot, 78  
 screen wipes, 24, 373  
 scroll arrows, 94  
 scroll bars, 65–66, 95  
 scroll wheel, 52, 65  
 SDTV format, 202  
 search  
 for album covers, 164  
 for associated application files, 335–336  
 Finder, 108–109  
 for images, 181  
 Internet, 109–110  
 for item on Web page, 123  
 in Music Library, 159  
 Spotlight. *See* Spotlight Search  
 of System Preferences settings, 87–88  
 Search For section, 61  
 Secure Empty Trash, 77  
 secure sites, 125  
 security  
 on Apple Base Station, 293  
 of downloading files, 122  
 of iDisk, 130  
 of iDisk Public folder, 136  
 login, 278–280  
 of shared services, 98  
 of Web Gallery, 197  
 of Web sites, 116  
 of wireless versus wireless networks, 285  
 Security pane, 91  
 selecting items, 59, 60, 64  
 Send Permission Requests To, 275  
 Send Screen Shot of Current Page, 117

- Send Source of Current Page, 117
- separator line, 75
- sepia, switching to, 193
- service, Apple, 320–321
- settings
  - adjusting track, 256–257
  - copying, 34
  - network, 31
  - Parental Control, 274–275
  - System, 274, 276–277
  - System Preferences, 87–88
- setup process, 29–30
- Shared folder, 280–281
- shared media, 172
- shared music, 157
- sharing
  - documents, 284
  - files, 284, 301
  - GarageBand, 259–261
  - Internet. *See* Internet sharing
  - iTunes, 172
  - Library folder, 172
  - movies, 216–217
  - on multiuser iMac, 280–281
  - music, 284
  - photo albums, 195–198
  - videos, 284
- Sharing Only accounts, 267
- Sharing pane, 97–98
- SHARK2 radio, 332
- Shift+Tab, 59
- shortcuts. *See* aliases; keyboard shortcuts
- Show All, 86
- Show All Bookmarks, 120
- Show Displays, 89
- Show Dock, 97
- Show Song Artwork, 164
- Show TV Safe Area, 228
- Show View Options, 72
- Shut Down, scheduling, 96
- ShuttleXpress, 332
- Sidebar, Finder, 61, 68, 70, 71, 364
- signal range, 289
- Simple Finder, 276
- Single User mode, 311
- Sites folder, 134
- size
  - of Dock, 96
  - of e-mail images, 198
  - of text, 117
- Sleep Display corner, 92
- Sleep mode, 92, 95, 96, 138, 149
- slideshows, 148, 181, 196, 221, 229–230
- Smart Album, 185
- Smart Folder, 109
- smart playlists, 162
- Smith Micro Software, 336
- smooth scrolling, 95
- software
  - downloading, 143
  - pre-installed, 21–22
  - saving original, 19
- Software folder, 134
- software instrument tracks, 246, 247
- software instruments, 257
- software piracy, 371
- Software Update, 54, 345–346
- song information, 158, 162–165
- songs, 159, 160, 161
- sorting, iPhoto, 190
- sound effects, 209
- Sound pane, 86, 87
- sound volume. *See* volume(s)
- Source list, 157, 180
- Spaces corner, 92
- Spaces feature, 80–82, 92, 93
- Speakable Items, 360–361
- speakers, 13, 173
- speech recognition, 361
- speed, 20, 168. *See also* performance
  - enhancement
- spoken alerts and text, 361
- Spotlight index file, 102
- Spotlight Search
  - about, 102–103
  - Boolean words in, 104–105
  - customizing, 106–108
  - filtering, 105, 106
  - launching, 101
  - private items eliminated from, 107–108
  - results from, 103–104
  - security of, 105
  - on System Preferences window, 88

Spring Cleaning, 336–337  
 Stack, 75  
 Standard user accounts, 267, 271, 274–276  
 Start Up, scheduling, 96  
 startup keys, 310–311, 318  
 static electricity, 326  
 status bar, Safari, 115  
 status line, 60  
 stereo speakers, 13  
 still images, 207–208  
 Stop button, 117  
 storage, mirror, 134–135  
 storage folders, iDisk, 133–134  
 streaming Internet radio, 154, 168, 169  
 StuffIt utility, 336, 357  
 submenus, 220  
 Super Video CDs, 351  
 support, iMac, 30, 31, 45, 320  
 surge suppressor, 24, 372  
 switch shortcut, 64  
 Switchers, 2, 35–36, 42  
 switching, 79–82  
 synchronize, 135, 171  
 System Administrator account, 371  
 system boot menu, 311  
 System Preferences  
   Appearance pane in, 94–95  
   Apple menu, launching from, 54  
   changes within, 316  
   copying, 31, 34  
   Desktop pane in, 90–91  
   Displays pane in, 89  
   Dock pane in, 96–97  
   Energy Saver pane in, 95–96  
   exiting, 86  
   Exposé & Spaces pane in, 92–94  
   illustration of, 87  
   launching, 85–86  
   for mouse, 65  
   return to top-level, 86  
   Screen Saver pane in, 91  
   searching through, 87–88  
   Security pane in, 91  
   Sharing pane in, 97–98  
   Spotlight Search in, 88, 106–108  
   Time Machine pane in, 98–100  
   System Profiler, 319–320  
 System settings, 274, 276–277

## • T •

Tab, 59  
 tabbed browsing, 123, 124  
 tabbed buttons, 86  
 TB (terabyte), 15, 328  
 TechTool, 308  
 TechTool Pro, 370  
 telephone jack, 18  
 telephone support, 30  
 temperature, 373  
 terabyte (TB), 15, 328  
 text, spoken, 361  
 text log files, 276  
 Text Size button, 117  
 themes, DVD, 220, 224–226  
 threads, 352  
 three-key shortcuts, 65  
 thumbnail(s)  
   of Content window, 114  
   event, 187  
   in iMovie, 211  
   in Photo Booth, 146  
   resizing, 181  
   slideshow, 230  
   theme, 225  
   for user accounts, 270–271  
 Tidy Up!, 336  
 tile images, 90  
 time, changing system, 86  
 Time Capsule, 290, 292, 329, 339  
 Time Limits button, 276  
 Time Machine, 99, 339–341  
 Time Machine pane, 98–100  
 time signature, 245  
 Timed Screen, 78  
 Timeline, GarageBand, 243, 251  
 Time/Tempo display (GarageBand), 244  
 title bar, 67  
 titles, movie, 215–216, 232  
 Toast Titanium, 239, 339, 350–351  
 toggling toolbars, 68  
 toolbar(s)  
   customizing, 116  
   Finder, 123  
   iMovie, 203, 205

toolbar(s) *continued*

- iPhoto, 181
- Safari, 114
- toggling, 68

Toolbar button, 68

Track Info button, 243

Track list, 243

tracks, 243, 245–248, 254–257

transitions, 214–215

Trash

- display contents of, 76
- emptying, 77, 335
- iTunes in, 159
- moving items to, 76
- rescuing items from, 76
- troubleshooting contents of, 316

trimming, 214

troubleshooting

- Apple Help Online for, 320
- Disk Utility for, 311–314
- myths about, 307–308
- with reboot, 308–310
- service centers for, 320–321
- special keys for, 310–311
- steps for, 314–320

turning off, your iMac, 28

turning on, your iMac, 27–28

tutorials, 320

TV broadcasts, 150

• U •

Undo feature, 186, 213, 250

uninterruptible power supply (UPS), 24, 372

Universal Serial Bus ports. *See* USB (Universal Serial Bus) ports

Unix, 41–43, 371

*UNIX For Dummies* (Levine and Young), 358

unpacking your iMac, 18–19

updates

- Apple iMac Support site for, 320
- automatic Mac OS X, 54, 345–346
- iDisk, 130
- to third-party drivers, 370
- troubleshooting, 315

UPS (uninterruptible power supply), 24, 372

USB 1.1 devices, 330, 368

USB 2.0 ports, 330

USB cable, 25

USB (Universal Serial Bus) ports, 14, 19, 330

USB printers, 141–143

Usenet newsgroups, 45

user accounts

- about, 266
- adding, 268–270
- administrator. *See* administrator account
- copying, 31, 33
- Login Items, setting up, 273–274
- modifying, 270–271
- Parental Controls on, 274–276
- System controls on, 276–277
- thumbnail image for, 270–271

user groups, 46

username, 278

utility software, 370



Vacation (keyword), 188

vents, cooling, 17, 29

VESA mounting adapter, 13, 17

video card, 16

video CDs, 351

video clips, 205–207, 211–212

video controllers, 332

video tracks, 246

videoconferencing, 22

videos, 35, 147, 154, 160, 284

Viewer pane, image, 181

View/Hide Loop Browser button, 243

View/Hide Media Browser button, 243

Virus Barrier X, 317, 318

virus scan, 317–318

visuals, iTunes, 174, 175

Voiceover, 210

volume(s)

- controlling, 12, 63
- of data stored on hard drive, 312
- equalizer, 166–167
- FrontRow, 149
- GarageBand, 244, 253
- iTunes, 156
- keyboard shortcuts for, 149, 156

Volume Down key, 63

Volume Up key, 63

VueScan, 145



• **W** •

wall, mounting iMac on, 17  
 wall adapter, 13  
 WAN (wide area network), 292  
 warranty, 331, 372  
 WAV format, 154  
 weather, 109  
 Web addresses, 3  
 Web archives, 124  
 Web Gallery, 195–198, 217  
 Web pages, 124, 125, 138–140  
 Web searches, 22  
 Web sites  
   allowing access to specific, 275  
   author's, 170  
   iCal on, 352  
   Mac support, 45  
   running, from networks, 302  
   security of, 116  
   visiting, 115–116  
 Web surfing, 22  
 Web URL icons, 75  
 Web-based support center, Apple, 45  
 WebClip widget, 79  
 well (term), 90  
 WEP encryption, 293, 294  
 wide area network (WAN), 292  
 widescreen aspect ratio, 11, 202, 222, 228  
 widgets, 77, 92, 109–110, 117  
 windows, 41, 44, 68, 92

Windows Easy Transfer (Windows Vista), 36  
 Windows OS, 2, 35–36, 42–44, 353–354  
 Windows Vista, 36, 41  
 Windows XP, 36  
 wipes, screen, 24, 373  
 wired keyboards, 12  
 wired networks, 284–286, 294–297  
 wireless Ethernet, 16  
 wireless keyboards, 12, 20  
 wireless modem, 296  
 wireless mouse, 12, 20  
 wireless networks, 284–286, 289–294  
 workflows, 342  
 wrist rests, 25

• **X** •

XML file, 217

• **Y** •

Yellow Pages, 110  
 Young, Margaret Levine, 358  
 YouTube, 217

• **Z** •

Zip archives, 356  
 Zoom button, 67  
 Zoom feature, 67

