

Making Everything Easier!™

2nd Edition

Beekeeping

FOR

DUMMIES®

Learn to:

- Build and maintain your own beehives
- Handle all phases of honey production
- Use the latest tools and equipment
- Explore the theories behind and the environmental, economic, and societal impact of Colony Collapse Syndromet

Howland Blackiston

Beekeeper and cofounder and President
of bee-commerce.com



Beekeeping
FOR
DUMMIES®
2ND EDITION

by Howland Blackiston

Foreword by Kim Flottum

Editor, Bee Culture Magazine



WILEY

Wiley Publishing, Inc.

Beekkeeping For Dummies® 2nd Edition

Published by
Wiley Publishing, Inc
111 River St.
Hoboken, NJ 07030-5774

www.wiley.com

Copyright © 2009 by Wiley Publishing, Inc., Indianapolis, Indiana

Published by Wiley Publishing, Inc., Indianapolis, Indiana

Published simultaneously in Canada

No part of this publication may be reproduced, stored in a retrieval system, or transmitted in any form or by any means, electronic, mechanical, photocopying, recording, scanning, or otherwise, except as permitted under Sections 107 or 108 of the 1976 United States Copyright Act, without either the prior written permission of the Publisher, or authorization through payment of the appropriate per-copy fee to the Copyright Clearance Center, 222 Rosewood Drive, Danvers, MA 01923, 978-750-8400, fax 978-646-8600. Requests to the Publisher for permission should be addressed to the Permissions Department, John Wiley & Sons, Inc., 111 River Street, Hoboken, NJ 07030, (201) 748-6011, fax (201) 748-6008, or online at <http://www.wiley.com/go/permissions>.

Trademarks: Wiley, the Wiley Publishing logo, For Dummies, the Dummies Man logo, A Reference for the Rest of Us!, The Dummies Way, Dummies Daily, The Fun and Easy Way, Dummies.com, Making Everything Easier, and related trade dress are trademarks or registered trademarks of John Wiley & Sons, Inc. and/or its affiliates in the United States and other countries, and may not be used without written permission. All other trademarks are the property of their respective owners. Wiley Publishing, Inc., is not associated with any product or vendor mentioned in this book.

LIMIT OF LIABILITY/DISCLAIMER OF WARRANTY: THE PUBLISHER AND THE AUTHOR MAKE NO REPRESENTATIONS OR WARRANTIES WITH RESPECT TO THE ACCURACY OR COMPLETENESS OF THE CONTENTS OF THIS WORK AND SPECIFICALLY DISCLAIM ALL WARRANTIES, INCLUDING WITHOUT LIMITATION WARRANTIES OF FITNESS FOR A PARTICULAR PURPOSE. NO WARRANTY MAY BE CREATED OR EXTENDED BY SALES OR PROMOTIONAL MATERIALS. THE ADVICE AND STRATEGIES CONTAINED HEREIN MAY NOT BE SUITABLE FOR EVERY SITUATION. THIS WORK IS SOLD WITH THE UNDERSTANDING THAT THE PUBLISHER IS NOT ENGAGED IN RENDERING LEGAL, ACCOUNTING, OR OTHER PROFESSIONAL SERVICES. IF PROFESSIONAL ASSISTANCE IS REQUIRED, THE SERVICES OF A COMPETENT PROFESSIONAL PERSON SHOULD BE SOUGHT. NEITHER THE PUBLISHER NOR THE AUTHOR SHALL BE LIABLE FOR DAMAGES ARISING HEREFROM. THE FACT THAT AN ORGANIZATION OR WEBSITE IS REFERRED TO IN THIS WORK AS A CITATION AND/OR A POTENTIAL SOURCE OF FURTHER INFORMATION DOES NOT MEAN THAT THE AUTHOR OR THE PUBLISHER ENDORSES THE INFORMATION THE ORGANIZATION OR WEBSITE MAY PROVIDE OR RECOMMENDATIONS IT MAY MAKE. FURTHER, READERS SHOULD BE AWARE THAT INTERNET WEBSITES LISTED IN THIS WORK MAY HAVE CHANGED OR DISAPPEARED BETWEEN WHEN THIS WORK WAS WRITTEN AND WHEN IT IS READ. FULFILLMENT OF EACH COUPON OFFER IS THE SOLE RESPONSIBILITY OF THE OFFEROR.

For general information on our other products and services, please contact our Customer Care Department within the U.S. at 877-762-2974, outside the U.S. at 317-572-3993, or fax 317-572-4002.

For technical support, please visit www.wiley.com/techsupport.

Wiley also publishes its books in a variety of electronic formats. Some content that appears in print may not be available in electronic books.

Library of Congress Control Number: 2009921472

ISBN: 978-0-470-43065-1

Manufactured in the United States of America

10 9 8 7 6 5 4 3 2 1



About the Author



Howland Blackiston has been a backyard beekeeper since 1984. He's written many articles on beekeeping and appeared on dozens of television and radio programs (including The Discovery Channel, CNBC, CNN, NPR, Sirius Satellite Radio and scores of regional shows). He has been a keynote speaker at conferences in more than 40 countries. Howland is cofounder and president of bee-commerce.com, an internet-based store offering beekeeping supplies and equipment for the backyard beekeeper. Howland is the past president of Connecticut's Back Yard Beekeepers Association, one of the nation's largest regional clubs for the hobbyist beekeeper. Howland, and his wife Joy live in Weston, Connecticut.

Dedication

This book is lovingly dedicated to my wife Joy, who is the queen bee of my universe. She has always been supportive of my unconventional whims and hobbies (and there are a lot of them) and never once did she make me feel like a dummy for asking her to share our lives with honey bees. I also thank our wonderful daughter Brooke (now grown and married), who like her mother, cheerfully put up with sticky kitchen floors and millions of buzzing “siblings” While growing up in our bee-friendly household.

Author's Acknowledgments

I was very fortunate, when I started beekeeping, that I met a masterful beekeeper who took me under his wing and taught me all that is wonderful about honey bees. Ed Weiss became a valued mentor, a great friend, and ultimately a partner in business. I am deeply appreciative of his friendship and bee-wisdom. Ed served as the technical review editor for this book, and I am most appreciative of the many hours he spent checking my facts to ensure that I had been an attentive student. Thank you Ed.

My good friends Anne Mount and David Mayer played a key role in the creation of this book. Both of them are authors, and both encouraged me to contact the “Dummies” team at Wiley Publishing. “You should write a book about beekeeping, and they should publish it,” they urged. Well, I did and they did. Thank you Anne and David. I owe you a whacking big jar of honey!

A good how-to book needs great how-to images. Special thanks to John Clayton for the stunning cover image and some of the other close-ups used in the book. Thanks also to Steve McDonald and Dr. Edward Ross who provided most of the stunning macrophotography used in this book. I extend my gratitude for images (and technical suggestions) provided by Kim Flottum at Bee Culture magazine. Image credits also go to The National Honey Board, the U.S. Department of Agriculture, Marco Lazzari, Peter Duncan, Eric Erickson, Reg Wilbanks, Mario Espinola, David Eyre, Swienty Beekeeping Equipment, E. H. Thorne Ltd., Wellmark International, Barry Birkey, and Kate Solomon. And thanks to fellow beekeeper and friend Stephan Grozinger, who patiently served as my model for some of the how-to photographs.

Thanks also to Leslie Huston for her help with the chapter on raising queen bees, to Ellen Zampino for her section on planting flowers for your bees, and to Patty Pulliam for her wonderful beeswax recipes.

Writing this book was a labor of love, thanks to the wonderful folks at Wiley Publishing: Tracy Brown Collins, my project editor, who also did the copy editing; Erin Calligan Mooney, my acquisitions editor; and Erin Smith, the book's production coordinator, who handled nearly everything to do with the way the words and images ultimately appeared on the page. What a great team!

Publisher's Acknowledgments

We're proud of this book; please send us your comments through our Dummies online registration form located at <http://dummies.custhelp.com>. For other comments, please contact our Customer Care Department within the U.S. at 877-762-2974, outside the U.S. at 317-572-3993, or fax 317-572-4002.

Some of the people who helped bring this book to market include the following:

Acquisitions, Editorial, and Media Development

Project Editor: Tracy Brown Collins
(Previous Edition: Suzanne Snyder)

Acquisitions Editor: Erin Calligan Mooney

Editorial Program Coordinator: Joe Niesen

Technical Editor: Ed Weiss

Art coordinator: Alicia South

Senior Editorial Manager: Jennifer Ehrlich

Editorial Supervisor and Reprint Editor:
Carmen Krikorian

Editorial Assistant: David Lutton

Cartoons: Rich Tennant
(www.the5thwave.com)

Composition Services

Project Coordinator: Erin Smith

Layout and Graphics: Samantha K. Allen,
Reuben W. Davis, Melissa K. Jester,
Brent Savage

Proofreaders: John Greenough, Toni Settle

Indexer: Steve Rath

Publishing and Editorial for Consumer Dummies

Diane Graves Steele, Vice President and Publisher, Consumer Dummies

Kristin Ferguson-Wagstaffe, Product Development Director, Consumer Dummies

Ensley Eikenburg, Associate Publisher, Travel

Kelly Regan, Editorial Director, Travel

Publishing for Technology Dummies

Andy Cummings, Vice President and Publisher, Dummies Technology/General User

Composition Services

Gerry Fahey, Vice President of Production Services

Debbie Stailey, Director of Composition Services

Contents at a Glance

<i>Foreward</i>	<i>xvii</i>
<i>Introduction</i>	<i>1</i>
<i>Part I: Falling in Love with a Bug</i>	<i>7</i>
Chapter 1: To Bee or Not to Bee?	9
Chapter 2: Life Inside the Honey Bee Hive	21
<i>Part II: Starting Your Adventure</i>	<i>45</i>
Chapter 3: Alleviating Apprehensions and Making Decisions	47
Chapter 4: Basic Equipment for Beekeepers.....	59
Chapter 5: Obtaining and Installing Your Bees	91
<i>Part III: Time for a Peek</i>	<i>109</i>
Chapter 6: Opening Your Hive	111
Chapter 7: What to Expect when You're Inspecting.....	125
Chapter 8: Different Seasons, Different Activities	145
<i>Part IV: Common Problems and Simple Solutions</i>	<i>163</i>
Chapter 9: Anticipating and Preventing Potential Problems	165
Chapter 10: Colony Collapse Disorder	189
Chapter 11: Diseases and Remedies.....	197
Chapter 12: Honey Bee Pests	207
Chapter 13: Raising Your Own Queens	229
<i>Part V: Sweet Rewards</i>	<i>247</i>
Chapter 14: Getting Ready for the Golden Harvest.....	249
Chapter 15: Honey Harvest Day.....	263
<i>Part VI: The Part of Tens</i>	<i>277</i>
Chapter 16: (Almost) Ten Fun Things to Do with Bees.....	279
Chapter 17: Ten Frequently Asked Questions About Bee Behavior.....	305
Chapter 18: My Ten Favorite Honey Recipes	309

<i>Appendix A: Helpful Resources</i>	317
<i>Appendix B: Beekeeper's Checklist</i>	331
<i>Glossary</i>	335
<i>Index</i>	341

Table of Contents

Foreward xvii

Introduction 1

What I Assume about You 1
How This Book Is Organized 1
 Part I: Falling in Love with a Bug..... 2
 Part II: Starting Your Adventure..... 2
 Part III: Time for a Peek..... 2
 Part IV: Common Problems & Simple Solutions 3
 Part V: Sweet Rewards 3
 Part VI: The Part of Tens..... 4
Icons Used in This Book 4

Part 1: Falling in Love with a Bug..... 7

Chapter 1: To Bee or Not to Bee? 9

Discovering the Benefits of Beekeeping 10
 Harvesting liquid gold: Honey 11
 Bees as pollinators: Their vital role to our food supply 12
 Being part of the bigger picture: Save the bees! 13
 Getting an education: And passing it on! 13
 Improving your health: Bee therapies and stress relief..... 14
Determining Your Beekeeping Potential 15
 Environmental considerations 15
 Zoning and legal restrictions..... 16
 Costs and equipment..... 16
 Time and commitment 17
 Beekeeper personality traits 18
 Allergies 18

Chapter 2: Life Inside the Honey Bee Hive 21

Basic Body Parts 22
 Skeleton..... 22
 Head..... 22
 Thorax 24
 Abdomen..... 25
The Amazing Language of Bees 25
 Pheromones..... 25
 Shall we dance? 26



Dividing Honey Bees into Three Castes.....	27
Her majesty, the queen	27
The industrious little worker bee	30
The woeful drone	35
The Honey Bee Life Cycle	36
Egg	36
Larva.....	38
Pupa.....	39
Other Stinging Insects.....	41
Bumblebee	41
Carpenter bee.....	42
Wasp	42
Yellow jacket	43
Bald-faced hornet.....	44

Part II: Starting Your Adventure..... 45

Chapter 3: Alleviating Apprehensions and Making Decisions 47

Overcoming Sting Phobia	48
Knowing what to do if you're stung.....	49
Watching for allergic reactions	50
Building up a tolerance	51
Understanding Local Laws and Ordinances	51
Easing the Minds of Family and Neighbors	51
Location, Location, Location: Where to Keep Your Hives	53
Providing for your thirsty bees.....	55
Understanding the correlation between geographical area and honey flavors	57
Knowing When to Start Your Adventure	57

Chapter 4: Basic Equipment for Beekeepers 59

Finding Out about the Langstroth Hive	59
Knowing the Basic Woodenware Parts of the Hive.....	61
Hive stand	63
Bottom board	63
Entrance reducer	63
Deep-hive body	64
Queen excluder	64
Shallow or medium honey super	65
Frames	67
Foundation.....	69
Inner cover.....	71
Outer cover.....	73

Ordering Hive Parts..... 73
 Startup hive kits..... 74
 Setting up shop..... 74
 Adding on Feeders..... 75
 Hive-top feeder..... 75
 Entrance feeder..... 77
 Pail feeder..... 78
 Baggie feeder..... 79
 Frame feeder..... 80
 Fundamental Tools..... 81
 Smoker..... 81
 Hive tool..... 81
 Bee-Proof Clothing..... 82
 Veils..... 83
 Gloves..... 84
 Really Helpful Accessories..... 84
 Elevated hive stand..... 85
 Frame rest..... 86
 Bee brush..... 87
 Slatted rack..... 87
 Screened bottom board..... 88
 Other necessities..... 89

Chapter 5: Obtaining and Installing Your Bees..... 91

Determining the Kind of Bee You Want..... 91
 Deciding How to Obtain Your Initial Bee Colony..... 94
 Ordering package bees..... 94
 Buying a “nuc” colony..... 95
 Purchasing an established colony..... 97
 Capturing a wild swarm of bees..... 97
 Picking a Reputable Bee Supplier..... 97
 Deciding When to Place Your Order..... 99
 The Day Your Girls Arrive..... 100
 Bringing home your bees..... 101
 Recipe for sugar syrup..... 101
 Putting Your Bees into the Hive..... 102

Part III: Time for a Peek..... 109

Chapter 6: Opening Your Hive..... 111

Establishing Visiting Hours..... 111
 Setting an Inspection Schedule..... 112
 Preparing to Visit Your Hive..... 112
 Making “non-scents” a part of personal hygiene..... 113
 Getting dressed up and ready to go..... 113
 Lighting your smoker..... 114

Opening the Hive	117
Removing the hive-top feeder	119
Removing the inner cover.....	121
The Hive's Open! Now What?.....	122
Chapter 7: What to Expect when You're Inspecting	125
Exploring Basic Inspection Techniques	125
Removing the first frame.....	126
Working your way through the hive.....	128
Holding up frames for inspection	128
Knowing when it's time for more smoke	130
Understanding what to always look for	130
Replacing frames.....	132
Closing the hive.....	132
Your New Colony's First Eight Weeks.....	133
Checking in: A week after hiving your bees.....	133
The second and third weeks	136
Weeks four through eight	139
Chapter 8: Different Seasons, Different Activities.....	145
Lazy, Hazy, Crazy Days of Summer	145
Your summer "to-do" list	146
Your summer time commitment.....	146
Falling Leaves Point to Autumn Chores.....	147
Your autumn "to-do" list.....	147
Your autumn time commitment.....	150
Clustering in a Winter Wonderland.....	151
Your winter "to-do" list.....	152
Your winter time commitment.....	152
Spring Is in the Air (Starting Your Second Season).....	153
Your spring "to-do" list	153
Your springtime commitment	155
Administering spring medication	155
Reversing hive bodies	156
The Beekeeper's Calendar.....	158
How to Use this Tool.....	159
 Part IV: Common Problems and Simple Solutions	 163
Chapter 9: Anticipating and Preventing Potential Problems	165
Running Away (To Join the Circus?).....	166
Swarming.....	166
Absconding.....	176
Where Did the Queen Go?	176
Letting nature take its course	177
Ordering a replacement queen	177
Introducing a new queen to the hive.....	178

Avoiding Chilled Brood.....	179
Dealing with the Dreaded Robbing Frenzies	180
Knowing the difference between normal and abnormal (robbing) behavior	180
Putting a stop to a robbing attack	181
Preventing robbing in the first place.....	181
Ridding Your Hive of the Laying Worker Phenomenon.....	182
How to know if you have laying workers	183
Getting rid of laying workers	184
Preventing Pesticide Poisoning	185
The Killer Bee Phenomenon.....	186
What are “killer bees”?	186
Bee prepared!	187
Chapter 10: Colony Collapse Disorder	189
What Is CCD?	189
The warning signs.....	190
What to Do If You Suspect CCD?	190
Why All the Fuss?	191
What’s Causing CCD?	191
The cell phone theory	191
It may be the perfect storm.....	192
Answers to FAQs.....	193
What You Can Do to Help.....	194
A Final Word.....	195
Chapter 11: Diseases and Remedies	197
Medicating or Not?	197
Knowing the Big Six Bee Diseases	198
American foulbrood (AFB)	198
European foulbrood (EFB).....	199
Nosema.....	201
Chalkbrood	201
Sacbrood.....	202
Stonebrood	202
A handy chart.....	203
Chapter 12: Honey Bee Pests	207
Parasitic Mites	207
Varroa mites	207
Go au naturel!	214
Tracheal mites.....	215
Wax Moths.....	220
Small Hive Beetle	221
Determining whether you have a small hive beetle	221
How to control the small hive beetle	222
Ants, Ants, and More Ants.....	222
Bear Alert!.....	223

Raccoons and Skunks.....	224
Keeping Out Mrs. Mouse	225
Some Birds Have a Taste for Bees.....	226
Pest Control.....	226

Chapter 13: Raising Your Own Queens. 229

Why Raising Queens Is the Bee's Knees	229
Accentuate the Positive.....	230
What Makes a Queen a Queen	232
How do they mate?	233
Creating Demand: Making a Queenless Nuc.....	233
Queen Rearing: The Miller Method	234
The Doolittle Method: Grafting.....	238
Tools and equipment	238
How it's done.....	240
Providing nuptial housing.....	242
Finding a Home for Your Queens	243
The Queen Breeder's Calendar	244
Marking and Wing-Clipping	245

***Part V: Sweet Rewards* 247**

Chapter 14: Getting Ready for the Golden Harvest. 249

Having Realistic Expectations.....	250
What Flavor Do You Want?	250
Choosing Extracted, Comb, Chunk, or Whipped Honey.....	251
Extracted honey.....	251
Comb honey.....	251
Chunk honey.....	252
Whipped honey	252
The Right Equipment for the Job	253
Honey extractors	253
Uncapping knife	254
Honey strainer.....	254
Other handy gadgets for extracting honey.....	255
Comb honey equipment.....	258
Honey containers.....	258
Planning Your Honey Harvest Setup.....	258
Branding and Selling Your Honey.....	260
Creating an attractive label	260
Finding places to market your honey.....	262
Selling your honey on the Web	262

Chapter 15: Honey Harvest Day 263

Knowing When to Harvest.....	264
Bad things come to those who wait!	265

Getting the Bees Out of the Honey Supers 265
 Shakin’ ’em out 266
 Blowin’ ’em out..... 267
 Using a bee escape board 267
 Fume board and bee repellent 268
 Honey Extraction 101 270
 Cleaning Up After Extracting 273
 Controlling wax moths 274
 Harvesting wax..... 275

Part VI: The Part of Tens..... 277

Chapter 16: (Almost) Ten Fun Things to Do with Bees 279

Making Two Hives From One 279
 Making One Hive From Two 281
 Establishing a Nucleus Hive 283
 Starting an Observation Hive 284
 Planting Flowers for Your Bees 286
 Building Your Own Hives..... 289
 Brewing Mead: The Nectar of the Gods 292
 Create Cool Stuff with Propolis..... 294
 Propolis tincture 295
 Propolis ointment 296
 Propolis varnish..... 296
 Making Gifts From Beeswax 297
 Beeswax candles 298
 Beeswax furniture polish 299
 Beauty and the bees 299

**Chapter 17: Ten Frequently Asked Questions
 About Bee Behavior..... 305**

Chapter 18: My Ten Favorite Honey Recipes..... 309

Appendix A: Helpful Resources..... 317

Honey Bee Web Sites..... 317
 Bee-commerce.com 317
 About.com (beekeeping homepage) 318
 Apiservices — Virtual beekeeping gallery..... 318
 BeeHoo — The beekeeping directory 318
 Bee-Source.com..... 318
 Bee Master Forum..... 319
 Betterbee..... 319
 Mid Atlantic Apiculture Research and
 Extension Consortium (MAARAC) 319

Mite control using essential oils	320
National Honey Board	320
Bee Organizations and Conferences	320
American Apitherapy Society.....	320
American Beekeeping Federation.....	321
American Honey Producers Association	321
Apimondia: International Federation of Beekeepers' Associations	322
Bee Research Laboratory	322
Eastern Apiculture Society	323
International Bee Research Association	323
The Western Apiculture Society	324
Apiary Inspectors of America.....	324
Bee Journals & Magazines	324
American Bee Journal	324
Bee Culture	325
Bee World	325
The Speedy Bee.....	326
Beekeeping Supplies & Equipment.....	326
Bee-commerce.com	326
The Beez Neez Apiary Supply	327
Brushy Mountain Bee Farm	327
Dadant & Sons, Inc.....	328
Glorybee Foods, Inc.....	328
Mann Lake Ltd.....	328
Rossman Apiaries	329
Swienty Beekeeping Equipment.....	329
Thorne Beekeeping Supply.....	330
The Walter T. Kelley Company	330
State Bee Inspectors (United States)	330
 <i>Appendix B: Beekeeper's Checklist.....</i>	<i>331</i>
 <i>Glossary</i>	<i>335</i>
 <i>Index.....</i>	<i>341</i>

Foreword

There are many good reasons to keep bees.

And although there are far more than I can possibly list here, I'd like to make sure you are aware of those few that I think are most important. Certainly at the top of the list is that honey bees enhance the productivity of our gardens, our farms, and the wild plants everywhere due to their pollinating behaviors. There's a conspiracy between plants and bees — where bees gather a flower's nectar and pollen for food and in the process share one flower's pollen with the next flower they visit. Thus both plants benefit and can set the seeds of their next generation.

Meanwhile, the honey bee helps herself to the sweet and nutritious rewards offered by the flowers. These rewards are used to feed the young and sustain the honey bee colony over the winter. What a grand relationship. Both flowers and bees, and even beekeepers benefit.

Beekeepers and honey bees have a similar sort of arrangement. Honey bees, driven by instinct to gather as much of nature's bounty as possible, often store far more than they can ever use. This they share with their keepers, who in turn provide home and hearth, safety and protection for the colony, their queen and their future. Both are winners in this honeyed dance.

But beekeepers have had to pay more attention to the safety and protection they have been providing because unknown and unseen perils have come to visit our bees. Colony Collapse Disorder and other deadly pests are causing our bees problems. In some cases serious problems.

But we have responded in the new ways of the world. We've developed new and innovative Integrated Pest Management systems that control these pests, that care for the nutrition and health of our bees, that shield their young from harm, and that protect them from the things that go bump in the hive. We've learned that there are many, many ways to win these battles, ways that are safe, sane and healthy for both beekeepers and their bees. These are the beekeeping practices of the future. These are what we must know, and what we must do.

And beekeepers are learning the many advantages of growing their own. Beekeepers are producing their own queens, selected to thrive in their own backyards, chosen to grow where the beekeeper lives. These are the bees of the future. This is beekeeping at its best.

This new edition of *Beekeeping For Dummies* opens the door to this future. And the only Dummies are those that choose not to go through.

Kim Flottum
Editor, *Bee Culture Magazine*

Introduction

Keeping honey bees is a unique and immensely rewarding hobby. If you have an interest in nature, you'll deeply appreciate the wonderful world that beekeeping opens up to you. If you're a gardener, you'll treasure the extra bounty that pollinating bees bring to your fruits, flowers, and vegetables. In short, you'll be captivated by these remarkable little creatures in the same way others have been captivated for thousands of years.

Becoming a beekeeper is easy and safe — it's a great hobby for the entire family. All you need is a little bit of guidance to get started. And that's exactly what this book is for. I provide you with a step-by-step approach for successful backyard beekeeping — follow it closely, and you can have a lifetime of enjoyment with your bees.

What I Assume about You

If you've never kept bees, this book has all the information you need to get started in beekeeping. I assume that you have no prior knowledge of the equipment, tools, and techniques — complete ignorance, in the best sense of the word!

However, if you've been a beekeeper for a while, this book is a terrific resource for you, too. You'll find new ideas on how to keep your bees healthier and more productive. You may appreciate the way the book has been organized for easy and ongoing reference. I include the latest information on honey bee health and medications, plus a whole lot of "tricks of the trade." In short, this book is for just about anyone who's fallen in love with the bountiful honey bee.

How This Book Is Organized

This book is a reference, not a lecture. You certainly don't have to read it from beginning to end unless you want to. I organized the chapters in a logical fashion, with sensitivity to the beekeeper's calendar of events. I include lots of great photographs and illustrations (each, I hope, is worth a thousand words) and lots of practical advice and suggestions. The following sections describe how the book is structured:

Part I: Falling in Love with a Bug

Before becoming a beekeeper, take a moment to get to know the honey bee.

Chapter 1 explains basic bee anatomy and how bees communicate with each other. It also introduces you to the various kinds of honey bees and other stinging insects.

Chapter 2 gives you some insight into “a day in the life of the honey bee.” You find out about the queen, the workers, and the drones, and the roles each plays in the colony.

Part II: Starting Your Adventure

This is where the fun begins! Here’s where you find out how to get started with your first colony of honey bees.

Chapter 3 deals with any apprehensions you may have about beekeeping (stings, neighbors, and so on). This chapter tells you where you should locate your hive and how you can get started.

Chapter 4 shows the basic equipment you need and how to assemble it. You find out about really cool gadgets and weird and wonderful hives.

Chapter 5 helps you decide the kind of honey bee to raise, and when and how to order your bees. Find out what to do the day your “girls” arrive and how to successfully transfer them to their new home.

Part III: Time for a Peek

Here’s where you get up-close and personal with your honey bees. This is the heart of the book because it shares useful tips and techniques that help you develop good habits right from the start. You find out the best and safest way to inspect and enjoy your bees.

Chapter 6 clearly explains how to go about approaching and opening up a colony of bees.

Chapter 7 helps you understand exactly what you’re look for every time you inspect a colony. I include the specific tasks that are unique to the weeks immediately following the arrival of your bees, as well as throughout the season.

Chapter 8 discusses the tasks a beekeeper must perform year-round to maintain a healthy colony. Use it as a checklist of seasonal activities that you can refer back to year after year. There's a really neat "Beekeeper's Calendar" that's keyed to different climates across the country. Use this to identify the tasks you should do, and when.

Part IV: Common Problems & Simple Solutions

Okay, I admit it. Sometimes things go wrong. But don't worry. This section tells you what to expect and what to do when things don't go as planned.

Chapter 9 shows you how to anticipate a number of the most common problems. Find out what to do if your hive swarms or simply packs up and leaves. Discover how to recognize problems with brood production and your precious queen.

Chapter 10 provides information about a topic that's all the buzz in the media: Colony Collapse Disorder. Get the skinny on what we know and do not know about CCD. Learn what you can to help save the honey bees.

Chapter 11 takes a detailed look at bee illnesses. Learn what medications you can use to keep your bees healthy and productive, year after year.

Chapter 12 shows you how to deal with some common pests of the honey bee — mites, birds, insects, and other troublesome critters.

Chapter 13 teaches you the basics for how you can raise your own queen bees for fun and profit. Raising your own queens is a proven way to ensure strong, healthy honey bees by breeding queens from your colonies exhibiting the most desirable genetics (healthy, productive, and gentle).

Part V: Sweet Rewards

This is what beekeeping is all about for most people — the honey harvest!

Chapter 14 gets you ready for your honey harvest. Decide what kind of honey you'd like to make. Find out about the equipment you need and how to plan for the big harvest.

Chapter 15 gives you a step-by-step approach for harvesting, bottling, and marketing your honey. The chapter also includes some practical advice for what to do after the harvest is over.

Part VI: The Part of Tens

No *For Dummies* book is complete without the Part of Tens, so I offer a collection of fun lists. Not a bad way to squeeze a whole bunch of extra, helpful information into a book.

Chapter 16 lists ten fun, bee-related activities, including information about starting an observation hive, brewing honey wine, building your own hives, and making products from beeswax and propolis.

Chapter 17 answers the most frequently asked questions about bee behaviors that I've received from beekeepers.

Chapter 18 includes ten of my all-time favorite honey recipes. After all, there's a lot more uses for honey than just spreading it on toast!

I also include some back-of-book materials, including a lot of really helpful bee-related resources: Web sites, journals, suppliers, and beekeeping associations. I also give you a glossary of bee and beekeeping terms that you can use as a handy quick reference, and some useful templates for creating your own beekeeping checklists and logs. Finally, there are some special offers that you can take advantage of for purchasing new beekeeping equipment and subscribing to one of the leading bee journals.

Icons Used in This Book



Peppered throughout this book are helpful icons that present special types of information to enhance your reading experience:

Think of these tips as words of wisdom that — when applied — can make your beekeeping experience more pleasant and fulfilling!



These warnings alert you to potential beekeeping boo-boos that could make your experiences unpleasant and/or your little winged friends unhappy or downright miserable. Take them to heart!



I use this icon to point out things that need to be so ingrained in your beekeeping consciousness that they become habits. Keep these points at the forefront of your mind when caring for your bees.



From time to time, I explain some new terminology that is basic beekeeping parlance. Learn some new words and some insights to the world of the hive!



Here I share with you some personal beekeeping anecdotes and “betcha didn’t know” facts about these winged wonders!

Part I

Falling in Love with a Bug

The 5th Wave

By Rich Tennant



"Nothing's more relaxing than sitting back and watching my bees do what comes naturally to them."

In this part . . .

Here's where you get to know more about the remarkable honey bee. See what makes them tick, understand how they communicate with each other, and find out about their different roles and responsibilities as members of the colony.

Chapter 1

To Bee or Not to Bee?

In This Chapter

- ▶ Finding out about the many benefits of beekeeping
 - ▶ Admiring the honey bee's vital role in nature
 - ▶ Deciding whether beekeeping is for you
-

I've been keeping bees in my backyard since 1983, and I have a confession to make — I really love my bees. That may sound weird to you if you aren't a beekeeper (yet!), but virtually everyone who keeps bees will tell you the same thing and speak with deep warmth about “their girls.” They impatiently await their next opportunity to visit their hives. They experience a true emotional loss when their bees don't make it through a bad winter. Beekeepers, without a doubt, develop a special bond with their bees.

Since becoming a backyard beekeeper, I've grown to deeply admire the remarkable qualities of these endearing creatures. As a gardener, I've witnessed firsthand the dramatic contribution they provide to flowering plants of all kinds. With honey bees in my garden, its bounty has increased by leaps and bounds. And then there's that wonderful bonus that they generously give me: a yearly harvest of sweet liquid gold.

Once you get to know more about bees' value and remarkable social skills, you'll fall in love with them too. They're simply wonderful little creatures. Interacting with them is an honor and a privilege. People who love nature in its purest form will love bees and beekeeping.

That being said, in this chapter, I help you better understand the remarkable and bountiful little honey bee by looking at its history and the value that it brings to our lives. I also discuss the benefits of beekeeping and why you should consider it as a hobby — or even a small business venture. This chapter gives you an idea of what equipment you'll need to get started, the time you should expect to spend maintaining a healthy hive, and how deep your pockets need to be. It also discusses the optimal environmental conditions for raising bees and ends with a checklist that you can fill out to see if beekeeping is for you.

The prehistoric bee

Bees have been around for a long, long time, gathering nectar and pollinating flowers. They haven't changed much since the time of the dinosaurs. The insect shown in the following

figure is definitely recognizable as a bee. It was caught in a flow of pine sap 30 to 40 million years ago and is forever preserved in amber.



Courtesy of Mario Espinola, www.espd.com

Discovering the Benefits of Beekeeping

Why has mankind been so interested in beekeeping over the centuries? I'm sure that the first motivator was *honey*. After all, for many years and long before cane sugar, honey was the primary sweetener in use. I'm also sure that honey remains the principal draw for many backyard beekeepers. Chapters 14 and 15 deal with how to produce, harvest, and market your honey.

Honeybee or honey bee?

This is a “tomato/*tomahto*” issue. The British adhere to their use of the one word: “honey-bee.” The Entomological Society of America, however, prefers to use two words “honey bee.” Here’s the society’s rationale: The honey

bee is a true bee, like a house fly is a true fly, and thus should be two words. A dragonfly, on the other hand, is not a fly; hence it is one word. **Note:** Spell it both ways when Web surfing. That way, you’ll cover all bases and hit all the sites!

But the sweet reward is by no means the only reason folks are attracted to beekeeping. For a long time, agriculture has recognized the value of pollination by bees. Without the bees’ help, many commercial crops would suffer serious consequences. More on that later. Even backyard beekeepers witness dramatic improvements in their gardens’ yields: more and larger fruits, flowers, and vegetables. A hive or two in the garden makes a big difference in your success as a gardener.

The rewards of beekeeping extend beyond honey and pollination. Bees produce other products that can be harvested and put to good use, including beeswax, propolis, and royal jelly. Even the pollen they bring back to the hive can be harvested (it’s rich in protein and makes a healthy food supplement in our own diets).

Harvesting liquid gold: Honey

The prospect of harvesting honey is certainly a strong attraction for new beekeepers. There’s something magical about bottling your own honey. And I can assure you that no other honey tastes as good as the honey made by your own bees. Delicious! Be sure to have a look at Chapter 18, where I list some delicious recipes for cooking with honey.

How much honey can you expect? The answer to that question varies depending on the weather, rainfall, and location and strength of your colony. But producing 60 to 80 pounds or more of surplus honey isn’t unusual for a single colony. Chapters 14 and 15 provide plenty of useful information on the kinds of honey you can harvest from your bees and how to go about it. Also included are some suggestions on how you can go about selling your honey — how many hobbies can boast a profitable return on investment!

Why bees make great pollinators

About 90 crops in the United States depend on bees for pollination. Why is the honey bee such an effective pollinator? Because she's uniquely adapted to the task. Here are several examples:

- ✔ The honey bee's anatomy is well suited for carrying pollen. Her body and legs are covered with branched hairs that catch and hold pollen grains. The bee's hind legs contain *pollen baskets* that the bee uses for transporting pollen, a major source of food, back to the hive. If the bee brushes against the stigma (female part) of the next flower she visits and brushes off some of the pollen grains, the act of cross-pollination is accomplished.
- ✔ Most other insects lie dormant all winter and in spring emerge only in small numbers, until increasing generations have rebuilt the population of the species. Not the honey bee. Its hive is perennial. The honey bee overwinters, with large numbers of bees feeding on stored honey. Early in the spring, the queen begins laying eggs, and the already large population explodes. When flowers begin to bloom, each hive has tens of thousands of bees to carry out

pollination activities. By mid-summer, an individual hive contains upward of 60,000 bees.

- ✔ The honey bee has a unique habit that's of great value as a pollinator. It tends to forage on blooms of the same kind, as long as they're flowering. In other words, rather than hopping from one flower type to another, honey bees are flower-consistent. This focus makes for particularly effective pollination. It also means that the honey they produce from the nectar of a specific flower takes on the unique flavor characteristics of that flower — that's how we get specific honey flavors, such as orange blossom honey, buckwheat honey, blueberry honey, lavender honey, and so on (see Chapter 3).
- ✔ The honey bee is one of the only pollinating insects that can be introduced to a garden at the gardener's will. You can garden on a hit-or-miss basis and hope that enough wild bees are out there to achieve adequate pollination — or you can take positive steps and nestle a colony of honey bees in a corner of your garden.

Bees as pollinators: Their vital role to our food supply

Any gardener recognizes the value of pollinating insects. Various insects perform an essential service in the production of seed and fruit. The survival of plants depends on pollination. You might not have thought much about the role honey bees play in our every day food supply. The fact is that 60 percent of the fruits and vegetables we rely on to feed our families need honey bee pollination. The value of honey bee pollination to U.S. agriculture is more than \$14 billion annually, according to a Cornell University study. These are more than interesting facts. These are realities with devastating consequences.

The dwindling population of honey bees in recent years (see the later section “Being part of the bigger picture: Save the bees!”) underscores the value of bee pollination. Indeed a spring without bees could endanger our food supply and impact our economy. It is a story that has become headline news in the media.



I’ve witnessed the miracle in my own garden: more and larger flowers, fruits, and vegetables — all the result of more efficient pollination by bees. After seeing my results, a neighbor who tends an imposing vegetable garden begged me to place a couple of hives on her property. I did, and she too is thrilled. She rewards me with a never-ending bounty of fruits and vegetables. And I pay my land-rent by providing her with 20 pounds of honey every year. Not a bad barter all around.

Being part of the bigger picture: Save the bees!

The facts that keeping a hive in the backyard dramatically improves pollination and rewards you with a delicious honey harvest are by themselves good enough reasons to keep bees. But today, the value of keeping bees goes beyond the obvious. In many areas, millions of colonies of wild (or *feral*) honey bees have been wiped out by urbanization, pesticides, parasitic mites, and a recent phenomenon called “Colony Collapse Disorder” (see Chapter 10 for more information on “CCD”). Collectively, these challenges are devastating the honey bee population. Many gardeners have asked me why they now see fewer and fewer honey bees in their gardens. It’s because of the dramatic decrease in our honey bee population. Backyard beekeeping has become vital in our efforts to reestablish lost colonies of bees and offset the natural decrease in pollination by wild bees. I know of many folks who have started beekeeping to help re-build the honey bee population.

Getting an education: And passing it on!

As a beekeeper you continually discover new things about nature, bees, and their remarkable social behavior. Just about any school, nature center, garden club, or youth organization loves for you (as a beekeeper) to share your knowledge. Each year I make the rounds with my slide show and props, sharing the miracle of honey bees with my community. On many occasions my daughter’s teacher and classmates visited the house for an on-site workshop. I opened the hive and gave each wide-eyed student a close-up look at bees at work. Spreading the word to others about the value these little creatures bring to all of us is great fun. You’re planting a seed for our next generation of beekeepers. After all, a grade-school presentation on beekeeping is what aroused my interest in honey bees.

Bee hunters, gatherers, and cultivators

An early cave painting in eastern Spain, circa 6000 B.C., shows early Spaniards hunting for and harvesting wild honey (see the figure below). In centuries past, honey was a treasured and sacred commodity. It was used as money and praised as the nectar of the gods. Methods

of beekeeping remained relatively unchanged until 1852 with the introduction of today's "modern" interchangeable-frame hive, also known as the Langstroth hive. (See Chapter 4 for more information about Langstroth and other kinds of bee hives.)



Improving your health: Bee therapies and stress relief

Although I can't point to any scientific studies to confirm it, I honestly believe that tending honey bees reduces stress. Working with my bees is so calming and almost magical. I am at one with nature, and whatever problems may have been on my mind tend to evaporate. There's something about being out there on a lovely warm day, the intense focus of exploring the wonders of the hive, and hearing that gentle hum of contented bees — it instantly puts me at ease, melting away whatever day-to-day stresses that I might find creeping into my life.

Any health food store proprietor can tell you the benefits of the bees' products. Honey, pollen, royal jelly, and propolis have been a part of healthful remedies for centuries. Honey and propolis have significant antibacterial qualities. Royal jelly is loaded with B vitamins and is widely used overseas as a dietary and fertility stimulant. Pollen is high in protein and can be used as a homeopathic remedy for seasonal pollen allergies (see the sidebar "Bee pollen, honey, and allergy relief" earlier in this chapter).

Apitherapy is the use of bee products for treating health disorders. Even the bees' venom plays an important role here — in bee-sting therapy. Venom is administered with success to patients who suffer from arthritis and other inflammatory/medical conditions. This entire area has become a science in itself and has been practiced for thousands of years in Asia, Africa, and Europe. An interesting book on apitherapy is *Bee Products — Properties, Applications and Apitherapy: Proceedings of an International Conference Held in Tel Aviv, Israel, May 26–30, 1996*, published by Kluwer Academic Publishers (ISBN: 0306455021).

More information on apitherapy is available from the American Apicultural Society (www.apitherapy.org).

Determining Your Beekeeping Potential

How do you know whether you'd make a good beekeeper? Is beekeeping the right hobby for you? Here are a few things worth considering as you ponder these issues.

Environmental considerations

Unless you live on a glacier or on the frozen tundra of Siberia, you probably can keep bees. Bees are remarkable creatures that do just fine in a wide range of climates. Beekeepers can be found in areas with long cold winters, in tropical rain forests, and in nearly every geographic region in-between. If flowers bloom in your part of the world, you can keep bees.

How about space requirements? You don't need much. I know many beekeepers in the heart of Manhattan. They have a hive or two on their rooftops or terraces. Keep in mind that bees travel miles from the hive to gather pollen and nectar. They'll forage an area as large as 6,000 acres, doing their thing. So the only space that you need is enough to accommodate the hive itself.

See Chapter 3 for more specific information on where to locate your bees.

Bee pollen, honey, and allergy relief

Pollen is one of the richest and purest of natural foods, consisting of up to 35 percent protein and 10 percent sugars, carbohydrates, enzymes, minerals, and vitamins A (carotenes), B1 (thiamin), B2 (riboflavin), B3 (nicotinic acid), B5 (panothenic acid), C (ascorbic acid), H (biotin), and R (rutine).

Here's the really neat part: Ingesting small amounts of pollen every day can actually help reduce the symptoms of pollen-related allergies — sort of a homeopathic way of inoculating yourself.

Of course you can harvest pollen from your bees, and sprinkle a small amount on your

breakfast cereal or in yogurt (as you might do with wheat germ). But you don't really need to harvest the pollen itself. That's because raw, natural honey contains pollen. Pollen's benefits are realized every time you take a tablespoon of honey. Eating local honey every day can relieve the symptoms of pollen-related allergies, if the honey is harvested from within a 50-mile radius of where you live or from an area where the vegetation is similar to what grows in your community. Now that you have your own bees, that isn't a problem. Allergy relief is only a sweet tablespoon away!

Zoning and legal restrictions

Most communities are quite tolerant of beekeepers, but some have local ordinances that prohibit beekeeping or restrict the number of hives that you can have. Some communities let you keep bees but ask that you register your hives with the local government. Check with your town hall, local zoning board, or state agricultural experiment station to find out about what's okay in your neighborhood.

Obviously you want to practice a good-neighbor policy, so that folks in your community don't feel threatened by your unique new hobby. See Chapter 3 for more information on the kinds of things you can do to prevent neighbors from getting nervous.

Costs and equipment

What does it cost to become a beekeeper? All in all, beekeeping isn't a very expensive hobby. You can figure on investing about \$200 to \$400 for the hive, equipment, tools, and medication. In addition, you'll spend \$60 to \$80 for a package of bees and queen. For the most part, these are one-time expenses. Keep in mind, however, the potential for a return on this investment. Your hive can give you 60 TO 90 pounds of honey every year. At \$5 to \$7 a pound (a fair going price for all-natural, raw honey), that should give you an income of \$300 to \$600 per hive! Not bad, huh?

Knowing where honey bees come from

Honey bees are native to Europe, Asia, and Africa, but they're not native to other parts of the world (Australia, New Zealand, and the Americas). Colonies of honey bees were first shipped to Virginia in 1621, and their honey was used by the early pioneers as their chief sweetener. These

bees prospered and gradually colonized all of North America. Today, they've become a vital part of our agricultural economy. Honey bees didn't reach Australia and New Zealand until the early to mid-1800s.

See Chapter 4 for a detailed listing of the equipment you'll need.

How many hives do you need?

Most beekeepers start out with one hive. And that's probably a good way to start your first season. But most beekeepers wind up getting a second hive in short order. Why? For one, it's twice as much fun! Another more practical reason for having a second hive is that recognizing normal and abnormal situations is easier when you have two colonies to compare. In addition, a second hive enables you to borrow frames from a stronger, larger colony to supplement one that needs a little help. My advice? Start with one hive until you get the hang of things, and then consider expanding in your second season.

What kind of honey bees should you raise?

The honey bee most frequently raised by beekeepers in the United States today is European in origin and has the scientific name *Apis mellifera*.

Of this species, the most popular bee is the so-called "Italian" honey bee. These bees are docile, hearty, and good honey producers. They are a good choice for the new beekeeper. See Chapter 5 for more information about different varieties of honey bees.

Time and commitment

Beekeeping isn't labor intensive. Sure you'll spend part of a weekend putting together your new equipment. And I'm anticipating that you'll be spending some time reading up on your new hobby. (I sure hope you read my book from cover to cover!) But the actual time that you absolutely *must* spend with your bees is surprisingly modest. Other than your first year (when I urge you to inspect the hive frequently to find out more about your bees) you need to make only five to eight visits to your hives every year. Add to that the time that you spend harvesting honey, repairing equipment, and putting things away for the season, and you'll probably devote 35 to 40 hours a year to your hobby (more if you make a business out of it).

For a more detailed listing of seasonal activities, be sure to read Chapter 8.

Beekeeper personality traits

If you howl like a banshee every time you see an insect, I suspect that beekeeping will be an uphill challenge for you. But if you love animals, nature, and the outdoors, and if you're curious about how creatures communicate and contribute to our environment, you'll be captivated by honey bees. If you like the idea of "farming" on a small scale, or you're intrigued by the prospect of harvesting your own all-natural honey, you'll enjoy becoming a beekeeper. Sure, as far as hobbies go, it's a little unusual, but all that's part of its allure. Express your uniqueness and join the ranks of some of the most delightful and interesting people I've ever met . . . backyard beekeepers!

Allergies

If you're going to become a beekeeper, you can expect to get stung once in a while. It's a fact of life. But when you adopt good habits as a beekeeper, you can minimize or even eliminate the chances that you'll be stung.

Honey trivia

There are all kinds of interesting facts about honey. Here's a hodgepodge of trivia that might improve your chances of winning a quiz show.

- ✔ Honey has antibacterial properties and is used in some cultures to prevent infection of cuts and burns. A medico friend of mine recently visited a burn clinic in China where honey is used in the patients' dressings.
- ✔ In olden days, a common practice was for newlyweds to drink mead (honey wine) for one month (one phase of the moon) to assure the birth of a son. Thus the term "honeymoon."
- ✔ The honey bee's image became a symbol for kings and religious leaders and was honored on ancient coins and in mythology.
- ✔ One gallon of honey (3.79 liters) weighs 11 lbs., 13.2 ounces (5.36 kg.).
- ✔ The Romans used honey to pay their taxes (I don't think the IRS would approve).
- ✔ Honey found in the tombs of the Egyptian Pharaohs was still edible. That's an impressive shelf life!
- ✔ To produce 1 pound of honey, the bees must visit 2 million flowers!

All bee stings can hurt a little, but not for long. It's natural to experience some swelling, itching, and redness. These are *normal* (not allergic) reactions. Some folks are mildly allergic to bee stings, and the swelling and discomfort may be more severe. And yet, the most severe and life-threatening reactions to bee stings occur in less than 1 percent of the population. So the chances that you're dangerously allergic to honey bee venom are remote. If you're uncertain, check with an allergist, who can determine whether you're among the relatively few who should steer clear of beekeeping.

You'll find more information on bee stings in Chapter 3.

Chapter 2

Life Inside the Honey Bee Hive

In This Chapter

- ▶ Recognizing bee parts and what they're for
 - ▶ Exploring how bees communicate with each other
 - ▶ Getting to know the three castes of honey bee
 - ▶ Appreciating what worker bees do
 - ▶ Understanding the honey bee life cycle
 - ▶ Recognizing the difference between honey bees and other stinging insects
-

My first introduction to life inside the honey bee hive occurred many years ago during a school assembly. My classmates and I were shown a wonderful movie about the secret inner workings of the beehive. The film mesmerized me. I'd never seen anything so remarkable and fascinating. How could a bug be so smart and industrious? I couldn't help being captivated by the bountiful honey bee. That brief childhood event planted a seed that blossomed into a treasured hobby some 20 years later.

Anyone who knows even a little bit about the honey bee can't help but be amazed, because far more goes on within the hive than most people can ever imagine: complex communication, social interactions, teamwork, unique jobs and responsibilities, food gathering, and the engineering of one of the most impressive living quarters found in nature. Whether newcomer or old hand, you'll have many opportunities to experience first-hand the miracle of beekeeping. Every time that you visit your bees you see something new. But you'll get far more out of your new hobby if you understand more about what you're looking at. What are the physical components of the bee that enable it to do its job so effectively? What are those bees up to and why? What's normal and what's not normal? What is a honey bee and what is an imposter? In this chapter you'll take a peek within a typical colony of honey bees.

Basic Body Parts

Everyone knows about at least one part of the honey bee's anatomy: its stinger. But you'll get more out of beekeeping if you understand a little bit about the other various parts that make up the honey bee. I won't go into this in textbook detail — just a few basic parts (see Figure 2-1) to help you understand what makes them tick.

Figure 2-1: This is how a honey bee looks if you shave all the hairs off. The illustration shows the basic body parts of the bee.

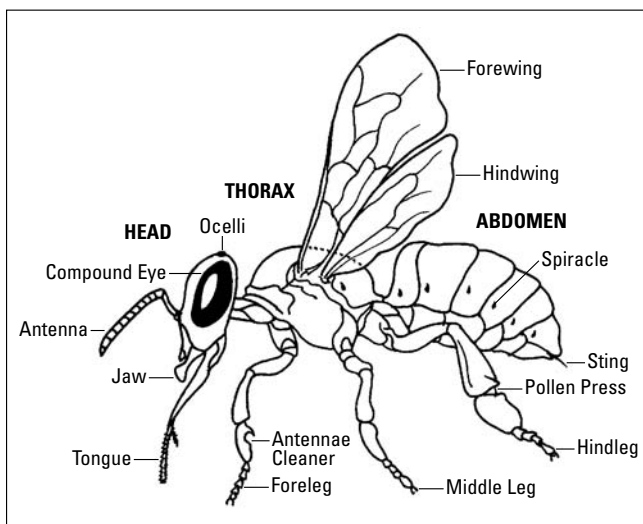

Skeleton

Like all insects, the honey bee's "skeleton" is on the outside. This arrangement is called an *exoskeleton*. Nearly the entire bee is covered with *branched hairs* (like the needles on the branch of a spruce tree). A bee can "feel" with these hairs, and the hairs serve the bee well when it comes to pollination, because pollen sticks well to the branched hairs.

Head

The honey bee's head (see Figure 2-2) is flat and somewhat triangular in shape. Here's where you'll find the bee's brain and primary sensory organs (sight, feel, taste, and smell). It's also where you'll find important glands that produce royal jelly and various chemical pheromones used for communication.



Royal jelly is a substance secreted from glands in a worker bee's head and used as a food to feed brood.

The important parts of the bee's head are its:

- ✓ **Eyes:** The head includes two large compound eyes that are used for general-distance sight and three small simple eyes, called ocelli, which are used in the poor light conditions within the hive. Notice the three simple eyes (ocellus) on the members of all three castes in Figure 2-2, while the huge wrap-around compound eyes of the drone make him easy to identify. The queen's eyes, however, are slightly smaller than the worker bee.
- ✓ **Antennae:** The honey bee has two antennae in front (attached to its forehead). Each antenna has thousands of tiny sensors that detect smell (like a nose does). The bee uses this sense of smell to identify flowers, water, the colony, and maybe even you! They also, like the branched hairs mentioned earlier, detect feel.
- ✓ **Mouth parts:** The bees' mandibles (jaws) are used for feeding larvae, collecting pollen, manipulating wax, and carrying things.
- ✓ **Proboscis:** Everyone's familiar with those noisemakers that show up at birthday and New Year's Eve parties. You know, the ones that unroll when you toot them! The bee's proboscis is much like those party favors only without the "toot." When the bee is at rest, this organ is retracted. But when the bee is feeding or drinking, it unfolds to form a long tube that the bee uses like a straw.

Figure 2-2: Comparing the heads of worker, drone, and queen bees, note the worker bee's extra-long proboscis and the drone's huge wrap-around eyes.

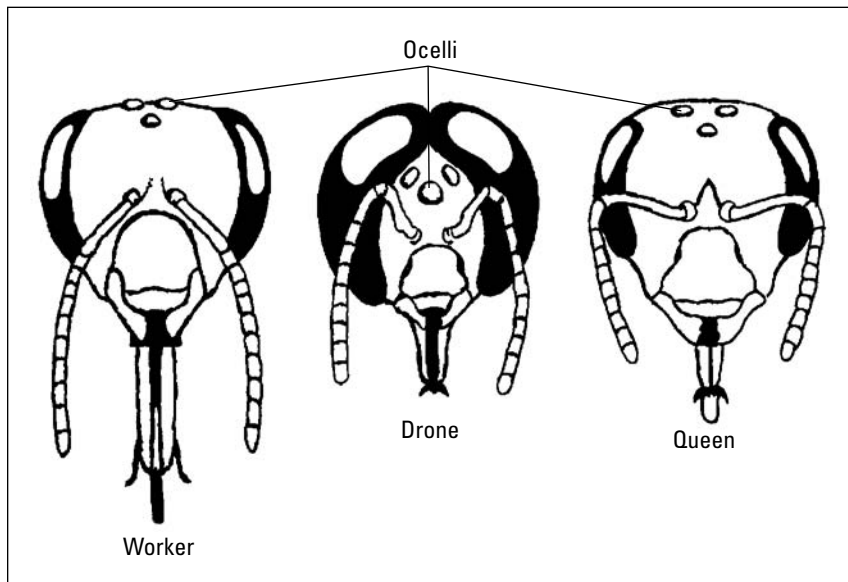

Thorax

The thorax composes the middle part of the bee. It is the segment between the head and the abdomen where the two pairs of wings and six legs are anchored.

- ✔ **Wings:** Here's a question for you: How many wings does a honey bee have? The answer is four. Two pairs are attached fore and aft to the bee's thorax. The wings are hooked together in flight and separate when the bee is at rest.
- ✔ **Legs:** The bee's three pairs of legs all are different. Each leg has six segments that make them quite flexible. The bees also have taste receptors on the tips of their legs. The bee uses its forward-most legs to clean its antennae. The middle legs help with walking and are used to pack loads of pollen (and sometimes propolis) onto the *pollen baskets* that are part of the hind legs. *Propolis* is the sticky resinous substance that the bees collect from the buds of trees and use to seal up cracks in the hive. Propolis can be harvested and used for a variety of nifty products. For more information on propolis and what you can do with it, see Chapter 16. The hind legs (see Figure 2-3) are specialized on the worker bee. They contain special combs and a pollen press, which are used by the worker bee to brush, collect, pack, and carry pollen and propolis back to the hive. Take a moment to watch a foraging bee on a flower. You'll see her hind legs heavily loaded with pollen for the return trip home.
- ✔ **Spiracles:** These tiny holes along the sides of a bee's thorax and abdomen are the means by which a bee breathes. The bee's trachea (breathing tubes) are attached to these spiracles. It is through the first hole in the thorax that tracheal mites gain access to the trachea.

Figure 2-3:

In this close-up image of a bee's leg, you can clearly see the hairs that serve as brushes to collect pollen.

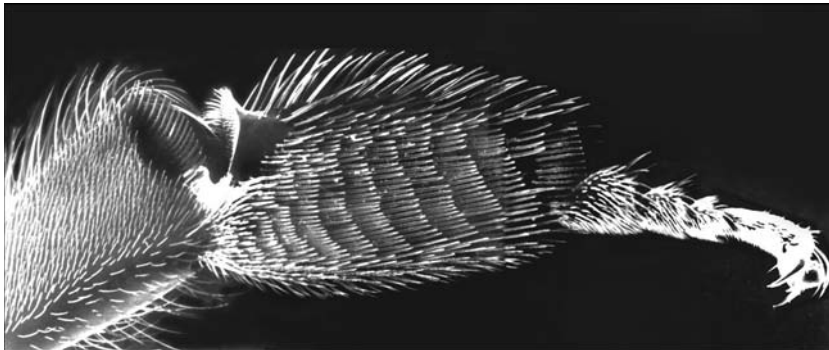

Courtesy of Dr. Eric Erickson, Jr.

Abdomen

The abdomen is the part of the bee's body that contains its digestive organs, reproductive organs, wax and scent glands (workers only), and, of course, the infamous stinger (workers and queen only).

The Amazing Language of Bees

It is said that only man has a form of communication superior to that of the honey bee. Like you and I, honey bees utilize five senses throughout their daily lives; however, honey bees have additional communication aids at their disposal. Two of the methods by which they communicate are of particular interest. One is chemical, the other choreographic.

Pheromones

What are *pheromones*? They're chemical scents that animals produce to trigger behavioral responses from the other members of the same species. Honey-bee pheromones provide the "glue" that holds the colony together. The three castes of bees, of which more is mentioned later in this chapter, produce various pheromones at various times to stimulate specific behaviors. The study of pheromones is a topic worthy of an entire book, so here are just a few basic facts about the ways pheromones help bees communicate:

- ✓ Certain queen pheromones (known as *queen substance*, discussed at greater length later in this chapter) let the entire colony know that the queen is in residence and stimulate many worker bee activities.
- ✓ Outside of the hive, the queen pheromones act as a sex attractant to potential suitors (male drone bees). They also regulate the drone (male bee) population in the hive.
- ✓ Queen pheromones stimulate many worker bee activities, such as comb building, brood rearing, foraging, and food storage.
- ✓ The worker bees at the hive's entrance produce pheromones that help guide foraging bees back to their hive. The Nassanoff gland (discussed later in this chapter) at the tip of the worker bee's abdomen is responsible for this alluring scent.
- ✓ Worker bees produce alarm pheromones that can trigger sudden and decisive aggression from the colony.
- ✓ The colony's brood (developing bee larvae and pupae) secretes special pheromones that help worker bees recognize the brood's gender, stage of development, and feeding needs.

Shall we dance?

Perhaps the most famous and fascinating “language” of the honey bee is communicated through a series of dances done by foraging worker bees who return to the hive with news of nectar, pollen, or water. The worker bees dance on the comb using precise patterns. Depending upon the style of dance, a variety of information is shared with the honey bees’ sisters. They’re able to obtain remarkably accurate information about the location and type of food the foraging bees have discovered.

Two common types of dances are the so-called *round dance* and the *waggle dance*. The round dance communicates that the food source is near the hive (within 10–80 yards) See Figure 2-4.

For a food source found at a greater distance from the hive, the worker bee performs the waggle dance. It involves a shivering side-to-side motion of the abdomen, while the dancing bee forms a figure eight. The vigor of the waggle, the number of times it is repeated, the direction of the dance, and the sound the bee makes communicates amazingly precise information about the location of the food source. See Figure 2-4.

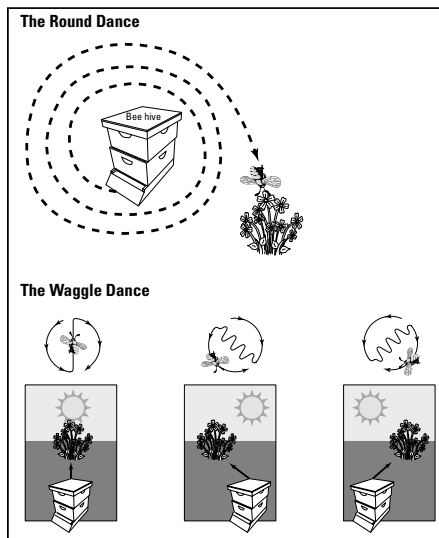

Figure 2-4:
The round
dance (top)
and the
waggle
dance
(bottom).

The dancing bees pause between performances to offer potential recruits a taste of the goodies they bring back to the hive. Combined with the dancing, the samples provide additional information about where the food can be found and what type of flower it is from.

Dividing Honey Bees into Three Castes

During summer months, about 60,000 or more bees reside in a healthy hive. And while you may think that all those insects look exactly alike, actually three different castes (worker, queen, and drone, see Figure 2-5) make up the total population. Each has its own characteristics, roles, and responsibilities. Upon closer examination, the three types even look a little different, and being able to distinguish one from the other is important.

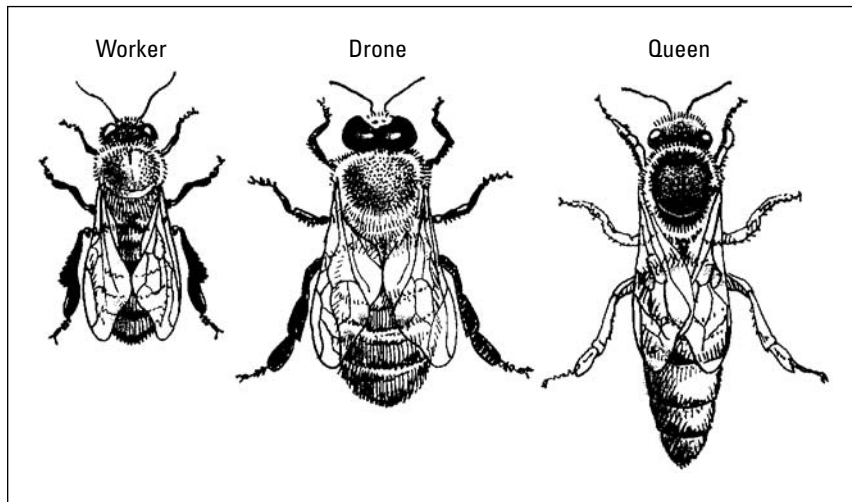

Figure 2-5: These are the three castes of honey bee: worker, drone, and queen.

Her majesty, the queen

Let there be no mistake about it — the queen bee is the heart and soul of the colony. She is the reason for nearly everything the rest of the colony does. The queen is the only bee without which the rest of the colony cannot survive. Without her, your hive is sunk. A good quality queen means a strong and productive hive. For more information on how to evaluate a good queen, see Chapter 7. And for some real fun, try raising your own queens from your best performing hives. See Chapter 13.



As a beekeeper, on every visit to the hive you'll need to determine “do I have a queen?” and “is she healthy?”

Only one queen lives in a given hive. She is the largest bee in the colony, with a long and graceful body. She is the only female with fully developed ovaries. The queen's two primary purposes are to produce chemical scents that help regulate the unity of the colony and to lay eggs — and lots of them. She is, in fact, an egg-laying machine, capable of producing more than 1,500 eggs a day at 30-second intervals. That many eggs are more than her body weight!

The other bees pay close attention to the queen, tending to her every need. Like a regal celebrity, she's always surrounded by a flock of attendants as she moves about the hive (see Figure 2-6). Yet, she isn't spoiled. These attendants are vital, because the queen is totally incapable of tending to her own basic needs. She can neither feed nor groom herself. She can't even leave the hive to relieve herself. And so her doting attendants (the queen's court) take care of her basic needs while she tirelessly goes from cell to cell doing what she does best . . . laying eggs.



Figure 2-6:
A queen and
her attentive
attendants.

Courtesy of John Clayton

Amazing “queen substances”

In addition to laying eggs, the queen plays a vital role in maintaining the colony’s cohesiveness and stability. The mere presence of the queen in the hive motivates the productivity of the colony. Her importance to the hive is evident in the amount of attention paid to her by the worker bees everywhere she goes in the hive. But, as is true of every working mom or regal presence, she can’t be everywhere at once, and she doesn’t interact with every member of the colony every day. So, how does the colony know it has a queen? By her scent. The queen produces a number of different pheromones (mentioned earlier in this chapter) in her mandibular (jaw) glands that attract workers to her and stimulate brood rearing, foraging, comb building, and other activities. Also referred to as *queen substances*, these pheromones play an important role in controlling the behavior of the colony: Queen substances inhibit the worker bees from making a new queen and prevent the development of the worker bees’ ovaries, thus ensuring that the queen is the only egg-laying

female in the hive. They act as a chemical communication that “all is well — the queen is in residence and at work.” As a queen ages, these pheromones diminish, and, when that happens, the colony knows that it’s time to supersede her with a new, young queen.

Pheromones are essential in controlling the well-being of the colony. This queen substance makes its way around the hive like a bucket brigade. The queen’s attendants pick up the scent from the queen and transfer it by contact with neighboring bees. They in turn pass the scent onto others, and so it distributes throughout the colony. So effective is this relay, that if the queen were removed from the hive, the entire colony would be aware of her loss within hours. When the workers sense the lack of a queen, they become listless, and their drive to be productive is lost. Without leadership, they nearly lose their reason for being! First they’re unhappy and mope around, but then it dawns on them . . . “let’s make a new queen.”

The gentle queen bee has a stinger, but it is rare for a beekeeper to be stung by a queen bee. I have handled many queen bees and have never been stung by any of them. In general, queen bees use their stingers only to kill rival queens that may emerge or be introduced in the hive.



The queen can live for two or more years, but replacing your queen after a couple of seasons ensures maximum productivity. Some beekeepers routinely replace their queens every autumn. That practice ensures that your hive has a new energetic young queen each spring. You may wonder why you should replace the queen if she’s still alive? That’s an easy one: As a queen ages, her egg-laying capability slows down, which results in less and less brood each season. Less brood means a smaller colony. And a smaller colony means a lackluster honey harvest for you! For information on how to successfully introduce a new queen, see Chapter 9. For information on how to raise your own queens (now that’s fun!), see Chapter 13.



As a beekeeper, your job is to *anticipate* problems before they happen. An aging queen — more than a year old — is something that you can deal with by replacing her after checking her egg laying before you have a problem.

The industrious little worker bee

The majority of the hive's population consists of *worker bees*. Like the queen, worker bees are all female. Worker bees that are younger than 3 weeks old do have working ovaries and can lay eggs, but they are not fertile as the workers never mate and have no sperm. Workers also look different than the queen. They are smaller, their abdomens are shorter, and on their hind legs they possess *pollen baskets*, which are used to tote pollen back from the field.

Like the queen, the worker bee has a stinger. But her stinger is not a smooth syringe like the queen's. It has a barb on the end. The barb causes the stinger, venom sack, and a large part of the bee's gut to remain in a human victim — a Kamikaze effort to protect the colony. Only in mammals (such as humans) does the bee's stinger get stuck. The bee can sting other insects again and again while defending its home.



The life span of worker bee is a modest six weeks during the colony's active season. However, worker bees live longer (four to eight months) during the less active winter months. These winter workers are loaded with protein and are sometimes referred to as "Fat Bees". The term "busy as a bee" is well earned. Worker bees do a considerable amount of work, day in and day out. They work as a team. Life in the hive is one of compulsory cooperation. What one worker could never do on her own, can be accomplished as a colony. During the busy season the worker bees literally work themselves to death. The specific jobs and duties they perform during their short lives vary as they age. Understanding their roles will deepen your fascination and appreciation of these remarkable creatures.

From the moment a worker bee emerges from her cell she has many and varied tasks clearly cut out for her. As she ages, she performs more and more complex and demanding tasks. Although these various duties usually follow a set pattern and timeline, they sometimes overlap. A worker bee may change occupations sometimes within minutes, if there is an urgent need within the colony for a particular task. They represent teamwork and empowerment at their best!

Initially, a worker's responsibilities include various tasks within the hive. At this stage of development, worker bees are referred to as *house bees*. As they get older, their duties involve work outside of the hive as *field bees*.

Royal jelly: The food of royalty

Royal jelly is the powerful, creamy substance that transforms an ordinary worker bee egg into a queen bee, and extends her life span from six weeks to five years! It's made of digested pollen and honey or nectar mixed with a chemical secreted from a gland in a nurse bee's head. In health food stores it commands premium prices rivaling imported caviar. Those in the know use

royal jelly as a dietary supplement and fertility stimulant. It contains an abundance of nutrients, including essential minerals, B-complex vitamins, proteins, amino acids, collagen, essential fatty acids, just to name a few! Sarah Ferguson ("Fergie"), the former Duchess of York, is said to have eaten royal jelly while she was trying to become pregnant.

In the following paragraphs, I highlight the various responsibilities of worker bees during their short but remarkable lives.

Housekeeping (days 1 to 3)

A worker bee is born with the munchies. Immediately after she emerges from the cell and grooms herself, she engorges herself with pollen and honey. Following this binge, one of her first tasks is cleaning out the cell from which she just emerged. This and other empty cells are cleaned and polished and left immaculate to receive new eggs and to store nectar and pollen.

Undertaking (days 3 to 16)

The honey bee hive is one of the cleanest and most sterile environments found in nature. Preventing disease is an important early task for the worker bee. During the first couple weeks of her life, the worker bee removes any bees that have died and disposes of the corpses as far from the hive as possible. Similarly, diseased or dead brood are quickly removed before becoming a health threat to the colony. Should a larger invader (such as a mouse) be stung to death within the hive, the workers have an effective way of dealing with that situation. Obviously a dead mouse is too big for the bees to carry off. So the workers completely encase the corpse with *propolis* (a brown sticky resin collected from trees, and sometimes referred to as *bee glue*). Propolis has significant antibacterial qualities. In the hot, dry air of the hive, the hermetically sealed corpse becomes mummified and is no longer a source of infection. The bees also use propolis to seal cracks and varnish the inside walls of the hive.

Working in the nursery (days 4 to 12)

The young worker bees tend to their "baby sisters" by feeding and caring for the developing larvae. On average, nurse bees check a single larva 1,300 times a day. They feed the larvae a mixture of pollen and honey, and royal jelly — rich in protein and vitamins — produced from the hypopharyngeal

gland in the worker bee's head. The number of days spent tending brood depends upon the quantity of brood in the hive, and the urgency of other competing tasks.

Attending royalty (days 7 to 12)

Because her royal highness is unable to tend to her most basic needs by herself, some of the workers do these tasks for her. They groom and feed the queen, and even remove her excrement from the hive. These royal attendants also coax the queen to continuously lay eggs as she moves about the hive.

Going grocery shopping (days 12 to 18)

Young worker bees also take nectar from foraging field bees that are returning to the hive. The house bees deposit this nectar into cells earmarked for this purpose. They add an enzyme to the nectar and set about fanning the cells to evaporate the water content and turn the nectar into ripened honey. The workers similarly take pollen from returning field bees and pack the pollen into cells. Both the ripened honey and the pollen are food for the colony.

Fanning (days 12 to 18)

Worker bees also take a turn at controlling the temperature and humidity of the hive. During warm weather and during the honey flow season, you'll see groups of bees lined up at one side of the entrance, facing the hive. They fan furiously to draw air into the hive. Additional fanners are in position within the hives. This relay of fresh air helps maintain a constant temperature (93 to 95 degrees F) for developing brood. The fanning also hastens the evaporation of excess moisture from the curing honey.

The workers also perform another kind of fanning, but it isn't related to climate control. It has more to do with communication. The bees have a scent gland located at the end of their abdomen called the *Nassanoff gland*. You'll see worker bees at the entrance with their abdomens arched, and the moist pink membrane of this gland exposed (see Figure 2-7). They fan their wings to release this pleasant sweet odor into the air. You can actually smell it sometimes as you approach the hive. The pheromone is highly attractive and stimulating to other bees, and serves as an orientation message to returning foragers, saying: "Come hither . . . this is your hive and where you belong."

Beekeepers can purchase synthetic queen bee pheromone and use this chemical to lure swarms of bees into a trap. The captured swarm then can be used to populate a new hive.



Figure 2-7:
This worker
bee fans her
wings while
exposing
her
Nassanoff
gland to
release a
sweet
orientation
scent. This
helps direct
other mem-
bers of the
colony back
to the hive.



Courtesy of Bee Culture Magazine

Becoming architects and master builders (days 12 to 35)

Worker bees that are about 12 days old are mature enough to begin producing beeswax. These white flakes of wax are secreted from wax glands on the underside of the worker bee's abdomen. They help with the building of new *wax comb* and in the capping of ripened honey and cells containing developing pupae.



Some new beekeepers are alarmed when they first see these wax flakes on the bee. They wrongly think these white chips are an indication of a problem (disease or mite).

Guarding the hive (days 18 to 21)

The last task of a house bee before she ventures out is that of guarding the hive. At this stage of maturity, her sting glands have developed to contain an authoritative amount of venom. You can easily spot the guard bees at the hive's entrance (see photo of guard bees in color insert). They are poised and alert, checking each bee that returns to the hive for a familiar scent. Only family members are allowed to pass. Strange bees, wasps, hornets, and others intent on robbing the hives vast stores of honey are bravely driven off.



Bees from other hives are occasionally allowed in when they bribe the guards with nectar. These bees simply steal a little honey or pollen and leave.

Steppin' out (days 22 to 42)

With her life half over, the worker bee now ventures outside of the hive and joins the ranks of field bees. You'll see them taking their first *orientation flights*. The bees face the hive and dart up, down, and all around the entrance. They're imprinting the look and location of their home before beginning to circle the hive and progressively widening those circles, learning landmarks that ultimately will guide them back home. At this point, worker bees are foraging for pollen (see Figure 2-8), nectar, water, and propolis (resin collected from trees).



Foraging bees visit 5 million flowers to produce a single pint of honey. They forage a two- to three-mile (four- to five-kilometer) radius from the hive in search of food. That's the equivalent of nearly 6,000 acres! So don't think for a moment that you need to provide everything they need on your property. They're ready and willing to travel.

Foraging is the toughest time for the worker bee. It's difficult and dangerous work, and it takes its toll. They can get chilled as dusk approaches and die before they can return to the hive. Sometimes they become a tasty meal for a bird or other insect. You can spot the old girls returning to the hive. They've grown darker in color, and their wings are torn and tattered. This is how the worker bee's life draws to a close . . . working diligently right until the end.

Figure 2-8:

This bee's pollen baskets are filled. She can visit 10 flowers every minute, and may visit more than 600 flowers before returning to the hive.



Courtesy of Wellmark International

The woeful drone

This brings us to the only male bee in the colony. Drones make up a relatively small percentage of the hive's total population. At the peak of the season their numbers may be only in the hundreds. You rarely find more than a thousand.



New beekeepers often mistake a drone for the queen, because he is larger and stouter than a worker bee. But his shape is in fact more like a barrel (the queen's shape is thinner, more delicate and tapered). The drone's eyes are huge and seem to cover his entire head. He doesn't forage for food from flowers — he has no pollen baskets. He doesn't help with the building of comb — he has no wax-producing glands. Nor can he help defend the hive — he has no stinger and can be handled by the beekeeper with absolute confidence.

The drone gets a bad rap in many bee books. Described as lazy, glutinous, and incapable of caring for himself, you might even begin wondering what he's good for?

He mates! Procreation is the drone's primary purpose in life. Despite their high maintenance (they must be fed and cared for by the worker bees), drones are tolerated and allowed to remain in the hive because they may be needed to mate with a new virgin queen (when the old queen dies or needs to be superseded). Mating occurs outside of the hive in mid-flight, 200 to 300 feet in the air. This location is known as the "drone Mating Area", and it can be a mile or more away from the hive. The drone's big eyes come in handy for spotting virgin queens taking their *nuptial flights*. The few drones that do get a chance to mate are in for a sobering surprise. They die after mating! That's because their sex organ is barbed (like the worker bee's stinger). An organ inside the queen called the "spermatheca" is the receptacle for the sperm. The queen will mate with several drones during her "nuptial flight". After mating with the queen, the drone's most personal apparatus and a significant part of its internal anatomy is torn away, and it falls to its death, a fact that prompts empathetic groans from the men in my lectures and unsympathetic cheers from the women.

Once the weather gets cooler and the mating season comes to a close, the workers will not tolerate having drones around. After all, those fellows have big appetites and would consume a tremendous amount of food during the perilous winter months. So in cooler climates at the end of the nectar-producing season, you will see the worker bees systematically expelling the drones from the hive (see the photo in this book's color section). They are literally tossed out the door. For those beekeepers who live in areas that experience cold winters, this is your signal that the beekeeping season is over for the year.



Depending upon where you live, the calendar of events for you and your bees varies depending upon temperature ranges and the time of year. To read more about the beekeeper's calendar in your part of the world, see the chart in Chapter 8.

The Honey Bee Life Cycle

In winter the hive is virtually dormant. The adult bees are in a tight cluster for warmth, and their queen is snugly safe in the center of it all. But as the days lengthen and the spring season approaches, the bees begin feeding the queen royal jelly. This special food (secreted from the glands near the workers' mandibles) is rich in protein and stimulates the queen to start laying eggs.

Like butterflies, honey bees develop in four distinct phases: egg, larva, pupa, and adult. The total development time varies a bit among the three castes of bees, but the basic miraculous process is the same: 24 days for drones, 21 days for worker bees, and 16 days for queens.

Egg

The metamorphosis begins when the queen lays an egg. You should know how to spot eggs, because that is one of the most basic and important skills you need to develop as a beekeeper. It isn't an easy task, because the eggs are mighty tiny (only about 1.7 millimeters long). But finding eggs is one of the surest ways to confirm that your queen is alive and well. It's a skill you'll use just about every time you visit your hive.

The queen lays a single egg in each cell that has been cleaned and prepared by the workers to raise new brood (see Figure 2-9). The cell must be spotless, or she moves on to another one.

If she chooses a standard worker-size cell, she releases a fertilized egg into the cell. That egg develops into a worker bee (female). But if she chooses a wider drone-size cell, the queen releases a nonfertilized egg. That egg develops into a drone bee (male). The workers that build the cells are the ones that regulate the ratio of female worker bees to male drone bees. They do this by building smaller cells for female worker bees, and larger cells for male drone bees.

Figure 2-9:
Note the rice-like shape of the eggs and how the queen has positioned them “standing up” in the cell.

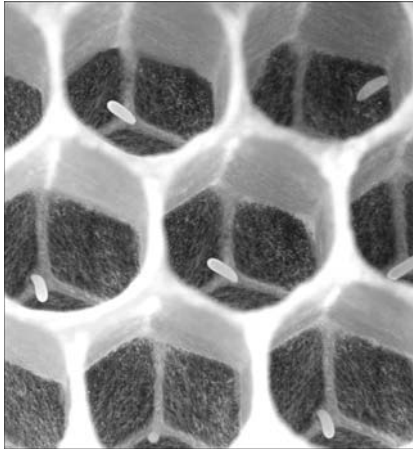

Courtesy of Stephen McDaniel

Having said all that, not all fertilized eggs develop into worker bees. Some can develop into a regal queen bee. But more on that in Chapter 13.

The queen positions the egg in an upright position (standing on end) at the bottom of a cell. That’s why they’re so hard to see. When you look straight down into the cell, you’re looking at the miniscule diameter of the egg, which is only 0.4 of a millimeter wide. Figure 2-10 shows a microscopic closeup of a single egg.



Figure 2-10:
A single egg.

Courtesy of Stephen McDaniel



Eggs are much easier to spot on a bright sunny day. Hold the comb at a slight angle, and with the sun behind you and shining over your shoulder, illuminate the deep recesses of the cell. The eggs are translucent white, and resemble a miniature grain of rice. I recommend that you invest in an inexpensive pair of reading glasses. The magnification can really help you spot the eggs (even if you don't normally need reading glasses). Once you discover your first egg, it'll be far easier to know what you're looking for during future inspections. Better yet, get yourself a pair of magnifying goggles such as those used by watch makers and model makers (see Figure 2-11).

Figure 2-11:

These magnifying goggles (used by watch makers and model makers) are a great bee-keeping tool for finding those itty-bitty eggs.



Larva

Three days after the queen lays the egg, it hatches into a *larva* (the plural is *larvae*). Healthy larvae are snowy white and resemble small grubs curled up in the cells (see Figure 2-12). Tiny at first, the larvae grow quickly, shedding their skin five times. These helpless little creatures have voracious appetites, consuming 1,300 meals a day. The nurse bees first feed the larvae royal jelly, and later they're weaned to a mixture of honey and pollen (sometimes referred to as *bee bread*). Within just five days, they are 1,570 times larger than their original size. At this time the worker bees seal the larvae in the cell with a porous capping of tan beeswax. Once sealed in, the larvae spin a cocoon around their bodies.

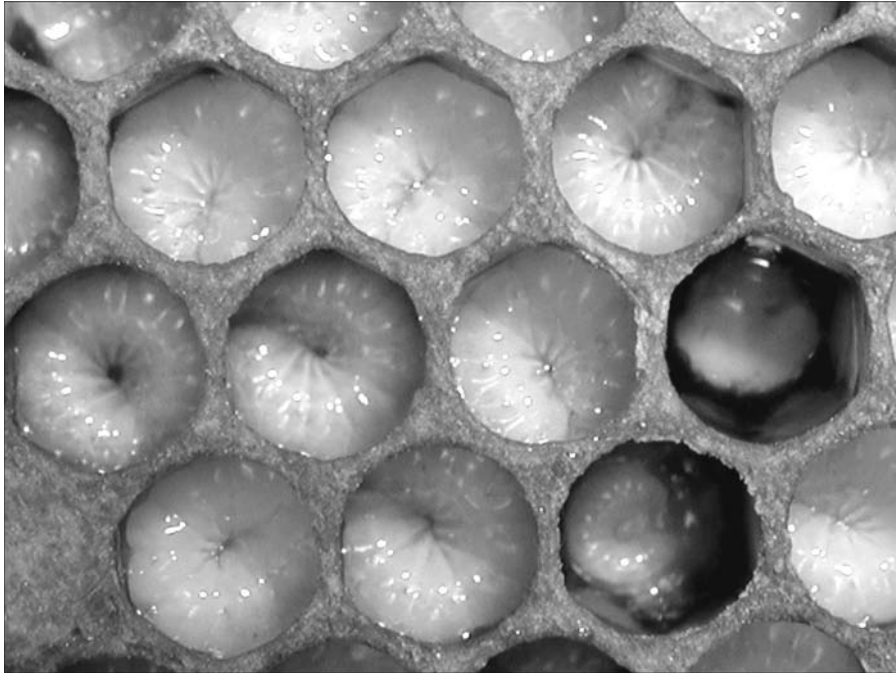

Figure 2-12:
Beautiful
pearly-white
little larvae
curled up in
their cells.

Courtesy of John Clayton

Pupa

The larva is now officially a *pupa* (the plural is *pupae*). Here's where things really begin to happen. Of course the transformations now taking place are hidden from sight under the wax cappings. But if you could, you'd see that this little creature is beginning to take on the familiar features of an adult bee (see Figure 2-13). The eyes, legs, and wings take shape. Coloration begins with the eyes. First pink, then purple, then black. Finally, the fine hairs that cover the bee's body develop. After 12 days, the now *adult bee* chews her way through the wax capping to join her sisters and brothers. Figure 2-12 shows the entire life cycle of the three castes of honey bee from start to finish.



Figure 2-13:
Opened cells reveal an egg and developing pupae.

Courtesy of Dr. Edward Ross, California Academy of Sciences.

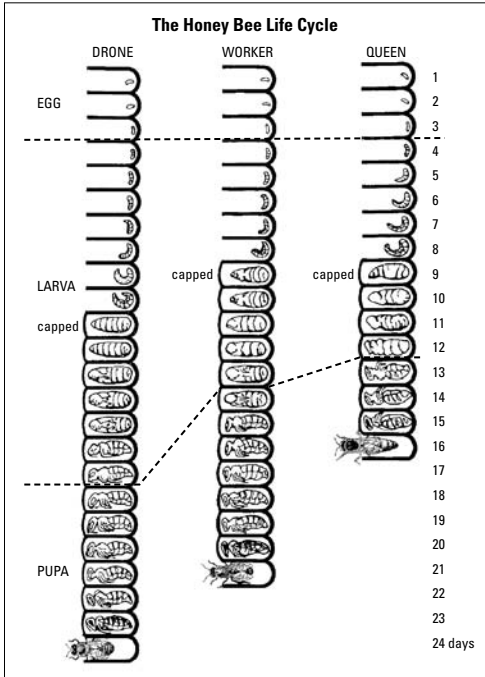

Figure 2-14:
This chart shows the daily development cycle of all three castes, from egg to adult.

Other Stinging Insects

Many people are quick to say they've been "stung by a bee," but the chances of a *honey bee* stinging them are rather slim. Honey bees usually are gentle in nature, and it is rare for an individual to be stung by a honey bee. Away from their hives, honey bees are nonaggressive. More aggressive insects are the more likely culprits when someone is stung. Most folks, however, don't make the distinction between honey bees and everything else. They incorrectly lump all insects with stingers into the "bee" category. True bees are unique in that their bodies are covered with hair, and they use pollen and nectar from plants as their sole source of food (they're not the ones raiding your cola drink at a picnic — those are likely to be yellow jackets). Here are some of the most common stinging insects.

Bumblebee

The gentle bumblebee (see Figure 2-15) is large, plump, and hairy. It's a familiar sight, buzzing loudly from flower to flower, collecting pollen and nectar. Bumblebees live in small ground nests that die off every autumn. At the peak of summer, the colony is only a few hundred strong. Bumblebees make honey, but only small amounts (measured in ounces, not pounds). They are docile and not inclined to sting, unless their nest is disturbed.



Figure 2-15:
The bumble-
bee is furry
and plump.

Courtesy of Dr. Edward Ross, California Academy of Sciences

Carpenter bee

The carpenter bee (see Figure 2-16) looks much like a bumblebee, but its habits are quite different. It is a solitary bee that makes its nest by tunneling through solid wood (sometimes the wooden eaves of a barn or shed). Like the honey bee, the carpenter bee forages for pollen. Its nest is small and produces only a few dozen offspring a season. Carpenter bees are gentle and are not likely to sting. But they can do some serious damage to the woodwork on your house.



Figure 2-16:

The carpenter bee looks similar to a bumblebee, but its abdomen has no hair.

Courtesy of Dr. Edward Ross, California Academy of Sciences

Wasp

Many different kinds of insects are called “wasps.” The more familiar of these are distinguished by their smooth hard bodies (usually brown or black) and familiar ultra-thin “wasp waist” (see Figure 2-17). So-called “social wasps” build exposed paper or mud nests, which usually are rather small and contain only a handful of insects and brood. These nests sometimes are located where we’d rather not have them (in a door frame or windowsill). The slightest disturbance can lead to defensive behavior and stings. Social wasps primarily are meat eaters, but adult wasps are attracted to sweets. Note that wasps and hornets have smooth stingers (no barbs) and can inflict their furry over and over again. Ouch!

Figure 2-17:
The wasp is clearly identified by its smooth hairless body and narrow “wasp waist.”

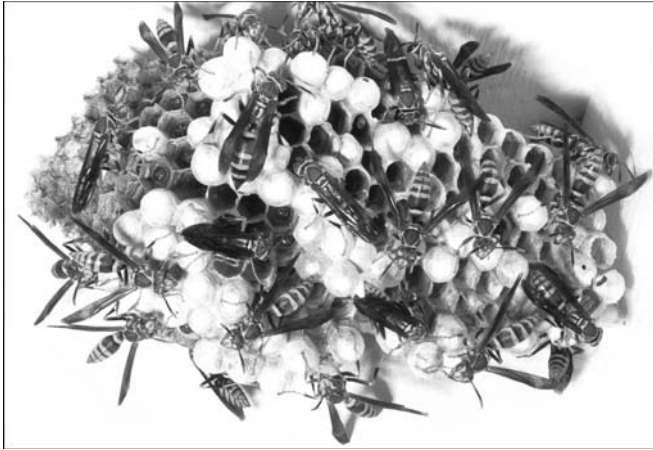

Courtesy of Dr. Edward Ross, California Academy of Sciences

Yellow jacket

The yellow jacket also is a social wasp. Fierce and highly aggressive, it is likely responsible for most of the stings wrongly attributed to bees (see Figure 2-18). Yellow jackets are a familiar sight at summer picnics where they scavenge for food and sugary drinks. Two basic kinds of yellow jackets exist: those that build their nests underground (which can create a problem when noisy lawn mowers or thundering feet pass overhead) and those that make their nests in trees. All in all, yellow jackets aren't very friendly bugs.

Figure 2-18:
The ill-tempered yellow jacket is a meat eater but also has a taste for sweets.



Courtesy of Dr. Edward Ross, California Academy of Sciences

Bald-faced hornet

Bald-faced hornets are not loveable creatures (see Figure 2-19). They are related to yellow jackets, but they build their nests *above* ground. Hornets have a mean disposition and are ruthless hunters and meat eaters. They do, however, build fantastically impressive and beautiful paper nests from their saliva and wood fiber they harvest from dead trees (see Figure 2-20). These nests can grow large during the summer and eventually reach the size of a basketball. Such nests can contain several thousand hot-tempered hornets — keep your distance! In nontropical regions, the end of the summer marks the end of the hornet city. When the cool weather approaches, the nest is abandoned, and only the queen survives. She finds a warm retreat underground and emerges in the spring, raising young and building a new nest.

Figure 2-19:
The bald-faced hornet makes impressive paper nests in trees.



Courtesy of Dr. Edward Ross, California Academy of Sciences

Figure 2-20:
A large paper nest made by a colony of bald-faced hornets.



Part II

Starting Your Adventure

The 5th Wave

By Rich Tennant



"Honey – get the smoke can. The guests are starting to swarm all over the bee hives again."

In this part . . .

This is where the fun begins! In these chapters, I tell you how to get started with honey bees, where you should locate your hive, and what kind of equipment you'll need. I also show you how to successfully and safely transfer your bees to their new home.

Chapter 3

Alleviating Apprehensions and Making Decisions

In This Chapter

- ▶ Avoiding the dreaded stinger
 - ▶ Understanding local restrictions
 - ▶ Winning over your family, friends, and neighbors
 - ▶ Deciding whether you have enough space
 - ▶ Picking the perfect location
 - ▶ Choosing the best time to start
-

I suspect all new backyard beekeepers think similar thoughts as they're deciding to make the plunge. You've thought about beekeeping for some time. You're growing more and more intrigued by the idea . . . maybe this is the year you're going to do something. It certainly sounds like a lot of fun. What could be more unique? It's educational and a nice outdoor activity for you — back to nature and all that stuff. The bees will do a great job of pollinating the garden, and there's that glorious crop of delicious homegrown honey to look forward to. And you realize you can make a difference by introducing a colony of bees in a time when the wild bee population is in jeopardy. The anticipation is building daily, and you're consumed with excitement. That's it! You've made up your mind. You'll become a beekeeper! But in the back of your mind some nagging concerns keep bubbling to the surface.

You're a wee bit concerned about getting stung, aren't you? Your friends and family may say you're crazy for thinking of becoming a beekeeper. What if the neighbors disapprove when they find out? Maybe bees are not even *allowed* in your neighborhood. What happens if the bees don't like their new home and all fly away? Help!

Relax. These are certainly some of the concerns that I had when I first started. In this chapter I hope to defuse your apprehensions and suggest some helpful ways to deal with those concerns.

Overcoming Sting Phobia

Perhaps the best-known part of the bee's anatomy is its stinger. Quite honestly, that was my biggest apprehension about taking up beekeeping. I don't think I'd ever been stung by a honey bee, but I'd certainly felt the wrath of yellow jackets and hornets. I wanted no part of becoming a daily target for anything so unpleasant. I fretted about my fear for a long time, looking for reassurances from experienced beekeepers. They told me time and again that honey bees bred for beekeeping were docile and seldom inclined to sting. But lacking first-hand experience, I was doubtful.

The advice turned out to be 100 percent correct. Honey bees *are* docile and gentle creatures. To my surprise (and delight), I made it through my entire first season without receiving a single sting. In the decades that I've been keeping bees, not a single member of my family, not a single visitor to my home, and not a single neighbor has ever been stung by one of my honey bees.

By the way, bees *sting* — they don't *bite*. Honey bees use their stinger only as a last resort to defend the colony. After all, they die after stinging. When bees are away from the hive (while they're collecting nectar and pollen) defending the colony is no longer a priority, so they're as gentle as lambs out in the field.

Do I ever get stung? Sure. But usually not more than three or four times a year. In every case, the stings I take are a result of my own carelessness. I'm rushing, taking short cuts, or am inattentive to their mood — all things that I shouldn't do. That sloppiness is merely the result of becoming so comfortable with my bees that I am not as diligent as I should be. The secret to avoiding stings is your technique and demeanor.

Here are some helpful tips for avoiding stings:

- ✓ Always wear a veil and use your smoker when visiting your hive (see Chapters 4 and 5 for more information on these two vital pieces of beekeeper apparatus).
- ✓ Inspect your bees during pleasant daytime weather. Try to use the hours between 10 a.m. and 5 p.m. That's when most of the bees are out working, and fewer bees are at home. Don't open up the hive at night, during bad weather, or if a thunderstorm is brewing. In Chapters 6 and 7, I go into detail about how to open the hive and inspect the colony.
- ✓ Don't rush. Take your time and move calmly. Sudden movements are a no-no.

- ✔ Get a good grip on frames. If you drop a frame of bees, you'll have a memorable story to tell.
- ✔ Never swat at bees. Become accustomed to them crawling on your hands and clothing. They're just exploring. Bees can be gently pushed aside if necessary.
- ✔ When woodenware is stuck together with propolis, don't snap it apart with a loud "crack." The bees go on full alert when they feel sudden vibrations.
- ✔ Never leave sugar syrup or honey in open containers near the hive. Doing so can excite bees into a frenzy, and you may find yourself in the middle of it. It can also set off *robbing* — an unwelcome situation in which bees from other colonies attack your bees, robbing them of their honey. In Chapter 9 you'll find instructions on how to avoid robbing, and what to do when it happens.
- ✔ Keep yourself and bee clothing laundered. Bees don't like bad body odor. If you like to eat garlic, avoid indulging right before visiting your bees. Chapter 6 has some handy hygiene hints.
- ✔ Wear light-colored clothing. Bees don't seem to like dark colors.

Knowing what to do if you're stung

Be prepared to answer the following question from everyone who hears you're a beekeeper: "Do you ever get stung?" You'll hear this one a hundred times. An occasional sting is a fact of life for a beekeeper. Following the rules of the road, however, keeps stings to a minimum, or perhaps you'll get none at all. Yet, if a bee stings you or your clothing, calmly remove the stinger and smoke the area to mask the chemical alarm scent left behind. (This alarm pheromone can stimulate other bees to sting.) To remove the stinger, you can use your fingernail to *scrape* it off your skin.



If you are stung, apply a cold compress and take an antihistamine tablet (such as Benadryl). Antihistamine creams also are available. Using this technique alleviates the swelling, itching, and discomfort.



Some folks swear by the effectiveness of baking-soda-and-water poultices for bee stings; other folks advocate meat tenderizer and wet tobacco poultices, respectively. These are "grandma recipes" that were used before we had the antidote that the medical profession endorses — over-the-counter antihistamines.

Watching for allergic reactions

All bee stings hurt a bit, but not for long. Experiencing redness, swelling, and itching is completely natural. These are normal (not allergic) reactions. For a small percentage of individuals, more severe allergic or even toxic reactions can occur, including severe swelling beyond the immediate area of the sting, and shortness of breath. In the worst cases, reaction to bee stings can result in loss of consciousness or even death. The most severe reactions occur in less than 1 percent of the population. To put that in perspective, more people are killed by lightning each year than die from bee stings.

As a precaution against a guest having a severe reaction, I keep an EpiPen (see Figure 3-1) on hand. These emergency sting kits are available from your doctor by prescription. The kit automatically injects a dosage of epinephrine (adrenaline). But be careful. Liability issues can arise when injecting another person, so check with your doctor beforehand.



Figure 3-1:
EpiPen
emergency
sting kits
are avail-
able only by
prescription
from your
doctor.

Courtesy of Wellmark International

Building up a tolerance

Now this may sound strange, but many beekeepers (myself included) look forward to getting a few stings early in the season. No, we're not masochistic. The more stings we get, the less the swelling and itching. For many, occasional stings actually build up a kind of tolerance. It still smarts, but the side effects disappear.

One school of thought states that bee venom can actually be good for some health conditions that you may suffer from. This is what bee-sting therapy is all about; see Chapter 1 for more information.

Understanding Local Laws and Ordinances

Is it legal to keep bees? In most places, the answer is yes. But some areas have laws or ordinances restricting or even prohibiting beekeeping. For the most part, such restrictions are limited to highly populated, urban areas. Other communities may limit the number of hives you can keep, and some require you to register your bees with town hall. Some communities require that the state bee inspector inspect the health of your colonies periodically. If you have any questions about the legality of keeping bees, contact your state bee inspector, the state agricultural experiment station, or a local bee club or association.



Bee Culture magazine maintains a terrific online listing of “Who’s Who in the Beeyard.” This search engine is a great way to find beekeeping clubs, associations, and agencies in your state. Visit: www.beeculture.com and follow the links. By the way, there is a 50-percent subscription discount offer on this journal at the end of this book.

Easing the Minds of Family and Neighbors

For many among the general public, ignorance of honey bees is complete. Having been stung by hornets and yellow jackets, they assume having any kind of bee nearby spells trouble. Not true. It’s up to you to take steps to educate them and alleviate their fears.

Some things you can do to put them at ease are

- ✔ Restricting your beeyard to two hives or less. Having a couple of hives is far less intimidating to the uneducated than if you had a whole phalanx of hives.
- ✔ Locating your hive in such a way that it doesn't point at your neighbor's driveway, your house entrance, or some other pedestrian traffic-way. Bees fly up, up, and away as they leave the hive. Once they're 15 feet from the hive, they're way above head level.
- ✔ Not flaunting your hives. Put them in an area where they'll be inconspicuous.
- ✔ Painting or staining your hives to blend into the environment. Painting them flame orange is only tempting fate.
- ✔ Providing a nearby source of water for your bees. That keeps them from collecting water from your neighbor's pool or birdbath (see the "Providing for your thirsty bees" section later in this chapter).
- ✔ Inviting folks to stop by and watch you inspect your hive. They'll see first-hand how gentle bees are, and your own enthusiasm will be contagious.
- ✔ Letting your neighbors know that bees fly in about a three-mile radius of home plate (that's roughly 6,000 acres). So mostly they'll be visiting a huge area that isn't anywhere near your neighbor's property.
- ✔ Giving gifts of honey to all your immediate neighbors (see Figure 3-2 for an example). This gesture goes a long ways in the public relations department.

Figure 3-2:

This gift basket of honey bee products will be given to each of my immediate neighbors. That's sure to help keep the peace.



Location, Location, Location: Where to Keep Your Hives

You can keep bees just about anywhere: in the countryside, in the city, in a corner of the garden, by the back door, in a field, on the terrace, or even on an urban rooftop. You don't need a great deal of space, nor do you need to have flowers on your property. Bees will happily travel for miles to forage for what they need. These girls are amazingly adaptable, but you'll get optimum results and a more rewarding honey harvest if you follow some basic guidelines (see Figure 3-3). Basically, you're looking for easy access (so you can tend to your hives), good drainage (so the bees don't get wet), a nearby water source for the bees, dappled sunlight, and minimal wind. Keep in mind that fulfilling *all* these criteria may not be possible. Do the best you can by:

- ✓ Facing your hive to the southeast. That way your bees get an early morning wake-up call and start foraging early.
- ✓ Positioning your hive so that it is easily accessible come honey harvest time. You don't want to be hauling hundreds of pounds of honey up a hill on a hot August day.
- ✓ Providing a windbreak at the rear of the hive (see Figure 3-4). I've planted a few hemlocks behind my hives. Or you can erect a fence made from posts and burlap, blocking harsh winter winds that can stress the colony (assuming you live in a climate with cold winters).
- ✓ Putting the hive in dappled sunlight. Ideally, avoid full sun, because the warmth of the sun requires the colony to work hard to regulate the hive's temperature in the summer. By contrast, you also want to avoid deep, dark shade, because it can make the hive damp and the colony listless.
- ✓ Making sure the hive has good ventilation. Avoid placing it in a gully where the air is still and damp. Also, avoid putting it at the peak of a hill, should you live in a region where the bee will be subjected to winter's fury.
- ✓ Placing the hive absolutely level from side to side, and with the front of the hive just slightly lower than the rear (a difference of an inch or less is fine), so that any rainwater drains out of the hive (and not into it).
- ✓ Locating your hive on firm, dry land. Don't let it sink into the quagmire. Mulch around the hive prevents grass and weeds from blocking its entrances.



Figure 3-3:
The picture-perfect beeyard. Not always possible, but an admirable objective.

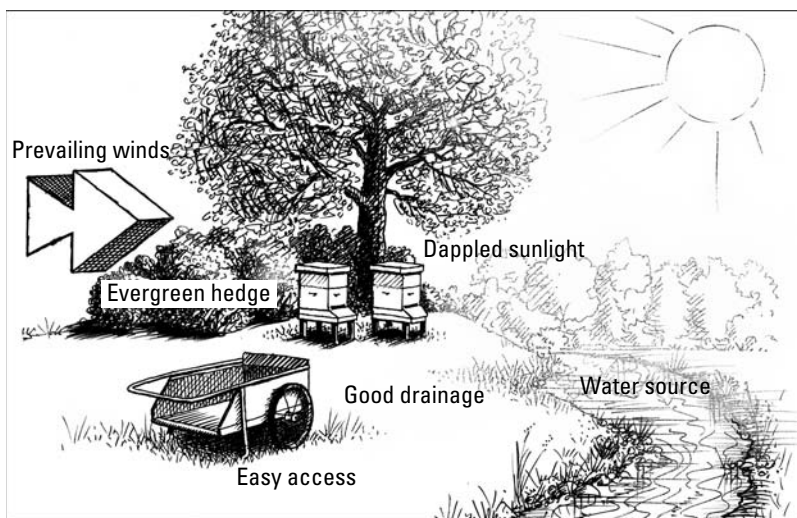

Figure 3-4:
A perfect location: hemlock windbreak, flat easy access, dappled sunlight, south-eastern exposure, and a nearby water source (not visible in this image).



If you are moving bees to a new location that is a mile or two away, no problem. But if you are moving the hive to a location much less than this, you may lose all of your field bees because they will return to where the hive used to be. If you only need to move your hive a short distance (like across your yard), move the hive a little bit at a time (a few yards each day until you reach the desired destination).

How to move a full hive

It's best not to move hives around unless it's necessary because it's disruptive to the bees and a lot of work for you. But sometimes move you must. Here are some helpful guidelines:

- ✔ Plan to make your move in the evening when the bees are not flying.
- ✔ Before making the move, tape up any extra entrance or ventilation holes you have drilled in the hive (duct tape works great).
- ✔ Secure the hive together by using heavy-duty strapping tapes (available at hardware stores). These strapping tapes use a ratchet-type buckle to tighten the straps. Strap the entire hive together as a single unit: bottom board, hive bodies, and cover.
- ✔ Staple a strip of window screening across the front entrance of the hive. Doing so will keep the bees from flying out of the hive (and stinging you) while providing them with adequate ventilation.
- ✔ Use a hand truck to move the hive (an entire hive can weigh a couple hundred pounds). Get a friend to help.
- ✔ Wear a veil and gloves in case any bees get loose. I can assure you that they won't be happy about this move.
- ✔ Once the hive is in its new location, wait until early the next morning to remove the straps and the entrance screen. This gives the bees time to calm down.

Providing for your thirsty bees

During their foraging season, bees collect more than just nectar and pollen. They gather a whole lot of water. They use it to dilute honey that's too thick, and to cool the hive during hot weather. Field bees bring water back to the hive and deposit it in cells, while other bees fan their wings furiously to evaporate the water and regulate the temperature of the hive.

If your hive is at the edge of a stream or pond, that's perfect. But if it isn't, you should provide a nearby water source for the bees. Keep in mind that they'll seek out the nearest water source. You certainly don't want that to be your neighbor's kiddie pool. You can improvise all kinds of watering devices. Figure 3-5 shows an attractive and natural-looking watering device that I created on top of a boulder that sits in one of my beeyards. All it took was a little cement, a dozen rocks and a few minutes of amateur masonry skills.

Consider these other watering options: a pie pan filled with gravel and topped off with water, a chicken-watering device (available at farm supply stores; see Figure 3-6), or simply an outdoor faucet that is encouraged to develop a slow drip.

When it comes to providing water for your bees, here's a nifty idea that I learned from a fellow beekeeper. Find or purchase a clean pail or bucket. Any size, color, or material will do. Just make sure that it's clean and has never been used for chemicals, fertilizers, or pesticides. Drill ½-inch drainage holes

all around the top edge of the bucket. The holes should be placed about 2 to 3 inches down from the top. Fill the bucket nearly to the holes with water, and then float a single layer of Styrofoam packaging pellets on the surface of the water. The pellets give the bees something to stand on as they sip water. That way they won't drown. The drainage holes keep rainwater from overflowing the bucket and washing away the pellets. Neat, huh?



You can use a hive top feeder, filled with water (not syrup) as a convenient way to provide your colony with water.

Figure 3-5:
A shallow
bee water-
ing pool
that I con-
structed on
a boulder
near my
hives.



Figure 3-6:
A chicken
waterer is a
great way to
provide your
bees with
water. Place
some gravel
or small
pebbles in
the tray, so
the bees
don't drown.



Understanding the correlation between geographical area and honey flavors

The type of honey you eat usually is classified by the primary floral sources from which the bees gathered the nectar. A colony hived in the midst of a huge orange grove collects nectar from the orange blossoms — thus the bees make orange-blossom honey. Bees in a field of clover make clover honey, and so on. As many different kinds of honey can exist as there are flowers that bloom. The list gets long.

For most hobbyists, the flavor of honey they harvest depends upon the dominant floral sources in their areas. During the course of a season, your bees visit many different floral sources. They bring in many different kinds of nectar. The resulting honey, therefore, can properly be classified as *wild-flower honey*, a natural blend of various floral sources.

The beekeeper who is determined to harvest a particular kind of honey (clover, blueberry, apple blossom, sage, tupelo, buckwheat, and so on) needs to locate his or her colony in the midst of acres of this preferred source and must harvest the honey as soon as that desired bloom is over. But, doing so is not very practical for the backyard beekeeper. Leave it to the professional migratory beekeepers.

My advice? Let the bees do their thing and collect from myriad nectar sources. You'll not be disappointed in the resulting harvest, because it will be unique to your neighborhood and better than anything you have ever tasted from the supermarket. Guaranteed!

Knowing When to Start Your Adventure

The answer depends upon where you live. A good time to start is a few months before the “official” launch of the season (when the flowers come into bloom). There's a chart in Chapter 8 that will help you determine the right calendar of events for your region and climate. Generally speaking, in the United States, the season officially starts in the early spring when the bee breeders in the southern states have package bees to sell. Don't wait until the last minute. Use the “winter” months to order and assemble the equipment that you'll need and to reserve a package of bees for early spring delivery. Read up on bees and beekeeping and become familiar with your equipment. Join a bee club and attend its meetings. That's a great way to get to know more about beekeeping and meet new friends. Many clubs have special programs for new beekeepers (called newbees) and hands-on weekend workshops that show you how it's done. Latch on to a mentor whom you can call on to answer questions and help you get started.

Install your bees in the early spring (April or early May is best). Spring varies from area to area, but you're trying to time your start to coincide with the first early season blossoms, and just a few weeks prior to the fruit bloom. Don't wait until June or July. Starting a hive in summer won't give your colony a chance to grow strong for its first winter.

Be sure to have everything assembled and ready to go before the post office calls announcing the arrival of your bees. As for what kind of equipment you need to get for this new adventure, that's covered in Chapter 4.

Chapter 4

Basic Equipment for Beekeepers

In This Chapter

- ▶ Deciding what equipment and tools to get
 - ▶ Assembling woodenware
 - ▶ Preserving the wood to last for years
 - ▶ Picking up some tricks of the trade
 - ▶ Considering really helpful accessories
-

Beekeepers use all kinds of fantastic tools, gadgets, and equipment. Quite frankly, part of the fun of beekeeping is putting your hive together and using the paraphernalia that goes with it. The makings for a beehive come in a kit form and are precut to make assembly a breeze. The work is neither difficult, nor does it require too much skill. Some suppliers will even assemble the kits for you.



The more adventuresome among you may want to try making your own hives from scratch. But precise measurements are critical to the bees, and unless you're pretty good at carpentry and have a lot of time to spend, purchasing what you need is probably easier. Once you get the hang of beekeeping, you can try your hand at making your own hives.

Many different mail order establishments offer beekeeping supplies, and a number of excellent ones are now on the Internet. Check out a listing of some of the quality suppliers in Appendix A.

Finding Out about the Langstroth Hive

Many different kinds and sizes of beehives are available. But worldwide, the most common is the 10-frame *Langstroth hive*. This so-called moveable

frame hive with a practical top opening was the 1851 invention of Rev. Lorenzo L. Langstroth of Pennsylvania (see Figure 4-1). Its design hasn't changed much in the last 150 years, which is a testament to its practicality. Therefore, this is the style of hive we will concentrate on in this book.

Figure 4-1:
The "father"
of modern
beekeeping,
Lorenzo
Langstroth.



Here are some of the benefits of the Langstroth hive:

- ✓ Langstroth hive parts are completely interchangeable and readily available from any beekeeping supply vendor.
- ✓ All interior parts of the hive are spaced exactly three-eighths of an inch apart (9.525 mm), thus enabling honey bees to build straight and even combs. Because it provides the right "bee space," the bees don't "glue" parts together with propolis or burr comb.
- ✓ Langstroth's design enables beekeepers to freely inspect and manipulate frames of comb. Prior to this discovery, beekeepers were unable to inspect hives for disease, and the only way to harvest wax and honey was to kill the bees or drive them from the hive.

Figure 4-2 shows a simple basket hive, or *skep* was popular for hundreds of years in many countries. But, with this design, you have no way to inspect the bees' health and no way to harvest honey without destroying the bees and comb. Although the skep hive is rarely used today, it still is associated with the public's "romantic" image of what a beehive looks like.

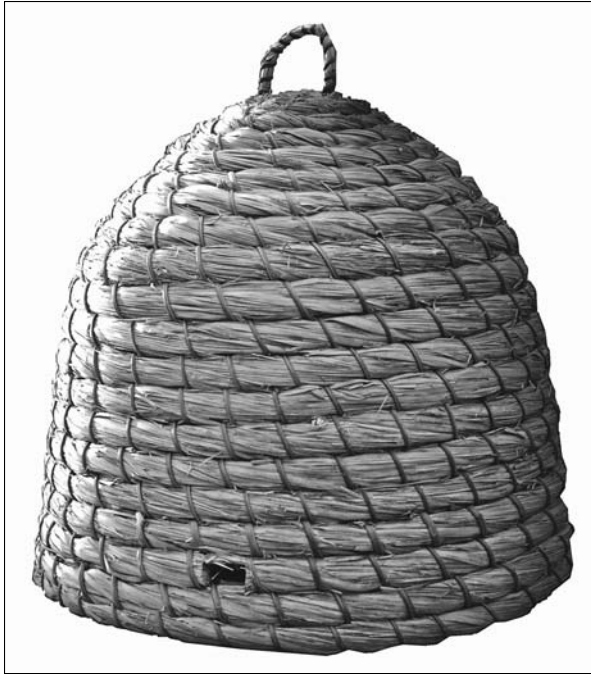

Figure 4-2:
A simple
basket, or
skep hive.

Knowing the Basic Woodenware Parts of the Hive

Woodenware refers to the various components that collectively result in the beehive. Traditionally these components are made of wood — thus the term — but some manufacturers offer synthetic versions of these same components (plastic, polystyrene, and so on). My advice: Get the wood. The bees accept it far more readily than synthetic versions. And the smell and feel of wood is ever so much more pleasurable to work with.



Be aware that the hive parts you order (see “Ordering Hive Parts” later in this chapter) will arrive in precut pieces. You will need to spend some time assembling them. See “Setting Up Shop” later in this chapter for a list of tools and so forth that you will need for assembly. **Note:** Some vendors will preassemble hives for you, usually for a slight extra charge.

This section discusses, bottom to top, the various components of a modern Langstroth beehive. As you read this section, refer to Figure 4-3 to see what the various parts look like and where they are located within the structure of the hive.

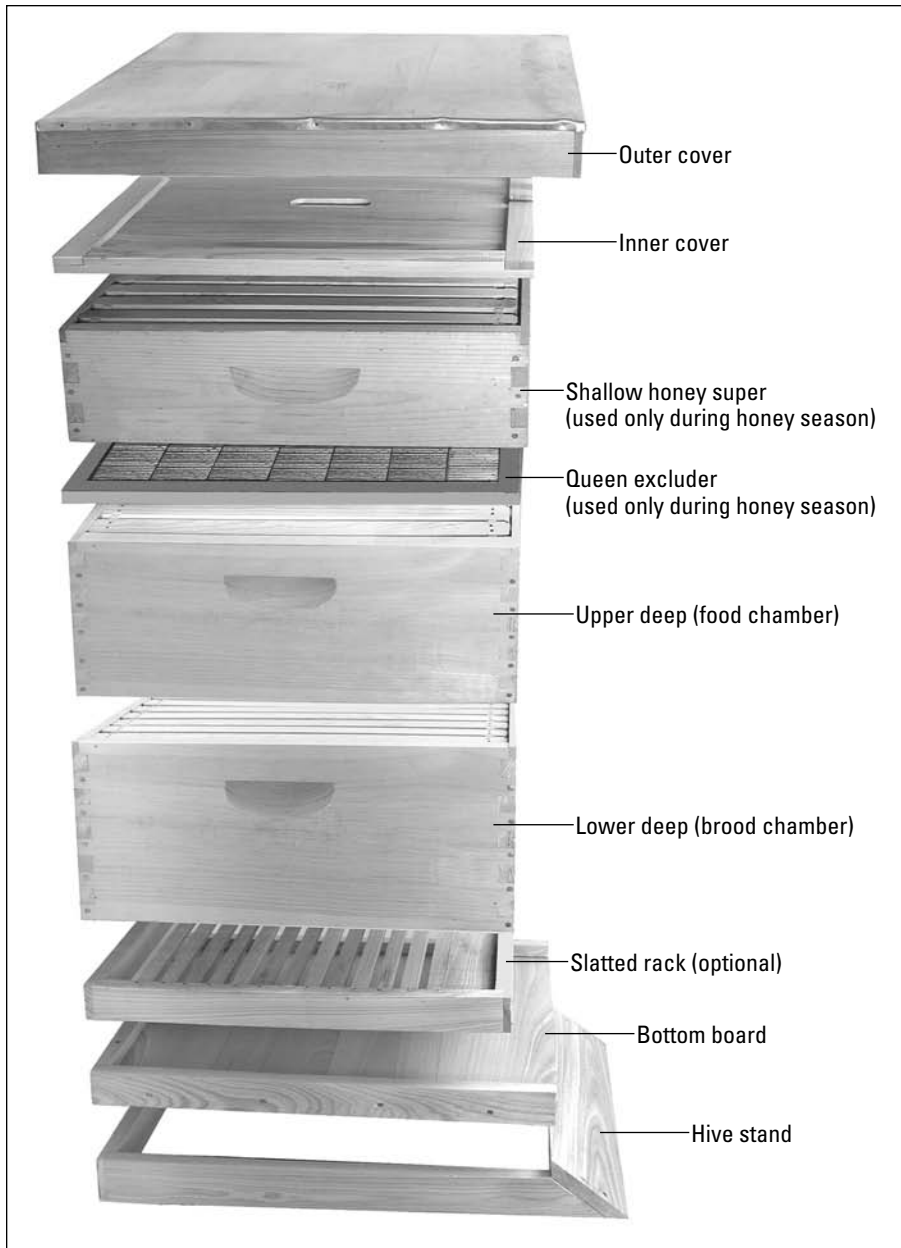

Figure 4-3:
The basic
components
of a modern
Langstroth
hive.

Hive stand

The entire hive sits on a hive stand. The best ones are made of cypress — a wood that is highly resistant to rot. The stand is an important component of the hive because it elevates the hive off the ground, improving circulation and minimizing dampness. In addition, grass growing in front of the hive's entrance can slow the bees' ability to get in and out. The stand alleviates that problem by raising the hive above the grass.



The hive stand consists of three rails and a landing board, upon which the bees land when they return home from foraging trips. Nailing on the landing board just right is the only tricky part of hive stand assembly. Carefully follow the instructions that come with your hive stand. **Note:** Putting the stand together on a flat surface helps prevent the stand from wobbling.

Bottom board

The *bottom board* is the thick bottom floor of the beehive. Like the hive stand, the best bottom boards are made of cypress wood. This part's easy and intuitive to put together.



Some beekeepers will use what's called a "screened" bottom board in place of the standard bottom board. This improves ventilation and is helpful when monitoring the colony's population of varroa mites (see Chapter 11).

Entrance reducer

When you order a bottom board, it comes with a notched wooden cleat. The cleat serves as your *entrance reducer*, which limits bee access to the hive and controls ventilation and temperature during cooler months. The entrance reducer isn't nailed into place, but rather is placed loosely at the hive's entrance. The small notch reduces the entrance of the hive to the width of a finger. The larger notch (if available on the model you purchase) opens the entrance to about four finger widths. Removing the entrance reducer completely opens the entrance.



Beekeepers use the entrance reducer only for newly established hives or during cold weather (see Chapter 5). This is the reason the entrance reducer isn't shown in Figure 4-3. For established hives in warm weather, the entrance reducer isn't used at all. The only exception may be when you're dealing with a robbing situation — see Chapter 9.



If you can't find your entrance reducer, use a handful of grass to reduce the hive opening.

Deep-hive body

The *deep-hive body* contains ten frames of honeycomb. The best quality ones are made of clear pine or cypress and have crisply cut dovetail joints for added strength. You'll need two deep-hive bodies to stack one on top of the other, like a two-story condo. The bees use the *lower deep* as the nursery, or *brood chamber*, to raise thousands of baby bees. The bees use the *upper deep* as the pantry or *food chamber*, where they store most of the honey and pollen for their use.



If you live in an area where cold winters just don't happen, you don't need more than one deep hive body for your colony.

The hive body assembles easily. It consists of four precut planks of wood that come together to form a simple box. Simply match up the four planks, and hammer a single nail in the center of each of the four joints to keep the box square. Use a carpenter's square to even things up before hammering in the remaining nails.

Place the hive body on the bottom board. If it rocks or wobbles a little, use some coarse sandpaper or a plane to remove any high spots. The hive body needs to fit solidly on the stand.



Use a little waterproof wood glue on the joints of all your woodenware before nailing them together. That gives you a super-strong bond.

Queen excluder

No matter what style of honey harvest you choose, a queen excluder is a basic piece of equipment you need. It's placed between the deep food chamber and the shallow (or medium) honey supers, the parts of the hive that are used to collect surplus honey. The queen excluder comes already assembled and consists of a wooden frame holding a grid of metal wire, or a perforated sheet of plastic (see Figure 4-4). As the name implies, this gizmo prevents the queen from entering the honey super and laying eggs. Otherwise, a queen laying eggs in the super encourages bees to bring pollen into the super, spoiling the clarity of the honey. The spacing of the grid is such that smaller worker bees can pass through to the honey supers.



You use a queen excluder only when you place honey supers on the hive and the bees are bringing in nectar and making it into honey. It is a piece of woodenware that is unique to honey production. When you are not collecting honey, it should not be used.

For the do-it-yourselfer

If you're handy, you may want to try building your own equipment. For the more adventure-some, I include some plans in Chapter 15 to help you along. Remember that precise measurements are critical within a hive. Bees require a precise *bee space*. If you wind up with too little

space for the bees, they'll glue everything together with propolis. Too much space, and they'll fill it with burr comb. Either way, it makes the manipulation and inspection of frames impossible. So, as the old saying goes, measure twice and cut once!



Many experienced beekeepers (myself included) will not use a queen excluder as doing so can slow down the bees' progress in producing honey. Some say it may even contribute to swarming (see Chapter 9 for more on swarming). However, it takes a season or two of experience to judge when it's okay to bypass using a queen excluder. My recommendation: Play it safe in year one and use the queen excluder. Next year you can try not using it when you put the honey supers on.

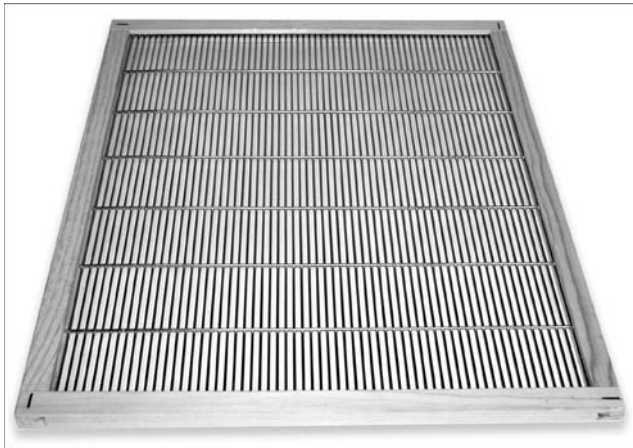

Figure 4-4:
A queen
excluder.

Shallow or medium honey super

Honey supers are used by beekeepers to collect surplus honey. That's *your* honey — the honey that you can harvest from your bees. The honey that's in the deep-hive body you need to leave for the bees. Supers are identical in design to the deep-hive bodies — and assemble in a similar manner — but the depth of the supers is shallower.



Making your woodenware last

To get the maximum life from your equipment, you must protect it from the elements. If you don't, wood that's exposed to the weather rots.

After you've assembled your equipment and before you put your bees in their new home, paint all the *outer* surfaces of the hive (see the following list). Use (at least) two coats of a good quality outdoor paint (either latex or oil-based paints are okay). The color is up to you. Any light pastel color is fine, but avoid dark colors, because they will make the hive too hot during summer. White seems to be the most traditional color. If you prefer, you can stain your woodenware and treat it with an outdoor grade of polyurethane.

Do paint/treat the following:

- ✓ Wooden hive-top feeder (outside surfaces only)

- ✓ Outer cover (inside and outside surfaces)
- ✓ Supers and hive bodies (outside surfaces only)
- ✓ Bottom board (all surfaces)
- ✓ Hive stand (all surfaces)

Do not paint/treat the following:

- ✓ Inner cover
- ✓ Frames
- ✓ Inside surfaces of supers, hive bodies, and wooden hive-top feeder
- ✓ Queen excluder

They come in two popular sizes: shallow and medium. The shallow supers are $5\frac{11}{16}$ inches deep, and the medium supers are $6\frac{5}{8}$ inches deep. Medium supers are sometimes referred to as “Western” or “Illinois” supers.

Honey supers are put on the hive about eight weeks after you first install your bees. For the second-year beekeeper, honey supers are placed on the hive when the first spring flowers start to bloom.

The reduced depth of the supers makes them easy to handle during the honey harvest. A shallow super full of honey will weigh a hefty (but manageable) 40 pounds. A medium super full of honey weighs about 50 pounds. However a *deep-hive body* full of honey weighs a backbreaking 80 pounds. That's more weight than you'd want to deal with!



You can use medium-size equipment for your entire hive. Three medium-depth hive bodies are equivalent to two deep hive bodies. Standardizing on one size means that all of your equipment is 100-percent interchangeable. The lighter weight of each medium hive body makes lifting much, much easier.



As the bees collect more honey, you can add more honey supers to the hive, stacking them one on top of another like so many stories to a skyscraper. For your first season, order one or two honey supers (either shallow or medium).

Nine or ten frames?

I like using nine frames in my honey supers. I also use special spacers along the frame rails to keep the distance between frames exact. Why do I use nine? That little extra space between

each frame allows the bees to draw the comb much deeper. This results in more honey in the nine frames than there would have been in ten.

Frames

Each wooden frame contains a single sheet of beeswax foundation (described in the next section). The frame is kind of like a picture frame. It firmly holds the wax and enables you to remove these panels of honeycomb for inspection or honey extraction. Ten deep frames are used in each deep-hive body, and nine shallow frames usually are used in each shallow honey super. Frames are the trickiest pieces of equipment you'll have to assemble. Beekeeping suppliers usually sell frames in packages of ten, with hardware included.

Although there are plastic frames and foundation available from some beekeeping suppliers, I don't like the plastic products. I much prefer the "all-natural" equipment, and I feel the bees share my preference. So in this book, I will focus on the traditional, wooden frames and pure beeswax foundation.

There is no doubt that plastic won't rot, nor will it be nibbled up by critters. Plastic frames last longer than wood, and plastic foundation is far more durable than delicate wax foundation. However, the bees are very slow to work plastic foundation into honeycomb. You need a super strong nectar flow to entice them. Not so with the all-natural setup of wood frames and beeswax foundation. The bees will eagerly and quickly convert the beeswax foundation into honeycomb. And the natural stuff smells so good! Want to be convinced? Use plastic frames and plastic foundation in one hive and wooden frames and beeswax foundation in a second hive. See for yourself.

Frames come in three basic sizes: deep, shallow, and medium — corresponding to deep hive bodies and shallow or medium honey supers. The method for assembling deep, shallow, or medium frames is identical. Regardless of its size, each frame has four basic components: one top bar with a wedge (the wedge holds the foundation in place), one bottom bar assembly (consisting of either two rails or a single bar with a slit running its length), and two sidebars (see Figure 4-5). Frames typically are supplied with the necessary and correct size nails.

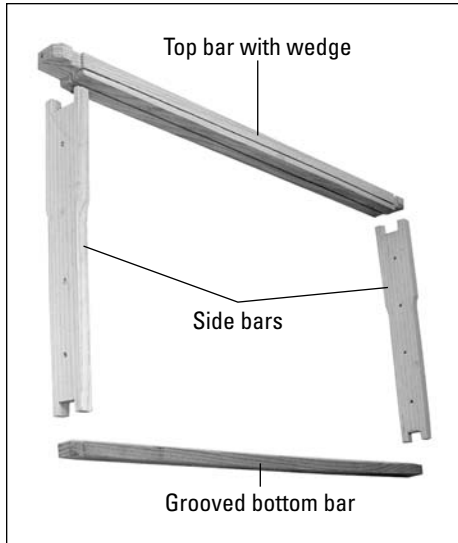

Figure 4-5:
The parts of
a frame.

Assemble your frames by following these directions:

1. Take the top bar and snap out the wedge strip. You can use your hive tool to pry the wedge strip from its place. Clean up any *filigree* (rough edges) by scraping the wood with your hive tool. Save the wedge for use when you're installing the wax foundation (see the "Foundation" section next).
2. Place the top bar on your tabletop work surface with the flat side facing down on the table.
3. Take the two side pieces and snap the wider end into the slots at either end of the top bar.
4. Now snap your bottom bar assembly into the slots at the narrow end of the side pieces (depending upon the manufacturer, this assembly will either consist of two rails or a single bar with a slit running its length).
5. Now nail all four pieces together. Use a total of six nails per frame (two for each end of the top bar, and one at each end of the bottom bar). In addition to nailing, I suggest that you also glue the parts together using an all-weather wood glue. Doing so adds strength.
6. Repeat these steps until all your frames are assembled. Time for a break while the glue dries.



Don't be tempted to use any shortcuts. Frames undergo all kinds of abuse and stress, so their structural integrity is vital. Use glue for extra strength and don't skimp on the nails nor settle for a bent nail that's partially driven home. There's no cheating when it comes to assembling frames!

Foundation

Foundation consists of thin rectangular sheets that are used to urge your bees to draw even and uniform honeycombs. It comes in two forms: plastic and beeswax. Using plastic foundation has some advantages, because it's stronger than wax and resists wax moth infestations. But the bees are slow to accept plastic, and I don't recommend it for the new beekeeper. Instead, purchase foundation made from pure beeswax. The bees will accept it much more quickly than plastic, and you will have a much more productive and enjoyable first season with your bees. In subsequent seasons you can experiment with plastic – but I'll bet you come back to the wax! Beeswax foundation is wired for strength, and imprinted with a hexagonal cell pattern that guides the bees as they draw out uniform, even combs. Some foundation comes with the wire already embedded into the foundation (my preference). Some you must wire manually after installing the foundation in the frames.

Your bees find the sweet smell of beeswax foundation irresistible and quickly draw out each sheet into thousands of beautiful, uniform cells on each side where they can store their food, raise brood, and collect honey for you!

Like frames, foundation comes in deep, shallow, and medium sizes — deep for the deep-hive bodies, shallow for the shallow supers, and medium for the medium supers. You insert the foundation into the frames the same way for all of them.

Here's how to insert foundation into your frames:

1. With one hand, hold the frame upright on the table. Look closely at a sheet of foundation. If it's the prewired variety (my recommendation), you will note that vertical wires protrude from one side and are bent at right angles. However, wires at the other side are trimmed flush with the foundation. Drop this flush end into the long groove or slit of the bottom bar assembly and then coax the other end of the foundation into the space where the wedge bar was (see Figure 4-6).
2. Turn the frame and foundation upside down (with the top bar now resting flat on the table). Adjust the foundation laterally so that equal space is on the left and right. Remember the wedge strip you removed when assembling the frames . . . now's the time to use it! Return the wedge strip to its place, sandwiching the foundation's bent wires between the wedge strip and the top bar (see Figure 4-7). Use a brad driver to nail the wedge strip to the top bar (see Figure 4-8). Start with one brad in the center, and then one brad at each end of the wedge strip. Add two more brads for good luck (five total).

Finally, use support pins — they look like little metal clothespins — to hold the foundation securely in place (see Figure 4-9). The pins go through predrilled holes in the side bars, and pinch the foundation to hold it in place.

Although each side bar has three to four predrilled holes, use only *two* pins on each sidebar (four per frame). The extra holes are for those who want to manually wire their foundation – that’s not me!

That’s it! You’ve completed building one frame. Only 19 more to go!

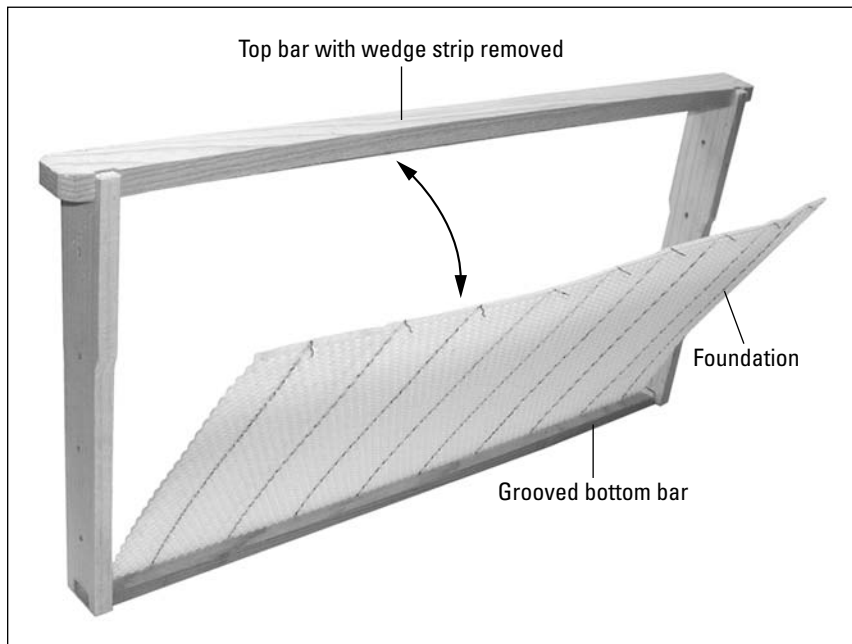

Figure 4-6: Inserting the pre-wired foundation sheet into the grooved or slotted bottom assembly.

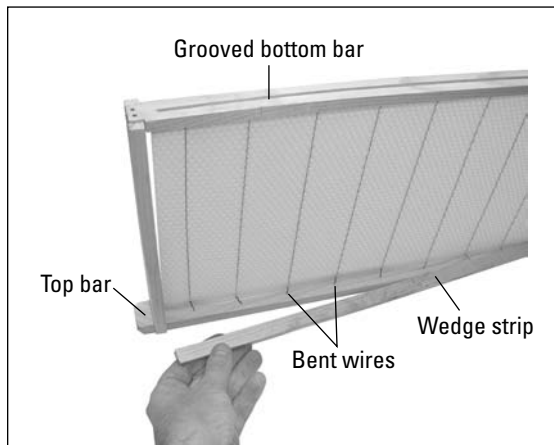
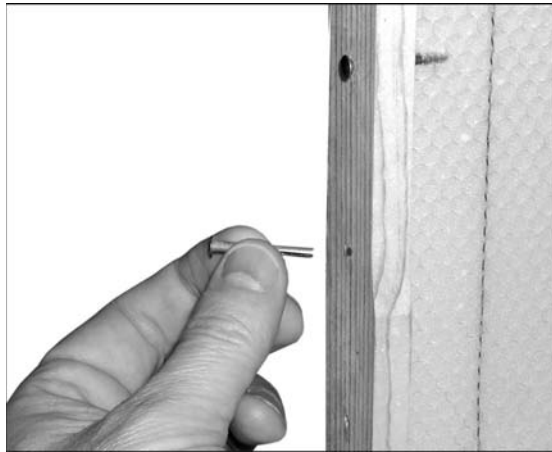

Figure 4-7: Turn the frame upside-down to sandwich the foundation’s bent wires between the wedge strip and the top bar.

Figure 4-8:
With the
frame still
upside-
down, use a
brad driver
to nail the
wedge strip
back in
place.



Figure 4-9:
Insert
support pins
in predrilled
holes to
hold
the wax
foundation
in place.



Inner cover

Inner covers of good quality are made entirely of cypress wood. Budget models made from pressboard or Masonite also are available, but they don't seem to last as long. Alternatively, there are plastic ones available that will never rot. See Figure 4-10. The basic design consists of a framed flat plank with a precut hole in the center of the plank. The inner cover resembles a shallow tray (with a hole in the center). In some models, a notch is cut out of one of the lengths of frame. This is a ventilation notch, and it is positioned to the front of the hive. The inner cover is placed on the hive with the "tray"

side facing up. See Figure 4-11. If your model has a half-moon ventilation notch (as seen in the figure) place the notch toward the front of the hive. The outer cover is placed over this inner cover.

Figure 4-10:
A wooden
and a
plastic inner
cover.



Figure 4-11:
The correct
placement
of an inner
cover. Note
tray side
faces up.



Knowing the right and wrong ways to put the inner cover on the hive

There is a correct way and incorrect way to put the inner cover on the hive. Note that there's a completely flat side, and a side with a ridge on all four sides. On some models, one of these ridges has a ventilation notch cut out of it. The inner cover goes immediately under the outer cover. The side with the ridge faces skyward.

The notched ventilation hole goes toward the front of the hive.

Note: You do *not* use the inner cover at the same time you have a hive-top feeder on the hive. The hive-top feeder (described later in this chapter) takes the place of the inner cover.

Outer cover

Look for cypress wood when buying an outer cover. Cypress resists rot and lasts the longest. Outer covers assemble in a manner similar to the inner cover: a frame containing flat planks of wood. But the *outer* cover has a galvanized steel tray that fits on the top, protecting it from the elements. Alternatively, there are some plastic models on the market that will never rot. Not quite as “pretty” as wood, but perhaps practical.

Ordering Hive Parts

Hive manufacturers traditionally make their woodenware out of pine and/or cypress. Hardwoods are fine, but too expensive for most hobbyists. A custom mahogany hive, for instance, runs more than \$1,000 versus a standard pine and cypress hive for about \$150 to \$300. Many suppliers offer various grades of components from a *commercial* budget-grade to a *select* best quality-grade. Go for the highest quality that your budget allows. Although they may be a little more expensive upfront, quality parts assemble with greater ease, and are far more likely to outlast the budget versions.

Any of this stuff is available from beekeeping supply stores. Most of these vendors are now on the Web. For a listing of some of my favorites, see Appendix A.



Don't wait until the last minute to order your first startup kit. In the United States, springtime is the beginning of the beekeeping season. If you wait until spring to order your kit, you will likely have to wait to get it (the suppliers become swamped with orders at that time). Ideally it's best to get all the stuff you need a few months before you plan to start your hive.

Eight frame hives lighten the load

Some beekeepers use smaller hives whose hive bodies contain only eight frames (versus the traditional ten frames per hive body). The result of course is a lighter-weight hive that can be

easier to manipulate. This is a nice option for the beekeeper who just wants a small hive in the garden for pollination.

Startup hive kits

Many suppliers offer a basic startup kit that takes the guesswork out of what you need to get. These kits often are priced to save a few bucks. Make certain that your kit contains these basic items, discussed in this section:

- ✓ Bottom board
- ✓ Lower and upper deep
- ✓ Honey super (shallow or medium)
- ✓ Inner and outer covers
- ✓ Frames and foundation for both deeps and the honey super
- ✓ Hardware to assemble stuff (various size nails, foundations pins, and so on)
- ✓ Veil and gloves
- ✓ Smoker
- ✓ Hive tool

Setting up shop

Before your bees arrive, you'll need to order and assemble the components that will become their new home. You don't need much space for putting the equipment together. A corner of the garage, basement, or even the kitchen will do just fine. A worktable is mighty handy, unless you actually like crawling around on the floor.

Get all your hive parts (woodenware) together and the instruction sheets that come with them. The only tool you absolutely *must* have is a hammer. But having the following also is mighty useful:

- ✔ A pair of pliers to remove nails that bend when you try to hammer them.
- ✔ A brad driver with some $\frac{3}{4}$ -inch, 18-gauge brads. Having this tool makes the installation of wax foundation go much faster.
- ✔ A bottle of good quality all-weather wood glue. Gluing and nailing woodenware greatly improves their strength and longevity.
- ✔ A carpenter's square to ensure parts won't wobble when assembled.
- ✔ Some coarse sandpaper or a plane to tidy-up any uneven spots.
- ✔ A hive tool (I hope one came with your startup kit). It's pretty handy for pulling nails and prying off the frame's wedge strip.



Start assembling your equipment from the ground up. That means starting with the hive stand, moving on to the bottom board, and so forth. That way you can begin to build the hive and ensure everything sits level and snug.



The various assembled parts of the hive are not nailed together. They simply are stacked one on top of the other (like a stack of pancakes). This enables you to open up and manipulate the hive and its parts during inspections.

Adding on Feeders

Feeders are used to offer sugar syrup to your bees when the nectar flow is minimal or nonexistent. They also provide a convenient way to medicate your bees (some medications can be dissolved in sugar syrup and fed to your bees). You must feed your bees in the early spring and once again in autumn (see Chapter 8). If needed, you may also want to medicate the colony. Each of the many different kinds of feeders has its pluses and minuses. I've included a brief description of the more popular varieties.

Hive-top feeder

The hive-top feeder (sometimes called a "Miller" feeder after its inventor, C. C. Miller) is the model I urge you to use (see Figure 4-12). There are various models, but the principle is similar from one to the next. As a new beekeeper, you will love how easy and safe it is to use. The hive-top feeder sits directly on top of the upper deep brood box and under the outer cover (no inner cover is used when a hive-top feeder is in place). It has a reservoir that can hold one to three gallons of syrup. Bees enter the feeder from below by means of a screened access.

Anticipating the length of assembly time

By all means make sure every thing is ready *before* your bees arrive on your doorstep. Don't wait until the last minute to put things together. It probably will take a bit longer than you think, particularly if you are doing this for the first time.

First-timers should allow 3 to 4 hours to assemble the various hive bodies and supers, bottom board, and the outer and inner covers. Assembling frames and installing the foundation may require another few hours.

And then you need to allow an hour or two to paint your equipment. Plus there's the cleanup time and the time for the paint to dry. All in all, your weekend is cut out for you.

My advice? Order your equipment 2 to 3 months before your bees are scheduled to arrive. Use all that extra time to ensure a timely delivery of the equipment and to leisurely put things together long before the bees arrive.

The hive-top feeder has several distinct advantages over other types of feeders:

- ✔ Its large capacity means that you don't have to fill the feeder more than once every week or two.
- ✔ The screened bee access means that you can fill the feeder without risk of being stung (the bees are on the opposite side of the screen).
- ✔ Because you don't have to completely open the hive to refill it, you don't disturb the colony (every time you smoke and open a hive you set the bees' progress back a few days).
- ✔ Because the syrup is not exposed to the sun, you can add medication without concern that light will diminish its effectiveness.

But with all of these good features, there are a couple of negatives:

- ✔ Sometimes in the frenzy of feeding, bees will lose their grip on the screen, and some will drown in the syrup. But there's an easy remedy — just float a small wooden dowel in the areas where the bees feed. These "rafts" give the bees additional footholds.
- ✔ When they are full, the feeder is awkward and heavy to remove for routine inspections.

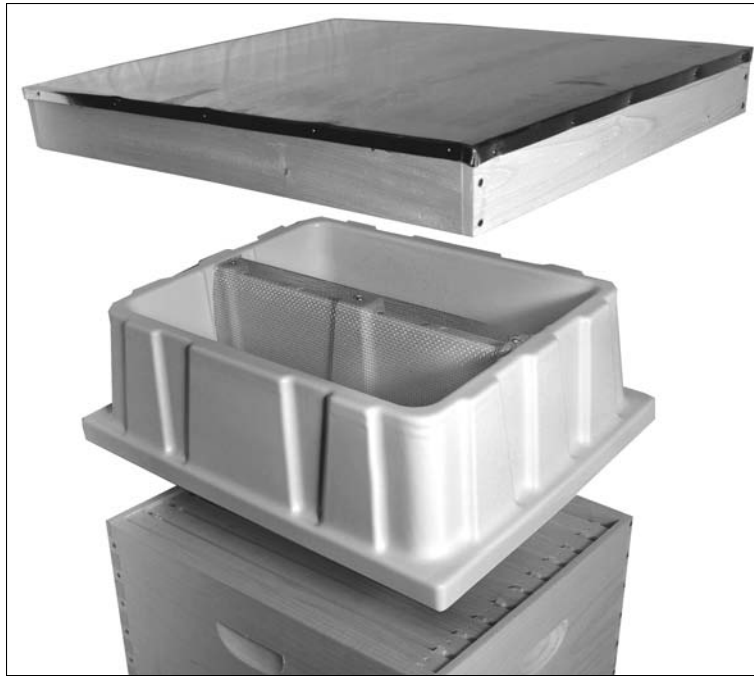

Figure 4-12:
A hive-top
feeder.

Entrance feeder

The entrance feeder (sometimes called a “Boardman” feeder) is a popular device consisting of a small inverted jar of syrup that sits in a contraption at the entrance to the hive (see Figure 4-13). Entrance feeders are inexpensive and simple to use. And they come with many hive kits. But I don’t recommend that you use an entrance feeder. They have few advantages (other than they are cheap) and have many worrisome disadvantages:

- ✓ The feeder’s proximity to the entrance can encourage bees from other hives to rob syrup and honey from your hive.
- ✓ You’re unable to medicate the syrup because it sits directly in the sun.
- ✓ The feeder’s exposure to the hot sun tends to spoil the syrup.
- ✓ Refilling the small jar frequently is necessary (often daily).
- ✓ Using an entrance feeder in the spring isn’t effective. The entrance feeder is at the bottom of the hive, but the spring cluster of bees is at the *top* of the hive.
- ✓ Being at the entrance, you risk being stung by guard bees when you refill the feeder.



Figure 4-13:
An entrance
feeder.

Pail feeder

The pail feeder consists of a one-gallon plastic pail with a friction top closure. Several tiny holes are drilled in its top. The pail is filled with syrup, and the friction top is snapped into place. The pail then is inverted and placed over the oval hole in the inner cover (Figure 4-14). These work on the same principle as a water cooler where the liquid is held in by a vacuum. The syrup remains in the pail, yet is available to the bees that feed via the small holes. Although inexpensive and relatively easy to use, it also has a few disadvantages:

- ✔ This feeder is placed within an empty deep-hive body, with the outer cover on top.
- ✔ You essentially must open the hive to refill the feeder, leaving you vulnerable to stings (see the following Tip to avoid this problem).
- ✔ Refilling this feeder requires smoking your bees and disrupting the colony.
- ✔ Its one-gallon capacity requires refilling once or twice a week.
- ✔ Limited access to syrup means that only a few bees at a time can feed.



Cover the hole on the inner cover with a small piece of #8 wire hardware cloth, and it will keep the bees from flying out at you when you remove the bucket for re-filling. The hardware cloth should be affixed to the top side of the inner cover.

Figure 4-14:

Here's a pail feeder placed over the oval hole of the inner cover. By covering the feeder with an empty deep-hive body you can keep raccoons out of the feeder.



Baggie feeder

Here's yet another cost-effective solution. Into a one-gallon size sealable plastic baggie, pour three quarts of syrup. Zip it up. Lay the baggie of syrup flat and directly on the top bars. Note the air bubble that forms along the top of the bag. Use a razor blade to make a couple of 2 inch slits into the air bubble. Squeeze the bag slightly to allow some of the syrup to come through the slits (this helps the bees "discover" the syrup). Now you will need to place an empty super and outer cover on the hive (to cover the feeder). See Figure 4-15.

The advantages of using a baggie feeder are as follows:

- ✓ Very cost effective
- ✓ Reduces the likelihood of robbing
- ✓ Puts the feed directly on top of the bees for easy access
- ✓ No drowned bees

There are some disadvantages

- ✔ You have to disrupt the bees to put new bags on.
- ✔ The old bags are not reusable once you cut them with a razor.
- ✔ The bags have to be replaced frequently.



Figure 4-15:
A baggie
feeder is a
cost-
effective
feeding
option.

Frame feeder

This plastic feeder is a narrow vessel resembling a standard frame that is placed in the upper deep-hive body, replacing one of the wall frames (see Figure 4-16). Filled with a pint or two of syrup, bees have direct access to it. But it isn't very practical:

- ✔ Its capacity is small and must be refilled frequently, sometimes daily.
- ✔ You lose the use of one frame while the feeder is in place.
- ✔ Opening the hive to refill the feeder is disruptive to the colony and exposes you to stings.
- ✔ Bees can drown in the feeder.

Figure 4-16:
Frame
feeders
are placed
within
the hive,
replacing
a frame of
comb.

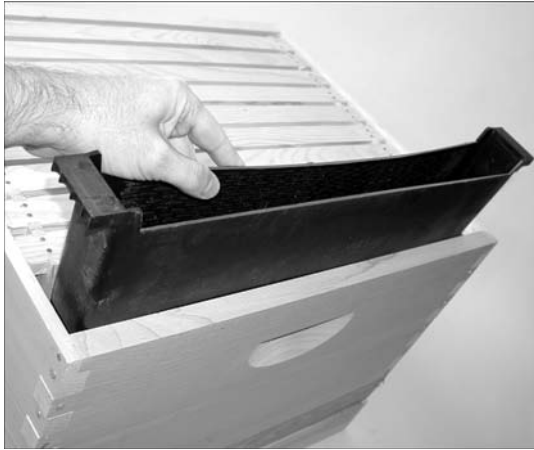

Fundamental Tools

Two tools — the smoker and the hive tool — are a must for the beekeeper. They're used every time you visit the hive and are indispensable.

Smoker

The smoker will become your best friend. Smoke calms the bees and enables you to safely inspect your hive. Quite simply, the smoker is a fire chamber with bellows designed to produce lots of cool smoke. Figure out how to light it so that it stays lit, and never overdo the smoking process. A little smoke goes a long way. (See Chapter 6 for more about how to use your smoker.)

Smokers come in all shapes, sizes, and price ranges, as shown in Figure 4-17. The style that you choose doesn't really matter. The key to a good smoker is the quality of the bellows. Consider one fabricated from stainless steel to avoid rusting.

Hive tool

The versatility of the simple hive tool is impressive. Don't visit your hives without it! Use it to scrape wax and propolis off woodenware. Use it to loosen hive parts, open the hive, and manipulate frames. You can choose from various models (see Figure 4-18). To see pictures of the hive tool in action, go to Chapters 6 and 7.



Figure 4-17:
Various
smokers.



Figure 4-18:
Two
varieties of
hive tools.

Bee-Proof Clothing

New beekeepers should wear a long-sleeved shirt when visiting the hive. Light colors are best — bees don't like dark colors. Wear long pants and slip-on boots. Tuck your pant legs into the boots. Alternatively, use Velcro or elastic strips (even rubber bands) to secure your pant legs closed. You don't want a curious bee exploring up your leg! You should also invest in veils and gloves, which are discussed in this section.

Veils

Don't ever visit your hive without wearing a veil. Although your new colony of bees is likely to be super-gentle (especially during the first few weeks of the season), it defies common sense to put yourself at risk. As the colony grows and matures, you will be working with and among upwards of 60,000 bees.



It's not that the bees are aggressive (they're not), but they are super-curious. They love to explore dark holes (like your ear canal and nostrils). Don't tempt fate — wear a veil.

Veils come in many different models (see Figure 4-19) and price ranges. Some are simple veils that slip over your head; others are integral to a pullover blouse or even a full jumpsuit. Pick the style that appeals most to you. If your colony tends to be more aggressive, more protection is advised. But remember, the more that you wear, the hotter you'll be during summer inspections. (See Chapter 6 for additional information on what to wear.)



Keep an extra veil or two on hand for visitors who want to watch while you inspect your bees.

Figure 4-19: Protective clothing comes in various styles, from minimal to full coverage. This beekeeper uses a veil-and-blouse combination, leather gloves, and high boots to keep him *bee-tight*.



Gloves

New beekeepers like the idea of using gloves (see Figure 4-20), but I urge you not to use them for installing your bees or for routine inspections. You don't really need them at those times, especially with a new colony or early in the season. Gloves only make you clumsier. They inhibit your sense of touch, which can result in your inadvertently injuring bees. That's counterproductive and only makes them more defensive when they see you coming.

The only times that you need to use gloves are

- ✓ Late in the season (when your colony is at its strongest)
- ✓ During honey harvest season (when your bees are protective of their honey)
- ✓ When moving hive bodies (when you have a great deal of heavy work to do in a short period of time)

Other times leave the gloves at home. If you must, you can use heavy gardening gloves, or special beekeeping gloves with long sleeves (available from beekeeping supply vendors).

Figure 4-20: Although not needed for routine inspections, it's a good idea to have a pair of protective gloves.

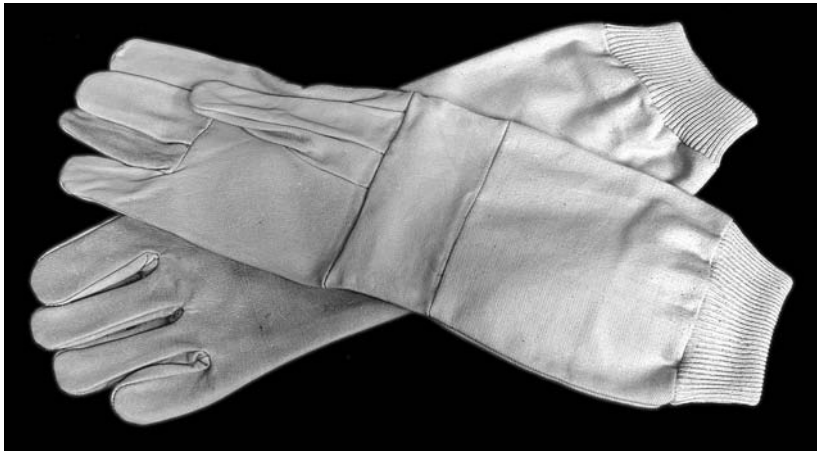

Really Helpful Accessories

All kinds of gadgets, gizmos, and doodads are available to the beekeeper. Some are more useful than others. I describe a few of my favorites in this section.

Elevated hive stand

I have all my hives on elevated stands. Elevated hive stands are something you're more likely to build than purchase. The simplest elevated stands are made from four 14-inch lengths of two-by-four (use these for the legs) and a single plank of plywood that is large enough to hold the hive (see Figure 4-21). Put the entire hive on top of the elevated stand, raising it a little more than 14 inches off the ground. Alternatively, fashion an elevated stand from a few cinderblocks (see Figure 4-22). You can also use posts of various sorts (see Figure 4-23).

In either case, having the hive off the ground means no bending over during inspections. Doing so makes the hive far easier to work with. Elevating the entrance also helps deter skunks from snacking on your bees (see Chapter 11 for more on skunks and other kinds of pests).

Figure 4-21:

You can build a simple table stand to elevate your hive off the damp ground. Note how it is open on the top — this is to accommodate the use of a screened bottom board.

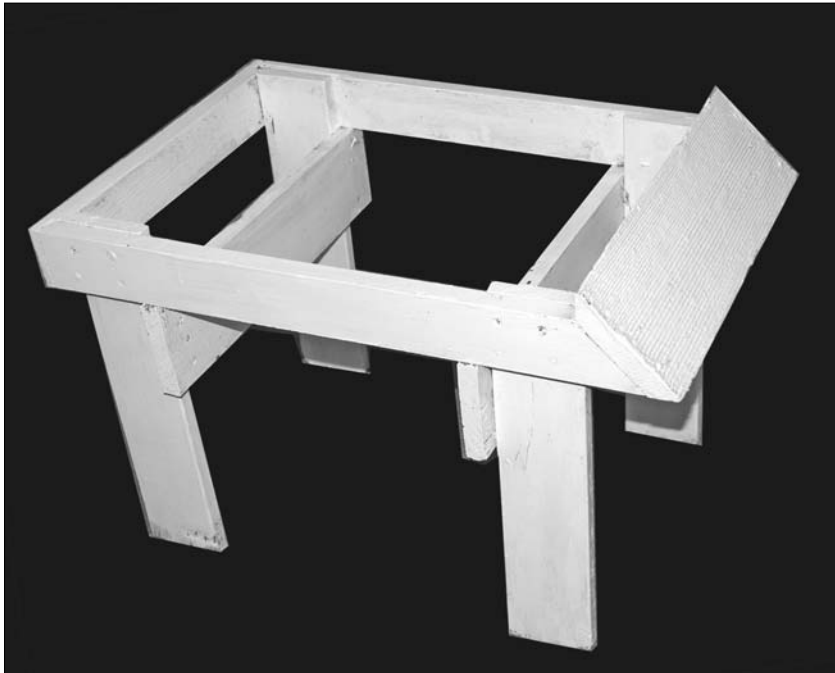

Figure 4-22:
You can also elevate your hive on cinder-blocks.



Figure 4-23:
You can use a level stump to get your hive up off the ground.



Frame rest

A frame rest is a super-helpful device that I love. This product hangs on the side of the hive, providing a convenient and secure place to rest frames during routine inspections (see Figure 4-24). It holds up to three frames, giving you plenty of room in the hive to manipulate other frames without crushing bees.



Figure 4-24:
A frame rest
is a handy
device for
holding
frames
during
inspections.

Bee brush

The long, super-soft bristles of a bee brush enable you to remove bees from frames and clothing without hurting them (see Figure 4-25). Some beekeepers use a goose feather for this purpose. Keep that in mind in the event you have an extra goose around the house.



Figure 4-25:
Use a soft
bee brush
to gently
remove
bees from
frames and
clothing.

Slatted rack

You might want to sandwich a slatted rack between the hive's bottom board and lower deep-hive body (see Figure 4-26). It does an excellent job of helping air circulation throughout the hive. Also, no cold drafts reach the front of the hive, which, in turn, encourages the queen to lay eggs right to the front of the combs. More eggs mean more bees, stronger hives, and more honey for you! I use a slatted rack on all my hives.

Figure 4-26:
Slatted
racks help
improve
ventilation
and can
improve
brood
pattern.



Screened bottom board

The screened bottom board replaces the standard bottom board. As you can see in the picture, its bottom is completely open, except for the #8 hardware cloth screening that makes up its “floor”. The unit also has a removable “sticky board” that you can use to monitor the colony’s varroa mite population. This product has become a standard part of Integrated Pest Management.

With varroa mites a problem for many beekeepers, screened bottom boards are gaining popularity. (See Chapter 11 for more information on varroa mites.) A moderate percentage of mites naturally fall off the bees each day and land on the bottom board of the hive. Ordinarily they just crawl back up and reattach themselves to the bees, but not when you use a screened bottom board in place of a regular bottom board. Mites drop off the bees and either fall to the ground, or they are trapped on a “sticky board” placed *under* the screening. Either way, they are unable to crawl back up into the hive. When using a sticky board, the beekeeper can actually count the number of mites that have fallen off the bees, and thus monitor the mite population. More on this practice in Chapter 12.

There is another great advantage of using a screened bottom board — improved ventilation. Poor ventilation is one of the leading causes of stress on the colony. Using a screened bottom board (sans sticky board) provides the ultimate in ventilation.



I am often asked if you use a slatted rack with a screened bottom board. The answer is no. Use one or the other. Either one will improve ventilation, but only the screened bottom board will help you monitor the mite population.

Other necessities

Some other necessities that all beekeepers should have on hand include:

- ✓ **A spray bottle of alcohol:** Fill a small plastic spray bottle with plain rubbing alcohol. Use this during inspections to clean any sticky honey or pollen off your hands. Never spray the bees with this!
- ✓ **Baby powder:** Dust your hands with baby powder before inspections. The bees seem to like the smell, and it helps keep your hands clean.
- ✓ **Disposable latex gloves:** Available at any pharmacy, I use these during inspections when propolis is plentiful. The gloves don't impede my dexterity, and they keep my hands clean when working among the authoritatively sticky propolis.
- ✓ **Toolbox:** Use a container to hold all your beekeeping tools and hardware. That way everything you need will be available to you during inspections. Any box will do. I use a fishing tackle box (see Figure 4-27).



Figure 4-27:
A simple toolbox is a convenient way to tote supplies to your beeyard.

Chapter 5

Obtaining and Installing Your Bees

In This Chapter

- ▶ Knowing the kind of honey bee you want to raise
 - ▶ Deciding how and where to obtain your bees
 - ▶ Preparing for your bees' arrival
 - ▶ Getting the girls into their new home
-

Ordering your bees and putting them into their new home (hiving) is just about my favorite part of beekeeping. *Hiving* your bees is surprisingly easy — and a lot safer than you might imagine. You don't often get an opportunity to do it, because once your bees are established, you don't need to purchase a new colony. Bees are perennial and remain in their hive generation after generation. Only when you start a new hive or lose a hive to disease or starvation do you need to buy and install a new colony of bees.

I was a nervous wreck in the days and hours prior to installing my first colony. Like an expectant father, I paced the floor nervously until the day they arrived. And when they arrived, I fretted about how in the world I'd get all those bees into the hive. Would they fly away? Would they attack and sting me? Would the queen be okay? Would I do the right things? Help! All my fears and apprehensions turned out to be unfounded. It was as easy as pie, and a thoroughly delightful experience.

Determining the Kind of Bee You Want

You can choose from many different races and hybrids of honey bees. Each strain has its own pluses and minuses. The list below acquaints you with some of the more common types of bees. Most of these types are readily available from bee suppliers. Some suppliers even specialize in particular breeds, so shop around to find what you want.

- ✔ **Italian (*A. m. ligustica*):** These honey bees are yellow-brown in color with distinct dark bands. This race originally hails from the Appenine Peninsula in Italy. They are good comb producers, and the large brood that Italian bees produce results in quick colony growth. They maintain a big winter colony, however, which requires large stores of food. You can help offset this by feeding them before the onset of winter (see Chapter 8).
- ✔ **Carniolan (*A. m. carnica*):** These bees are dark in color with broad gray bands. They originally hail from the mountains of Austria and Yugoslavia. This type exhibits a strong tendency to swarm. Carniolans maintain a small winter colony, which requires only small stores of food.
- ✔ **Caucasian (*A. m. caucasica*):** Caucasian bees are mostly gray in color and are extremely adaptable to harsh weather conditions. They hail from the Caucasian Mountains near the Black Sea. They make extensive use of propolis to chink-up drafty openings, which can make quite a sticky challenge for the beekeeper. Caucasian bees also are prone to robbing honey, which can create a rather chaotic beeyard. They can also fall victim to Nosema disease, so be sure to medicate your Caucasian bees with Fumidil-B every spring and autumn (see Chapter 8).
- ✔ **Buckfast (hybrid):** The Buckfast bee was the creation of Brother Adam, a Benedictine monk at Buckfast Abby in the United Kingdom. Brother Adam earned a well-deserved reputation as one of the most knowledgeable bee breeders in the world. The precise heritage of the Buckfast bee seems to have been known only by Brother Adam — and sadly he died in 1996 at the impressive age of 98. He mixed the British bee with scores of bees from other races, seeking the perfect blend of gentleness, productivity, and disease resistance. The Buckfast bee's resulting characteristics have created quite a fan club of beekeepers from all around the world. The Buckfast bee excels at brood rearing, but exhibits a tendency, however, toward robbing and absconding from the hive (see Chapter 9 for information on how to prevent these bad habits).
- ✔ **Russian:** In the 1990s, efforts to find a honey bee that was resistant to varroa and tracheal mites led USDA researches to Russia, where a strain of honey bee seemed to have developed a resistance to the pesky mites. Indeed the Russian bees seem to be far better at coping with the parasites that have created so much trouble for other strains of bees. These bees have a tendency to curtail brood production when pollen and nectar is in short supply, resulting in a smaller winter colony — a helpful trait that leads to better success when it comes to over-wintering in cold climates. I've had good success with Russian bees. Since 2000 Russians have been available from some bee breeders. They are worth considering.

- ✔ **Starline (hybrid):** This bee was derived as a hybrid strain of Italians and is the only commercially available hybrid race of Italians. It is regarded as productive at pollinating clover, so some people refer to the Starline as the *clover bee*.
- ✔ **Midnight (hybrid):** The double hybrid bee called *Midnight* is trademarked by York Bee Company in Gesup, Georgia. The Midnight bee makes heavy use of propolis, which can make inspecting a colony of Midnight bees a sticky challenge for the beekeeper. This bee is a hybrid combination of both the Caucasian and Carniolan races.
- ✔ **Africanized (hybrid):** This bee is not commercially available, nor desirable to have. I mention it here because its presence has become a reality throughout South America, Mexico, and parts of the southern United States. The list of bee races is not complete without a nod to the so-called *Killer Bee*. This bee's aggressive behavior makes it difficult and even dangerous to manage. (See Chapter 9 for more on this type of bee.)

Generally speaking, the four characteristics that you should consider when picking out the bee strain that you want to raise are gentleness, productivity, disease tolerance, and how well the bees survive winters in cold climates (such as in the northern United States and Canada). Table 5-1 assigns the various types of bees listed above a rating from 1 to 3 in these four categories, with 1 being the most desirable and 3 the least desirable.

Table 5-1 Characteristics of Various Common Honey Bee Types

<i>Bee Type</i>	<i>Gentleness</i>	<i>Productivity</i>	<i>Disease Tolerance</i>	<i>Wintering in Cold Climates</i>
Italian	1	1	2	2
Russian	1	1	1	1
Carniolan	1	2	2	2
Caucasian	1	2	2	1
Buckfast (hybrid)	2	2	1	1
Starline (hybrid)	2	1	2	2
Midnight (hybrid)	2	2	2	1
Africanized	3	1	1	3



After all that's said and done, which kind of bee do I recommend you start with? Try the Italian or Russian. No doubt about it. They are both gentle, productive, and do well in many different climates. These are great bees for beginning beekeepers. Look no further in your first year.

At some point in years to come, you may want to try raising your own various races and hybrids of bees. Much is involved in breeding bees. It's a science that involves a good knowledge of biology, entomology, and genetics. A good way to get your feet wet is to try raising your own queens. It's a way to retain the desirable characteristics of your favorite colonies. For a primer in raising queens, see Chapter 13.

Deciding How to Obtain Your Initial Bee Colony

You'll need some bees if you're going to be a beekeeper. But where do they come from? You have several different options when it comes to obtaining your bees. Some are good; others are not so good. This section describes these options and their benefits or drawbacks.

Ordering package bees

One of your best options and by far the most popular way to start a new hive is to order package bees. It's the choice that I most recommend. You can order bees by the pound from a reputable supplier. In the United States, *bee breeders* are found mostly in the southern states. They will ship just about anywhere in the continental United States.

A package of bees and a single queen are shipped in a small wooden box with two screened sides (see Figure 5-1). Packaged bees are sent via U.S. Mail. A package of bees is about the size of a large shoebox and includes a small screened cage for the queen (about the size of a matchbook) and a tin can of sugar syrup that serves to feed the bees during their journey. A three-pound package of bees contains about 11,000 bees, the ideal size for you to order. Order one package of bees for each hive that you plan to start.



Order a marked queen with the package. *Marked* means that a small colored dot has been painted on her thorax. This dot helps you spot the queen in your hive during inspections. It also confirms that the queen you see is the one that you installed (versus discovering an unmarked one that means your queen is gone and another has taken her place). The color of the dot indicates the year

your queen was purchased (a useful thing to know as it allows you to keep track of the queen's age — you will want to replace her every couple of years to keep brood production optimized).



Be sure to pick a reputable dealer with a good track record for providing healthy and disease-free package bees (criteria for selecting a vendor is discussed in “Picking a Reputable Supplier” later in this chapter). When ordering, be sure to ask to see a copy of a certificate of health from the vendor's state apiary inspector. If the vendor refuses . . . be wary.

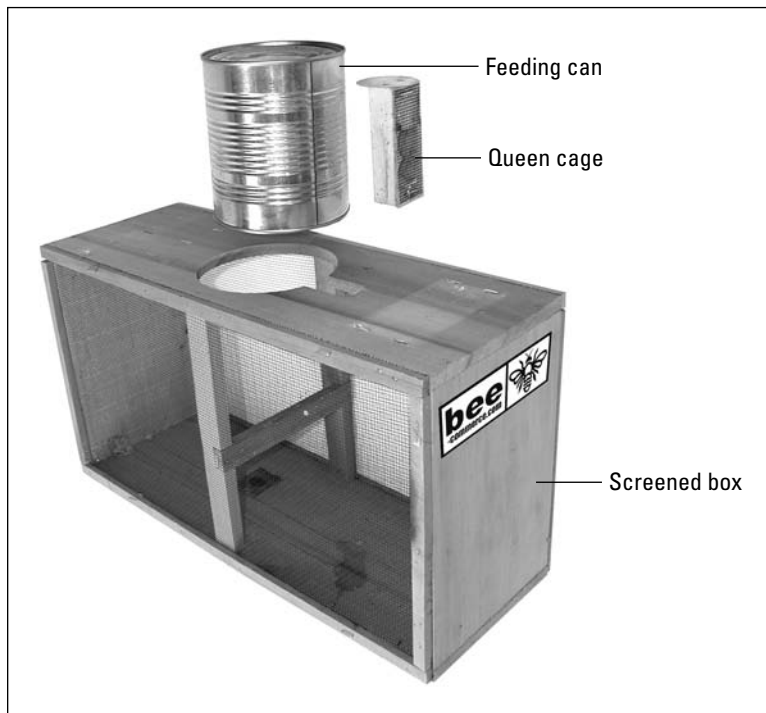

Figure 5-1: Package bees are shipped in screened boxes. Note the feeding can and queen cage.

Buying a “nuc” colony

Another good option for the new beekeeper: Find a local beekeeper who can sell you a *nucleus* (*nuc*) colony of bees. A nuc consists of four to five frames of brood and bees, plus an actively laying queen. All you do is transfer the frames (bees and all) from the nuc box into your own hive. The box usually goes back to the supplier. But finding someone who sells nucs isn't necessarily so easy, because few beekeepers have nucs for sale. After all, raising

volumes of nucs for sale is a whole lot of work with little reward. But if you *can* find a local source, it's far less stressful for the bees (they don't have to go through the mail system). You can also be reasonably sure that the bees will do well in your geographic area. After all, it's already the place they call home! An added plus is that having a local supplier gives you a convenient place to go when you have beekeeping questions (your own neighborhood bee mentor). To find a supplier in your neck of the woods, check your yellow pages under "beekeeping," call your state's bee inspector, or ask members of a local beekeeping club or association.



To find a bee club or association in your state, hop on the internet and go to www.beeulture.com. Click the link "Who's Who in North American Beekeeping" and then select your state. You will find a listing of all the bee clubs and associations in your area.



A *nuc* or *nucleus* consists of a small wooden or cardboard hive (a "nuc box"; see Figure 5-2) with three to five frames of brood and bees, plus a young queen.

Look for a reputable dealer with a good track record for providing healthy bees (free of disease). Ask whether the state bee inspector inspects the establishment annually. Request a copy of a certificate of health from the state. If you can find a reputable beekeeper with nucs, this is a convenient way to start a hive and quickly build up a strong colony.

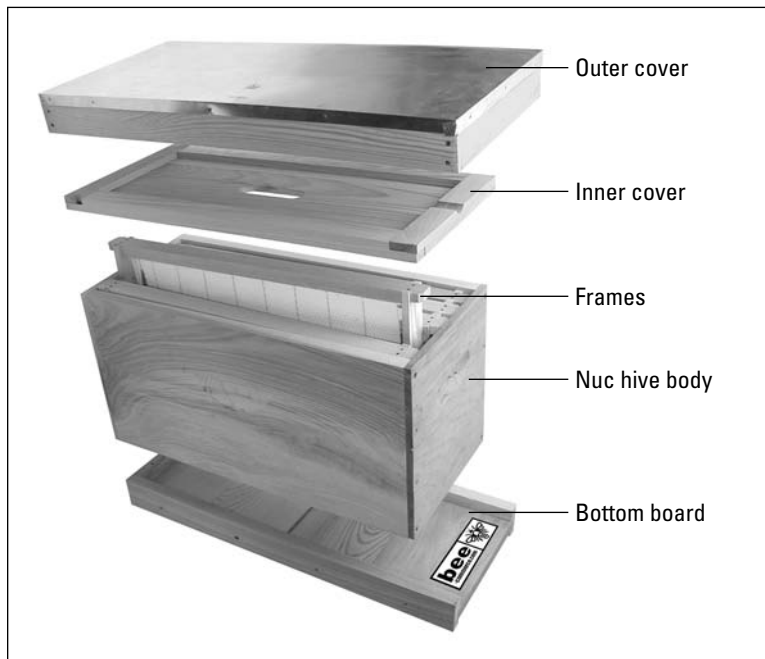

Figure 5-2:
A standard
nuc box.

Purchasing an established colony

You may find a local beekeeper who's willing to sell you a fully established colony of bees — hive, frames, bees, the whole works! This is fine and dandy, but more challenging than I recommend for a new beekeeper. First, you encounter many more bees to deal with than just getting a package or nuc. And the bees are mature and well established in their hive. They tend to be more protective of their hive than a newly established colony (you're more likely to get stung). Their sheer volume makes inspecting the hive a challenge. Furthermore, old equipment may be harder to manipulate (things tend to get glued together with propolis after the first season). More important, you also lose the opportunity to discover some of the subtleties of beekeeping that you can experience only when starting a hive from scratch: the building of new comb, introducing a new queen, and witnessing the development of a new colony.

Wait until you've gained more experience as a beekeeper. If you're determined, however, to select this option, make sure that you have your state's apiary inspector look at the colony before agreeing to buy it. You want to be 100-percent certain the colony is free of disease (for more information about honey bee diseases, see Chapter 12). After all, you wouldn't buy a used car without having a mechanic look at it first.

Capturing a wild swarm of bees

Here's an option where the price is right: Swarms are free. But I don't recommend this for the first-year beekeeper. Capturing a wild swarm is a bit tricky for someone who never has handled bees. And you never can be sure of the health, genetics, and temperament of a wild swarm. In some areas (mostly the southern United States) you face the possibility that the swarm you attempt to capture may be *Africanized* (see Chapter 9). My advice? Save this adventure for year two.



You can find information about capturing a swarm in Chapter 9.

Picking a Reputable Bee Supplier

By checking advertisements in bee journals and surfing the Internet you'll come up with a long list of bee suppliers (see Appendix A for a list of my favorite suppliers along with information on bee-related Web sites, journals, and organizations). But all vendors are not created equal. Here are some rules of thumb for picking a good vendor:

- ✔ **Be sure to pick a well-established vendor who has been breeding and selling bees for many years.** The beekeeping business is full of well-meaning amateurs who get in and out of breeding bees. They lack the experience that results in a responsible breeding program, which can result in problematic stocks of bees and lackluster customer service.
- ✔ **Look for a supplier with a reputation for consistently producing healthy bees and providing dependable shipping and good customer service.** Figure 5-3 shows a picture of a well-run commercial bee-breeding yard.
- ✔ **Ask if the establishment is inspected each year by the state’s apiary inspector.** Request a copy of its health certificate. If owners refuse to comply, look elsewhere.
- ✔ **A reputable supplier replaces a package of bees that dies during shipment.** Ask potential suppliers about their replacement guarantee.
- ✔ **Be suspicious of suppliers who make extravagant claims.** Some walk a fine ethical line when they advertise that their bees are “mite or disease resistant.” No such breed of bee exists. New beekeepers are easy prey for these charlatans. If the claims sound too good to be true, they probably are. Look elsewhere.
- ✔ **Consult with representatives of regional bee associations.** Contact your state’s apiary inspector or other bee association representatives. Find out whom they recommend as suppliers. Get them to share their experiences with you — good and bad.
- ✔ **Join a local bee club to get vendor recommendations from other members.** This also is a great way to find out more about beekeeping and latch onto a mentor. Many clubs have “new beekeeper” programs and workshops.

Deciding how many hives you want

Starting your adventure with *two* hives of bees offers certain advantages. Having two gives you a basis for comparison. It enables you to borrow frames from a stronger colony to supplement a weaker colony. In some ways two hives double the fun. You’ll have more bees to pollinate your garden and more opportunities to witness what goes on within a colony. And, of

course, you’ll double your honey harvest! You can also double the rate of your learning curve. I suggest, however, that you begin with no more than two hives during your first year. More than two can be too much for the beginner to handle. Too many bees can be too time consuming and present too many new problems to digest before you really know the subtleties of beekeeping.



Figure 5-3:
The yard
of a
commercial
bee
breeder.

Courtesy of Bee Culture Magazine

Deciding When to Place Your Order

When you're ordering packaged bees, you want to time your order so that you receive your bees as early in the spring as the weather allows. Doing so gives your colony time to build its numbers for the summer "honey flow" and means your bees are available for early pollination. Suppliers usually start shipping packaged bees early in April and continue through the end of May. Large commercial bee breeders shake bees into screened packages and ship hundreds of packages daily during this season (see Figure 5-4). After that, the weather simply is too hot for shipping packaged bees — they won't survive the trip during the scorching hot days of summer (most bees ship from the southern states). Local bee suppliers have nucs available in a similar time frame.



Don't wait until springtime to order your bees. Bees are in limited supply and available on a *first-ordered, first-shipped* basis. Avoid disappointment. Place your order early. Ordering in November for delivery the following spring is not too early!



Figure 5-4:
A commercial bee breeder shakes bees into packages for shipping to beekeepers.

Courtesy of Bee Culture Magazine

The Day Your Girls Arrive

You may not know the exact day that your bees will arrive, but many suppliers at least let you know the approximate day they plan to *ship* your package bees.



If your package of bees is being mailed to you, about a week before the anticipated date of arrival, alert your local post office that you're expecting bees. Make sure that you provide the post office with your telephone number so you can be reached the moment your bees come in. In most communities the post office asks that you pick up your bees at the post office. Seldom are bees delivered right to your door. Instruct the post office that the package needs to be kept in a cool, dark place until you arrive.



In all likelihood, you'll receive your "bees-have-arrived" call in the predawn hours — the instant they arrive at your local post office. Postal workers will, no doubt, be eager to get rid of that buzzing package! Please note, however, that this wake-up call is *not* the signal for you to start assembling your equipment. Plan ahead! Make sure everything is ready for your girls before they arrive.

Bringing home your bees

When the bees finally arrive, follow these steps in the order they are given:

1. Inspect the package closely.

Make sure that your bees are alive. You may find some dead bees on the bottom of the package, but that is to be expected. If you find an inch or more of dead bees on the bottom of the package, however, fill out a form at the post office and call your vendor. He or she should replace your bees.

2. Take your bees home right away (but don't put them in the hot, stuffy trunk of your car).

They'll be hot, tired, and thirsty from traveling.

3. When you get home, spray the package liberally with cool water using a clean mister or spray bottle.

4. Place the package of bees in a cool place, such as your basement or garage, for an hour.

5. After the hour has passed, spray the package of bees with nonmedicated sugar syrup (see recipe that follows).

Don't *brush* syrup on the screen, because doing so literally brushes off many little bee feet in the process.



You must have a means for feeding your bees once they're in the hive. I strongly recommend using a good quality hive-top feeder. Alternatively you can use a feeding pail or a baggie feeder (see Chapter 4 for additional information on different kinds of feeders).

Recipe for sugar syrup

You'll likely need to feed your bees sugar syrup twice a year (in spring and in autumn).

The early spring feeding stimulates activity in the hive and gets your colony up and running fast. It also may save lives if the bees' stores of honey have dropped dangerously low.

The colony will store the autumn sugar syrup feeding for use during the cold winter months (assuming your winter has cold months).

In either case, feeding syrup is also a convenient way to administer some important medications. More on that later.

If you purchased your bees from a reputable bee breeder, you won't need to medicate your bees during your first season. But you *may* want to feed them medicated syrup twice a year (spring and autumn) in your second and subsequent seasons.

- ✓ **Nonmedicated syrup:** Boil 2½ quarts of water on the stove. When it comes to a rolling boil, turn off the heat and add 5 pounds of white granulated sugar. Be sure you turn off the stove. If you continue boiling the sugar, it may caramelize, and that makes the bees sick. Stir until the sugar completely dissolves. The syrup must cool to room temperature before you can feed it to your bees.
- ✓ **Medicated syrup:** For medicated syrup, prepare the nonmedicated syrup recipe as above. Let it cool to room temperature. Mix 1 teaspoon of Fumigilin-B in approximately a half a cup of cool water (the medication won't dissolve directly in the syrup). Fumigilin-B protects your bees against nosema — a common bee illness (see Chapter 12 for more information on nosema and other diseases). Add the medication to the syrup and stir. You also can add two tablespoons of Honey B Healthy. This food supplement contains essential oils and has a number of beneficial qualities (see Chapter 12).



Deciding whether or not to medicate is a topic covered in Chapter 11.

Putting Your Bees into the Hive

The fun stuff comes next. Sure, you'll be nervous. But that's only because you're about to do something you've never done before. Take your time and enjoy the experience. You'll find that the bees are docile and cooperative. Read the instructions several times until you become familiar and comfortable with the steps. Do a dry run before your girls arrive. The illustrations in the following section provide a helpful visual clue — after all, a picture is worth a thousand words.



When I hived my first package of bees, I had my wife standing by with the instructions, reading them to me one step at a time. What teamwork!

Ideally, hive your bees in the late afternoon on the day that you pick them up, or the next afternoon. Pick a clear, mild day with little or no wind. If it's raining and cold, wait a day. If you absolutely must, you can wait several days to put them in the hive, but make certain that you spray them two or three times a day with sugar syrup while they're waiting to be introduced to their new home. Don't wait more than 5 to 6 days to hive them. The sooner the better. Chances are they've been cooped up in that box for several days before arriving in your yard.



Whenever I hive a package of bees, I always invite friends and neighbors to witness the adventure. They provide great moral support, and it gives them a chance to see first-hand how gentle the bees actually are. Ask someone to bring a camera. You'll love having the photos for your scrapbook!

To hive your bees, follow these steps in the order they are given:

- 1. Thirty minutes before hiving, spray your bees rather heavily with nonmedicated sugar syrup.**

But don't drown them with syrup. Use common sense, and they'll be fine.



- 2. Using your hive tool, pry the wood cover off the package.**

Pull the nails or staples out of the cover, and keep the wood cover handy.



- 3. Jar the package down sharply on its bottom so that your bees fall to the bottom of the package.**

It doesn't hurt them! Remove the can of syrup from the package and the queen cage, and loosely replace the wood cover (without the staples).



4. Examine the queen cage. See the queen?

She's in there with a few attendants. Is she okay? In rare cases, she may have died in transit. If that's the case, go ahead with the installation as if everything were okay. But call your supplier to order a replacement queen (there should be no charge). Your colony will be fine while you wait for your replacement queen.

5. Slide the metal disc on the queen cage to the side slowly.

Remove the cork at one end of the cage so that you can see the white candy in the hole. If the candy is present, remove the disc completely. If the candy is missing, you can plug the hole with a small piece of marshmallow. If your package comes with a strip of *Apistan* (designed to control mites during shipment), remove it from the back of the queen cage.

6. Out of two small frame nails bent at right angles, fashion a hanging bracket for the queen cage.

7. Spray your bees again, and jar the package down so the bees drop to the bottom.

8. Prepare the hive by removing five of the frames, but keep them nearby.

Remember that at this point in time you're using only the lower deep hive body for your bees. Now hang the queen cage (candy side up) between the center-most frame and the next frame facing toward the center. The screen side of the cage needs to face toward the center of the hive.



Some packages of bees come with instructions to hang the queen cage with the candy side down. Don't do it. If one or more of the attendant bees in the cage dies, they will fall to the bottom and block the queen's escape. By having the candy side "up", no workers will block the escape hole.



9. Spray your bees liberally with syrup one last time.

Jar the package down. Toss away the wood cover and then pour (and shake) approximately half of the bees directly above the hanging queen cage. Pour (and shake) the remaining bees into the open area created by the missing five frames.



10. When the bees disperse a bit, gently replace four of the five frames.

Do this gingerly so you don't crush any bees. If the pile of bees is too deep, use your hand (with gloves on) to gently disperse the bees.

11. Place the inner cover on the hive.

If you're using a hive-top feeder, it is placed in direct contact with the bees without the inner cover in between, so skip this step and go to step 12. The inner cover is used only when a jar or pail is used for feeding. The outer cover is placed on top of the hive-top feeder.

12. Place the hive-top feeder on top of the hive.

Alternatively, invert a one-gallon feeding pail above the oval hole in the inner cover; add a second deep super on top of the inner cover; and fill the cavity around the jar with crumpled newspaper for insulation.

13. Plug the inner cover's half-moon ventilation notch with a clump of grass (some inner covers do not have this notch).

You want to close off this entrance until the bees become established in their new home.

14. Now place the outer cover on top of the hive. You're almost done.**15. Insert your entrance reducer, leaving a one-finger opening for the bees to defend.**

Leave the opening in this manner until the bees build up their numbers and can defend a larger hive entrance against intruders. This takes about four weeks. If an entrance reducer isn't used, use grass to close up all but an inch or two of the entrance.



Place the entrance reducer so that the openings face "up." Doing so allows the bees to climb up over any dead bees that might otherwise clog the small entrance (see the sidebar "Knowing when and how to use the entrance reducer").

You're done! Take a breath, and leave everything alone for a week. No peeking! The bees may kill the queen if they're disturbed before five days have elapsed after her introduction.



Use this first week to get to know your bees. Take a chair out to the hive and sit to the side of the entrance — about two to three feet from the hive (within reading distance). Watch the bees as they fly in and out of the hive. Some of the workers will return to the hive with pollen on their hind legs. Other bees will be fanning at the entrance ventilating the hive or releasing a sweet pheromone into the air. This scent is unique to this hive and helps guide their foraging sisters back to their home. Can you spot the guard bees at the entrance? They're the ones alertly checking each bee as she returns to the hive. Do you see any drones? They are the male bees of the colony and are slightly larger and more barrel-shaped than the female worker bees. The loud, deep sound of their buzzing often distinguishes them from their sisters.

Congratulations! You're now officially a beekeeper. You've launched a wonderful new hobby that can give you a lifetime of enjoyment.

Knowing when and how to use the entrance reducer

The entrance reducer is used for two primary reasons:

- ✔ To regulate the hive's temperature
- ✔ To restrict the opening so that a new or weak colony can better defend the colony

That being the case, here are some guidelines:

- ✔ For a newly hived colony, leave the entrance reducer in place (utilizing its smallest opening) until approximately six weeks after you hived your package of bees. Chances are you can then position the entrance reducer so that its next largest opening is utilized. After about eight weeks, you can remove

the entrance reducer completely. By that time the colony should be strong enough to defend itself — and the weather should be warm enough to fully open the entrance.

- ✔ For an established colony, use the entrance reducer during long periods of cold weather (less than 40° F; 4° C). It helps prevent heat from escaping from the hive. I prefer not to use the smallest opening, as I find it too restrictive — bees that die from attrition can clog the small opening. As a general “rule of thumb,” remove the entrance reducer completely when daytime temperatures are above 60° F; 15° C.

Part III

Time for a Peek

The 5th Wave

By Rich Tennant

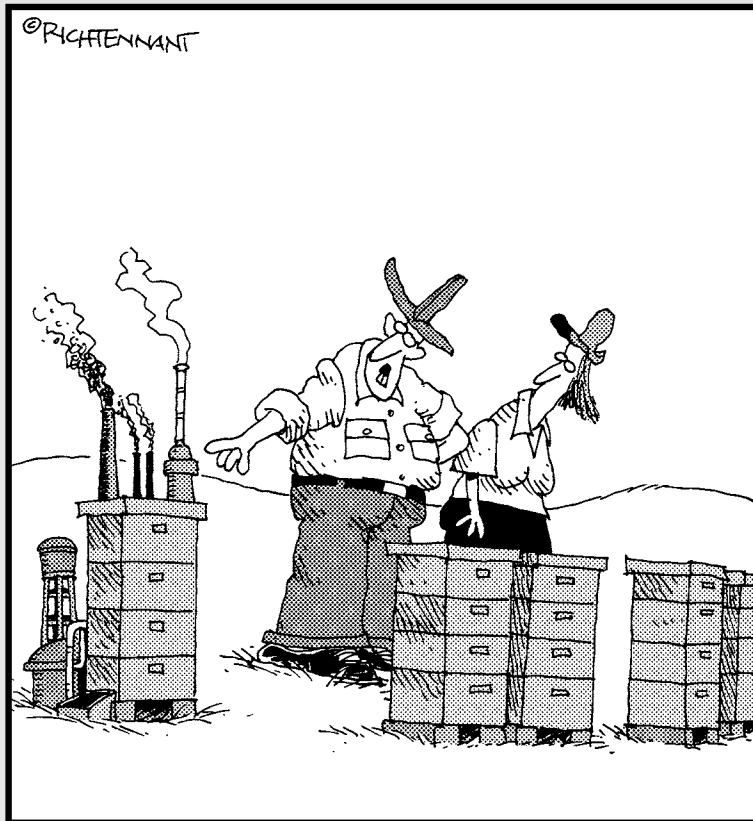

"My bee hives are all honey producers, except for that one. It produces industrial resins and polymers. Don't ask me why."

In this part . . .

This is where you get up-close and personal with your honeybees. You will read about the best and safest ways to inspect and enjoy your bees, as well as maintain your colony year-round. I also share useful tips and techniques that help you develop good habits right from the start.

Chapter 6

Opening Your Hive

In This Chapter

- ▶ Knowing when and how often to visit your bees
 - ▶ Finding out how to light your smoker
 - ▶ Deciding what to wear
 - ▶ Approaching the hive
 - ▶ Opening the hive
-

This is the moment you, as a new beekeeper, have been waiting for — that exhilarating experience when you take your first peek into the hive. You likely have a touch of fear, tempered by a sweeping wave of curiosity.

Put those fears aside. You'll soon discover visiting with your bees is an intoxicating experience that you eagerly look forward to. What you're about to see is simply fascinating. It's also one of the more tranquil and calming experiences that you can imagine: The warmth of the sun; the sweet smell of pollen, wax, and honey; the soothing hum of the hive. You're at one with nature. Your new friendship with your bees will reward you for many years to come.



The habits you develop in the beginning are likely to stick with you. So developing good habits early on is important. By getting familiar with the safe and proper way to inspect your hive and following suggested steps religiously in the beginning, you'll minimize any risks of injuring or antagonizing your bees. The techniques become second nature in no time. Down the road, you may find variations on the suggested methods that suit you better. Or helpful hints from other experienced beekeepers. That's okay. For now, just relax, move calmly, use good judgment, and enjoy the miracle of beekeeping.

Establishing Visiting Hours

Ideally, open your hive on a nice sunny day. Between 10 a.m. and 5 p.m. is best. Under those conditions, thousands of busy worker bees are out in the

field. Avoid cold, windy, or rainy weather, because that's when the entire colony is at home. With everyone in the hive, you'll probably find too many bees to deal with. Particularly when you are just starting. In addition, the bees tend to be crankier when they can't get out of the house! You know how that is.

Setting an Inspection Schedule



For the new beekeeper, once a week isn't too often to visit the bees. Use these frequent opportunities to find out more about the bees and their life cycles. Your first season is a time of discovery. You'll begin recognizing what's normal and what's not. You'll also become increasingly comfortable with manipulating the frames and working with the bees. So much so that it soon becomes second nature, and a quick peek at the entrance or under the lid is all that's needed to assure you that all is well. Beekeeping is as much an art as it is a science. Practice makes perfect.

Once you begin getting the hang of it, you needn't conduct more than six to eight thorough inspections a year: Three or four visits in the early spring, one or two during the summer, and a couple of inspections at the end of the season are all that are necessary. It's better not to disturb your bees too often.



Every day that you smoke the bees, open their hive, and pull it apart sets their productivity back a bit. It takes a day or two for life in the colony to return to normal. So if harvesting lots of honey is your objective, limit your inspections to once every few weeks.

This schedule doesn't apply to your first year — when you need to gain greater experience by visiting the hive often.

Preparing to Visit Your Hive

The weekend has rolled around, and the weather's great (mild, sunny, and not much wind), so you've decided that you're going to pay the girls a visit. It's time to see what's going on in the hive. But you can't just dash out and tear the top off the hive. You have to get yourself ready for this special occasion. What will you wear? How will you approach them? What in the world do you do with all this new equipment?

In the upcoming section, I'll take you through the details of each step. You may want to read this chapter and the next one word for word. You may even want to read it a few times before having your first "close encounter." You may also want to take the book along on your first inspection, just in case you need some quick moral support. Better yet, coerce a friend or family member to go with you. That's what I did the first time. I had my wife reading from a book and prompting me through each step of the way. At the time we didn't have an extra veil for her, so she hollered instructions at me from a safe distance.

Making "non-scents" a part of personal hygiene

Forgive me for being personal. But you need to know that bees don't react well to bad body odor. So, please don't inspect your bees when you're all sweated up after a morning jog. Take a shower first. Brush your teeth. On the other hand, don't try to smell too good, either!



Avoid using colognes, perfumes, or scented hairsprays. Sweet smells can attract more attention from the bees than you want.



Be sure to remove your leather watchband before visiting your bees. They don't like the smell of leather or wool, and these materials retain body odor. Removing any rings from your fingers also is a good idea. It isn't that bees don't like pretty jewelry. But in the rare event that you take a sting on your hand, you don't want your fingers swelling up when you're wearing a decidedly nonexpandable ring.

Getting dressed up and ready to go

Always wear your veil when you're inspecting your hive. Doing so keeps the bees away from your face and prevents them from getting tangled in your hair. For a discussion of the types of veils that are available, see Chapter 4.



If a bee ever gets under your veil, try not to panic. It isn't that big a deal. She's unlikely to sting you unless you squeeze her. Simply walk away from the hive and slip off your veil. Don't remove your veil at the hive, and don't thrash around screaming and yelling. Doing so only upsets the bees, and the neighbors will think you've gone wacky.

New beekeepers need to wear a long-sleeved shirt. Light colors and smooth fabrics (like cotton) are best, because bees don't like dark colors, or the smell of wool or leather (material made from animals). Using elastic, Velcro straps, or rubber bands around the cuff of each pant leg and sleeve keeps clothing bee-tight, unless, of course, you think you might actually like having curious bees traveling up inside your trousers.

You can use gloves if you feel you absolutely must (see Chapter 4 for more information about gloves). But I encourage you not to develop that habit. Gloves are bulky. They impair your sense of touch and make your movements clumsy. When you're working with new colonies and early spring colonies, gloves aren't even necessary. These small, young, and gentle colonies are a delight to work with. Save your gloves for unfavorable weather, moving colonies around, or for use during the late summer and honey-harvesting time (when the colony's population is large and bees tend to be more defensive). But at all other times, I recommend that you leave the gloves at home. Trust me. You will thank me later.



Colonies can be handled with far more dexterity and fewer injuries to bees (and you!) when you don't use gloves at all. Less injury to bees means a more docile colony.

Lighting your smoker

The smoker is the beekeeper's best friend. Yet for many, keeping a smoker lit can be the trickiest part of beekeeping. It doesn't have to be. What you're trying to achieve is enough thick, cool smoke to last throughout your inspection. You certainly don't want your smoker to pop out as soon as you've opened the hive.

Begin with a loosely crumpled piece of newspaper about the size of a tennis ball. Light the paper and place it in the bottom of the smoker. Nest it in place using your hive tool. Gently squeeze the bellows a few times until you're sure that the paper is burning with a flame.

Add dry matchstick-size kindling, pumping the bellows as you do. As it ignites (you'll hear it crackling), slowly add increasingly thicker kindling. Ultimately, the fattest of your twigs will be about as thick as your thumb. None of the kindling need be more than four or five inches in length. The kindling needs to fill three quarters of the smoker, and must be thoroughly packed from side to side. Using your hive tool, occasionally stoke the fire. Keep pumping. When your kindling has been burning for about 10 minutes, and embers are glowing, it's time to add the real fuel.

Use a fuel that burns slowly and gives off lots of smoke. I am partial to dry wood chips or hemp baling twine. But burlap, dry leaves, and even dry pine needles do nicely. You can also purchase *smoker fuel* (usually cartridges of compacted raw cotton fibers, or nuggets of wood) from beekeeping supply stores. It works well, too. The bees really don't care what you use — but avoid using anything synthetic or potentially toxic. Figure 6-1 shows a smoker and various kinds of starters and fuels.



I have recently discovered that the compressed wood pellets used as fuel in pellet stoves make great smoker fuel. Start with crumpled newspaper and a few twigs, then add a fistful or two of the wood pellets. Your smoker will produce thick white smoke for hours!

Keep a box of kindling and fuel with your other beekeeping equipment. Having this readily available saves time on the days that you plan to visit the hive.

Pack the smoker right to the top with your preferred fuel, as you continue to gently pump the bellows. When billows of thick, cool, and white smoke emerge, close the top. Pump the bellows a few more times. Use a long, slow pumping method when working the bellows, rather than short, quick puffs. Doing so produces more and thicker smoke than short puffs (see Figure 6-2).



Figure 6-1:

A smoker with all the “ingredients” is ready to load with paper, kindling of various sizes, and some hemp twine.

Keeping your smoker clean

A good question that I'm frequently asked is: "My smoker is all gummed up and needs a good cleaning. How do I clean it?"

After a season or two, the inside of a smoker can become thickly coated with black, gummy tar. I've found the best way to clean it is by burning the tar out of it — literally. Like a self-cleaning oven, you need a great amount of heat.

I've had success using a small propane blowtorch. You can purchase one at any hardware store. Just apply the flame to the black tar coating the inside of your smoker. Keep blasting away. Soon the tar ignites, glows a fiery orange, and then turns to a powdery ash. Turn off the blowtorch. Once the metal smoker cools, you can easily knock the ash out of the smoker. Clean as a whistle!

Congratulations! You're now ready to approach the hive. Your smoker should remain lit for many hours.



Make certain the smoke coming out of the smoker is "cool". You don't want to approach the hive with a smoker that is producing a blast furnace of smoke, fire, and sparks. Place your hand in front of the chimney as you gently work the bellows and feel the temperature of the smoke. If it feels comfortable to you, it will to the bees, too.

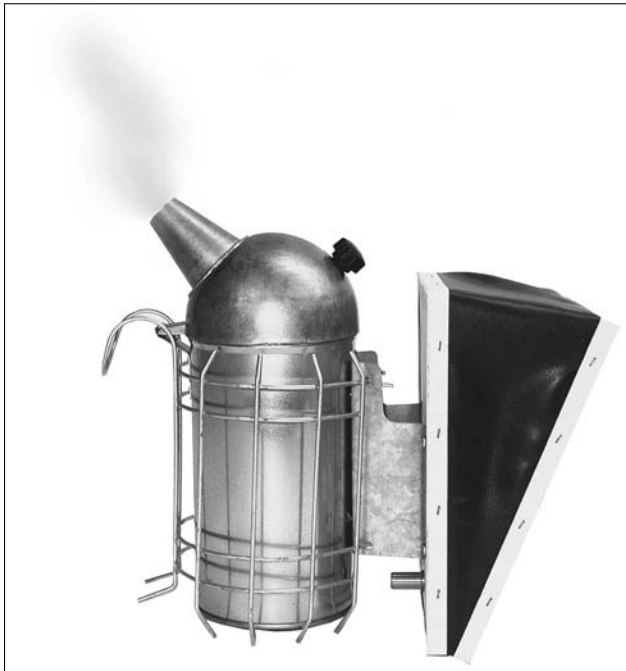

Figure 6-2:
A smoking
smoker.

Opening the Hive

You're all suited up and you have your smoker and hive tool. Perfect! Be sure to bring along an old towel (I'll explain why later in the "Removing the hive-top feeder" section). So now the moment of truth has arrived. Approach your hive from the side or rear. Avoid walking right in front of it, because the bees shooting out the entrance will collide with you. As you approach the hive, take a moment to observe the bees and then ask yourself, "In what direction are they leaving the hive?" Usually it's straight ahead, but, if they're darting to the left or right, approach the hive from the opposite side. Follow these steps to open the hive:

- 1. Standing at the side and with your smoker 2 or 3 feet from the entrance, blow several puffs of thick, cool smoke into the hive's entrance (see Figure 6-3).**

Four good puffs of smoke should do fine. Use good judgment. Don't oversmoke them. You're not trying to asphyxiate the bees; you simply want to let the guard bees know you're there.



Figure 6-3: Approach the hive from the side and blow a few puffs of smoke into the entrance to calm the guard bees.

What does the smoke do?

Smoke calms bees and prevents them from turning aggressive during inspections. You may ask, “Why?” One explanation I was told years ago is that it tricks bees into thinking there’s a fire. In nature bees make their homes in hollow trees. So a forest fire would be a devastating event. Smelling the smoke, the bees fan furiously to keep the hive cool. They also begin collecting their most precious commodity — honey, engorging their *honey stomachs* with it in the event they must abandon ship and move to a new and safer home. With all the commotion, they become quite oblivious to the beekeeper. And when the inspection is complete and the crisis passes, the bees return the honey to the comb. That way, nothing is lost.

But it’s another explanation that I think is more likely. The smoke masks the alarm pheromones given off by worker bees when the hive is opened. Ordinarily, these alarm pheromones trigger defensive action on the part of the colony. But the smoke confounds the bees’ ability to communicate danger.

In any event, smoking the bees really works. Don’t even think about opening a hive without first smoking it. It’s a tempting shortcut that may work when your colony is brand new, small, and young. But after that, it’s a shortcut you’ll try only once.

2. Still standing at the side of the hive? Good. Now lift one long edge of the outer cover an inch or so, and blow a few puffs of smoke into the hive (see Figure 6-4).

Ease the top back down and wait 30 seconds or so. Doing so gives the smoke time to work its way down into the hive. These puffs are for the benefit of any guard bees at the top of the hive.

3. Put your smoker down and, using both hands, slowly remove the outer cover.

Lift it straight up and off the hive. Set the cover upside down on the ground (with the flat metal top resting on the ground, and its underside facing skyward).

Your next step depends on whether you’re still feeding your bees at the time of the inspection. If no hive-top feeder is on the colony, skip ahead to the section “Removing the inner cover.”

Figure 6-4:
A little
smoke
under the
hive cover
calms any of
the colony's
guard bees
that may be
upstairs.



Removing the hive-top feeder

If you're using a hive-top feeder, you'll need to remove it before inspecting your hive. To do so, follow these steps:

- 1. With your smoker, puff some smoke through the screened access, and down into the hive (see Figure 6-5).**
- 2. Hive parts often stick together, so use the flat end of your hive tool to gently pry the feeder from the hive body (see Figure 6-6).**

Do this slowly, being careful not to pop the parts apart with a loud “snap.” That only alarms the bees.

Figure 6-5:

If you're using a hive-top feeder, apply some smoke through the screened access to reach the bees down below.



Figure 6-6:

Use your hive tool as a lever to ease apart hive parts.





Here's a useful trick. Use one hand to gently press down on the feeder, while prying the feeder loose with the hive tool in your other hand. This *counterbalance* of effort minimizes the possibility of the two parts suddenly popping apart with a loud “snap.”

3. **Loosen one side of the feeder and then walk around and loosen the other side.**
4. **Blow a few puffs of smoke into the crack created by your hive tool as you pry loose the feeder.**
5. **Wait 30 seconds and completely remove the hive-top feeder.**

Be careful not to spill any syrup. Set the feeder down on the outer cover that now is on the ground.



Positioning the feeder at right angles to the cover when you set it down, results in only two points of contact and makes it less likely that you'll crush any bees that remain on the underside of the feeder. Always be gentle with them, and they'll always be gentle with you!



Remember the old towel I talked about earlier in this chapter? This is where it comes in. If syrup remains in the feeder, completely cover it with the towel (alternatively you can use a small plank of plywood or a scrap of carpeting). Syrup left in the open attracts the bees — big time! You don't want to set off *robbing*. That's a nasty situation where bees go into a wild frenzy after finding free sweets (see Chapter 9). Open containers of syrup (or honey for that matter) also can attract bees from other colonies. All the gorging bees wind up whipped into such a lather that they begin robbing honey from your hive. War breaks out, and hundreds or even thousands of bees can be killed by the robbing tribe. Enough said! A good rule of thumb: *Never* leave syrup in the wide open. Keep it out of reach!

Removing the inner cover

If you're *not* using a hive-top feeder, you'll need to remove the inner cover (an inner cover is always used *unless* a top feeder is on the hive). Removing the inner cover is much like removing the top feeder. Follow these steps:

1. **Puff smoke through the oval hole and down into the hive.**
2. **Using the flat end of your hive tool, gently release the inner cover from the hive body (see Figure 6-7).**
Loosen one side and then walk around and loosen the other side. Pry slowly, being careful not to pop the parts apart with a loud “crack.”
3. **Blow a few puffs of smoke into the crack created by your hive tool as you pry up the inner cover.**



Figure 6-7: Direct some smoke through the hole in the inner cover — wait half a minute and then remove it.

4. Wait 30 seconds and then completely remove the inner cover.

Set it down on the outer cover that's now on the ground, or simply lean it up against a corner of your hive. Careful! Don't crush any bees that may still be on the inner cover.

The Hive's Open! Now What?

Whew! With the feeder or inner cover removed, the hive is officially open. Relax and take a deep breath. You should see lots of beautiful bees! Here's what to do next:

1. Time for the smoker again.

From 1 or 2 feet away, and standing at the rear of the hive, blow several puffs of cool smoke between the frames and down into the hives. Pumping the bellows in long, slow puffs, rather than short, quick ones, make sure that the breeze isn't preventing smoke from going into the

spaces between the frames. Watch the bees. Many of them will retreat down into the hive.

2. Now you can begin your inspection (see Chapter 7).



Although you have much to do, you don't want to keep the hive open for more than 10 to 15 minutes (even less if the weather is cooler than 55° F). But don't rush at the expense of being careful! Clumsiness results in injury to bees, and that can lead to stings. Be gentle with the ladies!

In Chapter 7, I'll explain exactly what you should look for when the hive's wide open.

Chapter 7

What to Expect when You're Inspecting

In This Chapter

- ▶ Getting familiar with basic inspection techniques
 - ▶ Removing the first frame
 - ▶ Understanding what you're looking for
 - ▶ Inspecting the hive during the first eight weeks
-

Peering out through your veil with your cuffs strapped shut and your smoker lit, you've opened your hive and now see that it's bustling with bees. But what exactly are you looking for?

Understanding when to look and what to look for makes the difference between being a “beekeeper” and a “*beehaver*.” Anyone can have a hive of bees, but your goal as a beekeeper is to help these little creatures along. Understand their needs. Try to anticipate problems. Give them the room they need before they actually need it. Give them comb in which to store honey before the nectar starts to flow. Medicate and feed them when a medical emergency strikes. Get them ready for winter before the weather turns cold. In return, your bees will reward you with many years of enjoyment and copious crops of sweet golden honey.

Exploring Basic Inspection Techniques

The approach for inspecting your hive doesn't vary much from one visit to another. You always follow certain procedures, and you always look for certain things. After a few visits to the hive, the mechanics of all this

become second nature, and you can concentrate on enjoying the miraculous discoveries that await you. In this section I give you some pointers that make each inspection easy.

Removing the first frame

Always begin your inspection of the hive by removing the *first frame* or *wall frame*. That's the frame closest to the outer wall. Which wall? It doesn't matter. Pick a side of the hive to work from, and that determines your first frame. Here's how to proceed:

1. Insert the curved end of your hive tool between the first and second frames, near one end of the frame's top bar (see Figure 7-1).

2. Twist the tool to separate the frames from each other.

Your hand moves toward the center of the hive — not the end.

3. Repeat this motion at the opposite end of the top bar.

The first frame should now be separated from the second frame.

4. Using both hands, pick up the first frame by the end bars (see Figure 7-2).

Gently push any bees out of the way as you get a hold of the end bars. With the frame in both hands *slowly* lift it straight up and out of the hive. Be careful not to roll or crush bees as you lift the frame. Easy does it!



You should never put your fingers on a frame without first noting where the bees are, because you don't want to crush any bees, and you don't want to get stung. Bees can be easily and safely coaxed away by gently pushing them aside with your fingers.

Now that you've removed the first frame, gently rest it on the ground, leaning it vertically up against the hive. It's okay if bees are on it. They'll be fine. Or, if you have a frame rest (a handy accessory available at some beekeeping supply stores) use it to temporarily store the frame.

This is a basic and important first step every time you inspect a colony. The removal of this frame gives you a wide-open empty space in the hive for better manipulating the remaining frames without squashing any bees. Always be sure to remove the wall frame from the hive before attempting to remove any other frames.

Figure 7-1:
Use your
hive tool
to pry the
wall frame
loose before
removing it.

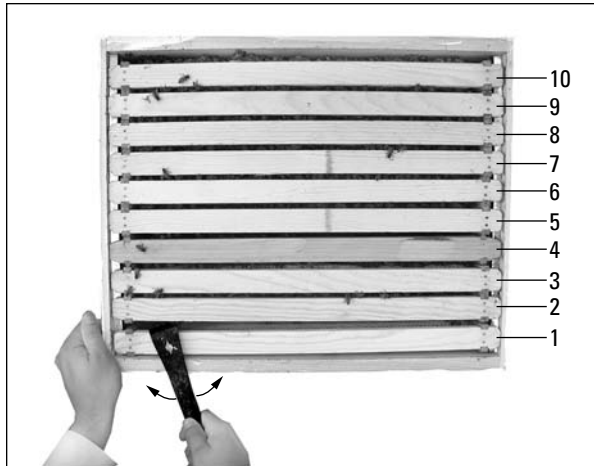

Figure 7-2:
Carefully
lift out the
first frame
and set it
aside. Now
you have
room to
manipulate
the other
frames.



Working your way through the hive

Using your hive tool, loosen frame two and move it into the open slot where frame one used to be. That gives you enough room to remove *this* frame without the risk of injuring any bees. When you're done looking at this frame, return it to the hive, close to (but not touching) the wall. Do *not* put this frame on the ground.

Work your way through all ten frames in this manner — moving the next frame to be inspected into the open slot. When you're done looking at a frame, always return it snugly against the frame previously inspected. Use your eyes to monitor progress as the frames are slowly nudged together.



Be careful not to crush any bees when pushing the frames together. One of those bees may be the queen! Look down between the frames to make sure the coast is clear before slowly pushing the frames together. If bees are on the end bars and at risk of being crushed, you can use the flat end of your hive tool to gently coax them to move along. A single puff of smoke also urges them to move out of the way.

Holding up frames for inspection

Holding and inspecting an individual frame the proper way is crucial. Be sure to stand with your back to the sun, with the light shining over your shoulder and onto the frame (Figure 7-3). The sun illuminates details deep in the cells and helps you to better see eggs and small larvae. Here's an easy way to inspect both sides of the frame (Figure 7-4 illustrates the following steps):

1. Hold the frame firmly by the tabs at either end of the top bar.

Get a good grip. The last thing you want to do is drop a frame covered with bees. Their retaliation for your clumsiness will be swift and, no doubt, memorable.

2. Turn the frame vertically.

3. Then turn the frame like a page of a book.

4. Now smoothly return it to the horizontal position, and you'll be viewing the opposite side of the frame.

Figure 7-3:
Hold frames
firmly with
the light
source
coming over
your shoul-
der and onto
the frame.

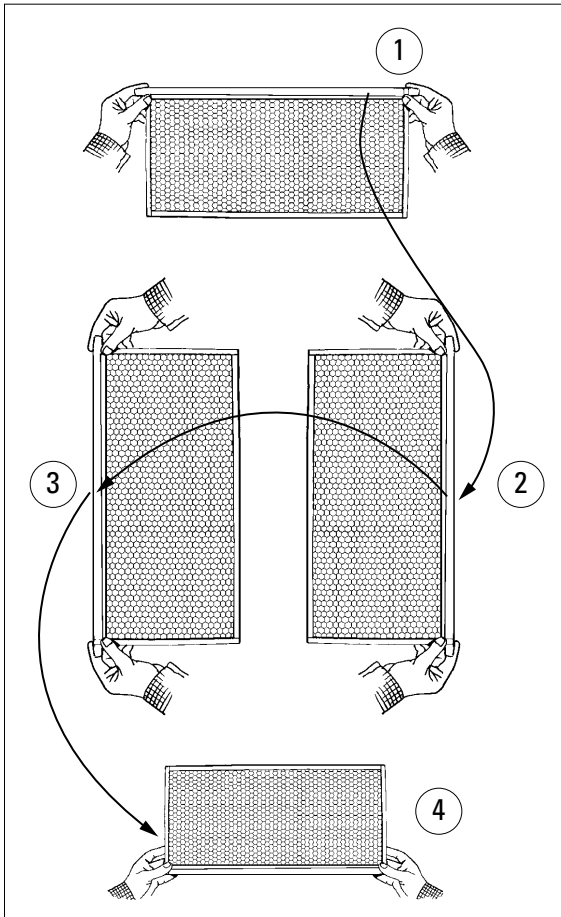

Figure 7-4:
The
correct way
to inspect
both sides
of a frame.



When inspecting frames, all your movements must be slow and deliberate. Change hand positions sparingly. Sliding your fingers across the frames as you reposition your hands is better than lifting your fingers and setting them down again, because you may land on a bee. As you turn the frame, you want to avoid any sudden and unnecessary centrifugal force that can disturb the bees.

Knowing when it's time for more smoke

A few minutes into your inspection, you may notice that the bees all have lined up between the top bars like racehorses at the starting gate. Their little heads are all in a row between the frames. Kind of cute, aren't they? They're watching you. That's your signal to give the girls a few more puffs of smoke to disperse them again so that you can continue with your inspection.

Understanding what to always look for

Each time that you visit your hive, be aware of the things that you always must look for. Virtually all inspections are to determine the health and productivity of the colony. The specifics of what you're looking for vary somewhat, depending upon the time of year. But some universal rules-of-the-road apply to every hive visit.

Checking for your queen

Every time that you visit your hive you're looking for indications that the queen is alive and well and laying eggs. If you actually see her, that's great and reassuring! But finding the queen becomes increasingly difficult as the colony becomes larger and more crowded. So how can you tell whether she's there?

Rather than spending all that time trying to see the queen, look for *eggs*. Although they're tiny, finding the eggs is much easier than locating a single queen in a hive of 60,000 bees. Look for eggs on a bright, sunny day. Hold the comb at a slight angle and with the sun shining over your shoulder. This illuminates the deep recesses of the cells. The eggs are translucent white, resembling a miniscule grain of rice (see Figures 2-9 and 2-10 in Chapter 2).



An inexpensive pair of reading glasses can help you spot the eggs — even if you don't normally need them. When you see eggs, you can be sure a queen is in the hive — or at least that she was there within the last two days.

Binocular magnifiers (used by hobbyists and watch makers (see Chapter 2) are better than reading glasses. These magnifiers can be worn under your veil and tipped out of the way when you are not using them. They make egg spotting easy, and give you a whole new perspective on the tiny wonders in the colony. Alternatively, you can make use of a conventional magnifying glass.

Storing food; raising brood

Each deep frame of comb contains about 7,000 cells (3,500 on each side). Honeybees use these cells for storing food and raising brood. When you inspect your colony, noting what's going on in those cells is important because it helps you judge the performance and health of your bees. Ask yourself: Is there ample pollen and nectar? Are there lots of eggs and brood? Does the condition of the wax cappings over the brood look *normal* — or are the cappings perforated and sunken in (see Chapter 9 for tips on recognizing unhealthy situations)?

Inspecting the brood pattern

Examining brood pattern is an important part of your inspections. A tight, compact brood pattern is indicative of a good, healthy queen (see this book's color insert). Conversely, a spotty brood pattern (many empty cells with only occasional cells of eggs, larvae, or capped brood) is an indication that you have an old or sick queen and may need to replace her. How does the capped brood look? These are cells that the bees have capped with a tan wax. The tan cappings are porous and enable the developing larvae within to breathe. The cappings should be smooth and slightly convex. Sunken-in (concave) or perforated cappings indicate a problem. See Chapter 10 for more information about how to recognize the telltale signs of brood disease.



Capped brood refers to larvae cells that have been capped with a wax cover, enabling the larvae to spin cocoons within and turn into pupae.

Recognizing foodstuffs

Learn to identify the different materials collected by your bees and stored in the cells. They'll pack pollen in some of the cells. Pollen comes in many different colors: orange, yellow, brown, gray, blue, and so on. You'll also see cells with something "wet" in them. It may be nectar. Or it may be water. Bees use large amounts of water to cool the hive during hot weather. Other cells contain capped and cured honey. These cappings usually are bright white and airtight (versus the tan, porous cappings covering brood cells).

Replacing frames

After you've inspected your last frame, nine frames should be in the hive and one leaning against it or hanging on the frame rest (the first frame you removed). Putting the first frame back in the hive means:

- 1. Slowly pushing the nine frames that are in the hive as a single unit toward the opposite wall of the hive.**

That puts them back where they were when you started your inspection. Pushing them as a single unit keeps them snugly together and avoids crushing bees. Focus your eyes on the "point of contact" as you push the frames together. You're now left with the open slot from which the first frame was removed.

- 2. Smoking the bees one last time to drive them down into the hive.**
- 3. Picking up the frame that's outside the hive.**

Are bees still on it? If so, with a downward thrust, sharply knock one corner of the frame on the bottom board at the hive's entrance. The bees fall off the frame and begin walking into the entrance to the hive. With no bees remaining on your first frame, you can easily return it to the hive without the risk of crushing them.

- 4. Easing the wall frame into the empty slot.**

Slowly, please! Make certain that all ten frames fit snugly together. Using your hive tool as a wedge, adjust the ten-frame unit so that the space between the frames and the two outer walls is equal.

Closing the hive

You're almost finished. Follow these steps to close the hive:

- 1. If you're using a hive-top feeder, put it back in place immediately on top of the hive body.**

Add more sugar syrup if the pantry is getting low. Now go to Step 4.

- 2. If you're not using a hive-top feeder, replacing the inner cover comes next.**

First remove any bees from the inner cover. Use a downward thrust and sharply knock one corner of the inner cover on the bottom board at the hive's entrance. Better yet, if there is a rock on the ground, use it as your hard surface rather than the bottom board (it's less disturbing to the bees in the hive).

3. Place the inner cover back on the hive by sliding it in position from the rear of the hive so that you don't crush any bees.

Very slowly slide it into place, and any bees along the top bars or on the edges of the hive will be pushed gently out of the way. Kind of like a bulldozer!

Note that the notched ventilation hole is positioned upward and toward the front of the hive. This notched opening allows air to circulate and gives bees a top floor entrance to the hive. Some manufacturers of bee equipment do not have this ventilation opening — I suggest getting one that does have this nice feature.

4. Replace the outer cover (the final step).

Make sure the outer cover is free of any bees. Tap it sharply on the ground to free it of bees. From the rear of the hive, slide it along the inner cover, again, gently pushing any bees out of the way (the bulldozer technique). Ease it into place, and adjust it so that it sits firmly and level on the inner cover.



Make sure that the ventilation notch on the outer cover isn't blocked. From the rear of the hive, shove the outer cover toward the front of the hive. Doing so opens the notched ventilation hole in the inner cover and gives the bees airflow and an alternate entrance.

Congratulations! The bees once again are snugly in their home.

Your New Colony's First Eight Weeks

For the newly hived colony, some specific beekeeping tasks are unique to the first few weeks of your first season. When you do any inspection, the general method for smoking, opening, and removing the frames is identical to the method given in the “Exploring Basic Inspection Techniques” section earlier in this chapter.

Checking in: A week after hiving your bees

After putting your package of bees in the hive, you'll be impatient to look inside to see what's happening. Resist the temptation! You must wait one full week before opening the hive. The colony needs this first uninterrupted week for accepting its new queen. Any premature disturbance to the hive can

result in the colony rejecting her. The colony may even kill her, thinking the disturbance is somehow her fault. Play it safe and leave the hive alone for one week. During that time, worker bees eat through the candy and release the queen from her cage. She becomes the accepted leader of the colony.



As mentioned in Chapter 6, conduct your first inspection on a mild, sunny day (55° F or more) with little or no wind. As always, visit your hive sometime between 10 a.m. and 5 p.m.

Smoke and open your hive, and remove the first frame. Place it vertically on the ground, leaning it up against the hive. Other than a few occasional bees, not much will be happening on this frame. In all likelihood, the bees haven't had time to draw the foundation into honeycomb.

As you continue your inspection of each subsequent frame, you should begin to see more and more going on. Toward the center of the hive you should see that the girls have been busily drawing out the wax foundation into honeycomb.

Verifying that the queen was released

When you reach the two frames sandwiching the queen cage, look down in the hole where the candy plug was. If the candy is gone, that's wonderful! It means worker bees have opened the cage and released the queen. Remove the cage and peek inside. Confirm that the queen has been released. Place the cage near the entrance so that any worker bees that you find exploring in the cage find their way back into the hive.

Removing any burr comb

You're likely to find that industrious bees have built lots of *burr comb* (sometimes called *natural comb*, *wild comb*, or *brace comb*) in the gap created by the queen cage. You may find comb on and around the queen cage itself. Although it's beautiful bit of engineering, you must remove this bright white comb of perfectly symmetrical cells. Failing to do so is sure to create all kinds of headaches for you later in the season.



In all likelihood this wild comb will contain eggs (it's the first place the queen lays eggs). Spotting those eggs will confirm you have a laying queen in the hive.



Burr comb refers to bits of random wax comb that connect two frames together or connect any hive parts together. Such comb is an extension of comb beyond what the bees build within the frames. Burr comb needs to be removed by the beekeeper to facilitate manipulation and inspection of frames.

Using your hive tool to sever the burr comb where it's connected to the frames, slowly lift the comb straight up and out of the hive. You'll probably find it covered with worker bees.

Examine the comb to ensure the queen isn't on it. If she is, you must gently remove her from the comb and place her back into the hive. Queens are quite easy to handle, and although they have a stinger, they're not inclined to use it. Simply wet your thumb and index finger and gently grasp her by her wings. She moves quickly, so it may take a few tries. Don't jab at her, but rather treat her as if she were made of eggshells. Easy does it!

Removing the bees from this burr comb is essential. One or two good shakes dislodge the bees from the comb. Shaking bees loose is a technique that will come in handy many times in the future.



Shaking is a sharp downward motion with an abrupt halt just above the hive.

Save the natural comb to study at your leisure back at home. Look for eggs, because the queen often starts laying on this comb. It makes a great "show and tell" for children! And you can always use beeswax to make cool things, like candles, furniture polish, and cosmetics recipes.

Looking for eggs

Taking a close look at the frames that were near the queen cage, what do you see? Pollen? Nectar? Great! Do you see any eggs? They're the primary things you're looking for during your first inspection (see "Exploring Basic Inspection Techniques" earlier in this chapter). When eggs are present, you know the queen already is at work. That's all you need to find out on this first inspection. Close things up, and leave the bees alone for another week. Be satisfied that all is well. Because the weather likely is still cool, you don't want to expose the new colony to the elements for too long.



If no queen or eggs can be found, you may have a problem. In this abnormal situation, wait another few days and check once again. Seeing eggs is evidence enough that you have a queen, but if you still find no evidence of the queen, you need to order a new one from your bee supplier. The colony will do okay while awaiting its new queen, which you'll introduce exactly as you did the original: by hanging the cage between two frames and leaving the bees alone for a full week.



New beekeepers often have a really hard time finding eggs. Before you give up hope as to whether there are any, look again. If you still don't see them, look again. And use a magnifier. Chances are they are there, and you just have not gained experience as to what you are looking at. Remember, they are very, very small.

Replacing the tenth frame

The tenth frame is the one that you removed when you originally hived your package. It now becomes your *wall frame*.

Providing more syrup

When necessary, replenish your hive-top feeder with more sugar syrup. The recipe for sugar syrup can be found in Chapter 5.

The second and third weeks

On that first visit, you were looking for evidence that the queen had been released and was laying eggs. During the inspections that you conduct two and three weeks after hiving your package, you're trying to determine how well the queen is performing. By now there are a lot of new things to see and admire.

Following standard procedure, smoke, open the hive, and remove frames one by one for inspection. Work your way toward the center of the hive. As always, look for eggs. They're your ongoing assurance that the queen is in residence.

Note that the bees have drawn more of the foundation into honeycomb. They work from the center outward, so that the outer five to six frames haven't likely been drawn out yet. That's normal.

Looking for larvae

By the second week you can easily see larvae in various stages of development (see Figure 7-5). They should be bright white and glistening like snowy white shrimp! Looking closely, you may even witness a larva moving in its cell or spot a worker bee feeding one.

Evaluating your queen

Estimate how many eggs her majesty is laying. One good way to tell is if you have one or two frames with both sides $\frac{3}{4}$ -filled with eggs and larvae. That means your queen is doing a super fantastic job. Congratulations!

If you have one or two frames with only one side filled, she's doing moderately well. If you find fewer than that, she's doing poorly, and you need to consider replacing her as soon as possible. See Chapter 9 for instructions on how to replace your queen.

Hunting for capped brood

By the third week you'll begin seeing capped brood — the final stage of the bees' metamorphosis. *Capped brood* are light tan in color, but note that the brood cappings on older comb are a darker tan or even dark brown. The capped brood are located on frames that are closest to the center of the hive. Cells with eggs and larvae are on the adjacent frames.



An excellent queen lays eggs in nearly every cell, skipping few cells along the way and resulting in a pattern of eggs, larvae, and capped brood that is tightly packed together, stretching all the way across most of the frame.

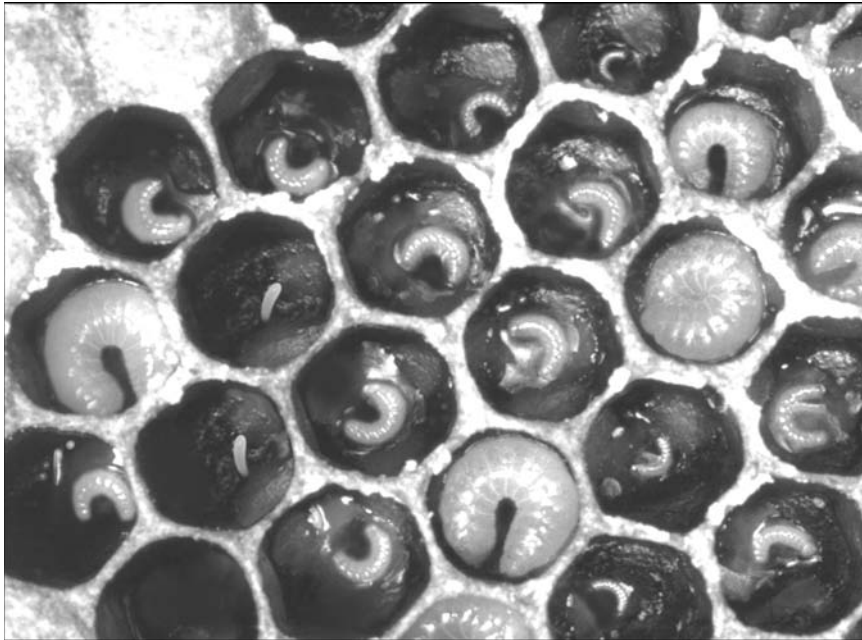

Figure 7-5:
Larvae go through various stages of development. Also, note eggs in this photo.

Courtesy of Dr. Edward Ross, California Academy of Sciences

You'll also notice a crescent of pollen above each capped brood, and a crescent of nectar or capped honey above the pollen. This is a picture-perfect situation.



A spotty and loose brood pattern also can be evidence of a problem. You may have a poor queen, in which case she should be replaced as soon as possible. Sunken or perforated brood cappings may be evidence of brood disease, in which case you must diagnose the cause and take steps to medicate. (See Chapter 10 for more about bee diseases and remedies.)

Looking for supersedure cells

The third week also is when you need to start looking for *supersedure* cells (also called queen cells). The bees create supersedure cells if they believe their queen is not performing up-to-par. These peanut-shaped appendages are an indication that the colony may be planning to replace (or supersede) the queen. Queen cells located on the upper two-thirds of the frame are supersedure cells (see Figure 7-6). On the other hand, queen cells located on the lower third of the frame are not supersedure cells but are called swarm cells, which are discussed later in this chapter. **Note:** Swarming seldom is a problem with a new hive this early in the season.



The bees create *swarm cells* to raise a new queen in preparation for the act of *swarming*. This usually happens when conditions in the hive become too crowded. The colony decides to split in half — with half the population leaving the hive (swarming) with the old queen and the remaining half staying behind with the makings for a new queen (the ones that are developing in the queen cells, or swarm cells).



If you spot more than three to four supersedure cells, you need to order a new queen, because giving the bees a new queen is far better than letting them create their own. Furthermore, you'll lose less time and guarantee a desirable lineage.



Supersedure is a natural occurrence when a colony replaces an old or ailing queen with a new queen.

Figure 7-6:
Supersedure cells are located in the upper two-thirds of the frame; swarm cells are located along the bottom third.

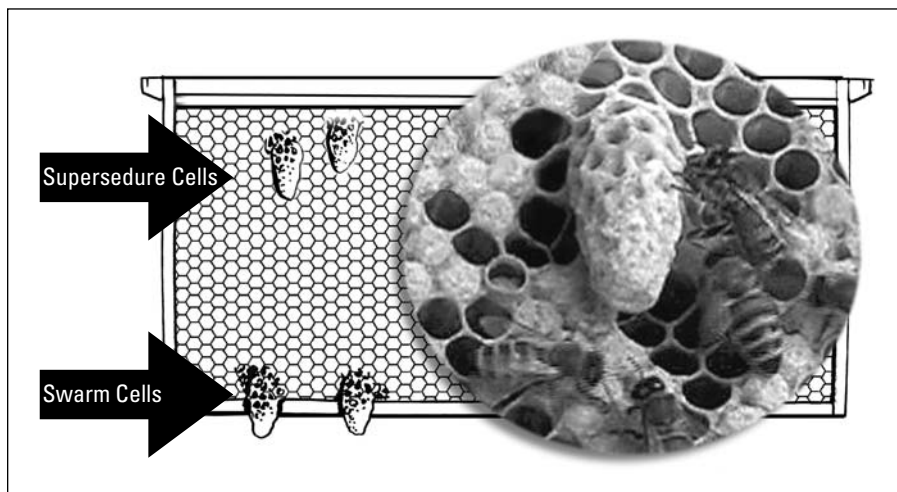

Provide more syrup

Check every week to see whether your hive-top feeder has enough sugar syrup. Replenish as needed. The recipe for sugar syrup is in Chapter 5. Just pour it into the feeder.

Weeks four through eight

Things really are buzzing now that a month has passed since you hived your bees. Or at least they should be.

Perform your inspection as always, looking for evidence of the queen (eggs) and a good pattern of capped brood, pollen, and capped honey.

Adding a second deep hive body

If all's well, by the end of the fourth week the bees have drawn nearly all the foundation into comb. They've added wax produced in their wax glands to the foundation, creating the comb cells in which they store pollen, honey, and brood. When seven of the ten frames are drawn into the comb, you want to add your second deep hive body (see Chapter 4 for more information). Anticipate the need for this addition because timing is important. If you wait too long, the colony may grow too fast (with up to 2,000 new bees emerging every day!), become overcrowded, and eventually swarm. Add the second deep hive body too early and the colony below loses heat, and the brood may become chilled and die.

When adding the second deep hive body becomes necessary, follow these steps:

- 1. Smoke your hive as usual.**
- 2. Remove the outer cover and the hive-top feeder (or the inner cover, if one is being used).**
- 3. Place the second deep directly on top of the original hive body.**
- 4. Fill the new second story with ten frames and foundation (see Chapter 4).**
- 5. Put the hive-top feeder directly on top of the new upper deep, and below the outer cover.**

Replenish sugar syrup if needed.

- 6. Replace the outer cover.**

The upper deep will be used during the early summer for raising brood. But later on it serves as the food chamber for storing honey and pollen for the upcoming winter season.

Witnessing a miracle!

By the fifth week the frames are jam-packed with eggs, larvae, capped brood, pollen, and honey. Look carefully at the capped brood. You may see a miracle in the making. Watch for movement under the capping. A new bee is about to emerge! She'll chew her way out of the cell and crawl out (see Figure 7-7). At first, she totters about, looking like a newborn, yet she quickly learns how to use her legs. She appears lighter in color than her sisters and is covered with soft, damp hairs. Her eyes are tiny at first, but in a few days will be the same size as her sisters. What a joy this is to witness. Savor the moment!



Figure 7-7:
This young
adult bee
is just
emerging
from her
cell.

Watching for swarm cells

During weeks six through eight, continue looking for queen cells, but you also want to be on the lookout for cells in the lower third of the frames. They are swarm cells (as mentioned previously in this chapter), which are an early indication that the hive may consider swarming. During your first season, don't be too concerned if you spot an occasional swarm cell. It isn't likely that a new colony will swarm. However, when you find eight or more of these swarm cells, you can be fairly certain the colony intends to swarm.



You don't want a swarm to happen. When a colony swarms, half the population leaves with the old queen looking for a new and more spacious home. Before that happens, the bees take steps — evidenced by the presence of

swarm cells — to create a new queen. But with half of the girls gone, and several weeks lost while the new virgin queen gets up to speed, you're left with far fewer bees gathering honey for you. Your harvest will be only a fraction of what it might otherwise have been. Prevent this unhappy situation before it happens by anticipating the bees' need for more space and adequate ventilation. (See Chapter 9 for more about swarming.)

Providing more ventilation

During weeks five or six, you need to improve hive ventilation by opening the hive entrance. Turn the entrance reducer so that the larger of its two openings is in position. The larger opening is about 4 inches wide. (Eventually, the reducer is completely removed.) The colony is now robust enough to protect itself, and the weather is milder.

You can remove the entrance reducer completely in the eighth week following the installation of your bees.

Manipulating the frames of foundation

By the seventh or eighth week, manipulate the order of frames to encourage the bees to draw out more foundation into comb cells. You can do this by placing any frames of foundation that haven't been drawn between frames of newly drawn comb. However, don't place these frames smack in the middle of the brood nest. That would be counterproductive because doing so splits (or breaks) the nest apart, making it difficult for bees to regulate the environment of the temperature-sensitive brood.

Making room for honey!

As the eighth week approaches, you may find that the bees may have drawn out seven of the ten frames in the upper deep. When that happens, remove the hive-top feeder and add a queen excluder and a shallow honey super with frames and foundation (see Chapter 4 for more information on woodenware). The girls now are ready to start collecting honey for you!



The act of adding shallow (honey) supers to a colony is called *supering*.

Inspecting your multi-level hive

Now that there are two hive bodies (later there will also be honey supers) you have more than just one "box" to inspect. You will need to inspect the entire colony: both the lower deep and the upper deep. The process is the same as any inspection, except you will first need to systematically remove all the honey supers and the upper deep to get down to the lower deep. That's where you will begin your frame-by-frame inspection.

Once all the frames in the lower deep are inspected, replace the upper deep and begin your frame-by-frame inspection of it. As always, you are checking for evidence of the queen, a good laying pattern, and healthy brood.

As the season progresses, the upper deep will be used by the bees to store honey, so you won't find the queen, any eggs or brood in the upper deep. The lower deep is where the action is as summer progresses. That will be the focus of your inspection. (See Figure 7-8.)



Shaking bees off frames is a technique you will use often.

Figure 7-8:
Use the outer cover (placed bottom-side up on the ground) as a surface on which to place supers and hive bodies as you disassemble the hive for inspection.



Courtesy of John Clayton

What to do about propolis during inspections

Here's a question I'm often asked: "My bees have built comb on and around some of the frames. There's comb along the bottom bars, and they've glued some of the frames together with propolis. Should I scrape this wax and propolis off, or should I leave things as the bees intended?"

With every inspection you should take a moment to scrape extra wax and propolis off the frames.

Don't let it build up, or the job will become too daunting to do anything about it. Take a few minutes during every inspection to tidy things up. Getting into the habit of cleaning house will save you tons of work later on. If you allow the bees to glue everything together, it's tempting to forgo a necessary inspection to avoid the challenge of pulling things apart. Don't let the bees get the upper hand. Scrape it off!

Chapter 8

Different Seasons, Different Activities

In This Chapter

- ▶ Beekeeping chores for summer, autumn, winter, and spring
 - ▶ Starting your second season
-

The seasonal calendar of events in Maine obviously looks different than one in southern California. But different climates mean different schedules and activities for the hive and beekeeper. Regardless of their precise location, honey bees are impacted by the general change of seasons. Knowing what major activities are taking place within the hive and what's expected of you during these seasons is useful. For a good beekeeper, *anticipation* is the key to success.

This chapter contains a suggested schedule of seasonal activities for the beekeeper. However, you must note that geography, weather, climate, neighborhood, and even the type of bees influence the timing of these activities. The book is written from the viewpoint of a beekeeper experiencing a distinct change in seasons and climate (spring, summer, autumn, winter).



There is a beekeeper's calendar and map at the end of this chapter. Use this as a guide to relate the timing of these activities to where in the world you live.

I also suggest some important tasks for the beekeeper and provide a rough estimate of the amount of time that you'll need to spend with your bees during each season. These time estimates are based on maintaining one to three hives.

Lazy, Hazy, Crazy Days of Summer

Nectar flow usually reaches its peak during summer. That's also when the population of the colony usually reaches its peak. When that's the case, your

colonies are quite self sufficient, boiling with worker bees tirelessly collecting pollen, gathering nectar, and making honey. Note, however, that the queen's rate of egg laying drops a bit during the late summer.



On hot and humid nights, you may see a huge curtain of bees hanging on the exterior of the hive. Don't worry. They're simply cooling off on the front porch. Consider providing better ventilation for the colony by adding ventilation holes.

Late in summer the colony's growth begins to diminish. Drones still are around, but outside activity begins slowing down when the nectar flow slows. Bees seem to be restless and become protective of their honey.

Your summer "to-do" list

Here are some activities you can expect to schedule between trips to the beach and hot-dog picnics.

- ✓ Inspecting the hive every other week, making sure that it's healthy and that the queen is present.
- ✓ Adding honey supers as needed. Keep your fingers crossed in anticipation of a great honey harvest.
- ✓ Keeping up swarm control through mid-summer (see Chapters 7 and 9). Late in the summer there is little chance of swarming.
- ✓ Being on the lookout for honey-robbing wasps or other bees. A hive under full attack is a nasty situation (see Chapter 9 for information about how to deal with robbing).
- ✓ Harvesting your honey crop at the end of the nectar flow (see Chapters 12 and 13). Remember that in zones experiencing cold winters, the colony requires at least 60 pounds of honey for use during winter. This is the time to break out your gloves, because your normally docile bees are at their most defensive. They don't want to give up their honey without a bit of a fight!

Your summer time commitment

You can't do all that much until the end of the summer and the honey harvest, because your bees are doing it all! Figure on spending about eight to ten hours with your bees during the summer months. Most of this time involves harvesting and bottling honey (see Chapters 12 and 13 for more information on honey harvesting).

Winter syrup recipe

I use special syrup for feeding bees that are going into the winter months. The thicker consistency recipe makes it easier for bees to convert the syrup into the capped honey they'll store for the winter.

Boil 2½ quarts of water on the stove. When it comes to a rolling boil, turn off the heat and add 10 pounds of white granulated sugar. Be sure that you turn off the stove. If you continue boiling the sugar, it may caramelize, and that makes the bees sick. Stir until the sugar dissolves completely. The syrup must cool to room temperature before you can add medication. Note that this is a recipe for thicker syrup than that used

for feeding bees in the spring. For medicated syrup, mix 1 teaspoon of Fumigilin-B in approximately a half cup of cool water (the medication won't dissolve in the syrup). Fumigilin-B protects your bees against Nosema — a common bee illness (see Chapter 10 for more information on Nosema and other diseases). Add the medication to the syrup and stir. You also can add two tablespoons of Honey B Healthy. This food supplement contains essential oils and has a number of beneficial qualities that keep your bees healthy. Only the first 2 gallons you feed your bees need to be medicated. Subsequent batches do not need to be medicated.

Falling Leaves Point to Autumn Chores

Most nectar and pollen sources become scarce as days become shorter and weather cools in autumn. All in all, as the season slows down, so do the activities within your hive: The queen's egg laying is dramatically reduced, drones begin to disappear from the hive, and hive population drops significantly.

Your bees begin bringing in propolis, using it to chink up cracks in the hive that may leak the winter's cold wind. The colony is hunkering down for the winter, so you must help your bees get ready.



Watch out for robbing during this time (other bees would love to steal honey from your hives). For more about robbing and how to prevent it, see Chapter 9.

Your autumn "to-do" list

When helping your bees prepare for the upcoming hardships of winter months, you must

- ✓ Inspect your bees (look inside the hive) and make certain that the queen is there. As mentioned in Chapter 7, the easiest way is finding eggs. One egg per cell means the queen is present.



Be sure to look for eggs, *not* larvae. Finding eggs means that the queen was present two days ago. Larvae, on the other hand, can be three to eight days old. Thus, merely finding larvae is no guarantee that you have a queen.

When you wait too late during autumn, you discover that eggs and larvae are few and far between. In that case, actually finding the queen is the surest way to check. Be patient, and look carefully.

- ✓ Determine whether the bees have enough honey. Your bees need plenty of food (capped honey) for the winter. Make certain that the upper deep hive body is full of honey. Honey is essential for your bees' survival, because it's the fuel that stokes their stoves. Without it they're certain to perish.



In cooler, northern climates, hives need about 60 pounds or more of honey as they head into winter. You'll need less honey reserves (30 to 40 pounds) if your winters are short (or nonexistent).

- ✓ Feed and medicate your colony. They'll accept a 2-to-1 sugar-syrup feeding (see the "Winter syrup recipe" sidebar) until colder weather contracts them into a tight cluster. At that point, temperatures are too cold for them to leave the cluster (see the "Clustering in a Winter Wonderland" section later in this chapter), so feeding them is useless.
- ✓ Consider treating your colony with either Terramycin® or Tylan® (both are antibiotics) as a prophylactic precaution against AMB and EFD disease (see Chapter 11).

Keep feeding your bees until they stop taking the syrup, or until the temperature drops, and they form the winter cluster. A hive-top feeder works best. The first two gallons should be medicated with Fumigilin-B — subsequent feedings are not medicated.

- ✓ Provide adequate ventilation. During winter, the temperature at the center of the cluster is maintained at 90 to 93 degrees F. Without adequate ventilation, the warm air from the cluster rises, hits the cold inner cover, and condensation drips down onto the bees as ice-cold water. That's a big problem! The bees will become chilled and die. Keep your colony dry by doing the following:

- Gluing (permanently) four postage stamp-sized pieces of wood (you can use the thin end of a wood shingle or pieces of a Popsicle stick) to the four corners of the inner cover's flat underside. This neat ventilation trick makes an air space of $\frac{1}{16}$ inch or less between the top edge of the upper deep hive body and the inner cover.
- Placing the inner cover on the top deep body, *flat side down*. The oval hole should be left open, and the notch in the ledge of the inner cover (if present on your model of inner cover) should be left open for ventilation.



When you put the outer cover on the hive, make sure that you push it forward so the notch in the ledge of the inner cover

remains open. Make sure that the outer cover is put on the hive equidistant from side to side. The result is a gentle flow of air that carries off moisture from the underside of the inner cover and thus keeps the colony dry.

- ✔ Wrap the hive in black tar paper (the kind used by roofers, see Figure 8-1) if you're in a climate where the winter gets below freezing for more than several weeks. Make sure that you don't cover the entrance or any upper ventilation holes. The black tar paper absorbs heat from the winter sun, and helps the colony better regulate temperatures during cold spells. It also acts as a windbreak.



I put a double thickness of tar paper over the top of the hive. Placing a rock on top ensures that cold winds don't lift the tar paper off. I also cut a hole in the wrapping to accommodate the ventilation hole I drilled in the upper deep hive body (see Figure 8-1).

- ✔ Provide a windbreak if your winter weather is harsh. It is hoped that you originally were able to locate your hives with a natural windbreak of shrubbery (see Chapter 3). But if not, you can erect a temporary windbreak of fence posts and burlap. Position it to block prevailing winter winds.
- ✔ Add a mouse guard to the front entrance of the hive (see Chapter 12 for more information on mouse guards).

Figure 8-1: Wrapping your hive in tar paper helps protect your colony from harsh winter winds and absorb the warmth of the sun. The rock on top keeps the paper from blowing off. The metal mouse guard keeps unwanted visitors outside the hive.



Making your winter ventilation preparations a breeze

Here's an easy ventilation trick from a commercial beekeeper who has successfully overwintered thousands of hives in upper New York State. During your late autumn preparation, simply slide the upper deep back so that you create a $\frac{1}{8}$ -inch opening along the entire front of the lower hive body (see figure below). Don't make it a larger gap, or the bees will use it as an

entrance or you might create a robbing situation. "Wait a minute!" you might say. "Doesn't the rain get in that little gap?" Yes it does. But that's no problem because you've already tilted your hive slightly forward (see Chapter 3). Any rain or snow that dribbles in simply drains right out the front door. Try this trick along with your other ventilation routines.

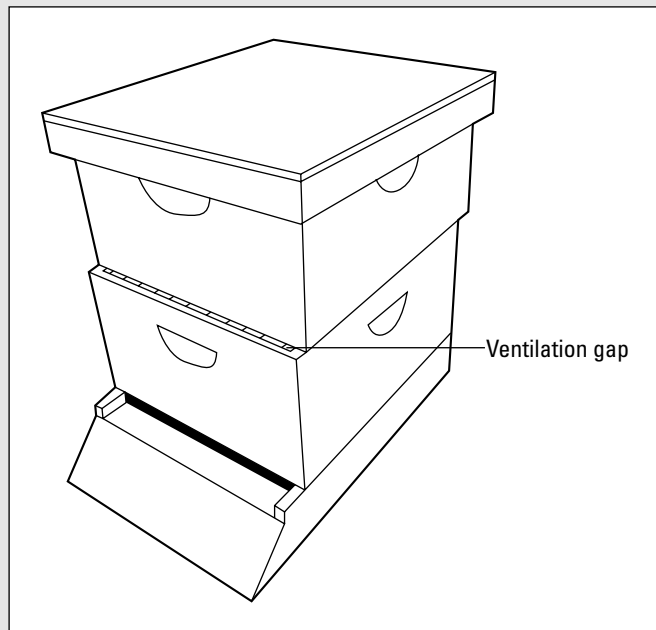

Your autumn time commitment

Figure on spending three to five hours total to get your bees fed, medicated, and bedded down for the winter months ahead.

Clustering in a Winter Wonderland

What goes on in a beehive during winter? The queen is surrounded by thousand of her workers — kept warm in the midst of the winter cluster. The winter cluster starts in the brood chamber when ambient temperatures reach 54 to 57 degrees F. When cold weather comes, the cluster forms in the center of the two hive bodies. It covers the *top* bars of the frames in the lower chamber and extends over and beyond the *bottom* bars of the frames in the food chamber (see Figure 8-2).



Although the temperature outside may be freezing, the center of the winter cluster remains a constant 92 degrees F. The bees generate heat by “shivering” their wing muscles.

No drones are in the hive during winter, but some worker brood begin appearing late in the winter. Meanwhile, the bees consume about 50 to 60 pounds of honey in the hive during winter months. They eat while they are in the cluster, moving around as a cluster whenever the temperature gets above 40 to 45 degrees F. They can move to a new area of honey only when the weather is warm enough for them to break cluster.



Bees won't defecate in the hive. Instead they hold off until they can leave the hive on a nice, mild day when the temperature is 45 to 50 degrees F to take *cleansing flights*.

Figure 8-2: Although the outside temperature may be freezing, the center of the winter cluster remains a balmy 92 degrees F. This cutaway illustration shows the winter cluster's position.



Your winter “to-do” list

Winter is the slowest season of your beekeeping cycle. You’ve already prepared your colony for the kinds of weather that your part of the world typically experiences. So, now is the time to do the following:

- ✓ Monitor the hive entrance. Brush off any dead bees or snow that blocks the entrance.
- ✓ Make sure the bees have enough food! The late winter and early spring are when colonies can die of starvation.

Late in the winter, on a nice, mild day when there is no wind and bees are flying, take a quick peek inside your hive. It’s best not to remove any frames. Just have a look-see under the cover. Do you see bees? They still should be in a cluster in the upper deep. Are they okay?

If you don’t notice any sealed honey in the top frames, you may need to begin some emergency feeding. But remember that once you start feeding, you *cannot* stop until the bees are bringing in their own pollen and nectar.

- ✓ Clean, repair, and store your equipment for the winter.
- ✓ Attend bee club meetings, and read all those back issues of your favorite bee journals.
- ✓ Order package bees and equipment (if needed) from a reputable supplier.
- ✓ Try a bee-related hobby. The winter is a good time for making beeswax candles, brewing some mead, and dreaming of spring! See Chapter 14 for some ideas.

Your winter time commitment

Not much is going on with bees during winter. They are in their winter cluster, toasty and warm inside the hive. Figure on spending two to three hours repairing stored equipment, plus whatever time you may spend on bee-related hobbies — making candles, mead, cosmetics, and so on — or attending bee-club meetings. You might even decorate your hive for the holidays (see Figure 8-3). Just don’t cover the ventilation holes!



Figure 8-3:

In the season to be jolly, deck your hive with boughs of holly!

Spring Is in the Air (Starting Your Second Season)

Spring is one of the busiest times of year for bees (and beekeepers). It's the season when new colonies are started, and established colonies come "back to life."

Days are getting longer and milder, and the established hive comes alive, exploding in population. The queen steadily lays more and more eggs, ultimately reaching her greatest rate of egg laying. The drones begin re-appearing, and hive activity starts hopping. The nectar and pollen begin coming into the hive thick and fast. The hive boils with activity.

Your spring "to-do" list

Beekeepers face many chores in the springtime, evaluating the status of their colonies and helping their bees get into shape for summer months. Some of those chores include



- ✓ **Conducting an early bird inspection:** Colonies should be given a quick inspection as early in the spring as possible. The exact timing depends upon your location (earlier in warmer zones, later in colder zones).

You don't need to wait until bees are flying freely every day nor until the signs of spring are visible (the appearance of buds and flowers). Do your first spring inspection on a sunny, mild day with *no wind* and a temperature close to 50 degrees F.

A rule of thumb: If the weather is cold enough that you need a heavy overcoat, it's too cold to inspect the bees.

- ✓ **Determining whether your bees made it through the winter:** Do you see the cluster? The clustered bees should be fairly high in the upper deep hive body. If you don't see them, can you hear the cluster? Tapping the side of the hive and putting your ear against it, listen for a hum or buzzing.

If it appears that you've lost your bees, take the hive apart and clean out any dead bees. Reassemble it and order a package of bees as soon as possible. Don't give up. We all lose our bees at one time or another.

- ✓ **Checking to make sure that you have a queen:** Look down between some of the frames. (Do you see any brood?) That's a good sign that the queen is present. To get a better look, you may need to carefully remove a frame from the center of the top deep. Can you see any brood? Do you spot any eggs?

This inspection must be done quickly, because you don't want to leave the frame open to chilly air. If you don't see any brood or eggs, your hive may be without a queen, and you should order a new queen as soon as possible, assuming, that is, the hive population is sufficient to incubate brood once the new queen arrives. What's sufficient? The cluster of bees needs to be *at least* the size of a large grapefruit (hopefully larger). If you have fewer bees than that, you should plan to order a new package of bees (with queen).



- ✓ **Checking to ensure the bees still have food:** Looking down between the frames, see if you spot any honey. Honey is capped with white cappings (tan cappings are the brood). If you see honey, that's great. If not, you must begin emergency feeding your bees (see the following bulleted items).
- ✓ **Medicating and feeding the colony:** A few weeks before the first blossoms appear, you need to begin medicating and feeding your bees (regardless of whether they still have honey).

Feed the colony sugar syrup (see recipe in Chapter 5). This feeding stimulates the queen and encourages her to start laying eggs at a brisk rate. It also stimulates the worker bees' wax glands. The two gallons need to be medicated with Fumigilin-B — subsequent gallons aren't medicated. See the section, "Administering spring medication," later in this chapter. Continue feeding until you notice that the bees are bringing in their own food. You'll know when you see pollen on their legs.



Feed the colony pollen substitute, which helps strengthen your hive and stimulates egg laying in the queen. Pollen substitute is available in a powdered mix from your bee supplier. This feeding can cease when you see bees bringing in their own pollen.

- ✓ **Reversing your hive bodies** (see “Reversing hive bodies” section later in this chapter).
- ✓ **Anticipating colony growth:** Don’t wait until your hive is “boiling” with bees. Later in the spring, before the colony becomes too crowded, create more room for the bees by adding a queen excluder and honey supers. Be sure that you remove the feeder and discontinue all medication at this time.
- ✓ **Watching out for indications of swarming:** Inspect the hive periodically and look for *swarm* cells (see Chapter 7).

Your springtime commitment

Spring is just about the busiest time for the beekeeper. You can anticipate spending eight to 12 hours tending to your bees.

Administering spring medication

Although you probably don’t need to medicate your bees during their first season (reputable bee suppliers should have already medicated the bees), you’ll definitely want to consider medication in the spring of your colony’s second season. Remember to stop all medication treatments five to six weeks *before* adding honey supers to the colony to prevent contamination of the honey that you want to harvest.

The list that follows contains a springtime medication regime that helps prevent diseases, control mites, and improve your bees’ overall health (see Chapters 10, 11, and 12 for more information):

- ✓ **To prevent Nosema:** In a small jar half filled with lukewarm water, add 1 teaspoon of *Fumigilin-B*. Shake the jar until dissolved. Stir the jar’s contents into the cooled sugar syrup solution you use to feed your bees (see Chapter 5). Feed at the top of the hive using a hive-top feeder. Medicate the first two gallons of syrup, but not subsequent gallons.
- ✓ **To prevent foulbrood:** *Terramycin* and *TYLAN* are antibiotics that come as a powder. They are effective against American and European foulbrood. To administer, carefully follow the directions on the package.



✓ **For general health:** *Honey B Healthy* contains essential oils (lemongrass and spearmint). The beneficial properties of using essential oils in hives are well documented. It's a "more natural" solution to honey bee health issues. Use it as a feeding stimulant by adding a teaspoon of the concentrate to your sugar syrup solution during your spring feedings. It helps keep bees healthy even in the presence of mites.

✓ **For varroa mite control:** Here there are a number of choices of product and treatment (see Chapter 11 for more information on varroa mite control). It is very important that you follow package directions precisely.

Never ever leave mite control products in the hive over the winter. Doing so constantly exposes the mites to the active chemical ingredient, which becomes weaker and weaker over time. These sublethal doses increase the chance for mites to build up a resistance to the products. This tolerance is then passed on to future generations of mites, and subsequent treatments become useless.

✓ **For tracheal mite control:** When the weather starts getting warmer, place a prepared bag containing 1.8 ounces of *menthol crystals* on the top bars toward the rear of the hive (see Chapter 11 for more information). Set them on a small piece of aluminum foil to prevent the bees from chewing holes in the bag and carrying it away. Leave the bag in the hive for 14 *consecutive* days when the outdoor temperature ranges between 60 and 80 degrees F.

Adding a grease patty to the top bars of the brood chamber is another treatment for tracheal mites. Making grease patties is easy; see Chapter 11 for the recipe that I use. Use one patty per hive, replacing them as the bees consume them. Use these patties throughout the year (even when honey supers are on the hive). Unused patties can be stored in the freezer until you're ready to use them.



There are non-chemical options for controlling mite populations. See Chapter 12 for examples of "natural" pest management.

Reversing hive bodies

Bees normally move upward in the hive during the winter. In early spring, the upper deep is full of bees, new brood, and food. But the lower deep hive body is mostly empty. You can help matters by reversing the top and bottom deep hive bodies (see Figure 8-4). Doing so also gives you an opportunity to clean the bottom board. Follow these steps:

Starting and stopping sugar syrup feedings

Continue feeding the bees sugar syrup in the spring until they stop taking the syrup — or until it is evident that the bees are bringing in nectar. The exception is for a newly established colony — in which case you should continue feeding syrup until all of the frames of

foundation are drawn into comb, or until the bees stop feeding on the syrup — whichever comes first. In the autumn, continue feeding until they stop taking the syrup, or the daytime temperature drops to less than 40° F (4° C) — whichever comes first.

- 1. When a mild day comes along (50 degrees F) with little or no wind and bright clear sunlight, open your hive using your smoker in the usual way.**
- 2. Place the upturned outer cover on the ground and then remove the upper deep hive body.**
- 3. Keep the inner cover on the deep and close the oval hole in the middle of the inner cover with a piece of wood shingle or tape.**
- 4. Place the deep across the edges of the outer cover, so there will be only four points of contact (you'll squeeze fewer bees that way).**
- 5. Now you can see down into the lower deep that still rests on the bottom board.**

It probably is empty, but even if some inhabitants are found, lift the lower deep off the bottom board and place it crossways on the inner cover that is covering the deep you previously removed.

- 6. Scrape and clean the bottom board.**

Note: This is good opportunity to add a slatted rack (see Chapter 4), because you won't get another chance until autumn. Slatted racks help with the hive's ventilation and can promote superior brood patterns. They also encourage the queen to lay eggs all the way to the front of the hive, because of improved ventilation and draft control.

- 7. Now stand the deep body — which had been the relatively empty bottom one — on one end, placing it on the ground.**

Then place the *full* hive body onto the clean bottom board (or on the slatted rack, if you added one).

- 8. Smoke the bees and remove the inner cover so that you can place the empty deep on top.**

Replace the inner and outer covers.

This reversing procedure enables the bees to better distribute brood, honey, pollen, fresh nectar, and water. Reversing gives them more room to move upward, which is the direction that they always want to move.

Repeat this reversal in about three to four weeks, restoring the hive to its original configuration. At that time you can put on one or more honey supers — assuming the bees are now bringing in their own food, and you have ceased feeding and medicating.

Figure 8-4: Reversing hive bodies in the spring helps to better distribute brood and food, and speeds up the growth of your colony's population.

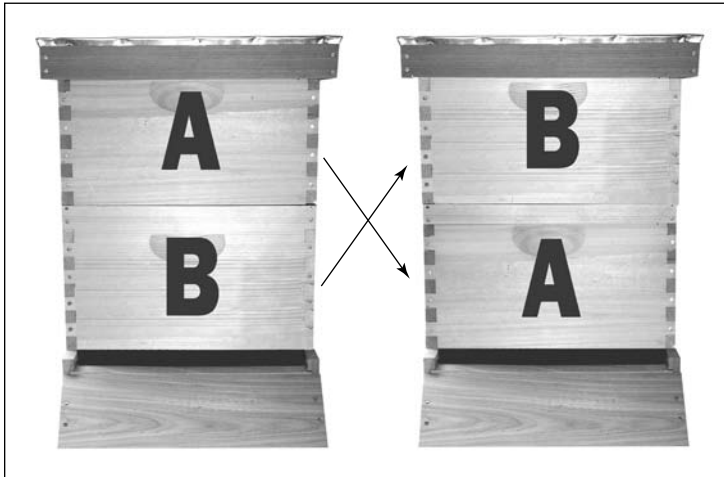

The Beekeeper's Calendar

This is not the bee-all and end-all of a “to-do” list! It’s simply a guideline to help you determine the kind of chores you should consider as the season progresses. Clearly a beekeeper’s calendar of activities will be different in Maine than in Southern California (see Figure 8-5). And the corresponding dates and activities can vary depending upon actual weather conditions, elevation, and so on. Consider this tool a “sanity check” as you and your bees progress through the seasons.

Zone A: Short summers and long, cold winters. Average annual temperature is between 35°F and 45°F. Minimum temperatures are between 0°F and 15°F.

Zone B: Summers are hot, and winters can be quite cold and extended. Average annual temperature is between 45°F and 55°F. Minimum temperatures are between 15°F and 20°F.

Zone C: Summers are long and hot, and the winters are mild and short. Average annual temperature is between 55°F and 65°F. Minimum temperatures are between 30°F and 35°F.

Zone D: Warm to hot all year round. Average annual temperature is between 65°F and 80°F. Minimum temperatures are between 30°F and 40°F.

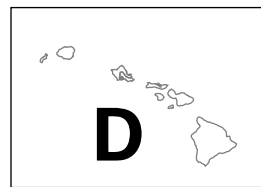
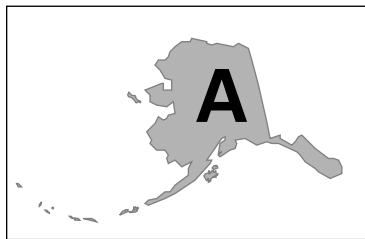
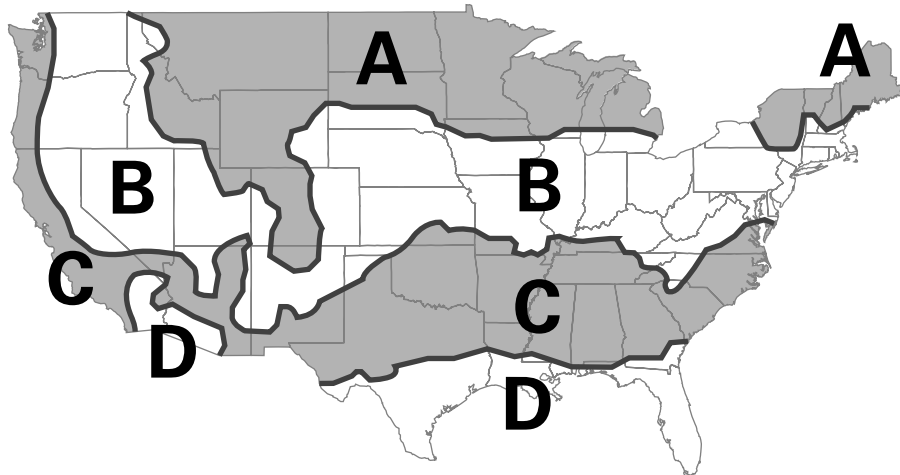

Figure 8-5:
The bee-keepers' calendar.

How to Use this Tool

1. Use Figure 8-5 to determine your “Beekeeping Zone”. If you live outside the United States, find the zone on the map with a temperature range that most closely corresponds to your part of the world.
2. Use Table 8-1 to locate the month of year you are currently in.
3. Look down the “month” column and find your zone letter (A, B, C or D). Wherever your zone letter appears, look at the corresponding activity in the far-left column. This is an activity you should consider doing during this month. All of these activities are covered in more detail within the various chapters of the book.

Table 8-1 **Beekkeeping Calendar**

<i>Typical Activity</i>	<i>JAN</i>	<i>FEB</i>	<i>MAR</i>	<i>APR</i>	<i>MAY</i>	<i>JUN</i>	<i>JUL</i>	<i>AUG</i>	<i>SEP</i>	<i>OCT</i>	<i>NOV</i>	<i>DEC</i>	
Check food reserves	B	B	A, C	A	A	B	B	B		A, C, D			
Feed colony if low on capped honey	B, D	B, D	A, B	A, B	A	B	B	B	B	A, B, C, D	C, D	D	
Check for eggs/queen		D	B, C	B, C	A	A		C		D			
Reverse hive bodies			B	C	A								
Install new bees in hive										B, A, B C, D			
First comprehensive inspection of the season										C, D	C, B	A	
Check for capped brood and brood pattern										D	B	B, C	A, B A, B
Feed a pollen substitute										C, D	A, B, C	A, B, C	
Look for swarm cells										D	B, D	A, B, C, D	A, B, C

Typical Activity	JAN	FEB	MAR	APR	MAY	JUN	JUL	AUG	SEP	OCT	NOV	DEC
Add queen excluder and honey supers			D	B, D	A, B, C, D	A						
Look for supercedure cells				B, C, D	A, B, C, D	A, B, C, D						
Check ventilation					D	D	B, C, D	C, D	B	A	A	A
Add mouse guard										B, C	A, B	
Medicate for AFB, EFB, and Nosema		D	C	B	A			A, B	C, D			
Check surplus honey			D	D	D	A, B, D	A, B, C	A, B	C			
Harvest honey					D	B, D	B, D	B				
Test for varroa mites			C, D	B	A	D		A, B	A, D			
Medicate for varroa mites (if needed)			C, D	B	A	D		A, B	A, C, D			

(continued)

Part IV

Common Problems and Simple Solutions

The 5th Wave

By Rich Tennant

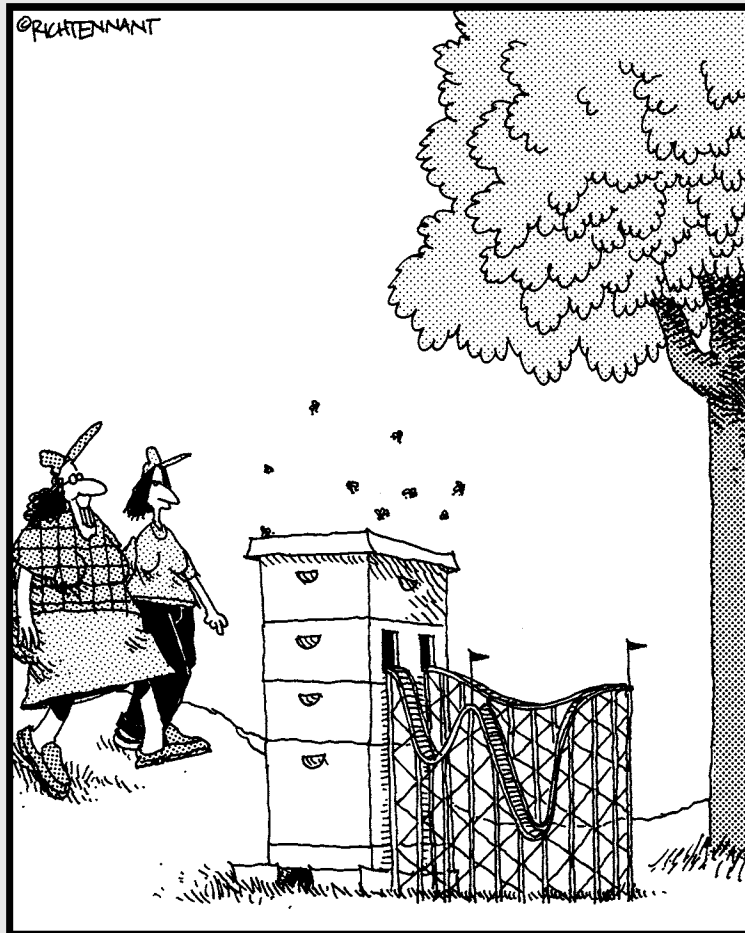

"I try to see to it that it's not all work for my bees."

In this part . . .

Sometimes things go wrong. But don't worry. In these chapters, I tell you what to expect and what to do when things don't go as planned. Find out how to keep your bees from swarming, getting sick, or undergoing stress. If you encounter a problem, refer to this section for a solution.

Chapter 9

Anticipating and Preventing Potential Problems

In This Chapter

- ▶ Preventing and controlling swarming
 - ▶ Capturing a swarm
 - ▶ Replacing your queen
 - ▶ Thwarting robbing frenzies
 - ▶ Ridding your hive of laying workers
 - ▶ Preventing pesticide poisoning
 - ▶ Understanding the “killer bee” phenomenon
-

Despite the best intentions and the most careful planning, things occasionally go wrong. It happens. The bees swarm. The queen is nowhere to be found. The whole colony dies or flies away. What happened? Did you do something wrong? What could you have done differently?

I’ve made just about every mistake in the book at one time or another. But that’s nothing to be ashamed of. It’s part of the process. The key lesson I’ve learned has been to *anticipate*. Discipline yourself to plan ahead and look out for potential problems *before* they happen. I can assure you that you can head off 80 to 90 percent of potential problems at the pass if you anticipate trouble and take steps to avoid it.

In this chapter, I include a few of the more common non-medical problems to anticipate and try to avoid. These problems include swarming and absconding, losing your queen, and losing your colony because of poor ventilation robbers (robber bees, that is!), and pesticides. This chapter also tells you how to deal with potential community-mindset problems of having Africanized bees in your geographical area.

Running Away (To Join the Circus?)

Sometimes bees disappear. They simply get up and go. Poof! In one common scenario, called *swarming*, about 50 percent of the colony packs up with the queen and takes flight. In the other scenario, called *absconding*, 100 percent of the colony hits the road, leaving not a soul behind. Neither scenario is something you want to happen.

Swarming

A swarm of honey bees is a familiar sight in the spring and early summer. It's one of the most fascinating phenomena in nature and an instinctive way that honey bees manage the colony's growth and survival. To witness a swarm pouring out of a hive is simply thrilling — though the pleasure may be less so if the swarm of bees is yours!

Immediately before swarming, the bees that intend to leave the colony gorge themselves with honey (like packing a box lunch before a long trip). Then, all at once, like someone flipped a switch, tens of thousands of bees exit the hive and blacken the sky with their numbers. Half or more of the colony leaves the hive to look for a new home. But first, within a few minutes of departing from the hive, the bees settle down on a nearby surface.

There's no telling where a swarm might land. It could land on any convenient resting place: a bush, a tree branch (see Figure 9-1), a lamppost, or perhaps a piece of patio furniture (see Figure 9-2). In any case, the swarming bees won't stay there long. As soon as scout bees find a more suitable and protected home, the swarm will be up, up, and away.

In its temporary resting place, the swarm is a bundle of bees clustered together for protection and warmth. In the center of it all is their queen. Depending on the size of the hive that swarmed, the cluster may be as small as a grapefruit or as large as a watermelon. The bees will remain in this manner for a few hours or even a few days while scout bees look for a new home. When they return with news of a suitable spot, off they all go to take up residence in a hollow tree, within the walls of an old barn, or in some other cozy cavity.



Not sure if your hive has swarmed? A regular inspection during the month of May and June will reveal the situation. Know the key indicators: no eggs, fewer bees, and all the cells have only older larvae and/or capped brood. And there are always queen cells present along the lower third of the frames.



Figure 9-1:
A swarm resting in a tree.



Figure 9-2:
A swarm that has taken up temporary residence under a picnic table.

What's the buzz?

You may have heard how a friend of a friend knew a couple who kept hearing a mysterious humming noise in their bedroom at night. Upon taking the wall apart, they discovered the whole space within the wall had been turned into a hive. No, this is not an urban legend! I get calls like this every year — at some point a colony of

bees has swarmed and set up housekeeping in a cozy niche of a human habitation. And now there's honey dripping through the ceiling and so forth. This is one whacking big job to deal with and very expensive. The walls have to be torn apart to get at such hives for removal.

Understanding why you want to prevent swarming

Swarms are a dramatic sight, and a completely natural occurrence for the bees, but swarms are not good news for you. A colony that swarms is far less likely to collect a surplus of honey. That means no honey harvest for you that year. A colony that loses 50 percent of its population and 50 percent of its honey also will have a difficult time regaining its population and productivity. It also means the bees may have a tougher time making it through the cold winter months (assuming you have such weather).

It's unhappy enough news when your bees swarm, but the *later* in the season they do it, the worse the news is for you. If the bees choose to swarm later, and you live in an area that experiences cold winter months, there simply isn't enough time for the colony to recover during that season.

If you're a first-year beekeeper, rest assured that a new colony is unlikely to swarm during its first season. But older and more crowded colonies are likely candidates for swarming behavior. Remember, swarming is a natural and normal instinct for bees. At one point or another, your bees will want to swarm. It's only natural. It's nature's way of reproduction. But discouraging them from doing so is a skill every beekeeper should have as a swarm means less bees to make honey for you.

Keeping the girls from leaving home

There are two primary reasons bees swarm: congestion and poor ventilation. Occasionally, a poorly performing queen can contribute to the swarming impulse. But all these conditions can be anticipated and avoided. Here are some things you can do:

- ✓ **Avoid congestion.** Because overcrowding is a primary reason a colony will swarm, make sure to anticipate your bees' needs and provide them with more room *before* they need it. If you wait until it's obvious that the colony is crowded, you're too late! The colony is likely to swarm, and

there is little you can do to prevent them from swarming once they've set their minds to it. However, you can do the following to prevent congestion from happening in the first place:

- Reverse your hive bodies in the early spring to better distribute the fast-growing population (see Chapter 8).
- Add a queen excluder and honey supers *before* the first nectar flow in the early spring (stop feeding and medicating before you add honey supers; see Chapter 8).

✔ **Provide adequate ventilation.** To ensure proper ventilation, you can do a number of things:

- If your inner cover has a notched ventilation hole in the front of the inner cover, make sure it is open. Here's how. Stand at the rear of the hive and push the outer cover forward. Doing so prevents the overhang of the outer cover from blocking the notched hole on the inner cover.
- Glue a short length of a wooden Popsicle stick to each of the four corners of the inner cover. By doing so, you create a thin gap between the inner cover and the hive and improve air flow into and out of the hive. (Alternatively, you can place a short screw with a fat, domed head in each corner. The fat head of the screw creates the gap you want.)
- Drill wine cork-sized holes in your upper deep (below the hand hold) and in all your honey supers, as shown in Figure 9-3. Doing so not only provides extra ventilation but also provides the bees with additional entrances. This ventilation can even be helpful in the cold winter months. You can control airflow and access by blocking and opening these holes as needed with corks or strips of duct tape. Be sure to close off these entrances for a new colony whose population is still too small to defend all these extra openings.

Figure 9-3:
A useful way to provide a colony with ventilation is to drill wine cork-sized holes in the hive bodies and supers.



✔ **Make the bees comfortable in hot weather by doing the following:**

- Supply a nearby water source. The bees will use this water to regulate the hive's temperature. See Chapter 3 for suggestions regarding water sources.
- Shield the hive from a full day of blazing sun. Particularly if you live in a blazing hot area. Locating the hive in dappled sunlight is the best solution (see Chapter 3).

✔ **Remove queen swarm cells — all of them.** The earliest evidence that your bees are thinking about swarming is that they start to make swarm cells (see Chapter 7). During the spring and early summer, inspect your hive every week or ten days to look for swarm cells. They can be found along the bottom of the frames. If you see any, remove them by cutting them out with the sharp end of your hive tool. The colony won't swarm if it doesn't have a new queen in the making.

This technique only works if you remove 100 percent of the swarm cells. If just one cell remains behind, the colony has the green light to swarm.

✔ **Replace your queen every other autumn.** Colonies with young queens are far less likely to swarm.



If the hive is simply boiling over with bees and you failed to take any of the above precautions, there is a last-resort emergency measure. You can remove all the frames of capped brood from the hive (with bees still on the frames) and replace them with frames of foundation. *A colony will not swarm if it does not have capped brood equal to the number of bees swarming.*

Make sure that the queen is not on any of these frames. You can use these frames of bees and brood to start a *new* hive! If there are eggs on those frames, the “new” hive will raise a new queen. Or you can play it safe and order a new queen from your bee supplier.

The 7/10 rule

If you're a first-year beekeeper, here's a way to remember when it's time to give a new colony more room (and do so *before* it's too late):

- ✔ When 7 of the 10 frames in the lower deep are drawn into comb, add a second deep hive body with frames and foundation.
- ✔ When 7 of the 10 frames in the upper deep are drawn into comb, add a queen excluder and a honey super.
- ✔ When 7 of the 10 frames in the honey super are drawn into comb, add an additional honey super.

Continue providing more room in this manner, adding more space when the bees have drawn out 70 percent of the foundation.

They swarmed anyway. Now what?

Okay, the bees swarmed anyway. You're not alone; it happens. The good news is that you may be able to capture your swarm and start another colony. (See the following section titled "Capturing a swarm.") You wanted a new hive of bees anyway, didn't you?

In any event, what should you do with the half of the colony that remains? Follow these steps:

1. A week after your colony swarms, inspect the hive to determine whether you have a new queen.

You might spot a queen cell or two along the lower third of the frames (see Chapter 7 for tips on finding queen cells). Good! That's an encouraging sign. It means a new queen is "in the oven." But you must ultimately determine if the colony's new queen is laying eggs. One week after a swarm you're unlikely to see any eggs — it's too soon for the new queen to get to work. But do have a look and see if you can find her majesty. If you can, great! Close up the hive and wait another week. If you *don't* see the queen, wait a couple more days and have another look.



After the swarm, it will take six to eight days for the queen cell to open and a new virgin queen to emerge. Then allow three to four more days for her to mate with the drones. After another three to four days, she will start laying eggs. The total elapsed time since the swarm is about two weeks.

Consider marking your new queen once you've found her. It's common for a beekeeper to place a daub of color on the queen's thorax (back). Marking queens makes them easier to find during future inspections, and verifies that the queen you see is the same one you saw during previous inspections. For information on how to do this, see Chapter 13.

2. Two weeks after the swarm, open the hive again and look for eggs.

Do you see eggs? If so, you have a queen, and your colony is off and running. Close things up and celebrate with a glass of mead. If there's still no sign of a queen or her eggs, order a new queen from your bee supplier. Hive the replacement queen as soon as she arrives (see "Introducing a new queen to the hive" later in this chapter).



If you don't follow up after a swarm, the colony can easily become queenless without you ever being aware of it. No queen, no brood. No brood, no good.

1. Have at-the-ready a new hive body with nine frames and foundation, bottom board, hive-top feeder and outer cover (I'll refer to this as the "new" hive).

2. Turn your attention to the suspect hive (I'll refer to this as the "old" hive). Smoke and inspect, looking for the frame with the queen on it. When you find that regal frame, gently put it aside. Be careful! The queen is on that frame! You can make use of a empty nuc box or another empty hive body to hold this frame out of harm's way. In any event, find a way to keep the queen and frame safe and sound while you tend to other things.
3. Move the old hive at least 10 feet away from its original location (here's where a wheelbarrow or hive lifter comes in handy).
4. Now place the new hive setup where the old hive was previously located.
5. Place a bed sheet in front of the new hive, from the ground to the entrance board. You are creating a ramp for the bees that you are about to unceremoniously dump in front of this hive.
6. Back to the old hive. One by one, take each frame out of the old hive, and shake 80 to 90 percent of the bees off the frames (use a bee brush if you prefer) and onto the bed sheet ramp in front of the new hive. They will march their way right into the new hive (see the following figure). Make sure you don't shake all of the bees off the frames. About 10 to 20 percent of the bees should remain on the old frames.
7. Put these old frames (with some bees still clinging to them) back into the old hive. At this point, the old hive has nine of its original frames containing brood, larvae, eggs, and about 10 to 20 percent of the bees. Remember that these frames must contain at least one queen cell. Add a new frame and foundation to take up the empty (tenth) slot.
8. Here's where you take the frame with the old queen and gently brush her onto the entrance of the new hive. Bee careful!
9. Take the frame that the queen was on and slip it into the tenth slot of the new hive. Your new hive now contains this "old" frame, nine new frames with foundation, and about 80 to 90 percent of the bees. Plus the original queen.
10. Feed syrup to both hives using hive-top feeders or some other suitable feeding device.

Using an artificial swarm to prevent a natural swarm

There's another way to prevent a crowded hive from swarming: by creating an "artificial swarm" (sometimes called a "shook swarm"). This little trick is a lot of work, but it's an effective way to get the urge to swarm out of your

colony's system. The best time to do a "shook swarm" is before 10 a.m. or after 2 p.m. Note that for this method to work, your "suspect" hive must have at least one queen cell on the frames.

It's a good practice to close up the new hive for a day or two by pushing screening along the entrance way. Confining the bees in this manner gets them working on building new comb and helps them get over the swarming instinct.

Capturing a swarm

If your bees do swarm and you can see where they landed (and you can reach it safely), you can capture them and start a new hive. You may even be lucky enough to get a call from a friend or neighbor who has spotted a wild swarm in his yard (beekeepers are often called to come capture swarms). Either way, capturing a swarm is a thrilling experience.

Despite their rather awesome appearance, swarms are not that dangerous. That's because honey bees are defensive only in the vicinity of their nest. They need this defensive behavior to protect their brood and food supply. But a swarm of honey bees has neither young nor food and is usually very gentle. That's good news because it makes your job easy if you want to capture a swarm of bees.



If you live in an area known to have Africanized Honey Bees (discussed later in this chapter), you must be very cautious — a swarm might be this undesirable strain. There's no way of telling just by looking at them. If you're in doubt, don't attempt to capture a swarm — unless you are certain this swarm originated from your hive.

Be prepared for a crowd of awestruck onlookers. I always draw a crowd when I capture a swarm. Everyone in your audience will be stunned as you walk up to this mass of 20,000 stingers wearing only a veil for protection. "Look" they'll gasp, "that beekeeper is in short sleeves and is not wearing any gloves! Are they crazy?" Only you will know the secret: The bees are at their gentlest when they're in a swarming cluster. You have nothing to fear. But your neophyte audience will think that your bravery is supreme. To them, you are a bee charmer — or the bravest (or nuttiest) person alive!

The easiest swarms to capture are those that are accommodating enough to collect on a bush or a low tree branch — one that you can reach without climbing a ladder. Obviously, if the branch is high up in a tree, you should not attempt your first capture! Gain experience by first capturing swarms that are easy reaches. Then you can graduate to the school of acrobatic swarm collection.

Say your swarm is located on an accessible branch. Lucky you! Follow these steps to capture it:

- 1. Place a suitable container on the ground below the swarm.**

You can use a large cardboard box (my favorite), an empty beehive, or a nuc box (see Chapter 5). This container will be the swarm's temporary accommodation while you transport the bees to their new, permanent

home. The container you use should be large enough to accommodate the entire cluster of bees and a hunk of the branch they are currently calling home.

2. Get the bees off the branch.

One approach is to give the branch holding the bees a sudden authoritative jolt. Doing so will dislodge the swarm, and it will (hopefully) fall into the container that you have placed directly under it. If this approach works, great. But it can be tricky. The swarm may miss its mark, and you may wind up with bees all over the place. In addition, this violent dislodging tests the gentle demeanor I promised!

I prefer a more precise approach that enables you to gently place (not drop) the bees into their “swarm box.” This approach works if the swarm is on a branch that you can easily sever from the rest of the foliage. You’ll need a pair of pruning shears — a size appropriate for the job at hand. Follow these steps:

1. Study the swarm.

Notice how the bees are clustered on the branches. Can you spot the main branch that’s holding the swarm? Are several branches holding it? Try to identify the branch (or branches) that, if severed, will allow you to gingerly walk the branch with swarm attached over to the box. In this manner, you can *place* the swarm in the box, not dump it.

2. Snip away at the lesser branches while firmly holding the branch containing the mother lode with your other hand.

Work with the precision of a surgeon: You don’t want to jolt the swarm off the branch prematurely. When you’re absolutely sure that you understand which branch is holding the bees, make the decisive cut. Anticipate that the swarm will be heavier than you imagined, and be sure that you have a firm grip on the branch before you make the cut. Avoid sudden jolts or drops that would knock the bees off the branch.

3. Carefully walk the swarm (branch and all) to the empty cardboard box and place the whole deal in the box. The bees will not leave the branch as you walk, but you should walk as gingerly as if you were walking on ice.

3. Close up the box, tape it shut, and you’re done. Whew!

Get it home right away because heat will build up quickly in the closed box.



I have modified a cardboard box for swarm captures. One side contains a large “window” cutout that I have fitted with mosquito screen. This window gives the captured swarm ample ventilation. Alternatively, punch some holes in the box with an awl or an ice pick to provide ventilation.

Hiving your swarm

You can introduce your swarm into a new hive in the following manner:

1. Decide where you want to locate your new colony.

Keep in mind all the factors you need to consider when making this decision (see Chapter 3).

2. Set up a new hive in this location.

You'll need a bottom board, a deep hive body, ten frames and foundation, an inner cover, an outer cover and a hive-top feeder (or other means for feeding the bees syrup). Keep the entrance wide open (no entrance reducer).

3. Place a bed sheet in front of the new hive, from the ground to the hive entrance.

This ramp will help the bees find the entrance to their new home. In lieu of a bed sheet, you can use a wooden plank or any configuration that creates a gang plank for the bees.

4. Take the box containing the swarm and shake/pour the bees onto the bed sheet, as close to the entrance as possible.

Some of the bees will immediately begin fanning an orientation scent at the entrance, and the rest will scramble right into the hive. What a remarkable sight this is — thousands of bees marching into their new home. Congratulations! You have a new colony of bees!

The swarm of bees (now in their new home) will draw comb quickly because they arrive loaded with honey. Feed them syrup using the hive-top feeder to stimulate wax production. Feeding may not be necessary if the nectar flows are heavy.



TIP

In a week, check the hive and see how the bees are doing. See any eggs? If you do, you know the queen is already at work. How many frames of foundation have been drawn into comb? The more the merrier! Is it time to add a second deep (see the “The 7/10 rule” sidebar earlier in this chapter)?



HIVE TALK

Finding a swarm and starting a new colony are typically more desirable earlier in the season than later. That's because late-swarms don't have much time to grow and prosper before the winter sets in. There's an old poem of unknown origin that is well-known to beekeepers:

A swarm in May — is worth a load of hay.

A swarm in June — is worth a silver spoon.

A swarm in July — isn't worth a fly.

Absconding

Absconding is a cruel blow when it happens. One day, you go to the hive and find that no one's at home. Every last bee (or nearly every bee) has packed up and left town. What a horror! Here are some of the typical causes of absconding:

- ✔ **Colony Collapse Disorder (CCD):** This relatively new phenomenon has devastated honey bee colonies around the world. One day the bees are gone with no evidence as to why. The causes are unknown, but the problem is being vigorously studied. For more information on what you can do to help prevent CCD, see Chapter 10.
- ✔ **Lack of food:** Make sure that your hive has an ample supply of honey. Feed your bees sugar syrup when their stores are dangerously low and during serious dearths of nectar.
- ✔ **Loss of queen:** This situation eventually results in a hive with no brood. Always look for evidence of a queen when you inspect your bees. Look for eggs!
- ✔ **Uncomfortable living conditions:** Make sure that the hive is situated where it doesn't get too hot or too wet. Overheated or overly wet hives make life unbearable for the colony. Provide ample ventilation and tip the hive forward for good drainage.
- ✔ **Itty-bitty (or not so itty-bitty) pests:** Some hives (particularly weak ones) can become overrun with other insects, such as ants, or hive beetles. Even persistent raids from wildlife (skunks, raccoons, and bears, for example) can make life miserable for the bees. See Chapter 12 for tips on dealing with these annoyances.
- ✔ **Mites and disease:** Colonies that are infested with mites or have succumbed to disease may give up and leave town. Routinely medicate your bees to prevent such problems (see Chapters 11 and 12).

Where Did the Queen Go?

It's every beekeeper's nightmare: The queen is dead, or gone, or lost. Whatever the reason, if the colony doesn't have a queen, it's doomed. That's why you must confirm that the queen is alive and well at every inspection. If you come to the dismal conclusion that your colony is queenless, you can do two things: Let the colony raise its own queen or introduce a new queen into the colony.



If you are a new beekeeper, don't panic if you can't find your queen. I get more calls about "lost queens" than any other topic. But most of the time the queen is in the hive. It's just that the new beekeeper has not yet become adept at spotting her. If you can't find the queen (she's easy to miss), look for eggs or very young larvae. That's a sure indication she was there just days ago.

Letting nature take its course

To let the colony create a new queen, it must have occupied queen cells or cells with eggs. If eggs are available, the worker bees will take some of them and start the remarkable process of raising a new queen. When the new virgin queen hatches, she will take her nuptial flight, mate with drones, and return to the hive to begin laying eggs. If no eggs are available for the colony to raise a new queen, you must take matters into your own hands and order a new queen from your beekeeping supplier (see next section). Or you can find out how to raise your own queen (see Chapter 13).



The colony must have eggs to create its own queen. Older larvae or capped brood are at too late a developmental stage to be transformed into new queens.



Replacing your queen naturally is certainly interesting, but consider the logistics. The entire process (from egg to laying queen) can take a month. That's a precious amount of time during honey collection season. Particularly if you live in a climate with a short summer season. In the interest of productivity, it may be better to take matters into your own hands and order a replacement queen. At least in your first year.

Ordering a replacement queen

A faster solution than the *au natural* method is to order a replacement queen from your bee supplier. Within a few days, a vigorous queen will arrive at your doorstep. She's already mated and ready to start producing brood.

The advantages of ordering a queen are clear:

- ✓ It provides a fast solution to the problem of having a queenless colony.
- ✓ The queen is certain to be fertile.
- ✓ It guarantees the pedigree of your stock. (Queens left to mate in the wild can produce bees with undesirable characteristics, such as a bad temper.)

Introducing a new queen to the hive

After your queen arrives by mail, you must introduce her into the colony. Doing so can be a little tricky. You can't just pop her in: She's a stranger to the colony, and the bees are sure to kill her. You have to introduce her *slowly*. The colony needs time to accept her and become accustomed to her scent. Old-time beekeepers swear by all kinds of methods — and some are downright weird. (I don't want you to try them so I'm not going to mention them here!) I suggest that you use one of the following tried-and-true approaches:

1. Remove one of the frames from the brood box.

Pick a frame with little or no brood on it, as whatever brood is on the frame will be lost — you won't use this frame again for a week.

2. Shake all the bees off the frame and put it aside for the next week.

3. With the one frame removed, create a space in the center of the brood box. Use this space to hang the queen cage in the same way you hung it when you first installed your package bees (see Chapter 5 and Figure 9-4).



Figure 9-4:
Hanging a
queen cage.



Make sure to remove the cork from the queen cage to expose the candy plug. Also, when you hang the cage, make sure that the candy end is facing *up*. That way, any attendant bees that die in the cage will not block the hole and prevent the queen from getting out. Leave the bees alone for one week, and then inspect the hive to determine that the queen has been released and that she is laying eggs.

If the weather is mild (over 60 degrees F at night), you can introduce the queen cage on the bottom board (see Figure 9-5). Remove the cork to expose the candy plug. Slide the cage screen side up along the bottom board and

situate it toward the rear of the hive. Use your hive tool to nudge it as far to the rear of the hive as possible. Leave the bees alone for one week, and then inspect the hive to determine that the queen has been released and that she is laying.



Use a flashlight to peer into the back of the hive to see if the hole in the cage is clear. If yes, the queen has likely been released.



Figure 9-5:
Sliding
a queen
cage onto
the bottom
board.

Avoiding Chilled Brood

Honey bees keep their hive clean and sterile. If a bee dies, the others remove it immediately. If a larva or pupa dies, out it goes. During the early spring, the weather can be unstable in some regions of the country. A cold weather snap can chill and kill some of the developing brood. When this happens, the bees dutifully remove the little corpses and drag them out of the hive. Sometimes the landing board at the entrance is as far as they can carry them. You may spot several dead brood at the entrance or on the ground in front of the hive. Don't be alarmed — the bees are doing their job. A few casualties during the early spring are normal.

Note: Chilled brood looks similar to, but is different from, the disease *chalkbrood*. You can find information about chalkbrood in Chapter 11.

Sometimes beekeepers unwittingly contribute to the problem of chilled brood. Remember, chilled brood is killed brood. You can do a few things to avoid endangering your bees:

- ✓ When the temperature drops below 50 degrees F, keep your inspections very, very brief. A lot of heat escapes every time you open the hive, and brood can become chilled and die.

- ✔ Provide adequate ventilation to avoid condensation. The resulting icy water dripping on the bees can chill the brood.
- ✔ Inspect your bees only on days when there is little or no wind (especially during cool weather). Harsh winds will chill (and kill) brood.

Dealing with the Dreaded Robbing Frenzies

Robbing is a situation in which a hive is attacked by invaders from other hives. The situation is serious for a number of reasons:

- ✔ A hive defending itself against robbing will fight to the death. This battle can result in the loss of many little lives and even destroy an entire colony. Tragedy!
- ✔ If the hive is unable to defend itself in a robbing situation, the invading army can strip the colony of all its food. Disaster!
- ✔ Being robbed changes the disposition of a hive. The bees can become nasty, aggressive, and difficult to deal with. Ouch!

Many new beekeepers mistake a robbing situation as being the opposite of a problem. Look at all that activity around the hive! Business must be booming! It's a natural mistake. The hive's entrance is furious with activity. Bees are everywhere. Thousands of them are darting in, out, and all around the hive. But look more closely. . . .

Knowing the difference between normal and abnormal (robbing) behavior

A busy hive during the nectar flow may have a lot of activity at the entrance, but the normal behavior of foraging bees looks different than a robbing situation. Foraging bees go to and fro with a purpose. They shoot straight out of the hive and are quickly up and away. Returning foragers are weighted down with nectar and pollen and land solidly when returning to their hive. Some even undershoot the entrance and crash-land just short of the bottom board.

Other times, normal activity at the hive's entrance can look unusually busy. This is when young worker bees take their orientation flights. Facing the hive, they hover up, down, and back and forth. They're orienting themselves to the location of their hive. You may see hundreds of these young bees floating around the front of the hive, but there's nothing aggressive or frantic about their exploratory behavior.



In contrast to these normal busy situations, robbing takes on an aggressive and sinister look. Try to recognize the warning signs:

- ✓ Robbing bees approach the hive without being weighted down with nectar. They may not shoot right into the entrance. Instead, they fly from side to side, waiting for an opportune moment to sneak past the guard bees.
- ✓ If you look closely, you may see bees fighting at the entrance or on the ground in front of the hive. They are embraced in mortal combat. These are the guard bees defending their colony to the death. This behavior is a sure indication of robbing.
- ✓ Unlike foraging bees that leave the hive empty-handed, robbing bees leave the hive heavily laden with honey, which makes flying difficult. Robbing bees tend to climb up the front of the hive before taking off. Once they're airborne, there's a characteristic dip in their flight path.

Putting a stop to a robbing attack

If you think that you have a robbing situation underway, don't waste time. Use one or more of the following suggestions to halt robbing and prevent disaster:

- ✓ Reduce the size of the entrance to the width of a single bee. Use your entrance reducer or clumps of grass stuffed along the entrance. Minimizing the entrance will make it far easier for your bees to defend the colony. But be careful. If the temperature has turned hot, narrowing the entrance impairs ventilation.
- ✓ Soak a bed sheet in water and cover the hive that's under attack. The sheet (heavy with water) drapes to the ground and prevents robbing bees from getting to the entrance. The bees in the hive seem to be able to find their way in and out. During hot, dry weather, rewet the sheet as needed. Be sure to remove the sheet after one or two days. By that time the robbing behavior should have stopped.

Preventing robbing in the first place

The best of all worlds is to prevent robbing from happening at all. Here's what you can do:

- ✓ Never leave honey out in the open where the bees can find it — particularly near the hive and during a dearth in the nectar flow. Easy pickings can set off a robbing situation.

- ✔ When harvesting honey, keep your supers covered after you remove them from the colony.
- ✔ Be very careful when handling sugar syrup. Try not to spill a single drop when feeding your bees. The slightest amount anywhere but in the feeder can trigger disaster.
- ✔ Until your hive is strong enough to defend itself, use the entrance reducer to restrict the size of the opening the bees must protect. Also, be sure to close off the hole in the inner cover.
- ✔ Never feed your bees in the wide open (such as filling a dish with syrup or honey and putting it near the entrance of the hive).
- ✔ Avoid using a Boardman entrance feeder (see Figure 9-6). Being so close to the entrance, these feeders can incite robbing behavior.

Figure 9-6:
I don't advocate using a Boardman entrance feeder — it can entice strange bees to rob your hive because of the smell of the syrup.

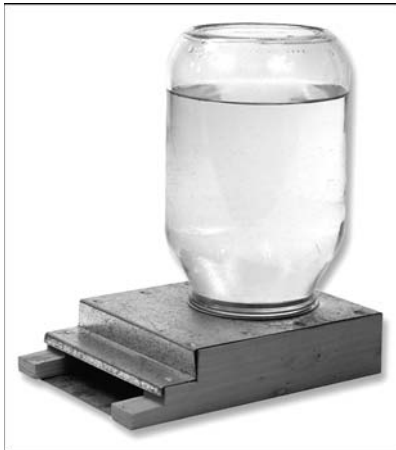

Don't be tempted to make it easier for your bees to access the syrup you feed them. I know of a beekeeper who put shims between the hive-top feeder and hive to create a gap that makes it easier for the bees to access the syrup. The result was a furious robbing attack from other bees. Keep your feeding device where only your colony can reach it.

Ridding Your Hive of the Laying Worker Phenomenon

If your colony loses its queen and is unable to raise a new queen, a strange situation can arise. Without the “queen substance” wafting its way through the hive, there is no pheromone to inhibit the development of the worker

bees' reproductive organs. In time, young workers' ovaries begin to produce eggs. But these eggs are not fertile (the workers are incapable of mating). So the eggs can only hatch into drones. You may notice eggs, larvae, and brood and never suspect a problem. But you have a huge problem! In time, the colony will die off without a steady production of new worker bees to gather food and tend to the young. A colony of drones is doomed.

How to know if you have laying workers

Be on the lookout for a potential laying-workers situation and take action when it happens. The following are key indicators:

- ✔ **You have no queen.** Remember that every inspection starts with a check for a healthy, laying queen. If you have lost your queen, you must replace her.
- ✔ **You see lots and lots of drones.** A normal hive never has more than a few hundred drone bees. If you notice a big jump in the drone population, you may have a problem.
- ✔ **You see cells with two or more eggs.** This is the definitive test. A queen bee will place only one egg in a cell — never more than one. Laying workers are not so particular; they will place two or more eggs in a single cell. If you see more than one egg in a cell (see Figure 9-7), you can be certain that you have laying worker bees. Time to take action!

Figure 9-7:
The best way to determine whether you have laying workers is to count eggs in the cells. If you spot multiple eggs in a cell, you have a problem to deal with.

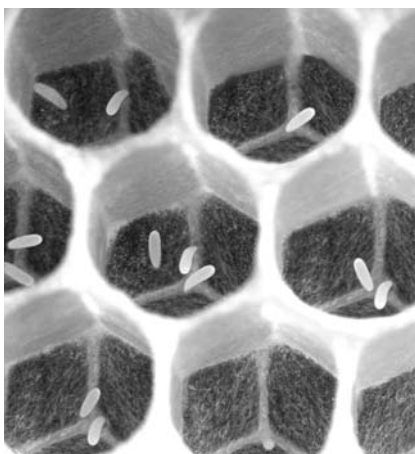

Getting rid of laying workers

You may think that introducing a young and productive queen will set things right. But it won't. The laying workers will not accept a queen once they have started laying eggs. If you attempt to introduce a queen, she will be swiftly killed. Guaranteed.

Before you can introduce a new queen, you need to get rid of all the laying workers. But how? They look just like all the other workers! The solution is tedious and time-consuming but 100-percent effective when done properly. You need the following items:

- ✓ An empty deep hive body (no frames). The empty hive body will be used to temporarily hold the frames you remove from the problem hive. You will need two empty hive bodies if your problem hive consists of two deep hive bodies.
- ✓ An outer cover
- ✓ A wheelbarrow or hand truck

Follow these steps:

- 1. Order a new marked queen from your bee supplier.**
- 2. The day your queen arrives, put the entire “problem” hive (bees and all, minus the bottom board) in the wheelbarrow (or on the hand truck) and move it at least 100 yards away from its original location. You'll want those spare empty hive bodies and outer covers nearby.**

The bottom board stays in its original location.

- 3. One by one, shake every last bee off each frame and onto the grass.**
Not a single bee can remain on the frame — that bee might be a laying worker. A bee brush (see Chapter 4) helps get the stubborn ones off.
- 4. Put each empty frame (without bees) into the spare empty hive(s) you have standing by. These should be at least 15 to 20 feet away from the shaking point.**

Make sure that no bees return to these empty frames while you are doing the procedure. Use the extra outer cover to ensure that they can't sneak back to their denuded frames.

- 5. When you have removed every bee from every frame, use the wheelbarrow or hand truck to return the old (now bee-less) frames to the original hive bodies.**

Again, just make sure that no bees sneak back onto the frames.

- 6. Place the hive to its original location on the bottom board, and transfer all the denuded frames from their temporary housing. So now you have the original hive bodies back at their original location, and all of the originals frames (less bees) placed back into the hive.**

Some of the bees will be there waiting for you. These are the older foraging bees (not the younger laying workers). Be careful not to squash any bees as you slide the hive back onto the bottom board.

Most of these older foraging bees will find their way back to the hive. But the young nurse bees, the ones that have been laying eggs, have never ventured out of the hive before. They will be lost in the grass where you deposited them and will never find their way back to the hive.

Now you can safely introduce your new queen. See the instructions earlier in this chapter.



There are rare occasions when a queen will lay nothing but drone eggs. This happens when a new queen does not successfully mate. Queens that do not mate (or older queens that use up their stored sperm) can only produce unfertilized (drone) eggs. Such queens are termed drone layers. Such colonies are doomed, since foraging workers are needed to survive, and fertilized eggs are necessary to raise a replacement queen.

Preventing Pesticide Poisoning

With what we are finding out about Colony Collapse Disorder and its potential relationship to pesticides, we can't be too careful when it comes to pesticide use. I get upset when I see people spraying their lawns and trees with pesticides. These chemicals may make for showcase lawns and specimen foliage, but they are no good for the water table, birds, and other critters. Some of these treatments are deadly to bees. (*Note:* I'm not talking about fertilizers, just pesticides here.) If you ever see a huge pile of dead bees in front of your hive, you can be pretty sure that your girls were the victims of pesticide poisoning. Here are a few things you can do to avoid such a tragedy:

- ✓ Let your neighbors know that you are keeping bees. Make sure that they know how beneficial pollinating bees are to the community and ecology. Explain to them the devastating effect that pesticide spraying can have on a colony. They may think twice about doing it at all. If they must spray, urge them to do so at dawn or dusk, when the bees are not foraging. Encourage your neighbors to call you the day before they plan to spray. With advance warning, you can protect your bees.



- ✓ On the day your neighbors plan to spray, cover your hive with a bed sheet that you have saturated with water. Let it drape to the ground. The sheet will minimize the number of bees that fly that day. Remove the sheet the following morning after the danger has passed.

Alternatively you can screen the entrance the night before the spraying and keep the girls at home the entire day. Remove the screen and let them fly the next day.
- ✓ Register your colony with the state apicultural office or agricultural experiment station. You may have to pay a minimal charge for registration. Each state publishes a list of all registered beekeepers in the state. Reputable arborists check such lists before spraying in a community. If you are on the list, they will call you before they spray in your area.

The Killer Bee Phenomenon

The media has had a ball with the so-called *killer bees*. These nasty-tempered bees have been fodder for fantastic headlines and low-budget horror movies. At the same time, this kind of publicity has had a negative and unwelcome impact on backyard beekeeping. The resulting fear in the community can make it difficult for a beekeeper to gain the support and acceptance of his or her neighbors. Moreover, sensational headlines have resulted in sensational legislation against keeping bees in some communities. The public has been put on guard. Killer bees present another problem for the beekeeper as well: If your area has them, you must manage your colony carefully to prevent your own bees from hybridizing and becoming more aggressive.

What are “killer bees”?

First of all, let’s get the name correct. The bees with the bad PR are actually Africanized Honey Bees (AHB) — or *Apis mellifera scutellata* if you want to get technical. The “killer bee” pseudonym was the doing of our friends in the media.

How did the AHB problem come about? It all started in 1956 in Brazil. A group of scientists was experimenting with breeding a new hybrid resulting in superior honey production. They were breeding the notoriously aggressive honey bee from Africa with the far more docile European honey bee. But a little accident happened. Some African queen bees escaped into the jungles of Brazil. The testy queens interbred with European bees in the area, and voilà — the AHB become a force to deal with.

A “bee” movie

Hollywood producer Irwin Allen is the king of the disaster movies. In his movie *The Swarm*, great clouds of “killer bees” attack entire cities and leave hundreds dead in their wake. It was a disaster movie in more ways than one. As a business venture, it tanked at the box office. As a public relations vehicle for beekeepers, it

fueled a fire of fear in the minds of the public. Despite what we see in movies like this, these bees do not fly out in angry swarms to randomly attack victims. But they are extremely protective of their hives should you venture too near or disturb them.

Outwardly, AHBs look just like European honey bees. In fact, you must take a peek under the microscope or do a DNA test to detect the difference. Their venom is no more powerful. And like our sweet bees, they too die after inflicting a sting. The main and most infamous difference is their temperament. They are very defensive of their hives, are quick to attack, will chase an intruder long distances, and stay angry for days after an incident.

There have been reports of human deaths resulting from attacks by AHBs. But these reports are rare and almost always involve elderly victims who have been unable to fend off the attackers. The media can put quite a sensational spin on such tragedies, and that has contributed to some bad PR for honey bees in general.

My friend Kate Solomon worked for several years in the Peace Corps teaching Brazilian beekeepers how to work with the AHB. Kate’s efforts (and yes, she puts cotton in her nose and ears to keep unwanted explorers at bay!) resulted in not a single sting from these “killer bees.”

Bee prepared!

In the half-century since “the accident” in Brazil, AHBs have been making their way northward to the United States. In 1990, the first colonies of AHBs were identified in southern Texas. As of this writing, they have been verified in quite a number of the southern states. There is speculation as to how far north these bees are capable of surviving (after all, they are a tropical species). In any event, they have arrived amid great publicity. Beekeepers and the public will have to learn how to deal with them. For an up-to-date map of the progress, go online to www.usda.gov and search “Africanized Bees”.

An experiment that flopped

Despite the hopes of those Brazilian scientists over half a century ago, the AHB has turned out to be kind of a dud as compared to her European cousins:

- ✔ It is more difficult for beekeepers to manage.
- ✔ It defends in larger groups, inflicting many more stings.
- ✔ It swarms far more frequently.
- ✔ It doesn't produce appreciably more honey.
- ✔ It makes less wax.



Here are some helpful hints about safe beekeeping in areas known to be populated by AHBs:

- ✔ If you live in an area where AHBs have been seen, do not capture swarms or populate your hive with anything other than package bees from a reputable supplier. Otherwise, you may wind up with the hive from hell.
- ✔ If you are unlucky enough to disturb a colony of AHBs, don't stick around to see how many will sting you. Run in a straight line far away from the bees. AHB are fast flyers, and you will have your work cut out for you when you attempt to outrun them. Don't jump into water — they'll be waiting for you when you surface. Instead, enter a building and stay inside until things cool off.
- ✔ In the areas where the AHB has been introduced, diligent beekeepers are the community's best defense against the AHBs spread. By systematically inspecting her hive to spot her *marked* queen, a beekeeper knows that her colony remains pure. Only when an unfamiliar queen (perhaps an AHB) is introduced is the colony's genetic integrity at risk. More than ever, backyard beekeepers are needed to ensure that the AHB doesn't become a problem in any community.
- ✔ If you join a local bee club (and I highly recommend that you do), encourage the club to publish information educating the public about the benefits of beekeeping. Teach the community the real story about the AHB. Take positive steps to quell the fear that may lurk in some people's minds. Let them know how important it is to have beekeepers who can help control the spread of the AHB. A good education program is a beekeeper's best defense against local legislation restricting beekeeping in the community.

Chapter 10

Colony Collapse Disorder

In This Chapter

- ▶ Getting familiar with Colony Collapse Disorder (CCD)
- ▶ Understanding what the fuss is about
- ▶ Thinking about what might be causing CCD
- ▶ Getting answers to frequently asked questions
- ▶ Looking at ways you can help save honey bees

Special thanks to the USDA for its help with this chapter

Unless you have been living in a remote cabin on the side of a forgotten hill, you have likely noted that the media has been abuzz with news about “the vanishing bees.” The last few years have been unhappy ones for our bees. Since 2006, thousands upon thousands of honey bee colonies have been vanishing. Gone without a trace. Poof!

Colony Collapse Disorder (CCD) is the name that has been given to what seems to be the most serious die-off of honey bee colonies in decades. And to get right to the point, as of this writing, it is not known what is causing it.

Although this news is unhappy, don’t despair. Becoming a new beekeeper is one of the most useful things you can do to help save our lovely honey bees. More on what else you can do later in this chapter.

What Is CCD?

In the autumn of 2006, a beekeeper in Florida filed the first report of a sudden and unexplained disappearance of his bees. They didn’t die. They just packed up and left. Then more reports of heavy losses (mostly from commercial migratory beekeepers) quickly followed. During the next two years, some commercial beekeepers have reported losing 30–90 percent of their hives.

Like a firestorm, this tragedy has swept across nearly all of the United States, as well as some countries overseas. It has impacted both commercial beekeepers and hobbyists. It is a far-reaching problem that has serious consequences (see the section “Why All the Fuss?”).

CCD is characterized by the sudden and unexplained disappearance of all adult honey bees in the hive. A few young bees and perhaps the queen may remain. Or there may be no bees left. Honey and pollen are usually present, and there is often evidence of recent brood rearing. This abrupt evacuation is highly unusual, because bees are not inclined to leave a hive if there is brood present.

Another puzzling characteristic is that opportunists (such as robbing bees from other hives, wax moths, and small hive beetles) are very slow to invade colonies experiencing CCD. There are no adult bees present to guard the hive, lots of goodies to loot, and yet these invaders stay clear. Hmmm. What do they know that we don't?

The warning signs

Sometimes (rarely) bees abscond from a hive because conditions are too unpleasant to remain in the hive: too hot, too many pests, not enough food, no queen, and so on. (See Chapter 9.) But CCD is different from such absconding. There don't appear to be unfavorable conditions. And it's happening at an alarming rate.

Colonies that experience CCD have the following characteristics:

- ✓ All or nearly all of the bees disappear suddenly.
- ✓ There are no adult bees in the hive (although in some cases the queen and a small number of survivor bees are present in the brood nest) and there is or very little build-up of dead bees in the hive or at the hive entrances.
- ✓ Capped brood is left behind.
- ✓ There are pollen and capped honey.
- ✓ Empty hives are *not* quickly invaded by opportunists (robbing bees, wax moths, small hive beetle, and so on).

What to Do If You Suspect CCD?

Don't panic. As a new beekeeper you may be jumping to unwarranted conclusions. To date, CCD has been far more prevalent among commercial beekeepers than hobbyists like us.



If you are convinced you might have a problem, I urge you to contact your state bee inspector. He or she is best qualified to evaluate your diagnosis. Call your state's Agricultural Experiment Station and ask to be connected to the head bee inspector. He or she is likely to make a house call if you ask nicely.

Why All the Fuss?

The media is all over this story. It's even hit the evening national news. Why is CCD making headlines? Imagine a world without bees. That would be an unhappy world. Did you know that honey bees account for 30 percent of everything you eat? Commercial beekeepers provide honey bees to farmers all around the country to pollinate the crops that wind up in our supermarkets. If these pollinating mavericks were all to disappear, there would be less crops and higher prices in your grocery store. No question about it. Honey bees are critical for agricultural pollination — adding more than \$15 billion in value to about 130 crops — especially crops like berries, nuts, fruits, and vegetables. The unexplained disappearance of so many colonies is not a matter to take lightly. Table 10-1 summarizes some of the consequences of a world without bees.

Table 10-1		
Pollination Experiments		
<i>Crop</i>	<i>Without Honey Bees</i>	<i>With Honey Bees</i>
Pears	99 lbs. fruit	344 lbs. fruit
Alfalfa	62 lbs. seed per acre	220 lbs. seed per acre
Apples	25 apples per tree	1,200 apples per tree

Experiment results showing comparison of crops pollinated by honey bees versus the same crops netted to prevent pollination. Source: W.R. Roach Company Orchards and other sources.

What's Causing CCD?

The short answer is — we don't know. At least not at the time of this writing. But researchers have managed to dismiss some "wild" theories and are now focusing in on other more probable causes.

The cell phone theory

There was a well-publicized theory that it was the explosion of cell phone usage that was causing CCD. Could it be? The short answer is no.

There was a very small study done in Germany that looked at whether a particular type of base station for mobile phones could screw-up honey bee navigation. But, despite all the media attention that this study received, it had nothing to do with CCD. The researcher who conducted the study told the Associated Press that there is “no link between our tiny little study and the CCD-phenomenon . . . anything else said or written is a lie.” The scientists studying CCD agree. Case closed.

It may be the perfect storm

Far more likely it is not one single thing that is causing CCD, but rather a brew of many different challenges that have contributed to this problem. In a nutshell, there are four classes of potential causes that are being studied by scientists around the world: parasites (such as mites); pathogens (disease); environmental stresses (which include pesticides); and management stresses (including nutrition problems). If CCD is a combination of factors, it makes investigating the root cause especially complex. There are so many variables!

Although this is not a complete list of what’s being studied, here are some of the more significant ingredients to this dire cocktail.

Parasites

The spread of *Varroa* and tracheal mites has certainly seriously impacted honey bee health in the United States and around the world. It has nearly wiped out honey bees in the wild (feral hives). The mites have put a major stress on our honey bees and could certainly make our girls far more susceptible to some of the other causes being studied.

Pathogens

In Chapter 11 I talk about bee viruses. While there are many different viruses that can impact honey bee health, there is one in particular being studied in connection with CCD: Israeli Acute Paralysis Virus (IAPV). This particular virus is not necessarily the cause of CCD, but is more likely one ingredient to that cocktail that might trigger CCD. This research is being headed by Dr. Diana Cox-Foster at Penn State College of Agricultural Sciences. For the most up-to-date information on the potential connection between CCD and IAPV, visit <http://cas.psu.edu/>.

Pesticides

Researchers have found higher-than-expected levels of miticides (used and sometimes misused by beekeepers to control mites) plus traces of a wide variety of agricultural chemicals in the pollen and wax of inspected hives.

Some believe that pesticides, especially a relatively new class called neonicotinoids, are responsible for CCD. Most neonicotinoids are known to be toxic to bees. They can impair olfaction memory, motor activity feeding behavior, and the bees' navigation and orientation. Neonicotinoids and some fungicides are synergistic, resulting in a far more toxic situation. All in all, this is some nasty stuff. Pesticide involvement in CCD remains a possibility that has not been ruled out.

Other possibilities

There are a host of other possible causes now under study, including the following:

- ✓ Nutritional fitness of the adult bees
- ✓ Level of stress in adult bees as indicated by stress-induced proteins
- ✓ The use of honey bee antibiotics (especially new products in the market)
- ✓ Feeding bees high-fructose corn syrup (as is common with commercial beekeepers)
- ✓ Availability and quality of natural food sources
- ✓ Lack of genetic diversity and lineage of bees

Answers to FAQs

Is honey from CCD colonies safe to eat? To date there is no evidence that CCD affects honey. The impact of CCD appears to be limited to adult bees.

Is it safe to reuse the equipment from colonies that are lost during the winter? If it can be determined that the bees starved or died due to other reasons associated with typical winter loss (e.g., mites), it is completely safe to reuse equipment, including the remaining honey and pollen. However if your colonies died from what appears to be CCD, reusing equipment is not a good idea. Play it safe and store this equipment in a safe place until we know more about CCD and the associated causes.

Who is working on this problem? There is an army of researchers, apiculture extension specialists, and government officials who have come together to work on CCD. This group is called the CCD Working Group. For a complete list of the institutions and individuals involved, and for up-to-date information on the research, visit the Web site: www.MAAREC.org. Additional information can be found at the Web site for the United States Department of Agriculture: www.usda.gov/wps/portal/usdahome.

What You Can Do to Help

There are a lot of things you can do to fend-off CCD in your neck of the woods. Although we don't yet know the actual causes of CCD, here are some sensible actions you can take immediately.

- ✔ Become a beekeeper! What a great way to reintroduce honey bees in your area. Hopefully this book will get you started.
- ✔ Keep colonies strong by practicing best management practices. In other words, follow the steps in this book religiously!
- ✔ Feed colonies Fumigillin in the spring and autumn to prevent Nosema. Although *Nosema apis* is not considered the cause of CCD, its presence can create stress factors that might promote CCD. See chapter 11.
- ✔ Replace old comb with new foundation every one to two years. This will minimize the amount of residual chemicals that might be present in old wax.
- ✔ Avoid introducing stress to your colonies (provide adequate ventilation; feed your bees when pollen and nectar are scarce; keep mite infestations in check; medicate against Nosema).
- ✔ Do not reuse the equipment if the colony displayed symptoms of CCD. Such equipment should be stored until CCD is understood better.
- ✔ If you treat your colonies with an antibiotic to prevent or control American or European foulbrood, use Terramycin rather than Tylan. Tylan is new on the market and does not have a long track record. Terramycin has a longer history of safe use in bee colonies. See chapter 11
- ✔ Monitor Varroa mite populations and take steps to treat your colony when mite levels become unacceptable.
- ✔ Consider using an integrated pest management (IPM) approach for Varroa control in honey bee colonies. This approach can minimize the need for chemical use in your hives and lessens the bees' exposure to chemicals (see sidebar).
- ✔ Avoid the use of chemicals and pesticides in your garden and on your lawn. The use and misuse of pesticides is on the short list of factors that might be harming honey bees. Limit the use of these chemicals, or better yet, go au natural (after all, Dandelion lawns can be very beautiful). Convince your neighbors to do the same.
- ✔ Plant a bee-friendly garden. Good nutrition is vital to the overall health of the colony.
- ✔ Write your Congressional representatives. Funding for honey bee research is more critical than ever. Let the feds know you care about our precious honey bees.

A Final Word

Don't let all this gloomy news prevent your enjoyment as a beekeeper. Although CCD is a serious concern for our honey bees, I am confident that remedies will be forthcoming. As mentioned earlier, becoming a backyard beekeeper is the single best thing you can do to help our honey bees. Embrace and enjoy this glorious hobby, and feel good about helping the honey bee get back on its feet. All six of them.

What Is IPM?

The idea of IPM (integrated pest management) is to manage honey bee pests (such as wax moths and Varroa and tracheal mites) by the minimal use of chemicals. The key word is “manage”, not necessarily to eliminate the pests. Some general rules of thumb:

- ✔ Prevention is better than attempting a cure—just do what's needed to help the bees help themselves.
- ✔ Monitor, sample, and test regularly to make sound decisions.
- ✔ Use soft (non-chemical) treatments whenever possible.
- ✔ Use hard treatments (medications and chemicals) when only absolutely necessary.
- ✔ Practice rotational use of chemicals to avoid pests developing resistance.

A whole book could be devoted to the nuances of IPM, but there are many examples of IPM

scattered throughout this book. Consider the following as IPM best-practice techniques:

- ✔ Placing supers in the freezer prior to storage to kill wax moth larvae and pupa.
- ✔ Using screened bottom boards to monitor and manage Varroa populations.
- ✔ Dusting the colony with powdered sugar to knock mites off the bees.
- ✔ Developing resistant bee stock by raising your own queens from your heartiest colonies.
- ✔ Using drone comb to capture and remove Varroa mites.
- ✔ Using “soft” chemicals for mite control, such as essential oils, menthol, grease patties.
- ✔ Replacing old wax comb with new foundation every two to three years.
- ✔ Placing metal mouse guards at the entrance of the hive.

Chapter 11

Diseases and Remedies

In This Chapter

- ▶ Deciding to medicate
 - ▶ Preventing problems before they happen
 - ▶ Recognizing the first signs of trouble
 - ▶ Nursing sick bees back to good health
-

I won't pretend otherwise — this is *not* the fun part of beekeeping. I'd much rather never have to think about my bees getting sick. My heart aches when they do. Nothing is more devastating than losing a colony to disease. But let's get real. Honey bees, like any other living creatures, are susceptible to illness. Although some of these diseases aren't too serious, some can be devastating. The good news is that you can prevent many honey bee health problems *before* they happen, and you can often head off disaster if you know the early signs of trouble.

Right away let me clear up one thing. None of the health problems that affect bees have any impact on human health. These diseases are 100-percent unique to your bees. They're not harmful or contagious in any way to you or your family. Phew! That's a relief!

In this chapter I've highlighted the most common health problems that your bees may face. As you inspect your hives, look carefully at the capped and open brood cells (what's going on in these cells is often the barometer of your colony's health). Discover how to recognize the telltale indications of health problems.

Medicating or Not?

I know what you're thinking. Should you put medication in your hive or not? Wouldn't keeping everything natural and avoiding the use of any chemicals, medications, or antibiotics be better? Maybe you can even save a few dollars? Well, perhaps the answer to that question depends on your practice in other areas. Do you avoid taking your dog to the vet for distemper shots and heartworm pills? Do you send your kids off to school without their vaccines?

Probably not. Bees are no different. Without some help from you, I can assure you they'll eventually have a problem. You may even run the risk of losing your hive entirely. Don't risk it. Follow a sensible annual medication regime and look carefully for signs of trouble every time you inspect your colony.



Remember that you should never ever medicate your bees when you have honey on the hive that is intended for human consumption. Medicate *before* honey supers go on the hive, or *after* they are removed. For a description of honey supers and their use, see Chapter 4.

Knowing the Big Six Bee Diseases

You should be on the lookout for six honey bee diseases. Some are rare, and it's doubtful that you'll ever encounter them. Some are more commonplace (like Nosema and chalkbrood) and knowing what to do if they come knocking is important. Some, like American foulbrood, are very serious, and you need to know how to recognize and deal with them.



Each time you inspect your bees, you're looking for two things: evidence of the queen (look for eggs) and evidence of health problems (look for the symptoms I describe below).

American foulbrood (AFB)

I'll start with the worst of the lot. American foulbrood (AFB) is a nasty bacterial disease that attacks larvae and pupae. This serious threat is highly contagious to bees (not people) and, left unchecked, is certain to kill your entire colony. It's the most terrible of the bee diseases. Some symptoms are

- ✓ Infected larvae change color from a healthy pearly white to tan or dark brown and die *after* they're capped.
- ✓ Cappings of dead brood sink inward (becoming concave) and often appear perforated with tiny holes.
- ✓ The capped brood pattern no longer is compact, but becomes spotty and random. This is sometimes referred to as a "shotgun" pattern (see this book's color-photo section).
- ✓ The surface of the cappings may appear wet or greasy.



If you see these conditions, confirm that it's AFB by thrusting a toothpick or matchstick into the dead brood, mixing it around, and then *slowly* withdrawing the toothpick. Observe the material that is being drawn out of the cell as you withdraw the toothpick. Brood killed by AFB will be stringy and will *rope*

out about ¼ inch (like pulling taffy) and then snap back like a rubber band (see “Spotting Problems” in this book’s color-photo section). That test can confirm the presence of AFB. Also take a close look at the dead pupae. Some may have tongues protruded at a right angle to the cell wall. There may also be a telltale odor associated with this disease. Most describe it as an unpleasant “foul” smell (like a pot of old-fashioned horse glue). If you suspect a foul smell, and that smell lingers in your nose after leaving the hive, your bees might have AFB.

If you suspect that your bees actually *have* AFB, immediately ask your state bee inspector to check your diagnosis. Treatment for AFB is subject to state law in the United States. If AFB is present, it is likely that your hives and equipment will have to be burned and destroyed. Why such drastic measures? Sleeping spores of AFB can remain active (even on old unused equipment) for up to 70 years.

You can help prevent the onset on AFB by treating your colonies in the spring and autumn with antibiotics approved for use with honey bees. There are two products currently on the market: Tylan (tylosin tartrate) and Terramycin (oxy-tetracycline). These medications are available from bee equipment suppliers. To administer, carefully follow the instructions on the product package.



Never purchase old, used equipment. No matter how tempting the offer may be — no matter how well you know the seller. If the bees that once lived in that hive ever had AFB, the disease-causing spores remain in the equipment for decades. No amount of scrubbing, washing, sanding or cleaning can remedy the situation. Please start your new adventure in beekeeping by purchasing new and hygienic equipment.

European foulbrood (EFB)

European foulbrood (EFB) is a bacterial disease of larvae. Unlike AFB, larvae infected with EFB die *before* they’re capped. Symptoms of EFB include the following:

- ✓ Very spotty brood pattern (many empty cells scattered among the capped brood). This is sometimes referred to as a “shotgun” pattern.
- ✓ Infected larvae are twisted in the bottoms of their cells like an inverted corkscrew. The larvae are either a light tan or brown color, and have a smooth “melted” appearance. Remember that normal, healthy larvae are a glistening, bright white color.
- ✓ With EFB, nearly all of the larvae die in their cells before they are capped. This makes it easy for you to see the discolored larvae.

- ✓ Capped cells may be sunken in and perforated, but the “toothpick test” won’t result in the telltale ropy trail as described above for AFB.
- ✓ A sour odor may be present (but not as foul as AFB).



Here’s the best way to view frames for diseased larvae. Hold the frame by the ends of the top bar. Stand with your back to the sun and the light shining over your shoulder and down into the cells. The frame should be sharply angled so you are looking at the true *bottom* of the cell. Most new beekeepers interpret the “bottom” as the midrib of the comb. It isn’t. The true bottom of the cell is the lower wall of the cell (the wall that’s closest to the hive’s bottom board when the frame is hanging in the hive). Because EFB bacteria don’t form persistent spores, this disease isn’t as dangerous as AFB. Colonies with EFB sometimes recover by themselves after a good nectar flow begins. Although serious, EFB is *not* as devastating as AFB and can be successfully prevented or treated with antibiotics.

Prophylactically (preventively) treating colonies in the spring and autumn with Terramycin or Tylan can help prevent EFB (see Chapter 9). If you’ve detected EFB, requeen your colony (replace the old queen with a new one; see Chapter 9) to break the brood cycle and allow the colony time to remove infected larvae. Help the bees out, and remove as many of the infected larvae as you can using a pair of tweezers. Treat the colony with Tylan or Terramycin following the instructions on the package.



It’s a good hygienic practice to replace all of the frames and comb in your hives every few years. There are a couple of compelling reasons for doing this: Replacing old frames minimizes the spread of disease; old wax can contain residual medication from past treatments — building resistance and making medication treatments ineffective when needed.

New medications on the horizon

With Colony Collapse Disorder in the news (see Chapter 10), the honey bee has become quite a celebrity. Its value to our economy is well recognized, and there is much research underway to save these little creatures. There are new

medications and treatments being tested and developed as I write. I urge you to subscribe to one or more of the bee journals to keep tabs on these new developments regarding honey bee health.

Nosema

Nosema, a common protozoan disease that affects the intestinal tracks of adult bees, is kind of like dysentery in humans. It can weaken a hive and reduce honey production by between 40 and 50 percent. It can even wipe out a colony of bees. It's most common in spring after bees have been confined to the hive during the winter. The problem is, that by the time the symptoms are visible, it has gone too far and is difficult or impossible to treat. Some symptoms of Nosema are

- ✓ In the spring, infected colonies build up slowly or perhaps not at all.
- ✓ Bees appear weak and may shiver and crawl aimlessly around the front of the hive.
- ✓ The hive has a characteristic *spotting*, which refers to streaks of mustard-brown feces that appear in and on the hive.

You can discourage Nosema by selecting hive sites that have good airflow and a nearby source of fresh, clean water. Avoid damp, cold conditions that can encourage Nosema. Provide your hives with full or dappled sunlight. Creating an upper entrance for the bees during winter improves ventilation and discourages Nosema. Purchase your bees and queens from reputable suppliers who treat their bees with antibiotics to minimize infection.

Medicate for Nosema prophylactically (preventively) by feeding Fumigilin (an antibiotic) in sugar syrup in the spring and fall. See Chapter 8 for how to prepare and feed medicated sugar syrups.



You should add Fumigilin-B to the first two gallons of sugar syrup that you feed your bees in the spring. Also medicate the first two gallons you feed them in the autumn (see Chapter 8). Any additional gallons of syrup you feed to the bees are not medicated.

Chalkbrood

Chalkbrood is a common fungal disease that affects bee larvae. Chalkbrood pops up most frequently during damp conditions in early spring. It is rather common and usually not that serious. Infected larvae turn a chalky white color, become hard, and may occasionally turn black. You may not even know that your bees have it until you spot the chalky carcasses on the hive's "front porch." Worker bees on "undertaker duty" attempt to remove the chalkbrood as quickly as possible, often dropping their heavy loads at the entrance or on the ground in front of the hive.



Misdiagnosing this disease is common, because it's easily confused with chilled brood (see Chapter 9). You see carcasses at the hive entrance with both anomalies, but with chalkbrood, the bodies are hard and chalky (not soft and translucent as is true with chilled brood).

No medical treatment is necessary for chalkbrood. Your colony should recover okay on its own. But you can help them out by removing mummified carcasses from the hive's entrance and from the ground around the hive. Also, usually one frame will have most of the chalkbrood cells. Remove this frame from the hive and replace it with a new frame and foundation. This action minimizes the bees' job of cleaning up. Also consider replacing your queen by ordering a new one from your bee supplier (or by providing one of your own if you are raising queens — see Chapter 13.) Your help quickly arrests the spread of the fungus.

Sacbrood

Sacbrood is a viral disease of brood similar to a common cold. It isn't considered a serious threat to the colony. Infected larvae turn yellow and eventually dark brown. They're easily removed from their cells, because they appear to be in a water-filled sack. Now you know where the name comes from.

No recommended medical treatment exists for sacbrood. But you can shorten the duration of this condition by removing the sacs with a pair of tweezers. Other than that intervention, let the bees slug it out for themselves.



Do your best to keep your bees free of stressful problems (mites, poor ventilation, crowded conditions) and they'll have an easier time staying healthy and avoiding disease. Be sure to feed them sugar syrup and pollen substitute in the spring and sugar syrup in the autumn.

Stonebrood

Stonebrood is a fungal disease that affects larvae and pupae. It is rare and doesn't often show up. Stonebrood causes the mummification of brood. Mummies are hard and solid (not sponge-like and chalky as with chalkbrood). Some brood may become covered with a powdery green fungus.

Honey bee viruses

Adult honey bees may occasionally fall prey to various different kinds of viruses. Sacbrood is one such viral disease. But there are quite a few others that impact honey bees. Viruses aren't easily detected and are often overlooked by beekeepers. Some researchers are exploring a link between viruses and Colony Collapse Disorder (see Chapter 10). Perhaps the most easily recognized virus is *chronic bee paralysis*, which causes workers to become greasy looking, hairless, and uniformly black in color. Sick bees are seen crawling on the grass in front of the hive, simply unable to fly.

Note: Colonies infested with mites (see Chapter 12) are far more susceptible to viral diseases, because open wounds created by mites are an invitation to infection.

The subject of bee viruses is a fast moving target, with new developments and discoveries taking place every year. I urge you subscribe to one or more of the bee journals to keep tabs on developments regarding honey bee health.

No medical treatment exists for honey bee viruses, but if you know your bees have a virus, you can help. One by one, remove each frame from the hive and carry it 10 to 20 feet away. Now shake all the bees off the frame and return it (empty) to the hive. Do this for all frames. The sick bees will not be able to return to the hive. The healthy ones will have no trouble making it home.

No medical treatment is recommended for stonebrood. In most instances worker bees remove dead brood, and the colony recovers on its own. You can help things along by cleaning up mummies at the entrance and around the hive, and removing heavily infested frames (see treatment for chalkbrood).



If you have more than one hive, think twice before shaking sick bees onto the ground and exposing other healthy bees to the problem.

A handy chart

Table 11-1 gives you a quick overview of the big six bee diseases, their causes, and their distinguishable symptoms. It contains a description of a healthy bee colony for comparison purposes.

Table 11-1 Honey Bee Health at a Glance

<i>Situation/ Disease</i>	<i>What Causes It?</i>	<i>Appearance of Brood</i>	<i>Appearance of Cappings</i>	<i>Appearance of Dead Larvae</i>	<i>Color and Consistency of Larvae</i>	<i>How Does It Smell?</i>
Normal, healthy brood and bees	The result of terrific beekeeping!	Tight pattern of sealed and open brood cells	Light tan, brown color, slightly convex	No dead larvae	Plump, bright white, wet, pearly appearance	Fresh sweet smell (or no smell at all)
American foulbrood (AFB)	A bacterium (spore forming)	Scattered, spotty brood pattern	Sunken, perforated, discolored, greasy appearance	Flat and fluid-like on bottom of cell. Tongue extended up to the roof of the cell.	Brown, dull, sticky and ropy	Unpleasant, sharp, foul smell
Chalkbrood	A fungus	Scattered, spotty brood pattern	Sunken, perforated, discolored	Most often in sealed or perforated cells	White and moldy, later white, gray or black, hard and chalk-like	Normal
European foulbrood (early stages)	A bacterium	Scattered, spotty brood pattern	Some discolored, sunken, perforated	In unsealed cells, in twisted positions	Yellowish, tan or brown	Sour

Situation/ Disease	What Causes It?	Appearance of Brood	Appearance of Cappings	Appearance of Dead Larvae	Color and Consistency of Larvae	How Does It Smell?
European foulbrood (advanced stage)	A bacterium	Scattered, spotty brood pattern	Discolored, sunken, per- forated	In unsealed and sealed cells, in twisted positions	Brown, but not ropy or sticky	Sour
Sacbrood	A virus	Scattered brood pat- tern. Many unsealed cells	Often dark and sunken, many perfo- rated	Most often with head raised	Grayish to black, skin has a watery, sack-like appearance	Sour or no smell
Stonebrood	A fungus	Affected brood are usually white, but can sometimes have a greenish, moldy appearance	Some cap- pings are perforated and covered with a green- ish mold	In unsealed and sealed cells	Green- yellow, or white, hard and shrunken	Moldy

Chapter 12

Honey Bee Pests

In This Chapter

- ▶ Getting to know some common pests
 - ▶ Recognizing and preventing potential problems
 - ▶ Treating your colony when the going gets tough
 - ▶ Utilizing some holistic alternatives to modern medicine
 - ▶ Keeping out some furry nonfriends
-

Even healthy bee colonies can run into trouble every now and then. Critters (four-legged and multilegged) can create problems for your hives. Anticipating such trouble can head off disaster. And if any of these pests get the better of your colony, you'll need to know what steps to take to prevent things from getting worse.

In this chapter I introduce you to a few of the most common pests of the honey bee, and what you must do to prevent catastrophe.

Parasitic Mites

Two little mites have gotten a lot of publicity in recent years about big problems they've created for honey bees: the Varroa mite and the tracheal mite. These parasites have become unwelcome facts of life for beekeepers, changing the way they care for their bees. You need to be aware of these pests and find out how to control them. Doing *nothing* to protect your bees from mites is like playing a game of Russian roulette.

Varroa mites

Somehow this little pest (*Varroa destructor*) has made its way from Asia to all parts of the world, with the exception of Hawaii. Varroa has been in the United States since the late 1980s (maybe longer) and has created quite a



problem for beekeepers. Resembling a small tick, this mite is about the size of a pinhead and is visible to the naked eye. Like a tick, the adult female mite attaches herself to a bee and feeds on its blood (*hemolymph fluid*).

Hemolymph fluid is the “blood” of arthropods. It is the fluid that circulates in the body cavity of an insect, and carries oxygen like mammal blood does.

Mites attached to foraging worker bees enable the infestation to spread from one hive to another. The Varroa mite is strongly attracted to the scent of drone larvae, but it also invades other brood cells just before they’re capped over by the bees. Within the cells Varroa mites feed on the developing bees and lay eggs. They reproduce at a fantastic rate and cause a great deal of stress to the colony. The health of the colony can weaken to a point that bees become highly susceptible to viruses. Within a couple of seasons, the entire colony can be wiped out. See Figure 12-1.

Figure 12-1:

Varroa mites can seriously weaken a hive by attaching to bees and feeding on their hemolymph (blood).

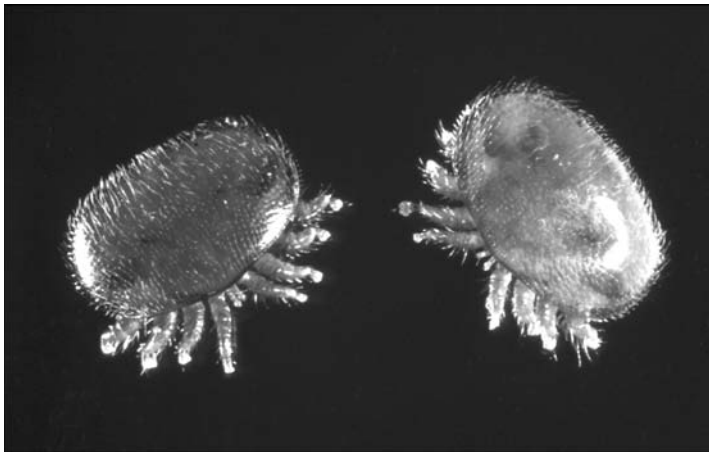

Courtesy of United States Department of Agriculture

Recognizing Varroa mite symptoms

How do you know if your colony has a serious infestation of Varroa mites? Following is a list of some Varroa mite symptoms. If you suspect a Varroa infestation, confirm your diagnosis using one of the surefire detection techniques I describe in the next section.

- ✔ **Do you see brown or reddish spots on the white larvae?** You may be seeing mites.
- ✔ **Are any of the newly emerged bees badly deformed?** You may notice some bees with stunted abdomens and deformed wings.
- ✔ **Do you actually see Varroa on adult bees?** They’re usually found behind the head or nestled between the bee’s abdominal segments.



Finding mites on adult bees indicates a *heavy* infestation. The mites head for bee larvae first (before the larvae are capped and develop into pupae). They then feed on capped pupae. It doesn't take much to figure out that by the time the mites are prevalent on adult bees, the mite population is quite high.

- ✓ **Did your colony suddenly die in late autumn?** Oops! You're way too late to solve the problem this year. You'll have to start fresh with a new colony next spring.

Utilizing two surefire detection techniques for Varroa

If you suspect a Varroa mite problem, then, by all means, confirm your diagnosis by using either the powdered sugar shake method or the drone brood inspection method. But performing one of these detection techniques before you suspect a problem is best. Varroa detection needs to be a routine part of your inspection schedule. I suggest using the powdered sugar shake method twice a year — once in the early spring, and once in the late summer.

Powdered sugar shake method

The powdered sugar shake technique is my favorite method for detecting Varroa. It is effective and nondestructive (no bees are killed in the process). You use this process in the early spring (before honey supers go on) and again in the late summer (before the honey supers come off). Follow these steps:

1. **Obtain a one pint wide-mouthed glass jar (the kind mayonnaise comes in) and modify the lid so that it has a coarse screen insert. Just cut out the center of the lid and tape or glue a wire screen over the opening (see Figure 12-2).**
Hardware cloth (eight wires to the inch) works well. Now you have something resembling a jumbo saltshaker.
2. **Put 3 to 4 tablespoons of powdered sugar (confectioners' sugar) into the jar. Alternatively you can use granulated sugar.**
3. **Scoop up about half a cup of live bees (about 200 to 300) from the brood nest and place them in the jar. Be careful that you don't scoop up the queen! Screw on the perforated lid.**
4. **Cover the screened lid with one hand (to keep the sugar from spilling out) and shake the jar vigorously (like a bartender making a martini).**

This action doesn't really harm the bees, but it sure wakes them up!

5. **Shake the sugar through the screened top and onto a white sheet of paper. Open the top and let the bees fly home (you may want to stand to the side as they will be rather unhappy). When the bees have departed, shake the rest of the sugar onto the paper.**



Shake authoritatively. Doing so dislodges any mites that are on the bees. The mites can easily be counted, contrasted against the white paper and powdered sugar.

Figure 12-2:
This jar's lid
has been
modified for
a powdered
sugar shake
mite
inspection.



If you count ten or more mites, you should proceed with the recommended treatment (see the “Knowing how to control Varroa mite problems” later in this chapter). Seeing many dozens of mites means the infestation has become significant. Take remedial action fast!



Bees can be returned unharmed to the hive using this technique. Although they may be coated with sugar, their sisters nevertheless have a grand time licking them clean. Just wait 10 to 15 minutes to let them calm down before releasing them. All that jostling can make them understandably irritable.

Drone brood inspection method

Regrettably, the drone brood inspection method kills some of the drone brood. I prefer the sugar shake method for that reason alone. If you choose this drone brood inspection technique, follow these steps:

1. Find a frame with a large patch of capped *drone* brood.

They are the larger capped brood with slightly dome-shaped cappings. Shake all the bees off the frame, and move to an area away from the hive where you can work undisturbed.

2. Using an uncapping fork (see Chapter 12), slide the prongs along the cappings spearing the top third of the cappings and impaling the drone pupae as you shovel across the frame. See Figure 12-3.

3. Pull the drone pupae straight out of their cells.

Any mites are clearly visible against the white pupae. Repeat the process to take a larger sampling. See Figure 12-4.

Two or more mites on a single pupa indicate a serious, heavy infestation. Two or three mites per 50 pupae indicate a low to moderate infestation. But remember, whenever you see *any* mites at all, it's time to consider taking action! (See "Knowing how to control Varroa mite problems" next.)

Figure 12-3:

Slide the prongs of an uncapping fork along the drone brood capings so you can check the pupae for varroa mites.



Courtesy of Stephen McDaniel

Figure 12-4:

Varroa mites first attach themselves to drone pupae, so that's a good place to look for evidence of an infestation. Can you see the mites on these pupae?



Courtesy of Stephen McDaniel

Evaluating the Varroa population using a screened bottom board

About 10 percent to 15 percent of Varroa mites routinely fall off the bees and drop to the bottom board. But if you use a screened bottom board (sometimes called a “sticky” board), the mites fall through the screen and onto a removable tacky white board.

When this white board is in place, mites fall through the screen and become stuck to the sheet (you apply a thin film of petroleum jelly or a cooking spray to the sheet to help the mites stick).

Just insert the sheet for a day or two and then remove it to count the mites. If the number of mites is more than 50, then appropriate control measures should be taken.



A screened bottom board is also an excellent way to improve ventilation in the hive.

Knowing how to control Varroa mite problems

A number of products and techniques are available that help reduce or even eliminate Varroa mites populations. Here are the ones that I suggest you consider and a few that I think you should avoid as a new beekeeper.



In recent years, it is a generally accepted practice *not* to medicate your bees unless you know it is necessary. Medicating your bees as a protective measure can actually diminish the effectiveness of medication when you absolutely, positively need it. The mites can build a resistance when medications are used too frequently.

Medication options

There are a few effective and approved *miticides* (chemicals that kill mites). One is fluvalinate, which is sold under the brand name, *Apistan*, and is available from your beekeeping supplier. Another is coumaphos (marketed as CheckMite+). Formic Acid is also used as a treatment for tracheal mites (sold in gel packs under the brand name Miteaway II). In addition there are “soft” (safer) chemicals such as thymol (marketed as Apiguard). When any of the detection techniques mentioned earlier in this chapter indicate Varroa mites, you must immediately treat with one of these treatments by carefully following the directions on the package.



Because Varroa mites can develop a resistance to these medications, it is prudent to alternate between two or more of these from one season to the next.

Apistan (fluvalinate)

Apistan is packaged as chemical-impregnated strips that look kind of like bookmarks. Hang two of the plastic strips in the brood chamber between second and third frames and the seventh and eighth frames (see Figure 12-5).

You're positioning the strips close to the brood so the bees naturally come into contact with the miticide they contain. The bees will brush up against each other and transfer the fluvalinate throughout the hive.



Following package directions precisely is important with any of the miticides listed in this chapter. The use of protective gloves is also recommended.



Figure 12-5:
Hanging
Apistan
strips.

Courtesy of Wellmark International



Never treat your bees with *any* kind of medication when you have honey supers on the hive. If you do, your honey becomes contaminated and cannot be used for human consumption. **Note:** Feeding medicated honey to the bees is, however, perfectly okay.

CheckMite+

Some mites have developed a resistance to Apistan, so new miticides have entered the market. CheckMite+ is a product manufactured by the Bayer Corporation (of aspirin fame). Like Apistan, it also consists of strips impregnated with a chemical miticide. But in the case of CheckMite+ the chemical is *coumaphos* — an ingredient used in deadly nerve gas. It's tricky to use safely. My advice? New beekeepers should steer clear of CheckMite+ until they gain experience.

Mite-Away II (Formic acid)

Formic acid is available in gel packs, but it is so caustic and tricky to administer that I don't suggest that new beekeepers use it, either.

Apiguard (Thymol)

Apiguard is a natural product specifically designed for use in beehives. It is a slow-release gel matrix, ensuring correct dosage of the active ingredient thymol. Thymol is a naturally occurring substance derived from the plant thyme. It is effective against the Varroa mite and is also active against both tracheal mite and chalkbrood. It is easy to use and much safer than formic acid or coumaphos. You might try alternating between Apistan and Apiguard if you need to treat your bees for Varroa mites.

Go au naturel!

You don't always have to use chemicals to deal with Varroa mites. Integrated pest management (IPM) is the practice of controlling honey bee pests with the minimal use of chemicals. See Chapter 10 for more on IPM. As it relates to controlling Varroa mites, here are a couple of non-chemical options to consider.

Use Drone Comb to Capture Varroa Mites. Bee suppliers sell a special “drone” foundation that has larger hexagons imprinted in the sheet. The bees will only build drone comb on these sheets. That's useful, because Varroa mites prefer drone brood over worker brood. By placing a frame of drone comb in each of your hives, you can “capture” and remove a many mites. Once the drone cells are capped, remove the frame and place it overnight in your freezer. This will kill the drone brood and also the mites that have invaded the cells. Then uncap the cells and place the frame (with the dead drone brood and dead mites back in the hive. The bees will clean it out (removing the dead drone brood and mites). The cells will get filled again, and you repeat the process.

Powdered Sugar Dusting to Control Varroa Mites. This involves dusting the bees with powdered sugar (note it's best to find a powdered sugar without added corn starch, although some claim this is not so critical. Play it safe and ask your bee supplies for a “pure” powdered sugar). The idea behind this technique is that the powdered sugar knocks many of the mites off the bees, and the mites fall down through the screened bottom board and perish in the grass below the hive (this assumes you are using an elevated hive stand and a screened bottom board with the insert removed). Use this method when you note a mite problem in your hive(s).

Here's the process:

1. **Sift a pound of powdered sugar using a baking flour sifter.** Do this twice to ensure no lumps. This should be done on a day with low humidity.
2. **Put the sifted sugar into an empty (and cleaned), baby powder container (alternatively you can improvise your own container).**
3. **Smoke and open the hive.** Remove frames one by one, and dust the bees with the sugar. The key operating word is “dusting” the bees . . . not coating them with loads of powdered sugar. You want to master a technique that makes light clouds of sugar dust — don't shake the sugar directly on the bees.
4. **Here's where a frame perch comes in handy (see Chapter 4).** Place the frame on the perch and do your dusting thing.
5. **Avoid dusting any open cells.** You just want to dust the backs of the bees.
6. **Put the dusted frame back into the hive and repeat this process with each frame.**
7. **When done, but a little extra dusting along all the top bars.**

This should be repeated once a week for two to three weeks.

Tracheal mites

Another mite that can create serious trouble for your bees is the tracheal mite (*Acarapis woodi*) shown in Figure 12-6. These little pests are much smaller than the period at the end of this sentence and can't be seen with the naked eye. Dissecting an adult bee and examining its trachea under magnification is the only way to identify a tracheal mite infestation.

As its name implies, this mite lives most of its life within the bee's trachea (breathing tubes), as shown in Figure 12-7. Mated female mites pass from one bee to another when the bees come in close contact with each other. Once the mite finds a newly emerged bee, she attaches to the young host and enters its tracheal tubes through one of the bee's spiracles — holes that are part of the respiratory system. Within the trachea the mite lays eggs and raises a new generation. The tracheal mite causes what once was referred to as *acarine disease* of the honey bee (a rather old-fashioned term not used much these days).



In my opinion, this mite causes more trouble for hobbyist beekeepers than Varroa. Early detection of bad infestations is difficult. As a result, tracheal mites can lead to the total loss of a colony before you're even aware that your bees are infested. Infestations are at their worst during winter months when

bees are less active. Her majesty isn't laying eggs, so no new bees are emerging to make up for attrition. Winter also is when beekeepers don't routinely inspect the colony. Thus, seemingly healthy colonies with plenty of food sometimes suddenly die during late winter or early spring.

Symptoms that may indicate tracheal mites

The only surefire way to detect tracheal mites involves dissecting a bee under a microscope — a little tricky for the novice, and not everyone has a dissection microscope in the hall closet. Whenever you suspect tracheal mites, call your state apiary inspector for information about how to have your bees inspected for tracheal mites.

A few clues may indicate the presence of tracheal mites. But the symptoms, listed below, are unreliable because they also may indicate other problems.

- ✔ **You see many weak bees stumbling around on the ground in front of the hive.** (This condition could also be an indication of Nosema disease; see Chapter 11.)
- ✔ **You spot some bees climbing up a stalk of grass to fly, but instead they just fall to the ground.** This happens because mites clog the trachea and deprive the bee of oxygen to its wing muscles.
- ✔ **You notice bees with *K-wings* (wings extended at odd angles — not folded in the normal position).** This also can be an indication of Nosema disease.
- ✔ **Bees abandon the hive (abscond) in early spring despite ample honey supplies.** This can happen even late in the fall when it's too late to remedy the situation and making the time right for ordering package bees and starting anew in the spring.

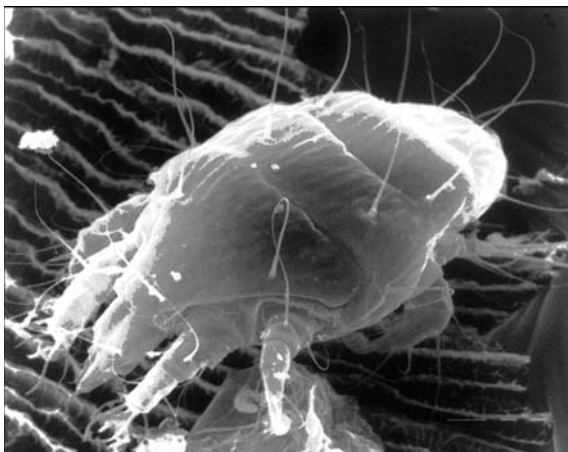
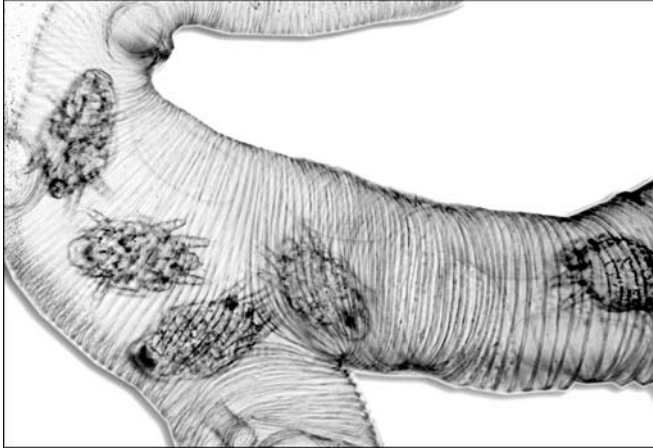

Figure 12-6:
An adult
tracheal
mite
(*Acarapis
woodi*).

Courtesy of United States Department of Agriculture

Figure 12-7:

Tracheal mites (seen in this magnified photo of an infected bee's tracheal tubes) are responsible for *acarine disease*, a serious threat to the health of bee colonies.



Courtesy of United States Department of Agriculture

How to control tracheal mite problems

Tracheal mite infestations are a problem, not a hopeless fate. You can take steps to use a number of techniques that I've listed in the following sections to prevent things from getting out of control. It isn't a case of just one technique working well. Play it safe by using a combination of some or all of these methods.

Menthol crystals

Menthol crystals are the same ingredient found in candies and cough drops. Menthol is derived from a plant, making it a natural alternative to chemical miticides. Prepackaged bags containing 1.8 ounces of menthol crystals are available from your beekeeping supplier.

Place a single packet on the top bars of the brood chamber toward the rear of the hive (see Figure 12-8). Setting the packet on a small piece of aluminum foil prevents the bees from chewing holes in the bag and carrying away the menthol. Bees are tidy and try their best to remove anything they don't think belongs in the hive. Leave the menthol in the hive for 14 *consecutive* days when the outdoor temperature is between 60 and 80 degrees F. The menthol vapors are effective only at these temperatures. That means the product is *temperature dependent* — you can only use it when the weather is warm.



Honey for human consumption must be taken off the hive whenever *any* medications are used. You can safely apply honey supers three to four weeks after medication is removed from the hive.

Figure 12-8:

In warm weather a packet of menthol placed on the top bars of the brood chamber helps control tracheal mites.



Sugar and grease patties

Placing patties of sugar and grease in the hive is a holistic treatment for tracheal mites that you can (and should) use year-round (even during the honey harvest season — unless you are adding the wintergreen oil option). As the bees feed on the sugar, they become coated with grease. The grease impairs the mite's ability to reproduce or latch onto the bees' hairs. Whatever the scientific reason, the treatment works effectively and is your number-one natural defense against tracheal mites.

Place one patty on the top bars of the brood chamber, flattening out the patty as needed to provide clearance for the inner cover and replacing it as the bees consume it. One patty should last a month or more.

Here's my recipe for grease patties:

1½ pounds of solid vegetable shortening (such as Crisco)

4 pounds of granulated sugar

½ pound honey

Optional: Add ⅓ cup of mineral salt (the orange/brown salt available at farm supply stores — it's used to feed to livestock). Pulverize the salt in a blender, breaking it into a fine consistency. The bees seem to like it.

Mix all these ingredients together until smooth. Form into about a dozen hamburger-size patties. Unused patties may be stored in a resealable plastic food bag and kept frozen until ready to use.

Winter patty replacement

Feed your bees sugar and grease patties all year round (they help control tracheal mites). These patties have no effect on the honey you will harvest. During the winter, on a sunny day with no wind, have a very quick peek under the

inner cover to see if you need to replace the patty. Chances are a patty placed on the hive in early November will last the bees over two to three months.

Note: As an option, you may add 45 milliliters (1.5 ounces) of natural wintergreen oil to the mixture, provided that you're not using this treatment while honey for human consumption is on the hive.

Essential oils

A number of interesting studies have tested the effectiveness of using essential oils as a means of controlling mite populations. Essential oils are those natural extracts derived from aromatic plants such as wintergreen, spearmint, lemon grass, and so on. These oils are available from health-food stores and companies that sell products for making soap.

Pioneering work on the use of essential oils in honey bee hives has been conducted by Bob Noel and Dr. Jim Amrine (West Virginia University). Their experimentation led to discoveries about the use of natural oils in killing off mite infestations in the hive without having any detrimental impact on the bees. A number of different ways exist for using essential oils in the hive.

For information and links to lots of sites devoted to Varroa and tracheal mite studies, visit Dr. Amrine's Web site: www.wvu.edu/~agexten/Varroa.

Miteaway II (Formic acid)

Formic acid is the stuff that I mentioned earlier in this chapter as a treatment option for Varroa mites. It also controls tracheal mites (especially when used in autumn). But formic acid is wickedly caustic, tricky to administer, and may not even be approved for use in your state. I don't suggest that new beekeepers use it. Gain some experience before you mess with it.

Apiguard (Thymol)

Apiguard was mentioned earlier in this chapter. It is effective against the Varroa mite and is also active against both tracheal mite and chalkbrood. It is easy to use and much safer than formic acid or coumaphos. As always, follow directions precisely.



Honey B Healthy

An all-natural product on the market that's well worth mentioning is Honey B Healthy. It contains pure essential oils (spearmint and lemon grass oils) and is sold as a concentrated food supplement (see figure that follows) that's added to the sugar syrup you feed your bees in the spring and autumn. It was developed by Bob Noel and Jim Amrine, pioneers in the use

of essential oils to control mite infestations. The manufacturers make no claims about Honey B Healthy's ability to kill mites, but field tests indicate that this product keeps bees healthy and strong even in the presence of *Varroa* and tracheal mites. I use it religiously, and urge you to give it a try. For more information about the product, visit www.bee-commerce.com.



Wax Moths

Wax moths can do large-scale damage in a weak hive (see the color section, of this book). But they don't usually become a problem in a strong and healthy hive, because bees continually patrol the hive and remove any wax moth larvae they find. If you see wax moths, therefore, you probably have a weak colony. So keeping your bees healthy is the best defense against wax moths. Once you have an infestation in a live colony of bees, there is nothing you can do to get rid of them. It's too late.

The story is different when comb is stored for winter. With no bees to protect these combs, the wax is highly susceptible to invasion by wax moths. But in this case, steps can be taken to keep the moths from destroying the combs over the winter. The use of PDB crystals (para dichlorobenzene) on stored supers and hive bodies can kill the moths and larvae that would otherwise destroy the wax (see Chapter 15 for more details).

Small Hive Beetle

More bad news for bees — besides the Africanized Honey Bees (AHB; see Chapter 9) — came in 1998 when the small hive beetle was discovered in Florida. Most common beetles that wander in and out of a hive are not a problem, so don't panic if you see some. But the small hive beetle, also originally from Africa, is an exception. The larvae of this beetle eat wax, pollen, honey, bee brood, and eggs. In other words, they gobble up nearly everything in sight. The beetles also — yuck! — defecate in the bees' honey, causing it to ferment and ooze out of the comb. Things can get so nasty that the entire colony may pack up and leave. Who can blame them?

Determining whether you have a small hive beetle problem

Be on the lookout for little black or dark brown beetles scurrying across combs or along the inner cover and bottom board (see Figure 12-9). You may even notice the creamy larvae on the combs and bottom board.

Figure 12-9:
The small hive beetle has become a significant problem for beekeepers in some states (mostly in the southeast).



Courtesy of Bee Culture Magazine

Small hive beetle trap

In the spirit of integrated hive management (see Chapter 10), here's a nonchemical means for controlling the population of small hive beetles (a problem in southern states). This two-piece plastic trap sits on the existing bottom board. There are perforations in the top piece, and

the bottom tray is filled with vegetable oil. A wooden shim provides the proper spacing at the entrance. The bees will chase the beetles as they enter the hive, causing the beetles to seek a hiding spot. As they retreat through the holes of the trap, they fall into the oil and drown.

How to control the small hive beetle

First of all, keeping your colonies strong and healthy is your best natural defense. In addition, you need to destroy any small beetles you see during routine inspections. If infestation levels appear heavy, medicating your hive may be necessary. Presently one approved treatment for the small hive beetle is *coumaphos* (sold under the brand name of CheckMite+).



If you suspect that you have the small hive beetle, contact your state apiary inspector. It's important that you do your part to keep this new pest from spreading all across the country. The inspector will let you know what kinds of treatments are legal in your state. They might even help you with the treatment!

Ants, Ants, and More Ants

Ants can be a nuisance to bees. A few ants here and there are normal, and a healthy colony keeps the ant population under control. But every now and then things can get out of hand, particularly when the hive is too young or too weak to control the ant population. Sometimes simply more ants are around than the colony can handle. When ants overrun a colony, the bees may *abscond* (leave the hive). But you can take steps to control the ant population *before* it becomes a crisis. Two things that you can do if you notice more than a few dozen ants in the hive are

- **Sending cinnamon to the rescue:** Purchase a large container of ground cinnamon from a restaurant supply company. Sprinkle the cinnamon liberally on the ground around the hive. Sprinkle some on the inner cover. Your hive will smell like a giant breakfast doughnut. Yummy! The bees don't mind, but the ants don't like it and stay away. Remember to reapply the spice after the rain washes it away.

- ✔ **Creating a moat of oil:** This technique is a useful defense against ants. You'll need a hive stand with legs. (This is a good idea even if you don't have an ant problem, because raising the hive off the ground is a back-saver for you!). Place each of the stand's four legs in a tin can — old tuna cans are fine. Fill the cans with motor oil. Old or new oil . . . it doesn't matter which you use. The ants won't be able to cross the "moat" of oil and thus are unable to crawl up into the hive (see Figure 12-10). You may need to replenish the oil after heavy rains.

Figure 12-10: Placing the legs of your elevated hive stand in cans of motor oil prevents ants from marching into your hive.

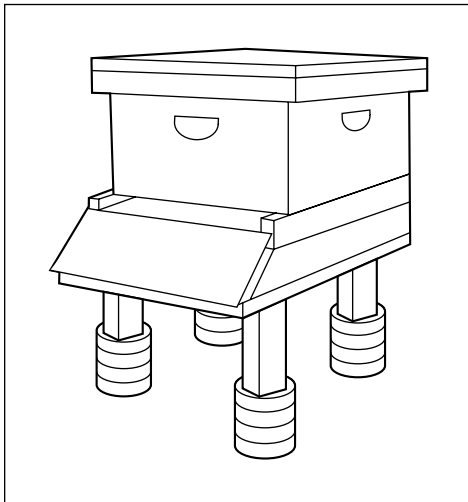

Bear Alert!

Do bears like honey? Indeed they do! And they simply crave the sweet honey bee brood. (I've never tried it myself, but I suspect it's sweet.) If bears are active in your area (they're in many states within the continental United States), taking steps to protect your hive from these lumbering marauders is a necessity. If they catch a whiff of your hive, they can do spectacular and heartbreaking damage, smashing apart the hive and scattering frames and supers far and wide (see Figure 12-11). What a tragedy to lose your bees in such a violent way. Worse yet, you can be certain that once they've discovered your bees, they'll be back, hoping for a second helping.



The only really effective defense against these huge beasts is installing an electric fence around your apiary. Anything short of this just won't do the trick.



If you're ever unlucky enough to lose your bees to bears, be sure to contact your state or local conservation department. You may qualify for remuneration for the loss of your bees. And the department may provide financial assistance for the installation of an electric fence.



Figure 12-11:
These
beehives
were
shattered
to
smithereens
by a hungry
bear.

Courtesy of Bee Culture Magazine

Raccoons and Skunks

Raccoons are clever animals. They easily figure out how to remove the hive's top to get at the tasty treats inside. Placing a heavy rock on the hive's outer cover is a simple solution to a pesky raccoon problem.

Skunks are insect eaters by nature. When they find insects that have a sweet drop of honey in the center . . . bonanza! Skunks and their families visit the hive at night and scratch at the entrance until bees come out to investigate. When they do . . . they're snatched up by the skunk and . . . gulp! Skunks can put away quite a few bees during an evening's banquet. In time they can decimate your colony. These raids also make your bees decidedly more irritable and difficult to work with. You need to put a quick end to skunk invasions.

Putting your hive on an elevated stand is an effective solution for skunk invasions. The skunk then must stand on his hind legs to reach the hive's entrance. That exposes his tender underbelly to the bees — and have no doubts, the bees know what to do next!



You may wonder how the bees feel about skunk scent and whether or not it bothers them. I can't really give you a good answer to this: My bees have never told me how they feel about the smell, nor do I think I've ever known a skunk to spray a hive. But my dog has some stories to tell!

Another solution is hammering a bunch of nails through a plank of plywood (about two-foot square) and placing it in front of the hive with the nail points sticking up. Like a bed of nails. No more skunks. Just be sure *you* remember the plank's there when you go stomping around the hive!

Keeping Out Mrs. Mouse

When the nighttime weather starts turning colder in early autumn, mice start looking for appropriate winter nesting sites. A toasty warm hive is a desirable option. The mouse may briefly visit the hive on a cool night when bees are in a loose cluster. During these exploratory visits the mouse marks the hive with urine so she can find it later on. When winter draws nearer, the mouse returns to the marked hive and builds her nest for the winter.

I can assure you that you don't want this to happen. Mice do extensive damage in a hive during the winter. They don't directly harm the bees, but they destroy comb and foundation and generally make a big mess. They usually leave the hive in early spring, long before the bees break winter cluster and chase them out or sting them to death (see Chapter 2 for the morbid consequences of getting caught). Nesting mice isn't the surprise you want to discover during your early spring inspection. Anticipate mouse problems and take these simple steps to prevent them from taking up winter residence in your hive:

1. **As part of winterizing your hive, use a long stick or a wire coat hanger to "sweep" the floor of the bottom board, making sure that no mouse already has taken up residence.** Shoo them out if they have.
2. **When you're sure your furry friends are *not* at home, secure a metal mouse guard along the entrance of the hive (see Figure 12-12).** This metal device enables bees to come to and fro and provides ample winter ventilation, but the mouse guard's openings are too small for Mrs. Mouse to slip through.



The early use of mouse guards pays dividends. Mama mouse makes early visits to the hive (when the weather is still mild) looking for a suitable home for the winter. She will “scent” the inside of the hive at night when the bees are inactive, and then will return in the cooler weather to take up winter residence. So don’t delay getting those guards on *before* she makes her rounds.



Using a wooden entrance reducer as a mouse guard doesn’t work. The mouse nibbles away at the wood and makes the opening just big enough to slip through.

Figure 12-12:
Installing
a metal
mouse
guard
prevents
mice from
nesting in
your hive
during
winter.



Some Birds Have a Taste for Bees

If you think you notice birds swooping at your bees and eating them, you may be right. Some birds have a taste for bees and gobble them up as bees fly in and out of the hive. But don’t be alarmed. The number of bees that you’ll lose to birds probably is modest compared to the hive’s total population. No action need be taken. You’re just witnessing nature’s balancing act.

Pest Control

Table 12-1 provides treatment options for the various pests mentioned in this chapter.

Table 12-1 Solutions to Common Pest Problems		
<i>Pest Problem</i>	<i>Solution(s)</i>	<i>Comments</i>
Varroa mites	Apistan (fluvalinate)	Alternate your treatments to prevent the mites from building a resistance to the miticide
	Chec-Mite II (coumaphos)	
	Apiguard (Thymol)	Apiguard and Honey B Healthy use natural (non harsh) ingredients
	Honey B Healthy (essential oils)	
Tracheal mites	Grease patties	All of these options use natural (non harsh) ingredients
	Menthol	
	Apiguard (Thymol)	
	Honey B Healthy (essential Oils)	
Small hive beetles	Chec-Mite II (coumaphos)	Harsh chemical
Wax moths	PDB crystals (para dichlorobenzene)	Applied only to empty supers and hive bodies
Ants	Cinnamon	Reapply as needed after rain
	Oil moat	
Skunks	Elevated hive stand	Also easy on your back!
	Bed of nails	Watch your step!
Racoons	Heavy rock on outer cover	Avoid using entrance feeders as they attract unwanted visitors
Bears	Electric fence around your hives	Some states offer financial compensation for bear fence installations
Mice	Metal mouse guard placed at hive entrance	Install guards before the cold weather approaches

Chapter 13

Raising Your Own Queens

In This Chapter

- ▶ Understanding the benefits of raising your own queens
- ▶ Knowing what equipment you will need
- ▶ Looking at different methods
- ▶ Selling your queens
- ▶ Performing seasonal chores

Special thanks to my friend and EAS Master Beekeeper Leslie Huston for her help preparing this chapter.

In this chapter I introduce you to different methods for raising your own queens. The process can be fairly involved, but once you are familiar with some basic concepts you'll be on your way to success.

Several books have been written on this topic alone, and I recommend you do some further reading if you want to pursue this fascinating component of beekeeping. I cover some of the fundamentals and a couple of “easy” methods to get your feet wet.

Why Raising Queens Is the Bee's Knees

Some colonies are particularly delightful to work with. Nice temperament, healthy bees, great honey producers, and resilient enough to survive winter. This is the kind of colony that's a pleasure to be around. It's the queen who possesses the genetics that provide the colony with these desirable traits.

When you raise your own queens, you can avoid “imported” problems. Every time you bring bees into your apiary from other sources, you run the risk of bringing unwanted “hitchhikers” along — like the small hive beetle, American foulbrood, and Africanized honey bees just to name a few. Once established, these troubles can be difficult to get rid of.

Raising genetically strong queens that produce healthy colonies can help you avoid the multitude of worries and problems currently facing honey bees (including Colony Collapse Disorder, or CCD — see Chapter 10). Robust colonies are resistant to pests, chemicals, and diseases.

And here's the best part. Raising queens is fun! You'll experience a whole new dimension of these fascinating insects. And you'll feel so proud when you hold your homegrown queen in your hand.

Sure you will encounter some challenges, but they will help you grow as a beekeeper. Queen-rearing will put you in better touch with the overall health and well-being of all your bees. Even if you don't make queen-rearing a permanent part of your beekeeping repertoire, by trying it you'll begin to appreciate what makes a good queen and what to look for when shopping for one.



You can raise as few or as many queens as you like. I suggest that you raise just enough to provide yourself with great queens to start, rather than enough queens to sell. Then, if you want, kick things up a notch and raise queens that you can sell to other beekeepers. Your carefully raised, local stock will likely be a big hit with other beekeepers in your neighborhood.

There is a subtle but important difference. Queen *rearing* is the process of making queen bees. There are a number of methods for queen rearing. I'll cover the general principles here and describe in some detail a couple of the most popular methods. Queen *breeding* is the act of identifying and selecting queens from superior colonies to use as the parents of subsequent generations. This genetic selection will result in a greater tendency for subsequent generations to exhibit the traits for which you select. Using gentleness as an example: Selecting queens from gentle colonies to raise new queens will result in new colonies that will be gentler than if you had not done that careful selection. In this way, queen rearing and queen breeding are separate yet related processes.

Accentuate the Positive

With bees, just like all plants and animals, traits are passed from one generation to the next. Good and bad. With respect to livestock (and your bees are considered livestock) it is common to select from your "herd" to retain the best traits and minimize or eliminate the worst. This is how the many different dog breeds came into existence, and it has also shaped the characteristics of our chickens, cows, corn, and so on.

In order to breed better bees, you need one or more mothers and a whole lot of fathers. So there are two types of colonies you will select to be your breeding stock:

- ✔ **Queen mother colony:** Your very best colony and the queen that rules it is the one to use to raise more queens. This queen is called the “queen mother”.
- ✔ **Drone mother colony:** Wherever you plan to allow your queens to do their mating, you will want to have the most desirable *drone* (male bee) stock available. You don’t want drones from sub-par colonies contributing their poor genetics to your fine queens. Unless you live in an area where you can guarantee isolation, you will be unable to control the drone gene pool completely. But you can stack the deck in your favor by doing your best to saturate the area with lots of healthy drones from colonies with desirable traits.

No matter how you go about raising queens, provide your queen-rearing operation with every advantage. Go easy on the chemical treatments, and make sure they have plenty of honey and pollen.

Whether you are selecting a queen mother or a drone mother, there are certain traits you will want to consider. Some traits are more hereditary than others. In the case of honey bees, here are some of the most desirable traits to look for when selecting colonies for your breeding project:

- ✔ **Gentleness:** Gentleness is a great trait for bees to have — no beekeeper wants to be stung. It is a very hereditary trait. You can test a colony for gentleness by vigorously waving a wand with a black leather patch at the end over an open hive. This will alarm the bees, and they may rush up to sting the leather patch. After a minute or so, count the stingers on the patch. The colonies with the fewest stingers in the patch are the most gentle.
- ✔ **Resistance to disease and pests:** Bee breeders and commercial queen producers are making progress with breeding bees that are resistant or more tolerant to disease (for more on bee diseases, see Chapter 11). You can do this as well by identifying those colonies that are the most robust and require the least treatment. You will want to raise queens using stock from these “star” colonies. Honey bees are very responsive to selection, and in just a few seasons you can influence the overall health of your bees.
- ✔ **Hardiness:** Winter hardiness is especially important to beekeepers in climates that have long, cold winters. If you live in a climate where winter’s deep freeze lasts ten to 12 weeks or more, then you may regard winter as the enemy, at least as far as your bees’ survival goes. Colonies that survive a long cold spell must be healthy and strong. They must produce and store enough honey to fuel their winter hunker-down. And they should slow down their brood rearing in the fall efficiently, and start up in the spring in time to have their numbers grow to take advantage of the spring nectar flow. It takes a healthy, well-run, well-rounded colony to survive a northern winter. These are traits you would like all of your colonies to have.

- ✔ **Productivity:** Some say you can't really select for honey production when breeding queens because there are too many other factors, such as the weather (if it doesn't rain, then there are fewer flowers, and honey production will be low). So while honey production may be more a function of environment than genetics, if one of your colonies consistently produces more honey than another, consider that colony's queen for breeding.

What Makes a Queen a Queen

All bees are essentially created equal, to start. The queen develops from a fertilized egg, just the same as the workers do. For the first two to three days, the fertilized egg of the bee destined to be a queen hatches into a young larva, just as with worker bees. But after the egg hatches into a young larva, it becomes decision time. A larva that goes down the road to "queendom" continues to receive a plentiful supply of rich royal jelly. And only royal jelly. But larvae that will become workers are switched to a nourishing, but coarser diet of honey and pollen. See Chapter 2 for more the life cycle of bees.

Because of these differences, you'll need to get familiar with some basic bee biology to raise queens. Here are some of the more important differences between queen bees and workers and drones:

- ✔ A queen takes just 16 days to develop. (A worker takes 21, and a drone takes 24). Here's how the queen's development proceeds:
 - Day 1–3: Egg
 - Day 4: Larva of suitable age to become a queen (rather than a worker)
 - Days 4–9: Larva with cell open, being fed by nurse bees
 - Days 12–14: Queen cell is capped, the developing queen (pupa) inside the cell is very fragile
 - Days 14–16: The developing queen is less fragile (she can be moved to queenless nuc)
 - Day 16: The queen emerges from her cell
- ✔ All queens and workers are developed from fertilized eggs and possess a full set of chromosomes and have a complete genetic makeup (a mother and father).
- ✔ The drone develops from an unfertilized egg. He has half the full set of chromosomes (a mother, but no father).

How do they mate?

It's important to understand how honey bees mate, so that you can do your best to provide optimal conditions and know how circumstances such as weather can impact your queen-rearing operation. The queen bee has some interesting mating habits:

- ✔ **Queen bees mate in the air.** The drones fly out of their colonies and gather at a place called a drone congregation area. The virgin queens seem to know where these areas are, and make a “bee-line” there in order to mate. Here a number of drones mate with the virgin, and drop-dead afterward (see Chapter 2 for more).
- ✔ **A virgin queen will take one or more mating flights over the course of a few days or a week.** Then she's done mating for her lifetime. The sperm (from the drone) is stored in a special, tiny ball in the queen's abdomen called the *spermatheca*. It is supplied with nutrients to keep the sperm alive for as long as the queen remains productive.
- ✔ **Because queens mate with a number of drones, a honey bee colony is a collection of “sub-families”.** All the bees in the colony have the same mother (the queen). But some workers will be full sisters (having the same mother and father) and some will be half-sisters (having the same mother but different fathers). This genetic diversity is critical to having thriving, healthy colonies with a variety of traits that help the bees survive.
- ✔ **If for some reason a virgin is prevented from mating, there will come a time when she will stop trying to mate and will begin laying eggs.** However, none of these eggs will be fertilized so they will all result in drones.



A virgin queen takes a few days to mature — her wings expand and dry, her glands mature, and so on. Then a few days more to fly and mate, and a few days more to settle down to laying eggs. Allow two or three weeks from emergence to the time when she will begin laying eggs.

Creating Demand: Making a Queenless Nuc

A *nuc*, or *nucleus* colony is a small community of bees. Most common are nucs of four or five frames. A *queenless nuc* is a small colony of bees without a queen. If a colony does not have a queen, the bees will try to make one from any available larvae of the right age (four days after the egg was laid). A queenless nuc will also be very receptive to a newly introduced virgin or mated queen. Queenless nucs should be made up a day or two before they are needed — so that the bees will have time to realize that they no longer have a queen. Queenless nucs are used for starting queen cells, and also for receiving queens — virgin or mated.

Here's how to create a queenless nuc.

1. **Place frames of capped brood, honey, and pollen into the nuc hive body. The frames should be covered with worker bees and come from a healthy hive.**



Make 100-percent certain there is no queen on these frames — just workers (an occasional drone is okay). There should be as little open brood as possible.

2. **Wait a day or two before introducing a frame of eggs, or a frame of grafted larvae, or a queen (virgin or mated).**

Queen Rearing: The Miller Method

The Miller Method is a queen-rearing process that requires no special equipment and is perfect for the backyard beekeeper who just wants to raise a few queens.

Here's how it works:

1. **First, take a deep frame with wax foundation and cut the bottom edge of the foundation into a saw tooth pattern (see Figure 13-1).** If the wax has wires in it, you'll need to snip a few of them, or work around them.

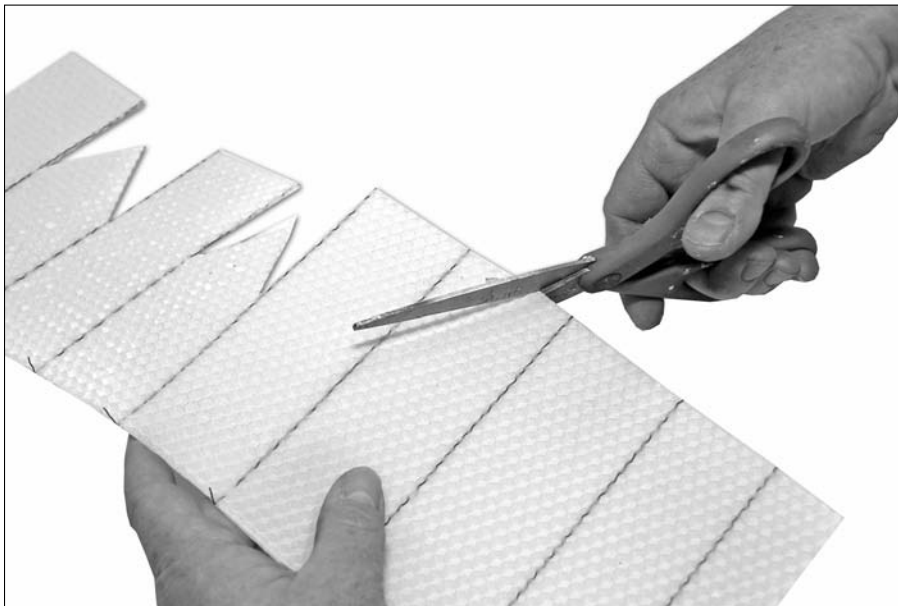

Figure 13-1:
Cutting the
bottom edge
of the wax
foundation.



The size of frame you use is not that critical. Most queen-rearing beekeepers use the same size frame used in their brood box. For most folks this would be a deep frame, although some beekeepers standardize on medium depth frames for both brood and honey.

2. **Place the frame with the “saw tooth” foundation in the center of your queen mother colony (the strongest, hardiest, most productive and gentlest).** Let the bees draw it out into comb. Consider feeding the colony some syrup to get them making wax.
3. **After a week, have a peek every few days. At some point, the queen will start laying eggs in this new comb.** When the cells along the saw-toothed margins have eggs, it’s time to set up a queenless nuc that will build and raise the queen cells.
4. **The day after setting up the queenless nuc, insert the saw-tooth frame of eggs into the center.** Overnight the bees will have become very aware that they have no queen. They will be ever-so-ready to receive a frame containing just what they need to raise some queens: eggs. If all goes well, the bees will build a number of queen cells along the jagged edge.
5. **In a week’s time, have a look and see what the bees have made.** Hopefully, the bees will have built several queen cells in different spots along the jagged edge.

In a few more days, come back and see how the queen cells are developing. Later, you will separate them by cutting them apart. But for now, just look and see what you’ve got to work with. If some of the cells are too close to cut apart, then plan to leave them together and put that clump in a queenless nuc. If the bees have managed to raise any queen cells on other frames, you should destroy them. They’re not from your carefully chosen queen mother, and you want the bees’ attention focused on raising the daughters of that favored queen, not their own kin.

6. **Make up an additional queenless nuc for each queen cell (or clumps of cells) that you saw in Step 5.**
7. **A few days before the queens are due to emerge, go back and remove the frame containing the queen cells.**

Cut the cells apart carefully to put into the waiting queenless nucs (see Figure 13-2). When you cut the comb, take plenty of comb around each cell or clump of cells — give yourself a hefty handle, even if it means cutting into other brood cells. Don’t dent or deform the queen cell in the least little bit — the developing queen inside is extremely fragile. Also, don’t tip the cells or jostle them, for the same reason.



Be sure to move those queen cells to the queenless nucs before the queens emerge. If you don’t, the first queen to emerge will kill all the other queens she can find! A sad ending.



Figure 13-2:
Queen cages come in different sizes and styles.



Figure 13-3:
Carefully cut around the queen cell and transfer it onto a frame in a waiting queenless nuc (left).



Figure 13-4:

By gently pressing on the extra “handle,” it should stick securely in place.

8. Distribute the queen cells to the queenless nucs.

Remove a central frame from each queenless nuc and carefully press the comb handle attached to the cells into the comb of this frame. Be very careful as you slide the frame back into the hive. Not denting the queen cell is of paramount importance.

9. A day or two after “emergence day” (16 days after the egg was laid), check to see that each queen did emerge from her cell.

You’ll see the queen cell with a round opening on the bottom. You might be able to find her walking around on one of the frames. Then again, you may not. A virgin queen is often on the small side, not much larger than a worker (she’ll plump up after she mates). If you don’t find her, don’t worry. A virgin emerging from a cell into a queenless colony is very likely to be accepted — hey, she’s the only game in town.

Bees found on frames of open brood (not capped) are typically nurse bees. You can ensure that your queenless nuc has lots of nurse bees by shaking or brushing the bees off frames of open brood and into your queenless nuc. Just make sure you don’t shake off or brush a queen into the nuc! Return the brood frame to the colony it came from.

The Doolittle Method: Grafting

With the Miller Method you can raise a few queens at a time, but there are other methods that allow you to ramp up production and turn out dozens of high-quality queens. Raising larger numbers of queens is more challenging. But you might find a market for your lovely queens among beekeepers in your area. Whatever the market is charging for queens, you can charge, too. Feel free to charge more if you think you have some hot property. Right now, queens sell for around \$20 to \$25 each.

The most common method of producing large numbers of queens is by grafting larvae of the right age into special wax or plastic *queen cell cups* that are affixed to bars. The bars are positioned in frames, and the frames are inserted into a queenless nuc equipped with lots of nurse bees and lots of provisions such as honey (and/or syrup) and pollen (and/or pollen patties).

Tools and equipment

Grafting requires some special equipment and supplies. All are available from most beekeeping suppliers. If you're a gadget lover, grafting has a lot of allure.

- ✓ **Cell bar frames:** These are frames that, instead of containing foundation, contain one or more bars that hold plastic or wax queen cups into which larvae are grafted. The frame is then inserted into a queenless colony where queen cells will be raised. See Figure 13-5.

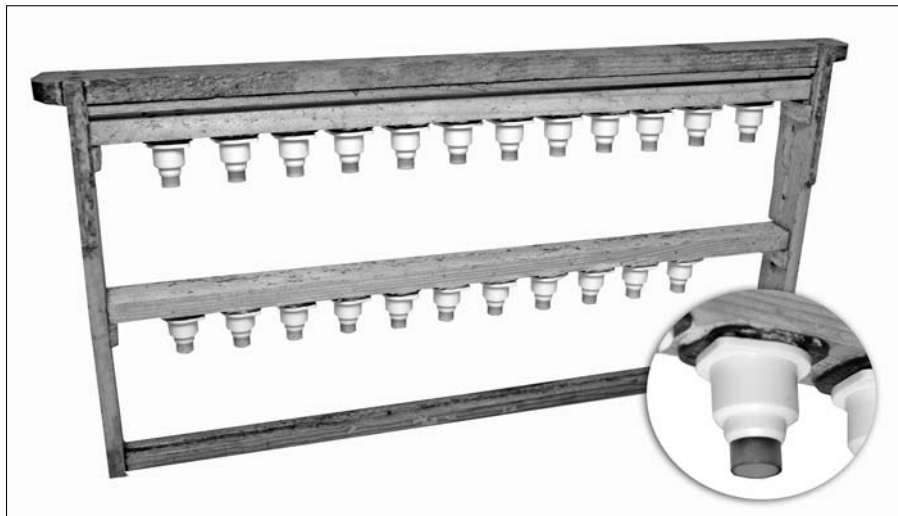
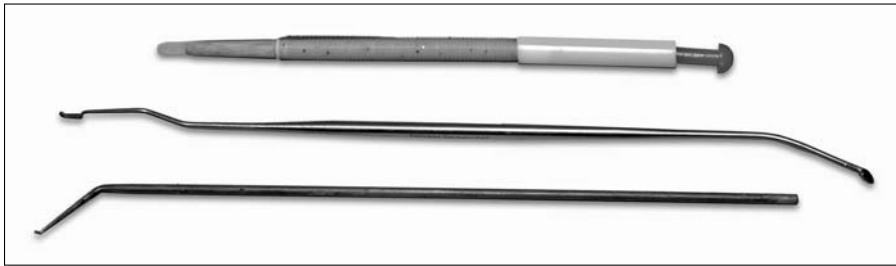

Figure 13-5:
A cell bar
frame (detail
of individual
queen cup).

- ✔ **Grafting tools:** You use grafting tools (see Figure 13-6) to lift the delicate and oh-so-fragile larva out of its original cell and place it gently in the cup on the cell bar frame. There are many different kinds of grafting tools, and each beekeeper develops his or her own preference.

Figure 13-6:
Three different kinds of grafting tools.



- ✔ **Queen cell protectors:** Cell protectors are cage-like cylinders that are placed around the developing queen cells once they are capped (see Figure 13-7). The cell protectors keep the newly emerged virgin queens confined, preventing them from being able to move about the colony and kill the other queens. The perforations in the “cage” allow surrounding worker bees to feed and care for the new virgin queens.

Figure 13-7:
Queen cell protectors snapped into place. They are used to contain new queens that emerge from their cells.



- ✓ **Queen cages:** These are designed to confine the queen and provide, via screen or perforations, a way for the bees on the outside of the cage to feed the queen inside. Queen cages also have a place that can be filled with a fondant or candy plug, which will be eaten by the bees and allow the queen to be released after sufficient time has passed to have her accepted by the colony.

How it's done

There are steps leading up to grafting day, and steps following grafting day. As with the Miller Method, you select the colony headed by your best queen for grafting.

- ✓ **Four days before grafting day:** The eggs you'll want to graft are laid four days before grafting day. To make it easier to locate the right-age larva, confine the queen on a frame of empty drawn comb four days ahead of grafting day. Use that comb when transferring larvae to cell cups. A "push-in" cage is the perfect tool for restricting a laying queen to a cluster of empty cells. See Figure 13-8.

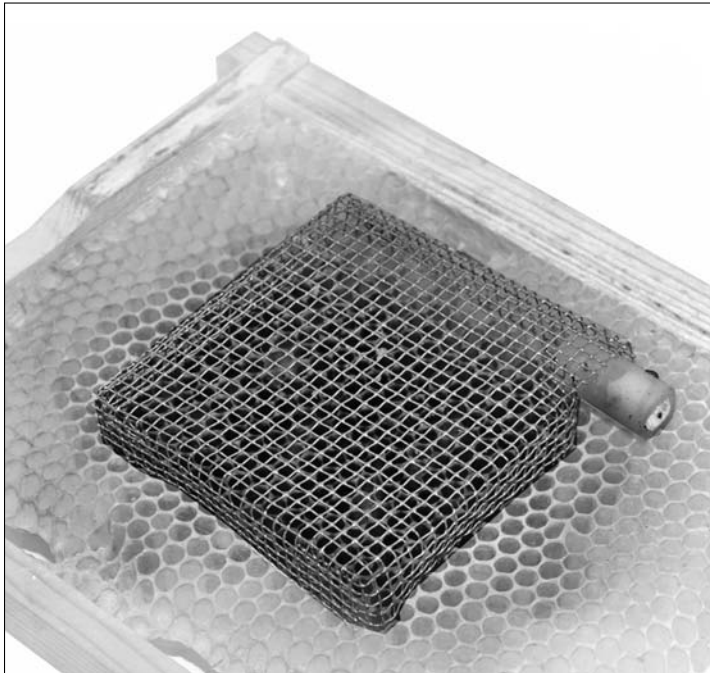

Figure 13-8: A "push-in" queen cage helps you confine a queen to just a few cells. The eggs laid in these cells are the ones you will want to use for grafting.

- ✔ **Three days before grafting day:** Release the queen from confinement by removing the push-in cage. Having laid eggs in these cells, the queen's job is done. She can be allowed to roam the colony and continue laying eggs at will. You will want to keep track of where those larvae are — they are the ones that will be the right age for grafting. Mark the frame's top bar so that you can retrieve that frame come grafting day.
- ✔ **Two days before grafting day:** Create your queenless nuc to serve as a cell starter. You want to put your freshly grafted larvae into an environment where they'll be well cared for. This means lots of bees (especially lots of nurse bees), frames of honey, pollen (and/or a feeder and a pollen patty), and little or no open brood. You want lots of nurse bees because they are the ones most geared to feeding larvae.
- ✔ **Grafting day:** Using the frame you confined four days ago, graft larvae into cell cups and place the frame of cells into the queenless cell starter that you made up a couple of days ago. Grafting is a delicate maneuver, and the very young larvae are exceedingly fragile. See Figure 13-9.

A larva that is bruised or handled too much is unlikely to survive and be accepted by the bees. In order to achieve successful grafting, be prepared to try various grafting tools, different positions (for you and for the frame of larvae), different lighting, and perhaps some magnification. Try a few different tools, and give yourself time and a lot of practice to get it right. You may have poor acceptance your first few rounds of grafting, but keep trying.



Figure 13-9:
The delicate
process
of grafting
larva into
queen cell
cups.



The larva breathes through small openings on one side of its body — the side exposed to the air. If the larva is flipped when transferred to the cell cup, it will not be able to breathe.

- ✓ **One or two days after grafting day:** Have a peek. The bees have decided which cells they're going to feed and draw and develop into queens, and which they are not.
- ✓ **A week or so after grafting day:** Check the cells and put cell protectors on them. The cells should be capped by the bees four or five days after grafting, so the only care they need from here until emergence is warmth and humidity. The cell protectors will keep the virgin queens separated from each other — if they are left to emerge into the colony, the first queen out will kill all of the other queens.



While you're in the cell builder, give the other frames a look and remove any "rogue" queen cells elsewhere in the hive that the bees may have built. If one of them emerges, she'll kill all the other queens.

Virgin queens will emerge 15 to 17 days after the egg is laid (11 to 13 days after grafting). The average development time is 16 days, but development is faster in warmer weather, and slower in cooler temperatures.

Providing nuptial housing

Virgin queens are often given temporary housing until they mate. Mating nucs for your virgins can be regular-sized hives or nucs, but if you're raising a lot of queens that can be quite demanding in terms of bees, equipment, and real estate. There are small units, called *mini-mating nucs* or *pee wees*, that hold just a couple of cups of bees, a few miniature frames, and a small food reservoir (Figure 13-10). These downsized colonies take up far less space and demand fewer bees less food to support the virgin while she matures and mates. With mini mating nucs, you can place a bunch of nucs in a comparatively small area. Checking these smaller units is quicker and easier, too. But be careful, in midsummer when nectar falls off, it can be hard to keep these tiny communities fed.

After the queens have emerged safely into their cell protectors, you can transfer them to queen cages (with candy plugs). Then introduce the caged queens into their own mating nuc (one queen per nuc), letting the bees slow-release the queens by chewing through the candy plug.

Be patient. Allow two to three weeks for a virgin queen to mate and begin laying eggs.

Figure 13-10:
A pee-wee mating nuc takes up less real estate than a conventional nuc or hive. With just a few mini frames and its own food supply, it's the perfect size for temporarily housing a virgin queen while she matures and mates.

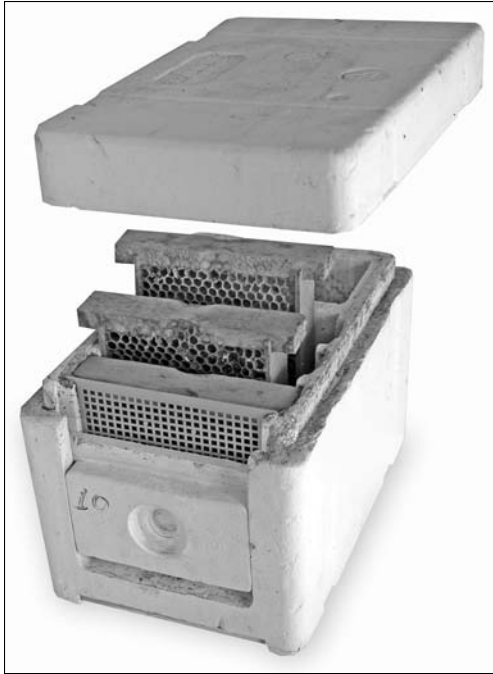

Finding a Home for Your Queens

Now that you have queens, what do you do with them? Where do they live? You have a number of options:

- ✓ **Queen cages and battery boxes:** Your queens can be kept for a few days in a cage with attendants. Use a clean eye-dropper to feed them a single drop of water once or twice a day.
- ✓ **Queen banks:** A *queen bank* is a regular, queen-right colony with a queen excluder keeping the colony's resident queen separate from the upper hive body. In the upper hive body, caged queens are held in a special rack that takes the place of one of the frames.



Queen-right: A queen-right colony is one that has a laying queen.

When queens are in the bank, help ensure that they're surrounded by nurse bees by periodically (weekly) moving frames of young, open brood from the lower portion up to the bank portion. Examine the frames carefully as you move them up — be careful not to move the queen from the lower portion up to the queen bank portion! If nectar is scarce, feed the queen bank with sugar syrup using whatever kind of feeder you prefer.

You can store mated queens for days or a few weeks in a queen bank. However, the sooner they get out and start laying eggs, the better off they'll be. They're meant to be roaming comb among a population and laying eggs. Confinement is hard on them, so get them out into a colony as soon as possible.

The Queen Breeder's Calendar

Spring: This is swarming season and an ideal time to raise queens. The bees are in full gear to do it: build comb and raise and accept new queens. And the nectar and pollen are plentiful. Keep an eye on your drone mother colonies.

When drone cells are emerging, start actively rearing queens. The drones will be mature and ready for mating by the time your virgins are out on their mating flights.

Summer: Keep on raising queens. Be aware that as nectar flow diminishes, the colonies will need feeding. In late summer especially, feeding is necessary not only to keep the smaller nucleus colonies afloat, but to aid in queen acceptance.

Fall: Queen-rearing is done. Time to get nucs settled and ready for winter. Consider using a side-by-side nuc that can house two queens.

Winter: Now's a good time to read and make plans for the coming season.

You can set up some nucleus colonies for your new queens and overwinter them by setting them on top of other, full-size colonies. This is especially helpful in cooler, northern climates. Heat rises and the full size colonies will help keep the nucs warm. The following spring, these over-wintered nucs will have young queens that can be used to re-populate colonies that die over the wintertime. Or you can grow these nucs into full-sized colonies.

Over-wintering nucs does require some special equipment: a split bottom board and a hive body divider of some kind (a division board and/or a division feeder).

Then all that remains is to review your queen-rearing, as you do with the rest of your beekeeping. Make notes on what worked and what needs improving and make plans for next season.

Marking and Wing-Clipping

It's a good idea to mark your mated queens. Beekeeping suppliers often sell queen marking pens, or you can buy similar pens at an art supply store (just be careful to get water-based, permanent paint pens). An international queen marking color code has been established to track the age of a given queen:

For years ending with

0 or 5

1 or 6

2 or 7

3 or 8

4 or 9

Mark with this color

Blue

White

Yellow

Red

Green

Part V

Sweet Rewards

The 5th Wave

By Rich Tennant

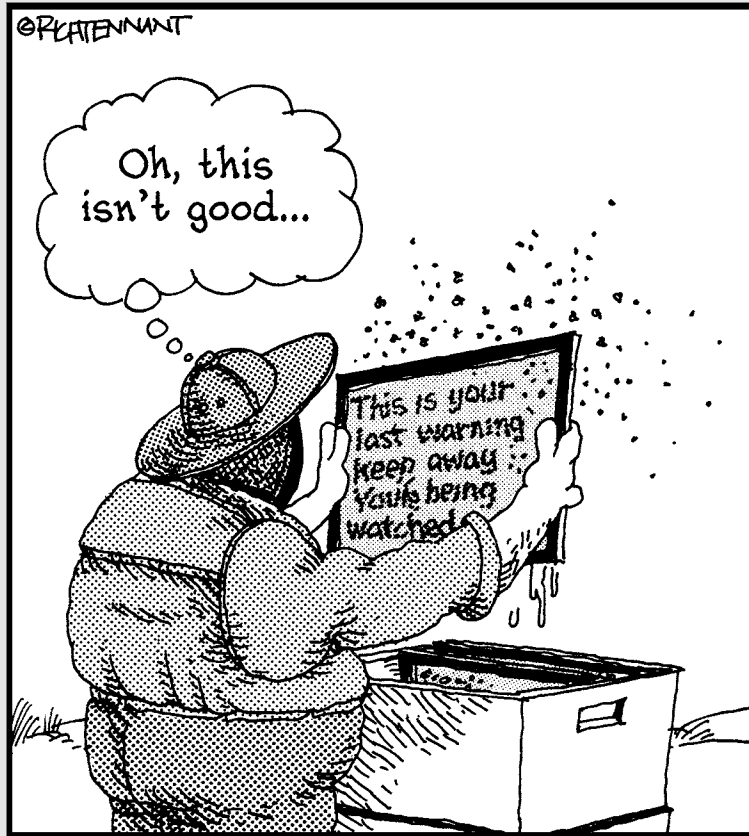

In this part . . .

These chapters deal with the sweet rewards of beekeeping. I give you a step-by-step approach for harvesting, bottling, and marketing your honey. I also tell you about other valuable products that you can harvest from your bees.

Chapter 14

Getting Ready for the Golden Harvest

In This Chapter

- ▶ Deciding what kind of honey you want
 - ▶ Selecting the best tools for the job
 - ▶ Planning your workspace
 - ▶ Packaging and marketing your honey
-

It all comes down to honey. That's why most people keep bees. For eons honey has been highly regarded as a valuable commodity. And why not? No purer food exists in the world. It's easily digestible, a powerful source of energy, and simply delicious. In many countries, honey even is used for its medicinal properties. The honey bee is the only insect that manufactures a food that we eat. And we eat a lot of it — more than 1 million tons are consumed worldwide each year.

What a thrill it is to bottle your first harvest! You'll swear that you've never had honey that tastes as good as your own. And you're probably right. Commercial honey can't compare to homegrown. Most supermarket honey has been blended, cooked, and ultrafiltered. Yours will be just the way the bees made it, and packed with aroma and flavor. I'm getting hungry just thinking about it.

In this chapter I'll help you plan for the big day — your first honey harvest. You'll need to consider the type of honey you want to produce, the tools you'll need, the amount of preparation you'll have to do, and what you'll need for marketing. So let's get started.

Having Realistic Expectations

In your first year, don't expect too much of a honey harvest. Sorry, but a newly established colony doesn't have the benefit of a full season of foraging. Nor has it had an opportunity to build its maximum population. I know that's disappointing news. But be patient. Next year will be a bonanza!

Beekeeping is like farming. The actual yield depends upon the weather. Many warm, sunny days with ample rain results in more flowers and greater nectar flows. When gardens flourish, so do bees. If Mother Nature works in your favor, a hive can produce 60 to 100 pounds of surplus honey (that's the honey you can take from the bees), or more. If you live in a warm climate (like Florida or Southern California) you can expect multiple harvests each year. But remember that your bees need you to leave some honey for their own use. In cold climates leave them 60 pounds, in climates with no winter, leave 20 to 30 pounds.



For a hive to produce that much surplus honey is amazing when you consider that honey bees fly more than 50,000 miles and visit more than 2 million flowers to gather enough nectar to make a pound of honey.

What Flavor Do You Want?

The flavor of honey your bees make is likely more up to the bees than you. You certainly can't tell them which flowers to visit. See Chapter 3 for a discussion of where to locate your hive when you want a particular flavor of honey.



Unless you put your hives on a farm with acres of specific flowering plants, your bees will collect myriad nectars from many different flowers, which results in a delicious honey that's a blend of the many flowers in your area. Your honey can be classified as *wildflower honey*. Note also that eating such honey is an effective way to fend off local pollen allergies — a natural way of inoculating yourself. See Chapter 3 for more information on different kinds of honey.

Then you need to decide what *style* of honey you want to package, because that influences some of the equipment that you use.

Choosing Extracted, Comb, Chunk, or Whipped Honey

What style of honey do you plan to harvest? You have several different options. Each impacts what kind of honey harvesting equipment you purchase, because specific types of honey can be collected only by using specific tools and honey-gathering equipment. If you have more than one hive, you can designate each hive to produce a different style of honey. Now that sounds like fun!



Honey never should be refrigerated, because cold temperatures accelerate crystallization. In time, however, nearly all honeys form granulated crystals, regardless of the temperature. Crystallized honey can be easily liquefied by placing the jar in warm water, or by gently heating in the microwave for a couple of minutes.

Extracted honey

Extracted honey is by far the most popular style of honey consumed in the United States. Wax cappings are sliced off the honeycomb, and liquid honey is removed (extracted) from the cells by centrifugal force. The honey is strained and then put in containers. The beekeeper needs an uncapping knife, extractor (spinner), and some kind of sieve to strain out the bits of wax and the occasional sticky bee.

Comb honey

Comb honey is honey just as the bees made it . . . still in the comb. Encouraging bees to make this kind of honey is a bit tricky. You need a very strong nectar flow to get the bees going. Watch for many warm sunny days and just the right amount of rain to produce a bounty of flowering plants. But harvesting comb honey is less time consuming than harvesting extracted honey. You simply remove the entire honeycomb and package it. You eat the whole thing: the wax and honey. It's all edible! A number of nifty products facilitate the production of comb honey (but more on that later in this chapter).

Whipping up whipped honey: The Dyce Method

The Dyce Method is a process used to control the crystallization of honey. It was developed and patented by Elton J. Dyce in 1935. The process (described here) results in a nice, smooth whipped honey:

- ✔ Heat honey to 120 degrees F (use a candy thermometer — accuracy is important). This kills yeast cells that always are present in honey. Yeast causes fermentation, and its presence can inhibit a successful result when making whipped honey. Stir the honey gently and constantly to avoid overheating. Be careful not to introduce air bubbles.
 - ✔ Using a two-fold thickness of cheesecloth as a strainer, strain honey to remove foreign material and wax.
 - ✔ Heat honey again, this time to 150 degrees F. Don't forget to stir continuously.
 - ✔ Strain honey another time to remove all visible particles. Again, you can use a two-fold thickness of cheesecloth as a strainer.
 - ✔ Cool honey as rapidly as possible. You can place honey in a container and "float" it in an ice water bath to speed the cooling process.
- Stir gently as honey cools. Continue cooling until the temperature of the honey reaches 75 degrees F.
- ✔ Add some finely crystallized honey to promote a controlled crystallization of your whipped honey — it's kind of like adding a special *yeast culture* when making sourdough bread. Introduce these seed *crystals* by adding 10 percent (by weight) of processed granulated honey. *Granulated honey* is processed by breaking down any coarse crystals into finely granulated crystals. This can be accomplished by *fracturing* the crystallized honey in a meat grinder or a food processor.
 - ✔ Place mixture in a cool room (57 degrees F). Complete crystallization occurs in about a week.
 - ✔ After a week, run mixture through the grinder (or food processor) one more time to break up any newly formed crystals.
 - ✔ Bottle and store in a cool dry room.

(Information courtesy of National Honey Board)

Chunk honey

Sometimes called *cut comb*, *chunk honey* refers to chunks of honeycomb that are placed in a wide-mouthed bottle and then filled with extracted liquid honey.

Whipped honey

Also called *creamed honey*, *creamed honey*, *spun honey*, *churned honey*, *candied honey*, or *honey fondant*, *whipped honey* is a semisolid style of honey that's popular in Europe. In time, all honey naturally forms coarse granules or crystals. By controlling the crystallization process you can produce fine crystals and create a smooth, spreadable product.



Granulated honey is honey that has formed sugar crystals. You make *whipped honey* by blending nine parts of extracted liquid honey with one part of finely granulated (crystallized) honey. The resulting consistency of whipped honey is thick, ultrasmooth, and can be spread on toast like butter. Making it takes a fair amount of work, but it's worth it!

The Right Equipment for the Job

Once you decide what style of honey you want your bees to make (extracted, comb, chunk, or creamed) you need to get hold of the appropriate kind of equipment. This section discusses the various types that you'll need depending upon the style of honey you want to harvest.

Honey extractors

Essentially, an extractor is a device that spins honey from the comb using centrifugal force (see Figure 14-1). Extractors come in different sizes and styles to meet virtually every need and budget. Hand-crank models or ones with electric motors are available. Small ones for the hobbyist with a few hives, huge ones for the bee baron with many hives, and everything in between can be found. Budget extractors are made entirely of plastic, and rugged ones are fabricated from food-grade stainless steel. Keep in mind, however, that a good-quality, stainless-steel extractor will far outlast a cheap one made of plastic. So get the best one that your budget allows. Look for a model that accommodates at least four frames at a time. Backyard beekeepers can expect to pay \$295 to \$495 for a new quality extractor. Less for a used one. Even more for ones with electric motors.



Figure 14-1:
This hand-crank, stainless-steel extractor extracts up to six shallow frames at a time.



You may not have to buy an extractor. Some local beekeepers, beekeeping clubs, and nature centers rent out extractors. So be sure to call around and see what options you have. Ultimately, you may want to invest in your own. My advice: If you're able to, rent or borrow an extractor during your first season. From the experience you gain, you'll be better able to choose the model and style of extractor that best meets your needs.

Uncapping knife

The wax cappings on the honeycomb form an airtight seal on the cells containing honey — like a lid on a jar. Before honey can be extracted, the “lids” must be removed. The easiest way is by using an uncapping knife. These electrically heated knives slice quickly and cleanly through the cappings (see Figure 14-2).

Alternatively, you can use a large serrated bread knife. Heat it by dipping in hot water (be sure to wipe the knife dry before you use it to prevent any water from getting into your honey).

Figure 14-2: An electrically heated uncapping knife makes short order of slicing wax cappings off honeycomb.

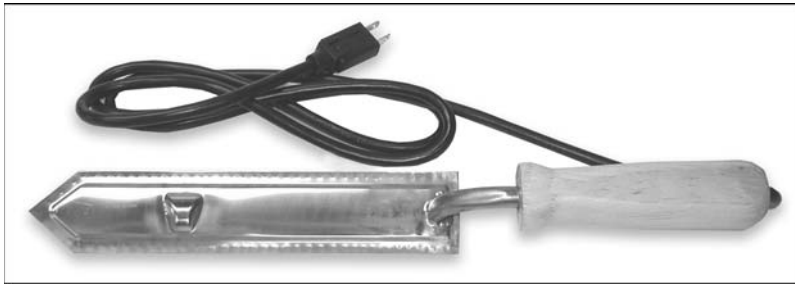

Honey strainer

The extracted honey needs to be strained before you bottle it. This step removes the little bits of wax, wood, and the occasional sticky bee. Any kind of conventional kitchen strainer or fine-sieved colander will suffice. Nice, stainless-steel honey strainers (see Figure 14-3) are made just for this purpose and are available from your beekeeping supplier.

Or you can use a disposable paint strainer (available at your local paint supply store). It does the trick just fine, and fits nicely over a five gallon plastic bucket.

Figure 14-3:

A double, stainless-steel honey strainer (like this one) is an effective way to clean up your honey before bottling it.



Other handy gadgets for extracting honey

Here are a few of the optional items that are available for extracting honey. None are essential, but all are useful niceties.

Double uncapping tank

The double uncapping tank is a nifty device that is used to collect the wax cappings as you slice them off the comb. The upper tank captures the cappings (this wax eventually can be rendered into candles, furniture polish, cosmetics, and so on). The tank below is separated by a wire rack, and collects the honey that slowly drips off the cappings. Some say the sweetest honey comes from the cappings! The model shown in Figure 14-4 also has a honey valve in the lower tank.

Figure 14-4:

A double uncapping tank helps you harvest wax cappings. It reclaims the honey that drains from the cappings.

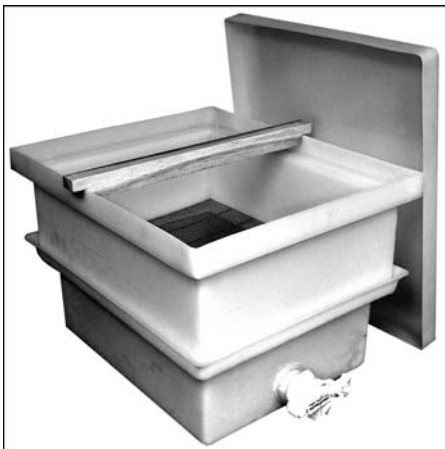

Uncapping fork

An uncapping fork is used to scratch open cappings on the honeycomb (see Figure 14-5). It can be used in place of or as a supplement to an uncapping knife (the fork opens stubborn cells missed by the knife).

Figure 14-5:

An uncapping fork is a useful tool for opening cappings missed by your uncapping knife.



Bottling bucket

Five-gallon bottling buckets are made with food-grade plastic and include a honey gate. They come with airtight lids and are handy for storing and bottling honey. Each pail holds nearly 60 pounds of honey. I always keep a few of them on hand (see Figure 14-6).

Figure 14-6:

The honey gate valve on this five-gallon bucket makes bottling your honey a breeze.



Solar wax melter

Aside from honey, one of the most important products of the hive is beeswax. From the wax you can make candles, furniture polish, and cosmetics. Your primary harvest of wax is the result of the cappings that you cut from the comb during the honey extraction process. These cappings (and any burr comb that you trim from the hive during the year) can be placed in a solar wax melter and melted. A single hive yields enough surplus wax to make a few candles and some other wax products (such as wax polish or hand cream).

You can obtain a *solar wax melter* by purchasing it from your bee supplier or by making one yourself (see Figure 14-7). It typically consists of a wooden box containing a metal pan, covered with a glass lid. The sun melts the wax, which is collected in a tray at the base of the unit. It's a handy piece of equipment if you plan to make use of all that wax.



Figure 14-7:
You can use
a solar wax
melter to
begin the
rendering
process.
Very green!

Comb honey equipment

Harvesting comb honey boils down to two basic equipment choices, using section comb cartridges or the cut-comb method. Either works fine. You'll need special equipment on your hives to produce these special kinds of honey. See Chapter 4 for additional information about comb honey production.

Section comb cartridges

Honeycomb kits consist of special supers containing wooden or plastic section comb cartridges. Each cartridge contains an ultrathin sheet of wax foundation. Using them enables the bees to store honey in the package that ultimately is used to market the honeycomb. My favorite kit — Ross Rounds — makes circular section comb in clear plastic containers. This is a product with enormous eye-appeal!



You typically need a strong nectar flow to encourage the bees to make any kind of section comb honey.

Cut comb

The cut-comb method uses conventional honey supers and frames, but it also uses a special foundation that is ultrathin and unwired. Once bees fill the frames with capped honey, the comb is cut from the frames. You can use a knife, or a *comb honey cutter*, which looks like a square cookie cutter and makes the job easy.

Honey containers

Select an attractive package for your honey (jar, bottle, and so on). Many options are available to you, and quite frankly, any kind of container will do. Clear containers are best, because customers want to be able to see what they're getting. Either plastic or glass is okay to use. You can purchase all kinds of specialized honey bottles from your beekeeping supplier. Or simply use the old mayonnaise and jam jars that you've been hoarding.

Planning Your Honey Harvest Setup

Giving some thought to where you plan to extract and bottle your honey is important. You can use your basement, garage, tool shed, or even your kitchen. You don't need a big area. If you have only a few hives, harvesting is a one-person job. But be prepared — you'll likely get plenty of volunteers who want to help out. The kids in my neighborhood are eager to lend a hand in exchange for a taste of my *liquid candy*. The guidelines in the following list will help you choose the best location:



- ✔ **The space you choose must be absolutely beettight.** That is to say, you don't want any bees getting into the space where you're working. The smell of all that honey will attract them, and the last thing you want is hundreds (or thousands) of ravenous bees flying all about.
- ✔ **Never, ever attempt to harvest your honey outdoors.** If you do, disaster is imminent! In short order you'll be engulfed by thousands of bees, drawn by the honey's sweet smell.
- ✔ **Set up everything in advance, and arrange your equipment in a way that complements the sequential order of the extraction process (see Figure 14-8).**
- ✔ **Have a bucket of warm water — better yet, hot and cold running water — and a towel at the ready.** Life gets sticky when you're harvesting honey, and the water is a welcome means for rinsing off your hands and uncapping knife.
- ✔ **If you're using an electric uncapping knife, you'll need an electrical outlet.** But remember that water and electricity don't mix well, so be careful!
- ✔ **Place newspaper on the floor.** This little step saves time during cleanup. If your floor is washable, that really makes life easy!



Figure 14-8: Here's the setup, left to right, in my garage for extracting honey.

Branding and Selling Your Honey

Before you harvest your first crop of honey, you may want to give some advanced thought to the label you will put on it. You may even want to sell your honey. After all, a hundred or more bottles of honey may accommodate more toast than your family can eat! The following sections describe some ideas to help you think this through.

Creating an attractive label

An attractive label can greatly enhance the appearance and salability of your honey. It also includes important information about the type of honey and who packages it (you!). Generic labels are available from your beekeeping supplier. Or you can make your own custom label. I easily reproduce my labels (see Figure 14-9) using my computer's printer and an appropriate size of blank, self-adhesive labels.

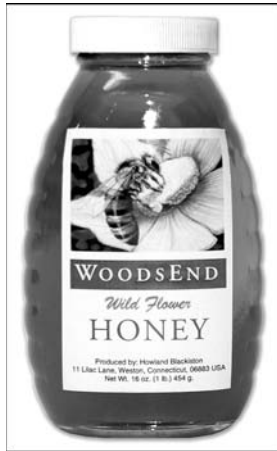

Figure 14-9:
Here's my
honey
label —
simple and
to the point.

You must include a few important bits of information on your label (assuming that you're planning to sell your honey). Listed below are label requirements that you need to keep in mind (see Figure 12-11). You must

- ✓ State what the container contains: HONEY.
- ✓ Include your name and address (as the producer).
- ✓ Report the net weight on the lower 20 percent of the label using a dual weight declaration, for example, NET WEIGHT 16 OZ. (1 lb). Federal law mandates it.

In addition to these requirements, I recommend

- ✓ Adding information about the type of honey in the package (for example, WILDFLOWER) and some marketing propaganda about the pure and wholesome nature of the product.
- ✓ Including information about the nutritional value (not usually required by law). I think it makes the product far more professional looking. For more on the wording and design of a nutritional information label, see Figure 14-10.



Go to your local market and make mental notes about commercial honey labels. Which ones appeal to you? What about them makes them look so attractive? What kind of image or graphic is used? Which colors look best? Borrow ideas shamelessly from the ones you like best — but be careful not to steal anything that may be trademarked!

Simplified Format

Helvetica Regular 8 point with 1 point of leading →

3 point rule →

1/4 point rule centered between nutrients (2 points leading above and 2 points below) →

8 point Helvetica Black with 4 points of leading →

8 point Helvetica Regular with 4 points of leading →

Nutrition Facts

Serving Size 1 Tbsp (21g)
Servings Per Container 22

Amount Per Serving

Calories 64

% Daily Value

Total Fat 0g 0%
Sodium 0g 0%
Total Carbohydrate 17g 6%
Sugars 16g
Protein 0g

*Percent Daily Values (DV) are based on a 2,000 calorie diet.

Franklin Gothic Heavy or Helvetica Black, flush left & flush right, no smaller than 13 point ←

7 point rule ←

6 point Helvetica Black ←

All labels are enclosed by 1/2 point box rule within 3 points of text measure ←

6 point with 1 point of leading ←

Figure 14-10:

These are the standard layouts and nutritional information that can appear on your label. Information in this example is based on a one-pound jar of honey.

Simplified Tabular Format

Nutrition Facts	Amount serving	%DV*	Amount serving	%DV*
Serving Size 1 Tbsp (21g) Servings 22 Calories 64				
	Total Fat 0g	0%	Total Carb. 17 g	6%
	Sodium 0 mg	0%	Sugars 16 g	
			Protein 16 g	
<small>*Percent Daily Values (DV) are based on a 2,000 calorie diet.</small>				

Simplified Tabular Format

Nutrition Facts Serv size: 1 Tbsp (21g), Servings: 22, Amount Per Serving: **Calories** 64, **Total Fat** 0g (0% DV), **Sodium** 0mg (0% DV), **Total carb**, 17g (6% DV), **Sugars** 16g, **Protein** 0g, Percent Daily Values (DV) are based on a 2,000 calorie diet.



More detailed information about creating a distinctive label is available from the National Honey Board, 390 Lashley St., Longmont, CO 80501-6045. Its Web address is: www.nhb.org.

Finding places to market your honey

An independently owned food market in your neighborhood may be interested in selling your honey. Honey is a pure and natural food, and you don't need a license to package and sell it (more detailed information is available from the National Honey Board, 390 Lashley St., Longmont, CO 80501-6045; see Web address in the previous section. Here are some other ideas:

- ✓ Check out health food stores. They're always looking for a source of fresh, local honey.
- ✓ Gift stores, craft shops, and boutiques are good places to sell local honey.
- ✓ Put up an attractive sign in front of your house: HONEY FOR SALE.
- ✓ Sell your honey at the local farmers' market.
- ✓ Don't forget to consider church fairs, synagogue bazaars, and gardening centers.
- ✓ And by all means GIVE a bottle to all your immediate neighbors. It's the right thing to do, and a great public relations gesture.

Selling your honey on the Web

This is the Web generation. So why not set up a simple Web site to sell your honey all over the world? Or use eBay. Remember that plastic honey jars are lighter to ship and less fragile than glass. This may be the time to invest in *Creating Web Pages For Dummies* for more information on that particular subject.

Chapter 15

Honey Harvest Day

In This Chapter

- ▶ Knowing when to harvest your honey
 - ▶ Extracting and bottling the easy way
 - ▶ Cleaning up
 - ▶ Harvesting wax cappings
 - ▶ Storing equipment for the next season
-

The day you've anticipated all year is finally here, and it's time to reap the rewards of all your efforts (actually the bees did most of the work, but go ahead and take the credit anyway). It's time for the honey harvest!

And what better excuse could you ever have for having a party! Harvest day always is a big event at my house — a day when neighbors and friends gather to lend a hand and get a free sample from the magic candy machine. I schedule an open house on honey harvest day, inviting anyone interested to stop by, lend a hand, see how it's done, and go home with a bottle of honey still warm from the hive. I have plenty of honey-related refreshments on hand: honey-ginger snaps, and honey-sweetened ice tea and lemonade.

I am assuming that you've decided to harvest extracted honey. That's what I recommend for new beekeepers. Harvesting extracted honey is easier for you and the bees, and you're far more likely to get a substantial crop than if you were trying to produce comb honey. *Comb honey* requires picture-perfect conditions to realize a successful harvest (large hive population, hard working and productive bees, ideal weather conditions, and excellent nectar flows).



Extracted honey refers to honey that is removed from wax comb by centrifugal force (using a device call an extractor). The honey is bottled in a liquid form, as opposed to harvesting comb or chunk honey where the honey is not removed from the wax comb before it's packaged.

Be sure to allow yourself enough time. I set aside an entire weekend for my harvest activities, part of one afternoon to get the honey supers off the hive and a good hunk of the following day to actually extract and bottle the honey.

Knowing When to Harvest

Generally speaking, beekeepers harvest their honey at the conclusion of a substantial nectar flow and when the hive is filled with cured and *capped* honey (see Figure 15-1). Conditions and circumstances vary greatly across the country. Here in Connecticut, early one spring, I had an unusually large flow of nectar from a large honey locust tree. My bees filled their honey supers before June. I harvested this rare and delicate white honey in late May. I put the supers back on and got another harvest in the late summer. More typically, I will wait until late summer to harvest my crop (usually mid-September). Where I live (in the northeastern United States) the last major nectar flow (from the asters) is over by September. First-year beekeepers are lucky if they get a small harvest of honey by late summer. That's because a new colony needs a full season to build up a large enough population to gather a surplus of honey.



I suggest that you take a peek under the hive cover every couple of weeks during summer. Note what kind of progress your bees are making and find out how many of the frames are filled with capped honey.

When a shallow frame contains 80 percent or more of sealed, *capped* honey, you're welcome to remove and harvest this frame. Or, you can practice patience — leave your frames on and wait until one of the following is true:

- ✓ The bees have filled all the frames with capped honey.
- ✓ The last major nectar flow of the season is complete.

Figure 15-1:
Here's a beautiful frame of capped honey ready to be harvested.

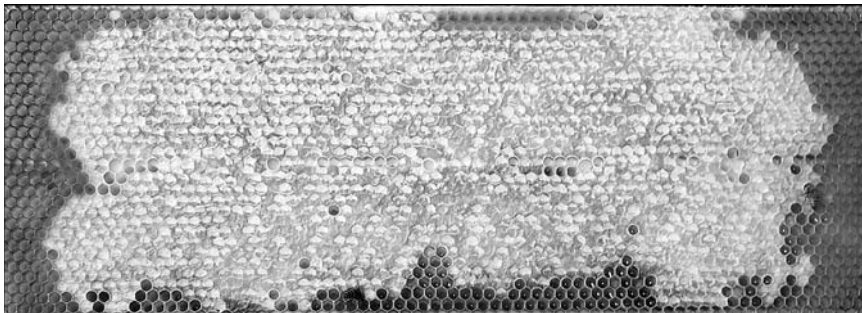



Honey in *open* cells (not capped with wax) can be extracted if it is cured. To see if it's cured, turn the frame with the cells facing the ground. Give the frame a gentle shake. If honey leaks from the cells, it isn't cured and shouldn't be extracted. This stuff is not even honey. It's nectar that hasn't been cured. The water content is too high for it to be considered honey. Attempting to bottle the nectar results in watery syrup that is likely to ferment and spoil.

Bad things come to those who wait!

You want to wait until the bees have gathered all the honey they can, so be patient. That's a virtue. However, don't leave the honey supers on the hive *too* long! I know, I know! Things tend to get busy around Labor Day. Besides spending a weekend harvesting your honey, you probably have plenty of other things to do. But don't put off what must be done. If you wait too long, one of the following two undesirable situations can occur:

- ✓ **After the last major nectar flow and winter looms on the distant horizon, bees begin consuming the honey they've made.** If you leave supers on the hive long enough, the bees will eat much of the honey you'd hoped to harvest. Or they will start moving it to open cells in the lower deep hive bodies. Either way, you have lost the honey that should have been yours. Get those supers off the hive before that happens!
- ✓ **If you wait *too* long to remove your supers, the weather turns too cold to harvest your honey.** In cool weather, honey can thicken or even granulate, which makes it impossible to extract from the comb. I discuss this later in this chapter in the "Two common honey-extraction questions" sidebar. Remember that honey is easiest to harvest when it still holds the warmth of summer and can flow easily.

Getting the Bees Out of the Honey Supers

Regardless what style of honey you decide to harvest, you must remove the bees from the honey supers before you can extract or remove the honey. You've heard the old adage, "Too many cooks spoil the broth!" Well, you certainly don't need to bring several thousand bees into your kitchen!



You must leave the bees 60 to 70 pounds of honey for their own use during winter months (less in those climates that don't experience cold winters). But anything they collect more than that is yours for the taking.



To estimate how many pounds of honey are in your hive, figure that each deep frame of capped honey weighs about 7 pounds. If you have ten deep frames of capped honey, you have 70 pounds!

Removing bees from honey supers can be accomplished in many different ways. This section discusses a few of the more popular methods that beekeepers employ. Before attempting any of these methods, be sure to smoke your bees the way you normally would when opening the hive for inspection. (See Chapter 6 for information on how to use your smoker properly.)



The bees are protective of their honey during this season. Besides donning your veil, now's the time to wear your gloves. If you have somebody helping you, be sure they are also adequately protected.

Shakin' 'em out

This bee-removal method involves removing frames (one by one) from honey supers and then shaking the bees off in front of the hive's entrance (see Figure 15-2). The cleared frames are put into an empty super. Be sure that you cover the super with a towel or board to prevent bees from robbing you of honey. Alternatively, you can use a bee brush (see Chapter 4) to gently brush bees off the frames.

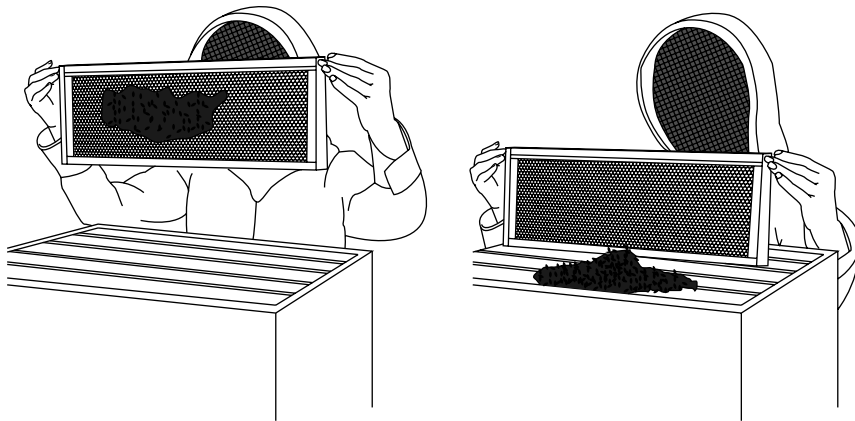

Figure 15-2:
Shaking the
bees out of
the honey
supers.



Note that the cells on comb tend to slant downward slightly — to better hold liquid nectar. Therefore, when brushing bees, you should always brush bees gently *upward* (never downward). This little tip helps prevent you from injuring or killing bees that are partly in a cell when you're brushing.

Shaking and brushing bees off frames aren't the best options for the new beekeeper, because they can be quite time consuming, particularly when you have a lot of supers to clear. Besides the action can get pretty intense around the hive during this procedure. The bees are desperate to get back into those honey frames, and, because of their frenzy, you can become engulfed in a fury of bees. Don't worry — just continue to do your thing. The bees can't really hurt you, provided you're wearing protective gear.

Blowin' 'em out

One fast way to remove bees from supers is by blowing them out, but they don't like it much. Honey supers are removed from the hive (bees and all) and stood on end. By placing them 15 to 20 feet away from the hive's entrance and using a special bee blower (or a conventional leaf blower), the bees are blasted from the frames at 200 miles an hour. Although it works, to be sure, the bees wind up disoriented and *very* irritated. Oh goodie. Again, I wouldn't recommend this method for the novice beekeeper.



A bee blower is basically the same as a conventional leaf blower, just packaged differently and usually more expensive.

Using a bee escape board

Yet another bee-removal method (and far less dramatic) places a bee escape board between the upper deep-hive body and the honey supers that you want to clear the bees from. Various models of *escape boards* are available, and all work on the same principle: The bees can travel down to the brood nest, but they can't immediately figure out how to travel back up into the honey supers. It's a one-way trip. (See Figure 15-3 for an example of a triangle bee escape with a maze that prevents the bees from finding their way back up into the honey supers.)



Bee escapes work okay, but it takes a few days for the bees to be cleared from the honey supers. You must install the escape boards 48 hours *before* you plan to remove the honey supers. It takes that long to clear the bees. And, the thing is, you can't leave the escape board on for *more* than 48 hours, or the bees eventually solve the puzzle and find their way back into the supers. For me, a weekend beekeeper, the timing of all this is quite impractical.

Figure 15-3: This triangle bee escape enables bees to easily travel down into the top deep, but it takes the bees a while to figure out how to get back up into the honey supers.

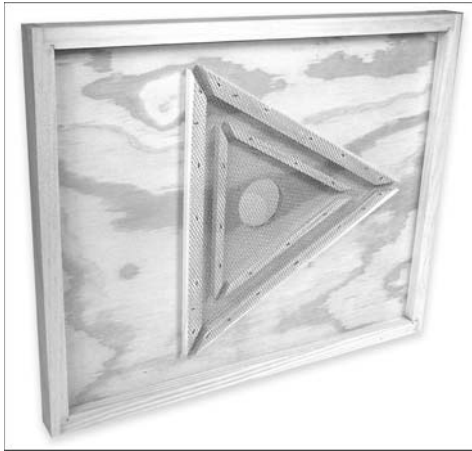

Fume board and bee repellent

Here's my favorite method — a fume board and bee repellent! It's fast and highly effective. And it's made even more desirable because of a wonderful new product on the market (more about that later in this section).

A *fume board* looks like an outer cover with a flannel lining. A liquid bee repellent is applied to the flannel lining and the fume board is placed on top of the honey supers (in place of the inner and outer covers). Within five minutes, the bees are repelled out of the honey supers and down into the brood chamber. Instant success! The honey supers can then be safely removed and taken to your harvesting area.

In the past, chemicals used as repellents (either butyric propionic anhydride or benzaldehyde) have been hazardous in nature. They're toxic, combustible, and may cause respiratory damage, central nervous system depression, dermatitis, and liver damage. Need I say more? It's simply nasty stuff to have around the house.

In addition, the stench of each of these products is more than words can politely express. All that has changed with the introduction of a product called Fischer's Bee-Quick (see Figure 15-4). This product repels the bees, but it is nonhazardous and made entirely from natural ingredients. Best of all, its almond-vanilla scent smells good enough to be a dessert topping!

Figure 15-4:
A safe and fast way to get bees out of honey supers is to use a fume board with Fischer's Bee-Quick.



Here are step-by-step instructions for using a fume board with Fischer's Bee-Quick:

1. **Smoke your hive as you would for a normal inspection.**
2. **Remove the outer and inner covers, and the queen excluder.**
3. **Use your smoker on the top honey super to drive the bees downward.**
4. **Sprinkle Fischer's Bee Quick on the fume board's felt pad in a zigzag pattern (as if corresponding to spaces between the frames) across the full width of the fume board.**

Don't overdo it. About one ounce or less should do the trick (use more in cold, cloudy weather, less in hot, sunny weather). When in doubt . . . use less.

5. **Place fume board on the uppermost honey super and wait three to five minutes for the bees to be driven out (this method works most effectively when the sun is shining on the fume board's metal cover).**
6. **Remove the fume board and confirm that most or all of the bees have left the super. They have? Good.**
7. **Now remove the top honey super. Put the super aside and cover it with a towel or extra hive cover to avoid robbing (discussed in the next section).**
8. **Repeat the process for subsequent honey supers.**



Keep in mind that a shallow super full of capped honey can weigh 30 to 40 pounds. You'll have a heavy load to move from the beeyard to wherever you'll be extracting honey. So be sure to save your back and take a wheelbarrow or hand truck with you when removing honey supers from the hive. Figure 15-5 shows a hive carrier.

You can store your frames of honey (briefly) before extracting

Extracting your honey as soon as you can after taking the honey supers off the hive is best. I try to schedule my extraction activities either on the same day that I remove the supers from the hive or the day following removal. If that isn't practical, you can temporarily store your shallow supers in a bee-tight room where the temperature is between 80 and 90 degrees F. Honey that's kept warm is much easier to extract and strain and is far less likely to granulate. A new

beekeeper with one or two hives can expect to spend 3 to 5 hours on the extraction process.

Under no circumstances leave honey supers uncovered where bees can get access to them. Unless you want to see something really exciting! Specifically, you will set off what called a "robbing frenzy". Dramatic, but not a good thing. When you remove honey supers, get them away from the hives and in a "bee-tight" room as soon as possible.

Figure 15-5:

If you have a friend to help, a hive carrier like this makes carrying heavy supers and hive bodies much easier.

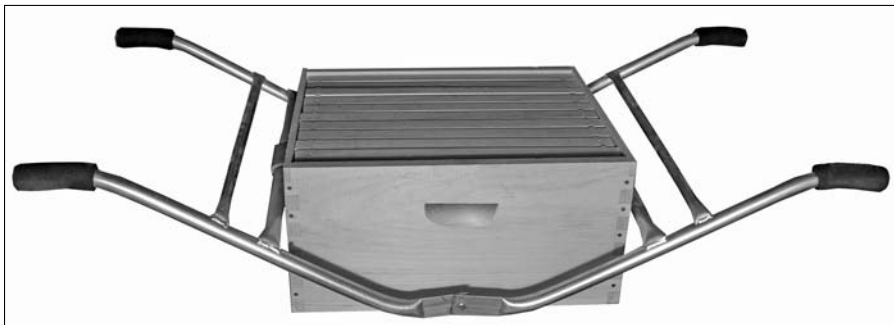

Honey Extraction 101

Once the bees are out of the honey supers, you need to be prepared to process your honey as soon as possible (within a few days). Doing so minimizes the chance of a wax moth infestation, discussed in the "Controlling wax moths" section later in this chapter. Besides, extracting honey is easier to do when the honey is still warm from the hive as it flows much more freely.



For a description of the various tools used in the honey-extraction process (uncapping knife, honey extractor, bucket of warm water, a towel, and so forth) see Chapter 14.

Follow this procedure when extracting honey from your frames:

1. One by one, remove each frame of capped honey from the super.

Hold the frame vertically over the uncapping tank and tip it slightly forward. This helps the cappings fall away from the comb as you slice them.

2. Use your electric uncapping knife to remove the wax cappings and expose the cells of honey.

A gentle side-to-side slicing motion works best, like slicing bread. Start a quarter of the way from the bottom of the comb, slicing upward (see Figure 15-6). Keep your fingers out of harm's way in the event the knife slips. Complete the job with a downward thrust of the knife to uncapping the cells on the lower 25 percent of the frame.

3. Use an uncapping fork (also called *cappings scratcher*) to get any cells missed by the knife.

Flip the frame over, and use the same technique to do the opposite side.

I discuss what you should do with the wax cappings, particularly if you want to use them for craft purposes, later in this chapter.

4. When the frame is uncapped, place it vertically in your extractor (see Figure 15-7).

An *extractor* is a device that spins the honey from the cells and into a holding tank.

Once you've uncapped enough frames to fill your extractor, put the lid on and start cranking. Start spinning slowly at first, building some speed as you progress. Don't spin the frames as fast as you can, because extreme centrifugal force may damage the delicate wax comb. After spinning for five to six minutes, turn all the frames to expose the opposite sides to the outer wall of the extractor. After another five to six minutes of spinning, the comb will be empty. The frames can be returned to the shallow super.

5. As the extractor fills with honey, it becomes increasingly difficult to turn the crank (the rising level of honey prevents the frames from spinning freely), so you need to drain off some of the harvest.

Open the valve at the bottom of the extractor and allow the honey to filter through a honey strainer and into your bottling bucket.

6. Use the valve in the bottling bucket to fill the jars you've designed for your honey.

Brand it with your label, and you're done! Time to clean up.



Figure 15-6:

Removing wax cappings using an electric uncapping knife. The uncapping tank below is a nifty accessory for collecting and draining the cappings.



Figure 15-7:

Place the uncapped frame vertically in the extractor.



Two common honey-extraction questions

Here's a question I'm frequently asked: *When I spin frames in my honey extractor, the entire unit wobbles uncontrollably, dancing across the floor. How do I prevent this from happening?*

This shimmy happens when the load in the extractor is unbalanced. Make sure you have a frame in each of the basket's slots. Try redistributing the weight in the basket. Place frames of similar weight opposite each other. It's kind of like rearranging the wash load in the washing machine during the spin cycle. Some extractors can be bolted to a sturdy table — that helps.

Another frequently asked question I receive is: *The honey in some of my shallow frames has granulated. I cannot remove the granulated*

honey using my extractor. How can I extract granulated honey from the honeycomb?

Unfortunately, no practical way to extract granulated honey from the honeycomb exists without destroying the honeycomb (melting the comb and wax, and then separating the wax once it floats to the top and solidifies). I suggest that you put supers with granulated honey back on the hives in the early spring. Before you do, scratch the cappings with an uncapping fork, exposing the honey to the bees. They'll consume the granulated honey and leave the combs sparkling clean and ready for a new harvest. **Note:** Don't feed your bees granulated honey in late autumn, because it can give them dysentery.



Honey is *hygroscopic* — meaning that it absorbs moisture from the air. On the positive side, this is why baked goods made with honey stay moist and fresh. On the negative side, this means you must keep your honey containers tightly sealed, otherwise your honey will absorb moisture, become diluted, and eventually ferment.



Having enough honey jars and lids on hand is important. Standard honey jars are available in 1-, 2- and 5-pound sizes. You can estimate that you'll harvest about 30 pounds of honey from each shallow honey super (assuming all of the frames are full of honey).

Cleaning Up After Extracting

Never store extracted frames while they're wet with honey. You'll wind up with moldy frames that have to be destroyed and replaced next year. You've got to clean up the sticky residue on the extracted frames. How? Let the bees do it!

At dusk, place the supers with the empty frames on top of your hive (sandwiched between the top deep and the inner and outer covers). Leave the supers on the hive for a few days, and then remove them (you may have to coax the bees from the supers using a bee escape or fume board). The bees

will lick up every last drop of honey, making the frames bone dry and ready to store until next honey season. Be sure to treat your frames with wax moth control before storing them away for the winter (see the next section).

Controlling wax moths

There's a good chance that honey supers stored over the winter will become infested with wax moths. It happens. The adult moth lays eggs on beeswax comb before the hives are stored for the winter. The developing larvae tunnel their way through the wax comb, leaving a crisscrossed pattern of silky trails. In time, all the frames are destroyed and become useless. What a disheartening sight to discover this damage. You can help prevent wax moth damage in stored honey supers by:

✓ Fumigating them with PDB.

My favorite solution is to treat stored supers with wax moth control crystals (paradichlorobenzene, or PDB; see Figure 15-8). This product is available from your bee supplier. Place a tablespoon of PDB crystals on an index card and put the card on the top bars of the super to be stored. Do this for every super that you plan to store, stacking them one on top of another, like so many floors of a building.

Top the whole stack with an outer cover. Make sure there are no gaps or cracks. You want the slowly evaporating crystals to fumigate all the frames while they're stored over the winter. If you've drilled any ventilation holes in the supers, make sure they're taped shut.

Store supers in any area where the air temperature is above 60 degrees F. When spring arrives, and you're ready to place the honey supers on your hive, be sure to air them out for 48 hours before using them.



Figure 15-8: Using PDB crystals on stored supers eliminates the possibility of damage from wax moth larvae.

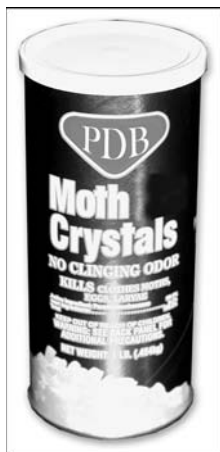



PDB crystals are not the same as other moth control products made from *naphthalene*. Don't confuse the two. PDB is ok to use, as it is not absorbed by the wax. But moth control products made from naphthalene contaminate the wax and will kill your bees when the supers are reintroduced into the hive. Read labels carefully!

✓ **Freezing the combs.**

You can destroy wax moth larvae by placing the frames in the deep-freezer for 24 hours. This assumes, of course, that you have a really big freezer! Then put the frames back in the supers and store them in tightly sealed, plastic garbage bags. The colder the storage area, the better.

Harvesting wax

When you extract honey, the cappings that you slice off represent your major wax harvest for the year. You'll probably get one or two pounds of wax for every 100 pounds of honey that you harvest. This wax can be cleaned and melted down for all kinds of uses (See the section on beeswax in Chapter 14). Pound for pound, wax is worth more than honey, so it's definitely worth a bit of effort to reclaim this prize. Here are some guidelines:

1. Allow gravity to drain as much honey from the cappings as possible.

Let the cappings drain for a few days. Using a double uncapping tank greatly simplifies this process.

2. Place the drained cappings in a five-gallon plastic pail and top them off with warm (not hot) water.

Using a paddle — or your hands — slosh the cappings around in the water to wash off any remaining honey. Drain the cappings through a colander or a honey strainer and repeat this washing process until the water runs clear.

3. Place the washed cappings in a double boiler and melt the wax.

Always use a double boiler for melting beeswax (never melt beeswax directly on an open flame, because it is highly flammable). And *never, ever* leave the melting wax — even for a moment. If you need to go to the bathroom, turn off the stove!

4. Strain the melted beeswax through a couple of layers of cheesecloth to remove any debris.

Remelt and restrain as necessary to remove all impurities from the wax.

5. The rendered wax can be poured into a block mold for later use.

I use an old cardboard milk carton. Once the melted wax has solidified in the carton, it can easily be removed by tearing away the carton. You're left with a hefty block of pure, light-golden beeswax.



Part VI

The Part of Tens

The 5th Wave

By Rich Tennant



"Remind me the next time we're harvesting honey not to sit down and pet the cat afterwards."

In this part . . .

In this part, I offer a collection of fun lists, frequently asked questions, and honey recipes.

Chapter 16

(Almost) Ten Fun Things to Do with Bees

In This Chapter

- ▶ Combining, dividing, and building hives
 - ▶ Planting a garden for your bees
 - ▶ Brewing mead: The nectar of the gods
 - ▶ Creating useful gifts from propolis and beeswax
-

One of the glorious things about keeping bees is that your interests can expand way beyond the business with your smoker and hive tool. Beekeeping opens up entire new worlds of related hobbies and activities — horticulture, carpentry, biology, and crafts just to name a few. That’s been a good thing for me, because living in Connecticut, as I do, the winters were unbearably long when I couldn’t play with my bees. I really missed them! But now, having gotten drawn into some of these “related” hobbies, I can hardly find time to sit and think. Here are a few of the bee-related activities whose sirens have beckoned to me over the years.

Making Two Hives From One

If you’re like most beekeepers I know, it’s only a matter of time before you start to ask yourself, “Gee, wouldn’t it be twice as much fun to have twice as many hives?” Well, actually it is. And the neat thing is that you can create a second colony from your existing colony. You don’t even have to order another package of bees! Free bees! Ah, but here’s the dilemma! You’ll need a new queen for your new colony. Strictly speaking, you don’t have to order a new queen. You can let the bees make their own; however, ordering a new queen is simply faster and more foolproof. I discuss the nuances of ordering a new queen later in this chapter. Or if you want to get really adventurous, you can raise your own queen (see Chapter 13).

To make two hives from one, you first need a strong, healthy hive. That's just what you hope your hive will be like at the start of its second season — boiling with lots and lots of busy bees. The procedure is known as *dividing* or *making a divide*.



Dividing not only enables you to start a new colony, it's also considered good bee management — dividing thins out a strong colony and prevents that colony from swarming.

The best time to make a divide is in the early spring about a month before the first major nectar flow. Follow these steps in the order they are given:

1. Check your existing colony (colonies) to determine whether you have one that's strong enough to divide.

Look for lots of bees, and lots of capped brood (six frames of capped brood and/or larvae are ideal). The situation should look crowded.

2. Order a new hive setup from your bee supplier.

You'll want hive bodies, frames, foundation — the works. You need the elements to build a new home for your new family.

3. Order a new queen from your bee supplier.

Alternatively, you can allow the new colony to raise its own queen. See Chapter 12.



Your new queen doesn't have to be marked, but having a marked queen is a plus, particularly when you're looking for her because the mark makes her easier to identify. I advise you, a new beekeeper, to let your bee vendor mark your queen. A novice can end up killing a queen by mishandling her.

4. Put your new hive equipment where you plan to locate your new family of bees.

You'll need only to put out one deep hive body at this point — just like when you started your first colony (see Chapter 5). Remove four of the ten foundation frames and set them aside. You'll need them later.

5. When your new marked queen arrives, it's time to divide!

Smoke and open your existing colony as usual.

6. Find the frame with the queen and set it aside in a safe place.

An extra empty hive body and cover will do just fine. Better yet, use a small “nuc” hive (available from your supplier). These mini-hives contain only five frames.

- 7. Now remove three frames of capped brood (frames with cells of developing pupae) plus all the bees that are on each of them.**

Place these three brood frames and bees in the center of the new hive. I know, I know — that still leaves one slot open because your removed *four* frames of foundation. The extra slot, however, provides the space that you'll need to hang the new queen cage (see Step 8).

- 8. Using two frame nails, fashion a hanging bracket for the new queen cage (candy side up) and hang the cage between brood frames in the middle of the new hive. Alternatively if the weather is nice and warm, you can use the Bottom Board installation technique. See Chapter 9).**

Make sure you have removed the cork stopper or metal disc, revealing the candy plug. This is the same queen introduction technique that you used when you installed your first package of bees (see Chapter 5).

- 9. Put a hive-top feeder on your new colony and fill it with sugar syrup.**
- 10. Turn your attention back to the original hive.**

Carefully put the frame containing the queen back into the colony. Add three of the new foundation frames (to replace the three brood frames that you removed earlier). Place these frames closest to the outer walls of the hive.

- 11. Add a hive-top feeder to your original hive and fill it with sugar syrup.**

Congratulations, you're the proud parent of a new colony! But wait, you say, "I've got one new frame of foundation left over." Good. That's what you'll use next week to replace what will then be an empty queen cage. If you used the bottom board installation technique, this step is eliminated.

Making One Hive From Two

Keep in mind that it's better to go into the winter with strong colonies — they have a far better chance of making it through the stressful cold months than do weak ones.

If you have a weak hive, you can combine it with a stronger colony. If you have two weak hives, you can combine them to create a robust colony. But you can't just dump the bees from one hive into another. If you do, all hell will break loose. Two colonies must be combined slowly and systematically so that the hive odors merge gradually — little by little. This is best done late in the summer or early in the autumn (it isn't a good idea to merge two colonies in the middle of the active swarming season).

My favorite method for merging two colonies is the so-called *newspaper method*. A single sheet of newspaper separates the two hives that you'll combine. Follow these steps in the order they are given:

1. Identify the stronger of the two colonies.

Which colony has the largest population of bees? Its hive should become the home of the combined colonies. The stronger colony stays put right where it's now located.

2. Smoke and open the weaker colony (see Chapter 6 for instructions).

Manipulate the frames so that you wind up with a single deep hive body containing ten frames of bees, brood, and honey. In other words, consolidate the bees and the ten *best* frames into one single deep. The "best" frames are those with the most capped brood, eggs, and/or honey.

3. Smoke and open the stronger hive.

Remove the outer and inner covers and put a single sheet of newspaper on the top bars. Make a small slit, or poke a few holes in the newspaper with a small nail. This helps hive odors pass back and forth between the strong colony and the weak one that you're about to place on top.

4. Take the hive body from the weak colony (it now contains ten consolidated frames of bees and brood) and place it directly on top of the stronger colony's hive.

Only the perforated sheet of newspaper separates the two colonies (see Figure 16-1).

5. Add a hive-top feeder and fill it with sugar syrup.

The outer cover goes on top of the feeder. No inner cover is used when using a hive-top feeder.

6. Check the hive in a week.

The newspaper will have been chewed away, and the two colonies will have happily joined into one whacking strong colony. The weaker queen is now history, and only the stronger queen remains.

7. Now you have the task of consolidating the three deeps back into two.

Go through all the frames, selecting the 20 best frames of honey, pollen, and brood. Arrange these in the lower two deeps. Frames with mostly brood go into the bottom deep, and frames with mostly honey go into the upper deep. Shake the bees off the ten surplus frames and into the lower two deeps (save these frames and the third hive body as spares).

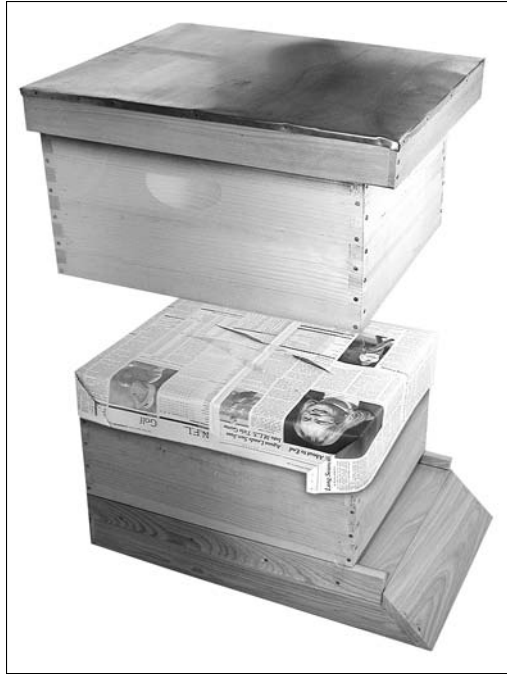

Figure 16-1:

A weak colony can be combined with a strong colony by using the newspaper method.

Establishing a Nucleus Hive

A nucleus hive (often called a “nuc”; see Chapter 5) is created by stocking a special miniature hive with a few frames of bees and brood from one of your colonies (see Figure 16-2). Why create a nuc? Some of the reasons include

- ✔ A nuc can serve as nursery for raising new queens (see Chapter 12).
- ✔ A nuc provides you with a handy source of brood, pollen, and nectar to supplement weaker colonies (kind of like having your own dispensary).
- ✔ A nuc can be sold to other beekeepers — they’re a great way to start a new colony.
- ✔ A nuc can be used to populate an observation hive.
- ✔ A nuc in the corner of a garden can help with pollination and be far less maintenance than a regular hive.

The big disadvantage of a nuc is that it will not overwinter in colder climate zones. Not enough bees or stored honey is available to see them through the cold months. However you can feed the colony using an entrance feeder, but if you live in an area where the winters are cold, you should combine your nuc with one of your big hives before Jack Frost pays a visit.



Figure 16-2:

A nuc hive doesn't take much room and can be a handy resource for the backyard beekeeper.

Starting an Observation Hive

An observation hive is a small hive with a glass panel that enables you to observe a colony of bees without disturbing them or risking being stung. Such hives usually are kept indoors but provide access for the bees to fly freely from the hive to the outdoors (a tube or pipe creates a passage way from the observation hive to outside).

I'm a big believer in having an observation hive — even when you have conventional hives in your garden. The pleasure and added insight they give you about honey bee behavior is immeasurable. Among a few of the rewards you can realize from setting up an observation hive are that it:

- ✔ Gives you a barometer on what's happening in a bee colony at any given time of year. That way you can anticipate the needs of your outdoor colonies and better manage your hives. Note that the behavior of bees in an observation hive is influenced by the weather outside (not by the environment indoors).
- ✔ Makes possible safe close-up observation of bee behavior. And because you can watch the bees without smoking or opening the hive, the bees' behavior is far more natural. You'll see things that you can never witness while inspecting a conventional hive. I've watched the queen laying eggs, the hive preparing for a swarm, and bees emerging from their cells. I've also studied the bees' remarkable communication dances and much more.
- ✔ Provides — because it's kept *indoors* — year-round enjoyment. No need to be a seasonal beekeeper, because you can observe your bees even in the dead of winter.
- ✔ Serves as a fantastic educational tool for all ages and a stunning conversation piece in your home. Spend endless hours admiring the remarkable world of the honey bee.
- ✔ Enables you to enjoy the pleasures of beekeeping from the comfort of your home, especially when you don't have the space to keep bees outdoors or can't physically manage a robust outdoor hive.

Observation hives come in all sizes and styles. Many on the market contain a mere frame or two. These smaller observation hives are great for toting to garden shows, classrooms, or wherever you might do a “show and tell” about beekeeping. But practical observation hives for year-round enjoyment are at least three-frames thick. Observation hives that are only one- or two-frames thick don't have enough volume for housing a decent-sized colony that can survive during the winter months. A colony needs ample room to grow and survive on a year-round basis. Furthermore, the bees' behavior is far more natural when they have generous enough space to raise brood and create adequate stores of honey. My favorite design includes three deep frames for brood and three shallow frames for food storage (see Figure 16-3). All observation hives make allowances for feeding the colony sugar syrup (something that you'll have to do on a year-round basis).

A nice six-frame observation hive is available from www.bee-commerce.com, 11 Lilac Lane, Weston, CT 06883. Call 203-222-2268. For detailed information about setting up, maintaining, and using an observation hive, I recommend the book *Observation Hives* by Thomas Webster and Dewey Caron (The A.I. Root Company, Medina, OH, 1999, ISBN: 0-936028-12-2).

Figure 16-3:
The six-frame design of this observation hive means it will overwinter well. The invisible, built-in hive-top feeder is esthetically pleasing and a big convenience for the owner.



Planting Flowers for Your Bees

This section was prepared by my friend Ellen Zampino, an avid gardener and an excellent beekeeper.

Flowers and bees are a perfect match. Bees gather nectar and pollen enabling plants to reproduce. In turn, pollen feeds baby bees, and nectar is turned into honey to be enjoyed by the bees and you. Everyone's happy.

While many kinds of trees and shrubs are bees' prime source of pollen and nectar, a wide range of flowers contributes to bee development and a bumper crop of honey. You can help in this process by adding some of these flowers to your garden or by *not* removing some that already are there. Did you know that many weeds actually are great bee plants, including the pesky dandelion, clover, goldenrod, and purple vetch? You can grow all kinds of flowering plants in your garden that not only will add beauty and fragrance to your yard but also give bees handy sources of pollen and nectar. You'll hear the warm buzz of bees enjoying them before you even realize the plants are in bloom.

Each source of nectar has its own flavor. A combination of nectars produces great tasting honey. Not all varieties of the flowers described in the sections that follow produce the same quality or quantity of pollen and nectar, but the ones that I list here work well, and bees simply love them.

Asters (Aster/Callistephus)

The *Aster family* has more than 100 different species. The aster is one of the most common wildflowers ranging in color from white and pink to light and dark purple. They differ in height from 6 inches to 4 feet and can be fairly bushy. Asters are mostly perennials, and blooming times vary from early spring to late fall. However, like all perennials, their blooming period lasts only a few weeks. Several varieties can be purchased as seeds, but you'll also find some aster plants offered for sale at nurseries.

Callistephus are china asters, which run the same range of colors, but produce varied styles of flowers. These pincushions-to-peony style flowers start blooming late in summer and continue their displays until frost. They are annuals. Plants can be bought potted from local nurseries or purchased by seed.

Sunflowers (Helianthus/Tithonia)

Sunflowers are made up of two families. They provide the bees with pollen and nectar. Each family is readily grown from seed, and you may find some nurseries that carry them as potted plants. When you start sunflowers early in the season, make sure that you use peat pots. They are rapid growers that transplant better when you leave their roots undisturbed by planting the entire pot. *Helianthus annuus* include the well-known giant sunflower as well as many varieties of dwarf and multibranched types. Sunflowers no longer are only yellow. They come in a wide assortment of colors, from white to rust and even several varieties of mixed shades. Watch out for the hybrid that is pollenless, because it is of little use to the bees.

Salvia (Salvia/Farinacea-Strata/Splendens)

The *Salvia family*, with more than 500 varieties, includes the sages (*Salvia officinalis*) and many bedding plants. The sages are good nectar providers. When in bloom, they're covered with bees all day long. The variety of colors and sizes of the *Farinacea* and *Splendens* cover the entire gambit from white, apricot, all shades of red, and purple, to blues with bicolors and tricolors. They're easily found potted in garden stores or available as from seed. *Salvia officinalis* is the sage herb that you can use in cooking.

Bee balm (Monarda)

Bee balm (*Monarda didyma*) is a perennial herb that provides a long-lasting display of pink, red, and crimson flowers in midsummer. They start flowering when they reach about 18 inches and continue to grow to 3 or 4 feet in height. Deadheading them encourages more growth, which can prolong their flowering period. Bee balm is susceptible to powdery mildew but the Panorama type does a good job of fending off this problem. Bee balm is a good source of nectar for bees as well as butterflies and hummingbirds. This family also includes horsemint (*M. punctata*), and lemon mint (*M. citriodora*). The fragrant leaves of most of these plants are used in herbal teas. They are easily found in seed catalogs. Several varieties usually are available at local nurseries.

Hyssop (Agastache)

Anise hyssop (*Agastache foeniculum*) has a licorice fragrance when you bruise its leaves. It produces tall spikes of purple flowers in midsummer. Sometimes you can find a white variety of this plant. The bees happily gather nectar from it. Hyssop flowers from seed the first year that you plant it. Another common hyssop is found in the wild — *Agastache nepetoides*. It has a light, yellowish flower and is found in wooded areas. The seed for this variety is more difficult to find, but some seed houses carry them.

Mint (Mentha)

Chocolate, spearmint, apple mint, peppermint, and orange mint are only a few of the types of mints available. They come in a variety of colors, sizes, fragrances, and appearances, but when they produce a flower, bees are there. Most mints bloom late in the year. Some can be easily grown by seed; other varieties you can start from roots. Mints are easily obtained because they spread readily, and many gardeners are happy to share their plants. Most nurseries carry peppermint and spearmint.

Cleome/Spider flower (Cleome)

Spider flower (*Cleome hasslerana*) is heat and drought tolerant and grows well in the cold Northeast. This annual is easy to start from seed and grows more than 4 feet tall with airy flowers that are 6 to 8 inches across. It comes in white, pink, and light purple and adds an unusual flower to your garden. It's also a good producer of nectar for the bees, blooming from midsummer to fall.

Thyme (Thymus)

Thyme varieties are low-growing hardy herbs. Common, French, wooly, silver, and lemon are but a few of the varieties available. Several are used in cooking. In spring most nurseries have large selections. These varieties

also can be started by seed at least two to three months before planting. Put plants between your steppingstones or at the edges of your garden beds. They bloom from midsummer on. Bees will cover them most of the day gathering nectar, which is aromatic and produces nice-tasting honey.

Poppy (Papaver/Eschscholzia)

Danish flag (*Papaver somniferum*), corn poppy (*P. rhoeas*), and Iceland poppies (*P. nudicaule*) are easily grown from seed. Some are deep scarlet or crimson, but others are found in pastel shades. All bloom freely from early summer to fall, need full sun, and grow 2 to 4 feet tall. Literature claims that poppies are valuable mostly for the pollen, but I'm sure my bees also are gathering a fair amount of nectar.

California poppies (*Eschscholzia*) are golden orange and easily grown. They are a good pollen source for honey bees. California poppies will self-seed in warmer climates.

Bachelor's buttons (Centaurea)

Annual and perennial selections of bachelor's buttons are available. The annuals (*Centaurea cyanus*, *C. imperialis*), found in shades of white, pink, yellow, purple, and blue, also are referred to as cornflowers.

The perennial version is a shade of blue that blooms early in summer, and sometimes again in late fall. They're sometimes referred to as mountain blue buttons. Annual and perennial varieties produce an ample supply of nectar. They're easily grown from seed, and most nurseries have the annual variety available as potted plants.

Building Your Own Hives

If you're reasonably handy with woodworking, you can build your own hive parts from scratch. Here are some plans to help you along (see Figure 16-4). Remember that precise measurements are critical within a hive. Bees require a precise "bee space" (5/16"). If you wind up with too little space for the bees, they'll glue everything together with propolis. Too much space and they will fill it with burr comb (wax comb built by the bees to fill large voids in the hive). Either way, it makes the manipulation and inspection of frames impossible. So, measure twice and cut once!

Commercial makers of bee equipment typically use pine and cypress. These woods are cost effective and easy to work with. But why not give your bees a treat, and spoil them with a hive fashioned from some exotic hardwood? Central American cocobolo or flame mahogany certainly would turn some heads!



Bee space refers to the critical measurement between hive parts that enables bees to freely move about the hive. The space measures $\frac{5}{16}$ inch (1 cm).

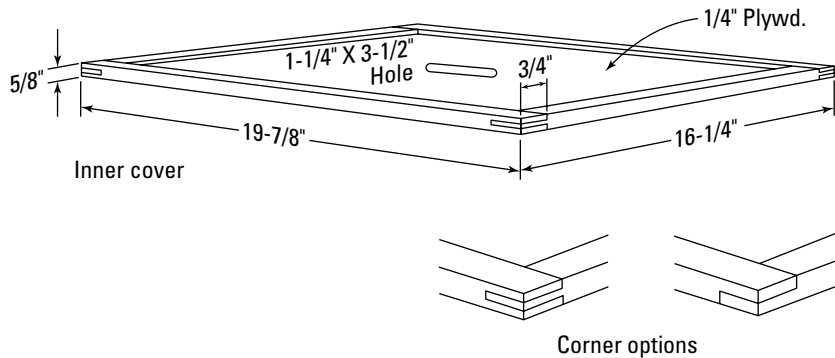
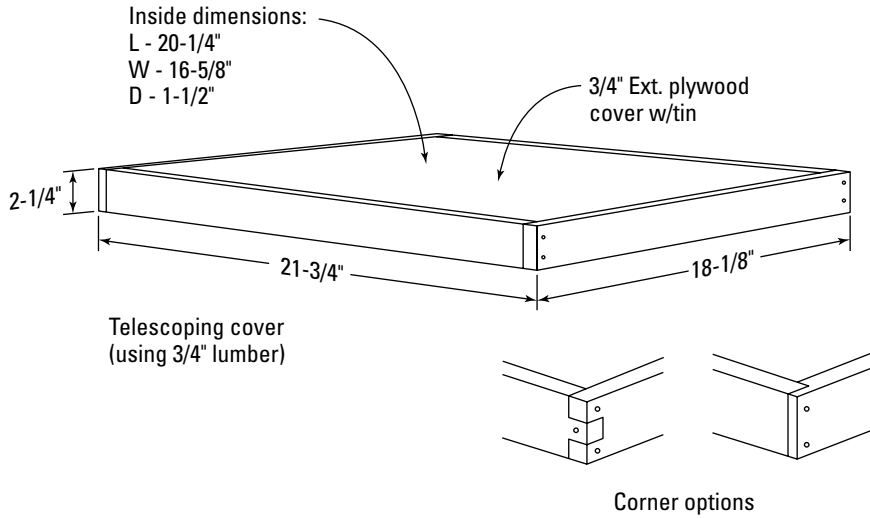
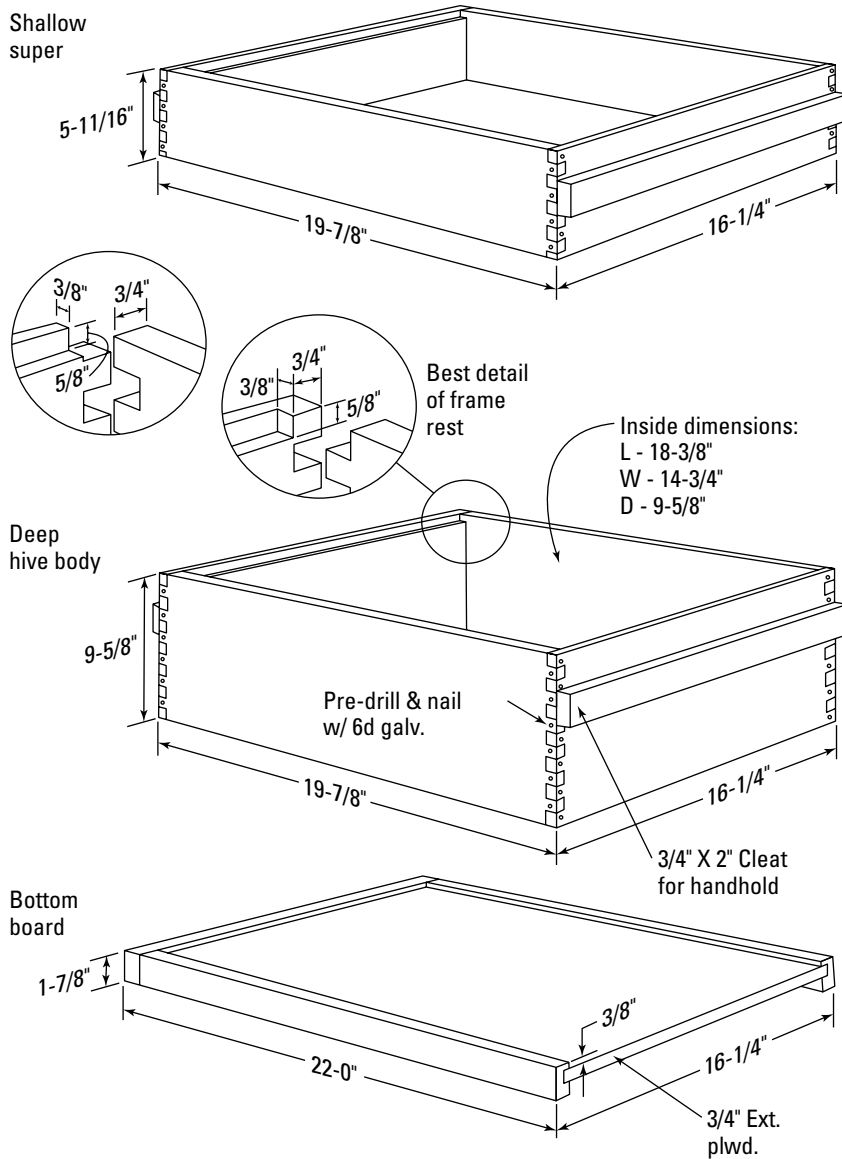

Figure 16-4: These blue-prints will serve as a guide if you decide to build your own hive.

Courtesy of Barry Birkey and www.beesource.com



Courtesy of Barry Birkey and www.beesource.com

Brewing Mead: The Nectar of the Gods

I get restless every winter when I can't tend to my bees. So a number of years ago I looked around for a related hobby that would keep me occupied until spring. I thought, "Why not brew mead?" Mead is a wine made from honey instead of grapes. It was the liquor of the Greek gods and is thought by scholars to be the oldest form of alcoholic beverage. In early England and until about 1600, mead was regarded as the national drink. In fact, the wine that Robin Hood took from Prince John had honey as its base.

When mead is made right, the resulting product is simply delicious! And like a fine, red wine, it gets better and better with age. Many companies supply basic wine- and mead-making equipment to hobbyists (see Figure 16-5). All you need is a little space to set up shop, and some honey to ferment. The key to success is keeping everything sanitary — sterile laboratory conditions!

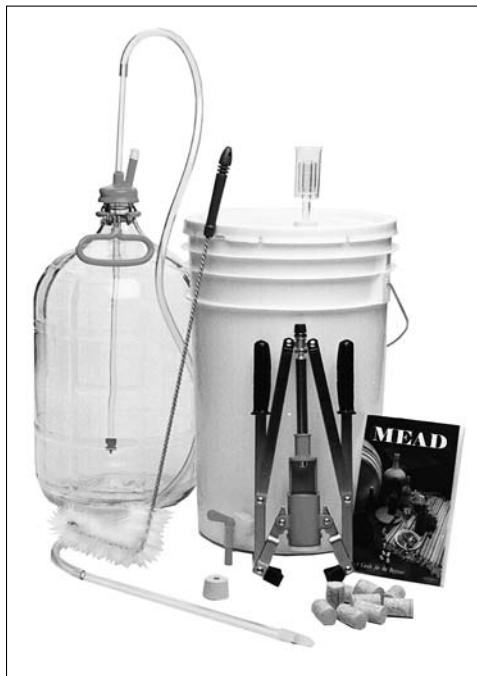

Figure 16-5:
Here's a
typical kit
for brew-
ing mead
(honey
wine).

The following recipe produces an extraordinary mead. Technically, this is a *Metheglin*, the term given to mead that is spiced. The recipe yields about 40 bottles of finished product. Adjust the amounts to suit your needs.



Ideally, keep the room's temperature at between 65 and 68 degrees F (the cool basement is a good place to brew mead). If the temperature is higher than 75 degrees F, the yeast may die; if it's less than 50 degrees F, fermentation ceases. Note that a portable space heater with a thermostat helps control basement temperatures during winter.

1. The initial honey and water mixture is called the “must.” My recipe calls for the following:

- 32 pounds of dark wildflower honey
- 5 gallons of well water (nonchlorinated water)
- 5 sticks of cinnamon
- 1 tablespoon cloves

2. Add the following to the “must”:

- 4¹/₄ tablespoons of wine yeast nutrient (available at wine-making supply stores)

3. Pour the mixture into a large (16.5-gallon) initial fermentation tank.

Top off with water so that the tank contains a total of 13 gallons of must. Stir vigorously to blend and to introduce oxygen (splashing permitted).

4. Add the following ingredients to the tank of must:

- 13 potassium metabisulfite tablets (available at wine-making supply stores) to hinder the growth of undesirable bacteria.
- A few drops of antifoam agent (available at wine-making supply stores)

5. Wait 24 hours, and then add the following to the must in the fermentation tank:

- 2¹/₂ packets of white wine yeast (stir to blend)

6. Cover loosely and let the must ferment for 3 to 4 weeks before performing the first racking (when the bubbling and fizzing has stopped, it's time to rack.

Racking is the process of siphoning off the liquid and leaving the dead yeast cells behind.

7. After the initial 3 to 4 weeks, rack liquid into glass carboys. You'll need two or three 5-gallon carboys for this recipe.

Fill right up to the neck of the carboy (you want to minimize air space). Place a fermentation valve on each carboy. The valve keeps air and bacteria from entering the carboy. Add one potassium metabisulfite tablet for each gallon of liquid to maintain 50 parts per million (ppm).

8. Rack a total of two or three more times at 1- to 2-month intervals.

Each racking further clears the mead. I know you are anxious to drink your mead, but your patience will pay off in a product that tastes great and has great eye appeal. After the final racking, transfer the mead to sterilized wine bottles and cork tightly. Store bottles on their sides in a cool dark place. Remember, the longer the mead is aged, the more improved the flavor. Salute!



You can get your wine sparkling clear by using a special filtering device available from beer- and wine-making suppliers.

For more information on making mead, see *Making Mead Honey Wine: History, Recipes, Methods and Equipment* by Roger A. Morse (Wicwas Press, Cheshire, Connecticut, 1992, ISBN: 1878075047).

Create Cool Stuff with Propolis

Propolis (sometimes called “bee glue”) is the super-sticky, gooey material gathered by the bees from trees and plants. The bees use this brown goop to fill drafty cracks in the hive, strengthen comb, and to sterilize their home.



Propolis has remarkable antimicrobial qualities that guard against bacteria and fungi. Its use by bees makes the hive one of the most hygienic domiciles found in nature. This remarkable property has not gone unnoticed over the centuries. The Chinese have used it in medicine for thousands of years. Even Hippocrates touted the value of propolis for healing wounds. In addition, propolis has been used for centuries as the basis for fine wood varnishes.

When cold, propolis is hard and brittle. But in warm weather propolis is gummier than words can express. When you inspect your hives at the end of the summer and early autumn (the height of propolis production), you’ll discover that the bees have coated just about everything with propolis. The frames, inner cover, and outer cover will be firmly glued together, and they’ll require considerable coaxing to pry loose. You’ll get propolis all over your hands and clothes, where it will remain for a long, long time. It’s a nuisance for most beekeepers. But be sure to take the time to scrape it off, or you’ll never get things apart next season. Be sure to save the propolis you scrape off with your hive tool! It’s precious stuff. I keep an old coffee can in my tool-box and fill it with the propolis I remove from the hive. And I keep another can for the beeswax (burr comb) I remove.



Keep a spray bottle of rubbing alcohol in your supply box. Alcohol works pretty well at removing sticky propolis from your hands. But, for goodness sakes, keep propolis off your clothes — because it’s nearly impossible to remove.

Many beekeepers encourage the bees to make lots of propolis. Special *propolis traps* are designed just for this purpose. The traps usually consist of a perforated screen that is laid across the top bars — similar to a queen excluder, but the spaces are too narrow for bees to pass through (see Figure 16-6). Instinctively, bees fill all these little holes with propolis. Eventually, the entire trap becomes thickly coated with the sticky, gummy stuff. Remove the trap from the hive (gloves help keep you clean) and place it in the freezer overnight so that the propolis becomes hard and brittle. Like chilled Turkish Taffy, a good whack shatters the cold propolis, crumbling it free from the trap. It then can be used to make a variety of nifty products. I've included some recipes to get you started.

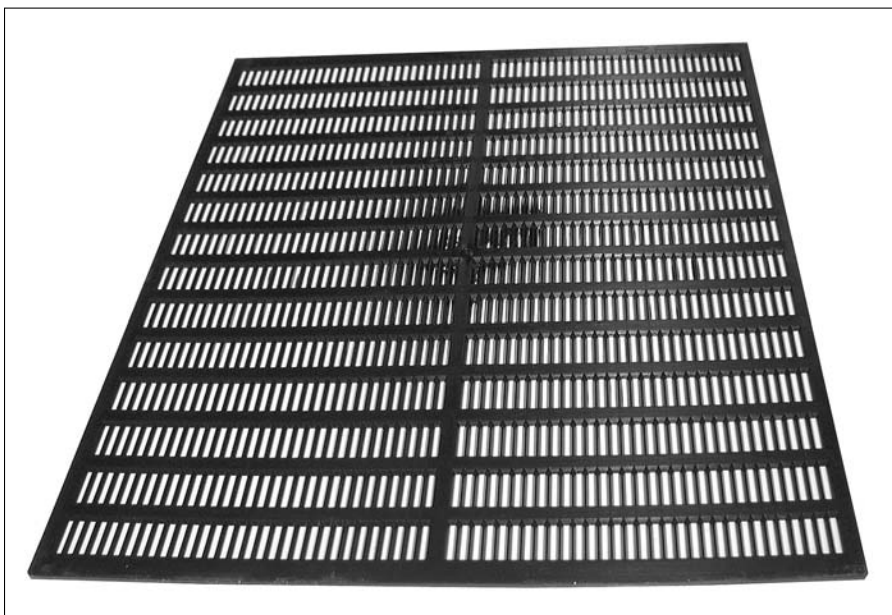

Figure 16-6: A propolis trap can be placed where the inner cover usually goes. In no time, bees will coat the entire trap with precious propolis.

Propolis tincture

Here's a homemade and all-natural alternative to iodine. **Note:** Like iodine, it stains. Use it on minor cuts, rashes, and abrasions. Some folks even use a few drops in a glass of drinking water to relieve sore throats. The shelf life of this tincture is several years.

1. Measure the crumbled propolis and add an equal measure of 100-proof vodka or grain alcohol (for example, one cup propolis and one cup alcohol). Place in an ovenproof bottle with a lid.

2. Heat the closed bottle in a 200-degree (Fahrenheit) oven. Shake the bottle every 30 minutes. Continue until the propolis has completely dissolved in the alcohol.
3. Strain the mixture through a paper coffee filter or a nylon stocking.
4. Bottle the tincture into dropper bottles, which you can get from your pharmacist.

Propolis ointment

This ointment can be applied to minor cuts, bruises and abrasions.

1. Melt the ingredients in a microwave or in a double boiler.
 - 1 teaspoon of beeswax
 - 4 teaspoons of liquid paraffin
 - 1 teaspoon of finely chopped propolis granules
 - 1 teaspoon of honey
2. Remove from heat and stir continuously until it cools and thickens.
3. Pour into suitable jars.

Propolis varnish

If you happen to have a multi-million-dollar violin made by Stradivarius, you already know that the finest string instruments ever made had a varnish made from propolis. But this superior lacquer need not be reserved for such exclusive uses. Propolis varnish provides a warm, durable finish for any wood project. Here's a recipe from a friend of mine who refinishes museum-quality violins.

1. Combine all ingredients in the following list in a glass jar at room temperature. Cover the jar with a lid. Allow mixture to stand for a week or more while shaking at regular intervals.
 - 4 parts blond shellac
 - 1 part manila copal (a soft resin)
 - 1 part propolis

2. Filter solution through a few layers of cheesecloth or a nylon stocking before using.

Note: The manila copal resin is available from specialty varnish suppliers, such as Joseph Hammerl GmbH & Co. KG, Hauptstrasse 18, 8523 Baiersdorf, Germany.

Making Gifts From Beeswax

Your annual harvest doesn't begin and end with honey. You'll also be collecting plenty of beautiful, sweet-smelling beeswax, which can be cleaned and used for all kinds of artsy projects (see Chapter 15 for instructions on how to clean your wax). You can make candles, furniture polish, and cosmetics for all your friends and neighbors (see Figure 16-7). Better yet, why not sell these goodies at the local farmers' market? Here's some useful information to get you started.



Figure 16-7:
Here's
a sample
of the
wonderful
products
you can
make from
beeswax.

Beeswax candles

Beeswax candles are desirable; unlike paraffin, they don't drip, don't sputter, and don't smoke, but they do burn a long time. You can make three basic types of candles from beeswax: rolled, dipped, and molded. Buy them in a gift store, and they're fantastically expensive. But not when you make them yourself!

Rolled candles

This type of candle is a breeze to make, and no special equipment is required. Thin sheets of craft beeswax are available from candlemaking suppliers. The sheets are embossed with a honeycomb pattern (like a sheet of foundation) and come in a huge variety of colors. Purchasing this kind of craft wax probably is best, because it is tough to make without special expensive equipment. To make a rolled candle, place a length of candle wicking along one edge, and roll the sheet up like a jellyroll. Once you get the hang of it, you can easily manufacture several candles in less than a minute. Tie a pair up with a nice ribbon, and you have a great gift to take to your next dinner party.

Dipped candles

This is a time-consuming process, but the end result is beautiful.

- 1. Melt beeswax in a tall container (the container can be placed in a hot water bath to keep the wax melted).**
- 2. Tie a lead fishing weight to one end of wicking (to make it hang straight) and begin dipping.**
- 3. Let each coat of wax cool before dipping again. The more you dip, the thicker the candle becomes.**

With a little finesse, you can create an attractive taper to your dipped candles. You can even add color and scent (your candlemaking supplier sells what you need, including wicks, coloring dyes, and scents). Elegant!

Molded candles

Candlemaking suppliers offer a huge variety of rubber or plastic molds for candlemaking — from conventional tapers to complex figurines. Just melt your beeswax, pour it into the mold (add color and scent if you want). Don't forget the wick. Let it cool and remove the mold. Easy!

Beeswax furniture polish

My good friend Peter Duncan makes simply beautiful wood furniture. He says that my beeswax wood polish is the finest he's ever used. Smooth enough to apply evenly, beeswax polish feeds and preserves the wood and provides a hard protective finish. Here's my "secret" recipe.

Ingredients:

- ✓ 4 ounces beeswax (by weight)
- ✓ 2 tablespoons of carnauba wax flakes
- ✓ 2½ cups odorless turpentine or mineral spirits

- 1. Melt the waxes in a double boiler.**
- 2. Remove the waxes from the heat and stir in the turpentine or mineral spirits.**
- 3. Pour into containers (something that looks like a tin of shoe polish is ideal) and let the mixture cool.**
- 4. Cover tightly with a lid.**

Apply the polish with a clean cloth and rub in small circles. Turn the cloth as it becomes dirty. Allow the polish to dry, then buff with a clean cloth. If more than one coat is desired, wait two days between applications. This stuff is simply fantastic!

Beauty and the bees

Special thanks to my friend and fellow beekeeper Patty Pulliam for putting together these great recipes

There is nothing more satisfying than making your own creams, salves, and balms with beeswax from your hives. It has been said that Cleopatra's beauty regime included a cream made with beeswax and olive oil, and some of my favorite recipes use both of these ingredients! Talk about enduring the test of time!

The recipes here utilize extra virgin olive oil, sweet almond oil and coconut oil — all of which are edible. I figure that I don't want to put anything on my body that I would not put in it! There are so many other wonderful oils, each with their own unique quality such as shea nut butter, jojoba oil, apricot kernel oil, rapeseed oil, safflower oil, and wheat germ oil, that I encourage

you to seek them out and give them a try. You can substitute any oil here for another. However, I do not suggest that you use a mineral or baby oil because they produce a heavy product.

Since these are fresh and natural cosmetic recipes, they do not contain any preservatives, so I encourage you to mark them with the date of manufacture and to use them within a six-month period, but I do not think that will be a problem.

Use your cappings

In making beauty products I suggest that you use “capping’s wax.” This is the wax that the bees produce to cover the honey in the hive and is saved during extraction. Because it is brand new, the wax is light in color, aromatic, and clean. And since you already know that no chemicals should be used while the honey supers are on the hive, you will be guaranteed that your wax is also chemical-free.

Equipment

I use a good-quality kitchen scale that measures in ounces for the dry weight of beeswax. To break up the beeswax use a screwdriver and a hammer on a cutting board. Cleaning any container that has melted beeswax can be a lot of work, so I have taken to using empty coffee cans (well washed and dried, naturally) with chopsticks or the wooden paint stirrers from a hardware store as my mixers. This works very well in a double boiler, you simply place the can in a pot of warm water to melt the wax and oil and you can bend the lip of the can with a pair of pliers to make a pouring spout. You can clean up by wiping the can with paper towels until the next use or recycle it. For a thermometer I employ a digital-display probe type.



Working with melted beeswax is like working with hot cooking oil, use common sense! Always use a water bath when melting beeswax, never directly over a heat source. Wax melts at between 143 degrees F to 148 degrees F. It is fairly stable below 200 degrees F. But at higher temps beeswax can vaporize (flash point) and can ignite.

It is essential to keep a fire extinguisher handy when melting beeswax.

Hint: As wax overheats, it begins to smoke and give off an acrid smell. If this happens, remove it immediately from heat.

Borax

Be certain that you use “chemically pure” borax when making cosmetics (it can be ordered from beekeeping equipment suppliers). Never use laundry-grade borax for cosmetics. Borax is a complex borate mineral salt, which occurs naturally and is mined in the Mojave Desert in Boron, California. In these recipes it acts as an emulsifier and has some minor preservative properties.

Ultra Rich Skin Cream

- 2.5 ounces (weight) beeswax
 - 4 ounces (liquid) lanolin
 - $\frac{2}{3}$ cup sweet almond oil
 - $\frac{3}{4}$ cup distilled water
 - 1 teaspoon borax (sodium borate, Cchemically pure)
 - A few drops essential oil (your choice — I like rose or citrus)
1. In a double boiler, melt the oil, lanolin, and beeswax to 160 degrees F.
 2. Heat the borax and water in a separate container to 160 degrees F. Be sure that the borax is dissolved and the wax is melted.
 3. Add the water mixture to the oil mixture while stirring briskly.
 4. When white cream forms, stir slowly until the mixture cools to 100 degrees F.
 5. Pour into containers, label, and date recipe (use within six months).

Rich Body Balm

- 5 ounces beeswax (weight)
 - $1\frac{1}{3}$ cups distilled water
 - 2 teaspoons borax
 - 2 cups (16 ounces) olive oil
 - A few drops of essential oil (your choice — Geranium is nice!)
1. In a double boiler, melt the oil and beeswax. Heat water and borax in a separate container to 160 degrees F.
 2. Add the water to the oil mixture VERY SLOWLY, stirring constantly.
 3. When mixture is emulsified, pour into containers. Pour into containers, label, and date recipe, use within six months.

Beeswax Lip Balm

- 1 ounce (weight) beeswax
 - 4 ounces (volume) sweet almond oil
 - A few drops essential oil (I recommend peppermint or wintergreen)
1. In a double boiler, combine and melt beeswax and oil; stir until wax is melted.
 2. Remove from heat, add few drops of essential oil, and pour into containers.
 3. Let lip balm cool and solidify before placing caps on containers.



This recipe is a favorite for making specialty salves, by changing the essential oil you can come up with many different products; add Eucalyptus oil and you have a cold chest remedy, add comfrey and you have a cut and wound healer, add propolis and you have a first-aid antibiotic ointment, add chamomile for a soothing foot rub salve, add citronella and or lemongrass for an insect repellent.

Beeswax and Olive Oil Salve

- 1 part beeswax
- 6 parts olive oil
- Fresh or dried herbs (optional) or essential oil of your choice



If using herbs, clean and dry thoroughly, place in glass jar, cover with olive oil, and allow to steep for one week. Strain herbs from olive oil and proceed.

1. In the top of a double boiler set over medium heat, warm olive oil and add beeswax; stir until beeswax is dissolved.
2. While warm, pour into small jars; when cool, cover with lids.

Beeswax Lotion Bar

These bars are great to have in your bag when you need to refresh your skin. I like to use silicone baking molds, which are available in cookware departments and come in a variety of shapes. Soap-making forms also work nicely.

- 2 ounces (weight) beeswax
 - 2 ounces (weight) sweet almond oil
 - 2¹/₂ ounces coconut oil or cocoa butter or combination
 - ¹/₄ teaspoon Vitamin E oil
 - A few drops of essential oil (your choice — lavender is lovely!)
1. Melt all ingredients (except essential oil) in double boiler until melted.
 2. Remove from heat and add in essential oil.
 3. Pour into molds, let cool, and place in cellophane wrapper or reusable container.

Packaging and labeling

There are many online sites for packaging and labeling products. Avery and Labels-on-Line produce many labels that can be used with home computers. Think up a clever name for the item that you have prepared. Make sure that you list all of the ingredients in descending order of quantity on the label along with the net weight of the product and some sort of contact information.

Sources:

www.mangobutter.com/listing

www.donnamaria@handmadebeauty.com

www.sks-bottle.com

www.glorybeefoods.com

www.thesage.com

www.beehivebotanicals.com

www.wholesalesuppliesplus.com

www.labelsonline.com

Chapter 17

Ten Frequently Asked Questions About Bee Behavior

In This Chapter

- ▶ Getting the answers to questionable situations you may encounter
 - ▶ Understanding *unusual* bee behavior
-

I am on the receiving end of virtually every question you can possibly imagine about bees and beekeeping. I've received many e-mails and letters since writing the first edition of *Beekeeping For Dummies*. Beginning beekeepers face all kinds of puzzling new situations and concerns every day. I know how gratifying it is for them to have someone they can ask when they just can't seem to figure out what to do next. I had a wonderful mentor when I started beekeeping, and it made all the difference when I encountered something baffling.

Not surprisingly, most new beekeepers face the same bewildering situations and ask identical questions. That gives me the illusion of intelligence when I rattle off lucid answers to seemingly impossible conundrums. Actually, it's just that I've had a lot of practice responding to the same questions again and again. The good thing is that I get a little better at it each time.

This chapter includes some of the most frequently asked questions about bee behavior that come my way. Look them over. They may solve a riddle or two for you as you embark on the wonderful adventure of backyard beekeeping.

Help! A million bees are clustered on the front of my hive. They've been there all day and all night. Are they getting ready to swarm?

They're not swarming. Chances are it's hot and humid, and the bees are doing just what you'd do — going out on the front porch to cool off. It's called "bearding". They may spend days and nights outside the hive until the weather becomes more bearable inside. Make sure you've given them a nearby source for water and provided adequate hive ventilation. Bearding can be an indication that the hive's ventilation is not what it should be. (See Chapter 9 for more on ventilation.)

Is something wrong with my bees? They're standing at the entrance of the hive, and it looks like they're just rocking back and forth. Are they sick?

Your bees are fine. They're scrubbing the surface of the hive to clean and polish it. They do this inside and outside the hive. Tidy little creatures, aren't they?

I hived a new package of bees last week. I just looked in the hive. The queen isn't in her cage, and I don't see her or any eggs. Should I order a new queen?

It's probably too early to conclude that you have a problem. Overlooking the queen is easy (she's always trying to run away from the light when you open a hive). Seeing eggs is a far easier method of determining whether you have a queen. But, it may be too soon for you to see eggs. Give it another few days and then look again for eggs. Until they get a better idea of what eggs look like, most new beekeepers have a hard time recognizing them. Have a close look at the images of eggs in the color insert section and in Chapter 2.

A few days after the queen lays the eggs, they hatch into larvae, which are easier to see than eggs. If you see absolutely nothing after ten days (no queen, no eggs, and no larvae), order a new queen from your beekeeping supplier.

Why is my queen laying more than one egg in each cell? Is she just super productive?

Actually you may have a problem. More than one egg in a cell is not at all typical, and it may mean one of two things:

- ✔ You have a drone-laying queen.
- ✔ You have lost your queen, and some of the young worker bees have started laying eggs.

If you have a drone-laying queen, you need to replace her. If you have drone-laying workers, you'll have to remove them from the hive and get a new queen (see Chapter 9). If you don't correct the situation, you'll eventually lose your hive as all the worker bees die off from old age. At that point only drones are left. Without the workers, there will be no bees gathering food and no workers to feed the helpless drones.

Hundreds of bees are around my neighbor's swimming pool and bird-bath. The bees are creating a problem, and the neighbor is blaming me. What can I do?

Bees need lots of water in summer, and your neighbor's pool and birdbath are probably the bees' closest sources. You must provide your bees with a closer source of water (see the sidebar in Chapter 3). If they're already

imprinted on your neighbor's oasis, you may have to "bait" your new water source with a light mixture of sugar water. After the bees find your sweet new watering hole, you can switch to 100-percent water.

A tremendous amount of activity is present at the entrance of the hive. It looks like an explosion of bees flying in and out of the hive. The bees seem to be wrestling with each other and tumbling onto the ground. They appear to be fighting with each other. What's going on?

It sounds like you have a robbing situation. Your bees are trying to defend the hive against invading bees that are stealing honey from your hive. You must call a halt to this activity before the robbing bees steal all the honey and many bees die in the battle (see Chapter 9 for tips on how to prevent and solve this situation).

My bees had been so sweet and gentle, but now I'm scared to visit the hive. They have become unbearably aggressive. What can I do?

Bees become more aggressive for a number of different reasons. Consider the following possibilities, and see whether any apply to your situation:

- ✔ A newly established colony almost always starts out gentle. As the colony grows in size and the season progresses, the bees become more protective of their honey stores. Likewise, a growing colony means many more bees for you to deal with. But if the colony is handled with care, this is seldom a problem. Be gentle as you work with your colony.
- ✔ Incorrect use (or lack of use) of the smoker can result in irritable colonies. See Chapter 6 for information about how to use your smoker.
- ✔ Do you launder your bee clothes and veil? Previous stings on gloves and clothing can leave behind an alarm pheromone that can stimulate defensive behavior when you revisit the hive. Be sure to keep your garments clean. You can also smoke the area of the sting to disguise any alarm pheromone that may linger on clothing or on your skin.
- ✔ When colonies are raided at night by skunks or other pirates, they can become cross and difficult to deal with. See Chapter 11 for ideas on how to remedy these situations.
- ✔ Do you still have your original queen? Are you sure? If you had a marked queen, you'd know for certain whether the queen now heading your colony is your original queen (see if she's marked!). A colony that supersedes the queen sometimes can result in more aggressive bees. That's because you have no guarantee of the new genetics. The new queen mated with drones from goodness knows where. Her offspring may not be as nice as the carefully engineered genetics provided by your bee supplier. When this happens, order a marked and mated queen from your supplier to replace the queen that is now in your hive.



When you purchase a marked queen from a supplier, the marking stays on for the full life of the queen. It's like spilling nail polish on the living room carpet. It never wears off!

I see white spots on the undersides of my bees. I'm worried these might be mites or some kind of disease. What are these white flecks?

This isn't a problem. The white flakes that you see are bits of wax produced by glands on the underside of the bee's abdomen. They use this wax to build comb. All is well.

The bees have carried dead larvae out of the hive and dumped them in and around the entrance of the hive. What's going on?

Bees remove any dead bees and larvae from the hive. They keep a clean house. The dead larvae may be *chilled brood*, or brood that died when the temperature took a sudden and unexpected drop. Larvae that look hard and chalky may be a sign of chalkbrood (see Chapter 10 for more information on chalkbrood). Either case is fairly commonplace. You don't need to be concerned unless the number of dead bees and larvae is high (more than ten).

It's mid-winter, and I see quite a few dead bees on the ground at the hive's entrance. Is this normal?

Yes. Seeing a few dozen dead bees in and around the hive's entrance during the winter months is normal. The colony cleans house on mild days and attempts to remove any bees that have died during the winter. In addition, some bees may take "cleansing flights" on mild sunny days but may become disoriented or caught in a cold snap. When that's the case, they don't make it all the way back to the hive — dropping dead in the snow. Seeing more than a few dozen dead bees may be an indication of a health problem, so it may be time for a closer inspection on the first mild, sunny day.

Chapter 18

My Ten Favorite Honey Recipes

In This Chapter

- ▶ Using honey in place of sugar in recipes
- ▶ Baking and cooking with honey

There's a good chance that you'll be able to harvest 50 or more pounds of honey from each of your hives. That's a lot of honey. Unless you eat a whole lot of toast, you may want to consider other ways to utilize your copious crop (see Figure 18-1). Honey is not only wholesome, delicious, sweet, and fat-free, but it's also incredibly versatile. You'll find uses for honey in a myriad of recipes that call for a touch of sweetness.

In this chapter, I include ten of my favorite recipes from the National Honey Board. For many additional recipes, be sure to visit its Web site (www.honey.com) or write to the National Honey Board, 390 Lashley St., Longmont, CO 80501-6045.

Before I jump into the recipes themselves, here are some tips for cooking with honey:

- ✓ Because of its high fructose content, honey has a higher sweetening power than sugar. This means you can use less honey than sugar to achieve the desired sweetness.
- ✓ To substitute honey for sugar in recipes, start by substituting up to half of the sugar called for. With a little experimentation, honey can replace all the sugar in some recipes.

Recipes in This Chapter

- ▶ Honey Lemonade with Frozen Fruit Cubes
- ▶ Banana Yogurt Shake
- ▶ Spiced Tea
- ▶ Apricot Honey Bread
- ▶ Honey Pumpkin Pie
- ▶ Honey Barbecue Baste
- ▶ Honey Herb Salad Dressing
- ▶ Honey-Mustard Roasted Potatoes
- ▶ Grilled Honey Garlic Pork Chops
- ▶ Linguini with Honey Prawns



- ✔ When measuring honey, keep in mind that one 12-ounce jar of honey equals a standard measuring cup.
- ✔ For easy cleanup when measuring honey, coat the measuring cup with nonstick cooking spray or vegetable oil before adding the honey. The honey will slide right out.
- ✔ In baking, honey helps baked goods stay fresh and moist longer. It also gives any baked creation a warm, golden color. When substituting honey for sugar in baked goods, follow these guidelines:
 - Reduce the amount of liquid in the recipe by $\frac{1}{4}$ cup for each cup of honey used.
 - Add $\frac{1}{2}$ teaspoon of baking soda for each cup of honey used.
 - Reduce the oven temperature by 25 degrees to prevent overbrowning.



Figure 18-1:
Honey
goes with
all sorts of
foods!

Courtesy of National Honey Board

Honey Lemonade with Frozen Fruit Cubes

Yield: 6 servings

1½ cups lemon juice

¾ cup honey

9 cups water

48 pieces of assorted fruit

- 1 Combine the lemon juice and honey in a large pitcher; stir until the honey is dissolved. Stir in the water.
- 2 Place 1 or 2 pieces of fruit in each compartment of 2 ice cube trays. Fill each compartment with honey lemonade and freeze. Chill the remaining lemonade.
- 3 To serve, divide the frozen fruit cubes among tall glasses and fill with the remaining lemonade.

Per serving (11/2 cups): Calories 164 (1% of Calories from Fat); Total Fat <1g; Protein <1g; Carbohydrates 45g; Cholesterol 0mg; Sodium 3mg; Dietary Fiber 1g



Banana Yogurt Shake

Yield: 4 servings

1½ cups 2% low-fat milk

2 ripe bananas, peeled

1 cup low-fat plain yogurt

¼ cup honey

1 teaspoon vanilla extract

½ teaspoon ground cinnamon

Dash ground nutmeg

5 ice cubes

Combine all the ingredients except the ice cubes in a blender or food processor. Process until thick and creamy. With the motor running, add the ice cubes and process until smooth. Pour into tall glasses and serve.

Per serving (1 cup): Calories 232 (22% of Calories from Fat); Total Fat 6g; Protein 6g; Carbohydrates 40g; Cholesterol 18mg; Sodium 82mg; Dietary Fiber 1g



Spiced Tea

Yield: 4 servings

4 cups freshly brewed tea

¼ cup honey

4 cinnamon sticks

4 whole cloves

4 orange slices

Combine the tea, honey, cinnamon sticks, and cloves in a large saucepan and simmer for 5 minutes. Serve hot, or let cool and serve with ice cubes for a great iced tea treat! Garnish each cup with an orange slice.

Per serving (1 cup): Calories 76 (1% of Calories from Fat); Total Fat <1g; Protein <1g; Carbohydrates 20g; Cholesterol 0mg; Sodium 8mg; Dietary Fiber <1g



Apricot Honey Bread

Yield: 12 servings

3 cups whole-wheat flour

3 teaspoons baking powder

1 teaspoon ground cinnamon

½ teaspoon salt

¼ teaspoon ground nutmeg

1¼ cups 2% low-fat milk

1 cup honey

1 egg, lightly beaten

2 tablespoons vegetable oil

1 cup chopped dried apricots

½ cup chopped almonds or walnuts

½ cup raisins

- 1** Combine the flour, baking powder, cinnamon, salt, and nutmeg in a large bowl and set aside. Combine the milk, honey, egg, and oil in separate large bowl.
- 2** Pour the milk mixture over the dry ingredients and stir until just moistened. Gently fold in the apricots, nuts, and raisins.
- 3** Pour into a greased 9-x-5-x-3-inch loaf pan. Bake at 350 degrees for 55 to 60 minutes or until a wooden pick inserted near the center comes out clean.

Per serving: Calories 302 (15% of Calories from Fat); Total Fat 6g; Protein 7g; Carbohydrates 61g; Cholesterol 20mg; Sodium 154mg; Dietary Fiber 5g



Honey Pumpkin Pie

Yield: 8 servings

1 can (16 ounces) solid pack pumpkin

1 cup evaporated low-fat milk

$\frac{3}{4}$ cup honey

3 eggs, lightly beaten

2 tablespoons all-purpose flour

1 teaspoon ground cinnamon

$\frac{1}{2}$ teaspoon ground ginger

$\frac{1}{2}$ teaspoon dark rum or rum extract

Pastry for single 9-inch piecrust

Combine all the ingredients except the pastry in a large bowl; beat until well blended. Pour into the pastry-lined, 9-inch pie plate. Bake at 400 degrees for 45 minutes or until a knife inserted near the center comes out clean.

Per serving (1 slice): Calories 284 (27% of Calories from Fat); Total Fat 9g; Protein 7g; Carbohydrates 46g; Cholesterol 82mg; Sodium 209mg; Dietary Fiber 2g



Honey Barbecue Baste

Yield: 1 cup

1 tablespoon vegetable oil

$\frac{1}{4}$ cup minced onion

1 clove garlic, minced

1 can (8 ounces) tomato sauce

$\frac{1}{3}$ cup honey

3 tablespoons vinegar

2 tablespoons dry sherry

1 teaspoon dry mustard

$\frac{1}{2}$ teaspoon salt

$\frac{1}{4}$ teaspoon freshly ground black pepper

- 1** Heat the oil in a saucepan over medium heat until hot. Add the onion and garlic; cook and stir until the onion is tender.
- 2** Add the remaining ingredients and bring to a boil; reduce the heat to low and simmer for 20 minutes. Serve over grilled chicken, pork, spareribs, salmon, or hamburgers.

Per serving (about 3 tablespoons): Calories 103 (21% of Calories from Fat); Total Fat 3g; Protein 1g; Carbohydrates 19g; Cholesterol 0mg; Sodium 408mg; Dietary Fiber 1g



Honey Herb Salad Dressing

Yield: ½ cup

¼ cup white wine vinegar

¼ cup honey

2 tablespoons chopped fresh basil or mint

1 tablespoon minced green onion

Salt and pepper to taste

Combine all ingredients in a small bowl and whisk briskly until mixed well.

Per serving (2 tablespoons): Calories 81 (0% of Calories from Fat); Total Fat 0g; Protein 0g; Carbohydrates 21g; Cholesterol 0mg; Sodium 4mg; Dietary Fiber <1g



Honey-Mustard Roasted Potatoes

Yield: 4 servings

4 large baking potatoes (about 2 pounds)

½ cup Dijon mustard

¼ cup honey

½ teaspoon crushed dried thyme leaves

Salt and pepper to taste

- 1 Peel the potatoes and cut each one into 6 to 8 pieces. Cover the potatoes with salted water in a large saucepan and bring to a boil over medium-high heat. Cook the potatoes for 12 to 15 minutes or until just tender. Drain.
- 2 Combine the mustard, honey, and thyme in a bowl. Toss the potatoes with the mustard mixture until evenly coated. Arrange the potatoes on a foil-lined baking sheet coated with nonstick cooking spray. Bake at 375 degrees for 20 minutes or until the potatoes begin to brown around the edges. Season to taste with salt and pepper.

Per serving: Calories 296 (6% of Calories from Fat); Total Fat 2g; Protein 6g; Carbohydrates 65g; Cholesterol 0mg; Sodium 726mg; Dietary Fiber 3g



Grilled Honey Garlic Pork Chops

Yield: 4 servings

1/4 cup lemon juice

1/4 cup honey

2 tablespoons soy sauce

1 tablespoon dry sherry

2 cloves garlic, minced

*4 boneless center-cut pork chops,
about 4 ounces each*

- 1** Combine the lemon juice, honey, soy sauce, sherry, and garlic in a bowl. Place the pork chops in a shallow baking dish and pour the marinade over the pork. Cover and refrigerate for 4 hours or overnight.
- 2** Remove the pork from the marinade. Heat the remaining marinade to a simmer in a small saucepan over medium heat. Grill the pork over medium-hot coals for 12 to 15 minutes, turning once during cooking and basting frequently with marinade. A meat thermometer should register 155 to 160 degrees when inserted into the pork.

Per serving: Calories 248 (26% of Calories from Fat); Total Fat 7g; Protein 25g; Carbohydrates 20g; Cholesterol 61mg; Sodium 604mg; Dietary Fiber <1g



Linguini with Honey Prawns

Yield: 4 servings

1 pound prawns, peeled and deveined

½ cup julienned carrots

½ cup sliced celery

½ cup diagonally sliced green onions

3 cloves garlic, minced

2 tablespoons olive oil

½ cup water

¼ cup honey

4 teaspoons cornstarch

1 teaspoon salt

¼ teaspoon crushed red pepper flakes

¼ teaspoon crushed dried rosemary leaves

1 pound cooked linguini (*al dente*), kept warm

- 1** In a large, heavy skillet over medium-high heat, stir-fry the prawns, carrots, celery, green onions, and garlic in the oil for about 3 minutes, or until the prawns start to turn pink.
- 2** Combine the water, honey, cornstarch, salt, red pepper flakes, and rosemary in a small bowl and mix well. Add to the prawn mixture and stir-fry for about 1 minute or until the sauce thickens a bit. Pour over the cooked pasta and serve immediately.

Per serving: Calories 445 (19% of Calories from Fat); Total Fat 10g; Protein 30g; Carbohydrates 61g; Cholesterol 172mg; Sodium 737mg; Dietary Fiber 4g



Appendix A:

Helpful Resources

As a new beekeeper, you'll welcome all the information that you can get your hands on. In this chapter I present a bunch of resources that I find mighty useful: Web sites, vendors, associations, and journals.

Honey Bee Web Sites

I confess. I've become an Internet addict! What in the world did I do before cyberspace? For one thing, I took a lot of trips to the library. But not even the most determined library search of years gone by would have turned up the plethora of bee-related resources that are only a click away on the Web. Just enter the word "beekeeping" or "honey bees" into any of the search engines, and you'll come up with hundreds (even thousands) of finds. Like all things on the Net, many of these sites tend to come and go. A few are outstandingly helpful. Some are duds. Others have ridiculous information that may lead you to trouble. So be careful as you browse around in cyberspace. But, by all means, poke around the Web and see what you come up with. Here are some of my tried-and-true bee-related favorites. Each is worth a visit.

Bee-commerce.com

www.bee-commerce.com

This is an online beekeeping supply business I founded in 2000. It features many free "how-to" downloads, instruction sheets, and a wide array of beekeeping supplies, equipment, startup kits, books, and videos. The staff is very knowledgeable and is available to answer questions and provide beekeeping advice. So be sure to visit bee-commerce and feel free to send the company an e-mail. The staff would love to hear from you!

See the coupon at the end of this book for a special offer from bee-commerce.com.

About.com (beekeeping homepage)

www.about.com

Go to about.com, a slick Web site, and search on “beekeeping.” You can find just about every bee resource that you can possibly imagine. If you’re looking for *anything* to do with bees and beekeeping, this is a great place to start. A professional guide who is carefully screened and trained by the hosting company runs the site. This is a good Web site to bookmark.

Apiservices — Virtual beekeeping gallery

www.apiservices.com

This European site is a useful gateway to scores of other beekeeping sites: forums, organizations, journals, vendors, conferences, images, articles, catalogues, apitherapy, beekeeping software, plus much more. It can be accessed in English, French, Spanish, and German and is nicely organized.

BeeHoo — The beekeeping directory

www.beehoo.com

This comprehensive international site has many helpful articles, information sheets, instructional guides, resources, photos, and links of interest for the backyard beekeeper. The site is viewable in English or in French and is definitely worthy of a bookmark.

Bee-Source.com

www.beesource.com

This site includes a nicely organized collection of bee-related articles, resources, and links, and it features sections on bees in the news, editorials, an online book store, a listing of beekeeping suppliers, plans for building your own equipment, discussion groups, bulletin boards, and much more.

Bee Master Forum

www.beemaster.com

A popular international beekeeping forum designed to entertain and educate anyone with an interest in bees or beekeeping. Here you can share images, send messages, and participate in live voice forums. This secure site is moderated and is completely family friendly. It was created and is maintained by hobbyist beekeeper John Clayton (who also took many of the images in this book).

Betterbee

www.betterbee.com

Online and mail order shopping for beekeeping supplies and equipment. Betterbee also has a great selection of supplies for candle making, soap making and even sales tools for marketing your honey. Worth a visit.

Betterbee
8 Meader Road
Greenwich, NY 12834
Telephone: 518 692 9802
Toll Free: 1 800 632 3379
Email: info@betterbee.com

Mid Atlantic Apiculture Research and Extension Consortium (MAARAC)

maarec.cas.psu.edu/index.html

This research and extension consortium is packed with meaningful information for beekeepers worldwide. Download extension publications, find out more about videos, slide shows, software, courses that are available from the organization, and read about honey bee research currently underway. You can also discover important local beekeeping events planned in the Mid-Atlantic Region and other national and international meetings of importance to beekeepers. The USDA/ARS (Beltsville Bee Lab) is an active member of MAARAC. This site is more techie than others.

Mite control using essential oils

www.wvu.edu/~agexten/varroa.htm

This site includes useful information about using essential oils and menthol for the natural control of parasitic mites. If you want to avoid using chemical pesticides in your hives, this information site is a must-read. This text-only site is administered by Dr. Jim Amrine, an entomologist and acarologist at West Virginia University.

National Honey Board

www.honey.com/honeyindustry/

This nonprofit government agency supports the commercial beekeeping industry. The folks at NHB are enormously helpful and accommodating. The well-designed site is a great source for all kinds of information about honey. You'll find articles, facts, honey recipes, and plenty of beautiful images — all available as free downloads. You'll also find links to Japanese, Spanish, and Middle Eastern “honey” sites. Well worth the visit!

Bee Organizations and Conferences

Here are my favorite national and international beekeeping associations. Joining one or two of these is a great idea, because their newsletters alone are worth the price of membership (dues are usually modest). Most of these organizations sponsor meetings and conferences. On the agenda: bees, bees, and more bees. Attending one of these meetings (even if you only do it occasionally) is a fantastic way to learn about new tricks, find new equipment, and meet some mighty nice people with similar interests.

American Apitherapy Society

www.apitherapy.org

This nonprofit organization researches and promotes the benefits of using honey bee products for medical use. A journal published by the society four times a year. Once a year, AAS organizes a certification course.

American Apitherapy Society
500 Arthur St.Centerport, NY 11721
Telephone: 631-470-9446
Fax: 631-693-2528
E-mail: info@apitherapy.org

American Beekeeping Federation

www.abfnet.org

This nonprofit organization plays host to a large beekeeping conference and trade show each year. The meetings are worth attending because they include a plethora of interesting presentations on honey bees and beekeeping. By all means join this organization to take advantage of its bimonthly newsletter. The organization's primary missions are benefiting commercial beekeepers and promoting the benefits of beekeeping to the general public. Commercial beekeepers dominate the membership; however, the hobbyist will find value in membership as well.

American Beekeeping Federation
PO 1337
Gesup, GA 31598
Telephone: 912-427-4233
E-mail: info@abfnet.org

American Honey Producers Association

www.americanhoneyproducers.org

The American Honey Producers Association is a nonprofit organization dedicated to promoting the common interest and general welfare of the American Honey Producer. The handsome Web site provides the public and other fellow beekeepers with industry news, membership information, convention schedules, cooking tips, and contact information.

Apimondia: International Federation of Beekeepers' Associations

www.apimondia.org

Apimondia is a huge international organization comprised of national beekeeping associations from all over the world, representing more than 5 million members. The organization plays host to a large international conference and trade shows every other year.

Apimondia
Corso Vittorio Emanuele 101
I-00186 Rome, Italy
Telephone: ++39 066852286
E-mail: apimondia@mclink.it

Bee Research Laboratory

www.barc.usda.gov/psi/brl/brl-page.html

Known as “Beltsville” in the bee world, the Bee Research Laboratory is a division of the U.S. Department of Agriculture and a good agency to know about. After all, if you’re an American, your tax dollars are paying for it! It’s the oldest of the federal bee labs. Launched in 1891, this is one of the leading research labs in the country. The list of scientists who have worked at Beltsville in the past reads like a “Who’s Who of American Beekeeping Research.” If you ever needed to (let’s hope not), you can send samples of your sick bees to the lab for analysis. The lab also is consulted when there’s a question about whether a colony is Africanized. The lab’s Web site has a lot of helpful information on bee diseases, and a bunch of other technical stuff.

Bee Research Laboratory
10300 Baltimore Blvd.
Building 476, Room 100
Beltsville, MD 20705
Telephone: 301-504-8205
Fax: 301-504-8736
E-mail: jeffery.pettis@avs.usda.gov

Eastern Apiculture Society

www.easternapiculture.org

The Eastern Apiculture Society (EAS) was established in 1955 to promote honey bee culture, the education of beekeepers, and excellence in bee research. Membership consists mostly of beekeepers east of the Mississippi River. Every summer, EAS conducts its annual conference in one of its 22 member states/provinces. About 500 people, from around the world attend this conference every year. The event is simply wonderful for a beekeeper. You can even take a comprehensive exam to become certified as an EAS “master beekeeper.” By all means, try to attend one of these weeklong adventures. You’ll discover new products and techniques, learn a ton of stuff, and make some lifelong beekeeping friends. EAS also publishes a quarterly newsletter.

Kim Flottum
7011 Spieth Road
Medina, OH 44256
Telephone: 330.722.2021 (h)330.725.6677 x3214 (w)
800.289.7668 x3214 (w)
Fax: 330.725.5624
E-mail: president@easternapiculture.org

International Bee Research Association

www.ibra.org.uk

Founded in 1949, the International Bee Research Association (IBRA) is a non-profit organization with members in almost every country in the world. Its mission is to increase awareness of the vital role of bees in agriculture and the natural environment. The organization is based in the United Kingdom. IBRA publishes several journals and sponsors international beekeeping conferences. Lots of good information and bee-related links can be found on the IBRA Web site.

International Bee Research Association
16 North Road
Cardiff, CF10 3DT, UK
Telephone: +44 (0) 29 20 372409
Fax: +44 (0) 5601 135640
E-mail: mail@ibra.org.uk

The Western Apiculture Society

http://beekeeper.dbs.umt.edu/was/about_was.shtml

A small association of beekeepers mostly from the western part of the United States and Canada, the Western Apiculture Society offers a quarterly newsletter and an annual conference.

President Dr. Adrian Wenner
967 Garcia Road
Santa Barbara, CA 93103
Telephone: 805-963-8508
E-mail: wenner@lifesci.ucsb.edu

Apiary Inspectors of America

<http://www.apiaryinspectors.org/>

The Apiary Inspectors of America is an organization that promotes better beekeeping conditions in North America through more effective laws and methods for the suppression of bee diseases and by encouraging a mutual understanding and cooperation between apiary inspection officials. This site is also a great link to find the name and contact information for your state's bee inspector.

Bee Journals & Magazines

Are you ready to curl up with a good article about honey bees? A bunch of publications are worth a read. Subscribing to one or more of them provides you with ongoing sources of useful beekeeping tips and practical information. And the ads in these journals are a great way to learn about new beekeeping toys and gadgets. Here are some English language journals of interest.

American Bee Journal

www.dadant.com/journal

The *American Bee Journal* has been around for more than a century. Although it primarily targets the professional beekeeper, backyard beekeepers value its articles on practical beekeeping techniques and beekeeping news from around the world.

Dadant & Sons, Inc.
51 S. Second St.
Hamilton, IL 62341
Toll free: 800-637-7468
Telephone: 217-847-3324
Fax: 217-847-3660

Bee Culture

www.beeculture.com

This easy-to-digest journal has been around since the late 1800s. Articles are aimed at the needs and interests of the backyard beekeeper and small-scale honey producers. It features a wide range of “how-to” articles, Q&A, honey recipes, and industry news. Hands down, this is the “bible” for the hobbyist beekeeper.

The *Bee Culture* website lists “Who’s Who in North American Beekeeping.” This terrific database enables you to search for bee clubs in your area.



Joining a local bee club/association is an excellent way to latch onto a mentor. Clubs usually schedule meetings during the year with guest speakers on different topics. A ton of local beekeeping clubs and associations can be found across the United States — far too many to list here. Besides *Bee Culture*’s list of bee clubs, you can contact your local county agricultural extension office to find out about bee clubs in your area.

A.I. Root Company
623 W. Liberty St.
Medina, OH 44256
Toll free: 800-289-7668, Ext. 3220
Fax: 330-725-5624

Be sure to check out the coupon later in this book that gives you a 50-percent discount on a subscription to *Bee Culture*.

Bee World

Bee World is a quarterly journal that digests research studies and articles from around the world. Reliable and practical information come from bee experts worldwide. It’s published by IBRA.

www.ibra.org.uk

International Bee Research Association
16 North Road
Cardiff, CF10 3DY, United Kingdom
Telephone: +44 (0) 29 2037 2409
Fax +44 (0) 5601 135640
E-mail: mail@ibra.org.uk

The Speedy Bee

The primary focus of *The Speedy Bee* is on business topics for commercial beekeepers, including news of U.S. trade regulations, regulations dealing with pesticide use, and quarantines that impact honey bees. Publication of this newspaper can be sporadic. To subscribe, write:

The Speedy Bee
PO Box 1038
Jesup, GA 31598-1038

Beekeeping Supplies & Equipment

Where do you find all the neat stuff you need to become a beekeeper? Where do you buy bees? You can start by taking a look in the local yellow pages under “beekeeping supplies.” Maybe you’ll get lucky and find a listing for a local beekeeper who sells supplies out of his or her garage. That’s kind of cool, because it gives you face-to-face access to your own personal mentor. Alternatively, you can deal directly with one of the major bee suppliers. They all offer mail-order catalogs, and all now have e-commerce-enabled Web sites. Some provide online advice (your online mentor). I’ve listed ten of the more popular suppliers.

Bee-commerce.com

www.bee-commerce.com

Okay. This is *the company I founded in 2000*, so yes I have a big bias here. Of course I think it’s the best online bee supply business! Why? Because bee-commerce.com truly offers the highest quality beekeeping supplies and equipment. No junky stuff is found on this site. Cream of the crop! The company offers secure e-commerce shopping and personalized support designed

exclusively for the backyard beekeeper. A free download section is provided with helpful instruction sheets and articles. The company's beekeeping experts happily serve as your online mentors.

bee-commerce.com
11 Lilac Lane
Weston, CT 06883
Telephone: 203- 222-2268
Fax: 413-653-1978
E-mail: info@bee-commerce.com

See the offer at the end of this book for a free gift offer from bee-commerce.com.

The Beez Neez Apiary Supply

www.beezneezapiary.com

Founded in 1992, the Beez Neez Apiary Supply provides beekeeping supplies and equipment by mail order and e-commerce. It also offers candlemaking supplies, honey candy, and mead making kits. An online catalog is available.

The Beez Neez Apiary Supply
403-A Maple Ave.
Snohomish, WA 98290-2562
Telephone: 360-568-2191
E-mail: jean@beezneezapiary.com

Brushy Mountain Bee Farm

www.brushymountainbeefarm.com

Brushy Mountain Bee Farm features a large selection of beekeeping supplies and equipment by mail order and e-commerce. Brushy Mountain manufactures very nice quality hives and offers a wide range of equipment.

Brushy Mountain Bee Farm
610 Bethany Church Road
Moravian Falls, NC 28654
Toll free: 800-BEESWAX
Fax: 336-921-2681
E-mail: sales@brushymountainbeefarm.com

Dadant & Sons, Inc.

www.dadant.com

Dadant & Sons, Inc. provides beekeeping supplies and equipment by mail order and e-commerce. It has a number of regional offices around the United States. One of the largest suppliers in the United States, it has been in business for more than 145 years. Dadant & Sons' primary business is selling decorative and religious beeswax candles.

Dadant & Sons Inc.
51 S. Second
Hamilton, IL 62341
Telephone: 217-847-3324
Fax: 217-847-3660
Toll free: 888-922-1293
E-mail: Dadant@dadant.com

Glorybee Foods, Inc.

www.glorybeefoods.com

Beekeeping equipment plus soap, skin care, aromatherapy, and candle-making supplies are available by mail order and e-commerce from Glorybee, Inc. Founded in 1978, it also is a good resource for unique bee-related gifts.

Glorybee Foods, Inc.
120 N. Seneca Road
PO Box 2744
Eugene, OR 97402
Toll free: 800-456-7923
Fax: 541-762-7173
E-mail: info@glorybeefoods.com

Mann Lake Ltd

www.mannlakeltd.com

Mann Lake, Ltd. offers beekeeping supplies, equipment, and medication by mail order and e-commerce. Its Web site features an online catalog and a beekeeping learning center.

Mann Lake, Ltd
501 First St.
Hackensack, MN 56452
Toll free: 800-880-7694
Fax: 218-675-6156
E-mail: beekeeper@mannlakeltd.com

Rossman Apiaries

www.gabees.com

Rossman Apiaries is a family business that features beekeeping supplies and equipment by mail order and e-commerce. It specializes in nice cypress woodenware. Rossman also sells its own package bees.

Rossman Apiaries
GA Highway 33 North
PO Box 909
Moultrie, GA 31776-0909
Toll free: 800-333-7677
E-mail: rossmanbees@alltel.net

Swienty Beekeeping Equipment

www.swienty.com

European supplier Swienty Beekeeping Equipment offers beekeeping supplies by mail order and e-commerce, including a nice selection of unique products not readily available in the United States. Its Web site is published in three languages.

Hørtoftvej 16 - DK-6400
Sønderborg, Denmark
Telephone: + 45 74486969
Fax: + 4574488001
E-mail: shop@swienty.com

Thorne Beekeeping Supply

www.thorne.co.uk

Thorne Beekeeping Supply offers beekeeping supplies and equipment by mail order only. The company has three store locations, all based in the United Kingdom. It has plenty of stuff on its Web site, but the site is a little cluttered and difficult to negotiate.

E.H. Thorne, Ltd.
Beehive Works
Wragby, Market Rasen
LN3 5LA, United Kingdom
Telephone: 44+(0)1 673 858 555
Fax: 44+(0)1 673 857 004

The Walter T. Kelley Company

www.netgrab.com/kelleycompany/

The Walter T. Kelley Company provides beekeeping supplies and equipment by mail order and e-commerce. It offers a large selection of nice quality stuff.

Walter T. Kelley Company
807 W. Main St.
Clarkson, KY 42726-0240
Telephone: (270) 242-2012
Toll free: 800-233-2899
Fax: (270) 242-4801
E-mail: kelleybees@kynet.net

State Bee Inspectors (United States)

If you live in the United States, you will want to know how to contact the bee inspector in your state. The inspector is there to help. If you have a pesky problem with your bees' health or a question needing the attention of a bee expert, call your state bee inspector. To track 'them down, just go to this Web address: www.beeculture.com/content/StateApiaristDirectory/.

Appendix B:

Beekeeper's Checklist

Hive number/location _____

Date of this inspection _____

Date queen/hive was established _____

Use this simple checklist every time you inspect your bees. It's okay to photocopy it. Be sure to date copies and keep them in a loose-leaf notebook for future reference and comparison. Use one form for each of your hives. For more details on what to look for during inspections, be sure to read Chapters 7 through 12. Happy beekeeping!

<i>Observations</i>	<i>Notations</i>
<input type="checkbox"/> Observe bees at entrance. (Look for dead bees or abnormal behavior and appearance.)	
<input type="checkbox"/> Do you see "spotting" of feces on the hive? (If yes, the bees may have Nosema and need to be medicated.)	
<input type="checkbox"/> What is the condition of your equipment? (Note any needed repairs that have to be made or replacement parts to order.)	
<input type="checkbox"/> Do you see eggs? (You should find only one per cell.)	
<input type="checkbox"/> Can you find the queen? (Is she the same "marked" one you introduced?)	
<input type="checkbox"/> How's the brood pattern? (It should be compact and plentiful during the brood rearing season.)	
<input type="checkbox"/> Evaluate your queen based on her egg-laying ability. (Do you need to replace her with a new queen?)	

(continued)

<i>Observations</i>	<i>Notations</i>
<input type="checkbox"/> How do the larvae look? (Larvae should be a glistening, snowy white.)	
<input type="checkbox"/> Check for swarm cells. (Take swarm prevention steps, if needed.)	
<input type="checkbox"/> Check for supercedure cells. (May be an indication that your queen is underperforming and needs to be replaced.)	
<input type="checkbox"/> Check appearance of brood cappings. (Cappings should be slightly convex and free of perforations.)	
<input type="checkbox"/> Is the colony healthy? (You should find lots of active bees, healthy-looking brood, a clean hive, and a nice sweet smell.)	
<input type="checkbox"/> Do you see evidence of Varroa mites (on bees on sticky board). If yes, medicate accordingly.	
<input type="checkbox"/> Observe bees on the ground in front of the hive. Do they appear to be staggering or crawling up grass blades and then falling off? If yes, this may be an indication of Tracheal mites. Medicate accordingly.	
<input type="checkbox"/> Do the bees have food? (They need honey, pollen, and nectar.)	
<input type="checkbox"/> How much capped honey is there? (Is it time to add a queen excluder and honey supers?)	
<input type="checkbox"/> Do the bees have an adequate water supply?	
<input type="checkbox"/> Clean off propolis and burr comb that make manipulation difficult.	
<input type="checkbox"/> Check ventilation. (Adjust based on weather conditions.)	
<input type="checkbox"/> Is it time to feed? (This usually is done in spring and autumn, depending upon where you live.)	
<input type="checkbox"/> Is it time to medicate? (This usually is done in spring, autumn, and when disease is evident.)	

Glossary

abscond: To leave a hive suddenly, usually because of problems with poor ventilation, too much heat, too much moisture, mites, moths, ants, beetles, lack of food, or other intolerable problems.

acarine disease: The name given to the problems bees experience when they are infested with tracheal mites (*Acarapis woodi*).

Africanized honey bee (AHB): A short-tempered and aggressive bee that resulted from a cross of honey bees from Brazil and Africa. The media has dubbed it “Killer Bee” because of its aggressive behavior.

apiary: This is the specific location where a hive(s) is kept. (Sometimes referred to as a beeyard.)

apiculture: The science, study, and art of raising honey bees. (As a beekeeper, you are an apiculturist!)

Apis mellifera: The scientific name for the European honey bee.

apitherapy: The art and science of using products of the honey bee for therapeutic/medical purposes.

bee bread: Pollen, collected by bees, that is mixed with various liquids and then stored in cells for later use as a high protein food for larvae and bees.

bee space: The critical measurement between parts of a hive that enables bees to move freely about the hive. The space measures $\frac{3}{8}$ inch (1 cm).

bee veil: A netting worn over the head to protect the beekeeper from stings.

beehive: The “house” where a colony (family) of honey bees lives. In nature, it may be the hollow of an old tree. For the beekeeper, it usually is a boxlike device containing frames of honeycomb.

beeswax: The substance secreted by glands in the worker bee’s abdomen that is used by the bees to build comb. It can be harvested by the beekeeper and used to make candles, cosmetics, and other beeswax products.

bottom board: The piece of the hive that makes the ground floor.

brace/burr comb: Brace comb refers to the bits of random comb that connect two frames, or any hive parts, together. Burr comb is any extension of comb beyond what the bees build within the frames. (Both should be removed by the beekeeper to facilitate manipulation and inspection of frames.)

brood: A term that refers to immature bees, in the various stages of development, before they have emerged from their cells (eggs, larvae, and pupae).

brood chamber: The part of the hive where the queen is laying eggs and the brood is being raised. This is typically the lower deep, when two hive bodies are used.

capped brood: The larvae cells that have been capped with a wax cover, enabling the larvae to spin cocoons and turn into pupae.

caste: The two types of female bees (workers and queens) and the male bee (drones).

cell: The hexagon-shaped compartment of a comb. Bees store food and raise brood in these compartments (cells).

cleansing flight: Refers to when bees fly out of the hive to defecate after periods of confinement. (A good day to wear a hat.)

cluster: A mass of bees, such as a swarm. Also refers to when bees huddle together in cool weather.

colony: A collection of bees (worker bees, drones, and a queen) living together as a single social unit.

Colony Collapse Disorder (CCD): Term given to the sudden die off of honey bees in colonies.

comb: A back-to-back collection of hexagonal cells that are made of beeswax and used by the bees to store food and raise brood.

crystallization: The process by which honey granulates or becomes a solid (rather than a liquid).

dancing: A series of repeated bee movements that plays a role in communicating information about the location of food sources and new homes for the colony.

deep hive body: The box that holds standard full-depth frames. (A deep box is usually $9\frac{5}{8}$ inches deep. It is often simply referred to as a deep.)

drawn comb: A sheet of beeswax foundation used by the bees to build up the walls of the cells.

drifting: Refers to when bees lose their sense of direction and wander into neighboring hives. (Drifting usually occurs when hives are placed too close to each other.)

drone: The male honey bee whose main job is to fertilize the queen bee.

egg: The first stage of a bee's development (metamorphosis).

entrance reducer: A notched strip of wood placed at the hive's entrance to regulate the size of the "front door." Used mostly in colder months and on new colonies, it helps control temperatures and the flow of bees.

extractor: A machine that spins honeycomb and removes liquid honey via centrifugal force. (The resulting honey is called extracted honey or liquid honey.)

feeder: A device that is used to feed sugar syrup to honey bees.

feral bees: Wild honey bees that are not managed by a beekeeper.

food chamber: The part of the hive used by the bees to primarily store pollen and honey. This is typically the upper deep, when two deep hive bodies are used.

foulbrood: Bacterial diseases of bee brood. American Foulbrood is very contagious — it is one of the most serious bee diseases. European Foulbrood is less threatening. Colonies should be treated with an antibiotic (such as Terramycin) to prevent foulbrood.

foundation: A thin sheet of beeswax that has been embossed with a pattern of hexagon-shaped cells. Bees use this as a guide to neatly build full-depth comb.

frame: Four pieces of wood that come together to form a rectangle designed to hold honeycomb.

grafting: The manual process of transporting young larvae into special wax or plastic "queen cell cups" in order to raise new queen bees.

hive: A home provided by the beekeeper for a colony of bees.

hive tool: A metal device used by beekeepers to open the hive and pry frames apart for inspection.

honey flow: The time of year when an abundance of nectar is available to the bees.

honeycomb: Comb that has been filled with honey.

inner cover: A flat board with a ventilation hole that goes between the upper hive body and the outer (top) cover.

Israeli Acute Paralysis (IAPV): A honey bee virus being studied as a potential contributor to CCD.

larva (pl. *larvae*): The second stage in the development of the bee.

laying worker: A worker bee that lays eggs. (Because they are unfertile, their eggs can only develop into drones.)

marked queen: A queen bee that is marked with a dot of paint on her thorax to make it easier to find her, document her age, or otherwise keep track of her.

Miller method: A queen-rearing process that requires no special equipment, and is perfect for the backyard beekeeper who just wants to raise a few queens.

miticides: Pesticide chemicals used to eradicate mites.

nectar: The sweet, watery liquid secreted by plants. (Bees collect nectar and make it into honey.)

neonicotinoids. A class of insecticides that act on the central nervous system of insects. Neonicotinoids are among the most widely used insecticides worldwide, but their use has been restricted in recent years due to a possible connection to Colony Collapse Disorder.

Nosema disease: An illness of the honey bee's digestive track caused by the protozoan pathogen, *Nosema apis*. The disease can be controlled with an antibiotic (such as Fimigilin-B).

nucleus hive (*nuc*): A small colony of bees housed in a 3 to 5 frame cardboard or wooden hive.

nuptial flight: The flight that takes place when a newly emerged virgin queen leaves the hive to mate with several drones.

nurse bees: Young adult bees who feed the larvae.

outer cover: The “lid” that goes on top of the hive and serves as protection against the elements. (Sometimes called a top cover or telescoping outer cover.)

pheromone: A chemical scent, released by an insect or other animal, that stimulates a behavioral response in others of the same species.

pollen: The powdery substance that is the male reproductive cell of flowers. (Bees collect pollen as a protein food source.)

propolis: A sticky resinous material that bees collect from trees and plants and use to seal up cracks and strengthen comb. It also has antimicrobial qualities. (Also called bee glue.)

pupa (pl. pupae): The third and final stage in the immature honey bee’s metamorphosis before it emerges from the cell as a mature honey bee.

queen: The mated female bee, with fully developed ovaries, that produces male and female offspring. (There is usually only one queen to a colony.)

queen cage: A small screened box used to temporarily house queen bees (such as during shipment).

queen excluder: A frame holding a precisely spaced metal grid. The device usually is placed immediately below the honey supers to restrict the queen from entering that area and laying eggs in the honeycomb. The spacing of the grid allows foraging bees to pass through freely, but it is too narrow for the larger queen to pass through.

queen mothers: Desirable queen(s) used to raise more queen bees.

queen substance: A term that refers to the pheromone secreted by the queen. It is passed throughout the colony by worker bees.

queenless nuc: A small colony of bees (without a queen) that is used to draw out the new queen cells and nurture the queen larvae.

reversing: The managerial ritual of switching a colony’s hive bodies to encourage better brood production. (Usually done in the early spring.)

robbing: The pilfering of honey from a weak colony by other honey bees or insects.

royal jelly: The substance that is secreted from glands in a worker bee’s head and is used to feed the brood.

scout bees: The worker bees that look for pollen, nectar, or a new nesting site.

shallow super: The box that is used to collect surplus honey. The box is $5^{11}/_{16}$ inches deep. (Sometimes called a honey super.)

smoker: A tool with bellows and a fire chamber that is used by beekeepers to produce thick, cool smoke. The smoke makes colonies easier to work with during inspections.

stinger: The part of the bee's anatomy that everyone knows. The hypodermic-like stinger is located at the end of the adult female bee's abdomen. Remember, bees don't bite! They sting.

supersedure: The natural occurrence of a colony replacing an old or ailing queen with a new queen. (A cell containing a queen larva destined to replace the old queen is called a supercedure cell.)

supering: The act of adding shallow (honey) supers to a colony.

surplus honey: Refers to the honey that is above and beyond what a colony needs for its own use. It is this "extra" honey that the beekeeper harvests for his/her own use.

swarm: A collection of bees and a queen that has left one hive in search of a new home (usually because the original colony had become too crowded). Bees typically leave behind about half of the original colony and the makings for a new queen (queen cells or swarm cells). The act itself is called swarming.

uncapping knife: A device used to slice the wax capping off honeycomb that is to be extracted. (These special knives usually are heated electrically or by steam.)

winter cluster: A tightly packed colony of bees, hunkered down for the cold winter months.

worker bee: The female honey bee that constitutes the majority of the colony's population. Worker bees do most of the chores for the colony (except egg laying, which is done by the queen).

Index

• A •

- abdomen, honey bees, 25
- About Web site (beekeeping homepage), 318
- absconding, 176, 222
- acarine disease, 215
- Africanized Honey Bees (AHB)
 - areas, beekeeping in, 188
 - defined, 93, 186
 - first colonies, 187
 - as flopped experiment, 188
- Agastache foeniculum*, 288
- alcohol, spray bottle, 89
- allergic reactions, 19, 50
- allergy relief, as pollen health benefit, 16
- American Apitherapy Society, 320–321
- American Bee Journal*, 324–325
- American Beekeeping Federation, 321
- American foulbrood (AFB). *See also* diseases
 - chart comparison, 204
 - confirming, 198–199
 - defined, 198
 - preventing, 155, 199
 - symptoms, 198
- American Honey Producers Association, 321
- antennae, honey bees, 23
- anticipation
 - problems, 165–188
 - as success key, 145
- antihistamine creams, 49
- ants. *See also* pests
 - cinnamon, 222
 - oil moat, 223
 - problem, 222
 - solution summary, 227
- Apiary Inspectors of America, 324
- Api-guard (thymol), 214, 219
- Apimondia: International Federation of Beekeeper's Associations, 322
- Apis mellifera*, 17
- Apiservices Web site, 318
- Apistan (fluvalvinate)
 - defined, 212
 - strips, handling, 213
 - strips, positioning, 213
- apitherapy, 15
- apprehensions
 - alleviating, 47–58
 - family and neighbors, 51–52
 - local laws/ordinances, 51
 - sting phobia, 48–51
- Apricot Honey Bread, 312
- artificial swarms, 172
- assembly
 - deep-hive bodies, 64
 - equipment, 74–75
 - frames, 63, 76
 - length of time, 76
- asters, 287
- attending to royal (days 7 to 12), worker bees, 32
- audience, this book, 1
- autumn. *See also* seasons
 - black tar paper, 149
 - colony dryness, 148–149
 - feeding and medicating, 148
 - honey determination, 148
 - inspections, 147–148
 - mouse guards, 149
 - in queen breeder calendar, 244
 - time commitment, 150
 - to-do list, 147–149
 - ventilation, 148, 150
 - ventilation preparations, 150
 - windbreaks, 149

• B •

- baby powder, 89
- bachelor's buttons (*Centaurea*), 289
- baggie feeders. *See also* feeders
 - advantages, 79
 - defined, 79
 - disadvantages, 80
 - illustrated, 80

- baking-soda-and-water poultices, 49
- bald-faced hornets, 44
- Banana Yogurt Shake, 311
- basket hives, 60–61
- bears, 223–224, 227
- bee balm (*Monarda*), 288
- bee behavior
 - activity at entrance, 307
 - aggressive, 307
 - clustering on hive front, 305
 - dead bees in winter, 308
 - dead larvae outside hive, 308
 - looking for water, 306–307
 - multiple eggs in each cell, 306
 - new queen with no eggs, 306
 - rocking at hive entrance, 306
 - white flakes on underside, 308
- bee breeders
 - locating, 94
 - shaking bees, 99–100
 - yard illustration, 99
- bee brushes, 87
- Bee Culture* magazine, 51, 325
- bee escape boards, 267–268
- Bee Master Forum, 319
- bee products. *See also specific products*
 - gift baskets, 52
 - types of, 11, 15
 - use of, 15
- Bee Products - Properties, Applications, and Apitherapy*, 15
- Bee Research Laboratory, 322
- bee space, 289, 290
- bee stings
 - allergic reactions, 19, 50
 - avoidance tips, 48–49
 - as beekeeper fact of life, 18
 - carelessness and, 48
 - normal reactions, 19, 50
 - phobia, overcoming, 48–51
 - queen bees and, 29
 - tolerance, building, 51
 - treatment methods, 49
- bee therapies, 15
- Bee World*, 325–326
- Bee-commerce Web site, 317, 326–327
- BeeHoo Web site, 318
- beekeepers
 - allergies, 18–19
 - education of, 13
 - newbee programs, 57
 - personality traits, 18
 - time and commitment, 17–18
- beekeeper's calendar
 - activities, 160–162
 - defined, 158
 - illustrated, 159
 - using, 159
 - Zone A, 158, 159
 - Zone B, 158, 159
 - Zone C, 159
 - Zone D, 159
- beekeeper's checklist
 - action items, 333–334
 - illustrated, 331–334
 - observations, 331–332
 - using, 331
- beekeeping
 - benefits, 10–15
 - communicating about, 13
 - as education, 13
 - farming analogy, 250
 - for health, 14–15
 - for pollination, 12–13
 - in saving bees, 13
 - for stress relief, 14
- beekeeping potential
 - allergies, 18–19
 - costs and equipment, 16–17
 - determining, 15–19
 - environmental considerations, 15
 - personality traits, 18
 - time and commitment, 17–18
 - zoning and legal restrictions, 16
- bees. *See* honey bees
- Bee-Source Web site, 318
- bee-sting therapy, 15
- beeswax
 - candles, 298
 - cosmetics, 299–303
 - furniture polish, 299
 - harvesting, 275
 - melting, 275
 - products, 297–303

uses, 135
 value, 275
 Beeswax and Olive Oil Salve, 302
 Beeswax Lip Balm, 302
 Beeswax Lotion Bar, 302–303
 beeyards, 54
 Beez Neez Apiary Supply, 327
 Betterbee Web site, 319
 birds, 226
 black tar paper, 149
 blowing bees out, 267
 blueprints, hive, 290–291
 Boardman entrance feeders, 182
 body balm, beeswax, 301
 body odor, 49, 113
 borax, 300
 bottling bucket, 256, 271
 bottom board, 63
 brood
 capped, 131, 137, 140, 170
 chamber, 64
 checking, 131
 chilled, 179–180, 308
 pattern, 131, 137
 Brushy Mountain Bee Farm, 327
 Buckfast bees, 92
 building hives
 bee space and, 289–290
 blueprints, 290–291
 bumblebees, 41
 burr comb
 defined, 134
 eggs, 134
 examining, 135
 removing, 134–135
 removing bees from, 135
 buying bees
 arrival and, 100–102
 capturing swarms and, 97
 established colonies, 97
 first-ordered, first-shipped basis, 99
 hives, number of, 98
 “nuc” colonies, 95–96
 package, 94–95
 supplier selection, 97–99
 time for, 99–100

• C •

C. imperialis, 289
 calendar, beekeeper’s, 158–162
Callistephus, 287
 candles, beeswax, 298
 capped brood. *See also* brood
 color, 137
 defined, 131
 hunting for, 137
 movement under, 140
 pollen, 137
 problems, 137
 swarming and, 170
 capped honey, 264
 capturing swarms, 173–174
 Carniolan bees, 92
 carpenter bees, 42
 Caucasian bees, 92
 CCD. *See* Colony Collapse Disorder
 CCD Working Group, 193
 cell bar frames, 238
 cells
 adult bee emergence, 140
 with multiple eggs, 183
 open, honey in, 265
 queen, 177, 235–237
 supersedure, 138
 swarm, 138, 140–141
Centaurea cyanus, 289
 chalkbrood. *See also* diseases
 chart comparison, 204
 defined, 179, 201
 misdiagnosis, 202
 recovery, 202
 CheckMite+, 213, 222
 chilled brood
 avoiding, 179–180
 dead larvae as, 308
 defined, 179
 chronic bee paralysis, 203
 chunk honey, 252
 cinderblocks, as hive stand, 85, 86
 cinnamon, 222
 cleaning, after extracting, 273–275
 cleansing flights, 151

- Cleome hasslerana*, 288
 - closing hives, 132–133
 - clothing. *See also* equipment
 - dressing and, 113–114
 - gloves, 84, 114
 - light-colored, 49, 82
 - pants legs, 82, 114
 - securing, 82
 - shirts, 82, 114
 - veils, 83, 113
 - colonies
 - autumn feeding and medicating, 148
 - drone mother, 231
 - dryness, 148–149
 - established, purchasing, 97
 - first eight weeks, 133–142
 - growth, anticipating, 155
 - inspecting, 141
 - installing, 91
 - nucleus (nuc), 95–96, 233–234
 - obtaining, 94–97
 - queen mother, 231
 - queen-right, 243
 - registering, 186
 - size, 29
 - stress, avoiding, 194
 - Colony Collapse Disorder (CCD)
 - actions if suspected, 190–191
 - cell phone theory, 191–192
 - characteristics, 190
 - colony characteristics, 190
 - defined, 13, 189–190
 - equipment reuse and, 193
 - FAQs, 193
 - helpful actions, 194
 - honey safety and, 193
 - as perfect storm, 192–193
 - problem, 191
 - theories, 191–193
 - warning signs, 190
 - colors
 - clothing, 49, 82
 - pollen, 131
 - comb honey. *See also* honey
 - defined, 251, 263
 - equipment, 258
 - required conditions for, 263
 - combining hives
 - benefits, 281
 - newspaper method, 282–283
 - combs
 - around queen cage, 134
 - burr, 134–135
 - drone, 214
 - freezing, 275
 - inspections and, 143
 - swarms and, 175
 - commitment, beekeeping, 17
 - congestion, avoiding, 168–169
 - containers, honey, 258
 - cooking with honey
 - baking, 310
 - measurements, 310
 - sugar substitution, 309
 - cosmetics, beeswax
 - Beeswax and Olive Oil Salve, 302
 - Beeswax Lip Balm, 302
 - Beeswax Lotion Bar, 302–303
 - borax, 300
 - cappings, 300
 - equipment, 300
 - ingredients, 299
 - packaging and labeling, 303
 - preservatives and, 300
 - Rich Body Balm, 301
 - Ultra Rich Skin Cream, 301
 - costs, beekeeping, 16
 - coumaphos, 222
 - crystallized honey, 251
 - cut-comb method, 258
- **D** •
- Dadant & Sons, Inc., 328
 - dances
 - between, 27
 - defined, 26
 - round, 26
 - waggle, 26
 - deep-hive bodies
 - assembly, 64
 - defined, 64
 - inspecting, 142
 - lower, 64

placement, 139
 reversing, 155, 156–158
 second, adding, 139
 upper, use of, 64, 140
 dipped candles, 298
 diseases
 American foulbrood (AFB), 198–199
 chalkbrood, 201–202
 European foulbrood (EFB), 199–200
 Nosema, 201
 sacbrood, 202
 stonebrood, 202–203
 table of, 204–205
 viruses, 203
 dividing
 defined, 280
 queens and, 279
 steps for, 280–281
 Doolittle Method. *See* grafting
 double uncapping tank, 255
 drone brood inspection method. *See also*
 Varroa mites
 drawback, 210
 illustrated, 211
 infestation, 211
 steps, 210
 drone Mating Area, 35
 drone mother colonies, 231
 drone-laying queens, 306
 drones
 characteristics, 35
 defined, 35
 function, 35
 head comparison, 23
 illustrated, 27
 in laying workers phenomenon, 183
 Dyce Method, 252

• E •

Eastern Apiculture Society, 323
 egg laying
 checking, 30
 process, 36
 statistics, 28

eggs
 amount, evaluating, 136
 burr comb, 134
 checking, 130
 in honey bee life cycle, 36–38
 illustrated, 37
 looking for, 135
 positioning, 37
 as queen evidence, 135
 spotting, 36, 38
 viewing, 38, 130–131
 elevated hive stands, 85–86
 entrance feeders, 77–78
 entrance reducer
 defined, 63
 guidelines, 107
 inserting, 106
 in robbing prevention, 181
 use of, 63, 107
 environment, beekeeping
 considerations, 15
 EpiPens, 50
 equipment. *See also* hives
 accessories, 84–89
 alcohol, 89
 assembling, 74–75
 baby powder, 89
 bee brushes, 87
 building, 65
 clothing, 82–84
 cosmetic-making, 300
 costs, 16
 disposal latex gloves, 89
 elevated hive stands, 85–86
 feeders, 75–81
 frame rests, 86–87
 fundamental, 81–82
 gloves, 84
 harvest, 253–258
 hive tool, 81–82
 screened bottom board, 88
 slatted racks, 87–88
 smokers, 81–82
 toolbox, 89
 veils, 83

escape boards, 267–268
Eschscholzia, 289
 essential oils, 219
 established colonies, 97
 European foulbrood (EFB). *See also*
 diseases
 chart comparison, 204–205
 confirming, 200
 defined, 199
 preventing, 155, 200
 symptoms, 199–200
 expectations, harvest, 250
 extracted honey. *See also* honey
 decision to harvest, 263
 defined, 251, 263
 when to harvest, 264–265
 extraction
 cleaning after, 273–275
 common questions, 273
 process, 270–273
 storing frames before, 270
 extraction equipment. *See also* harvest
 bottling bucket, 256
 double uncapping tank, 255
 honey extractors, 253–254
 honey strainer, 254–255
 solar wax melter, 257
 uncapping fork, 256
 uncapping knife, 254
 eyes, honey bees, 23, 35

● F ●

family, easing minds of, 51–52
 fanning (days 12 to 18), worker bees, 32–33
 “Fat Bees,” 30
 feeders. *See also* equipment
 adding on, 75–81
 baggie, 79–80
 Boardman entrance, 182
 entrance, 77–78
 frame, 80–81
 hive-top, 75–77, 119–121
 pail, 78–79
 feedings, starting/stopping, 157
 field bees. *See also* worker bees
 defined, 30
 returning to hive, 54
 first-ordered, first-shipped ordering, 99

Fischer’s Bee Quick, 268–269
 flowers for bees
 asters, 287
 bachelor’s buttons (*Centaurea*), 289
 bee balm (*Monarda*), 288
 Callistephus, 287
 hyssop (*Agastache*), 288
 mint (*Menta*), 288
 planting, 286–289
 poppy (*Papaver/Eschscholzia*), 289
 Salvia family (*Salvia/Farinacea-Strata/Splendens*), 287
 spider flower (*Cleome*), 288
 sunflowers (*Helianthus/Tithonia*), 287
 thyme (*Thymus*), 288–289
 food chamber, 64
 foodstuffs, recognizing, 131
 foraging, 34
 foulbrood. *See* American foulbrood (AFB);
 European foulbrood (EFB)
 foundation. *See also* frames
 defined, 69
 drone, 214
 inserting, 69–70
 support pins, 69, 71
 frame feeders, 80–81
 frame rests, 86–87
 frames. *See also* equipment; hives
 assembly directions, 68
 assembly time, 76
 bee safety during removal, 126, 128
 capped honey, 264
 in dividing, 281
 first, removing, 126
 in hiving bees, 104–105
 holding, 128–129
 inserting foundation into, 69–70
 inspecting, 128–130
 knocking bees off, 132
 manipulating, 141
 materials, 67
 movements, 130
 moving bees from, 126
 moving through, at inspection, 128
 number of, 67
 parts of, 68
 removing, 126–128
 removing bees from, 184
 replacing, 132

shaking bees off, 142
 sizes, 67
 storing before extraction, 270
 structural integrity, 68
 tenth, replacing, 136
 turning, 128
 viewing, 128–130
 freezing combs, 275
 fume board
 defined, 268
 technique, 268–269
 Fumigilin-B
 for Nosema, 155, 194, 201
 in sugar syrup, 154
 time to use, 194
 furniture polish, beeswax, 299

• **G** •

gentleness trait, queen, 231
 Glorybee Foods, Inc., 328
 gloves
 disposable latex, 89
 drawbacks, 84
 at harvest, 266
 need for, 84
 use versus nonuse, 114
 grafting. *See also* queen rearing
 cell bar frames, 238
 day, 241
 defined, 238
 four days before, 240
 mini-mating nucs, 242–243
 one/two days after, 242
 pee wees, 242–243
 process, 240–242
 queen cages, 240
 queen cell cups, 238
 queen cell protectors, 239
 three days before, 241
 tools, 239
 two days before, 241
 week after, 242
 granulated honey, 253
 Grilled Honey Garlic Pork Chops, 315
 guarding the hive (days 18 to 21), worker
 bees, 33–34

• **H** •

hardiness trait, queen, 231
 harvest
 amount, 273
 amount to leave behind, 265
 branding/selling after, 260–262
 conditions, 264
 expectations, 250
 extraction process, 270–273
 honey styles and, 251–253
 knowing when to, 264–265
 location, 258–259
 pounds, estimating, 266
 preparation, 249–262
 setup, planning, 258–259
 time commitment, 264
 waiting too long, 265
 wax, 275
 harvest equipment
 advance setup, 259
 bottling bucket, 256, 271
 double uncapping tank, 255
 honey comb, 258
 honey containers, 258
 honey extractors, 253–254, 271
 honey strainer, 254–255
 location, 259
 solar wax melter, 257
 uncapping fork, 256
 uncapping knife, 254, 272
 head, honey bee
 characteristics, 22
 illustrated, 23
 parts of, 23
 health, general, 156
Helianthus annuus, 287
 hive carriers, 270
 hive stand, 63
 hive tool
 in burr comb removal, 135
 defined, 18
 in easing apart hive parts, 120
 in frame removal, 126–127
 illustrated, 82
 using, 103
 hives. *See also* equipment
 assembling, 74–75
 basket (skep), 60–61

hives (*continued*)

- blending into environment, 52
- blueprints, 290–291
- bottom board, 63
- building, 289–291
- closing, 132–133
- combining, 281–283
- deep-hive body, 64
- eight-frame, 74
- entrance reducer, 63
- facing, 53
- frames, 67–68
- guarding, 33–34
- hive stand, 63
- honey supers, 65–66
- illustrated, 54
- income, 16
- inner covers, 71–72
- introducing queen to, 178–179
- Langstroth, 59–60, 62
- laying worker phenomenon, 182–185
- life inside, 21–44
- locating, 53–57
- making one from two, 281–283
- making two from one, 279–281
- manufacturers, 73
- moving, 54–55
- number needed, 17
- number to start with, 98
- observation, 284–286
- opening, 111–123
- outer covers, 73
- parts, ordering, 73–75
- putting bees into, 102–106
- queen excluder, 64–65
- stands, 85–86
- startup kits, 74
- ventilation, 53
- windbreaks, 53
- woodenware, 61–73

hive-top feeders. *See also* feeders

- advantages, 76
- bee entrance, 76
- counterbalancing, 121
- covering with towel, 121
- defined, 75
- disadvantages, 76
- in dividing, 281

- illustrated, 77

- placing at hiving, 106

- removing, 119–121

- replacing, 132

- replenishing, 136

hiving bees

- entrance reducer placement, 106

- first week after, 106, 133–134

- frame preparation, 104

- hive-top feeder placement, 106

- inner cover placement, 106

- jarring package, 103

- outer cover placement, 106

- process, 102–106

- queen cage examination, 104

- safety, 91

- spraying with sugar syrup, 103, 105

- time of day, 102

honey

- antibacterial properties, 18

- as bee benefit, 11

- branding, 260–262

- capped, 265

- CCD and, 193

- chunk, 252

- comb, 251, 253

- cooking with, 309–310

- extracted, 251, 263

- gifts of, 52

- granulated, 253

- harvest preparation, 249–262

- as hygroscopic, 273

- liquefying, 251

- making room for, 141

- marketing locations, 262

- in open cells, 265

- qualities, 15

- refrigeration and, 251

- styles, 251–253

- trivia, 18

- whipped, 252

Honey B Healthy, 156, 220

Honey Barbecue Baste, 313

honey bee life cycle

- development chart, 40

- egg, 36–38

- larva, 38–39

- pupa, 39–40

- honey bee types
 - Africanized, 93
 - Buckfast, 92
 - Carniolan, 92
 - Caucasian, 92
 - characteristics, 93
 - Italian, 17, 92
 - Midnight, 93
 - to raise, 17
 - Russian, 92
 - Starline, 93
- honey bees. *See also* drones; queen bees; worker bees
 - abdomen, 25
 - Apis mellifera*, 17
 - body illustration, 22
 - body parts, 22–25
 - bond with, 9
 - bringing home, 101
 - castes, 27–36
 - choosing, 91–94
 - as docile and gentle creatures, 48
 - dwindling population, 13
 - emergence from cell, 140
 - head, 22–23
 - hiving, 102–106
 - inspecting, 48
 - installing, 58
 - language of, 25–27
 - ordering, 91, 94–100
 - origins, 17
 - pests, 207–227
 - as pollinators, 12
 - prehistoric, 10
 - protecting, from pesticide poisoning, 185–186
 - robbing, 181
 - saving, 13
 - skeleton, 22
 - spelling, 11
 - thorax, 24
 - viruses, 203
- honey containers, 258
- honey extractors
 - cost, 253
 - defined, 253, 271
 - illustrated, 253
 - placing uncapped frames in, 272
 - renting, 254
 - shimmy, 273
 - using, 271
- honey flavors
 - determining, 250
 - graphical areas and, 57
 - wildflower, 57, 250
- Honey Herb Salad Dressing, 314
- honey jars, 273
- Honey Lemonade with Frozen Fruit Cubes, 311
- Honey Pumpkin Pie, 313
- honey recipes
 - Apricot Honey Bread, 312
 - Banana Yogurt Shake, 311
 - cooking tips, 309–310
 - Grilled Honey Garlic Pork Chops, 315
 - Honey Barbecue Baste, 313
 - Honey Herb Salad Dressing, 314
 - Honey Lemonade with Frozen Fruit Cubes, 311
 - Honey Pumpkin Pie, 313
 - Honey-Mustard Roasted Potatoes, 314
 - Linguini with Honey Prawns, 316
 - Spiced Tea, 312
- honey strainers, 254–255
- honey supers. *See also* equipment; hives
 - bee escape board, 267
 - blowing bees out, 267
 - carrying, 270
 - defined, 65
 - fume board technique, 268–269
 - medium, 66
 - removing bees from, 265–270
 - shaking bees out, 266–267
 - shallow, 66
 - waiting too long to remove, 265
- Honey-Mustard Roasted Potatoes, 314
- hot weather comfort, 170
- house bees. *See also* worker bees
 - defined, 30
 - guarding the hive, 33–34
 - housekeeping (days 1 to 3), worker bee, 31
 - hyssop (*Agastache*), 288

• 1 •

icons, this book, 4–5
 income, hive, 16
 inner covers
 defined, 71
 illustrated, 72
 materials, 71
 placing at hiving, 106
 removing in opening hive, 121–122
 replacing, 132–133
 ventilation notch, 106
 inspections
 after swarms, 171
 autumn, 147–148
 bee sting avoidance and, 48–49
 brood, 131
 brood pattern, 131
 colony, 141
 conditions for, 111–112
 dispersing bees during, 130
 first, 134
 food storage, 131
 foodstuffs, 131
 frame, 128–130
 frame removal, 126–128
 frame replacement, 132
 hive closure, 132–133
 as intoxicating experience, 111
 lower deep, 142
 multi-level hive, 141–142
 preparation for, 112–116
 productivity and, 112
 propolis and, 143
 queen, 130–131
 schedule, setting, 112
 smoke during, 130
 smoker preparation for, 114–116
 summer, 146
 swarming, 166
 techniques, 125–133
 time of day, 48, 111
 upper deep, 142
 what to look for during, 125, 130–131
 installation, time for, 58, 91
 integrated pest management (IPM)
 best practice techniques, 195
 defined, 195

 rules of thumb, 195
 using, 194
 for Varroa mites, 214–215
 International Bee Research
 Association, 323
 Israeli Acute Paralysis Virus (IAPV), 192
 Italian bees, 17, 92

• K •

killer bees
 areas, beekeeping in, 188
 defined, 186–187
 first colonies, 187
 as flopped experiment, 188
 phenomenon, 186–188
 K-wings, 216

• L •

labels, honey. *See also* selling honey
 creating, 260–262
 illustrated, 260
 information requirements, 260
 nutritional information, 261
 Langstroth hive. *See also* hives
 benefits, 60
 components illustration, 62
 defined, 59
 language, honey bee, 25–27
 larvae
 brown/reddish spots, 208
 dead, 308
 defined, 38
 grafting, 241–242
 illustrated, 39, 137
 looking for, 136
 pheromones, 25
 sealing of, 38
 stages, 137
 latex gloves, disposable, 89
 laying workers. *See also* worker bees
 defined, 182–183
 getting rid of, 184–185
 indicators, 183
 phenomenon, 182–185
 legal restrictions, 16, 51
 legs, honey bee, 24

life span
 queen bee, 29
 worker bee, 30

Linguini with Honey Prawns, 316

lip balm, beeswax, 302

lotion bar, beeswax, 302–303

• **M** •

magnifiers, 131

Making Mead Honey Wine: History, Recipes, Methods, and Equipment, 294

manila copal resin, 297

Mann Lake Ltd, 328–329

marked queens, 94, 308

marketing honey, 262

marking, mated queens, 245

mated queens. *See also* raising queens
 marking, 245
 storing, 243–244
 wing-clipping, 245

mating, queen bee, 233

mead
 brew kit, 292
 brewing, 292–294
 defined, 292
 filtering, 294
 information resource, 294
 steps for making, 293–294

medicated syrup, 102

medications
 decision, 197–198
 new, 200
 spring, administering, 154–156
 Varroa mites, 212

menthol crystals, 156, 217–218

mice. *See also* pests
 damage, 225
 prevention, 225–226
 solution summary, 227

Mid Atlantic Apiculture Research and Extension Consortium (MAARAC), 319

Midnight bees, 93

Miller feeders. *See* hive-top feeders

Miller Method. *See also* queen rearing
 defined, 234
 process, 234–237
 queen cells, 235–237

queen emergence, 237

queenless nuc, 235

wax foundation, 234–235

mini-mating nucs, 242–243

mint (*Mentha*), 288

Mite-Away II (formic acid), 214, 219

mites. *See* parasitic mites

molded candles, 298

Monarda didyma, 288

mouse guards. *See also* mice; pests
 installation, 225–226
 placing, 149
 use dividends, 226

moving hives, 54, 55

• **N** •

National Honey Board, 309, 320

natural comb. *See* burr comb

neighbors, easing minds of, 51–52

newspaper method. *See also* combining hives
 defined, 282
 illustrated, 283
 process, 282

nonmedicated syrup, 102

Nosema. *See also* diseases
 defined, 201
 medicating for, 201
 preventing, 155
 symptoms, 201

nucleus (nuc) colonies
 defined, 233
 disadvantages, 284
 establishing, 283–284
 illustrated, 96, 284
 ordering, 95–96
 over-wintering, 244
 queenless, 233
 reasons for creating, 283
 sources, 96

nurse bees, 185, 237, 241, 243

nursery work (days 4 to 12), worker bees, 31–32

• 0 •

observation hives
 benefits, 285
 illustrated, 286
 sizes/styles, 285
 starting, 284–286
Observation Hives (Webster and Caron), 285
 oil moat, 223
 ointment, propolis, 296
 opening hives. *See also* hives
 fears, 111
 hive-top feeder removal, 119–121
 inner cover removal, 121–122
 outer cover removal, 118–119
 preparation for, 112–116
 process, 117–122
 productivity and, 112
 schedule for, 112
 smoke puffs, 117
 smoker preparation, 114–116
 time and conditions for, 111–112
 ordering
 bee arrival and, 100–102
 capturing swarms and, 97
 established colonies, 97
 first-ordered, first-shipped basis, 99
 hives, number of, 98
 “nuc” colonies, 95–96
 package bees, 94–95
 queens, when dividing, 279
 supplier selection in, 97–99
 time for, 99–100
 organization and conferences
 American Apitherapy Society, 320–321
 American Beekeeping Federation, 321
 American Honey Producers Association, 321
 Apiary Inspectors of America, 324
 Apimondia: International Federation of Beekeeper’s Associations, 322
 Bee Research Laboratory, 322
 Eastern Apiculture Society, 323
 International Bee Research Association, 323
 Western Apiculture Society, 324
 organization, this book, 1–4

outer covers
 in adding second deep hive body, 139
 cypress, 73
 placing at hiving, 106
 putting on hive, 73
 removing, in opening hive, 118–119
 replacing, 133
 ventilation notch, 133

• P •

P. nudicaule, 289
P. rhoeas, 289
 package bees
 availability timeframe, 99
 dealers, 95
 hiving, 102–106
 inspecting, 101
 jarring, 103
 marked queen, 94–95
 ordering, 94–95
 queen cage, 104
 shipping illustration, 95
 size, 94
 spraying with sugar syrup, 101
 spraying with water, 101
 pail feeder, 78–79
 pants, 82, 114
Papaver somniferum, 289
 paradichlorobenzene (PDB), 274–275
 parasitic mites
 Honey B Healthy for, 220
 tracheal, 215–219
 Varroa, 207–215
 parts, hive, 73–75
 pathogens, CCD and, 192
 PDB (paradichlorobenzene), 274–275
 pee wees, 242–243
 personality traits, beekeeper, 18
 pesticides
 avoiding use of, 194
 CCD and, 192–193
 poisoning prevention, 185–186
 pests
 ants, 222–223
 bears, 223–224
 birds, 226
 mice, 225–226

- parasitic mites, 207–220
 - raccoons, 224–225
 - skunks, 224–225
 - small hive beetle, 221–222
 - solutions, 226–227
 - tracheal mites, 215–219
 - Varroa mites, 207–215
 - wax moths, 220–221
 - pheromones. *See also* queen substances
 - in bee communication, 25
 - defined, 25
 - planning
 - disciplining, 165
 - harvest setup, 258–259
 - pollen
 - for allergy relief, 16
 - capped brood, 137
 - colors, 131
 - health benefits, 16
 - honey bee anatomy and, 12
 - recognizing, 131
 - pollination, bee
 - importance, 12
 - miracle of, 13
 - monetary value, 12
 - pollinators, bee
 - advantages of, 12
 - garden introduction, 12
 - role, 12–13
 - poppy (*Papaver/Eschscholzia*), 289
 - powdered sugar dusting, 214–215
 - powdered sugar shake method, 209–210
 - prehistoric bee, 10
 - problems
 - absconding, 176, 222
 - anticipating/preventing, 165–188
 - queenless colonies, 176–179
 - swarming, 166–175
 - proboscis, 23
 - productivity
 - inspections and, 112
 - queen trait, 232
 - propolis
 - characteristics, 294
 - for chinking cracks, 147
 - cold, 294
 - inspections and, 143
 - ointment, 296
 - products, 294–297
 - qualities, 15
 - sticky, removing, 294
 - tincture, 295–296
 - traps, 295
 - varnish, 296–297
 - warm, 294
 - pupae
 - defined, 39
 - illustrated, 39–40
 - pheromones, 25
- *Q* ●
- queen banks, 243
 - queen bees. *See also* honey bees
 - aging, 29, 30
 - bee stings and, 29
 - characteristics, 27–29
 - checking, 130–131
 - defined, 27
 - development, 232
 - drone-laying, 306
 - eggs as evidence, 135
 - evaluating, 136
 - head comparison, 23
 - illustrated, 27, 28
 - introducing to hive, 178–179
 - life span, 29
 - marked, 94, 308
 - mating habits, 233
 - missing, 176–179
 - ordering, 279
 - in package, 94–95
 - pheromones, 25
 - raising, 229–245
 - release verification, 134
 - replacement, ordering, 177
 - replacing, 29, 170
 - selecting, 230
 - virgin, 233, 242
 - queen breeder's calendar, 244
 - queen breeding. *See also* raising queens
 - defined, 230
 - gentleness trait, 231
 - hardiness trait, 231
 - productivity trait, 232
 - resistance trait, 231

- queen breeding (*continued*)
 - stock, selecting, 230–231
 - traits, 231–232
 - queen cages
 - on bottom board, 178, 179
 - candy plug, 178
 - comb around, 134
 - examining, 104
 - in grafting, 240
 - hanging, 178
 - “push-in,” 240
 - for storing queens, 243
 - in verifying queen release, 134
 - queen cells
 - cups, 238
 - grafting, 238
 - Miller Method, 235–237
 - occupied, 177
 - protectors, 239
 - queen excluder, 64–65
 - queen mother colonies, 231
 - queen rearing. *See also* raising queens
 - defined, 30
 - Doolittle Method (grafting), 238–243
 - methods, 234–243
 - Miller Method, 234–237
 - queen substances
 - as chemical communication, 29
 - defined, 25, 29
 - functions, 29
 - relay, 29
 - queenless colonies, 176–179
 - queenless nucs. *See also* raising queens
 - creating, 234
 - defined, 233
 - Miller Method, 235
 - use of, 233
 - queen-right colonies, 243
- R •**
- raccoons, 224–225, 227
 - raising queens. *See also* queen bees
 - benefits, 229–230
 - breeding, 230–232
 - feeding and, 243
 - numbers, 230
 - queen storage, 243–244
 - queenless nuc, 233–234
 - rearing, 230, 234–243
 - traits, 231–232
 - replacement queens
 - advantages, 178
 - introducing, 178–179
 - resistance trait, queen, 231
 - resources
 - About site (beekeeping homepage), 318
 - American Apitherapy Society, 320–321
 - American Bee Journal*, 324–325
 - American Beekeeping Federation, 321
 - American Honey Producers Association, 321
 - Apiary Inspectors of America, 324
 - Apimondia: International Federation of Beekeeper’s Associations, 322
 - Apiservices site, 318
 - Bee Culture*, 51, 325
 - Bee Master Forum site, 319
 - Bee Research Laboratory, 322
 - Bee World*, 325–326
 - Bee-commerce site, 317, 326
 - BeeHoo site, 318
 - beekeeping supplies and equipment, 326–330
 - Bee-Source site, 318
 - Beez Neez Apiary Supply, 327
 - Betterbee site, 319
 - Brushy Mountain Bee Farm, 327
 - Dadant & Sons, Inc., 328
 - Eastern Apiculture Society, 323
 - Glorybee Foods, Inc., 328
 - International Bee Research Association, 323
 - journals and magazines, 324–326
 - Mann Lake Ltd, 328–329
 - Mid Atlantic Apiculture Research and Extension Consortium (MAARAC), 319
 - National Honey Board, 309, 320
 - organization and conferences, 320–324
 - Rossmann Apiaries, 329
 - The Speedy Bee*, 326
 - state bee inspectors, 330
 - Swienty Beekeeping Equipment, 329
 - Thorne Beekeeping Supply, 330
 - Walter T Kelley Company, 330
 - Western Apiculture Society, 324

reversing hive bodies, 155, 156–158
Rich Body Balm, 301
robbing
 attacks, stopping, 181
 bees, 181
 dangers, 121
 dealing with, 180–182
 defined, 49, 121
 normal behavior versus, 180–181
 preventing, 181–182
 seriousness, 180
 setting off, 49
rolled candles, 298
Rossman Apiaries, 329
round dance, 26
royal jelly
 components, 31
 defined, 23
 health benefits, 31
 qualities, 15
Russian bees, 92

• S •

sacbrood, 202, 205
salve, beeswax, 302
Salvia officinalis, 287
schedule, inspection, 112
screened bottom board, 88
seasons
 autumn, 147–150
 beekeeper's calendar, 158–162
 spring, 153–158
 summer, 145–146
 winter, 151–153
section comb cartridges, 258
selling honey
 labels, 260–262
 marketing locations, 262
 on Web, 262
7/10 rule, 170
shaking bees
 burr comb, 135
 defined, 135
 frames, 142
 honey supers, 266–267
shirts, 82, 114
skeleton, honey bee, 22
skep hives, 60–61
skin cream, beeswax, 301
skunks, 224–225, 227
slatted racks, 87–88
small hive beetle. *See also* pests
 controlling, 222
 coumaphos, 222
 defined, 211
 illustrated, 221
 problem determination, 221
 solution summary, 227
 trap, 222
smells, 113
smoke
 cool, testing for, 116
 in deep-hive body reversal, 157
 in frame replacement, 132
 in hive-top feeder removal, 119, 121
 in inner cover removal, 121–122
 in open hive, 122–123
 puffs, 117
 purpose, 118
smokers
 cleaning, 116
 defined, 81
 fuel, adding, 115
 illustrated, 82, 115
 ingredients, 115
 keeping lit, 114
 kindling, 114–115
 opening hive with, 117
 packing, 115
 preparing, 114–116
 smoking, 116
 testing for cool smoke, 116
solar wax melter, 257
The Speedy Bee, 326
Spiced Tea, 312
spider flower (*Cleome*), 288
spiracles, 24
spraying sugar syrup, 101, 103, 105
spring. *See also* seasons
 bee health determination, 154
 bird inspection, 154
 as busy times, 153
 colony growth anticipation, 155
 food determination, 154
 medication, administering, 154, 155–156

- spring (*continued*)
 - in queen breeder calendar, 244
 - queen determination, 154
 - sugar syrup feedings, 157
 - swarming indications, 155
 - time commitment, 155
 - to-do list, 153–155
 - Starline bees, 93
 - startup hive kits, 74
 - state bee inspectors
 - contacting for AFB, 199
 - contacting for CCD, 191
 - tracking down, 330
 - steppin' out (days 22 to 42),
 - worker bees, 34
 - stingers
 - queen bee, 29
 - use as last resort, 48
 - worker bee, 30
 - stinging insects. *See also* honey bees
 - bald-faced hornets, 44
 - bumblebees, 41
 - carpenter bees, 42
 - wasps, 42–43
 - yellow jackets, 43
 - stonebrood. *See also* diseases
 - chart comparison, 205
 - defined, 202
 - recovery, 203
 - sugar and grease patties. *See also* tracheal mites
 - feeding recommendation, 219
 - recipe, 218
 - use of, 218
 - wintergreen oil option, 219
 - sugar syrup
 - handling, 182
 - in hive-top feeder, 136
 - medicated, 102
 - nonmedicated, 102
 - recipe for, 101–102
 - replenishing, 139
 - spilling, 182
 - spraying before hiving, 103, 105
 - spraying on arrival, 101
 - winter, 147
 - summer. *See also* seasons
 - honey harvesting, 146
 - inspections, 146
 - in queen breeder calendar, 244
 - time commitment, 146
 - to-do list, 146
 - ventilation, 146
 - sunflowers (*Helianthus/Tithonia*), 287
 - supersedure cells, 138
 - supplies and equipment resources, 326–330
 - swarm cells
 - defined, 138
 - evidence, 140
 - removing, 170
 - watching for, 140–141
 - swarming
 - capped brood and, 170
 - colony candidates, 168
 - defined, 166
 - first season and, 168
 - following up after, 171–173
 - gorging before, 166
 - hive inspection after, 171
 - indications, watching for, 155
 - inspections, 166
 - preparation for, 138
 - prevention, understanding, 168
 - reasons for, 168
 - swarms
 - in AHB areas, 188
 - artificial, 172
 - capturing, 97, 173–174
 - collection container, 173–174
 - comb and, 175
 - early, 175
 - hiving, 175
 - illustrated, 167
 - late, 175
 - natural, preventing, 172
 - studying, 174
 - temporary resting place, 166
 - walking, 174
 - Swienty Beekeeping Equipment, 329
- T ●
- tar paper, 149
 - Terramycin, 148, 155, 200
 - thorax, honey bee, 24
 - Thorne Beekeeping Supply, 330
 - thyme (*Thymus*), 288–289

- time commitment
 autumn, 150
 beekeeping, 17
 harvest, 264
 spring, 155
 summer, 146
 winter, 152
- tincture, propolis, 295–296
- to-do lists
 autumn, 147–149
 spring, 153–155
 summer, 146
 winter, 152
- toolbox, 89
- tracheal mites. *See also* pests
 acarine disease, 215
 Apiguard (thymol), 219
 control, 156
 defined, 215
 essential oils, 219
 illustrated, 216–217
 menthol crystals and, 217–218
 Miteaway II (formic acid), 219
 problems, 215–216
 problems, avoiding, 217–219
 solution summary, 227
 sugar and grease patties and, 218–219
 symptoms, 216
- Tylan, 148, 155, 200
- U •
- Ultra Rich Skin Cream, 301
- uncapping fork, 256
- uncapping knife, 254, 272
- undertaking (days 3 to 16), worker bee, 31
- V •
- varnish, propolis, 296–297
- Varroa mites. *See also* pests
 Apiguard (thymol), 214
 Apistan (fluvalvinate), 212–213
 CCD and, 191
 CheckMite+, 213
 control, 156, 212–214
 defined, 207–208
 detection techniques, 209–211
 drone brood inspection method, 210–211
- drone comb, 214
 harm, 208
 medication options, 212
 Mite-Away II (formic acid), 214
 natural control, 214–215
 populations, evaluating, 212
 populations, monitoring, 194
 powdered sugar dusting, 214–215
 powdered sugar shake method, 209–210
 solution summary, 227
 symptoms, recognizing, 208–209
- veils
 bees under, 113
 illustrated, 83
 types of, 83
 wearing, 83, 113
- vendors
 choosing, 97–99
 nuc colony, 96
 package bees, 95
 reputation, 98
- venom
 in bee-sting therapy, 15
 tolerance to, 51
- ventilation
 autumn, 148, 150
 hive placement and, 53
 holes, 146
 providing, 141, 169
 in swarming prevention, 169
- virgin queens, 233, 242
- viruses, honey bee, 203
- W •
- waggle dance, 26
- Walter T Kelley Company, 330
- wasps, 42–43
- water
 bee collection of, 55
 hot weather and, 170
 options, 55–56
- watering pool, 56
- wax. *See* beeswax
- wax moths. *See also* pests
 controlling, 274–275
 defined, 220
 freezing combs and, 275
 fumigating with PDB, 274–275

- wax moths (*continued*)
 - invasions, 221
 - solutions, 227
 - Web, selling honey on, 262
 - Web sites
 - About (beekeeping homepage), 318
 - Apiservices, 318
 - Bee Master Forum, 319
 - Bee-commerce, 317, 326–327
 - BeeHoo, 318
 - Bee-Source, 318
 - Betterbee, 319
 - Mid Atlantic Apiculture Research and Extension Consortium (MAARAC), 319
 - National Honey Board, 320
 - West Virginia University, 320
 - Western Apiculture Society, 324
 - whipped honey
 - creating, 252, 253
 - defined, 252
 - wild comb. *See* burr comb
 - wildflower honey, 57, 250
 - windbreak
 - black tar paper, 149
 - in hive placement, 53
 - winter, 149
 - wing-clipping, queens, 245
 - wings, 24
 - winter. *See also* seasons
 - brood chamber temperature, 151
 - cleansing flights, 151
 - cluster temperature during, 151
 - dead bees on ground in, 308
 - hive entrance monitoring, 152
 - in queen breeder calendar, 244
 - sugar and grease patties, 219
 - syrup recipe, 147
 - time commitment, 152
 - to-do list, 152
 - windbreaks, 149
 - woodenware. *See also* hives
 - bottom board, 63
 - deep-hive body, 64
 - defined, 61
 - entrance reducer, 63
 - foundation, 69–71
 - frames, 67–68
 - inner cover, 71–73
 - making it last, 66
 - outer cover, 73
 - queen excluder, 64–65
 - shallow/medium honey super, 65–66
 - stand, 63
 - worker bees
 - architects and master builders (days 12 to 35), 33
 - attending to royal (days 7 to 12), 32
 - dances, 26
 - defined, 30
 - fanning (days 12 to 18), 32–33
 - foraging, 34
 - grocery shopping days 12 to 18), 32
 - guarding the hive (days 18 to 21), 33–34
 - head comparison, 23
 - as house bees, 30
 - housekeeping (days 1 to 3), 31
 - illustrated, 27
 - laying, 182–185
 - life span, 30
 - nursery work (days 4 to 12), 31–32
 - orientation flights, 34
 - pheromones, 25
 - queen substance stimulation of, 25
 - steppin' out (days 22 to 42), 34
 - stinger, 30
 - tasks, 30
 - team work, 30
 - undertaking (days 3 to 16), 31
 - Varroa mite attacks, 208
- *Y* •
- yellow jackets, 43
- *Z* •
- zoning restrictions, 16

BUSINESS, CAREERS & PERSONAL FINANCE

Accounting For Dummies, 4th Edition*

978-0-470-24600-9

Bookkeeping Workbook For Dummies†

978-0-470-16983-4

Commodities For Dummies

978-0-470-04928-0

Doing Business in China For Dummies

978-0-470-04929-7

E-Mail Marketing For Dummies

978-0-470-19087-6

Job Interviews For Dummies, 3rd Edition*†

978-0-470-17748-8

Personal Finance Workbook For Dummies*†

978-0-470-09933-9

Real Estate License Exams For Dummies

978-0-7645-7623-2

Six Sigma For Dummies

978-0-7645-6798-8

Small Business Kit For Dummies, 2nd Edition*†

978-0-7645-5984-6

Telephone Sales For Dummies

978-0-470-16836-3

BUSINESS PRODUCTIVITY & MICROSOFT OFFICE

Access 2007 For Dummies

978-0-470-03649-5

Excel 2007 For Dummies

978-0-470-03737-9

Office 2007 For Dummies

978-0-470-00923-9

Outlook 2007 For Dummies

978-0-470-03830-7

PowerPoint 2007 For Dummies

978-0-470-04059-1

Project 2007 For Dummies

978-0-470-03651-8

QuickBooks 2008 For Dummies

978-0-470-18470-7

Quicken 2008 For Dummies

978-0-470-17473-9

Salesforce.com For Dummies, 2nd Edition

978-0-470-04893-1

Word 2007 For Dummies

978-0-470-03658-7

EDUCATION, HISTORY, REFERENCE & TEST PREPARATION

African American History For Dummies

978-0-7645-5469-8

Algebra For Dummies

978-0-7645-5325-7

Algebra Workbook For Dummies

978-0-7645-8467-1

Art History For Dummies

978-0-470-09910-0

ASVAB For Dummies, 2nd Edition

978-0-470-10671-6

British Military History For Dummies

978-0-470-03213-8

Calculus For Dummies

978-0-7645-2498-1

Canadian History For Dummies, 2nd Edition

978-0-470-83656-9

Geometry Workbook For Dummies

978-0-471-79940-5

The SAT I For Dummies, 6th Edition

978-0-7645-7193-0

Series 7 Exam For Dummies

978-0-470-09932-2

World History For Dummies

978-0-7645-5242-7

FOOD, GARDEN, HOBBIES & HOME

Bridge For Dummies, 2nd Edition

978-0-471-92426-5

Coin Collecting For Dummies, 2nd Edition

978-0-470-22275-1

Cooking Basics For Dummies, 3rd Edition

978-0-7645-7206-7

Drawing For Dummies

978-0-7645-5476-6

Etiquette For Dummies, 2nd Edition

978-0-470-10672-3

Gardening Basics For Dummies*†

978-0-470-03749-2

Knitting Patterns For Dummies

978-0-470-04556-5

Living Gluten-Free For Dummies†

978-0-471-77383-2

Painting Do-It-Yourself For Dummies

978-0-470-17533-0

HEALTH, SELF HELP, PARENTING & PETS

Anger Management For Dummies

978-0-470-03715-7

Anxiety & Depression Workbook For Dummies

978-0-7645-9793-0

Dieting For Dummies, 2nd Edition

978-0-7645-4149-0

Dog Training For Dummies, 2nd Edition

978-0-7645-8418-3

Horseback Riding For Dummies

978-0-470-09719-9

Infertility For Dummies†

978-0-470-11518-3

Meditation For Dummies with CD-ROM, 2nd Edition

978-0-471-77774-8

Post-Traumatic Stress Disorder For Dummies

978-0-470-04922-8

Puppies For Dummies, 2nd Edition

978-0-470-03717-1

Thyroid For Dummies, 2nd Edition†

978-0-471-78755-6

Type 1 Diabetes For Dummies*†

978-0-470-17811-9

* Separate Canadian edition also available

† Separate U.K. edition also available

Available wherever books are sold. For more information or to order direct: U.S. customers visit www.dummies.com or call 1-877-762-2974. U.K. customers visit www.wiley.com or call (0) 1243 843291. Canadian customers visit www.wiley.ca or call 1-800-567-4797.



INTERNET & DIGITAL MEDIA

AdWords For Dummies

978-0-470-15252-2

Blogging For Dummies, 2nd Edition

978-0-470-23017-6

Digital Photography All-in-One

Desk Reference For Dummies, 3rd Edition

978-0-470-03743-0

Digital Photography For Dummies, 5th Edition

978-0-7645-9802-9

Digital SLR Cameras & Photography For Dummies, 2nd Edition

978-0-470-14927-0

eBay Business All-in-One Desk Reference For Dummies

978-0-7645-8438-1

eBay For Dummies, 5th Edition*

978-0-470-04529-9

eBay Listings That Sell For Dummies

978-0-471-78912-3

Facebook For Dummies

978-0-470-26273-3

The Internet For Dummies, 11th Edition

978-0-470-12174-0

Investing Online For Dummies, 5th Edition

978-0-7645-8456-5

iPod & iTunes For Dummies, 5th Edition

978-0-470-17474-6

MySpace For Dummies

978-0-470-09529-4

Podcasting For Dummies

978-0-471-74898-4

Search Engine Optimization For Dummies, 2nd Edition

978-0-471-97998-2

Second Life For Dummies

978-0-470-18025-9

Starting an eBay Business For Dummies, 3rd Edition†

978-0-470-14924-9

GRAPHICS, DESIGN & WEB DEVELOPMENT

Adobe Creative Suite 3 Design Premium All-in-One Desk Reference For Dummies

978-0-470-11724-8

Adobe Web Suite CS3 All-in-One Desk Reference For Dummies

978-0-470-12099-6

AutoCAD 2008 For Dummies

978-0-470-11650-0

Building a Web Site For Dummies, 3rd Edition

978-0-470-14928-7

Creating Web Pages All-in-One Desk Reference For Dummies, 3rd Edition

978-0-470-09629-1

Creating Web Pages For Dummies, 8th Edition

978-0-470-08030-6

Dreamweaver CS3 For Dummies

978-0-470-11490-2

Flash CS3 For Dummies

978-0-470-12100-9

Google SketchUp For Dummies

978-0-470-13744-4

InDesign CS3 For Dummies

978-0-470-11865-8

Photoshop CS3 All-in-One Desk Reference For Dummies

978-0-470-11195-6

Photoshop CS3 For Dummies

978-0-470-11193-2

Photoshop Elements 5 For Dummies

978-0-470-09810-3

SolidWorks For Dummies

978-0-7645-9555-4

Visio 2007 For Dummies

978-0-470-08983-5

Web Design For Dummies, 2nd Edition

978-0-471-78117-2

Web Sites Do-It-Yourself For Dummies

978-0-470-16903-2

Web Stores Do-It-Yourself For Dummies

978-0-470-17443-2

LANGUAGES, RELIGION & SPIRITUALITY

Arabic For Dummies

978-0-471-77270-5

Chinese For Dummies, Audio Set

978-0-470-12766-7

French For Dummies

978-0-7645-5193-2

German For Dummies

978-0-7645-5195-6

Hebrew For Dummies

978-0-7645-5489-6

Ingles Para Dummies

978-0-7645-5427-8

Italian For Dummies, Audio Set

978-0-470-09586-7

Italian Verbs For Dummies

978-0-471-77389-4

Japanese For Dummies

978-0-7645-5429-2

Latin For Dummies

978-0-7645-5431-5

Portuguese For Dummies

978-0-471-78738-9

Russian For Dummies

978-0-471-78001-4

Spanish Phrases For Dummies

978-0-7645-7204-3

Spanish For Dummies

978-0-7645-5194-9

Spanish For Dummies, Audio Set

978-0-470-09585-0

The Bible For Dummies

978-0-7645-5296-0

Catholicism For Dummies

978-0-7645-5391-2

The Historical Jesus For Dummies

978-0-470-16785-4

Islam For Dummies

978-0-7645-5503-9

Spirituality For Dummies, 2nd Edition

978-0-470-19142-2

NETWORKING AND PROGRAMMING

ASP.NET 3.5 For Dummies

978-0-470-19592-5

C# 2008 For Dummies

978-0-470-19109-5

Hacking For Dummies, 2nd Edition

978-0-470-05235-8

Home Networking For Dummies, 4th Edition

978-0-470-11806-1

Java For Dummies, 4th Edition

978-0-470-08716-9

Microsoft® SQL Server™ 2008 All-in-One Desk Reference For Dummies

978-0-470-17954-3

Networking All-in-One Desk Reference For Dummies, 2nd Edition

978-0-7645-9939-2

Networking For Dummies, 8th Edition

978-0-470-05620-2

SharePoint 2007 For Dummies

978-0-470-09941-4

Wireless Home Networking For Dummies, 2nd Edition

978-0-471-74940-0

OPERATING SYSTEMS & COMPUTER BASICS

iMac For Dummies, 5th Edition

978-0-7645-8458-9

Laptops For Dummies, 2nd Edition

978-0-470-05432-1

Linux For Dummies, 8th Edition

978-0-470-11649-4

MacBook For Dummies

978-0-470-04859-7

Mac OS X Leopard All-in-One Desk Reference For Dummies

978-0-470-05434-5

Mac OS X Leopard For Dummies

978-0-470-05433-8

Macs For Dummies, 9th Edition

978-0-470-04849-8

PCs For Dummies, 11th Edition

978-0-470-13728-4

Windows® Home Server For Dummies

978-0-470-18592-6

Windows Server 2008 For Dummies

978-0-470-18043-3

Windows Vista All-in-One Desk Reference For Dummies

978-0-471-74941-7

Windows Vista For Dummies

978-0-471-75421-3

Windows Vista Security For Dummies

978-0-470-11805-4

SPORTS, FITNESS & MUSIC

Coaching Hockey For Dummies

978-0-470-83685-9

Coaching Soccer For Dummies

978-0-471-77381-8

Fitness For Dummies, 3rd Edition

978-0-7645-7851-9

Football For Dummies, 3rd Edition

978-0-470-12536-6

GarageBand For Dummies

978-0-7645-7323-1

Golf For Dummies, 3rd Edition

978-0-471-76871-5

Guitar For Dummies, 2nd Edition

978-0-7645-9904-0

Home Recording For Musicians For Dummies, 2nd Edition

978-0-7645-8884-6

iPod & iTunes For Dummies, 5th Edition

978-0-470-17474-6

Music Theory For Dummies

978-0-7645-7838-0

Stretching For Dummies

978-0-470-06741-3

Home:Dummies

DUMMIES.COM The Online Resource for the Rest of Us!

SEARCH

MY ACCOUNT SHOPPING CART HELP

Everyday Computing Advanced Computing The Internet At Home Health Mind & Spirit Making & Managing Money Sports & Leisure Travel Beyond the Classroom

Win the Ultimate Back-to-School Prize Package!

eTips
Subscribe to our free newsletters.
Sudoku/Puzzles
Catch the Fever! Free Sudoku and Kakuro Puzzles each day!
Podcasts
Whether reading a Dummies book or listening to a Dummies podcast, when you get Dummies, you get results.
RSS
It's all free to you so what are you waiting for?
Dummies Deals
At a store near you.

Around the World
View other Dummies editions

United Kingdom
Canada
Australia
Translations

Featured Books & Articles

Focus on Football
How Football Begins
Understanding Football's Downs, Yardage, and Stuff
How the Football Season is Set Up
Understanding Football's Defensive Line
Scoring in Football

Resource Center
iPhone
Office2007/Vista
Adobe CS3

Adobe Creative Suite 3 Web Premium All-in-One Desk Reference For Dummies

Basic Math & Pre-Algebra For Dummies

SEARCH

What's a Gigabook?

Win a \$500 Gift Card!

Dummies Biographies

Spring Cleaning

Featured Product
Wine For Dummies: Champagne, Flutes and Book Set
More Info >

Product Shop
• Consumer Electronics
• Crafts & Sewing Patterns
• Culinary
and more >

Get smart @ dummies.com®

- Find a full list of Dummies titles
- Look into loads of FREE on-site articles
- Sign up for FREE eTips e-mailed to you weekly
- See what other products carry the Dummies name
- Shop directly from the Dummies bookstore
- Enter to win new prizes every month!

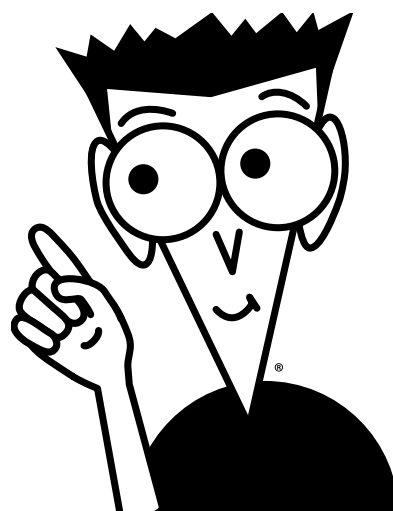

* Separate Canadian edition also available

† Separate U.K. edition also available

Available wherever books are sold. For more information or to order direct: U.S. customers visit www.dummies.com or call 1-877-762-2974. U.K. customers visit www.wiley.co.uk or call (0) 1243 843291. Canadian customers visit www.wiley.ca or call 1-800-567-4797.

Do More with Dummies Products for the Rest of Us!

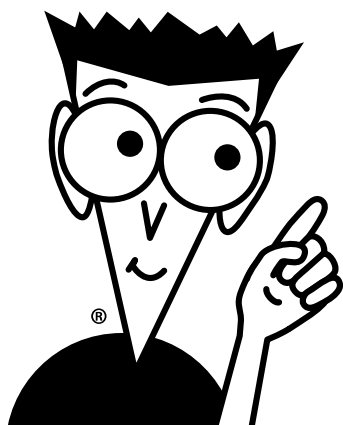
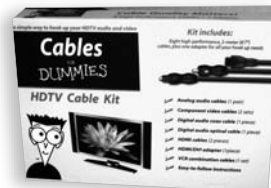
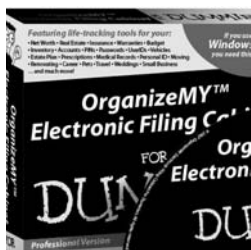
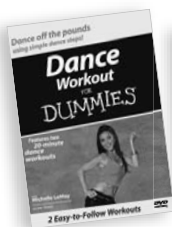
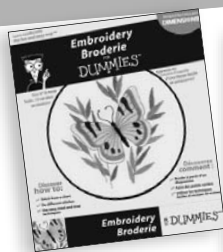

**DVDs • Music • Games • DIY
Consumer Electronics • Software • Crafts
Hobbies • Cookware • and more!**

Check out the Dummies Product Shop at www.dummies.com for more information!



Now updated — your guide to becoming a successful backyard beekeeper

Interested in raising honey bees? This friendly, practical guide presents a step-by-step approach to starting your own beehive, along with expert tips for maintaining a healthy colony. You get the latest on honey bee medication and treatments, harvesting and marketing your honey, and the impact the sudden disappearance of the honey bee has on our environment and economy.

- **To bee or not to bee?** — understand the benefits of beekeeping and whether it's right for you
- **Build your first hive** — gather the right equipment, obtain your bees, and transfer them safely to their new home
- **Get up-close and personal** — see how to open and close the hive, inspect your bees at the right times, and know what to look for
- **Handle common problems** — from swarming to robbing to pesticide poisoning, find simple solutions
- **Understand Colony Collapse Syndrome** — learn what you can do to help save the honey bees
- **Gear up for the golden harvest** — use the tools of the trade to extract honey, store it, and sell it

Praise for *Beekeeping For Dummies*

"The information a beginner needs to keep bees with confidence."
— Kim Flottum, *Bee Culture Magazine*

"A reader-friendly guide to beekeeping for novices or beginners."
— Dewey M. Caron, *Professor of Entomology, University of Delaware*

Howland Blackiston has more than 20 years' experience keeping bees. He has written many articles on beekeeping and appeared on dozens of television and radio programs, including CNBC, CNN, NPR, and Sirius Satellite Radio. Blackiston has been a keynote speaker at conferences in more than 40 countries.



Open the book and find:

- The various types of honey bees and the role each plays in a colony
- Hands-on instruction in building a hive
- How to keep bees healthier and more productive
- Guidelines for all phases of honey production
- New information on raising your own queens
- Plenty of helpful, illustrative pictures to guide you
- The safest ways to inspect and enjoy your bees
- A Beekeeper's Calendar organized by climate zones

Go to dummies.com[®] for more!

For Dummies[®]
A Branded Imprint of
 WILEY

\$19.99 US / \$23.99 CN / £13.99 UK

ISBN 978-0-470-43065-1

