



*Third
Edition*

COATINGS TECHNOLOGY HANDBOOK

Edited by
Arthur A. Tracton



Taylor & Francis
Taylor & Francis Group

*Third
Edition*

**COATINGS
TECHNOLOGY
HANDBOOK**

*Third
Edition*

COATINGS TECHNOLOGY HANDBOOK

Edited by
Arthur A. Tracton



Taylor & Francis
Taylor & Francis Group

Boca Raton London New York Singapore

A CRC title, part of the Taylor & Francis imprint, a member of the Taylor & Francis Group, the academic division of T&F Informa plc.

Published in 2006 by
CRC Press
Taylor & Francis Group
6000 Broken Sound Parkway NW, Suite 300
Boca Raton, FL 33487-2742

© 2006 by Taylor & Francis Group, LLC
CRC Press is an imprint of Taylor & Francis Group

No claim to original U.S. Government works
Printed in the United States of America on acid-free paper
10 9 8 7 6 5 4 3 2 1

International Standard Book Number-10: 1-57444-649-5 (Hardcover)
International Standard Book Number-13: 978-1-57444-649-4 (Hardcover)

This book contains information obtained from authentic and highly regarded sources. Reprinted material is quoted with permission, and sources are indicated. A wide variety of references are listed. Reasonable efforts have been made to publish reliable data and information, but the author and the publisher cannot assume responsibility for the validity of all materials or for the consequences of their use.

No part of this book may be reprinted, reproduced, transmitted, or utilized in any form by any electronic, mechanical, or other means, now known or hereafter invented, including photocopying, microfilming, and recording, or in any information storage or retrieval system, without written permission from the publishers.

For permission to photocopy or use material electronically from this work, please access www.copyright.com (<http://www.copyright.com/>) or contact the Copyright Clearance Center, Inc. (CCC) 222 Rosewood Drive, Danvers, MA 01923, 978-750-8400. CCC is a not-for-profit organization that provides licenses and registration for a variety of users. For organizations that have been granted a photocopy license by the CCC, a separate system of payment has been arranged.

Trademark Notice: Product or corporate names may be trademarks or registered trademarks, and are used only for identification and explanation without intent to infringe.

Library of Congress Cataloging-in-Publication Data

Catalog record is available from the Library of Congress

T&F informa

Taylor & Francis Group
is the Academic Division of T&F Informa plc.

Visit the Taylor & Francis Web site at
<http://www.taylorandfrancis.com>
and the CRC Press Web site at
<http://www.crcpress.com>

Preface to Third Edition

The world of coatings is very broad. The application techniques are many, and the uses are numerous. Technical people need to be aware of many things. One study said that a coating chemist must be proficient in 27 different disciplines. This book is directed at supplying a broad cross-index of some of the different aspects to help the technical person. It is not meant to be an in-depth treatise on any subject. It is meant to give insight into the various subjects covered. The chapter authors or the editor may be contacted for more information or direction on the subjects.

To aid the person involved in coatings, inks, or adhesives, be they chemists, engineers, technicians, researchers, or manufacturers, chapters are given in the areas of fundamentals and testing, coating and processing, techniques and materials, and surface coatings. Each section contains information to expand the awareness and knowledge of someone practicing in the field. The objective is to help people solve problems and increase their level of technology. With time, technology increases, as shown by the chapter on statistical design of experiments, and the chapter on using equipment to determine ultraviolet (UV) resistance. Newer materials such as fluorocarbon resins, polyurethane thickeners, and high-temperature pigments are included as well as older materials such as alkyds, clays, and driers.

To accomplish the presentation of technology, this book has been expanded to 118 chapters by adding new material and updating other material. Hopefully, the reader will expand his or her knowledge and further push the envelope of technology.

The editor gratefully acknowledges the many contributions of the chapter authors and the publishers who have made this book possible.

Arthur A. Tracton

Contributors

N. J. Abbott

Albany International Research
Company
Dedham, Massachusetts

Harold Van Aken

GretagMacbeth
New Windsor, New York

Walter Alina

General Magnaplate
Corporation
Linden, New Jersey

Mark J. Anderson

Stat-Ease, Inc.
Minneapolis, Minnesota

Robert D. Athey, Jr.

Athey Technologies
El Cerrito, California

Brian E. Aufderheide

W. H. Brady Company
Milwaukee, Wisconsin

Bruce R. Baxter

Specialty Products, Inc.
Lakewood, Washington

William F. Beach

Bridgeport, New Jersey

Edward A. Bernheim

Exxene Corporation
Corpus Christi, Texas

Deepak G. Bhat

GTE Valenite Corporation
Troy, Michigan

Thomas P. Blomstrom

Monsanto Chemical Company
Springfield, Massachusetts

Kenneth Bourlier

Union Carbide Corporation
Bound Brook, New Jersey

J. David Bower

Hoechst Celanese Corporation
Somerville, New Jersey

Donald L. Brebner

E. I. du Pont de Nemours &
Company
Wilmington, Delaware

Patrick Brennan

Q-Panel Lab Products
Cleveland, Ohio

George E. F. Brewer

George E. F. Brewer Coating
Consultants
Birmingham, Michigan

Lisa A. Burmeister

Aqualon Company
Wilmington, Delaware

Peter A. Callais

Pennwalt Corporation
Buffalo, New York

Naomi Luft Cameron

Datek Information Services
Newtonville, Massachusetts

Robert W. Carpenter

Windsor Plastics, Inc.
Evansville, Indiana

Chi-Ming Chan

Raychem Corporation
Menlo Park, California

Gary W. Cleary

Cygnus Research Corporation
Redwood City, California

Carl A. Dahlquist

3M Company
St. Paul, Minnesota

B. Davis

ABM Chemicals Limited
Stockport, Cheshire, England

Richey M. Davis

Hercules Incorporated
Wilmington, Delaware

David R. Day

Micromet Instruments, Inc.
Cambridge, Massachusetts

Marcel Dery

Chemical Fabrics Corporation
Merrimack, New Hampshire

Arnold H. Deutchman

BeamAlloy Corporation
Dublin, Ohio

John W Du

BYK-Chemie USA
Wallingford, Connecticut

Richard P. Eckberg

General Electric Company
Schenectady, New York

Jesse Edenbaum

Consultant
Cranston, Rhode Island

Eric T. Everett

Q-Panel Lab Products
Cleveland, Ohio

Carol Fedor

Q-Panel Lab Products
Cleveland, Ohio

William C. Feist

Consultant
Middleton, Wisconsin

R. H. Foster

Eval Company of America
Lisle, Illinois

James D. Gasper

ICI Resins US
Wilmington, Massachusetts

Sam Gilbert

Sun Chemical Corporation
Cincinnati, Ohio

K. B. Gilleo

Sheldahl, Inc.
Northfield, Minnesota

William S. Gilman

Gilman & Associates
South Plainfield, New Jersey

F. A. Goossens

Stork Brabant
Boxmeer, The Netherlands

Joseph Green

FMC Corporation
Princeton, New Jersey

Douglas Grossman

Q-Panel Lab Products
Cleveland, Ohio

Clive H. Hare

Coating System Design, Inc.
Lakeville, Massachusetts

**William F. Harrington,
Jr.**

Uniroyal Adhesives and Sealants
Company, Inc.
Mishawaka, Indiana

J. Rufford Harrison

E. I. du Pont de Nemours &
Company
Wilmington, Delaware

Helen Hatcher

Johnson Matthey Pigments &
Dispersions
Kidsgrove, Stoke-on-Trent,
Staffs, United Kingdom

Jack Hickey

International Paint Company
Union, New Jersey

Herman Hockmeyer

Hockmeyer Equipment
Corporation
Elizabeth City, North Carolina

Krister Holmberg

Chalmers University of
Technology
Göteborg, Sweden

Albert G. Hoyle

Hoyle Associates
Lowell, Massachusetts

H. F. Huber

Hüls Troisdorf AG
Troisdorf/Marl, Germany

Michael Iskowitz

Kop-Coat Marine Group
Rockaway, New Jersey

Joseph L. Johnson

Aqualon Company
Wilmington, Delaware

Stephen L. Kaplan

Plasma Science, Inc.
Belmont, California

Douglas S. Kendall

National Enforcement
Investigations Center
U.S. Environmental Protection
Agency
Denver Federal Center
Denver, Colorado

Ashok Khokhani

Engelhard Corporation
Iselin, New Jersey

Carol D. Klein

Spectra Colors Corporation
Kearny, New Jersey

Lisa C. Klein

Ceramic and Materials
Engineering
Rutgers — The State University
of New Jersey
Piscataway, New Jersey

Joseph V. Koleske

Charleston, West Virginia

Alan Lambuth

Boise Cascade
Boise, Idaho

Kenneth Lawson

DeSoto, Inc.
Des Plaines, Illinois

B. H. Lee

Ciba-Geigy Corporation
Ardsley, New York

Peter A. Lewis

Sun Chemical Corporation
Cincinnati, Ohio

Raimond Liepins

Los Alamos National Laboratory
Los Alamos, New Mexico

H. Thomas Lindland

Flynn Burner Corporation
New Rochelle, New York

Harry G. Lippert

Extrusion Dies, Inc.
Chippewa Falls, Wisconsin

Ronald A. Lombardi

ICI Resins US
Wilmington, Massachusetts

Donald M. MacLeod

Industry Tech
Oldsmar, Florida

Algirdas Matukonis

Kaunas Technical University
Kaunas, Lithuania

John A. McClenathan

IMD Corporation
Birmingham, Alabama

**Christopher W.
McGlinchey**

The Metropolitan Museum of
Art
New York, New York

Frederic S. McIntyre

Acumeter Laboratories, Inc.
Marlborough, Massachusetts

Timothy B. McSweeney

Screen Printing Association
International
Fairfax, Virginia

R. Milker

Lohmann GmbH
Neuwied, Germany

Samuel P. Morell

S. P. Morell and Company
Armonk, New York

Wayne E. Mozer

Oxford Analytical, Inc.
Andover, Massachusetts

Helmut W. J. Müller

BASF AG
Ludwigshafen/Rhein, Germany

Richard Neumann

Windmüller & Hölscher
Lengerich/Westfalen, Germany

Robert E. Norland

Norland Products, Inc.
North Brunswick, New Jersey

Milton Nowak

Troy Chemical
Newark, New Jersey

Michael O'Mary

The Armoloy Corporation
DeKalb, Illinois

Robert J. Partyka

BeamAlloy Corporation
Dublin, Ohio

John A. Pasquale III

Liberty Machine Company
Paterson, New Jersey

Patrick Patton

Q-Panel Lab Products
Cleveland, Ohio

Detlef van Peij

Solventborne Coatings —
Europe
Elementis GmbH
Cologne, Germany

Kim S. Percell

Witco Corporation
Memphis, Tennessee

Edwin P. Plueddemann

Dow Corning Corporation
Midland, Michigan

Liudas Pranevicius

Vytautas Magnus University
Kaunas, Lithuania

Charles P. Rader

Advanced Elastomer Systems,
L.P.
Akron, Ohio

Valentinas Rajeckas

Kaunas Polytechnic University
Kaunas, Lithuania

H. Randhawa

Vac-Tec Systems, Inc.
Boulder, Colorado

Richard Rathmell

Londonderry, New Hampshire

Donald A. Reinke

Oliver Products Company
(Retired)
Grand Rapids, Michigan

Peter W. Rose

Plasma Science, Inc.
Belmont, California

D. Satas

Satas & Associates
Warwick, Rhode Island

Milton C. Schmit

Plymouth Printing Company,
Inc.
Cranford, New Jersey

Jaykumar (Jay) J. Shah

Decora
Fort Edward, New York

Douglas N. Smith

Waterborne Coatings — Global
Elementis GmbH
Cologne, Germany

Steve Stalker

ITW Industrial Finishing
Glendale Heights, Illinois

Henry R. Stoner

Henry R. Stoner Associates
North Plainfield, New Jersey

D. Stoye

Hüls Troisdorf AG
Troisdorf/Marl, Germany

Larry S. Timm

Findley Adhesives, Inc.
Wauwatosa, Wisconsin

Harry H. Tomlinson

Witco Corporation
Memphis, Tennessee

Arthur A. Tracton

Consultant
Bridgewater, New Jersey

George D. Vaughn

Surface Specialties Melamines
Springfield, Massachusetts

A. Vaškėlis

Lithuanian Academy of Sciences
Vilnius, Lithuania

Subbu Venkatraman

Raychem Corporation
Menlo Park, California

**Theodore G.
Vernardakis**

BCM Inks USA, Inc.
Cincinnati, Ohio

Lawrence R. Waelde

Troy Corporation
Florham Park, New Jersey

Leonard E. Walp

Witco Corporation
Memphis, Tennessee

Patrick J. Whitcomb

Stat-Ease, Inc.
Minneapolis, Minnesota

K. Winkowski

ISP Corporation
Piscataway, New Jersey

Kurt A. Wood

Arkema, Inc.
King of Prussia, Pennsylvania

Daniel M. Zavisza

Hercules Incorporated
Wilmington, Delaware

Randall W. Zempel

Dow Chemical Company
Midland, Michigan

Ulrich Zorll

Forschungsinstitut für Pigmente
and Lacke
Stuttgart, Germany

Contents

I Fundamentals and Testing

1 Rheology and Surface Chemistry	1-1
<i>K. B. Gilleo</i>	
2 Coating Rheology	2-1
<i>Chi-Ming Chan and Subbu Venkatraman</i>	
3 Leveling	3-1
<i>D. Satas*</i>	
4 Structure–Property Relationships in Polymers	4-1
<i>Subbu Venkatraman</i>	
5 The Theory of Adhesion	5-1
<i>Carl A. Dahlquist</i>	
6 Adhesion Testing	6-1
<i>Ulrich Zorll</i>	
7 Coating Calculations	7-1
<i>Arthur A. Tracton</i>	
8 Infrared Spectroscopy of Coatings	8-1
<i>Douglas S. Kendall</i>	
9 Thermal Analysis for Coatings Characterizations	9-1
<i>William S. Gilman</i>	
10 Color Measurement for the Coatings Industry	10-1
<i>Harold Van Aken</i>	
11 The Use of X-ray Fluorescence for Coat Weight Determinations	11-1
<i>Wayne E. Mozer</i>	
12 Sunlight, Ultraviolet, and Accelerated Weathering	12-1
<i>Patrick Brennan and Carol Fedor</i>	
13 Cure Monitoring: Microdielectric Techniques	13-1
<i>David R. Day</i>	
14 Test Panels	14-1
<i>Douglas Grossman and Patrick Patton</i>	

*Deceased.

15	Design of Experiments for Coatings	15-1
	<i>Mark J. Anderson and Patrick J. Whitcomb</i>	
16	Top 10 Reasons Not to Base Service Life Predictions upon Accelerated Lab Light Stability Tests	16-1
	<i>Eric T. Everett</i>	
17	Under What Regulation?	17-1
	<i>Arthur A. Tracton</i>	

II Coating and Processing Techniques

18	Wire-Wound Rod Coating	18-1
	<i>Donald M. MacLeod</i>	
19	Slot Die Coating for Low Viscosity Fluids	19-1
	<i>Harry G. Lippert</i>	
20	Extrusion Coating with Acid Copolymers and Lonomers	20-1
	<i>Donald L. Brebner</i>	
21	Porous Roll Coater	21-1
	<i>Frederic S. McIntyre</i>	
22	Rotary Screen Coating	22-1
	<i>F. A. Goossens</i>	
23	Screen Printing	23-1
	<i>Timothy B. McSweeney</i>	
24	Flexography	24-1
	<i>Richard Neumann</i>	
25	Ink-Jet Printing	25-1
	<i>Naomi Luft Cameron</i>	
26	Electrodeposition of Polymers	26-1
	<i>George E. F. Brewer</i>	
27	Electroless Plating	27-1
	<i>A. Vakelis</i>	
28	The Electrolyzing Thin, Dense, Chromium Process	28-1
	<i>Michael O'Mary</i>	
29	The Armoloy Chromium Process	29-1
	<i>Michael O'Mary</i>	
30	Sputtered Thin Film Coatings	30-1
	<i>Brian E. Aufderheide</i>	
31	Vapor Deposition Coating Technologies	31-1
	<i>Lindas Pranevicius</i>	

32	Cathodic Arc Plasma Deposition	32-1
	<i>H. Randhawa</i>	
33	Industrial Diamond and Diamondlike Films	33-1
	<i>Arnold H. Deutchman and Robert J. Partyka</i>	
34	Tribological Synergistic Coatings.....	34-1
	<i>Walter Alina</i>	
35	Chemical Vapor Deposition	35-1
	<i>Deepak G. Bhat</i>	
36	Solvent Vapor Emission Control	36-1
	<i>Richard Rathmell</i>	
37	Surface Treatment of Plastics.....	37-1
	<i>William F. Harrington, Jr.</i>	
38	Flame Surface Treatment	38-1
	<i>H. Thomas Lindland</i>	
39	Plasma Surface Treatment.....	39-1
	<i>Stephen L. Kaplan and Peter W. Rose</i>	
40	Surface Pretreatment of Polymer Webs by Fluorine.....	40-1
	<i>R. Milker and Artur Koch</i>	
41	Calendering of Magnetic Media	41-1
	<i>John A. McClenathan</i>	
42	Embossing	42-1
	<i>John A. Pasquale III</i>	
43	In-Mold Finishing.....	43-1
	<i>Robert W. Carpenter</i>	
44	HVLP: The Science of High-Volume, Low-Pressure Finishing	44-1
	<i>Steve Stalker</i>	
45	A Practical Guide to High-Speed Dispersion	45-1
	<i>Herman Hockmeyer</i>	

III Materials

46	Acrylic Polymers	46-1
	<i>Ronald A. Lombardi and James D. Gasper</i>	
47	Vinyl Ether Polymers.....	47-1
	<i>Helmut W. J. Müller</i>	
48	Poly(Styrene-Butadiene)	48-1
	<i>Randall W. Zempel</i>	

49	Liquid Polymers for Coatings	49-1
	<i>Robert D. Athey, Jr.</i>	
50	Polyesters	50-1
	<i>H. F. Huber and D. Stoye</i>	
51	Alkyd Resins	51-1
	<i>Krister Holmberg</i>	
52	The Polyurea Revolution: Protective Coatings for the 21st Century	52-1
	<i>Bruce R. Baxter</i>	
53	Phenolic Resins	53-1
	<i>Kenneth Bourlier</i>	
54	Coal Tar and Asphalt Coatings	54-1
	<i>Henry R. Stoner</i>	
55	Vulcanizate Thermoplastic Elastomers	55-1
	<i>Charles P. Rader</i>	
56	Olefinic Thermoplastic Elastomers	56-1
	<i>Jesse Edenbaum</i>	
57	Ethylene Vinyl Alcohol Copolymer (EVOH) Resins	57-1
	<i>R. H. Foster</i>	
58	Elastomeric Alloy Thermoplastic Elastomers	58-1
	<i>Charles P. Rader</i>	
59	Polyvinyl Chloride and Its Copolymers in Plastisol Coatings	59-1
	<i>Jesse Edenbaum</i>	
60	Polyvinyl Acetal Resins	60-1
	<i>Thomas P. Blomstrom</i>	
61	Polyimides	61-1
	<i>B. H. Lee</i>	
62	Parylene Coating	62-1
	<i>William F. Beach</i>	
63	Nitrocellulose	63-1
	<i>Daniel M. Zavisza</i>	
64	Soybean, Blood, and Casein Glues	64-1
	<i>Alan Lambuth</i>	
65	Fish Gelatin and Fish Glue	65-1
	<i>Robert E. Norland</i>	
66	Waxes	66-1
	<i>J. David Bower</i>	
67	Carboxymethylcellulose	67-1
	<i>Richey M. Davis</i>	

68	Hydroxyethylcellulose	68-1
	<i>Lisa A. Burmeister</i>	
69	Antistatic and Conductive Additives.....	69-1
	<i>B. Davis</i>	
70	Silane Adhesion Promoters.....	70-1
	<i>Edwin P. Plueddemann</i>	
71	Chromium Complexes	71-1
	<i>J. Rufford Harrison</i>	
72	Nonmetallic Fatty Chemicals as Internal Mold Release Agents in Polymers	72-1
	<i>Kim S. Percell, Harry H. Tomlinson, and Leonard E. Walp</i>	
73	Organic Peroxides.....	73-1
	<i>Peter A. Callais</i>	
74	Surfactants for Waterborne Coatings Applications.....	74-1
	<i>Samuel P. Morell</i>	
75	Surfactants, Dispersants, and Defoamers for the Coatings, Inks, and Adhesives Industries.....	75-1
	<i>John W Du</i>	
76	Pigment Dispersion	76-1
	<i>Theodore G. Vernardakis</i>	
77	Colored Inorganic Pigments.....	77-1
	<i>Peter A. Lewis</i>	
78	Organic Pigments	78-1
	<i>Peter A. Lewis</i>	
79	Amino Resins	79-1
	<i>George D. Vaughn</i>	
80	Driers	80-1
	<i>Milton Nowak</i>	
81	Biocides for the Coatings Industry	81-1
	<i>K. Winkowski</i>	
82	Clays.....	82-1
	<i>Ashok Khokhani</i>	
83	Fluorocarbon Resins for Coatings and Inks.....	83-1
	<i>Kurt A. Wood</i>	
84	High Temperature Pigments.....	84-1
	<i>Helen Hatcher</i>	
85	Polyurethane Associative Thickeners for Waterborne Coatings	85-1
	<i>Douglas N. Smith and Detlef van Peij</i>	

IV Surface Coatings

86 Flexographic Inks.....	86-1
<i>Sam Gilbert</i>	
87 Multicolor Coatings.....	87-1
<i>Robert D. Athey, Jr.</i>	
88 Paintings Conservation Varnish.....	88-1
<i>Christopher W. McGlinchey</i>	
89 Thermoset Powder Coatings.....	89-1
<i>Lawrence R. Waelde</i>	
90 Peelable Medical Coatings	90-1
<i>Donald A. Reinke</i>	
91 Conductive Coatings	91-1
<i>Raimond Liepins</i>	
92 Silicone Release Coatings	92-1
<i>Richard P. Eckberg</i>	
93 Silicone Hard Coatings.....	93-1
<i>Edward A. Bernheim</i>	
94 Pressure-Sensitive Adhesives and Adhesive Products.....	94-1
<i>D. Satas*</i>	
95 Self-Seal Adhesives.....	95-1
<i>Larry S. Timm</i>	
96 Solgel Coatings.....	96-1
<i>Lisa C. Klein</i>	
97 Radiation-Cured Coatings	97-1
<i>Joseph V. Koleske</i>	
98 Nonwoven Fabric Binders	98-1
<i>Albert G. Hoyle</i>	
99 Fire-Retardant/Fire-Resistive Coatings.....	99-1
<i>Joseph Green</i>	
100 Leather Coatings	100-1
<i>Valentinas Rajeckas</i>	
101 Metal Coatings	101-1
<i>Robert D. Athey, Jr.</i>	
102 Corrosion and Its Control by Coatings	102-1
<i>Clive H. Hare</i>	
103 Marine Coatings Industry.....	103-1
<i>Jack Hickey</i>	

104	Decorative Surface Protection Products	104-1
	<i>Jaykumar (Jay) J. Shah</i>	
105	Coated Fabrics for Protective Clothing	105-1
	<i>N. J. Abbott</i>	
106	Coated Fabrics for Apparel Use: The Problem of Comfort	106-1
	<i>N. J. Abbott</i>	
107	Architectural Fabrics	107-1
	<i>Marcel Dery</i>	
108	Gummed Tape	108-1
	<i>Milton C. Schmit</i>	
109	Transdermal Drug Delivery Systems	109-1
	<i>Gary W. Cleary</i>	
110	Optical Fiber Coatings	110-1
	<i>Kenneth Lawson</i>	
111	Exterior Wood Finishes	111-1
	<i>William C. Feist</i>	
112	Pharmaceutical Tablet Coating	112-1
	<i>Joseph L. Johnson</i>	
113	Textiles for Coating	113-1
	<i>Algirdas Matukonis</i>	
114	Nonwovens as Coating and Laminating Substrates	114-1
	<i>Albert G. Hoyle</i>	
115	General Use of Inks and the Dyes Used to Make Them	115-1
	<i>Carol D. Klein</i>	
116	Gravure Inks	116-1
	<i>Sam Gilbert</i>	
117	Artist's Paints: Their Composition and History	117-1
	<i>Michael Iskowitz</i>	
118	Fade Resistance of Lithographic Inks — A New Path Forward: Real World Exposures in Florida and Arizona Compared to Accelerated Xenon Arc Exposures	118-1
	<i>Eric T. Everett, John Lind, and John Stack</i>	

I

Fundamentals and Testing

1

Rheology and Surface Chemistry

1.1	Introduction	1-1
1.2	Rheology	1-2
	Types of Viscosity Behavior • Temperature Effects • Solvent Effects • Viscosity Measurement • Yield Value	
1.3	Surface Chemistry	1-8
	Surface Tension • Measuring Surface Tension • Wetting • Surfactants • Leveling	
1.4	Summary	1-12
	References	1-12
	Bibliography	1-12

K. B. Gilleo
Sheldahl, Inc.

1.1 Introduction

A basic understanding of rheology and surface chemistry, two primary sciences of liquid flow and solid–liquid interaction, is necessary for understanding coating and printing processes and materials. A generally qualitative treatment of these subjects will suffice to provide the insight needed to use and apply coatings and inks and to help solve the problems associated with their use.

Rheology, in the broadest sense, is the study of the physical behavior of all materials when placed under stress. Four general categories are recognized: elasticity, plasticity, rigidity, and viscosity. Our concern here is with liquids and pastes. The scope of rheology of fluids encompasses the changes in the shape of a liquid as physical force is applied and removed. Viscosity is a key rheological property of coatings and inks. Viscosity is simply the resistance of the ink to flow — the ratio of shear stress to shear rate.

Throughout coating and printing processes, mechanical forces of various types and quantities are exerted. The amount of shear force directly affects the viscosity value for non-Newtonian fluids. Most coatings undergo some degree of “shear thinning” phenomenon when worked by mixing or running on a coater. Heavy inks are especially prone to shear thinning. As shear rate is increased, the viscosity drops, in some cases, dramatically.

This seems simple enough except for two other effects. One is called the yield point. This is the shear rate required to cause flow. Ketchup often refuses to flow until a little extra shear force is applied. Then it often flows too freely. Once the yield point has been exceeded the solidlike behavior vanishes. The loose network structure is broken up. Inks also display this yield point property, but to a lesser degree. Yield point is one of the most important ink properties.

Yield value, an important, but often ignored attribute of liquids, will also be discussed. We must examine rheology as a dynamic variable and explore how it changes throughout the coating process. The mutual interaction, in which the coating process alters viscosity and rheology affects the process, will be a key concept in our discussions of coating technology.

The second factor is time dependency. Some inks change viscosity over time even though a constant shear rate is being applied. This means that viscosity can be dependent on the amount of mechanical force applied and on the length of time. When shearing forces are removed, the ink will return to the initial viscosity. That rate of return is another important ink property. It can vary from seconds to hours.

Rheology goes far beyond the familiar snapshot view of viscosity at a single shear rate, which is often reported by ink vendors. It deals with the changes in viscosity as different levels of force are applied, as temperature is varied, and as solvents and additives come into play. Brookfield viscometer readings, although valuable, do not show the full picture for non-Newtonian liquids.

Surface chemistry describes wetting (and dewetting) phenomena resulting from mutual attractions between ink molecules, as well as intramolecular attractions between ink and the substrate surface. The relative strengths of these molecular interactions determine a number of ink performance parameters. Good print definition, adhesion, and a smooth ink surface all require the right surface chemistry. Bubble formation and related film formation defects also have their basis in surface chemistry.

Surface chemistry, for our purposes, deals with the attractive forces liquid molecules exhibit for each other and for the substrate. We will focus on the wetting phenomenon and relate it to coating processes and problems. It will be seen that an understanding of wetting and dewetting will help elucidate many of the anomalies seen in coating and printing.

The two sciences of rheology and surface tension, taken together, provide the tools required for handling the increasingly complex technology of coating. It is necessary to combine rheology and surface chemistry into a unified topic to better understand inks and the screen printing process. We will cover this unification in a straightforward and semiquantitative manner. One benefit will be the discovery that printing and coating problems often blamed on rheology have their basis in surface chemistry. We will further find that coating leveling is influenced by both rheology and surface chemistry.

1.2 Rheology

Rheology, the science of flow and deformation, is critical to the understanding of coating use, application, and quality control. Viscosity, the resistance to flow, is the most important rheological characteristic of liquids and therefore of coatings and inks. Even more significant is the way in which viscosity changes during coating and printing. Newtonian fluids, like solvents, have an absolute viscosity that is unaltered by the application of mechanical shear. However, virtually all coatings show a significant change in viscosity as different forces are applied. We will look at the apparent viscosity of coatings and inks and discover how these force-induced changes during processing are a necessary part of the application process.

Viscosity, the resistance of a liquid to flow, is a key property describing the behavior of liquids subjected to forces such as mixing. Other important forces are gravity, surface tension, and shear associated with the method of applying the material. Viscosity is simply the ratio of shear stress to shear rate (Equation 1.3). A high viscosity liquid requires considerable force (work) to produce a change in shape. For example, high viscosity coatings are not as easily pumped as are the low viscosity counterparts. High viscosity coatings also take longer to flow out when applied.

$$\text{Shear rate, } D = \frac{\text{velocity}}{\text{thickness}} (\text{sec}^{-1}) \quad (1.1)$$

$$\text{Shear stress, } \tau = \frac{\text{force}}{\text{area}} (\text{dynes/cm}^2) \quad (1.2)$$

$$\text{Viscosity, } \eta = \frac{\text{shear stress}}{\text{shear rate}} = \frac{\tau}{D} (\text{dynes} \cdot \text{sec/cm}^2) \quad (1.3)$$

TABLE 1.1 Viscosities of Common Industrial Liquids

Liquid	Viscosity (cP)
Acetone	0.32
Chloroform	0.58
Toulene	0.59
Water, standard 2(20°C)	1.0000
Cyclohexane	1.0
Ethyl alcohol	1.2
Turpentine	1.5
Mercury, metal	1.6
Creosote	12.0
Sulfuric acid	25.4
Lindseed oil	33.1
Olive oil	84.0
Castor oil	986.0
Glycerine	1490.0
Venice turpentine	130,000.0

Values are for approximately 20°C.

Source: From *Handbook of Chemistry and Physics*, 64th ed., CRC Press, Boca Raton, FL, 1984.¹

As indicated above, shear stress, the force per unit area applied to a liquid, is typically in dynes per square centimeter, the force per unit area. Shear rate is in reciprocal seconds (sec^{-1}), the amount of mechanical energy applied to the liquid. Applying Equation 1.3, the viscosity unit becomes dyne-seconds per square centimeter or poise (P). For low viscosity fluids like water (≈ 0.01 P), the poise unit is rather small, and the more common centipoise (0.01 P) is used. Since 100 centipoise = 1 poise, water has a viscosity of about 1 centipoise (cP). Screen inks are much more viscous and range from 1000 to 10,000 cP for graphics and as high as 50,000 cP for some highly loaded polymer thick film (PTF) inks and adhesives. Viscosity is expressed in pascal-seconds (Pa·sec) in the international system of units (SI: 1 Pa·sec = 1000 cP). Viscosity values of common industrial liquids are provided in Table 1.1.

Viscosity is rather a simple concept. Thin, or low viscosity liquids flow easily, while high viscosity ones move with much resistance. The ideal, or Newtonian, case has been assumed. With Newtonian fluids, viscosity is constant over any region of shear. Very few liquids are truly Newtonian. More typically, liquids drop in viscosity as shear or work is applied. The phenomenon was identified above as shear thinning. It is, therefore, necessary to specify exactly the conditions under which a viscosity value is measured. Time must also be considered in addition to shear stress. A liquid can be affected by the amount of time that force is applied. A shear-thinned liquid will tend to return to its initial viscosity over time. Therefore, time under shearing action and time at rest are necessary quantifiers if viscosity is to be accurately reported.

It should be apparent that we are really dealing with a viscosity curve, not a fixed point. The necessity of dealing with viscosity curves is even more pronounced in plastic decorating. A particular material will experience a variety of different shear stresses. For example, a coating may be mixed at relatively low shear stress of 10 to 20 cP, pumped through a spray gun line at 1000 cP, sprayed through an airless gun orifice at extreme pressure exceeding 10^6 cP, and finally allowed to flow out on the substrate under mild forces of gravity (minor) and surface tension. It is very likely that the material will have a different viscosity at each stage. In fact, a good product should change in viscosity under applications processing.

1.2.1 Types of Viscosity Behavior

1.2.1.1 Plasticity

Rheologically speaking, plastic fluids behave more like plastic solids until a specific minimum force is applied to overcome the yield point. Gels, sols, and ketchup are extreme examples. Once the yield point has been reached, the liquid begins to approach Newtonian behavior as shear rate is increased. Figure

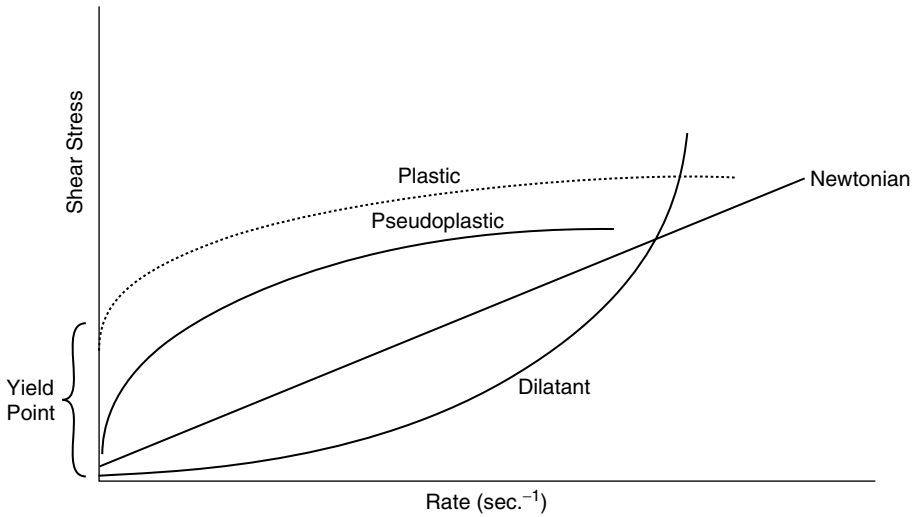

FIGURE 1.1 Shear stress–shear rate curves.

1.1 shows the shear stress–shear rate curve and the yield point. Although plastic behavior is of questionable value to ketchup, it has some benefit in inks and paints. Actually, it is the yield point phenomenon that is of practical value. No-drip paints are an excellent example of the usefulness of yield point. After the brush stroke force has been removed, the paint's viscosity builds quickly until flow stops. Dripping is prevented because the yield point exceeds the force of gravity.

Ink bleed in a printing ink, the tendency to flow beyond the printed boundaries, is controlled by yield point. Inks with a high yield point will not bleed, but their flow out may be poor. A very low yield point will provide excellent flow out, but bleed may be excessive. Just the right yield point provides the needed flow out and leveling without excessive bleed. Both polymer binders and fillers can account for the yield point phenomenon. At rest, polymer chains are randomly oriented and offer more resistance to flow. Application of shear force straightens the chains in the direction of flow, reducing resistance. Solid fillers can form loose molecular attraction structures, which break down quickly under shear.

1.2.1.2 Pseudoplasticity

Like plastic-behaving materials, pseudoplastic liquids drop in viscosity as force is applied. There is no yield point, however. The more energy applied, the greater the thinning. When shear rate is reduced, the viscosity increases at the same rate by which the force is diminished. There is no hysteresis; the shear stress–shear rate curve is the same in both directions as was seen in Figure 1.1. [Figure 1.2](#) compares pseudoplastic behavior using viscosity–shear rate curves.

Many coatings exhibit this kind of behavior, but with time dependency. There is a pronounced delay in viscosity increase after force has been removed. This form of pseudoplasticity with a hysteresis loop is called thixotropy. Pseudoplasticity is generally a useful property for coatings and inks. However, thixotropy is even more useful.

1.2.1.2.1 Thixotropy

Thixotropy is a special case of pseudoplasticity. The material undergoes “shear thinning”; but as shear forces are reduced, viscosity increases at a lesser rate to produce a hysteresis loop. Thixotropy is very common and very useful. Dripless house paints owe their driplessness to thixotropy. The paint begins as a moderately viscous material that stays on the brush. It quickly drops in viscosity under the shear stress of brushing for easy, smooth application. A return to higher viscosity, when shearing action stops, prevents dripping and sagging.

Screen printing inks also benefit from thixotropy. The relatively high viscosity screen ink drops abruptly in viscosity under the high shear stress associated with being forced through a fine mesh screen. The

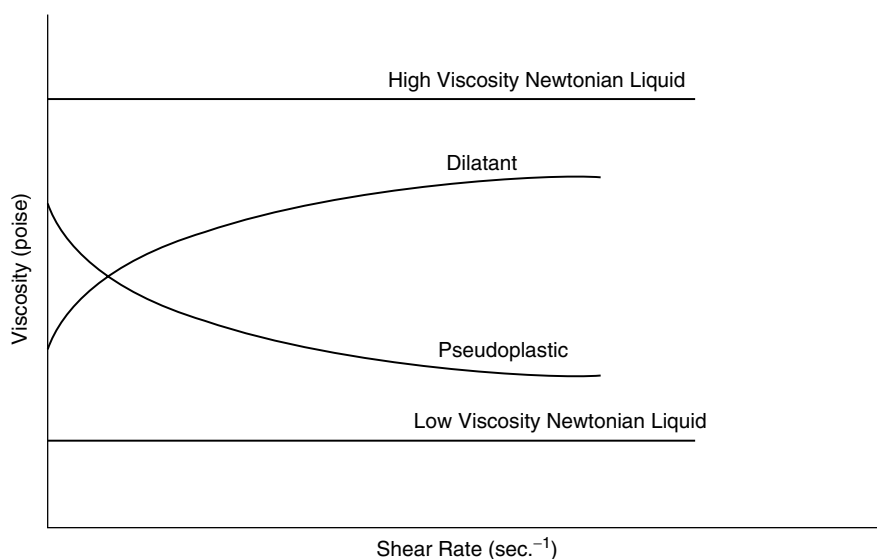

FIGURE 1.2 Viscosity shear rate curves.

momentary low viscosity permits the printed ink dots to merge together into a solid, continuous film. Viscosity returns to a higher range before the ink can “bleed” beyond the intended boundaries.

Thixotropic materials yield individual hysteresis loops. Shear stress lowers viscosity to a point at which higher force produces no further change. As energy input to the liquid is reduced, viscosity begins to build again, but more slowly than it initially dropped. It is not necessary to know the shape of the viscosity loop, but merely to realize that such a response is common in decorating inks, paints, and coatings.

The presence in decorating vehicles of pigments, flattening agents, and other solid fillers usually produces or increases thixotropic behavior. More highly loaded materials, such as inks, are often highly thixotropic. Thixotropic agents, consisting of flat, platelet structures, can be added to liquids to adjust thixotropy. A loose, interconnecting network forms between the platelets to produce the viscosity increase. Shearing breaks down the network, resulting in the viscosity drop.

Mixing and other high shear forces rapidly reduce viscosity. However, thixotropic inks continue to thin down while undergoing shearing, even if the shear stress is constant. This can be seen with a Brookfield viscometer, where measured viscosity continues to drop while the spindle turns at constant rpms. When the ink is left motionless, viscosity builds back to the initial value. This can occur slowly or rapidly. Curves of various shapes are possible, but they will all display a hysteresis loop. In fact, this hysteresis curve is used to detect thixotropy (see [Figure 1.3](#)). The rate of viscosity change is an important characteristic of an ink which is examined later as we take an ink step by step through screen printing. Thixotropy is very important to proper ink behavior, and the changing viscosity attribute makes screen printing possible.

1.2.1.2.2 Dilatancy

Liquids that show an increase in viscosity as shear is applied are called dilatants. Very few liquids possess this property. Dilatant behavior should not be confused with the common viscosity build, which occurs when inks and coatings lose solvent. For example, a solvent-borne coating applied by a roll coater will show a viscosity increase as the run progresses. The rotating roller serves as a solvent evaporator, increasing the coating's solids content and, therefore, the viscosity. True dilatancy occurs independently of solvent loss.

1.2.1.2.3 Rheoplexy

Sounding more like a disease than a property, rheoplexy is the exact opposite of thixotropy. It is the time-dependent form of dilatancy where mixing causes shear thickening. [Figure 1.3](#) showed the hysteresis loop. Rheoplexy is fortunately rare, because it is totally useless as a characteristic for screen print inks.

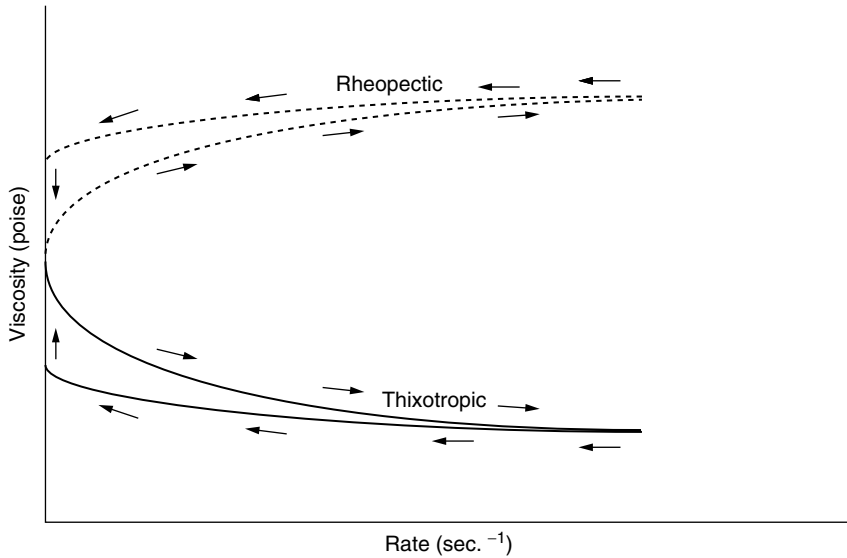

FIGURE 1.3 Shear stress–shear rate curves: hysteresis loop.

1.2.2 Temperature Effects

Viscosity is strongly affected by temperature. Measurements should be taken at the same temperature (typically 23°C). A viscosity value is incomplete without a temperature notation.

Although each liquid is affected differently by a temperature change, the change per degree is usually a constant for a particular material. The subject of temperature effects has been covered thoroughly elsewhere.² It will suffice to say that a coating's viscosity may be reduced by heating, a principle used in many coating application systems.

Viscosity reduction by heating may also be used after a material has been applied. Preheating of ultraviolet (UV)-curable coatings just prior to UV exposure is often advantageous for leveling out these sometimes viscous materials.

1.2.3 Solvent Effects

Higher resin solids produce higher solution viscosity, while solvent addition reduces viscosity. It is important to note that viscosity changes are much more pronounced in the case of soluble resins (polymers) than for insoluble pigments or plastic particles. For example, although a coating may be highly viscous at 50% solids, a plastisol suspension (plastic particles in liquid plasticizer) may have medium viscosity at 80% solids. Different solvents will produce various degrees of viscosity reduction depending on whether they are true solvents, latent solvents, or nonsolvents. This subject has been treated extensively elsewhere.^{2,3}

1.2.4 Viscosity Measurement

Many instruments are available. A rheometer is capable of accurately measuring viscosities through a wide range of shear stress. Much simpler equipment is typically used in the plastic decorating industry. As indicated previously, perhaps the most common device is the Brookfield viscometer, in which an electric motor is coupled to an immersion spindle through a tensiometer. The spindle is rotated in the liquid to be measured. The higher the viscosity (resistance to flow), the larger is the reading on the tensiometer. Several spindle diameters are available, and a number of rotational speeds may be selected. Viscosity must be reported along with spindle size and rotational speed and temperature.

TABLE 1.2 Viscosity Conversions^a

	Consistency								
	Watery			Medium			Heavy		
Poise:	0.1	0.5	1.0	2.5	5.0	10	50	100	150
Centipoise:	10	50	100	250	500	1,000	5,000	10,000	15,000
Viscosity device									
Fisher #1	20								
Fisher #2		24	50						
Ford #4 cup	5	22	34	67					
Parlin #10	11	17	25	55					
Parlin #15				12	25	47	232	465	697
Saybolt	60	260	530	1,240	2,480	4,600	23,500	46,500	69,500
Zahn #1	30	60							
Zahn #2	16	24	37	85					
Zahn #3			12	29	57				
Zahn #4			10	21	37				

^a Liquids are at 25°C. Values are in seconds for liquids with specific gravity of approximately 1.0.

Source: Binks Inc., ITW Industrial Finishing, 195 International Boulevard, Glendale Heights, IL 60134.

The Brookfield instrument is a good tool for incoming quality control. Although certainly not a replacement for the rheometer, the viscometer may be used to estimate viscosity change with shear. Viscosity readings are taken at different rpms and then compared. A highly thixotropic material will be easily identified.

An even simpler viscosity device is the flow cup, a simple container with an opening at the bottom. The Ford cup and the Zahn cup are very common in the plastic painting and coating field. The Ford cup, the more accurate of the two, is supported on a stand. Once filled, the bottom orifice is unstoppered and the time for the liquid to flow out is recorded. Unlike the Brookfield, which yields a value in centipoise, the cup gives only a flow time. Relative flow times reflect different relative viscosities. Interconversion charts permit Ford and other cup values to be converted to centipoise (Table 1.2).

The Zahn cup is dipped in a liquid sample by means of its handle and quickly withdrawn, whereupon time to empty is recorded. The Zahn type of device is commonly used on line, primarily as a checking device for familiar materials.

1.2.5 Yield Value

The yield value is the shear stress in a viscosity measurement, but one taken at very low shear. The yield value is the minimum shear stress, applied to a liquid, that produces flow. As force is gradually applied, a liquid undergoes deformation without flowing. In essence, the liquid is behaving as if it were an elastic solid. Below the yield value, viscosity approaches infinity. At a critical force input (the yield value) flow commences.

The yield value is important in understanding the behavior of decorating liquids after they have been deposited onto the substrate. Shear stress, acting on a deposited coating or ink, is very low. Although gravity exerts force on the liquid, surface tension is considerably more important.

If the yield value is greater than shear stress, flow will not occur. The liquid will behave as if it were a solid. In this situation, what you deposit is what you get. Coatings that refuse to level, even though the apparent viscosity is low, probably have a relatively high yield value. As we will see in the next section, surface tension forces, although alterable, cannot be changed enough to overcome a high yield value. Unfortunately, a high yield value may be an intrinsic property of the decorative material. Under these circumstances, changing the material application method may be the only remedy.

Although a high yield value can make a coating unusable, the property can be desirable for printing inks. Once an ink has been deposited, it should remain where placed. Too low a yield value can allow an ink to flow out, producing poor, irregular edge definition. An ink with too high a value may flow out

poorly. As pigments tend to increase yield value, color inks are not a problem. Clear protective inks can be a problem, especially when a thick film is deposited, as in screen printing. When it is not practical to increase yield value, wettability can sometimes be favorably altered through surface tension modification. Increasing surface tension will inhibit flow and therefore ink or coating bleed.

1.3 Surface Chemistry

Surface chemistry is the science that deals with the interface of two materials. The interface may exist between any forms of matter, including a gas phase. For the purpose of understanding the interfacial interaction of decorative liquid materials, we need only analyze the liquid–solid interaction. Although there is a surface interaction between a liquid coating and the air surrounding it, the effect is small and may be ignored.

1.3.1 Surface Tension

All liquids are made up of submicroscopic combinations of atoms called molecules (a very few liquids are made up of uncombined atoms). All molecules that are close to one another exert attractive forces. It is these mutual attractions that produce the universal property called surface tension. The units are force per unit length: dynes per centimeter.

A drop of liquid suspended in space quickly assumes a spherical shape. As surface molecules are pulled toward those directly beneath them, a minimum surface area (sphere) results. The spherical form is the result of an uneven distribution of force; molecules within the droplet are attracted from all directions, while those at the surface are pulled only toward molecules below them. All liquids attempt to form a minimum surface sphere. A number of counterforces come into play, however. A liquid placed on a solid provides a liquid–solid interface. This type of interface is critically important to the plastic decorator, as liquid molecules are attracted not only to each other (intramolecular attraction) but also to any solid surface (intermolecular attraction) with which they come in contact. We need only concern ourselves with these two interactions; intra- and intermolecular. A fundamental understanding of this interfacial interaction will permit the decorator to optimize materials and processes.

1.3.2 Measuring Surface Tension

Every liquid has a specific surface tension value. Liquids with high surface tensions, such as water (73 dynes/cm), demonstrate a high intramolecular attraction and a strong tendency to bead up (form spheres). Liquids with low values have a weak tendency toward sphere formation that is easily overcome by countering forces.

A variety of methods are available for measuring liquid surface tension. [Table 1.3](#) gives values for common solvents. Methods are also available for determining the surface tension of solids, which is usually referred to as surface energy. [Table 1.4](#) gives surface energy values for plastics. We need be concerned only with ways of estimating surface tension and with techniques for determining relative differences.

1.3.3 Wetting

A liquid placed on a flat, horizontal solid surface either will wet and flow out, or it will dewet to form a semispherical drop. An in-between state may also occur in which the liquid neither recedes nor advances but remains stationary. The angle that the droplet or edge of the liquid makes with the solid plane is called the *contact angle* ([Figure 1.4](#)).

A nonwetting condition exists when the contact angle exceeds 0° — that is, when the angle is measurable. The liquid's intramolecular attraction is greater than its attraction for the solid surface. The liquid surface tension value is higher than the solid's surface energy. A wetting condition occurs when the contact angle is 0° . The liquid's edge continues to advance, even though the rate may be slow for

TABLE 1.3 Surface Tension of Liquids

Liquid	Surface Tension (dynes/cm)
SF ₆	5.6
Trifluoroacetic acid	15.6
Heptane	22.1
Methanol	24.0
Acetone	26.3
Dimethylformamide (DMF)	36.8
Dimethyl sulfoxide (DMSO)	43.5
Ethylene glycol	48.4
Formamide	59.1
Glycerol	63.1
Diiodomethane	70.2
Water	72.8
Mercury, metal	490.6

Source: From Dean, J., Ed., *Lange's Handbook of Chemistry*, 13th ed., McGraw-Hill, New York, 1985.⁴

TABLE 1.4 Surface Tension of Polymers

Polymer	Surface Tension (dynes/cm)
Polyperfluoropropylene	16
Polytetrafluoroethylene (Teflon)	18.5
Polydimethylsiloxane	24
Polyethylene	31
Polystyrene	34
Polymethylmethacrylate (acrylic)	39
Polyvinyl chloride (PVC)	40
Polyethylene terephthalate (polyester)	43
Polyhexamethylene adipate (nylon)	46

Source: From Bikales, N.M., *Adhesion and Bonding*, Wiley-Interscience, New York, 1971.⁵

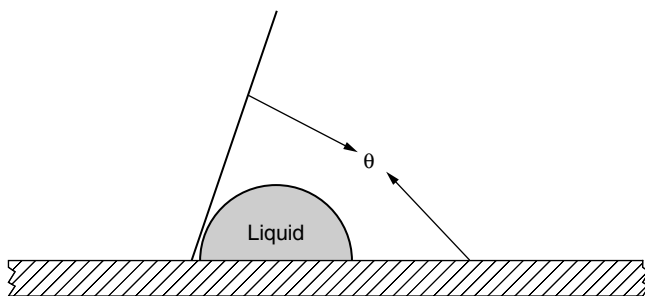
**FIGURE 1.4** Contact angle.

high viscosity materials. The intermolecular (solid–liquid) attraction is greater in this case. The surface energy of the solid is higher than the liquid's surface tension.

Measuring the contact angle is a simple technique for determining the relative difference between the two surface tensions. A high contact angle signifies a large departure, while a small angle suggests that the two values are close, but not equal.

TABLE 1.5 Surface Tension Test Kit

Surface Tension	Castor Oil	Toluene	Heptane	FC48/FC77
15 dynes/cm				0/100
17				100/100
19				100/0
22			100	
22.4	12.0	49.2	38.8	
24.5	55.2	25.0	19.8	
27	74.2	14.4	11.4	
30	0	100.0	0	
32.5	88.0	4.5	3.5	
35	100.0			
63	(100 glycerol)			
72.8	(100 water)			

Mixtures are in weight percent.

Source: Various sources and tests by author.

One can estimate liquid surface tension by applying drops of the liquid onto smooth surfaces of known values until a wetting just occurs, signifying that the two surface tensions are equal. Conversely, the surface energy of a solid may be estimated by applying drops of standard surface tension liquids until wetting is achieved. A surface tension kit can be made up from simple mixtures for testing surfaces. Table 1.5 provides formulas.

Low energy surfaces are difficult to wet and can give poor results for coating, painting, and printing. The standard surface tension kit may be used to estimate the surface energy of a plastic to be decorated. If the particular plastic shows a much lower value than that reported in Table 1.4, contamination is suspected. Mold release agents, unless specially made compatible for decorating materials, can greatly lower surface energy of a plastic part, making it uncoatable.

1.3.4 Surfactants

Agents that alter interfacial interactions are called surfactants. The surfactant possesses two different chemical groups, one compatible with the liquid to be modified, and the other having a lower surface tension. For example, the surface tension of an epoxy may be reduced by adding a surfactant with an alcohol group (epoxy-compatible) at one end and a fluorochemical group at the other. The alcohol group will associate with the epoxy resin, presenting the incompatible fluorochemical “tail” to the surface. The epoxy coating will behave as if it were a low surface tension fluorochemical. The addition of a small amount of surfactant will permit the epoxy coating to wet difficult, low energy surfaces, even oil-contaminated plastic.

Surfactants efficiently lower the surface tension of inks, coatings, and paints. Typically, 1% or less is sufficient. When dewetting occurs because of intrinsically low surface energy of the substrate, use of surfactants, also called wetting agents, is indicated. These materials are not a substitute for good house-keeping and proper parts preparation. Contamination can cause adhesion failure later.

Fluorochemicals, silicones, and hydrocarbons are common categories of surfactants. Fluorochemicals have the lowest surface tension of any material and are the most efficient wetting agents. Silicones are next in efficacy and are lower in cost. Certain types of silicone, however, can become airborne, causing contamination of the substrate.

Although it may be desirable to lower the surface tension of a coating, the opposite is true for the substrate. The very agent that helps the decorating material renders the substrate useless. Silicone contamination will produce the notorious dewetting defect called “fish-eyes.”

Coatings, paints, and inks, once modified with surfactants, are usually permanently changed, even after curing. Their low surface energy will make them difficult to wet over if, for example, it is necessary to apply a top coat. There are several options for overcoming this problem. The best practice is to use

the smallest amount of the least potent surfactant that will do the job. Start with the hydrocarbon class. Also make sure that the substrate is clean to begin with.

Another possibility is to use reactive surfactants. Agents possessing a functional group that can react with coating or binder are rendered less active after curing. Once the surfactant has completed the role of wetting agent, it is no longer needed. One other approach is to add surfactant to the second material to be applied. Often the same surfactant will work, especially at a slightly higher loading.

1.3.5 Leveling

Leveling depends on both rheology and surface chemistry. It is a more complex phenomenon and a more difficult one to control. Coatings applied by spraying, dipping, roll coating, and most other methods are often not smooth enough for aesthetic appeal. Splatters, runs, ridges, and other topological defects require that the liquid material level out. It is therefore important to understand the dynamics of leveling.

We will first assume that proper wetting has been achieved, by wetting agents if necessary. Important parameters affecting leveling are viscosity, surface tension, yield value, coating thickness, and the degree of wet coating irregularity. Several workers have developed empirical relationships to describe leveling. The leveling equation (Equation 1.4) is quite useful.⁶

$$a_t = a_0 \frac{\exp(\text{const } \sigma h^3 t)}{3\lambda^4 \eta} \quad (1.4)$$

where

- a_t = amplitude (height) of coating ridge
- σ = the surface tension of the coating
- η = coating viscosity
- h = coating thickness or height
- t = the time for leveling
- λ = wavelength or distance between ridges

Equation 1.4 shows that leveling is improved by one or more of the following:

1. Longer time (t)
2. Higher surface tension of coating (σ)
3. Lower viscosity (η)
4. Greater coating thickness (h)
5. Small repeating distance between ridges (λ)

Note that h , the coating thickness, is raised to the third power. Doubling the thickness provides an eightfold (2^3) improvement in leveling. Also note that λ , wavelength between ridges, is raised to the fourth power. This means that ridges that are very far apart create a very difficult leveling situation.

Earlier, it was pointed out that a high yield value could prevent leveling. The shear stress on a wet coating must be greater than the yield value for leveling to take place. Equation 1.5 shows the relationship between various parameters and shear stress.⁷

$$T_{\max} = \frac{4\pi^3 \sigma ah}{\lambda^3} \quad \text{or} \quad D(\text{coating ridge depth}) = \frac{\tau \lambda^3}{4\pi^3 \sigma h} \quad (1.5)$$

where

- σ = surface tension of coating
- a = amplitude of coating ridge
- h = coating height
- λ = coating ridge wavelength

Because Equation 1.5 deals with force, the time factor and the viscosity value drop out. It is seen that increasing surface tension and coating thickness produce the maximum shear stress. Coating defect height (a) increases shear, while wavelength (λ) strongly reduces it. If coating ridges cannot be avoided, higher, more closely packed ones are preferable.

When the yield value is higher than the maximum shear (T_{\max}), leveling will not occur. Extending leveling time and reducing viscosity will not help to overcome the yield value barrier, because these terms are not in the shear equation. Increasing surface tension and coating thickness are options, but there are practical limits.

As yield value is usually affected by shear (thixotropy), coating application rate and premixing conditions may be important. Higher roller speed (for roll coaters) and higher spray pressure (for spray guns) can drop the yield value temporarily. It should be apparent that best leveling is not achieved by lowest surface tension. Although good wetting may require a reduction in surface tension, higher surface tension promotes leveling. This is one more reason to use the minimum effective level of surfactant.

1.4 Summary

A comprehension of the basic principles that describe and predict liquid flow and interfacial interactions is important for the effective formulation and the efficient application of coatings and related materials. The theoretical tools for managing the technology of coatings are rheology, the science of flow and deformation, considered with surface chemistry, and the science of wetting and dewetting phenomena. Viewing such rheology properties as viscosity in terms of their time dependency adds the necessary dimension for practical application of theory to practice. Such important coating attributes as leveling are affected by both viscosity and surface tension. Knowing the interrelationships allows the coating specialist to make adjustments and take corrective actions with confidence.

References

1. *Handbook of Chemistry and Physics*, 64th ed. Boca Raton, FL: CRC Press, 1984.
2. Temple C. Patton, *Paint Flow and Pigment Dispersion*, 2nd ed. New York: Wiley, 1979.
3. Charles R. Martens, *Technology of Paint, Varnish and Lacquers*. New York: Krieger Pub. Co., 1974.
4. Dean, J., Ed., *Lange's Handbook of Chemistry*, 13th ed. New York: McGraw-Hill, 1985.
5. Norbert M. Bikales, *Adhesion and Bonding*. New York: Wiley-Interscience, 1971.
6. S. Orchard, *Appl. Sci. Res.*, A11, 451 (1962).
7. N. D. P. Smith, S. E. Orchard, and A. J. Rhind-Tutt, "The physics of brush marks," *JOCCA*, 44, 618–633, September (1961).

Bibliography

- Bikales, N. M., *Adhesion and Bonding*. New York: Wiley-Interscience, 1971.
- Martens, C. R., *Technology of Paint, Varnish and Lacquers*. New York: Krieger Pub. Co., 1974.
- Nylen, P. and S. Sunderland, *Modern Surface Coatings*. New York: Wiley, 1965.
- Patton, T. C., *Paint Flow and Pigment Dispersion*, 2nd ed. New York: Wiley-Interscience, 1979.

2

Coating Rheology

Chi-Ming Chan

Raychem Corporation

Subbu Venkatraman

Raychem Corporation

2.1	Introduction	2-1
2.2	Definitions and Measurement Techniques.....	2-1
	Surface Tension • Viscosity • Thixotropy • Dilatancy • Yield Stress • Elasticity	
2.3	Rheological Phenomena in Coating.....	2-5
	Wetting • Coalescence • Sagging and Slumping • Leveling • Viscosity Changes after Application • Edge and Corner Effects • Depressions: Bernard Cells and Craters	
	Acknowledgments.....	2-13
	References.....	2-13

2.1 Introduction

Depending on the nature of the starting material, coatings can be broadly classified into solvent-borne and powder coatings. The solvent-borne coatings include both solutions (high and low solid contents) and suspensions or dispersions. Methods of application and the markets for these coatings are listed in [Table 2.1](#).

2.2 Definitions and Measurement Techniques

2.2.1 Surface Tension

Surface tension is defined as the excess force per unit length at the surface; it is reckoned as positive if it acts in such a direction as to contract the surface.^{1,6} The tendency of a system to decrease its surface area is the result of the excess surface energy, because the surface atoms are subjected to a different environment as compared to those in the bulk. Surface tension of liquids and polymer melts can be measured by methods such as capillary tube,¹ Du Nuoy ring,^{2,7} Wilhelmy plate,^{3,8} and pendent drop.^{4,5} We shall focus our discussion on two methods: the capillary-height and pendant-drop methods.

The capillary-height method is the most suitable for low viscosity liquids because the system takes a long time to reach equilibrium for high viscosity liquids. It is reported that as many as 4 days are needed to attain equilibrium for a polystyrene melt at 200°C.⁵ [Figure 2.1](#) illustrates the capillary-height method. At equilibrium, the force exerted on the meniscus periphery due to the surface tension must be balanced by the weight of the liquid column. Neglecting the weight of the liquid above the meniscus, an approximate equation can be written as follows:

$$\Delta\rho gh = 2\gamma \frac{\cos\theta}{r} \quad (2.1)$$

where $\Delta\rho$ is the density difference between the liquid and air, g is the gravitational constant, h is the height of the liquid column, γ is the surface tension, θ is the contact angle, and r is the radius of the

TABLE 2.1 Application Methods and Markets for Solvent-Borne and Powder Coatings

Coating Type	Method of Application	Market
Solvent-borne	Brushing, rolling	Consumer paints
	Spraying	Automotive, industrial
	Spin-coating	Microelectronics
	Electrodeposition	Automotive, industrial
Powder	Electrostatic	Automotive, industrial

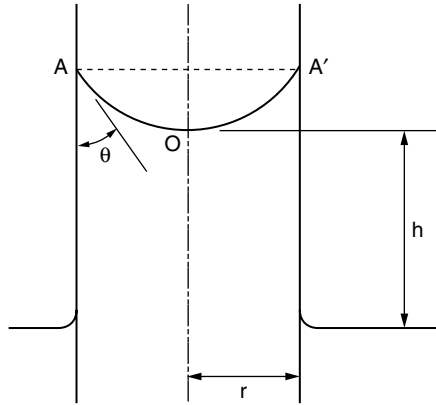

FIGURE 2.1 The capillary method.

capillary. In practice, it is difficult to measure accurately a vertical contact angle and a known and uniform radius. For a more accurate determination of the surface tension, various methods are available to calculate the weight of the liquid above the meniscus.

The pendant-drop method is a very versatile technique to measure the surface tension of liquids and also the interfacial tension between two liquids. Andreas et al.⁹ used this method to measure the surface tension of various organic liquids. Wu¹⁰ and Roe¹¹ have applied this method extensively to measure the surface and interfacial tensions of many polymer liquids and melts.

The experimental setup shown in Figure 2.2 consists of a light source, a pendant-drop cell, and a syringe assembly in a constant-temperature chamber, as well as a photomicrographic arrangement. A typical shape of a pendant drop is shown in Figure 2.3. The surface tension of the liquid is given by⁹

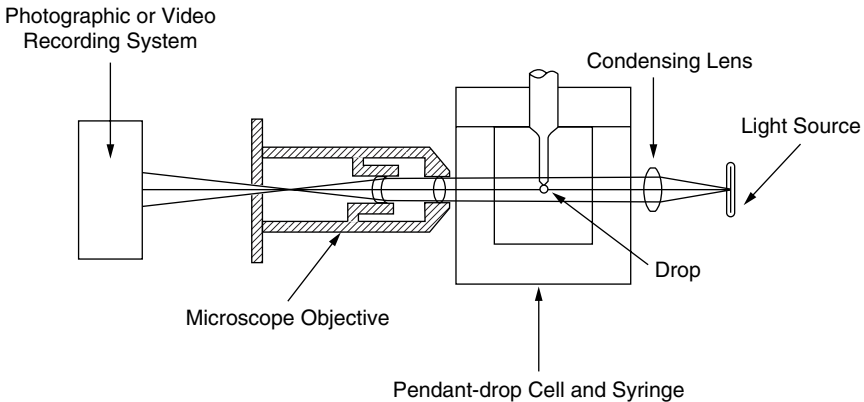

FIGURE 2.2 Experimental setup for the pendant-drop method.

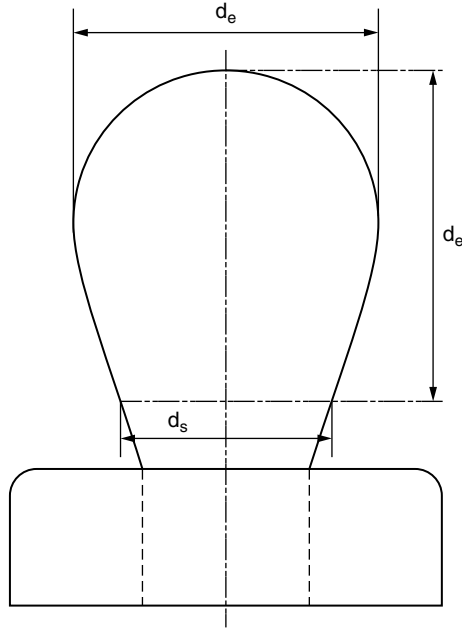

FIGURE 2.3 Typical pendant-drop profile.

$$\gamma = \Delta\rho g \frac{d_e}{H} \quad (2.2)$$

where d_e is the maximum (equatorial) diameter of the pendant drop, and H is a correction factor that depends on the shape of the drop; H is related to a measurable shape-dependent factor S , which is defined by

$$S = \frac{d_s}{d_e} \quad (2.3)$$

where d_s is the diameter of the pendant drop in a selected plane at a distance d_e from the apex of the drop (see Figure 2.3). Tables showing the values of $1/H$ as a function of S are available.^{12–14}

Recently there have been a number of significant improvements in both data acquisition and analysis of the pendant-drop profiles.^{15–17} The photographic recording and measurement of the pendant drop are replaced by direct digitization of a video image. The ability to measure the entire drop profile has led to the development of new algorithms for the drop-profile analysis.^{16,17}

2.2.2 Viscosity

The shear viscosity is defined as the ratio of the shear to the shear strain rate, at the strain rate of interest. Although the viscosity is usually quoted as a number without reference to the strain rate, it is really a function of strain rate. The strain rate dependence and, in certain situations, the time dependence, of the viscosity need to be determined if a meaningful correlation is to be made with coating phenomena. In the case of coatings, the shear strain rate range of interest extends from about a few thousand reciprocal seconds (during spraying, for instance) down to a hundredth of a reciprocal second (following application).

A variety of techniques is available to measure viscosity of coating formulations. Some of them are listed in Table 2.2.¹⁸ Instruments with a single or undefined strain rate should be avoided in the study

TABLE 2.2 Some Commercially Available Rheological Instrumentation

Name of Instrument	Geometries Available	Shear-Rate Range	Modes Available
Weissenberg Rheogoniometer	Couette, cone and plate, parallel plate	Broad	Steady shear, oscillatory
Rheometrics Mechanical Spectrometer	Couette, plate and cone, parallel plate	Broad	Steady shear, oscillatory
Carri-Med Controlled Stress Rheometer (CSR)	Couette, parallel plate	Fixed stress	Creep and recovery, oscillatory
Rheo-Tech Viscoelastic Rheometer (VER)	Cone and plate	Fixed stress	Oscillatory, creep and recovery
Contraves Rheomat 115	Cone and plate, couette	Broad	Steady shear
Rheometrics Stress Rheometer	Cone and plate	Fixed stress	Oscillatory, creep and recovery
Haake Rotovisco	Couette, cone and plate	Broad	Steady state
Shirley-Ferranti	Cone and plate	Broad	Steady shear
ICI Rotothinner	Couette	Single high rate	Steady shear
Brookfield Cone and Plate	Cone and plate	Medium to high	Steady
Brookfield Spindle	Undefined	Undefined	Steady shear
Gardner-Holdt	Rising bubble	Undefined	
Cannon-Ubbelohde	Poiseuille	Limited range, high end	Shear
Brushometer	Couette	High end only, single	Steady shear

of coating rheology. If meaningful correlations are to be made with coating phenomena, the viscosity must be measured over a wide range of strain rates.

The most acceptable technique for determining the strain-rate dependence of the viscosity is the use of the constant rate-of-strain experiment in torsion. This can be done in either a cone-and-plate (for low rates) or a concentric cylinder geometry (for higher rates). However, the oscillatory, or dynamic measurement, is also commonly employed for the same purpose. It is assumed that the shear strain rate and the frequency are equivalent quantities, and the complex viscosity is equal to the steady state constant rate viscosity (i.e., the Cox–Merz rule is valid). The applicability of the Cox–Merz rule, however, is by no means universal, and its validity must be demonstrated before the dynamic measurements can be substituted for the steady-state ones. The capillary technique, as employed in several commercial instruments, is not suitable for coating studies in general, because it is more suitable for measuring viscosity at higher strain rates.

2.2.3 Thixotropy

Thixotropy is a much abused term in the coatings industry. In the review, we shall define the phenomenon of thixotropy as the particular case of the time dependence of the viscosity, that is, its decrease during a constant rate-of-strain experiment. This time dependence manifests itself in hysteresis in experiments involving increasing and decreasing rates of strain. The area under the hysteresis loop has been used as a quantitative estimate of thixotropy, although its validity is still a matter of debate.^{18,19} Another attempt at quantifying thixotropy²⁰ involves the measurement of a peak stress (σ_p) and a stress at a long time (σ^∞) in a constant rate-of-strain experiment. In this instance, the thixotropy index β is defined as follows:

$$\beta = \sigma_p - \sigma \frac{\infty}{\sigma_p} \quad (2.4)$$

The utility of these different definitions is still unclear, and their correlation to coating phenomena is even less certain.

In a purely phenomenological sense, thixotropy can be studied by monitoring the time-dependence of the viscosity, at constant rates of strain. Quantification of the property is, however, rather arbitrary. The coefficient of thixotropy, β , appears to be the most reasonable, and is measurable in torsional

rheometers such as those mentioned in Table 2.2. It should be noted that this index, as defined above, increases with increase in the rate of strain. In addition, the thixotropic behavior is influenced considerably by the shear history of the material. In comparative measurements, care should be taken to ensure a similar or identical history for all samples. The phenomenon of thixotropy is also responsible for the increase in viscosity after the cessation of shear. If after a constant rate-of-strain experiment, the material viscosity is monitored using a sinusoidal technique, it will be found to increase to a value characteristic of a low shear rate-of-strain measurement.

2.2.4 Dilatancy

The original definition of dilatancy,²¹ an increase in viscosity with increasing rate of strain, is still the most widely accepted one today.²²⁻²⁴ The term has been used, however, to mean the opposite of thixotropy.²⁵ The constant rate-of-strain experiment, outlined above for viscosity measurements, can obviously be employed to determine shear thickening, or dilatancy

2.2.5 Yield Stress

In the case of fluids, the yield stress is defined as the minimum shear stress required to initiate flow. It is also commonly referred to as the “Bingham stress,” and a material that exhibits a yield stress is commonly known as a “Bingham plastic” or viscoplastic.²⁶ Though easily defined, this quantity is not as easily measured. Its importance in coating phenomena is, however, quite widely accepted.

The most direct method of measuring this stress is by creep experiments in shear. This can be accomplished in the so-called stress-controlled rheometers (see Table 2.2). The minimum stress that can be imposed on a sample varies with the type of instrument, but by the judicious use of geometry, stress (in shear) in the range of 1 to 5 dynes/cm² can be applied. This is the range of yield stresses exhibited by most paints with a low level of solids. However, the detection of flow is not straightforward. In the conventional sense, the measured strain in the sample must attain linearity in time when permanent flow occurs. This may necessitate the measurement over a long period of time.

An estimate of the yield stress may be obtained from constant rate-of-strain measurements of stress and viscosity. When the viscosity is plotted against stress, its magnitude appears to approach infinity at low stresses. The asymptote on the stress axis gives an estimate of the yield stress.

Another method used is the stress relaxation measurement after the imposition of a step strain. For materials exhibiting viscoplasticity, the stress decays to a nonzero value that is taken as the estimate of the yield stress.

2.2.6 Elasticity

Elasticity of coating materials is frequently mentioned in the literature^{18,19} as being very important in determining the coating quality, particularly of leveling. However, most of the reported measurements of elasticity are indirect, either through the first normal stress difference or through the stress relaxation measurement. Correlations are shown to exist, in paints, between high values of the first normal stress difference and the leveling ability.¹⁸ However, no satisfactory rationalization has been put forward for a cause-and-effect relationship. Also, direct measurement of the elasticity of a coating through the creep-and-recovery experiment is virtually nonexistent. We shall not discuss the role of elasticity in this chapter.

2.3 Rheological Phenomena in Coating

Coalescence, wetting, leveling, cratering, sagging, and slumping are the processes that are strongly influenced by surface tension and viscoelasticity. These, in turn, are the two important parameters that control the quality and appearance of coatings, and hence, their effects on the coating process are discussed in detail.

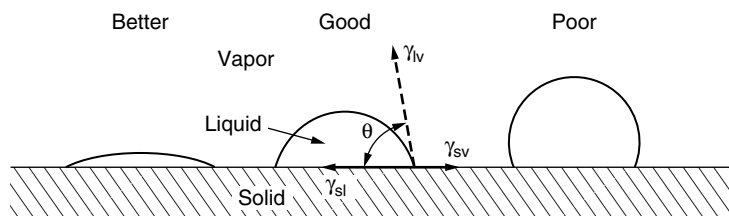

FIGURE 2.4 Schematic illustration of good and poor wetting.

2.3.1 Wetting

Surface tension is an important factor that determines the ability of a coating to wet and adhere to a substrate. The ability of a paint to wet a substrate has been shown to be improved by using solvents with lower surface tensions.²⁷ Wetting may be quantitatively defined by reference to a liquid drop resting in equilibrium on a solid surface (Figure 2.4). The smaller the contact angle, the better the wetting. When θ is greater than zero, the liquid wets the solid completely over the surface at a rate depending on a liquid viscosity and the solid surface roughness. The equilibrium contact angle for a liquid drop sitting on an ideally smooth, homogeneous, flat, and nondeformable surface is related to various interfacial tensions by Young's equation:

$$\gamma_{lv} \cos \theta = \gamma_{sv} - \gamma_{sl} \quad (2.5)$$

where γ_{lv} is the surface tension of the liquid in equilibrium with its own saturated vapor, γ_{sv} is the surface tension of the solid in equilibrium with the saturated vapor of the liquid, and γ_{sl} is the interfacial tension between the solid and liquid. When θ is zero and assuming γ_{sv} to be approximately equal to γ_s (which is usually a reasonable approximation), then from Equation 2.5, it can be concluded that for spontaneous wetting to occur, the surface tension of the liquid must be greater than the surface tension of the solid. It is also possible for the liquid to spread and wet a solid surface when θ is greater than zero, but this requires the application of a force to the liquid.

2.3.2 Coalescence

Coalescence is the fusing of molten particles to form a continuous film. It is the first step in powder coating. The factors that control coalescence are surface tension, radius of curvature, and viscosity of the molten powder. Figure 2.5 shows a schematic diagram of the coalescence of molten powder. Nix and Dodge²⁸ related the time of coalescence to those factors by the equation,

$$t_c = f \left(\eta \frac{R_c}{\gamma} \right) \quad (2.6)$$

where t_c is the coalescence time and R_c is the radius of the curvature (the mean particle radius). To minimize the coalescence time such that more time is available for the leveling-out stage, low viscosity, small particles, and low surface tension are desirable.

2.3.3 Sagging and Slumping

Sagging and slumping are phenomena that occur in coatings applied to inclined surfaces, in particular, to vertical surfaces. Under the influence of gravity, downward flow occurs and leads to sagging or slumping, depending on the nature of the coating fluid. In the case of purely Newtonian or shear thinning fluids, sagging (shear flow) occurs; Figure 2.6 represents "gravity-induced" flow on a vertical surface. On the other hand, a material with a yield stress exhibits slumping (plug flow and shear flow).

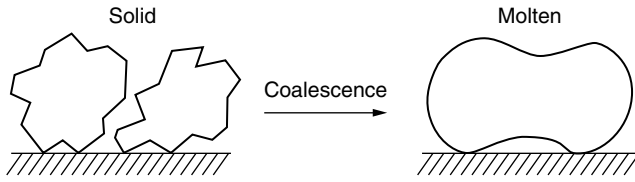

FIGURE 2.5 Schematization of the coalescence of molten powders.

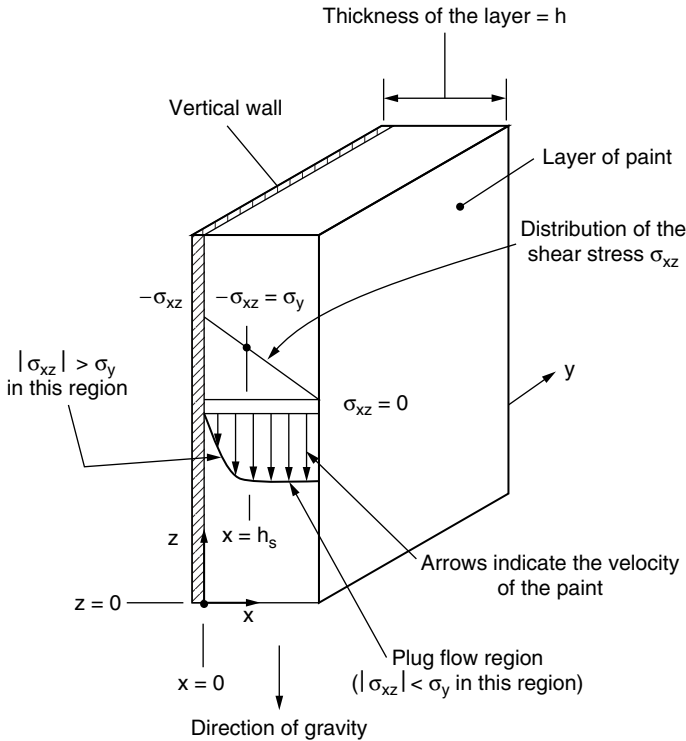

FIGURE 2.6 Gravity-induced flow on a vertical surface.

For the case of Newtonian fluids, the physics of the phenomenon has been treated.^{29,30} The extension to other types of fluid, including shear thinning and viscoplastic fluids, has been done as well.³¹ The treatment that follows is based largely on these three sources (i.e., Refs. 29–31). The parameters of interest in the analysis are the velocity V_0 of the material in flow at the fluid–air interface and the resulting sag or slump length, S . For the general case of a power-law fluid of index n ,³¹ these above quantities can be calculated:

$$V_0 = \left(\rho \frac{g}{\eta_0} \right)^{(1/n)} \frac{n}{n+1} h^{(n+1)/n} \tag{2.7}$$

and

$$S = V_0 t \tag{2.8}$$

where η_0 is the zero-shear viscosity and h is the film thickness. The special case of Newtonian fluids is obtained by putting $n = 1$ in Equation 2.8. The final sag or slump length S is determined by the velocity

as well as a time factor t , which is really a time interval for which the material remains fluid (or the time the material takes to solidify). The velocity v_0 depends inversely on the zero-shear viscosity. When all other things are equal, a shear thinning fluid ($n < 1$) will exhibit lower sag and slump velocities. In general, therefore, a Newtonian or a shear-thinning fluid will sag or slump under its own weight until its viscosity increased to the point at which V_0 is negligible. However, sagging might not occur at all, provided certain conditions are met. One of these is the existence of the yield stress. No sagging occurs if the yield stress (σ_y) is larger than the force due to gravity, ρgh . However, if the coating is thick enough (large h), this condition may no longer be satisfied, and both sagging and slumping can occur if the film thickness is larger than h_s , which is given by

$$h_s = \frac{\sigma_y}{\rho g} \quad (2.9)$$

Between $h = 0$ and $h = h_s$, sagging occurs. The velocity can be obtained by substituting $(h - h_s)$ for h in Equation 2.7:

$$V_0 = \left(\frac{\rho g}{\eta_0} \right)^{1/n} \frac{n}{n+1} (h - h_s)^{(n+1)/n} \quad (2.10)$$

For $h > h_s$, plug flow occurs (see Figure 2.6).

Wu³¹ also found that the tendency to sag, in general, increases in the order: shear-thinning fluids < viscoplastic fluids < Newtonian fluids < shear-thickening fluids, provided that all these materials have the same zero-shear viscosity, η_0 . The significance of η_0 for viscoplastic fluids is unclear, although it is used in the equations derived by Wu.³¹

For the particular case of sprayable coatings, Wu found that a shear thinning fluid with $n = 0.6$, without a yield stress, can exhibit good sag control while retaining adequate sprayability.

2.3.4 Leveling

Leveling is the critical step to achieve a smooth and uniform coating. During the application of coatings, imperfections such as waves or furrows usually appear on the surface. For the coating to be acceptable, these imperfections must disappear before the wet coating (fluid) solidifies.

Surface tension has been generally recognized as the major driving force for the flow-out in coating, and the resistance to flow is the viscosity of the coating. The result of leveling is the reduction of the surface tension of the film. Figure 2.7 illustrates the leveling out of a newly formed sinusoidal surface of a continuous fused film. For a thin film with an idealized sinusoidal surface, as shown in Figure 2.7, an equation that relates leveling speed t_v with viscosity and surface tension was given by Rhodes and Orchard³²:

$$t_v = \frac{16\pi^4 h^3 \gamma}{3\gamma^3 \eta} \ln \left(\frac{a_t}{a_0} \right) \quad (2.11)$$

where a_t and a_0 are the final and initial amplitudes, γ is the wavelength, and h is the averaged thickness of the film. This equation is valid only when γ is greater than h . From Equation 2.11 it is clear that leveling is favored by large film thickness, small wavelength, high surface tension, and low melt viscosity.

However, the question of the relevant viscosity to be used in Equation 2.11 is not quite settled. Lin¹⁸ suggests computing the stress generated by surface tension with one of several available methods.^{33,34} Then, from a predetermined flow curve, obtain the viscosity at that shear stress; this may necessitate the measurement of viscosity at a very low strain rate. On the other hand, Wu proposed³¹ using the zero-

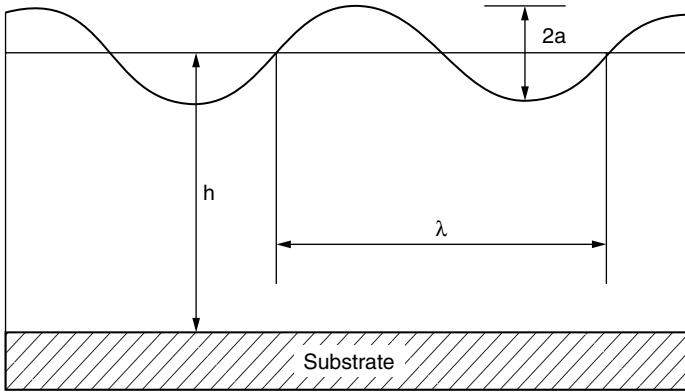

FIGURE 2.7 An ideal sinusoidal surface.

shear value for the viscosity in Equation 2.11. These two approaches will yield similar results, except when the material is highly sensitive to strain rate ($n < 1$).

When the material possesses a yield stress, the surface tension force must overcome the yield stress to initiate the flow or leveling. Thus, we replace λ in Equation 2.11 by λ' :

$$\gamma' = \gamma - \frac{\sigma_y \lambda}{8\pi^3 a_1 h} \quad (2.12)$$

This equation implies that a coating fluid with low yield stress should level out quickly. This requirement for leveling is in conflict with that for low sag or slump (high yield stress). Wu³⁵ claims that a shear thinning fluid of index 0.6 exhibits the lowest sag, provided the viscosity is 50 poise at 1 reciprocal second. Because such a fluid does not have a yield stress, it should level out well. This kind of rheological behavior may be attainable in an oligomeric powder coating at temperatures close to its melting point, or in a solution coating with a high solid content. It is difficult to see how this behavior could be realized in all situations, in particular for latex dispersions that possess yield stresses.

2.3.5 Viscosity Changes after Application

After a wet or fluid coating has been applied to a substrate, its viscosity starts to increase. This increase is due to several factors; some of the more important ones are depicted in Figure 2.8. The magnitudes of the viscosity increases due to the different factors shown in Figure 2.8 are typical of a solution coating with a low solid content. The relative magnitudes will, of course, differ for solution coatings with a high solid level, as well as for powder coatings. In powder coatings, the principal increase will be due to leveling, as the temperature approaches the melting point.

The measurement of the viscosity increase is important, because it gives us an idea of how much time is available for the various phenomena to occur before solidification. The leveling and sagging phenomena discussed above can occur only as long as the material remains fluid; as the viscosity increases, these processes become less and less significant because of the decrease in the sagging velocity and leveling speed in accordance with Equations 2.7 and 2.11. In fact, using the measured time dependence of the viscosity, one can estimate the time t (time taken to solidify) to be used in Equation 2.8, as well as the time of leveling, in Equation 2.11. In general, if the viscosity is higher than approximately 100,000 P, then leveling and sagging phenomena occur to a negligible extent.

Experimentally, one can monitor the viscosity increase using an oscillatory technique (see Section 2.2.2). This method is preferred, because measurements can be made under the condition of low shear amplitude, which approximates the condition after a coating application. Also, the solidification point can be estimated from the measurement of the elastic modulus. To mimic the condition immediately

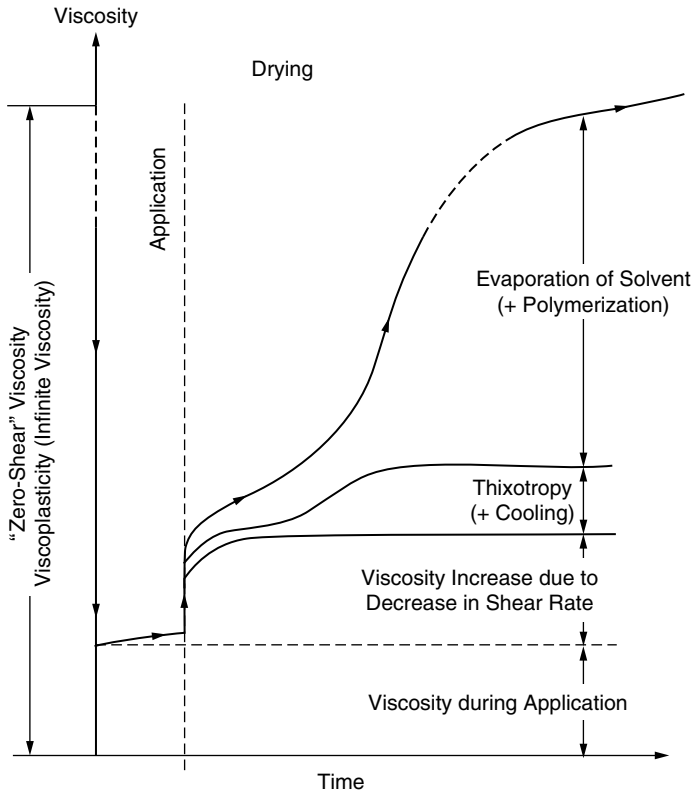

FIGURE 2.8 Schematic plot of coating viscosity during application and film formation.

after coating, the oscillatory measurement should be preceded by shearing at a fairly high rate, corresponding to the method of application.³⁶ In such an experiment, the average amplitude of the torque/stress wave increases with time after the cessation of a ramp shear. Although it is not easy to compute the viscosity change from the amplitude change, estimating is possible.³⁷ Alternatively, one can use just the amplitude of the stress for correlation purposes. Dodge³⁶ finds a correlation between the viscosity level after application and the extent of leveling as quantified by a special technique he developed. Another method that has been used³⁸ involves rolling a sphere down a coating applied to an inclined surface. The speed of the sphere can be taken as an indicator of the viscosity, after suitable calibration with Newtonian fluids. This method can be very misleading, because the flow is not viscometric, and it is not applicable to non-Newtonian fluids. A more acceptable technique is to use a simple shear, with a plate being drawn at constant velocity over a horizontal coating.¹⁹

2.3.6 Edge and Corner Effects

When a film is applied around a corner, surface tension, which tends to minimize the surface area of the film, may cause a decrease or increase in the film thickness at the corners as shown in Figure 2.9b and Figure 2.9d, respectively. In the case of edges of coated objects, an increase in the thickness has been observed. This phenomenon is related to surface tension variation with the solvent concentration.⁴⁰ In a newly formed film, a decrease in film thickness at the edge is caused by the surface tension of the film. Consequently, the solvent evaporation is much faster at the edge of the film, because there is a larger surface area per unit volume of fluid near the edge (Figure 2.10a). As more solvent (which usually has a lower surface tension than the polymer) evaporates, a higher surface tension exists at the edge, hence causing a material transport toward the edge from regions 2 to 1 (Figure 2.10b). The newly formed surface in region 2 will have a lower surface tension due to the exposure of the underlying material,

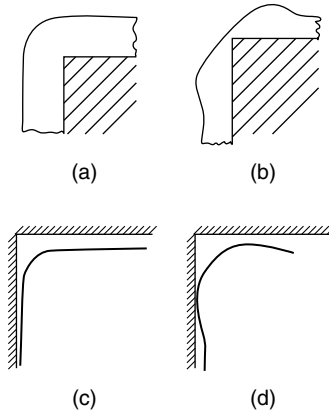

FIGURE 2.9 (a) Newly applied thick film at a corner. (b) Decrease in the film thickness at the corner due to surface tension. (c) Newly applied thin film at a corner. (d) Increase in the film thickness at the corner due to surface tension.

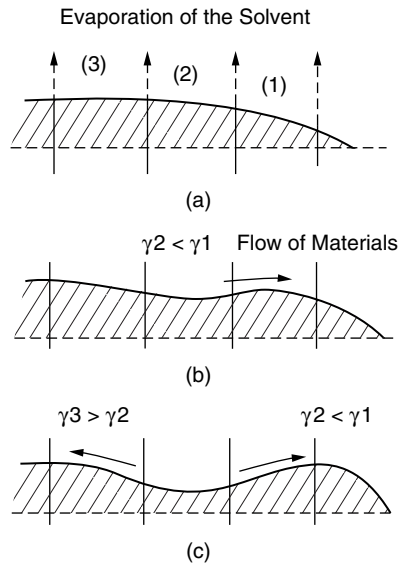

FIGURE 2.10 (a) Newly formed film near an edge. (b) Flow of materials from regions 2 to 1. (c) Further flow of materials from region 2 to the surroundings.

which has a higher solvent concentration. Consequently, more materials are transported from region 2 to the surrounding areas (regions 1 and 3) because of the surface tension gradient across the regions (Figure 2.10c).

2.3.7 Depressions: Bernard Cells and Craters

Local distortions (depressions) in a coating can be caused by a surface tension gradient (due to composition variation or temperature variation). This phenomenon is known as the Maragoni effect.⁴¹ The flow of a liquid from a region of lower to higher surface tension caused by the surface tension gradient results in the formation of depressions on the liquid surface. Such depressions come in two types: Bernard cells and craters.

Bernard cells usually appear as hexagonal cells with raised edges and depressed centers.^{42–44} The increase in the polymer concentration and the cooling due to solvent evaporation cause the surface tension and surface density to exceed those of the bulk. This creates an unstable configuration, which tends to move

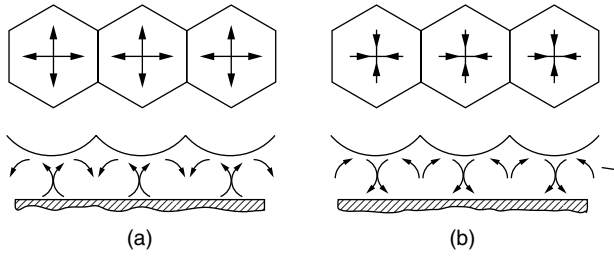

FIGURE 2.11 Schematic illustration of the formation of the Bernard cells due to (a) the surface tension gradient and (b) the density gradient.

into a more stable one in which the material at the surface has a lower surface tension and density. Theoretical analysis⁴⁵ has established two characteristic numbers: the Raleigh number R_a and the Marangoni number M_a , given by

$$R_a = \frac{\rho g \alpha \tau h^4}{K \eta} \quad (2.13)$$

$$M_a = \frac{\tau h^2 (-d\gamma / dT)}{K \eta} \quad (2.14)$$

where ρ is the liquid density, g is the gravitational constant, α is the thermal expansion coefficient, τ is the temperature gradient on the liquid surface, h is the film thickness, K is the thermal diffusivity, and T is the temperature. If the critical Marangoni number is exceeded, the cellular convective flow is formed by the surface tension gradient. As shown in Figure 2.11a, the flow is upward and downward beneath the center depression and the raised edge, respectively. But if the critical Raleigh number is exceeded, the cellular convective flow, which is caused by density gradient, is downward and upward beneath the depression and the raised edge, respectively (Figure 2.11b). In general, the density-gradient-driven flow predominates in thicker liquid layers (>4 mm), while the surface tension gradient is the controlling force for thinner films.

Cratering is similar to the Bernard cell formation in many ways. Craters, which are circular depressions on a liquid surface, can be caused by the presence of a low surface tension component at the film surface. The spreading of this low surface tension component causes the bulk transfer of film materials, resulting in the formation of a crater. The flow q of material during crater formation is given by⁴⁶

$$q = \frac{h^2 \Delta\gamma}{2\eta} \quad (2.15)$$

where $\Delta\gamma$ is the surface tension difference between the regions of high and low surface tension. The crater depth d_c is given by⁴⁷

$$d_c = \frac{3\Delta\gamma}{\rho g h} \quad (2.16)$$

The relationship between the cratering tendency and the concentration of surfactant was investigated by Satoh and Takano.⁴⁸ Their results indicate that craters appear whenever paints contain silicon oils (a surfactant) in an amount exceeding their solubility limits.

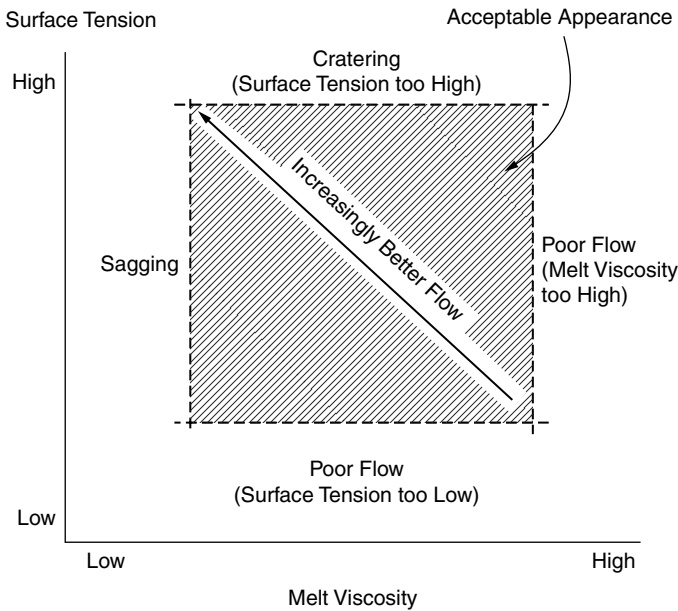

FIGURE 2.12 The effects of surface tension and melt viscosity on coating appearance.

In the discussion above, high surface tension and low viscosity are required for good flow-out and leveling. But high surface tension can cause cratering, and excessively low viscosity would result in sagging and poor edge coverage. To obtain an optimal coating, the balance between surface tension and viscosity is important. Figure 2.12 illustrates coating performance as a function of surface tension and melt viscosity. Coating is a fairly complex process; achieving an optimal result calls for the consideration of many factors.

Acknowledgments

We are grateful to Steve Trigwell for preparing the figures.

References

1. A. W. Adamson, *Physical Chemistry of Surfaces*, 4th ed. New York: Wiley, 1982.
2. L. Du Nouy, *J. Gen. Physiol.*, *1*, 521 (1919).
3. R. H. Dettre and R. E. Johnson, Jr., *J. Colloid Interface Sci.*, *21*, 367 (1966).
4. D. S. Ambwani and T. Fort, Jr., *Surface Colloid Sci.*, *11*, 93 (1979).
5. J. R. J. Harford and E. F. T. White, *Plast. Polym.*, *37*, 53 (1969).
6. J. Twin, *Phil. Trans.*, 29–30, 739 (1718).
7. J. W. Strutt (Lord Rayleigh), *Proc. R. Soc. London*, *A92*, 184 (1915).
8. S. Sugden, *J. Chem. Soc.*, 1483 (1921).
9. J. M. Andreas, E. A. Hauser, and W. B. Tucker, *J. Phys. Chem.*, *42*, 1001 (1938).
10. S. Wu, *J. Polym. Sci.*, *C34*, 19 (1971).
11. R. J. Roe, *J. Colloid Interface Sci.*, *31*, 228 (1969).
12. S. Fordham, *Prac. R. Soc. London.*, *A194*, 1 (1948).
13. C. E. Stauffer, *J. Phys. Chem.*, *69*, 1933 (1965).
14. J. F. Padday and A. R. Pitt, *Phil. Trans. R. Soc. London*, *A275*, 489 (1973).
15. H. H. Girault, D. J. Schiffrin, and B. D. V. Smith, *J. Colloid Interface Sci.*, *101*, 257 (1984).
16. C. Huh and R. L. Reed, *J. Colloid Interface Sci.*, *91*, 472 (1983).

17. Y. Rotenberg, L. Boruvka, and A. W. Neumann, *J. Colloid Interface Sci.*, **93**, 169 (1983).
18. O. C. Lin, *Chemtech*, January 1975, p. 15.
19. L. Kornum, *Rheol. Acta.*, **18**, 178 (1979).
20. O. C. Lin, *J. Appl. Polym. Sci.*, **19**, 199 (1975).
21. H. Freundlich and A. D. Jones, *J. Phys. Chem.*, **4**(40), 1217 (1936).
22. W. H. Bauer and E. A. Collins, in *Rheology*, Vol. 4, F. Eirich, Ed. New York: Academic Press, 1967, Chapter 8.
23. P. S. Roller, *J. Phys. Chem.*, **43**, 457 (1939).
24. S. Reiner and G. W. Scott Blair, in *Rheology*, Vol. 4, F. Eirich, Ed. New York: Academic Press, 1967, Chapter 9.
25. S. LeSota, *Paint Varnish. Prod.*, **47**, 60 (1957).
26. R. B. Bird, R. C. Armstrong, and O. Hassager, *Dynamics of Polymeric Fluids*, Vol. 1. New York: Wiley-Interscience, 1987, p. 61.
27. S. J. Storfer, J. T. DiPiazza, and R. E. Moran, *J. Coating Technol.*, **60**, 37 (1988).
28. V. G. Nix and J. S. Dodge, *J. Paint Technol.*, **45**, 59 (1973).
29. T. C. Patton, *Paint Flow and Pigment Dispersion*, 2nd ed. New York: Wiley-Interscience, 1979.
30. A. G. Frederickson, *Principles and Applications of Rheology*. Englewood Cliffs, NJ: Prentice Hall, 1964.
31. S. Wu, *J. Appl. Polym. Sci.*, **22**, 2769 (1978).
32. J. F. Rhodes and S. E. Orchard, *J. Appl. Sci. Res. A*, **11**, 451 (1962).
33. R. K. Waring, *Rheology*, **2**, 307 (1931).
34. N. O. P. Smith, S. E. Orchard, and A. J. Rhind-Tutt, *J. Oil Colour. Chem. Assoc.*, **44**, 618 (1961).
35. S. Wu, *J. Appl. Polym. Sci.*, **22**, 2783 (1978).
36. J. S. Dodge, *J. Paint Technol.*, **44**, 72 (1972).
37. K. Walters and R. K. Kemp, in *Polymer Systems: Deformation and Flow*. R. E. Wetton and R. W. Wharlow, Eds. New York: Macmillan, 1967, p. 237.
38. A. Quach and C. M. Hansen, *J. Paint Technol.*, **46**, 592 (1974).
39. L. O. Kornum and H. K. Raaschou Nielsen, *Progr. Org. Coatings*, **8**, 275 (1980).
40. L. Weh, *Plaste Kautsch.*, **20**, 138 (1973).
41. C. G. M. Marangoni, *Nuovo Cimento*, **2**, 239 (1971).
42. C. M. Hansen and P. E. Pierce, *Ind. Eng. Chem. Prod. Res. Dev.*, **12**, 67 (1973).
43. C. M. Hansen and Pierce, *Ind. Eng. Chem. Prod. Res. Dev.*, **13**, 218 (1974).
44. J. N. Anand and H. J. Karma, *J. Colloid Interface Sci.*, **31**, 208 (1969).
45. J. R. A. Pearson, *J. Fluid Mech.*, **4**, 489 (1958).
46. P. Fink-Jensen, *Farbe Lack*, **68**, 155 (1962).
47. A. V. Hersey, *Phys. Ser.*, **2**, 56, 204 (1939).
48. T. Satoh and N. Takano, *Colour Mater.*, **47**, 402 (1974).

3

Leveling

3.1	Introduction	3-1
3.2	Yield Value	3-1
3.3	Leveling and Viscosity.....	3-2
	Thixotropy	
3.4	Leveling and Surface Tension	3-3
3.5	Leveling of Brush and Striation Marks	3-4
	References	3-4
	Bibliography	3-4

D. Satas*

Satas & Associates

3.1 Introduction

A coating is applied to a surface by a mechanical force: by a stroke of a brush, by transfer from a roll, by removing the excess with a knife's edge, or by other means. Most of these coating processes leave surface disturbances: a brush leaves brush marks; a reverse roll coater leaves longitudinal striations; knife coating leaves machine direction streak; roll coating leaves a rough surface, when the coating splits between the roll and the substrate; and spraying may produce a surface resembling orange peel.

3.2 Yield Value

These surface disturbances may disappear before the coating is dried, or they may remain, depending on the coating properties and time elapsed between the coating application and its solidification. The surface leveling process is driven by surface tension and resisted by viscosity. Some coatings, especially thickened aqueous emulsions, may exhibit pseudoplastic flow characteristics and may have a yield value: minimum force required to cause the coating to flow (see [Figure 3.1](#)). For such coating to level, the driving force (surface tension) must be higher than the yield value. Solution coatings are usually Newtonian (have no yield value) and level rather well. Hot melt coatings solidify fast and may not level adequately. Some typical yield values for various coatings are given in [Table 3.1](#).

Viscosity measurements at very low shear rates are required to determine the yield value. Some of the shear rates experienced in various processes are shown in [Table 3.2](#). A Brookfield viscometer, which operates at shear rates of 0.6 to 24 sec⁻¹, is not suitable for investigating the leveling effects that appear at much lower shear rates. Shear rates experienced during various coating processes are very high, and the viscosity measurements at low shear rates might not disclose coating behavior at these high shear rates.

A yield value of 0.5 dynes/cm² produces very fine brush marks, while a yield value of 20 dynes/cm² produces pronounced brush marks. The yield stress necessary to suppress sagging is estimated at 5 dynes/

* Deceased.

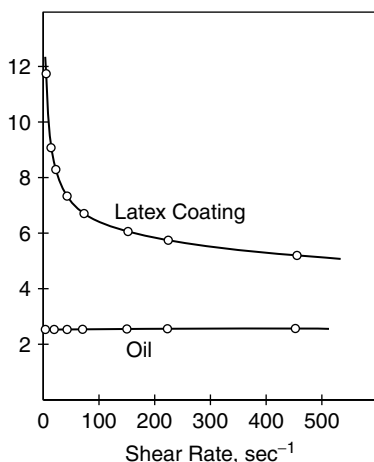

FIGURE 3.1 Viscosity of pseudoplastic emulsion coating as a function of shear rate compared to Newtonian oil.

TABLE 3.1 Yield Values and Thixotropy Ratings for Various Coatings

Coating Type	Yield Value (dynes/cm ²)	Thixotropy Rating
Enamels, glossy	0–30	None to slight
Enamels, semiglossy	50–120	Slight
Flat paints	20–100	Slight to marked
Aqueous wall coatings	10–100	Slight to marked
Metal primers	0–100	None to marked
Varnishes	0	None

TABLE 3.2 Shear Rates for Various Processes

Process	Shear Rate (sec ⁻¹)
Leveling	0.01–0.10
Pouring if solution	10–100
Mixing	50–1,000
Reverse roll coating	100–10,000
Knife over roll coating	1,000–10,000
Brushing	10,000–50,000
Spraying	10,000–70,000

cm², which is not compatible with the best leveling properties. Therefore, to produce both adequate leveling and nonsagging behavior, thixotropic properties must be introduced to a coating.

3.3 Leveling and Viscosity

The driving force of the leveling process is surface tension. The force that resists leveling is viscosity and, to a lesser degree, the elasticity of a coating. To facilitate leveling, therefore, it is desirable to employ coating of low viscosity. Low viscosity coatings, however, cannot always be used. It is difficult to deposit heavy coatings if the viscosity is low. If the coating is applied on a vertical surface, a high viscosity is needed to prevent sagging.

Aqueous coatings are often pseudoplastic: they exhibit a rate-dependent viscosity. They may have a low viscosity (20 to 30 mPa·sec) at high shear rates (10⁴ sec⁻¹), such as experienced in roll coating

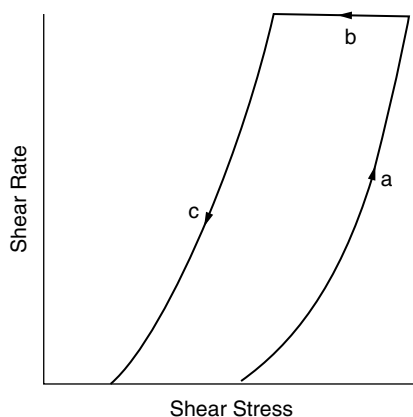

FIGURE 3.2 Thixotropic loop.

operations, and a much higher viscosity (1 to 3 pa·sec) at low shear rates (0.01 to 10 sec⁻¹), prevalent during leveling. Such coatings do not level well because of the high viscosity at low shear rates.

The rheology index is sometimes used as an indicator of the leveling capabilities of a coating. The rheology index is defined as the ratio of high shear rate viscosity to low shear rate viscosity. If the rheology index is one, the coating is Newtonian; if it is larger than one, the coating is dilatant; if it is smaller than one, the coating is pseudoplastic. A large rheology index favors good leveling; it should exceed 0.25 for aqueous systems of acceptable leveling properties.

3.3.1 Thixotropy

Thixotropic behavior of some coatings is utilized to circumvent the dilemma of having a coating of sufficiently low viscosity that levels well and a coating of sufficiently high viscosity that does not sag. Thixotropy is the dependence of viscosity on time. There are coatings that retain a low viscosity for a short period after shearing, thus allowing good leveling, but that thicken fast enough to prevent sagging.

The thixotropic behavior of a coating is usually characterized by the thixotropy loop as shown in Figure 3.2. At the beginning, the coating is sheared at a continuously increasing shear rate, producing curve *a*. Then the coating is sheared at a constant shear rate until constant viscosity (curve *b*) is reached. The shear rate is then gradually decreased, producing curve *c*. The area enclosed by the thixotropy loop indicates the degree of thixotropy: the larger the area, the more pronounced is the thixotropic behavior of the coating. A pseudoplastic coating that exhibits no thixotropy would form no loop, and curve *a* would coincide with curve *c*. Curve *b* would not be formed, because the viscosity is not time dependent in nonthixotropic coatings. Thixotropic behavior is quite common in many aqueous coatings and high viscosity inks, and it is utilized to improve the coatability.

3.4 Leveling and Surface Tension

If the coating contains ingredients of differing surface tension and volatility, a surface tension gradient may be formed during drying, which results in poor leveling.¹ This behavior was observed when a drop of alkyd resin was dried in heptane solution. A high surface tension is created around the outer edges because of a faster solvent evaporation rate in that region. This causes a flow of the solution from the center of the drop, resulting in formation of a doughnut-shaped resin deposit. When xylene is employed as the solvent, the result is the opposite. A region of lower surface tension is produced around the outer perimeter of the drop, resulting in a thicker center of the dried deposit. The addition of a solvent-soluble surface active agent eliminates the formation of the surface tension gradient, resulting in a dried deposit of uniform thickness.

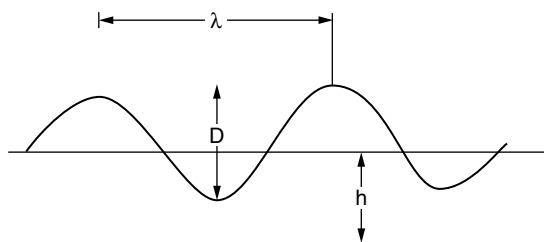

FIGURE 3.3 Profile of coating striation marks.

3.5 Leveling of Brush and Striation Marks

Brush application produces brush marks dependent on the brush fineness. Reverse roll and other roll coaters in which the coating splits between the rolls produce regular longitudinal striation marks in the coating. Knife coaters produce longitudinal streaks caused by the restriction of the flow under the knife by gel and other particles. The geometry of such coating striations or brush marks is shown schematically in Figure 3.3.

According to Orchard's² mathematical model of the leveling process, the leveling half-time may be expressed in the following manner:

$$T_{1/2} \propto \frac{\eta L \lambda^4}{\gamma h^3}$$

where γ is the surface tension and ηL the viscosity (at low shear rate).

The equation states that a low viscosity and a high surface tension favor the rate of leveling. The geometry of the coating (distance between striation marks and the coating thickness) has a very large effect on leveling. Decreasing the distance between the striation or brush marks is very effective in accelerating leveling, as is an increase in coating thickness. It has also been stated by some authors³ that coating elasticity has a retarding effect on leveling, although the effect is less important than that of viscosity.

References

1. D. A. Bultman and M. T. Pike, *J. Chem. Spec. Manuf. Assoc.*, January 1981.
2. S. Orchard, *Appl. Sci. Res.*, A11, 451 (1962).
3. M. Bierman, *Rheol. Acta*, 138 (1968).

Bibliography

- Beeferman, H. L., and D. A. Bregren, *J. Paint Technol.*, 38(492), 9–17 (1966).
- Kooistra, M. F., "Film formation phenomena: Fundamentals and applications," in *Third International Conference in Organic Coatings Science and Technology*, G. D. Parfitt and A. V. Patsis, Eds. Westport, CT: Technomic, 1979.
- Matsuda, T., and W. H. Brendly, Jr., *J. Coating Technol.*, 51(658), 46–60 (1979).
- Overdiep, W. S. "The leveling of paints," in *Proceedings of the Conference on Physical Chemistry and Hydrodynamics*, Oxford, July 1–13, 1977.
- Patton, T. C., *Paint Flow and Pigment Dispersion*, 2nd ed. New York: Wiley, 1979.
- Satas, D., "Surface appearance," in *Plastics Finishing and Decoration*, D. Satas, Ed. New York: Van Nostrand Reinhold, 1986, pp. 17–20.
- Smith, N. D. P., S. E. Orchard, and A. J. Rhind-Tutt, *J. Oil Chem. Colour. Assoc.*, 44, 618–633 (September 1961).

4

Structure–Property Relationships in Polymers

4.1	Structural Parameters	4-1
	Molecular-Weight Averages • Molecular Weight Between Cross-Links • Particle Size and Particle Size Distribution	
4.2	Properties of Wet Coatings.....	4-2
	Viscosity of Polymer Solutions • Viscosity of Suspensions	
4.3	Properties of Dried Films	4-4
	The Glass Transition Temperature • Tensile and Shear Moduli • Other Properties	
	References	4-6

Subbu Venkatraman
Raychem Corporation

Most of the binders used in paints, varnishes, lacquer films, and photolithographic coatings are made up of macromolecules. The final dry coating consists predominately of a polymer, either cross-linked or un-cross-linked. The material may have been polymeric before application or cured to become a polymer after application. In either case, a knowledge of the properties of polymers as related to structural features helps in obtaining coatings with desired performance characteristics.

4.1 Structural Parameters

We begin by defining some important structural parameters of polymers.

4.1.1 Molecular-Weight Averages

As all polymers contain a distribution of molecules of differing masses, it is customary to define averages of the distribution:

$$M_n(\text{number - average}) = \frac{\sum N_i M_i}{\sum N_i}$$

$$M_w(\text{weight - average}) = \frac{\sum w_i M_i}{\sum w_i}$$

$$M_v(\text{viscosity - average}) = [\sum w_i M_i^a]^{1/\alpha}$$

where N_i = number of molecules of molar mass M_i , and w_i their weight, and α is the Mark–Houwink exponent defined by

$$[\eta] = KM_v^\alpha \quad (4.1)$$

where $[\eta]$ is the intrinsic viscosity.

The number M_n is usually measured by nuclear magnetic resonance (NMR) spectrometry or osmometry; M_w can be obtained via light-scattering techniques, while intrinsic viscosity measurements yield estimates of M_v . Size-exclusion chromatography or gel permeation chromatography (GPA) can, in principle, be used to obtain all the averages mentioned above; care must be taken to ensure proper calibration of the column with standards that have the same molecular structure as the polymer of interest.

Although different definitions exist for the breadth of a distribution, we will use the most common one involving the averages defined above:

$$\text{MWD (molecular weight dispersity)} = \frac{M_w}{M_n}$$

A value of unity for this quantity defines a “narrow distribution” polymer; a value of 2 is obtained in condensation polymers, and higher values indicate considerable breadth of molecular weights. A measure of this quantity can be obtained via GPC, or a combination of NMR and light-scattering techniques.

4.1.2 Molecular Weight Between Cross-Links

This is defined as the average molar mass between successive cross-link sites in a network polymer and is denoted by the symbol M_c . It is a measure of the density of cross-linking and can be estimated from measurements of the equilibrium degree of swelling or of the modulus.

4.1.3 Particle Size and Particle Size Distribution

In the case of latexes, many properties of the wet and dry coatings are determined by the sizes of the latex particles. Estimations can be obtained directly through scanning electron micrography (SEM) if a film can be made. For the suspension, however, it is more customary to use light-scattering techniques (Coulter model N4, Brookhaven model DCP-1000) or optical sedimentation techniques (Horiba CAPA-700). In either case, it is possible to obtain a major portion of the particle size distribution.

4.2 Properties of Wet Coatings

Described below are some of the more important properties of coatings that are relevant to their ease of application, either in solution or as suspensions. Most wet coatings are brushed on (as with paints) or sprayed on (as with some epoxies used as insulation). The solution coatings are mostly polymer based, and thus a survey of the rheological properties of polymer solutions is given; in addition, some properties of suspensions are discussed.

4.2.1 Viscosity of Polymer Solutions

Although several theories of polymer solutions¹ examine the dependence of viscoelastic properties on molecular parameters, we shall not discuss these here. Instead, we shall focus on some generally accepted empirical relationships. Most of these are covered extensively by Ferry.²

4.2.1.1 Dependence on Molecular Weight

For pure polymers, the molecular weight dependence is usually expressed by the following type of relationship:

TABLE 4.1 Critical Molecular Weight of Source Polymers

Polymer	M_c
Polyvinyl chloride	6,200
Polyethylene	3,500
Polyvinyl acetate	25,000
Polymethyl acrylate	24,000
Polystyrene	35,000

Source: From D. W. Van Krevelen, *Properties of Polymers*, Elsevier, New York, 1976.³

$$\eta_0 = KM^\beta \quad (4.2)$$

where η_0 is the “zero-shear” viscosity, and K is a solvent- and temperature-dependent constant. The value of the exponent β is determined by the molecular weight range under consideration:

$$\text{for } M < M_c, \beta = 1 \text{ and for } M > M_c, \beta = 3.4 \quad (4.3)$$

where M_c is a critical molecular weight that expresses the onset of entanglements between molecules. The magnitude of M_c is characteristic of the polymer structure; Table 4.1 gives some representative numbers.

Although M_c signals the onset of topological effects on the viscosity, it is not identical to the molecular weight between entanglements, M_e . (The latter quantity is estimated from the magnitude of the rubbery plateau modulus.) Approximately, we have

$$M_c \sim 2M_e \quad (4.4)$$

Also, M_c is a function of polymer concentration. In the pure polymer (denoted by superscript zero), it attains its lowest value, M_c^0 ; in a solution of concentration C , its magnitude varies as discussed in Section 4.2.1.2.

The exponent β assumes the values quoted in Equation 4.3 only if the measured viscosity is in the so-called zero-shear-rate limit. At higher rates, β assumes values lower than unity and 3.4, in the two regimes.

4.2.1.2 Concentration Dependence of the Viscosity

As mentioned in Section 4.2.1.1, below a certain concentration, C^* , entanglement effects are not significant. This concentration is estimated from the following:

$$C^* = \rho \frac{M_c^0}{M} \quad (4.4a)$$

where M is the molecular weight of the polymer in the coating solution. The concentration C^* cannot be estimated from a plot of η_0 against concentration, however; the transition is not sharp, but gradual.⁴ No single expression for the concentration exists below C^* ; however, in the entangled regime, the expression

$$\eta_0 = C^5 M^{3.4} \quad (4.5)$$

works well for some polymers.^{5,6} This relation does not hold all the way to the pure polymer, where higher exponents are found.⁶ Equation 4.5 also does not hold in the case of polymer solutions in which there are other specific attractive forces, such as in poly(*n*-alkyl acrylates).⁷

There are two reasons for a reduction in viscosity of a polymer upon dilution: (a) the dilution effect, which causes the solution viscosity to be between those of the two pure components, and (b) a decrease of viscosity due to a lowering of T_g upon dilution. The latter is solvent-specific and is the main reason for the apparent difficulty in establishing a universal viscosity–concentration relationship for polymer solutions.

4.2.2 Viscosity of Suspensions

Many latex paints are suspensions in water or in an organic solvent. Their rheological properties differ from those of polymer solutions in several ways. The concentration dependence is of a different form, and in addition, there is a dependence on particle size. Also, at high concentrations, these suspensions tend to have structure, which usually refers to an aggregated network. The immediate consequences of the existence of a pseudonetwork are the phenomena of yield stress and thixotropy. We explore next the relationship of these quantities to the characteristics of the particles making up the suspension.

4.2.2.1 Concentration Dependence of the Viscosity

In dilute suspensions, the concentration dependence is expressed by an extension of the Einstein equation:

$$\eta_{\text{rel}} = \frac{\eta}{\eta_s} = 1 + 2.5\phi + 14.1\phi^2 \quad (4.6)$$

where η_s is the solvent viscosity, and ϕ is the volume fraction of the suspension. Equation 4.6 is valid for spherical particles without any interparticle interaction. Inclusion of long-range interaction (such as volume exclusion) merely changes the coefficient of the ϕ^2 term.

Of greater interest are the rheological phenomena that occur in suspensions of particles that have short-range interactions, attractive or repulsive. In a comprehensive study, Matsumoto et al.⁸ have established the conditions for the existence of yield stresses in suspension. Their conclusions are as follows:

1. For particles with repulsive interactions, no yield stresses exist.
2. Suspensions of neutral particles, or particles with attractive forces, do exhibit yield stresses.
3. The magnitude of the yield stress increases with the concentration of the particles and with increasing ratio of surface area to volume.

In this study, the existence of the yield stress was inferred from the presence of a plateau in the elastic modulus G' , at very low frequencies; the magnitude of the yield stress was deduced from the height of the plateau modulus. A detailed and critical survey of the literature is given by Meitz.⁹

The other important rheological consequence of a pseudonetwork is thixotropy, defined elsewhere in this volume. The phenomenon is attributed to a time-dependent but reversible breakdown of the network.

4.3 Properties of Dried Films

4.3.1 The Glass Transition Temperature

The T_g is defined in various ways, but in a broad sense, it signals the onset of small-scale motion in a polymer. It is heavily influenced by the chemical structure, in particular, by the bulkiness (steric hindrance) of pendant groups. (See Van Krevelen¹⁰ for an excellent discussion.)

The molecular weight dependence of the glass transition is fairly straightforward and is given by the following:

$$T_g = T_g^\infty - \frac{M}{M_n} \quad (4.7)$$

where T_g^∞ is the limiting value of T_g at high molecular weights.

The effect of plasticizers on T_g is well documented.¹⁰ According to a theoretical treatment by Bueche,¹¹ the T_g reduction by plasticizers can be calculated from

$$T_g(\text{solution}) = \frac{T_{g,p} + (KT_{g,s} - T_{g,p})\phi_s}{1 + (K-1)\phi_s} \quad (4.8)$$

where $T_{g,p}$ and $T_{g,s}$ are the glass transition temperatures of the polymer and solvent, respectively, and ϕ_s is the volume fraction of solvent. Then we write

$$K = \frac{\alpha_{1s} - \alpha_{gs}}{\alpha_{1p} - \alpha_{gp}}, \quad 1 < K < 3$$

where α_1 = volume expansion coefficient above T_g , and α_g = volume expansion coefficient below T_g .

To calculate the T_g of a solution, the T_g of the solvent should be known¹² or estimated as $2T_m/3$, and K is usually taken to be 2.5.

4.3.2 Tensile and Shear Moduli

Both tensile and shear moduli are functions of temperature, and of time in the case of viscoelastic polymers. We shall restrict our discussion to the temperature dependence of the isochronal moduli. (Because the tensile and shear moduli are related to each other through the use of an equation involving the Poisson's ratio, the comments made here on the shear modulus G can be extended to the tensile modulus E , as well.)

For semicrystalline polymers below T_g , the modulus can be estimated from¹³

$$G = G_g + X_c^2(G_c - G_g) \quad (4.9)$$

where G_g , G_c are the moduli for the fully amorphous and fully crystalline polymer, respectively, and X_c is the degree of crystallinity.

Above T_g , the same equation can be used, but G_c far exceeds G_g , and Equation 4.9 reduces to

$$G \approx X_c^2(G_c) \quad (4.10)$$

For amorphous polymers above T_g , the modulus is given by the rubber elasticity expression:

$$G_e = \frac{\rho^{RT}}{M_e} \quad (4.11)$$

where M_e^0 is the entanglement molecular weight (see Section 4.2.1.2). This rubbery plateau for un-cross-linked polymers is observed only at molecular weights higher than M_e^0 .

For cross-linked amorphous polymers above T_g (elastomers), the modulus is given in analogous fashion:

$$G \approx \frac{\rho^{RT}}{M_c} \quad (4.12)$$

where M_c is the molecular weight between permanent cross-linked junctions. When M_c exceeds M_e , trapped entanglements also play a part in determining modulus.¹⁴

$$G \approx \frac{\rho^{RT}}{M_c} + f_e G_e \quad (4.13)$$

where G_e is given by Equation 4.11 and f_e is a probability factor for trapped entanglements.

In the case of network imperfections, Equation 4.12 is modified.^{14,15} The quantity f_e can be calculated if the reaction parameters for network formation are known.^{14,16,17}

4.3.3 Other Properties

Several other properties of dried films influence performance characteristics. Examples are the coefficient of thermal expansion, ultimate mechanical properties, stress relaxation and creep, and dielectric properties. However, correlation of these properties with structure for polymeric films is not well established; some of the more successful attempts are treated in Refs. 2 and 3.

References

1. R. B. Bird, R. C. Armstrong, and O. Hassager, *Dynamics of Polymeric Fluids*, Vol. 2. New York: Wiley-Interscience, 1987.
2. J. D. Ferry, *Viscoelastic Properties of Polymers*. New York: Wiley, 1980.
3. D. W. Van Krevelen, *Properties of Polymers*. New York: Elsevier, 1976.
4. Ref. 2, see discussion in Chapter 17.
5. J. W. Berge and J. D. Ferry, *J. Colloid Sci.*, 12, 400 (1957).
6. G. Pezzin and N. Gligo, *J. Appl. Polym. Sci.*, 10, 1 (1966).
7. Ref. 2, p. 510.
8. T. Matsumoto, O. Yamamoto, and S. Onogi, *J. Rheol.*, 24, 279 (1980).
9. D. W. Meitz, Ph.D. thesis, Carnegie-Mellon University, December 1984.
10. Ref. 3, p. 383.
11. F. Bueche, *Physical Properties of Polymers*. New York: Wiley, 1962.
12. Ref. 3, p. 384.
13. Ref. 3, p. 266.
14. E. M. Valles and C. W. Macosko, *Macromolecules*, 12, 673 (1979).
15. P. J. Flory, *Principles of Polymer Chemistry*. Ithaca, NY: Cornell University Press, 1953, p. 458.
16. M. Gottlieb, C. W. Macosko, G. S. Benjamin, K. O. Meyers, and E. W. Merrill, *Macromolecules*, 14, 1039 (1981).
17. D. S. Pearson and W. W. Graessley, *Macromolecules*, 13, 1001 (1980).

5

The Theory of Adhesion

Carl A. Dahlquist
3M Company

5.1	Contact Angle Equilibrium	5-1
5.2	Forces of Attraction	5-3
5.3	Real and Ideal Adhesive Bond Strengths	5-8
	References	5-9

When pressure-sensitive adhesive is applied to a smooth surface, it sticks immediately. The application pressure can be very slight, not more than the pressure due to the weight of the tape itself. The adhesive is said to “wet” the surface, and, indeed, if the tape is applied to clear glass and one views the attached area through the glass, it is found that in certain areas the adhesive–glass interface looks like a liquid–glass interface. From this one would infer that a pressure-sensitive adhesive, even though it is a soft, highly compliant solid, also has liquidlike characteristics. Some knowledge of the interaction between liquids and solids is beneficial to the understanding of adhesion.

5.1 Contact Angle Equilibrium

When a drop of liquid is placed on a surface of a solid that is smooth, planar, and level, the liquid either spreads out to a thin surface film, or it forms a sessile droplet on the surface. The droplet has a finite angle of contact (Figure 5.1). The magnitude of the contact angle depends on the force of attraction between the solid and the liquid and the surface tension of the liquid. The contact angle equilibrium has received a great deal of attention, principally because it is perhaps the simplest direct experimental approach to the thermodynamic work of adhesion.

Many years ago Young¹ proposed that the contact angle represents the vectorial balance of three tensors, the surface tension of the solid in air (γ_{sa}), the surface tension of the liquid in equilibrium with the vapor (γ_{lv}), and the interfacial tension between the solid and the liquid (γ_{sl}). The force balance can be written

$$\gamma_{sa} = \gamma_{lv} \cos \theta + \gamma_{sl} \quad (5.1)$$

Young’s equation has come under criticism on the grounds that the surface tension of a solid is ill defined, but most surface chemists find his equation acceptable on theoretical grounds.

The equation can be written as a force equilibrium or as an energy equilibrium, because the surface tension, expressed as a force per unit of length, will require an energy expenditure of the same numerical value when it acts to generate a unit area of new surface.

Harkins and Livingston² recognized that Young’s equation must be corrected when the exposed surface of the solid carries an adsorbed film of the liquid’s vapor. The solid–“air-plus-vapor” tensor, γ_{sv} , is less than the solid–air tensor, γ_{sa} . Harkins and Livingston introduced a term, πe , to indicate the reduction thus:

$$\gamma_{sv} = \gamma_{sa} - \pi e \quad (5.2)$$

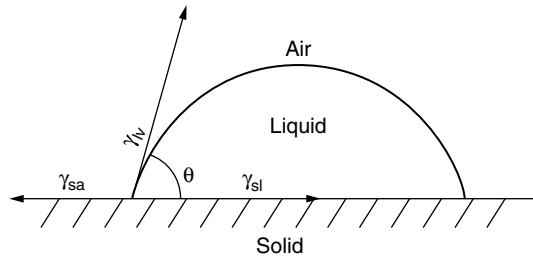

FIGURE 5.1 Contact angle equilibrium of surface and interfacial tensions.

and the modified Young equation becomes accordingly

$$\gamma_{sa} = \gamma_{lv} \cos \theta + \gamma_{sl} + \pi e \tag{5.3}$$

The work of adhesion (W_a) is the thermodynamic work necessary to separate the liquid from the solid without performing any additional work, such as viscous or elastic deformation of either the liquid or the solid. Dupré³ is credited with the definition of the work of adhesion. When a liquid is separated from a solid, new solid–air and liquid–air interfaces are created, and solid–liquid interface is destroyed (Figure 5.2).

The Dupré equation becomes

$$W_a = \gamma_{lv} + \gamma_{sa} - \gamma_{sl} \tag{5.4}$$

Combining Equations 5.4 and 5.3 yields.

$$W_a = \gamma_{lv} (1 + \cos \theta) + \pi e \tag{5.5}$$

Under some circumstances, πe is negligible, and Equation 5.5 simply reduces to the original Young–Dupré equation:

$$W_a = \gamma_{lv} (1 + \cos \theta) \tag{5.6}$$

The work of adhesion can then be obtained by measuring the surface tension of the liquid and the contact angle; γ_{sa} need not be known.

Zisman and his associates^{4,5} at the Naval Research Laboratories have done extensive and careful investigation of the contact angles of liquids on solids. They found that when the surface tensions of a family of liquids were plotted against the cosines of their contact angles on a given solid, the data fell, with some scatter, along a relatively straight line. The surface tension value at which this line intersected the ordinate [i.e., where $\cos \theta = 1.00$ (or $\theta = 0^\circ$)] was designated the critical surface tension, γ_c .

Some have equated γ_c of a solid to its surface tension or surface energy, but this was never done or condoned by Zisman. The critical surface tension of a solid is simply the highest surface tension among the surface tensions of liquids that will spread on the solid. It is, of course, a measure of the attractive force a liquid experiences when it comes in contact with the solid.

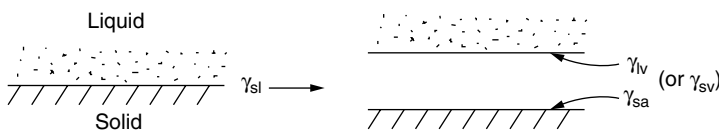

FIGURE 5.2 $W_a = \gamma_{lv} + \gamma_{sa} - \gamma_{sl}$.

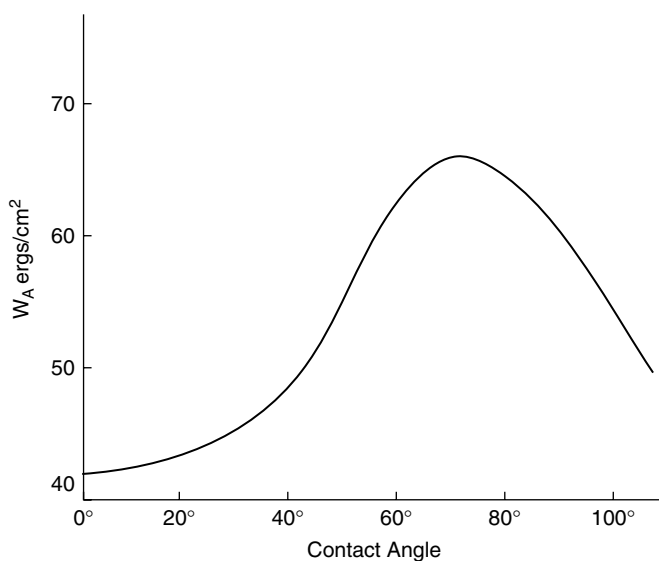

FIGURE 5.3 Work of adhesion of liquids on a surface having a γ_c of 21.5 ergs/cm².

Some have postulated that a contact angle of 0° is essential for the formation of a strong adhesive bond. This is said to be requisite for wetting. Wetting, however, is a relative term. Surely the molecules of a liquid and a solid will be in close contact at the interface even though the contact angle is greater than 0°. In fact, if one measures the works of adhesion between a family of liquids and a solid, one finds, as illustrated in Figure 5.3, that the work of adhesion can maximize at a relatively high contact angle. Thus, spreading is not requisite for good adhesion on thermodynamic grounds, but it may be highly desirable in real situations for maximizing contact area and minimizing interfacial flaws and defects.

5.2 Forces of Attraction

All atoms or molecules, when brought into sufficiently close proximity, exhibit attraction for each other as a result of asymmetric charge distributions in their electron clouds. Under special circumstances, if there are fixed electrical charge distributions (e.g., in electrets) or fixed magnetic polarization, repulsion may occur, but these are special and rare cases. Repulsion also occurs when matter is compressed to the point that the outer electron orbits begin to interpenetrate each other; but when electrical charges and magnetic domains are randomly distributed, and the liquids and solids are not under extremely high compressive forces, the forces of attraction prevail.

The forces take several forms. The forces due to the fluctuation in the electron cloud density are universal. These forces were first recognized by Fritz London⁶ and are sometimes called the “London forces,” but more frequently, they are called “dispersion forces.” The fluctuation in electron density produces temporary electrical dipoles, which give rise to universal attraction in matter. These are the forces that account for cohesion and adhesion in aliphatic hydrocarbons. They are relatively weak atomic interactions, but because all the atoms are involved, the cumulative effect is great. The dispersion forces depend markedly on the distance of separation, decreasing as the seventh power of the separation between isolated atom pairs, and as the third or fourth power of the separation between planar surfaces.

The dispersion forces are common to all matter and can account for universal adhesion in condensed media, but other forces can contribute substantially to adhesion in specific cases. There may be attractive forces between permanent dipoles, where the potential energy of head-to-tail interaction of two dipoles having dipole moments μ_1 and μ_2 is given in the lowest energy configuration, as

$$U_{int}^p = \frac{-2\mu_1\mu_2}{r^3}$$

where r is the center-to-center distance between the dipoles.

If the rotational energy is less than the thermal energy of the system, then

$$U_K = \text{Keesom potential} = \frac{-2\mu_1^2\mu_2^2}{3kTr^6}$$

where k is Boltzmann's constant (0.0821 l·atm/mol deg), and T is absolute temperature (K).

There may be dipole-induced dipoles, where the potential energy of interaction is given by

$$U^1 = \frac{-\mu_1^2\alpha_2 + \mu_2^2\alpha_1}{r^6}$$

where α_2 and α_1 are the molecular polarizabilities.

There may be acid–base interactions^{7,8} across the interface that can lead to strong bonding. Examples are hydrogen bonding, Lewis acid–base interactions, and Brønsted-type acid–base interactions.

Covalent bonding between adhesive and adherend, if achievable either by chemical reactions or by high energy radiation, can lead to very strong bonds.

Interdiffusion, usually not achievable except between selected polymers, can also lead to high adhesion.

The force of attraction between planar surfaces has been derived from quantum mechanical considerations by Casimir, Polder,⁹ and Lifshitz.¹⁰

Lifshitz calculated the attractive forces between nonmetallic solids at distances of separation sufficiently large that the phase lag due to the finite velocity of electromagnetic waves becomes a factor. He obtained the following relationship between the attractive force and the known physical constants:

$$F = \frac{\pi^2 hc(e_o - 1)[\phi(e_o)]}{240d^4(e_o + 1)}$$

where F is the attractive force per unit of area, h is Planck's constant, C is the velocity of light, d is the distance of separation, e_o is the dielectric constant, and $\phi(e_o)$ is a multiplying factor that depends on the dielectric constant as follows:

$1/e_o$:	0	0.025	0.10	0.25	0.50	1
$\phi(e_o)$:	1	0.53	0.41	0.37	0.35	0.35

Strictly speaking, the dielectric constant in this expression should be measured at electron orbital frequency, about 10^{15} Hz. However, if we assume handbook values of the dielectric constant at 10^6 Hz, which for nylon, polyethylene, and polytetrafluoroethylene, are 3.5, 2.3, and 2.0, respectively, the corresponding $\phi(e_o)$ values are 0.37, 0.36, and 0.35. The force values then stand in the ratios 0.11 to 0.056 to 0.039. When normalized to $F(\text{nylon}) = 1.0$, they fall to the following ratios:

$$F(\text{nylon}), = 1.00; F(\text{PE}), 0.51; F(\text{PTFE}), 0.35$$

When the γ_c values (dynes/cm) of these three materials are similarly normalized to the γ_c values for nylon, the values fall in remarkably similar ratios.

	Nylon	PE	PTFE
γ_c	56	31	18.5
$\gamma_c(\text{norm})$	1.00	0.55	0.33

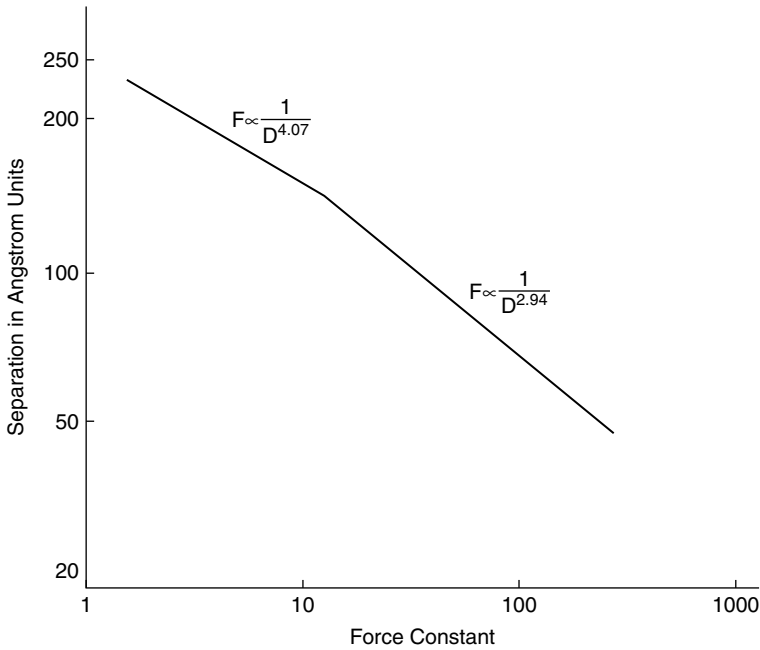

FIGURE 5.4 Attraction between ideally planar solids.

In the Lifshitz equation, the force of attraction is shown to decrease as the inverse fourth power of the distance of separation. However, when the separation becomes so small that the phase lag in the interaction no longer is significant (it is of the order of 6° at a separation of 50 \AA), the attractive force varies as the inverse third power of the distance of separation. This has been verified experimentally,¹¹ although the direct measurement is extremely difficult (Figure 5.4). The forces existing at separations greater than 50 \AA contribute very little to adhesion.

Some 30 years ago Good and Girifalco reexamined the interfacial tensions between dissimilar liquids and developed a theory of adhesion.¹² They found that the work of adhesion, given by

$$W_a = \gamma_{L_1} + \gamma_{L_2} - \gamma_{L_1L_2}$$

could be approximated quite well by the geometric mean of the works of cohesion of the two liquids when the only attractive forces of cohesion are dispersion forces:

$$W_a = 2(\gamma_{L_1}\gamma_{L_2})^{1/2}$$

However, in some liquid pairs (e.g., water and hydrocarbons), this did not hold, and they coined an “interaction parameter,” Φ , given by

$$\Phi = \frac{\gamma_{L_1} + \gamma_{L_2} - \gamma_{L_1L_2}}{2(\gamma_{L_1}\gamma_{L_2})^{1/2}}$$

Thus,

$$W_a = 2\Phi(\gamma_{L_1}\gamma_{L_2})^{1/2}$$

For water on a paraffinic hydrocarbon, where the contact angle is 108° , Φ would have a value of about 0.55. For hexadecane on polyethylene, Φ is very near unity. Good and his associates^{11,12} have provided directions for calculating Φ , and they give experimental and calculated values for several combinations of water and organic liquids.

Fowkes¹³ approached the problem from a different point of view. He reasoned that the only forces operable at the interface between water and an aliphatic hydrocarbon molecule contain no hydrogen bonding groups and no fixed dipoles.

Fowkes also assumed that the work of adhesion would be given by twice the geometric mean of the surface energies of the two liquids on either side of the interface but now taking into consideration only the dispersion force components of the surface energies. For the work of adhesion between water (L_1) and n -octane (L_2), we have

$$W_a = 2(\gamma_{L_1}^D \gamma_{L_2}^D)^{1/2} = \gamma_{L_1} - \gamma_{L_1 L_2}$$

where the superscript D stands for the dispersion energy component of the total surface energy. Accepted values for the surface energies and interfacial energies are as follows:

$$\gamma_{L_1} = 72.8 \text{ ergs/cm}^2; \gamma_{L_2} = \gamma_{L_2}^D = 21.8 \text{ ergs/cm}^2; \gamma_{L_1 L_2} = 50.8 \text{ ergs/cm}^2$$

If these values are substituted into the equation above to solve for $\gamma_{H_2O}^D$, we get 22.0 ergs/cm^2 . Fowkes evaluated several water-aliphatic hydrocarbon systems and found that they all yielded essentially the same value for the dispersion energy component of the surface energy of water, $21.8 \pm 0.7 \text{ ergs/cm}^2$.

Turning now to the work of adhesion and the interfacial energy between mercury and aliphatic hydrocarbon, Fowkes calculated the dispersion energy component of the surface energy of mercury. Using n -octane as the hydrocarbon liquid having a surface energy of 21.8 ergs/cm^2 (all of it attributed to dispersion forces), the surface energy of mercury, 484 ergs/cm^2 , and the interfacial energy, 375 ergs/cm^2 , we have

$$W_a = 2(\gamma_{Hg}^D \gamma_{n\text{-oct}}^D)^{1/2} = \gamma_{Hg} + \gamma_{n\text{-oct}} - \gamma_{(Hg, n\text{-oct})}$$

$$W_a = 2(\gamma_{Hg}^D \times 21.8)^{1/2} = 484 + 21.8 - 375$$

$$\gamma_{Hg}^D = 196.2$$

The average γ_{Hg}^D for a series of mercury-aliphatic hydrocarbon systems yielded $200 \pm 7 \text{ ergs/cm}^2$ for the dispersion energy component of the surface energy of mercury.

Since the remaining forces that contribute to the surface energy of mercury are metallic forces, the only interacting forces at the water-mercury interface are the dispersion forces, and the work of adhesion is given by

$$W_a = 2(200 \times 21.8)^{1/2} = 484 + 72.8 - \gamma_{(Hg, H_2O)}$$

from which

$$\gamma_{(Hg, H_2O)} = 424.7 \text{ ergs/cm}^2$$

This compares very favorably with the measured value of 426 ergs/cm^2 .

The work of adhesion due to dispersion forces is numerically small in work or energy units. For example, the work of adhesion of methylene iodide on polyethylene is 82 ergs/cm² ($\theta = 52^\circ$). This small value is not, however, indicative of a small force of attraction across the interface. Keep in mind that the work is the product of force and displacement, and that the attractive force, at separation distances less than 50 Å (5×10^{-7} cm) increases as the inverse of displacement raised to the third power (Figure 5.4).

The molecules at the interface are at an equilibrium distance of separation where attractive forces and repulsive forces balance. The variation in the repulsive forces with distance of separation has a dependence several orders of magnitude higher than the attractive forces (of the order of 10^{12} for atom pairs and 10^8 for repulsion forces across a hypothetical plane). We can calculate the maximum force of attraction by equating the work of adhesion to the work of separation.

Let F_a indicate the attractive force, F_r the repulsive force, x the distance separation, and d the equilibrium distance. We cannot measure d directly, but we can estimate it from calculations of the distance between molecular centers in a liquid of known specific gravity and molecular weight. In the case of methylene iodide (sp g 3.325, mol 267.9), we calculate the separation to be about 5×10^{-8} cm between the centers of adjacent molecules.

If we take 5×10^{-8} cm as a reasonable distance of separation across the interface between methylene iodide and polyethylene, and we accept the force versus distance relationships for attraction (a) and repulsion (r), we can write:

$$F_a = (F_a)_e \left(\frac{d}{x} \right)^3$$

$$F_r = (F_r)_e \left(\frac{d}{x} \right)^8$$

where the subscript e stands for “equilibrium.” At equilibrium we have the condition that $(F_a)_e = (F_r)_e$. We can then express the work of adhesion as

$$W_a = \int_d^\infty (F_a)_e \left(\frac{d}{x} \right)^3 dx - \int_d^\infty (F_r)_e \left(\frac{d}{x} \right)^8 dx$$

The solution is

$$W_a = F_e \left[\frac{d}{2} - \frac{d}{7} \right]$$

For methylene iodide on polyethylene, W_a is 82 ergs/cm². Taking d as 5×10^{-8} cm, $F_e = F = F_r = 4.92 \times 10^9$ dynes/cm².

The maximum attractive force is encountered where the difference between the attractive forces and the repulsive forces maximizes as separation proceeds. This occurs where $(d/x)^3 - (d/x)^8$ maximizes, at about $x = 1.22d$.

At this displacement, $F = 0.347F_e$, or, in the case of methylene iodide and polyethylene, at 1.71×10^9 dynes/cm² (about 25,000 psi). This would be the maximum attractive force experienced when separation of the materials is attempted; it far exceeds the average stresses that are typically observed when adhesive bonds are broken.

Others have calculated theoretical forces of adhesion by other approaches. All yield results that predict breaking strength far exceeding the measured breaking strengths.

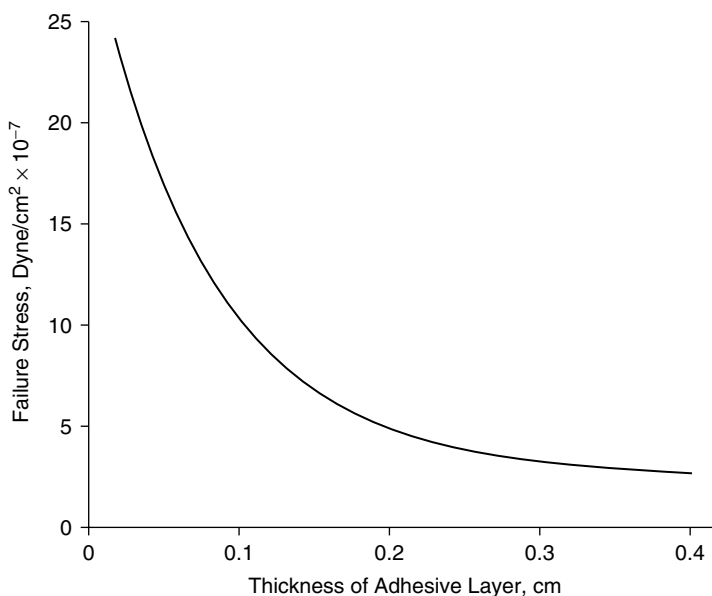

FIGURE 5.5 Adhesive layer thickness and strength of butt joints.

5.3 Real and Ideal Adhesive Bond Strengths

How, then, does one account for the fact that theoretical or ideal bond strengths do not seem to be attainable? The measured cohesive strengths of solids also fall far short of theoretical values. Only whisker crystals of silicon, graphite, iron, and the like have measured tensile strengths approaching their theoretical tensile strengths.

J. J. Bikerman contended that all adhesive bonds are flawed and contain weak boundary layers, and hence, always fall short of their theoretical strengths. Undoubtedly this is often the case; but flaws, at least gross flaws, can be minimized, and fracture in weak boundary layers, which can be detected, is not always observed.

All destructive tests, whether done in tension, shear, or peel, involve stress concentrations. Unless the stress is uniformly distributed over a very small area, as in the tensile strength tests on the “whiskers,” there will be localized stresses that far exceed the average stress. It is well known that the measured average breaking strengths of adhesive bonds broken in tension decrease as the adhesive thickness increases (Figure 5.5), and it can be shown that tensile stresses at the periphery of the bond are higher than interior stresses. If a flaw leads to highly localized stress, cleavage may be initiated and proceed catastrophically.

Bonds pulled in shear not only experience shearing stress concentrations but also tearing stresses.^{14,15} Peeling is a deliberate application of stress concentration.

Deformation and flow also contribute to stress concentrations and failure. It would be advantageous to match the mechanical properties of the adhesive to the mechanical properties of the adherend, but this is rarely feasible. Instead, the adhesive designer resorts to the expedient of toughening the adhesive and incorporating materials that arrest crack propagation, thereby maximizing the work necessary to destroy the bond.

In many instances, the adhesive–adherend interface is more accurately described as an “interphase.” A case in point is the bonding of aluminum to aluminum with structural adhesive. The surface of aluminum is really aluminum oxide, which, depending on the manner in which it was formed, will vary in strength and porosity. The adhesive penetrates and locks into the oxide film, and the bond strength can be greatly enhanced by use of a surface treatment that produces a strong, well-bonded oxide layer.

Adhesive–adherend bond strengths are often enhanced by priming. A classic example is the bonding of vulcanized rubber to steel, in which the steel is first electroplated with a thin coat of copper, and the rubber compound is cured on the copper surface under heat and pressure. It is believed that the sulfur in the vulcanizate bridges to the copper by chemical bonding to give a strong bond, and the copper, in turn, is strongly bonded to the steel.

Priming is often used on bonding adhesives to plastic films. For example, the first transparent pressure-sensitive tape, which comprised a cellophane film and a natural rubber rosin adhesive, would undergo separation of the adhesive from the film under humid conditions. The problem was solved by first applying to the cellophane a thin prime coat, a blend of natural rubber and casein, then coating the adhesive over the primer.

Surfaces notoriously difficult to bond to, such as polyethylene, polypropylene, and Teflon, are modified by treatments that make the surfaces more polar and possible chemically active, for example, by corona, plasma, or chemical treatments. These treatments may also remove weak boundary layers.

Though strong, durable adhesive bonds are usually the goal of adhesive technology, there is also a need for bonds that are deliberately made weak. This need arises in the pressure-sensitive tape industry, where it is desirable to have tape that unwinds easily from the roll, and especially where pressure-sensitive adhesives are to be transferred from a carrier film to another surface. The surfaces that provide easy release typically have low critical surface energies, almost totally dominated by the “dispersion energy” component. Also, for release coatings to function well, there must be no mutual solubility between them and the adhesives. Silicone release coatings, which consist mainly of polydimethyl siloxane, provide the easiest release. They have low critical surface energies, though not as low as certain fluorocarbon polymers. They also have a high degree of incompatibility with the pressure-sensitive adhesives that release well from them, but these criteria alone do not explain the low level of adhesion. In addition, they differ from other release coatings by being soft and elastic rather than hard. This feature may serve to enhance the stress concentration when the adhesive is separated from the release liner.

In conclusion, adhesive bond strengths measured by destructive tests will never approach theoretical value, but the intrinsic attractive forces can be manipulated by the choice of materials and surface treatments to produce a wide range of practical bond strengths.

References

1. T. Young, *Phil. Trans. R. Soc. London*, 95, 65 (1805).
2. W. D. Harkins and H. K. Livingston, *J. Chem. Phys.*, 10, 342 (1942).
3. A. Dupré, *Théorie Mécanique de la Chaleur*, Paris, 1869, p. 393.
4. W. A. Zisman, *Ind. Eng. Chem.*, 55, 18 (1963).
5. E. G. Shafrin, in *Polymer Handbook*, J. Brandrup and E. M. Immergut, Eds. New York: Wiley-Interscience, 1966, pp. 111–113.
6. F. London, *Trans. Faraday Soc.*, 33, 8 (1936).
7. R. S. Drago, L. B. Parr, and C. S. Chamberlain, *J. Am. Chem. Soc.*, 99, 3203 (1977).
8. F. M. Fowkes, *J. Adhes. Sci. Technol.*, 1, 7 (1987).
9. H. B. C. Casimir and D. Polder, *Phys. Rev.*, 73, 360 (1948).
10. E. M. Lifshitz, *C. R. Acad. Sci. USSR*, 97, 643 (1954).
11. D. Tabor and R. N. S. Winterton, *Nature*, 219, 1120 (1968).
12. L. A. Girifalco and R. J. Good, *J. Phys. Chem.*, 61, 904 (1957).
13. F. M. Fowkes, *J. Phys. Chem.*, 66, 382 (1962).
14. O. Volkersen, *Luftfahrtforschung*, 15, 41 (1938).
15. M. Goland and E. Reissner, *J. Appl. Mech., Trans. ASME*, 66, 17 (1944).

6

Adhesion Testing

6.1	Fundamentals of Adhesion	6-1
	Components at the Interface • Causes of Failure • Measures of Adhesion	
6.2	Standardization of Adhesion Tests.....	6-3
	Cross-Cut Test • Tensile Methods	
6.3	Delamination Procedures	6-4
	Knife-Cutting Method • Peel Test • Blister Method	
6.4	Local Debonding Systems.....	6-7
	Scratch Technique • Indentation Debonding • Impact Tests	
6.5	Flaw Detection Methods.....	6-10
	Ultrasonic Pulse-Echo System • Acoustic Emission Analysis • Thermographic Detection of Defects	
6.6	Outlook.....	6-12
	References.....	6-13

Ulrich Zorll

Forschungsinstitut für Pigmente and Lacke

6.1 Fundamentals of Adhesion

Without sufficient adhesion, a coating of otherwise excellent properties in terms of resistance to weather, chemicals, scratches, or impact would be rather worthless. It is therefore necessary to provide for good adhesion features when paint materials are formulated. There must also be adequate means for controlling the level of adhesion strength after the coating has been spread and cured on the substrate. Moreover, methods should be available that allow for the detection of any failure in the case of the dissolution of the bond between coating and substrate, under any circumstances whatsoever.

6.1.1 Components at the Interface

In chemical terms, there is a considerable similarity between paints on one side and adhesives or glues on the other (Figure 6.1). Both materials appear in the form of organic coatings; thus, it is appropriate in this chapter to concentrate on the behavior of paint materials. Adhesion is the property requested in either case, though perhaps with different emphasis on its intensity, according to the intended use.

Such a coating is, in essence, a polymer consisting of more or less cross-linked macromolecules and a certain amount of pigments and fillers. Metals, woods, plastics, paper, leather, concrete, or masonry, to name only the most important materials, can form the substrate for the coating.

It is important, however, to keep in mind that these substrate materials may inhibit a rigidity higher than that of the coating. Under such conditions, fracture will occur within the coating, if the system experiences external force of sufficient intensity. Cohesive failure will be the consequence, however, if the adhesion at the interface surpasses the cohesion of the paint layer. Otherwise, adhesive failure is obtained, indicating a definite separation between coating and substrate.

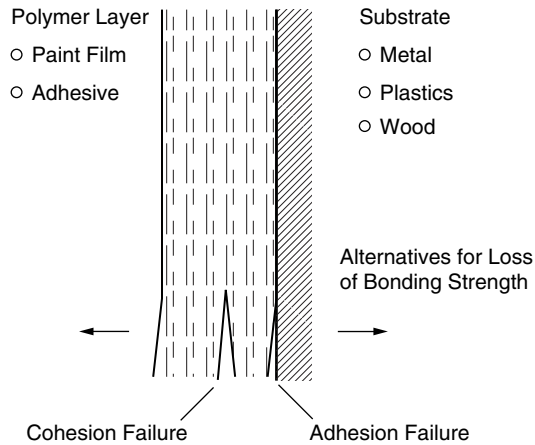

FIGURE 6.1 Bonding situation at the interface of polymer layer and substrate.

The energetic aspects at the interface and the effects of elasticity within coating and substrate have been taken into consideration for a theoretical approach, on which it is possible to base predictions of where failure will occur.¹

Both types of adhesion damage are encountered in practice. The existence of cohesion would signal the attainment of an optimum adhesion strength. Any further improvement of the systems should then be sought in the direction of increasing the inherent strength of the coating material.

6.1.2 Causes of Failure

The bond between coating and substrate can be put under stress, and may thus finally fail, by means of several external factors, acting either alone or in combination (Figure 6.2). First, there may be regular mechanical stress, affecting not only the bulk of the materials but also the bond strength at the interface. It is useful here to distinguish between the two most common types of stress: tensile stress, effective perpendicularly to the interface, and shear stress, appearing along the plane of contact.

Moreover, as coatings may undergo changes in temperature, sometimes rapidly, any difference in the coefficient of expansion can cause at the interface stress conditions of such high intensity that the paint film becomes detached from the substrate. This event may be especially disadvantageous because the temperature effects tend to be less obvious than the mechanical and chemical factors.

There may be, of course, an effect of a chemical, which penetrates through the coating and becomes absorbed at the interface, causing loss of adhesion here.

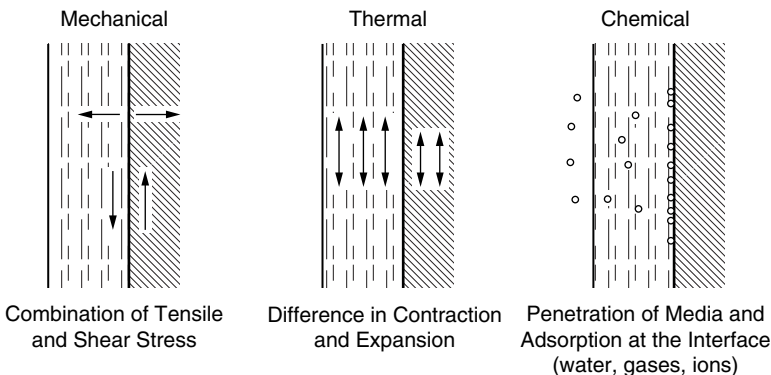

FIGURE 6.2 External situation at the interface of polymer layer and substrate.

It is always useful to take these effects into consideration when adhesion must be measured because the method of testing the coating should reproduce the end-use conditions.

6.1.3 Measures of Adhesion

There are various possibilities for characterizing the results obtained in an adhesion test. If it is necessary to evaluate the bonding strength at the interface, the quantity to be measured is obviously the maximum mechanical stress that can be attained at the interface. This is adhesion strength in the strict sense, expressed as force per unit area, and specified as either tensile or shear stress. Consequently, in several test methods, the result is obtained in that form.

The energy that must be provided for breaking the bond at the interface can also be an informative quantity. It is expressed as work of adhesion and is formally equivalent to the product of adhesion strength, as defined earlier, and the distance between the separated surfaces of coating and substrate immediately after detachment. Thus, that quantity has the dimensions of force per unit length, and this is exactly the value obtained with some other test methods, e.g., the peeling test.

6.2 Standardization of Adhesion Tests

Since a specification for the degree of adhesion must be provided in nearly each paint formulation, it is not surprising that methods for routine measurement of that key quantity have been established in the field of quality testing. This is true for the cross-cut test, the paint technician's first choice when adhesion must be estimated. However, the cross-cut test is nowadays more and more complemented by the pull-off methods.

Both methods have been the subject of national standardization. However, the differences in the documents of various countries are of minor importance, and it was relatively easy to formulate international standards, ensuring that these fundamental tests can be carried out in a uniform manner.

6.2.1 Cross-Cut Test

Scope and procedure of practical and instructive method have been laid down by the International Organization for Standardization (ISO).² To obtain an idea of the adhesion of the coating, a lattice pattern is cut into it, penetrating through the film and into the substrate. Various cutting tools can be used either manually or mechanically for this purpose. A good choice is the multiple cutting tool, consisting of a set of six "knives," 1 or 2 mm apart, yielding a uniform pattern.

The test results are evaluated according to the scheme indicated in Figure 6.3. The classification is based on estimating the amount of paint flakes separated from the substrate. If in doubt about the real percentage of detachment, one may brush off the loose parts or remove them by means of an adhesive tape.

It is not always necessary to base the judgment about the degree of adhesion on the whole six-step classification. The ISO recommends a standard considering the test for "go-no go" statements. In such case, class "0" would indicate perfect adhesion, whereas class "2," or even class "1," should be interpreted as an objectionable result. All higher classes would then signal, although with different distinctness, that something must be done to improve the coating's adhesion.

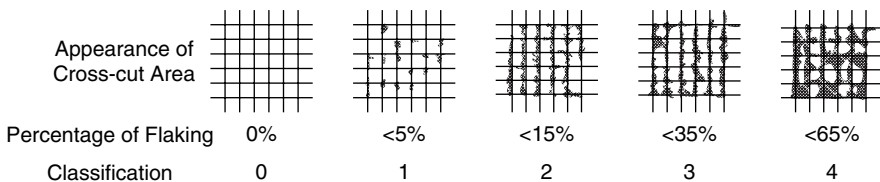

FIGURE 6.3 Principle of classifying paint film adhesion in the cross-cut test.

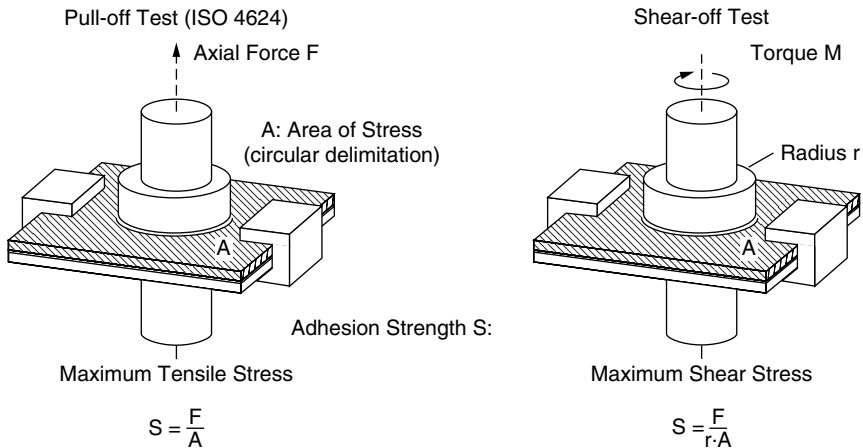

FIGURE 6.4 Methods for quantitative determination of adhesion strength.

6.2.2 Tensile Methods

The typical stress patterns at the interface, caused by loads acting predominantly either normal or parallel to the plane of contact, have been used as the basis for pertinent test methods (Figure 6.4). The pull-off method is the most widely used procedure and has already been standardized internationally.³ As a preparation for the test, a stud, normally made of steel, is glued with the coating and is subjected to axial tension until detachment of the paint film occurs. The result, i.e., the adhesion strength, is the maximum tensile stress that is possible at the interface.

If, however, a torque is applied about the axis of the stud, the process of detachment reveals the maximum shear stress that can be attained at the interface, thus also leading to a characteristic measure of adhesion.

It has been shown⁴ that the values of adhesion strength obtained from either method are of the same order of magnitude. However, there is a tendency to obtain results with the torque principle in the case of cohesive failure, but lower results for adhesive failure.

The accuracy with which the tests can be carried out, and the existence of a well-defined mechanical principle for them, must not, however, lead to the idea that the values obtained in this way can be considered to be material constants for the bonding components. There is, instead, an additional influence of several parameters, such as temperature, speed of deformation, and even form and size of the stud.

Also of importance are the rigidity of the test piece and the possibility of securing it for measurement.⁵ As shown in Figure 6.5, for coatings on undeformable substrates, using either clamps at the edge of the support in the vicinity of the attached stud is an adequate means of fastening the test piece. For flexible substrate such as plastics or leather, however, the sandwich principle is recommended.

Since an adhesive is used for fastening the stud firmly at the test area, it is necessary to discuss what type of adhesive would be suitable, especially with regard to avoiding any negative effects of its use. In general, solventless epoxy resin adhesives, cured with polyamines, or the fast-hardening cyanoacrylates, can be used for this purpose. To ensure reliability of the results, the constituents of the adhesive must not interact with the coating in a way that causes complete swelling. Penetration of the coating only to the uppermost layers would be beneficial in terms of bonding strength between adhesive and coating. The wide variety of adhesives, available commercially, ought to make it possible to find the most suitable type.

6.3 Delamination Procedures

There is a certain contrast between the tensile methods, in which stress conditions at the interface are of primary concern, and another group of test methods, in which the delamination effects that sometimes

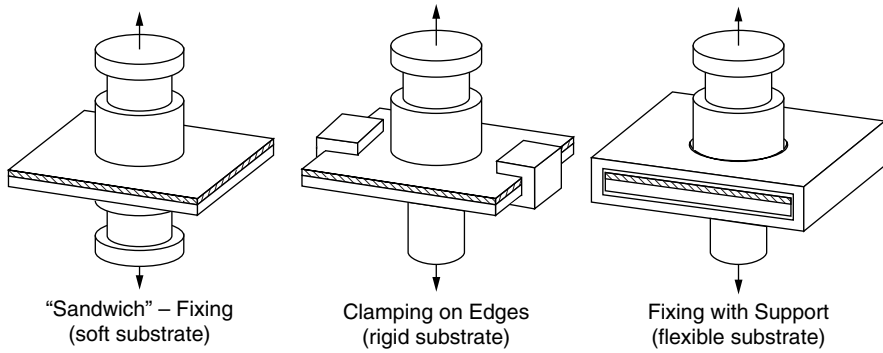

FIGURE 6.5 Formation of specimens for measuring adhesion strength in the pull-off test.

occur in the practical use of the coating are duplicated. In these methods, the test piece is, under idealized conditions, subjected to peeling forces. These forces attack the bond between paint film and substrate either at well-defined lines, so that the coating is detached in strips, or at one point only, thus causing delamination that progresses radially in the form of a blister. Both situations are encountered in practice. Thus, an appropriate method can always be selected according to the actual needs.

Such methods are equivalent to a model of the typical treatment that the coating may undergo. This is the most essential advantage of the methods in practical terms. But they do not, as a rule, lead to results so clearly defined as the maximum stresses at the interface. Only under certain conditions can the values of the stresses be calculated from results of these tests, and this is possible only if all geometrical and dynamical factors, on which the test procedure depends, are available.

As a test result, the work of adhesion is regularly obtained. This quantity is, in any case, useful for comparative purposes (i.e., without reference to a particular absolute adhesion standard). But the work of adhesion also provides some insight into the mechanism of bonding in energetic terms.

6.3.1 Knife-Cutting Method

There are two special methods for testing the degree of adhesion, and the procedures for loosening the bond between paint film and substrate are rather similar (Figure 6.6). In one method, film separation is obtained by means of a sharp knife, pushed along the interface with an exactly measured force.⁶ Although this seems to be a simple test method, the process of detachment is, in fact, complicated, comprising both shear and tensile stresses, which finally cause disbanding of the film. Moreover, a leverage effect

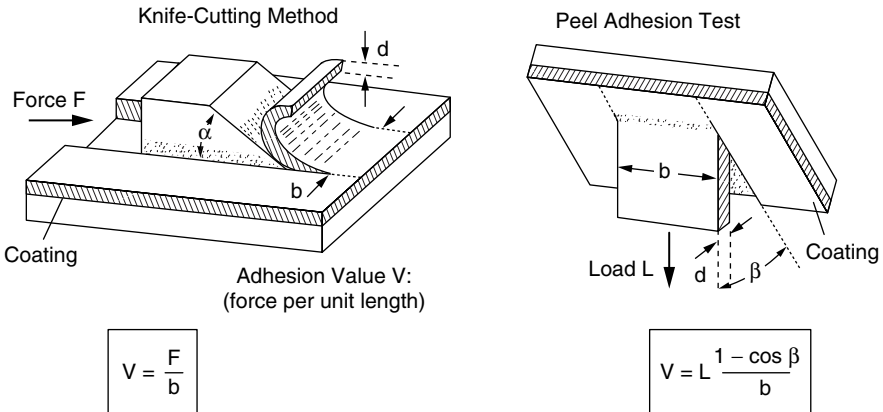

FIGURE 6.6 Devices for measuring adhesion on the basis of delamination procedures.

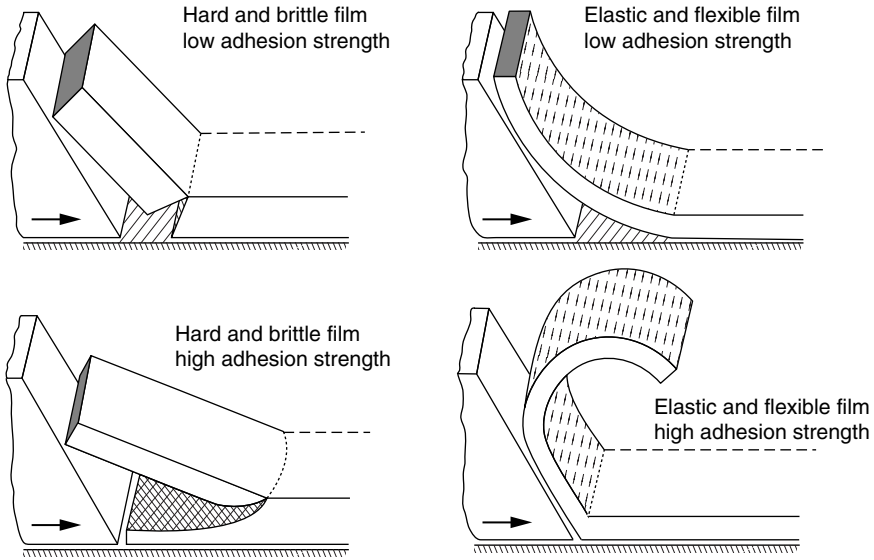

FIGURE 6.7 Influence of mechanical paint film properties on the results of the knife-cutting test.

plays a part in the separation process of the coating, and the intensity of that effect can be characterized by the angle under which the force is acting upon the film.

In the knife-cutting method, the principle of removing the paint film is analogous to the machining of metal in a lathe. A particular system of forces becomes effective here. It is determined by rake angle of the knife, coating thickness, friction between cutting tool and coating as well as substrate, amount of energy stored elastically in the film and energy losses caused by plastic deformation, fracture energy occurring during decomposition within the film, and other effects of minor importance.

To obtain meaningful results, all those parameters should be controlled strictly, or their influence at least estimated as exactly as possible. In many cases, however, the details of the separation process reveal, as indicated in Figure 6.7, how much relevance can be attributed to the various factors.

6.3.2 Peel Test

In practice, a coating often fails not by becoming simultaneously detached over an extended area, but by gradual peeling, for example, starting from a scarcely covered edge, or from a line-shaped damage zone. Thus, it appears sensible to duplicate these conditions in an appropriate test procedure.

The peel test was originally developed for adhesive tape, where its use appears natural and simple. For measuring the adhesion of a coating, however, a strip of adequate width must first be marked on the sample by two parallel cuts of sufficient length. An analysis of the test conditions, as indicated in Figure 6.6, reveals the influence of the angle under which the load is applied.⁷ Thus, in contrast to the first impression that the test procedure ought to be simple, the details of the separation process turn out to be rather complicated.⁸ Detachment of the film occurs under the combined effects of both positive and negative tensile stresses and shear stress. Besides, the viscoelastic character of the coating material must be taken into account, and this feature is also affected by the amount of pigmentation in the film.⁹ As a consequence of the viscoelasticity, the test results depend to a remarkable degree, on the velocity of the detachment process.

Thus, the general experience is that the peel test, when used for measuring adhesion of paint films, can certainly be considered to be a practical method, but it is also understandable that the results obtained cannot be interpreted in terms of the bonding mechanism.

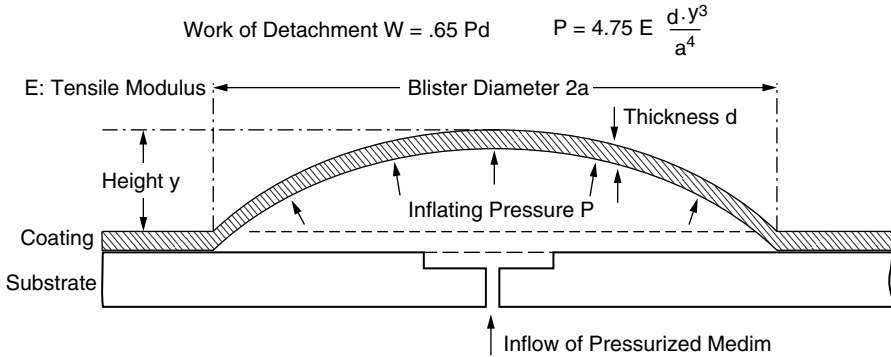

FIGURE 6.8 Blow-off test for measuring adhesion based on determination of blister dimensions and pressure.

6.3.3 Blister Method

Formation of blisters is generally a first sign of deterioration of any coating designed for protection against corrosion. It is therefore sensible to investigate the behavior of such a coating material under conditions that finally may lead to film detachment in the form of blisters.

This test (Figure 6.8) is normally carried out in the following way. First, before the liquid paint is spread over the surface of the sample, a hole is bored into the substrate at the site at which the blister is to occur. The hole is plugged with a material such as Teflon, on which there will be no adhesion during painting, to permit easy removal of the plug after film formation.¹⁰ It is also possible to generate the hole after painting, using spark erosion techniques.

The detachment of the film is initiated, and supported, by providing hydrostatic pressure in the hole, either with a fluid (oil, mercury, etc.) or with pressurized air.¹¹ In any case, the pressure is a primary measure of the progress of the debonding process. To obtain adhesion values, either as maximum stress or as bonding energy (work of adhesion), both height and diameter of the blister must be monitored. An optical system with relatively low magnification can prove sufficient for that purpose.¹² From these geometrical data, together with the tensile modulus of the film and its thickness, a critical pressure value can be calculated. It is pressure that causes the blister to grow, and thus pressure can serve as a basis for determining the adhesion strength.¹³

Preparation of test pieces as well as procedures of measurement are comparatively complicated, but this disadvantage is virtually compensated for by the basic information the test results yield in terms of the mechanism of blister formation.

6.4 Local Debonding Systems

In practice, mechanical damage on the coating often occurs locally, in form of scratches or impact deformation. As a consequence, not only are the appearance properties of the film deteriorated, but its adhesion may be lost as well, if the intensity of the external forces, transferred through the film, is high enough. Idealized conditions for such treatment have become the basis of special adhesion test methods. Prototypes of pertinent devices exist, and their scope of application has been studied in detail. Moreover, the deformation caused by such external loading processes has been analyzed, and theoretical relations are now available for assessing the extent of debonding at the interface.

6.4.1 Scratch Technique

Figure 6.9 illustrates the principle of a test method in which scratch resistance as well as adhesion of the coating can be measured. A loaded stylus is drawn across the film surface. There is obviously a simple relationship between the applied load, of which the intensity can be controlled easily in the balance

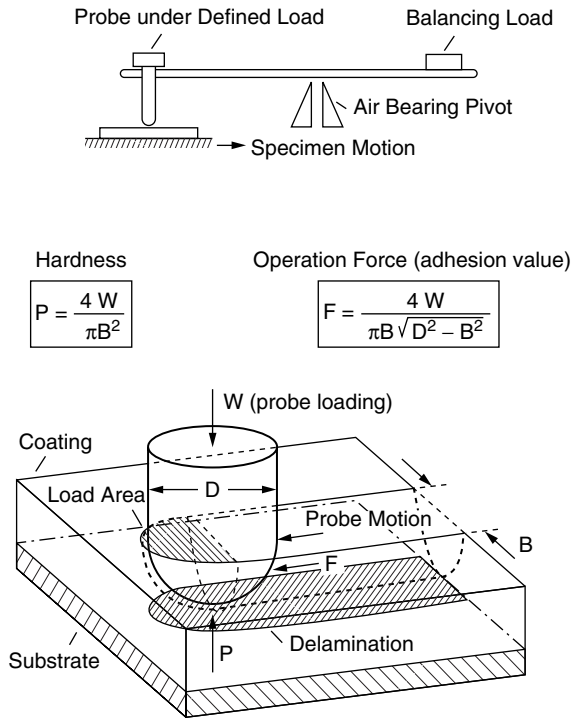

FIGURE 6.9 Scratch technique for determining the bonding of polymer films subjected to local surface forces.

system carrying the stylus, and the shearing force eventually causing detachment of the coating. A critical quantity is the radius at the tip of the tool, and it must be measured with the same accuracy as the width of the contact area generated during the scratching procedure.

It is recommended¹⁴ that the information obtained directly from the test be supplemented by additional data, such as results of surface profile meters or scanning electron microscopes, which provide insight into the details of the scratch topography. Under such provision, even the adhesion values in multilayer systems can be estimated. It can be seen what type of film failure occurs in those systems when they are subjected to scratch loading.

6.4.2 Indentation Debonding

If a needlelike indenter is perpendicularly pressed into the surface of a coating, which is bonded to a virtually undeformable substrate, most of the deformation will occur within the film, but there also will be a certain debonding effect at the interface.

According to that situation, indicated in Figure 6.10, a peeling moment can be calculated, which may serve as a measure of the film's capacity to withstand delamination in the vicinity of the indentation site.¹⁵ It is convenient, especially for thin coatings, to monitor the gradually increasing area of debonding with optical devices capable of leading to an evaluation on the basis of Newton's rings, for instance, with transparent coatings.

It is by no means necessary to restrict the scope of the indentation test to using a needle for penetration of the coating. Indenters of other typical shapes also are used successfully. It has been shown that the best approach for taking into account the boundary conditions at the interface, as a basis for the calculation of adhesion values, is to use a 60° angle cone as an indenter.¹⁶ An essential advantage of the identification test can be seen in the fact that it yields values for the bond strength in absolute terms, as well as information about the durability of the connection between coating and substrate under those specific loading conditions.

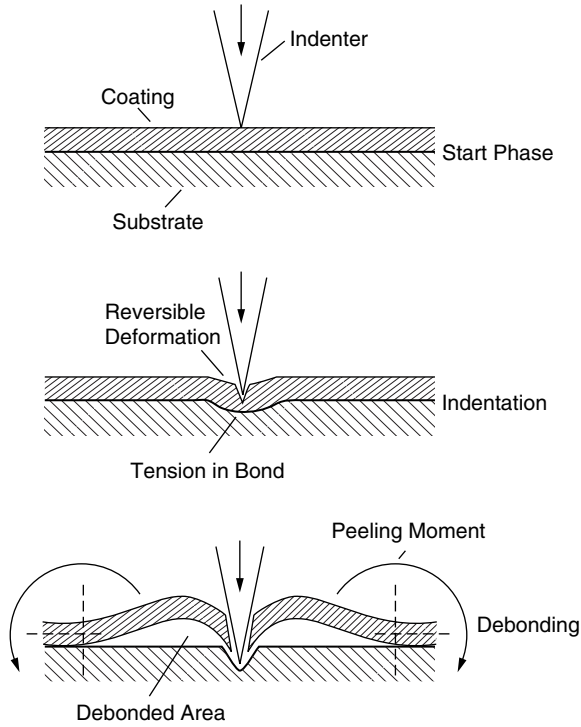

FIGURE 6.10 Principle of the indentation process for measuring adhesion at the polymer– substrate interface.

6.4.3 Impact Tests

Especially for determining the stone-chip resistance of coatings that are supposed to provide efficient protection against corrosion of a metal substrate, the value of adhesion at the interface is of primary interest. The situation encountered in practice can be duplicated, under only slightly idealized conditions, by means of a steel ball impinging on the test piece (Figure 6.11). The transfer of forces through the film

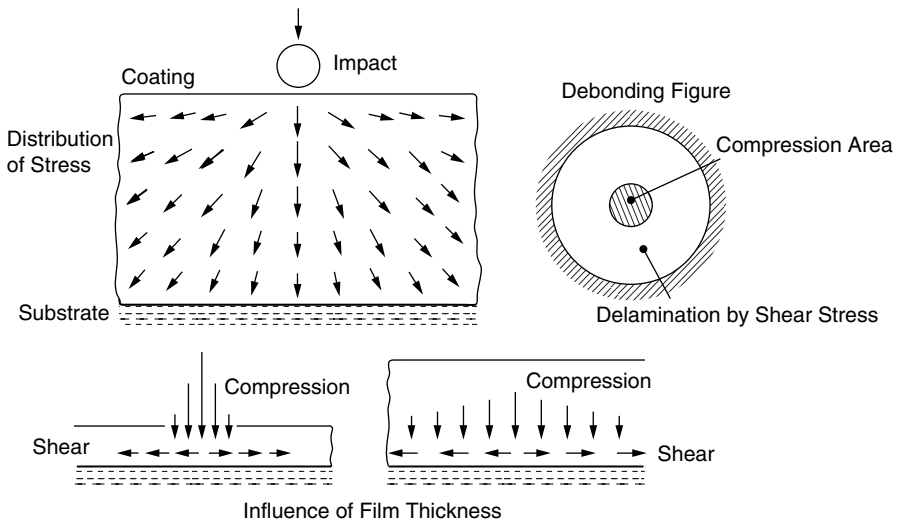

FIGURE 6.11 Information about adhesion on the basis of the circular debonding figure produced by impact loading of the paint film.

is, in a first approximation, equal to the case of static loading; that is, it can be calculated in virtually the same way as for an indentation test.

Thus, in the debonding area, two types of stress are active: negative tensile (i.e., compressive) stress in the center of the circular detachment site, and, still more essential, shear stress in the annular region. The dimensions of the debonding area, mainly the maximum diameter, can serve as a measure of adhesion at the interface, and it is convenient to use either that diameter or, better still, the area of the debonding zone, both as (reciprocal) measures of adhesion. An extended site of separation is thus an indication of a low adhesion level.¹⁷

It is possible, in principle at least, to calculate the value of adhesion in absolute terms, but then some additional parameters must be taken into account. There is first the remarkable influence of film thickness. For a thin film, the detachment area is more concentrated in the region in the vicinity of the axis of impact. In areas with thicker coatings, under the same test conditions, a larger area is affected by the stresses leading to delamination. The details of this relationship can easily be understood on the basis of the particular scheme that is valid for the stress distribution within the film as a whole.

The other parameters for the calculation of adhesion strength are related to the impinging steel ball. Its mass, diameter, and speed — before and after impact — must be known, as well as the (generally very short) time of impact, in which the energy is being transferred into the film.

6.5 Flaw Detection Methods

In practice, it is often necessary to know as fast as possible about any deterioration of the bonding strength between film and substrate; quantitative details of the adhesion values, however, are not required. The occurrence at the interface of any flaws, even those of tiny dimensions, is an event belonging to this category. Thus, tests allowing for identification of the first signs of adhesion failure are of great interest.

Some methods, based on acoustical or thermo-optical principles, have been proposed and, to a considerable degree, tested for that purpose. The unique potential of these test methods, most of them introduced only recently, promises very interesting applications in the future.

6.5.1 Ultrasonic Pulse-Echo System

Monitoring of ultrasonic echoes, according to the time domain principle,¹⁸ is widely used to identify any irregularities in materials that are supposed to be flawless. This method can also be applied to evaluate the quality of bonding between a polymer coating and the substrate, whatever its nature.

According to Figure 6.12, an incident of ultrasound will be partly reflected and transmitted at each interface at the test piece, including the backing. It is the pulse partly transmitted at the interface that

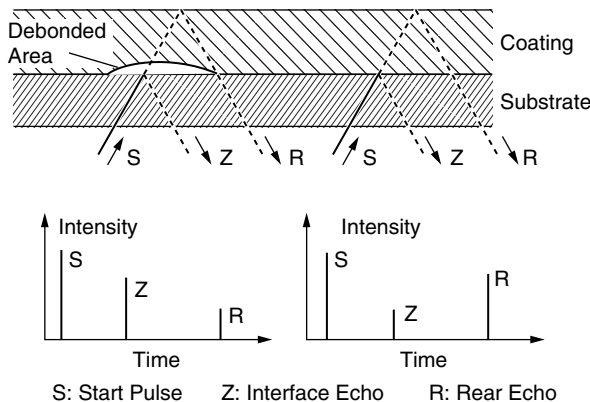

FIGURE 6.12 Ultrasonic pulse-echo technique for determining position and size of adhesion flaws.

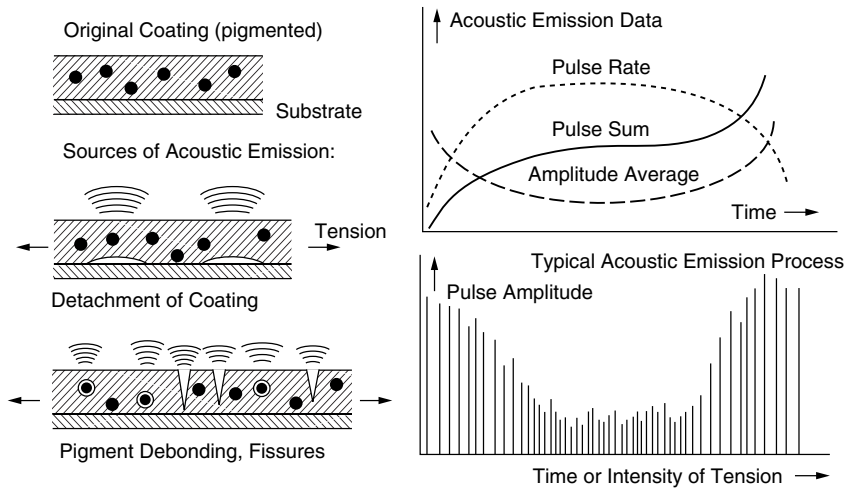

FIGURE 6.13 Application of acoustic emission analysis of monitoring the onset of coating detachment.

then undergoes more or less total reflection at this free surface. The bonding quality is expressed in the relative heights of the pulses.

With an intact bonding at the interface, the amplitude of the pulse reflected there will be fairly low, in contrast to the amplitude of the transmitted pulse that travels through the substrate and is reflected on its free boundary, appearing later at the sensor, accordingly. If a defect is assumed at the interface, containing air or indicating in another way that the joint has been disbanded, the amplitude of the related ultrasonic pulse will increase considerably, owing to the very low acoustic impedance now prevailing at that site. There is thus less intensity available for the transmitted pulse, and its amplitude would then decrease considerably.

The region subjected to that ultrasonic treatment can be restricted to a relatively small size. Consequently, there is a possibility of virtually scanning the test piece, line after line, to identify any sites at which adhesion strength might have been lost. The extent, even the particular shape, of that defective area can be determined in the test procedure.¹⁹

6.5.2 Acoustic Emission Analysis

Since it has been observed, by means of very sensitive acoustical sensors, that any debonding effects within an originally uniform and coherent material are accompanied by a specific burst of (mostly ultrasonic) pulses, this principle has also been proposed for monitoring the behavior of adhesive joints under load.²⁰

Thus, the method can also be applied with slight modifications (Figure 6.13), to examine the extent of debonding phenomena occurring in a coating system on a given substrate, if the whole test piece is subjected to gradual stretching, normally in one dimension.²¹ The acoustical signals obtained are related to individual fracture events in the test system. As a rule, it will be the detachment process of the film that is indicated in this way. Also, however, any separation within the film (e.g., between binder matrix and pigment) could cause acoustic signals, although most probably, of course, on a lower level of intensity.

This possibility, however, together with the knowledge that there may be a wide variety in form and distribution of the acoustic pulse spectrum, elucidates the present situation with this test. It provides for a promising potential in terms of flaw detection in coating systems; nevertheless, a great deal of information is required if the primary results are to be interpreted correctly.

6.5.3 Thermographic Detection of Defects

The main advantage of thermographic methods can be seen in the fact that they yield remote mapping of the distribution of temperature on a surface, whatever the cause may have been. This principle has

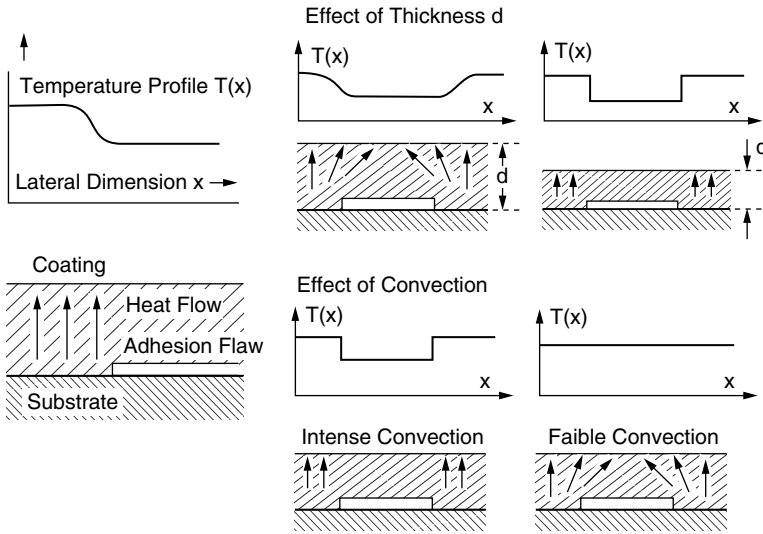

FIGURE 6.14 Thermographic detection of debonding areas by their impedance to heat flow through the substrate–film system.

been applied successfully for the detection of subsurface flaws, which may occur as a consequence of any deterioration in the bonding quality of coating and substrate.²²

As indicated schematically in Figure 6.14, it is the heat flux in the test piece, proceeding toward the surface, that, if there is an obstacle in its way in the form of a flaw or a debonded area, produces more or less pronounced differences in the otherwise uniform temperature on the surface. The shape of the area in which the temperature decreases is made visible at the surface by means of an infrared sensor. It is a rather exact reproduction of the real defect, which would have remained invisible otherwise. The agreement between real shape of debonded area and its “image” on the surface will be better as the distance becomes lower between the position of the flaw and the surface. The situation is similar, on optical grounds, to the formation of a shadow from a distant object.

As a rule of thumb, the linear dimension of the debonded area should be at least twice the distance from the interface to the surface. Under these conditions, a distinct reproduction of the defect on the surface can be expected.

6.6 Outlook

Although adhesion is, in principle, a well-defined quantity for a system consisting of paint film, or adhesive, and its pertinent substrate, there are so many possibilities for practical combinations that it would be unrealistic to look for universal adhesion test systems. On the contrary, the relatively great number of test methods proposed so far is the best proof of the diversity of the means available for tackling the problem of adhesion measurement in practical terms.

In many cases, the selected method will lead to satisfactory results, but it is nevertheless advisable to make it a practice to follow up on the development activities in the field of adhesion testing. Many of the existing methods were proposed when there was a need for a particular reproduction of typical bonding situations. It is thus not unrealistic to expect that the successful methods of today will be supplemented, in the not so distant future, by even more sophisticated methods with accordingly high performance qualities.

References

1. R. J. Good, "Theory of cohesive vs adhesive separation in an adhering system," *J. Adhes.*, 4, 133–154 (1972).
2. International Standard ISO 2409, "Paint and varnishes — Cross-cut test."
3. International Standard ISO 4624, "Paint and varnishes — Pull-off test for adhesion."
4. J. Sickfeld, "Experimental aspects of adhesion testing — An IUPAC study," *J. Oil Color. Chem. Assoc.*, 61, 292–298 (1978).
5. P. C. Hopman, "The direct pull-off test," *J. Oil Color. Chem. Assoc.*, 67, 179–184 (1984).
6. W. K. Asbeck, "The measurement of adhesion in absolute units by knife-cutting methods: The Hesiometer," presented at the 11th FATIPEC Congress, Brussels, 1972, *Congress Book*, pp. P78–P87.
7. A. N. Gent and G. R. Hamed, "Peel mechanics," *J. Adhes.*, 7, 97–95 (1975).
8. A. D. Crocombe and R. D. Adams, "Peel analysis using the finite element method," *J. Adhes.*, 12, 127–139 (1981).
9. P. M. Heertjes and J. de Jong, "The peeling-off of paint film," *J. Oil Color. Chem. Assoc.*, 55, 1096–1106 (1972).
10. A. Elbasir, J. D. Scantlebury, and L. M. Callow, "The adhesion of chlorinated rubber to mild steel using a blister technique," *J. Oil Color. Chem. Assoc.*, 68, 282–284 (1985).
11. H. Dannenberg, "Measurement of adhesion by a blister method," *J. Appl. Polym. Sci.*, 5, 125–134 (1961).
12. L. A. van der Meer-Lerk and P. M. Heertjes, "The influence of pressure on blister growth," *J. Oil Color. Chem. Assoc.*, 64, 30–38 (1981).
13. M. G. Allen and S. D. Senturia, "Analysis of critical debonding pressures of stressed thin films in the blister test," *J. Adhes.*, 25, 303–315 (1988).
14. J. Ahn, K. L. Mittal, and R. H. McQueen, "Hardness and adhesion of filmed structures as determined by the scratch technique," ASTM STP 640. Philadelphia: American Society for Testing and Materials, 1978, pp. 134–157.
15. P. A. Engel and D. D. Roshon, "Indentation-debonding of an adhered surface layer," *J. Adhes.*, 10, 237–253 (1979).
16. H. D. Conway and J. P. R. Thomson, "The determination of bond strength of polymeric films by indentation debonding," *J. Adhes. Sci. Technol.*, 2, 227–236 (1988).
17. U. Zorll, "Testing of the impact resistance of coatings under aspects of deformation energy," presented at the 15th FATIPEC Congress, Amsterdam, 1980. *Congress Book*, Vol. 3, pp. 94–109.
18. R. D. Adams, P. Cawley, and C. C. H. Guyott, "Non-destructive inspection of adhesively-bonded joints," *J. Adhes.*, 21, 279–290 (1987).
19. P. A. Meyer and J. L. Rose, "Modeling concepts for studying ultrasonic wave interaction with adhesive bonds," *J. Adhes.*, 8, 107–120 (1976).
20. H. G. Moslé and B. Wellenkoetter, "Acoustic emission on painted steel sheets," presented at the European Federation of Corrosion Conference on Surface Protection by Organic Coatings, Budapest, 1979. *Proceedings*, 5, pp. 17–33.
21. W. Mielke, "Application of acoustic emission analysis for evaluation of the adhesion of coatings," presented at the 19th FATIPEC Congress, Aachen, 1988. *Congress Book*, pp. 471–486.
22. B. E. Dom, H. E. Evens, and D. M. Torres, "Thermographic detection of polymer/metal adhesion failures," in *Adhesion Aspects of Polymeric Coatings*, K. L. Mittal, Ed. New York: Plenum Press, 1983, pp. 597–621.

7

Coating Calculations

7.1	Introduction	7-1
7.2	Resins	7-1
7.3	Pigments	7-2
7.4	Solvents	7-2
7.5	Additives.....	7-2
7.6	Conventions.....	7-2
7.7	Calculations	7-2
	Formulation Weight • Formulation Volume • Formulation Density • Formulation of “Nonvolatile by Weight” • Formulation “Nonvolatile by Volume” • Pigment to Binder Ratio (Weight) • Pigment Volume Content (Volume)	
7.8	Converting to a 100 Gallon Formulation.....	7-4
7.9	Cost	7-4
7.10	Coverage.....	7-5
7.11	Computer Use.....	7-5
	Bibliography	7-5

Arthur A. Tracton
Consultant

7.1 Introduction

Coatings are defined as mixtures of various materials. The questions arise as to how much of which materials, and how do these things relate. The materials fall into four general categories, as follows:

- Resins
- Pigments
- Solvents
- Additives

7.2 Resins

These are the generally solid, sticky materials that hold the system together. They are also called binders, and when in a solvent, they are the vehicles for the system. They may come as a “single-package” or “two-package” system. Single package is just the liquid resin or the resin in solvent. Two package means that an “A” part was blended with a “B” part to cause a chemical reaction. In both systems, we need to know the amount of solid resin present. This dry material divided by the total of the dry plus the solvent is frequently called a “resin solid.” With the two-package systems, we need to know not only the solids but also the ratio of these solids to form the desired film. This ratio may be designated as a simple ratio of 1 to 1. Or it may be based on 1 or 100, as 0.3 to 1, or 30 parts per hundred, or a total of 100 as 43 to 57. These ratios determine the film properties. We will also need to know the density (weight per unit volume, usually as pounds per gallon) of the resin or vehicle to help calculate volume.

7.3 Pigments

Pigments are the dry materials added to the coating to give it color or resistance properties, camouflaging properties, and the like. Pigments can be divided into many different categories for different purposes. Some materials are primary pigments versus filler pigments. Some materials are organic in nature, and others are inorganic. Properties such as lightfastness, particle size, and specific color are reasons for choice. For calculation purposes, dry density and evaporative material are needed for each pigment.

7.4 Solvents

The materials that permit you to apply the coating in a liquid state are called solvents. Solvents may be organic; they may even be water. They are in the formulation to aid in mixing, viscosity, and application of the coating. After application, they evaporate and leave a dry film. For calculation purposes, the density needs to be known.

7.5 Additives

These are ingredients added in small (<5%) amounts to alter some properties of the coating. They must be included in the calculation, as they have both solids and density factors that must be accounted for.

7.6 Conventions

The relationships among the various ingredients are looked at in the two aspects of weight and volume. Each aspect not only tells of the relationship but also implies some property of the formulation. Experienced formulators may use many of the relationships interchangeably, as they have a deep understanding of the processes. Common practice many years ago was to manufacture paint in 100 gallon batches. Ingredients were then spoken of as “pounds per 100 gallons.” However, if the batch was not 100 gallons, then the ingredients were spoken of as “pounds per gallon.” Consequently, statements such as “it has 100 pounds of pigment already” and “well, lets take it up to 2 pounds” make sense when one understands the practice of interchanging the basis for the number.

The density (weight per unit volume) of material is usually used as pounds per gallon. To convert numbers to a volume measurement (volume per unit weight) or “bulking factor,” divide the density into 1.

$$\text{Bulking factor} = 1/(\text{Density as pounds/gallon})$$

7.7 Calculations

To begin, list the ingredients of the formulation. From the supplier of the material, get the density, the nonvolatile level, and the price of each ingredient. Make a list as shown in [Table 7.1](#). Calculate the bulking factor (gallons/pound). Based on your knowledge, experience, and laboratory testing, you will estimate a rough relationship of ingredients, probably by weight.

7.7.1 Formulation Weight

Add the ingredients you have considered or used in the formulation (530 pounds).

7.7.2 Formulation Volume

Multiply the weight of each ingredient by its bulking factor. This will give the volume of the weight used. Total this column (50.97 gallons).

TABLE 7.1 Paint Formulation Calculations

No.	Material	Constants				Calculations						
		lb/gal	gal/lb	%NV	Cost, \$/lb	Weight	Volume	Dry Weight	Dry Volume	#/100 gal	gal/100 gal	Cost/gal
1	Titanium Dioxide	34.99	0.029	100	\$1.15	100	2.86	100	2.86	196.00	5.6	2.25
2	Phthalocyanine Blue	12.99	0.077	100	\$10.55	50	3.85	50	3.85	98.00	7.5	10.34
3	Acrylic Resin Solution	9.05	0.11	50	\$1.09	300	33.15	150	16.58	588.00	65.0	6.41
4	Toluene	7.55	0.132	0	\$0.28	20	2.65	0	0	39.20	5.2	0.11
5	Butoxyethanol	7.51	0.133	0	\$0.75	30	3.99	0	0	58.80	7.8	0.44
6	Methyl Ethyl Ketone	6.71	0.149	0	\$0.55	30	4.47	0	0	58.80	8.8	0.32
7												
8												
9												
10	Total	X	X	X	X	530	50.97	300	23.29	1038.8	99.9	19.88
						Factor = 1.96						
	On Total Formulation											
a	% Nonvolatile Weight					56.60						
b	% Nonvolatile Volume						45.69					
c	Pigment/Binder Ratio					2 to 3						
d	Pigment Volume Content						28.81					
e	Density, lb/gal					10.4						
f	square feet/gal @ 1 mil dry									733		

7.7.3 Formulation Density

Dividing the formulation weight by the formulation volume gives the density of the formulation (10.4 pounds/gallon).

7.7.4 Formulation of “Nonvolatile by Weight”

Multiply the weight of each ingredient by its nonvolatile content, and total the column (300 pounds). Divide this total by the formulation weight, 530 pounds, to get 0.5660, and multiply by 100 to get 56.6% NV-WT.

7.7.5 Formulation “Nonvolatile by Volume”

Multiply the volume of each ingredient by its nonvolatile content, and total the column (23.29 gallons). Divide this total by the formulation volume (50.97 gallons) to get 0.4569, and multiply by 100 to get 45.69% NV-VOL.

7.7.6 Pigment to Binder Ratio (Weight)

The pigment to binder ratio is a weight relationship, and depending on the formulator’s background, it can be expressed in several mathematical ways:

$$\text{Direct Ratio: pigment to binder} = 1/1$$

$$\text{Percentage: pigment to binder} = \text{pigment/pigment} + \text{binder} = 1/1 + 1 = 0.50$$

$$\text{Parts: Parts of pigment per 1 or 100 parts of resin} = 100/100$$

7.7.7 Pigment Volume Content (Volume)

The standard abbreviation is “PVC,” which should not be interpreted as polyvinyl chloride or any other item. This is a volume relationship expressed as a percentage:

$$\text{Pigment volume content (PVC, \%)} = \left[\frac{\text{Volume of the pigments}}{\text{Volume of the pigments} + \text{Volume of the binder}} \right] \times 100$$

$$\text{PVC} = ((2.86 + 3.85)/23.29) \times 100 = 28.81\%$$

The volume relationship of the pigment to the binder appears to be a more critical number. Studies have shown that there is a point at which the level of pigment in a given system is high enough to cause deterioration of the film produced. This point is termed the “critical pigment volume content” (CPVC).

7.8 Converting to a 100 Gallon Formulation

To convert the initial formulation to a 100 gallon basis, divide the initial volume (50.97 gallons) into 100 gallons to get a factor (1.96). Multiply this factor by the weight of each ingredient in the initial formulation to get pounds in 100 gallons. Multiply the factor by the volume of each ingredient in the initial formulation to get gallons per 100 gallons. If the amount to be manufactured is something other than 100 gallons, divide the desired volume by the initial volume to get a factor, and multiply as above.

7.9 Cost

Multiply the cost (\$/pound) of each ingredient times the weight in the pounds/100 gallon formulation, and divide by 100 to get the cost of the ingredient. Total the column for cost per gallon (\$/gallon).

7.10 Coverage

Frequently, the question arises as to how much a gallon will cover. A 1 gallon volume will cover 1604 square feet at 1 wet mil (0.001 inches), assuming no loss of any type. If the paint were 50% volume solids, this would give a film thickness of 0.5 mil. On the other hand, if I wanted a 2 mil dry film from a 50% volume solids paint, I would have to apply the paint at 4 wet mils per gallon, or 400 square feet per gallon. The standard is 1 mil dry. In the example, $1604 \times 0.4569 = 733$ square feet per gallon.

7.11 Computer Use

With the use of computers, calculating formulations may be done easier and faster. There are commercial computer programs that are available. Using a spreadsheet, a personalized calculation may be designed. [Table 7.2](#) is an example of spreadsheet use. It shows the “constants” of the ingredients, which must be known, and the “calculations.” This approach can be used for either solvent-borne or water-borne systems. Because costs vary widely, the numbers have been left out, but room is provided to use them.

Bibliography

- Norman I. Gaynes, *Formulation of Organic Coatings*, New York: Van Nostrand Company, 1967.
- Charles R. Martens, *Technology of Paints, Varnishes and Lacquers*, Huntington, NY: Robert Krieger Publishing Company, 1968.
- Charles R. Martens, *Waterborne Coatings*, New York: Van Nostrand Reinhold, 1980.
- Paul Nylén and Edward Sunderland, *Modern Surface Coatings*. New York: Wiley-Interscience, 1965.
- Dean H. Parker, *Principles of Surface Coatings Technology*, New York: Wiley-Interscience, 1965.
- H. P. Payne, *Organic Coatings Technology*, New York: John Wiley & Sons, Inc., 1961.

TABLE 7.2 Paint Formulation

No.	Material	Constants						Calculations								
		lb/gal	gal/lb	%NV	% Solvent	% Water	Cost, \$/lb	Weight	Gallons	Dry Wt	Dry Vol	#/100 gal	gal/100#	Cost/100 gal	Water	Solvent
1	Gloss Varnish	8.43	0.118623962	1	0	0	\$0.00	75	8.896797153	75.00	8.896797153	347.76	41.25	\$0.00	0	0
2	Resin @ 40% in BCarbAc	8.71	0.114810563	0.4	0.6	0	\$0.00	25	2.870264064	10.00	1.148105626	115.92	13.31	\$0.00	0	69.55284525
3	Titanium Dioxide	10.5	0.095238095	1	0	0	\$0.00	95	9.047619048	95.00	9.047619048	440.50	41.95	\$0.00	0	0
4	Antiskin Agent	13	0.076923077	1	0	0	\$0.00	0.1	0.007692308	0.10	0.007692308	0.46	0.04	\$0.00	0	0
5	Butyl Carbitol Acetate	10.8	0.092592593	0	1	0	\$0.00	7.4	0.685185185	0.00	0	34.31	3.18	\$0.00	0	34.31273699
6	Cobalt Drier, 6%	17.83	0.05608525	0.5	0.5	0	\$0.00	0.253	0.014189568	0.13	0.007094784	1.17	0.07	\$0.00	0	0.586562328
7	Lead Drier, 12%	8.5	0.117647059	0.5	0.5	0	\$0.00	0.379	0.044588235	0.19	0.022294118	1.76	0.21	\$0.00	0	0.878684278
8										0.00	0	0.00		\$0.00	0	0
9										0.00	0	0.00		\$0.00	0	0
10										0.00	0	0.00		\$0.00	0	0
	Total	X	X	X		X	X	203.132	21.56633556	180.42	19.12960304	941.89	100.00	\$0.00	0	105.3308289
	Total Formulation							factor = 4.63685635				cost/gal				
	lb/gal	9.42												\$0.00		
	% Nonvolatile weight									88.817						
	% Nonvolatile volume								88.701							for loss @\$95\$
	Pigment/Binder Ratio			0.51										\$0.00		
	wt pigment			95												
	wt binder			90												
	Pigment Volume Content			0.22												
	vol pigment			2.87												
	vol binder			10.05												
	vol pigment + binder															
	% Water	0.00														VOC = 1.05 lbs/gal
	% Solvent	11.18														

8

Infrared Spectroscopy of Coatings

8.1	Introduction	8-1
8.2	Principles.....	8-1
8.3	Instrumentation	8-2
	Infrared Microscopy • Imaging	
8.4	Data Collection.....	8-3
	Separation • Transmission Spectra • Attenuated Total Reflectance (ATR) • Infrared Photoacoustic Spectroscopy and Depth Profiling • Other Sampling Methods	
8.5	Data Interpretation	8-5
8.6	Applications	8-6
	References	8-7

Douglas S. Kendall

*National Enforcement
Investigations Center, U.S.
Environmental Protection Agency*

8.1 Introduction

Infrared (IR) spectroscopy is a most useful technique for characterizing coatings, a very cost-effective and efficient means of gathering information. If not the final answer, IR studies can point the way to other information or techniques needed to solve a problem. Ease of sample preparation is one advantage of IR. There are numerous ways of presenting the coating sample to the infrared spectrometer. The wide variety of sampling accessories or attachments, which can easily be swapped in and out of most spectrometers, enables the study of liquids and solids under a wide range of conditions. There is large body of literature on infrared methodology,^{1,2,3} and there are extensive collections of reference spectra available. Almost all components of coatings can be identified by IR; it is especially useful for polymers. IR spectroscopy can monitor changes, such as drying, curing, and degradation, which occur to coatings. Quality control of raw materials and process monitoring during coating synthesis and formulation can be done by IR spectroscopy.

Most important to the identification of coatings and the study of their properties is the skill of the analytical scientist. This factor is often overlooked because the trend in analytical instrumentation in recent years has been increasing computer control and automation. Even when these systems are at hand, they have little value without a well-trained and experienced analytical scientist behind them. The individual with a coatings problem or application is well advised to seek the services of an experienced spectroscopist.

8.2 Principles

The atoms of any molecule are continuously vibrating and rotating. The frequencies of these molecular motions are of the same order of magnitude (10^{13} to 10^{14} cycles per second) as those of IR radiation. When the frequency of molecular motion is the same as that of the IR radiation impinging on that

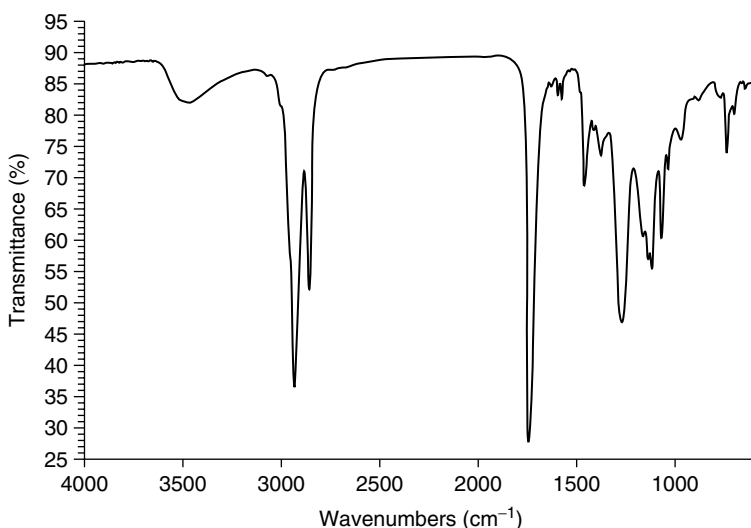

FIGURE 8.1 The infrared spectrum of the alkyd resin and oils from an exterior primer paint. The spectrum can serve as a fingerprint of this material. Many of the absorption bands are characteristic of particular functional groups and can be used to obtain structural information about the sample.

molecule, and when there is a change in dipole moment during that motion, the molecule can absorb the incident radiation. A plot or graph of these absorptions as a function of wavelength or frequency comprises an IR spectrum.

The mid-IR region extends from about 2 to 25 μm (5,000 to 400 cm^{-1}), the most useful range for chemical analysis. The most convenient unit for IR wavelengths is microns or micrometers (μm , 10^{-6} m). It is more common now to express the IR spectrum in terms of wave numbers, for which the units are reciprocal centimeters (cm^{-1}). Wave numbers are proportional to frequency and are calculated (in cm^{-1}) from the wavelength in μm by dividing 10,000 by the wavelength. The near-IR region of the spectrum, occurring at higher frequency (wave numbers) and shorter wavelengths than the mid-IR has found considerable use in recent years, particularly in process control and in monitoring relatively well-defined materials.^{4,5} It is not very useful for identifying complete unknowns and will not be discussed in this chapter.

An IR spectrum such as that shown in Figure 8.1 is a plot of the IR radiation transmitted or absorbed by a sample on the y -axis versus wave numbers or wavelength on the x -axis. As no two substances that absorb IR radiation absorb it at the same frequencies to the same extent, an IR spectrum is a “fingerprint” of a substance useful in differentiating one molecule from another. Moreover, the spectrum of a mixture, excepting certain hydrogen bonding situations or chemical reactions taking place, is simply the sum of the spectra of the individual components comprising the mixture. Figure 8.1 shows the IR spectrum of the alkyd resin and oils from an exterior primer paint. In addition to serving as a fingerprint, an IR spectrum can be interpreted in terms of molecular structure. Functional groups have characteristic absorptions. For instance, carbonyl compounds, such as the polyester in Figure 8.1, have a strong absorption near 1700 wave numbers.

8.3 Instrumentation

IR spectrometers are most often Fourier transform IR spectrometers (FTIR).^{6,7} They are sensitive and versatile instruments controlled by a computer. FTIR spectrometers have a high energy throughput and can produce useful spectra in a matter of seconds. Their wavelength or frequency calibration is accurate. All references in this chapter to IR spectrometers are to FTIR spectrometers.

8.3.1 Infrared Microscopy

IR microspectroscopy is an excellent way to analyze small samples or to examine a small region of a coating.^{8,9,10,11} This might help identify the cause of a failure or blemish, for example. IR microscopes combine a microscope with optics suitable for IR radiation with an IR spectrometer. They can be accessories to IR spectrometers, or they can be stand-alone instruments. A means is provided for the visual observation of the sample so that the analyst can correctly position a small sample or select the desired portion from a larger sample. These means could be eyepieces and lenses for visual observation, or a video camera with suitable optics with images that appear on the monitor of a PC. With some microscopes, the computer can be used to control the microscope, choosing which point, area, or line is to be scanned. Either transmission or reflectance spectra are possible. For transmission measurements, the most common problem is excessive sample thickness. The considerable pressures achieved by a diamond cell can reduce many samples to the thickness required for useful spectra. Objective lenses using the attenuated total reflectance (ATR) technique are also available. Forensic applications, which may require such analyses as the identification of small paint chips, rely heavily on IR microscopy. Many analysts use IR microscopy for most of their solid samples.

8.3.2 Imaging

A growing trend in many areas of chemical analysis is imaging,¹² and this is true in IR spectroscopy. Just as cameras and microscopes produce visible images, it is possible to produce images with IR radiation. With visible images, color is often used to distinguish different parts of the image. An IR image has two-dimensional spatial information, as well as spectral information for each point of the image. By associating different colors with different parts of the spectrum, it is possible to create a visible image that contains information about the IR response of the specimen. For instance, an image showing how a particular ester was distributed across a coating could be produced.

Early IR imaging used a microscope with a stage that moved the sample past the IR objective lens. As each point of the sample passed the lens, an IR spectrum would be obtained. The resulting data would be an array of spectra collected on a gridlike pattern over an area of a sample. A newer development is IR array detectors that can have 256 by 256 or more detectors arrayed together. Each detector in the array can produce a complete spectrum, so a complete image can be produced with simultaneous scanning. This greatly reduces the time required to produce an image and introduces the possibility of kinetic experiments, such as observing the surface of a coating react or change with time. Most imaging detectors are incorporated into IR microscopes, although equipment for macroscopic samples is available. Imaging detectors may not collect data over as wide a range of wavelengths as other detectors, so the suitability of the detector for the analytes of interest should be checked. This field is developing rapidly, so the literature and the major manufacturers, such as Digilab, Nicolet, or Perkin Elmer, should be consulted.

8.4 Data Collection

8.4.1 Separation

Often, it is possible to analyze a coating with minimal preparation. At other times, it is worth the extra effort to separate a coating into its components.¹³ The polymers and resins can be separated from the inorganic components, such as pigments and extenders, on the basis of solubility, as in [Figure 8.1](#). The proper solvent must be chosen that can dissolve the organic components. Heating usually increases the solubility of the organic components. After dissolution, filtration or centrifugation can be used to separate the inorganic pigments and fillers from the dissolved polymers or resins. The dissolved components can be prepared for IR analysis by casting a film on a salt plate or an ATR crystal. Because the solvents can be retained in the cast film, it is recommended that the cast film be dried in an oven before the IR spectrum is scanned. The spectrum of the cast film should be checked for the presence of residual solvents. The inorganic components can be scanned as potassium bromide (KBr) pellets or mineral oil mulls or

can be pressed against an ATR crystal. It may be possible to selectively remove additives from the principal polymers by extraction with the proper solvent.

8.4.2 Transmission Spectra

There are many ways of presenting a sample to an IR spectrometer. For each technique, there is an accessory to the spectrometer that attaches to it or fits in the sample compartment.¹⁴ The choice depends on the nature of the sample, the kind of information desired, and the time available. The classic sampling method is transmission, in which the IR beam passes through the sample, and the absorption of IR radiation as a function of wave number is measured. The intensity of the IR beam passing through the sample is given a ratio to a suitable reference to give the transmittance spectrum (often expressed as percent transmittance). The absorbance is the log of the transmittance and is proportional to the concentration and thickness of the absorbing substance. A computer easily converts between transmittance and absorbance units. Most of the available reference spectra were scanned as transmission spectra. Transmission often requires laborious preparation of solid samples, but it is still an important sampling method for gases and liquids. Liquids can be scanned as a thin layer between two salt plates or in special liquid cells. Solids should be ground to a particle size less than the wavelength of the shortest wavelength used — typically less than 2 μm . Powders can be mixed with potassium bromide, cesium iodide, or other salt, and pressed into a transparent pellet. Alternatively, they can be milled with mineral oil and spread between salt plates. Such transmission spectra are useful for identifying inorganic pigments and extenders.^{15,16} Dissolved materials, including polymers, can be made into a cast film by placing the solution on a salt plate and evaporating the solvent.

8.4.3 Attenuated Total Reflectance (ATR)

ATR, one of the most widely used sampling techniques, uses an accessory easily installed on most IR spectrometers. In ATR, the IR beam is directed inside a crystal, and the sample is placed on the outer surface of the ATR crystal. Total internal reflection occurs unless the sample has an absorption band at a particular frequency. Zinc selenide, germanium, and diamond are common ATR crystal materials. The ATR spectrum is similar, but not identical, to the transmission spectrum, and can be searched against libraries of transmission spectra. ATR is especially useful for surface analyses. Because the impinging IR radiation beam penetrates the surface of the sample pressed against the ATR crystal roughly to the depth of the wavelength of the IR beam, ATR is essentially a technique for examining surfaces. It penetrates surfaces to a depth of about 5 to 10 μm . The depth of penetration depends on the ATR crystal material and other parameters that can sometimes be varied by the experimenter.

Good contact between the sample and the crystal is vital for attaining a useful ATR spectrum. Solids must be firmly pressed against the crystal. Usually there is provision to applying pressure to the sample to improve contact. Even hard materials can yield useful spectra with a diamond crystal, which can sustain high pressures. Liquids, including viscous liquids, can be scanned by ATR. If volatility is a concern, then a cover can be placed over the sample. ATR offers many possibilities for coatings applications, and these have been reviewed.¹⁷ It may be possible to examine a coating without removing it from the substrate by placing it directly on the ATR crystal. By applying the coating to the ATR crystal, changes with time can be observed. The evaporation of solvents, curing reactions, and migration of additives to the surface are some of the possibilities. Films of soluble components can be cast on the ATR crystal. For example, ATR has been used to study polymer blend films.¹⁸

8.4.4 Infrared Photoacoustic Spectroscopy and Depth Profiling

Photoacoustic accessories to IR spectrometers have features that are attractive for coatings applications, including the ability to do depth profiling. This means of obtaining an IR spectrum requires little sample preparation. After the sample is placed in a sealed cell, it is irradiated with a modulated or varying IR beam. Absorption of IR radiation causes the sample to alternately heat and cool. This heating and cooling is transferred to the gas in contact with the sample, causing it to expand and contract. A microphone in

the cell is able to detect the alternating waves of expansion and contraction as sound waves. Wavelengths that are more strongly absorbed will cause more intense acoustic or sound waves, thus leading to a spectrum much like an absorption spectrum in transmission mode.

There are several advantages to using IR photoacoustic spectroscopy to study coatings. It can be used for insoluble or otherwise intractable coatings because the sample has only to fit in the cell. As a surface technique, it lends itself readily to coatings. The application of IR photoacoustic spectroscopy to polymers has been reviewed.^{19,20,21} It is possible to do depth profiling. By varying the conditions under which the IR photoacoustic spectrum is obtained, it is possible to change the depth at which the photoacoustic signal originates. Information on the composition of the coating and the substrate to a depth of tens of microns is obtainable.

Depth profiling is especially informative with step-scanning FTIR photoacoustic spectroscopy.^{22–26} With a step-scanning FTIR spectrometer, the wavelength dependence of the depth information is eliminated. By varying the operating parameters of the step-scanning spectrometer, the sampling depth for the IR spectrum can be varied from about 10 to 50 μm .

8.4.5 Other Sampling Methods

There are additional means of obtaining IR spectra of coatings if the standard methods are impractical. If a coating or a coating component proves to be insoluble, pyrolysis of the sample is a possible approach.²⁷ Pyrolysis equipment is available from a number of vendors, or a test tube can be used. Many types of polymers can be analyzed by IR spectroscopic examination of the pyrolyzate.²⁸ It is necessary to have access to reference spectra of pyrolyzates, as the pyrolysis products often differ from the polymer and the monomers.

Reflectance techniques can be used to examine coatings. A variety of reflectance accessories are available for most IR spectrometers. By comparing the reflectance from a sample to that of a nonabsorbing reference material, it is possible to determine the absorptions due to the sample.^{29,30} Diffuse reflectance and specular reflectance can be used to obtain the spectra of coatings on a variety of substrates. Reflection measurements have been used to study coatings on steel.^{31,32} Diffuse reflectance is useful for forensic samples.³³

8.5 Data Interpretation

Once the IR spectrum is obtained, it must be interpreted,³⁴ a task requiring skill, experience, and the availability of reference spectra. As much as possible, including direct observation, should be learned about the sample and its history. A computer with search software and an electronic database of reference spectra make the task easier.

An IR spectrum is an almost unique fingerprint of a particular molecule or of a coating formulation, characterized by the number, shape, and intensity of absorption bands. This pattern can be compared to a collection of known patterns, either manually or with a computer. Extensive collections of reference spectra are available in both printed and electronic forms. Nicolet Analytical Instruments and the Informatics Division of Bio-Rad offer extensive collections in computer-ready form. Hummel has prepared several excellent collections of IR spectra useful for coatings applications, including polymers and related materials.^{35,36,37} The Federation of Societies for Coatings Technology publishes an excellent book on IR spectroscopy for the coatings industry,¹³ which includes instructional text and excellent reference spectra. The spectra are now available in digital form from Nicolet Analytical Instruments.

Computer searches work best for pure compounds or mixtures that happen to be in the library. Mixtures may not be satisfactorily matched by search software. If a computer search fails to find a good match, then it may be worthwhile to simplify the interpretation by separating the coating into components and scanning each. Even if a computer search fails to find a good match, the presence of group frequencies in IR spectra (explained below) often means that the best matches have functional groups similar to those of the unknown. It is a good idea to carefully inspect the conclusions reached by the software before accepting them as legitimate.

An IR spectrum contains significant structural information besides being a unique fingerprint. IR absorption bands can be divided into characteristic bands and fingerprint bands. The latter are unique to a particular molecule. Characteristic bands or group frequencies are caused by a particular functional group, such as an ester or an amide. These group frequencies are almost independent of the rest of the molecule in which they occur, and they can be used to determine which functional groups are present in a molecule and which are absent. Their slight dependence on the rest of the molecule can be used to gain additional information. For instance, unsaturated and saturated esters have slightly different carbonyl stretching bands. Compilations of group frequencies are available to guide the analyst through interpretation.³⁸ Once the functional groups present in the unknown are identified, and once alternatives have been eliminated, the analysts can search the available reference spectra for compounds or polymers with the same functionality as the unknown.

8.6 Applications

There is an extensive amount of literature on the application of IR spectroscopy to coatings, including a recent review.³⁹ Books on IR include applications to coatings.^{40,41,42} The major IR spectrometer manufacturers, such as Nicolet, Perkin-Elmer, Bio-Rad, and Bomem, have applications laboratories staffed with experienced analysts. Laboratories in the coatings industry have experienced IR spectroscopists. All of these can be sources of valuable help. IR is often used in conjunction with other techniques, including thermal, electrochemical, and other spectroscopic methods, to study coatings.

An important application of IR spectroscopy to coatings is chemical analysis and the determination of the composition of a coating. IR is unique in being able to identify almost the full range of coating components, including volatile solvents, resins and polymers, inorganic and organic pigments, and a wide variety of additives. The use of solid sampling accessories for the analysis of coatings has been reviewed,⁴³ as has the analysis of polyester and alkyd resins.⁴⁴ The use of FTIR in the analysis of coatings and surfaces in packaged foods has been reviewed,⁴⁵ as has the use of FTIR for the analysis of coatings on glass substrates.⁴⁶ Forensic chemists rely on IR, particularly IR microscopy, to identify paint chips and other coatings. Their focus is matching their sample to a particular source, such as an automobile. The diamond anvil cell is useful for forensic analysis.⁴⁷ Identification of coatings and their components can be required in many different contexts. The manufacturer or formulator can use IR to identify contaminants and check the quality of raw materials. Manufacturers use IR to analyze their own products or those of competitors.

IR is very useful for studying changes that occur with coatings. Examples include following polymerization reactions that occur during the production of a coating or after its application.⁴⁸ Other examples include the curing of epoxy-based coatings,⁴⁹ automotive clear coats,⁵⁰ and powder coatings.^{51,52} The stratification of a multicomponent coating has been studied using ATR and step-scanning photoacoustic IR.⁵³ The evaporation of solvents can be monitored. Defects in coatings can be studied.⁵⁴ The degradation of a coating with time, temperature, or adverse conditions can be monitored.^{55,56} The degradation products can be identified and the mode of degradation elucidated. The degradation of polyurethanes and epoxies has been studied by step-scanning photoacoustic FTIR.⁵⁷ The application of IR to ultraviolet durability predictions has been reviewed.⁵⁸ It may be possible to monitor the coating *in situ*. Otherwise, the coating must be applied in such a way that it can be observed by IR. For example, a coating can be applied to an ATR crystal.

IR spectroscopy can be used to study surface phenomenon associated with coatings. The use of IR for surface analysis, including depth profiling, has been reviewed.^{59,60} Examples include the examination of polymers⁶¹ and coated paper.^{62,63} Other surface applications include monitoring acrylate polymerization,⁶⁴ observing silicone additives,⁶⁵ and investigating urethanes.⁶⁶ IR spectroscopy is useful for interfacial studies, investigations of interactions between coatings and substrates, air, liquids, and embedded fibers. Interactions between air and latex films have been studied.⁶⁷ Interfaces⁶⁸ were studied with diffuse reflectance IR.

There are many applications of IR spectroscopy to coatings. Most coatings problems can profit from investigation by IR spectroscopy.

References

1. N. B. Colthup, L. H. Daly, and S. E. Wiberley, *Introduction to Infrared and Raman Spectroscopy*, 3rd ed. New York: Academic Press, 1990.
2. D. N. Kendall, Ed., *Applied Infrared Spectroscopy*. New York: Van Nostrand Reinhold, 1966.
3. A. L. Smith, *Applied Infrared Spectroscopy*. New York: Wiley, 1979.
4. K. A. B. Lee, *Appl. Spectrosc. Rev.*, 28, 231 (1993).
5. D. A. Burns and E. W. Ciurczak, *Handbook of Near-Infrared Analysis*. New York: Marcel Dekker, 2001.
6. P. R. Griffiths and J. A. de Haseth, *Fourier Transform Infrared Spectrometry*. New York: Wiley, 1986.
7. B. C. Smith, *Fundamentals of Fourier Transform Infrared Spectroscopy*. Boca Raton, FL: CRC Press, 1995.
8. H. J. Humecki, Ed., *Practical Guide to Infrared Microspectroscopy*. New York: Marcel Dekker, 1995.
9. J. Chalmers and N. Overall, *Macromol. Symp.*, 94, 33 (1995).
10. P. L. Lang and L. J. Richwine, in *Practical Sampling Techniques in Infrared Analysis*. P. B. Coleman, Ed. Boca Raton, FL: CRC Press, 1993, p. 145.
11. R. G. Messerschmidt and M. A. Harthcock, Eds., *Infrared Microspectroscopy: Theory and Applications*. New York: Marcel Dekker, 1988.
12. W. L. Wolfe, *Introduction to Imaging Spectrometers*. Bellingham, WA: SPIE Optical Engineering Press, 1997.
13. D. R. Brezinski, Ed., *An Infrared Spectroscopy Atlas for the Coatings Industry*, 4th ed. Blue Bell, PA: Federation of Societies for Coating Technology, 1991.
14. P. B. Coleman, Ed., *Practical Sampling Techniques for Infrared Analysis*. Boca Raton, FL: CRC Press, 1993.
15. T. R. Harkins, J. T. Harris, and O. D. Shreve, *Anal. Chem.*, 31, 541 (1959).
16. L. C. Afremov and J. T. Vandeberg, *J. Paint Tech.*, 38, 169 (1966).
17. H. Ishida, *J. Adhes. Sealant Counc.*, 1, 521 (1996).
18. R. Popli and A. M. Dwivedi, *J. Appl. Polym. Sci.*, 37, 2469 (1989).
19. R. M. Dittmar, R. A. Palmer, and R. O. Carter, *Appl. Spectrosc. Rev.*, 29, 171 (1994).
20. M. W. Urban, *Adv. Chem. Ser.*, 236, 645 (1993).
21. J. R. Parker and W. H. Waddell, *J. Elastomers Plast.*, 28, 140 (1996).
22. V. G. Gregoriou and R. Hapanowicz, *Macromol. Symp.*, 119, 101 (1997).
23. R. A. Palmer, *Spectroscopy*, 8, 26 (1993).
24. B. D. Pennington and M. W. Urban, *Polym. Mater. Sci. Eng.*, 75, 3 (1996).
25. K. H. Michaelian, *Appl. Spectrosc.*, 43, 185 (1989).
26. V. G. Gregoriou and S. E. Rodman, *Anal. Chem.*, 74, 2361 (2002).
27. D. L. Harms, *Anal. Chem.*, 25, 1140 (1953).
28. D. O. Hummel, H. J. Duessel, G. Czybulka, N. Wenzel, and G. Holl, *Spectrochim. Acta*, 41A, 279 (1985).
29. M. Milosevic, *Mikrochim. Acta*, 2, 137 (1987).
30. T. Hirschfeld, *Appl. Spectrosc.*, 40, 1082 (1986).
31. N. Tinh, D. P. Bentz, and E. W. Byrd, *Polym. Mater. Sci. Eng.*, 55, 665 (1986).
32. T. Nguyen and E. Byrd, *J. Coat. Technol.*, 59, 39 (1987).
33. E. M. Suzuki and J. A. Brown, *J. Forensic Sci.*, 34, 180 (1989).
34. B. C. Smith, *Infrared Spectral Interpretation: A Systematic Approach*. Boca Raton, FL: CRC Press, 1998.
35. D. O. Hummel and F. Scholl, *Atlas of Polymer and Plastic Analysis, Vol. 3, Additives and Processing Aids*. Weinheim, Germany: VCH Publishers, 1981.
36. D. O. Hummel and F. Scholl, *Atlas of Polymer and Plastic Analysis, Vol. 2, Plastics, Fibers, Rubbers, Resins*. Weinheim, Germany: VCH Publishers, 1988.
37. D. O. Hummel, *Atlas of Polymer and Plastics Analysis: Plastics, Fibres, Rubbers, Resins; Starting and Auxiliary Materials, Degradation Products*. Weinheim, Germany: VCH Publishers, 1989.

38. D. Lin-Vien, N. B. Colthup, W. G. Fateley, and J. G. Grasselli, *The Handbook of Infrared and Raman Characteristic Frequencies of Organic Molecules*. New York: Academic Press, 1991.
39. B. J. Kip, T. Berghmans, P. Palmen, A. van der Pol, M. Huys, H. Hartwig, M. Scheepers, and D. Wienke, *Vib. Spectrosc.*, *24*, 75 (2000).
40. J. R. Ferraro and K. Krishnan, Eds., *Practical Fourier Transform Infrared Spectroscopy: Industrial and Laboratory Chemical Analysis*. New York: Academic Press, 1989.
41. B. Schrader and D. Bougeard, Eds., *Infrared and Raman Spectroscopy: Methods and Applications*. Weinheim, Germany: VCH Publishers, 1995.
42. W. Sueteka and J. T. Yates, *Surface Infrared and Raman Spectroscopy: Methods and Applications*. New York: Plenum Press, 1995.
43. A. M. Millon and J. M. Julian, in *ASTM Spec. Tech. Publ., Anal. Paints Relat. Mater., STP 1119*, 173 (1992).
44. J. K. Haken and P. I. Iddamalagoda, *Prog. Org. Coat.*, *19*, 193 (1991).
45. S. V. Compton, J. R. Powell, and D. A. C. Compton, *Prog. Org. Coat.*, *21*, 297 (1993).
46. R. L. De Rosa and R. A. Condrate, *Glass Researcher*, *9*, 8 (1999).
47. A. R. Cassista and P. M. L. Sandercock, *J. Can. Soc. Forensic Sci.*, *27*, 209 (1994).
48. J. A. Payne, L. F. Francis, and A. V. McCormick, *J. Appl. Polym. Sci.*, *66*, 1267 (1997).
49. G. A. George, G. A. Cash, and L. Rintoul, *Polym. Int.*, *41*, 162 (1996).
50. J. L. Gerlock, C. A. Smith, E. M. Nunez, V. A. Cooper, P. Liscombe, D. R. Cummings, and T. G. Dusibiber, *Adv. Chem. Ser.*, *249*, 335 (1996).
51. A. A. Dias, H. Hartwig, and J. F. G. A. Jansen, *Surf. Coat. Int.*, *83*, 382 (2000).
52. R. J. Dick, K. J. Heater, V. D. McGinniss, W. F. McDonald, and R. E. Russell, *J. Coat. Technol.*, *66*, 23 (1994).
53. M. W. Urban, C. L. Allison, G. L. Johnson, and F. Di Stefano, *Appl. Spectrosc.*, *53*, 1520 (1999).
54. D. J. Skrovaneck, *J. Coat. Technol.*, *61*, 31 (1989).
55. M. L. Mittleman, D. Johnson, and C. A. Wilke, *Trends Polym. Sci.*, *2*, 391 (1994).
56. M. Irigoyen, P. Bartolomeo, F. X. Perrin, E. Aragon, and J. L. Vernet, *Polym. Degradation and Stability*, *74*, 59 (2001).
57. H. Kim and M. W. Urban, *Polymeric Mater. Sci. and Eng.*, *82*, 404 (2000).
58. B. W. Johnson and R. McIntyre, *Prog. Org. Coat.*, *27*, 95 (1996).
59. M. R. Adams, K. Ha, J. Marchesi, J. Yang, and A. Garton, *Adv. Chem. Ser.*, *236*, 33 (1993).
60. L. J. Fina, *Appl. Spectrosc. Rev.*, *29*, 309 (1994).
61. T. Buffeteau, B. Besbat, and D. Eyquem, *Vib. Spectrosc.*, *11*, 29 (1996).
62. N. Dupuy, L. Duponchel, B. Amram, J. P. Huvenne, and P. Legrand, *J. Chemom.*, *8*, 333 (1994).
63. M. W. C. Wahls, E. Kentta, and J. C. Leyte, *Appl. Spectrosc.*, *43*, 214 (2000).
64. J. E. Dietz, B. J. Elliott, and N. A. Peppas, *Macromolecules*, *28*, 5163 (1995).
65. T. A. Thorstenson, J. B. Huang, M. W. Urban, and K. Haubennestel, *Prog. Org. Coat.*, *24*, 341 (1994).
66. B. W. Ludwig and M. W. Urban, *J. Coat. Technol.*, *68*, 93 (1996).
67. E. Kientz and Y. Holl, *Polym. Mater. Sci. Eng.*, *71*, 152 (1994).
68. G. C. Pandey and A. Kumar, *Polym. Test.*, *14*, 309 (1995).

9

Thermal Analysis for Coatings Characterizations

William S. Gilman
Gilman & Associates

9.1	Introduction	9-1
9.2	Characteristics	9-1
9.3	Techniques	9-1
9.4	Applications	9-2
	Bibliography	9-3

9.1 Introduction

The evaluation of substances and finished materials by thermal analysis will be discussed as a tool that the paint chemist can use to help evaluate coating properties. These properties are those that change as a function of temperature.

9.2 Characteristics

Substances change in a characteristic manner as they are heated. Thermal analysis (TA) monitors these changes. TA procedures are generally used to characterize various substances and materials that change chemically or physically as they are heated. These changes in properties as a function of temperature have been used to help characterize the interrelationship of a coating's composition and performance. TA methods or techniques measure changes in properties of materials as they are heated or at times cooled.

A TA evaluation entails subjecting a small sample of from a few milligrams to 100 mg to a programmed change in temperature. The resulting change in property is detected, attenuated, plotted, and measured by a recording device.

The instrumentation consists of an analysis module, a heating or cooling source, a measuring device, and a system for reporting the results, usually as an X-Y plot. A computer is used to program and control the procedure and analyze and store the results.

9.3 Techniques

The techniques of prime importance in coatings' characterization and analysis include differential scanning calorimetry (DSC), differential thermal analysis (DTA), thermogravimetric analysis (TGA), thermomechanical analysis (TMA), and dynamic mechanical analysis (DMA). Each of these will be discussed, with examples of the information derivable from each procedure.

DSC measures the heat flow and temperature associated with chemical transitions and reactions. The difference in heat flow between a sample and a reference material is measured under precisely controlled conditions. It measures heat flow into or out of a sample as an exothermic or endothermic change in energy. Generally, the temperature range of use is -180°C to $+725^{\circ}\text{C}$.

DTA has been replaced by DSC. However, DTA data also address changes in heat flow and measure the evolution or absorbance of energy in relation to an inert reference. The temperature detection is somewhat less accurate than DSC, and hence, it was replaced by DSC where better data are obtainable. It also measures the temperature excursions of a sample in the range of -180°C to $+1600^{\circ}\text{C}$.

TGA measures the change in mass as a function of temperature, time, and atmosphere. Thus, this procedure is limited to applications where a change in mass occurs. Since only information concerning the changes in mass is collected, nothing is revealed about the nature of the transitions. The energy involved, or whether it is absorbed or released, is not detected or indicated. TGA measures only changes in mass, usually in the temperature range of ambient to 1200°C .

TMA measures dimensional changes as a function of temperature and time in materials. Both linear and volumetric changes can be determined. TMA measures sample dimensional changes, generally, in the range of -160°C to $+1200^{\circ}\text{C}$.

Last, DMA is a thermal analysis technique that measures the properties of materials as they are deformed under periodic stress. DMA employs a variable sinusoidal stress application, and the resultant sinusoidal strain is measured. Or, stated differently, DMA is a technique that measures the modulus (stiffness) and damping (energy dissipation) properties of materials as they are deformed under periodic oscillatory stress. DMA detects sample modulus and damping changes in the temperature range of -150°C to $+500^{\circ}\text{C}$.

9.4 Applications

The practical applications associated with each technique are numerous, and it would be impractical even to attempt to list or describe them. Therefore, for each technique of TA that we have mentioned, a brief overview will be made with some specific applications of potential interest to the coating chemist.

The information that can be obtained from DTA and DSC is approximately the same, with the exception that DSC gives quantitative as well as qualitative information. DSC and DTA have been extensively used to study the temperatures and nature of transitions in materials heated under different atmospheres. Oxidation stability of various substances is easily characterized. Evaluations of polymer flammability and analysis of subambient phase transition are often conducted.

Coatings generally possess characteristic transitions, including glass transition (a transition related to changes in specific heat), exothermic reactions caused by physical or chemical reactions such as crystallization or cross-linking reactions, melting, volatilization, dissociation, a phase change, and oxidation or thermal decomposition. DSC with its ability to yield quantitative heats of reaction facilitates the determination of the relative heats of combustion for flame-retardant and untreated materials. The effectiveness of the flame retardant can also be assessed.

Reaction kinetic parameters of chemical reactions are derived from DSC data. Studies by isothermal techniques as well as rising temperature methods are used. These methods use the rate of heat evolution as the measured parameter. The classic epoxy-amine reaction helps model production methods to minimize raw materials and reaction times to obtain a quality product through first determining reaction kinetics. In addition, because aging or oxidation is an exothermic reaction, this technique has been used to study long-term stability of coatings.

The applications of TGA as an analytical tool center around determining changes in sample mass as a function of time and temperature. Both isothermal and nonisothermal methods are used. For coatings analysis, nonvolatiles and thermal stability determinations are usually conducted. However, as in DSC, decomposition kinetics, accelerated aging, and oxidation stability can be conducted.

Unlike DSC, in which heating is done by conduction, TGA heats by convection and irradiation. Therefore, the temperature sensor is located in the vicinity of the sample to obtain a true temperature reading.

Applications involving estimating polymer decomposition, polymer lifetime, distinguishing flame-retardant polymer from nontreated polymer of the same type, and kinetics of drying, have been reported.

For coatings analysis, compositional analysis may assist in determining why performance properties changes have occurred. For example, weight loss curves for materials ostensibly of exactly the composition with identical weight losses behaved differently in a formulation. Upon further examination, it was observed that the weight loss of one occurred at slightly different temperatures and in different modes, indicating differences in materials.

With ever-increasing control on organic volatiles in coatings, TGA can be used for volatile organic content determination.

As with DSC, thermal or long-term degradation stability of coatings based on one resin or another can be conducted as a formulation tool.

Applications of TMA are related to a sample's dimensions as a function of time and temperature. Information, such as the compatibility of coating and substrate, performance of an elastomer in a harsh environment, and the adhesion of one material to another, such as multilayered wrapper or baked on coating on a metal substrate, can be obtained.

The direct application of TMA in coatings technology is found in dilatometry, or the determination of the coefficient of thermal expansion. It is particularly useful in determining if two dissimilar coatings can adhere to each other.

The applications of DMA provide information about transition temperatures, curing phenomena, and mechanical properties. These properties include impact resistance and even sound absorption. The technique measures the properties of materials as they are deformed under periodic stress. Another way to state DMA testing is that it measures the viscoelastic response of a material under periodic load.

Applications range from viscoelastic measurements to kinetics of cross-linking. Modulus values, such as flex, Young's, and shear provide information on a material's stiffness, while mechanical damping correlates with the amount of energy dissipated as heat during deformation.

In coating technology, DMA is applicable in the study of film properties, such as the cure process and film formation. Various properties around the glass transition point may be studied. For example, in thermoplastic materials, increasing rubbery state modulus usually means increasing molecular weight. In thermosets, increasing rubbery state modulus values indicate higher cross-link density.

TA is constantly undergoing improvements in order to obtain faster, more reliable, and new information. For example, in most TGA decomposition measurements, the heating rate is maintained constant over the decomposition range, self-compensating for internal cooling. Devices are available that will detect both TGA and DSC data on the same sample simultaneously.

Maximum resolution TGA by rate adjustment addresses weight losses occurring in overlapping temperature regions. The overlapping can be seen using the first derivative of the TGA signal.

TA, such as the techniques already mentioned, can be coupled to a mass spectrometer or infrared spectrometer to analyze the effluent output of the TA instrument.

Modulated DSC is an innovation with increased sensitivity, higher resolution, more complete analysis, and easy data interpretation.

DMA is now available with multiple modes of degradation, including single and dual cantilever, three-point bend, shear sandwich, compression, and tension. Frequency multiplexing of 0.01 to 200 Hz is provided.

We have attempted to describe the vast capabilities of TA. This technology is at its best when more than one instrument is used on a research or production problem. In combination, these devices can supply insight into relationships between formulations, processing, and performance of coatings.

Bibliography

- Blain, Roger, "A faster approach to obtaining kinetic parameters," *American Laboratory*, January 1998, p. 21.
- Cassel, Bruce, et al., "Rapid DSC determination of polymer crystallinity," *American Laboratory*, January 1998, p. 24.

- Colborn, Robert, *Modern Science and Technology*. Princeton, NJ: Van Nostrand, 1965.
- Foreman, Jon, "Dynamic mechanical analysis of polymers," *American Laboratory*, January 1997, p. 21.
- Hassel, Robert L., "Evaluation of polymer flammability by thermal analysis," *American Laboratory*, January 1997.
- Hassel, Robert L., *Using Temperature to Control Quality*, Second Quarter 1991 P1 Quality. Hitchcock, 1991.
- Hassel, Robert L., "Thermomechanical analysis instrumentation for characterization of materials," *American Laboratory*, January 1991.
- Kelsey, Mark, et al., "Complete thermogravimetric analysis," *American Laboratory*, January 1997, p. 17.
- Neag, C. Michael, *Coatings Characterizations by Thermal Analyses*. ASTM Manual 17. West Conshohocken, PA: American Society for Testing and Materials, 1995.
- Park, Chang-Hwan, et al., "Syntheses and characterizations of two component polyurethane flame retardant coatings using 2,4dichlor modified polyester," *J. Coat. Technol.*, December 1997, p. 21.
- Reading, Micheal, et al., "Thermal analysis for the 21st century," *American Laboratory*, January 1998, p. 13.
- Riesen, Rudolf, "Maximum resolution in TGA by rate adjustment," *American Laboratory*, January 1998, p. 18.
- TA Instruments Company, Thermal Analysis Application briefs available from TA Instruments Company, New Castle, Delaware: TA-8A, Thermal Solutions — Long Term Stability Testing of Printing Inks by DSC; TA-73, A Review of DSC Kinetics Methods; TA-75, Decomposition Kinetics Using TGA; TA-121, Oxidation Stability of Polyethylene Terephthalate; TA-123, Determination of Polymer Crystallinity by DSC; TA-125, Estimation of Polymer Lifetime by TGA Decomposition Kinetics; TA-134, Kinetics of Drying by TGA; and TA-135, Use of TGA to Distinguish Flame-Retardant Polymers from Standard Polymers.

10

Color Measurement for the Coatings Industry

Harold Van Aken

GretagMacbeth

Bibliography10-2

Color is the most important appearance of coatings for their formulation, application, or inspection. Color is also the most subjective parameter to characterize visually, and characterization is often attempted under uncontrolled conditions that result in poor color judgement. Proper viewing conditions require controlled lighting in a viewing booth where the different types of light, such as simulated daylight, tungsten, and fluorescent light sources, can be used for evaluation. Visual evaluation always requires a physical standard for comparison because the “color memory” of the brain is quite poor without one, but very good when two samples are compared beside each other. Even when proper viewing conditions are used, it is often difficult to determine the direction and intensity of color difference between two samples. This process requires a trained colorist to make the evaluation.

A more accurate and consistent approach to evaluate color difference is the use of a color measurement instrument. The two types of instruments that can be used for this purpose are colorimeters and spectrophotometers. A colorimeter uses optical filters to simulate the color response of the eye, and a spectrophotometer breaks the visible spectrum into intervals that mathematically simulate the color response of the eye. The advantage of using spectrophotometers to determine color difference is in their accuracy, stability, and ability to simulate various light sources. Spectrophotometer cost and complexity of operation are greatly reduced on new versions of the instruments.

There are three different technologies that are used in modern industrial spectrophotometers: interference filters, gratings, and light-emitting diodes (LEDs). Interference filters require a filter for each wavelength measured and usually have 16 or 31 filters depending on the resolution required. Grating-based instruments have diode arrays of 20 to 256 elements to provide higher resolution for applications that require it. The advantage of interference filters is in their simplicity of operation and mechanical ruggedness. However, they are difficult to make consistent and deteriorate over time. High-performance instruments usually have gratings that give more resolution and better consistency, but they are usually more expensive and complex to build and calibrate. A new market entrant for spectrophotometers is based on LEDs of different illumination colors. Up to nine separate color LEDs are now available to cover most of the visible spectrum. The instruments operate by illuminating one LED at a time while measuring the reflected light. The advantage is that they can be made very small and cost less to manufacture. The disadvantages are reduced accuracy and stability, but the technology is improving with the advent of newer LEDs with better methods for compensation.

There are several different measurement geometries: sphere, 45/0, and multiangle. A sphere instrument illuminates a sample from all directions and views the sample at near normal or perpendicular. The 45/0 illuminates the sample at 45 degrees from all directions and views the sample normal. It is also possible to illuminate at 0 and view at 45. The multiangle approach illuminates at multiple angles and views at a fixed angle. It is also possible to illuminate at a fixed angle and view at multiple angles.

The use of proper geometry is important for color formulation or color inspection. Color formulation with sphere geometry eliminates the need to characterize the gloss and mathematically removes the gloss that is independent from the color formulation. Color inspection usually requires the instrument to have agreement with visual methods. A 45/0 instrument will give better correlation to visual assessment because it better approximates the conditions in a viewing booth. A sphere instrument with a specular exclusion port can eliminate sample high gloss to give good visual correlation but has difficulties with semigloss samples. The assessment can yield misleading information. This is very important when trying to match a coating to a plastic molded part.

Effect pigments such as metallic, pearlescent, and interference materials require multiple angles of illumination and viewing to characterize color at different angles. Multiangle instruments or goniospectrophotometers are available to measure three to five separate angles. A minimum of three angles are usually required to characterize effect pigments: (1) the near specular at 15 to 25 degrees from gloss, (2) 45/0, and (3) far from gloss of 75 to 110 degrees.

Consideration of the sample type to be measured should determine the variety of spectrophotometer to use. If samples are large and cannot be brought to the instrument, the instrument needs to be a portable. There are high-performance portable instruments for each geometry, but consideration should be given to the correlation to laboratory instruments because the communication of the measurements to a color lab is often required. If very small samples such as paint chips or small color bars are measured, the measurement aperture needs to be small. If the sample is nonuniform, the aperture should be as large as possible. Many instruments have changeable apertures that can be used for both samples. Fluorescent coatings require a spectrophotometer with a carefully controlled illumination source that is usually specified as daylight. Tungsten does not have the necessary ultraviolet and cannot be used as a good daylight simulator. However, pulsed xenon is a very good daylight simulator and can be adjusted in some instruments to match the spectrum of natural daylight exactly.

The required tolerances for color measurement are one of the most important considerations when selecting a color measurement instrument. If the comparison is always to a physical standard, and the formula is the same, a colorimeter can be sufficient. When high accuracy is needed for producing coatings in different locations throughout the world using numerical standards, only the very high-end instruments will be capable of results within acceptable visual agreement.

Bibliography

- ASTM Standards on Color and Appearance Measurement*, 4th ed. Philadelphia, PA: ASTM, 1994.
- GretagMacbeth, *Fundamentals of Color and Appearance*. New Windsor, NY: GretagMacbeth, 1997.
- Judd, D. B. and Wyszecki, G., Eds., *Color in Business, Science, and Industry*, 2nd ed. New York: John Wiley, 1987.
- Schunn, Anni Berger, *Practical Color Measurement, A Primer for the Beginner, A Reminder for the Expert*. New York: John Wiley, 1994.

11

The Use of X-ray Fluorescence for Coat Weight Determinations

11.1	Introduction	11-1
11.2	Technique.....	11-1
11.3	Method.....	11-2
11.4	Accuracy.....	11-3
11.5	Repeatability and Reproducibility.....	11-3
11.6	Conclusion	11-5

Wayne E. Mozer
Oxford Analytical, Inc.

11.1 Introduction

The technique of elemental analysis by x-ray fluorescence (XRF) has been applied to the quality control of coating weights at the plant level. Measurements by nonlaboratory personnel provide precise and rapid analytical data on the amount and uniformity of the applied coating. XRF has proved to be an effective means of determining silicone coating weights on paper and film, titanium dioxide loading in paper, and silver on film.

11.2 Technique

XRF is a rapid, nondestructive, and comparative technique for the quantitative determination of elements in a variety of matrices. XRF units come in a variety of packages; however, the type of unit most prevalent in the coating industry is described in this chapter.

The XRF benchtop analyzer makes use of a low level radioisotope placed in close proximity to the sample. The primary x-rays emitted from the excitation source strike the sample, and fluorescence of secondary x-rays occurs. These secondary x-rays have specific energies that are characteristic of the elements in the sample and are independent of chemical or physical state. These x-rays are detected in a gas-filled counter that outputs a series of pulses, the amplitudes of which are proportional to the energy of the incident radiation. The number of pulses from silicon x-rays, for example is proportional to the silicone coat weight of the sample. Because the technique is nondestructive, the sample is reusable for further analysis at any time.

To ensure optimum excitation, alternate radioisotopes may be necessary for different applications. For silicone coatings and titanium dioxide in paper, an iron-55 (Fe-55) source is used. Fe-55 x-rays are soft (low energy) and do not penetrate far into a sample. For silver on film, a more energetic americium-241 source has been used.

Placing samples just a few millimeters from the excitation source enables high sensitivities to be obtained. Irradiation of the sample is more efficient the closer the sample is brought to the source. In the case of low energy x-rays, such as silicon, which are easily absorbed by the atmosphere, a helium purge should be used. With optimum sample irradiation and helium purging when necessary, measurements within 2 minutes of counting time are typical for most samples.

Calibration curves for different elements and materials can be stored directly in the instrument and are available for recall. Curves are established by measuring a set of known samples or standards of the same material. Since XRF is a comparative technique, subsequent analyses are only as good as the quality of the calibration standards supplied.

The total accumulated intensity is actually a combination of signals from the analyte element and from the matrix in the form of background. Background intensities may vary depending on the thickness or the basis weight of the material. These differences may be determined by measuring uncoated or blank samples that are automatically incorporated into the calibration.

11.3 Method

Three procedural steps must precede analysis. First, spectrum scan helps to set up various calibration parameters. Next a calibration is established. Almost all the time the instrument is in use, it is dedicated to analysis of production samples. Typically, spectrum scans are performed on representative standards to identify the occurrence of elemental peaks of interest in the spectrum, as illustrated in Figure 11.1. The scan is a qualitative tool and will show the presence of any potential interfacing element. For example, an Fe-55 source will excite the following range of elements in the periodic scale: aluminum to vanadium and zirconium to cerium. With the proper combination of sources, it is theoretically possible to measure from aluminum to uranium. Once any interference has been recognized by a spectrum scan, a calibration

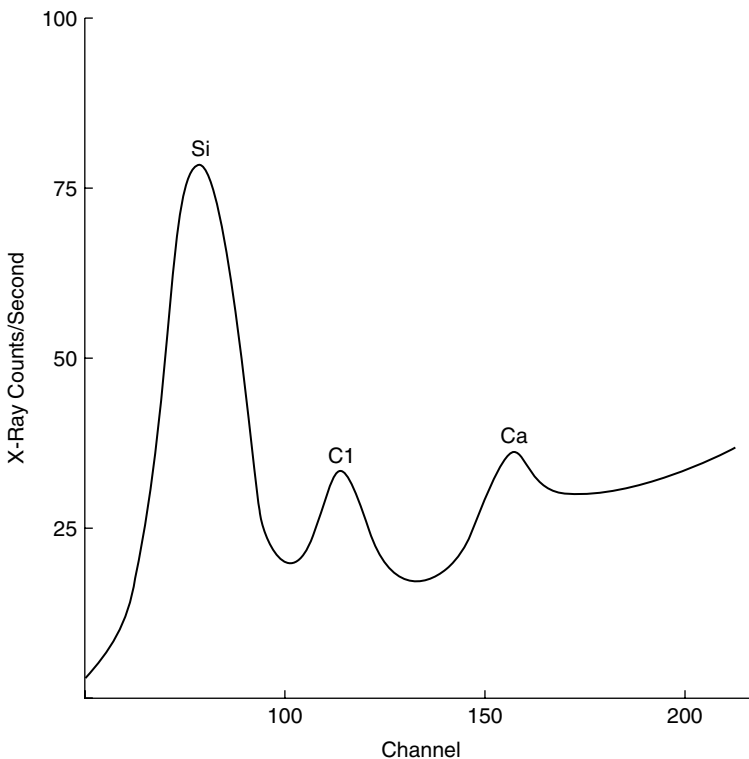

FIGURE 11.1 Spectra scan of silicone coatings on super calendar craft paper.

TABLE 11.1 Typical Results for a Silicone-on-Paper Calibration^a

Sample	Given Concentration (g/m ²)	X-ray Concentration (g/m ²)	Error
1	0.33	0.34	0.01
2	0.41	0.41	0.00
3	0.54	0.52	-0.02
4	0.62	0.62	0.00
5	0.70	0.72	0.02
6	1.50	1.50	0.00

^a Standard error = 0.013 g/m².

may be established. A sample is prepared by cutting a disk and placing it onto a nickel-coated paper holder. The holder ensures that the sample will be held as flat as possible because an uneven surface will introduce errors in reproducibility, caused by scattering and vacancies at the incident surface. Table 11.1 gives a typical calibration for silicon coat weights.

Once a calibration has been established, two samples are selected that bracket the operational range of the samples measured. These samples will then be used to correct for changes in instrumental performance with time. The measurement of these two standards and of an uncoated sample for background correction purposes is a push-button procedure. Termed restandardization is performed once per shift. Analyses may then be performed: an operator simply cuts a sample to be analyzed, inserts it into the instrument, and initiates the measurement. Within 23 minutes, the instrument will determine the concentration of the element of interest, both printing and displaying the results.

11.4 Accuracy

To ensure optimum accuracy, it is important to be aware of three sources of errors: suppliers of coating material, background changes, and interferences. It has been recognized, although not explained, that silicones of different suppliers give different sensitivities. When different silicones are analyzed on the same basis weight paper, lines with different slopes are obtained (Figure 11.2). Thus, to avoid this source of error, separate calibrations are established for each supplier of silicone. Second, correction for changes in background will help reduce error.

Figure 11.3 illustrates two sets of standards of the same silicone on supercalendar kraft prepared on different dates. Quite evidently, the samples give the same slopes, they are offset. The analyzer will correct for this background change by having the operator insert an uncoated sample from the lot of paper to be coated. Thus, all subsequent analyses will be corrected for the apparent background change.

The final source of error is the presence of another material in high concentrations. Examples include silicone coatings on polyvinyl chloride (PVC) or titanium dioxide filled films. As the levels in these films change, the effect on the background for the silicon region of the spectrum will change. Thus, there will be a raising or a lowering of the apparent silicone coat weight for that film sample. This type of interference is easily corrected for by software that can be built into the analyzer. The interferences are recognized by using the spectrum scan and are automatically compensated for during calibration.

11.5 Repeatability and Reproducibility

Repeatability in terms of precision of measurement is a statistical function determining the variability of repeat measurements on the accumulated intensity and x-ray counts. Since an iron-55 source excites titanium x-rays more efficiently than silicon x-rays, it follows that sensitivities for titania coatings are higher, and therefore, measurements are more precise. The precision may always be improved by increasing the coating time, but this does not always result in substantial improvements in accuracy. Typically, for silicone coatings, reported standard deviations correspond to ± 0.01 g per square meter of silicone.

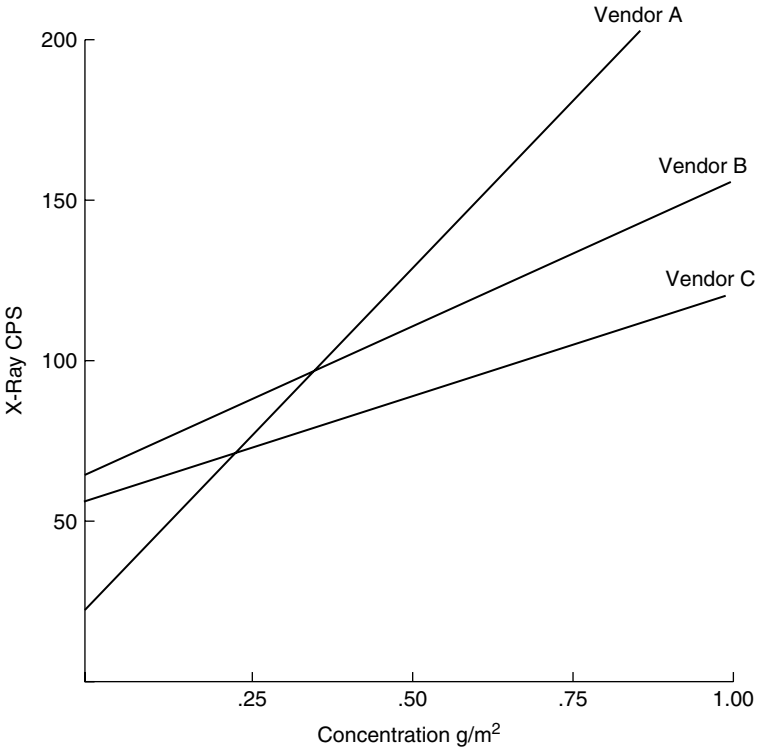

FIGURE 11.2 Differences in sensitivities in products from different suppliers of silicone.

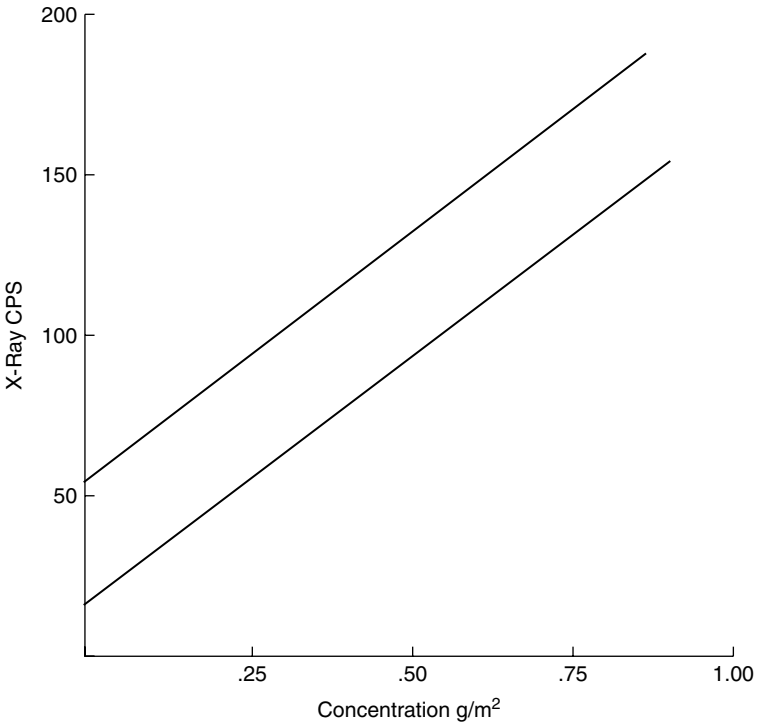

FIGURE 11.3 Differences in paper backings.

11.6 Conclusion

On-site XRF determinations are rapid enough and precise enough for effective quality control programs for elemental determinations on a variety of substrates. The use of XRF is not limited to measuring coatings; it is flexible enough to measure related products, such as tin, platinum, and rhodium catalysts, and other solutions.

12

Sunlight, Ultraviolet, and Accelerated Weathering

12.1	Introduction	12-1
12.2	Sunlight	12-1
	Variability of Sunlight	
12.3	Accelerated Light Sources Compared to Sunlight	12-2
	The Importance of Short-Wavelength Cutoff	
12.4	Arc-Type Light Sources.....	12-4
	Enclosed Carbon Arc (ASTM G 153) • Sunshine Carbon Arc (Open Flame Carbon Arc: ASTM G 152) • Xenon Arc (ASTM G 155)	
12.5	Fluorescent UV Lamps	12-7
	FS-40 Lamps (F40-UVB) (ASTM G 154) • UVB-313 Lamp (ASTM G 154) • UVA-340 Lamp (ASTM G 154)	
12.6	Conclusions	12-9
	Acknowledgments.....	12-9
	References.....	12-10

Patrick Brennan
Q-Panel Lab Products

Carol Fedor
Q-Panel Lab Products

12.1 Introduction

Sunlight is an important cause of damage to coatings. Short-wavelength ultraviolet (UV) light has long been recognized as being responsible for most of this damage.¹

Accelerated weathering testers use a wide variety of light sources to simulate sunlight and the damage that it causes. Comparative spectroradiometric measurements of sunlight and laboratory testers of various types show a wide variety of UV spectra. These measurements highlight the advantages and disadvantages of the commonly used accelerated light sources: enclosed carbon arc, sunshine carbon arc, xenon arc, and fluorescent UV. The measurements suggest recommendations for the use of different light sources for different applications.

12.2 Sunlight

The electromagnetic energy from sunlight is normally divided into ultraviolet light, visible light, and infrared energy. [Figure 12.1](#) shows the spectral energy distribution (SED) of noon midsummer sunlight. Infrared energy (not shown) consists of wavelengths longer than the visible red wavelengths and starts above 760 nanometers (nm). Visible light is defined as radiation between 400 and 760 nm. Ultraviolet light consists of radiation below 400 nm. The International Commission of illumination (CIE) further

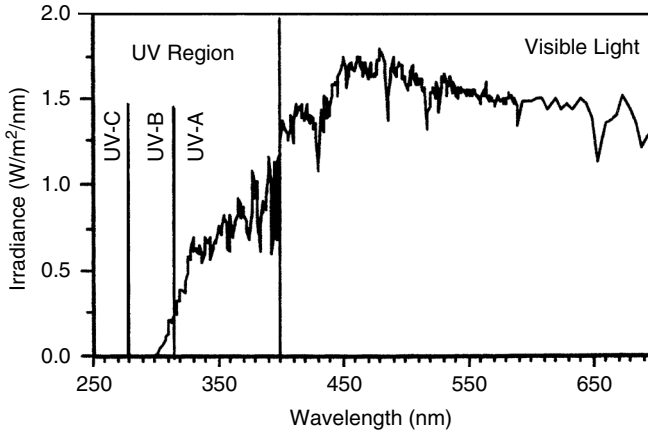

FIGURE 12.1 The sunlight spectrum.

TABLE 12.1 Wavelength Regions of the UV

Region	Wavelength (nm)	Characteristics
UV-A	400–315	Causes polymer damage
UV-B	315–280	Includes the shortest wavelengths found at the earth's surface; responsible for severe polymer damage; absorbed by window glass
UV-C	280–100	Found only in outer space; filtered out by earth's atmosphere; germicidal

Source: From D. Grossman, "Know your enemy: The weather," *J. Vinyl Technol.*, 3, 1 (1981).³

subdivides the UV portion of the spectrum² into UV-A, UV-B, and UV-C as shown in Figure 12.1. The effects of the various UV wavelength regions are summarized in Table 12.1.

12.2.1 Variability of Sunlight

Because UV is easily filtered by air masses, cloud cover, pollution, and other factors, the amount and spectrum of natural UV exposure is extremely variable. Figure 12.2 compares the UV regions of sunlight, measured at Cleveland, Ohio, at noon on:

- The summer solstice
- The winter solstice
- The spring equinox

These measurements are in essential agreement with data reported by other investigators.⁴ Because the sun is lower in the sky during the winter months, it is filtered through a greater air mass. This creates two important differences between summer and winter sunlight — changes in the intensity of the light and the spectrum. Most important, much of the damaging, short-wavelength UV light is filtered out during winter. For example, the intensity of UV at 320 nm changes from about eight to one from summer to winter. In addition, the short-wavelength solar cutoff shifts from about 295 nm in summer to about 310 nm in winter. Consequently, materials sensitive to UV below 320 nm would degrade only slightly, if at all, during the winter months.

12.3 Accelerated Light Sources Compared to Sunlight

The following discussion of accelerated weathering light sources is limited to the questions of UV spectrum. It does not address problems of light stability, the effects of moisture and humidity, the effects

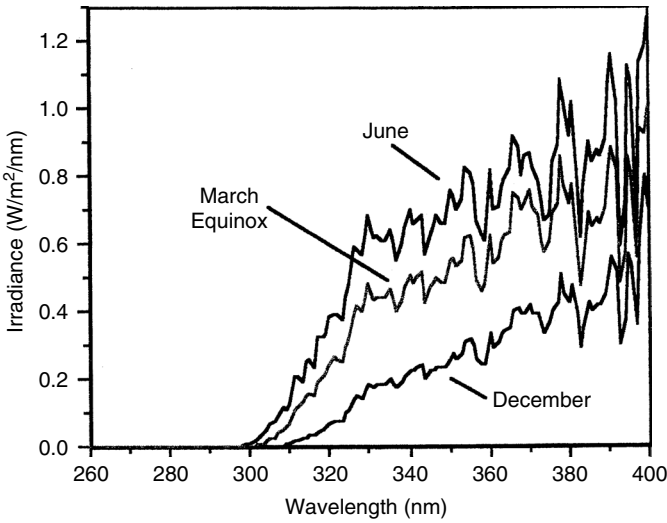

FIGURE 12.2 Seasonal variation of sunlight UV.

of cycles, or the reproducibility of results. For simulations of direct sunlight, artificial light sources should be compared to what we call the “solar maximum” condition: global, noon sunlight, on the summer solstice, at normal incidence. The solar maximum is the most severe condition met in outdoor service, and, as such, it controls which materials will fail. It is misleading to compare light sources against “average optimum sunlight,” which is simply an average of the much less damaging March 21 and September 21 equinox readings. In this chapter, graphs labeled “sunlight” refer to the solar maximum: noon, global, midsummer sunlight. Despite the inherent variability of solar UV, our measurements show surprisingly little variation in the solar maximum at different locations. Figure 12.3 shows measurements of the solar maximum at three widely varied locations.

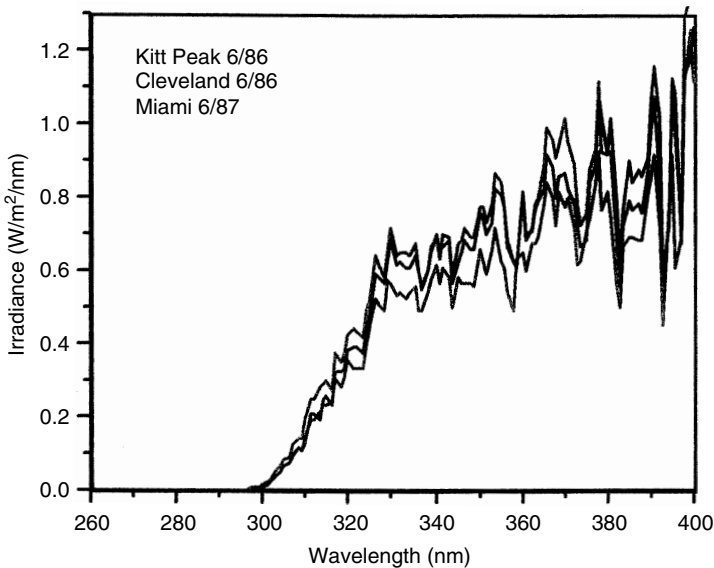

FIGURE 12.3 Solar maximum at three locations.

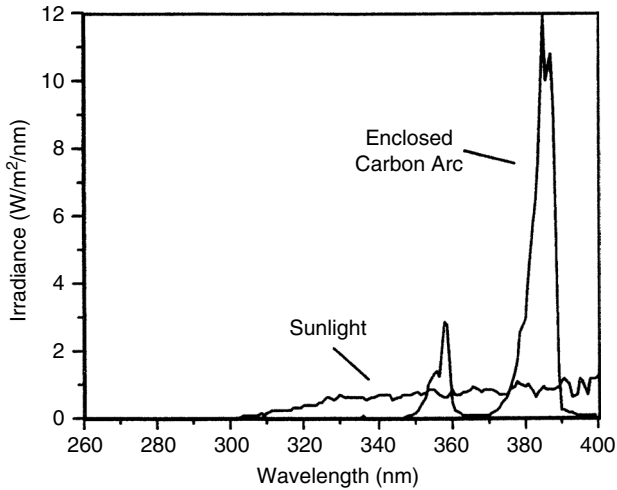

FIGURE 12.4 Enclosed carbon arc and sunlight.

12.3.1 The Importance of Short-Wavelength Cutoff

Photochemical degradation is caused by photons of light breaking chemical bonds. For each type of chemical bond, there is a critical threshold wavelength of light with enough energy to cause a reaction. Light of any wavelength shorter than the threshold can break the bond, but longer wavelengths of light cannot break it, regardless of their intensity (brightness). Therefore, the short-wavelength cutoff of a light source is of critical importance. For example, if a particular polymer is sensitive only to UV light below 295 nm (the solar cutoff point), it will never experience photochemical deterioration outdoors. If the same polymer is exposed to a laboratory light source that has a special cutoff of 280 nm, it will deteriorate. Although light sources with spectra that include the shorter wavelengths produce faster tests, there is a possibility of anomalous results if a tester has a wavelength cutoff too far below that of the material's end-use environment.

12.4 Arc-Type Light Sources

12.4.1 Enclosed Carbon Arc (ASTM G 153)

The enclosed carbon arc has been used as a solar simulator in accelerated weathering and lightfastness testers since 1918. Many test methods still specify its use. When the light output of this apparatus is compared to sunlight, some deficiencies become obvious. Figure 12.4 compares the UV spectral energy distribution of summer sunlight (solar maximum) to that of the enclosed carbon arc. The UV output of the enclosed carbon arc primarily consists of two very large spikes of energy, with very little output below 350 nm. Because the shortest UV wavelengths are the most damaging, the enclosed carbon arc gives very slow tests on most materials and poor correlation on materials sensitive to short-wavelength UV.

12.4.2 Sunshine Carbon Arc (Open Flame Carbon Arc: ASTM G 152)

The introduction of the sunshine carbon arc in 1933 was an advantage over the enclosed carbon arc. Figure 12.5 plots the UV SED of summer sunlight against the SED of a sunshine carbon arc (with Corex D filters). While the match with sunlight is superior to the enclosed carbon arc, there is still a very large spike of energy, much greater than sunlight, at about 390 nm.

A more serious problem with the spectrum of the sunshine carbon arc is found in the short wavelengths. To illustrate this, a change of scale is necessary to expand the low end of the graph. Figure 12.6 shows solar maximum versus sunshine carbon arc between 260 and 320 nm. The carbon arc emits a

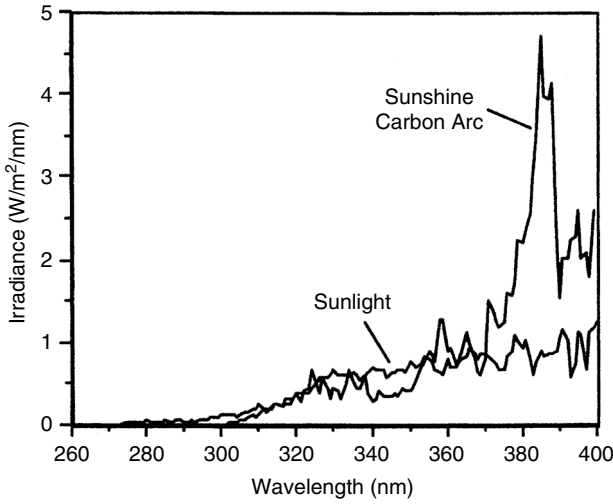

FIGURE 12.5 Sunshine carbon arc and sunlight: 260 to 400 nm.

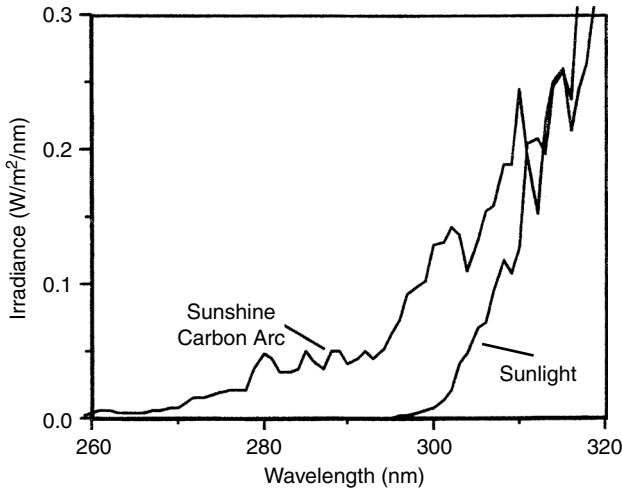

FIGURE 12.6 Sunshine carbon arc and sunlight: 260 to 320 nm.

great deal of energy in the UV-C portion of the spectrum, well below the normal solar cutoff point of 295 nm. Radiation of this type is realistic for outer space but is never found at the earth's surface. These short wavelengths can cause unrealistic degradation when compared to natural exposures.

12.4.3 Xenon Arc (ASTM G 155)

The xenon arc was adapted for accelerated weathering in Germany in 1954. Xenon arc testers, such as the Q-Sun Xenon Test Chamber, are appropriate for photostability of materials, because they provide the best available simulation of full-spectrum sunlight: UV, visible, and infrared (IR) light. Xenon arcs use filters to achieve the appropriate spectrum (e.g., outdoor sunlight or sunlight filtered through window glass).

12.4.3.1 Effect of Xenon Filters

Xenon arcs require a combination of filters to reduce unwanted radiation. The most common filter combination is the "daylight" filter. Figure 12.7 shows the spectral power distribution (SPD) of noon summer sunlight compared to a xenon arc with a Daylight Filter.

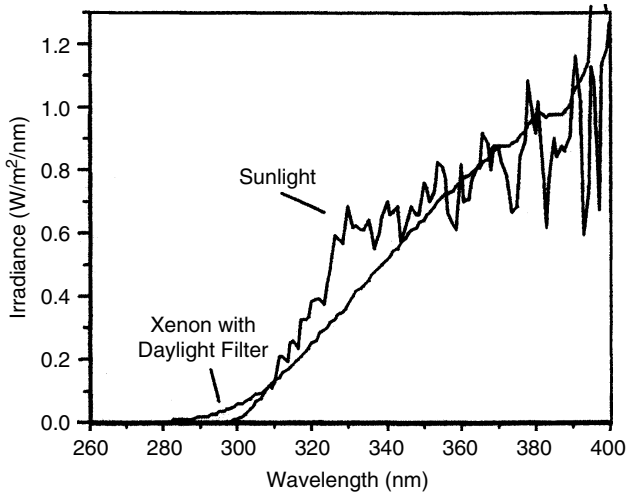

FIGURE 12.7 Xenon arc with Daylight Filter versus sunlight.

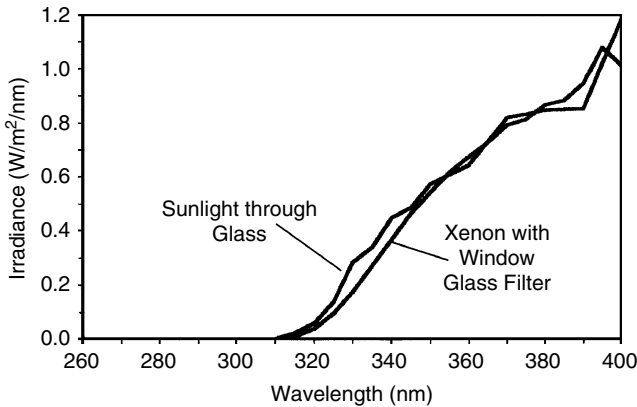

FIGURE 12.8 Xenon arc with Window Glass Filter versus sunlight through window glass.

Another type of xenon arc filter that is intended to simulate sunlight through window glass is the Window Glass Filter. It is typically used to test products with a primary service life that will be indoors. Figure 12.8 shows the SPD of noon summer sunlight behind glass compared to a xenon arc with a Window Glass Filter.

12.4.3.2 Xenon Arc Moisture

The xenon arc uses a system of intermittent water spray to simulate the effects of rain and dew. The water-spray cycle is especially useful for introducing thermal shock and mechanical erosion.

12.4.3.3 Effect of Irradiance Setting

Modern xenon arc models, including the Q-Sun, have a light monitoring system to compensate for the inevitable light output decay due to lamp aging. The operator presets a desired level of irradiance or brightness. As the light output drops off, the system compensates by increasing the wattage to the xenon burner. The most common irradiance settings are 0.35 or 0.55 W/m²/nm at 340 nm. Figure 12.9 shows how these two irradiance settings compare to noon summer sunlight.

Several different sensors to measure and control irradiance are available (depending on the manufacturer): 340 nm, 420 nm, TUV (total ultraviolet), or total irradiance. The difference between these sensors is the wavelength or wavelength band at which they control the irradiance, and the wavelength or wavelength band to which they are calibrated (through a NIST-traceable calibration radiometer).

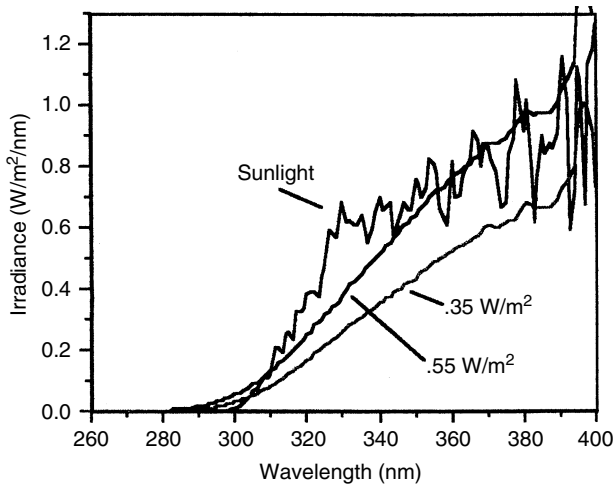

FIGURE 12.9 Effect of irradiance setting.

The 340 nm sensor measures a narrow band of wavelengths centered on 340 nm, with a half-bandwidth of 10 nm, and it should be used when testing materials that are primarily damaged by short-wavelength UV. This is because even as lamps age and the spectrum shifts, the 340 nm setting will still be maintained. Generally, this is a good control point for paints, plastics, roofing, and other typically durable products.

The 420 nm measures a narrow band of wavelengths centered on 420 nm, with a half-bandwidth of 10 nm, and it should be used when testing materials that are primarily damaged by visible light, such as dyes and pigments in textiles, papers, and inks. In general, the broader-band TUV and total irradiance sensors are not recommended.

Several factors complicate controlling the irradiance from a xenon burner: solarization of the filters and aging of the burner. Either of these factors may cause the xenon SPD to change nonuniformly — the short wavelength output drops off more rapidly than the longer wavelength output.

Figure 12.10 shows the SPD of one burner measured at four different times in its life. Irradiance is monitored and controlled only at 340 nm. A wattage increase that is sufficient to maintain irradiance at 340 nm is not enough to compensate for the fall off below 340 nm. At the same time, the higher wattage causes an increase in the visible light output from the burner. This changes the spectral power distribution of the lamp. The figure shows that, while the irradiance controller does a good job at 340 nm, there is a drop in irradiance in the short-wavelength UV portion of the spectrum.

This change in spectrum due to aging is an inherent feature of xenon arc lamps. However, this can be compensated for by regularly replacing the lamps.

12.5 Fluorescent UV Lamps

Since the 1970s, fluorescent UV and condensation testers have come into wide use. There are different lamps, with different spectra, for different exposure applications. The fluorescent UV testers and the arc testers use different approaches. The former do not attempt to reproduce sunlight itself, just the damaging effects of sunlight. This approach is effective, because short-wavelength UV causes almost all the damage to durable materials exposed outdoors. Consequently, fluorescent UV testers confine their primary light emission to the UV portion of the spectrum.

12.5.1 FS-40 Lamps (F40-UVB) (ASTM G 154)

In the early 1970s, the FS-40 became the first fluorescent UV lamp to achieve wide use. This lamp has been specified in some automotive test methods, particularly for coatings. Most of the output of the FS-

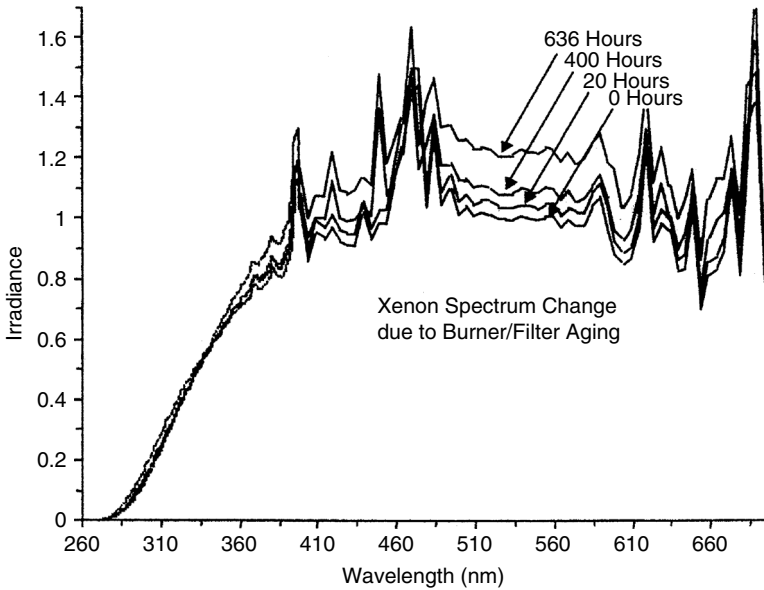

FIGURE 12.10 Xenon spectrum change due to aging.

40 is in the UV-B portion of the UV spectrum, along with some UV-A. This lamp has demonstrated good correlation to outdoor exposure for the gloss retention on coatings⁵ and for the material integrity of plastics. However, the short-wavelength output below the solar cutoff can occasionally cause anomalous results, especially for color retention of plastics and textile materials.⁶

12.5.2 UVB-313 Lamp (ASTM G 154)

Introduced in 1984, the UVB-313 is essentially a second-generation FS-40. It has the same SED as the FS-40, but its output is higher and more stable. Figure 12.11 plots the solar maximum against the UVB-313 and the FS-40. Because of its higher output, the UVB-313 gives significantly greater acceleration over the FS-40 for most materials. With the exception of the automotive industry, the UVB-313 is the most widely used light source for the ASTM G 154 devices.

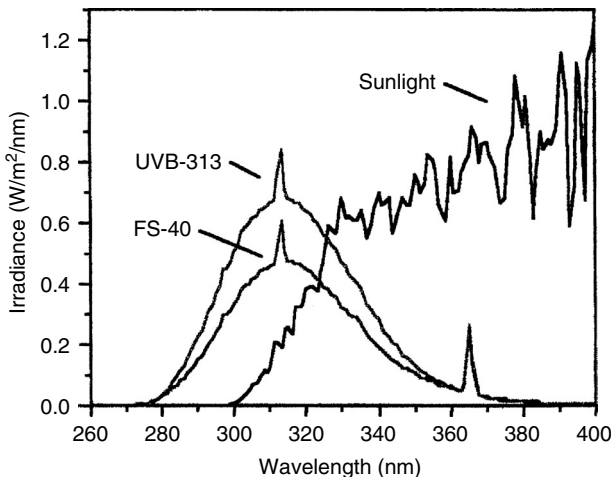

FIGURE 12.11 UVB-313 and FS-40.

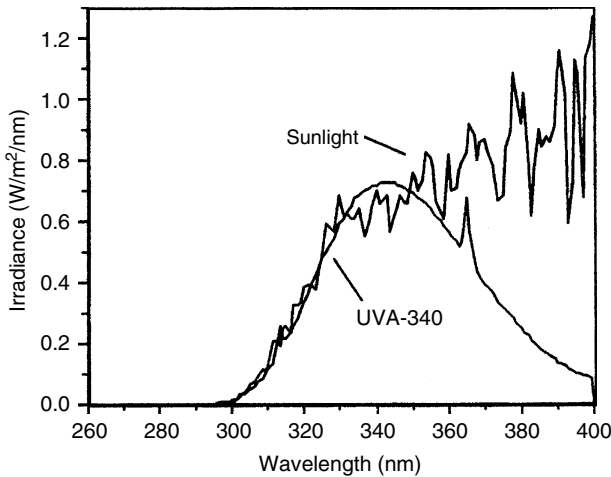

FIGURE 12.12 UVA-340 and sunlight.

12.5.3 UVA-340 Lamp (ASTM G 154)

The UVA-340 was introduced in 1987 to enhance correlation in the G 154 devices. Figure 12.12 shows the UVA-340 compared to the solar maximum. This lamp is an excellent simulation of sunlight in the critical short-wavelength UV region, from about 365 nm, down to the solar cutoff of 295 nm. Because the UVA-340 eliminates the short-wavelength output (i.e., five output lower than sunlight), which can cause unnatural test results, it allows more realistic testing than many of the other commonly used light sources. The UVA-340 has been testing on both plastics and coatings and greatly improves the correlation possible with the fluorescent UV and condensation devices.

12.6 Conclusions

The correlation between laboratory and natural exposure probably will always be controversial. As Fischer had indicated,⁷ test speed and test accuracy tend toward opposition. Accelerated light sources with short-wavelength UV give fast test results but may not always be accurate. But, there they are wrong, however, as they usually err on the safe side if they are too severe. Light sources that eliminate wavelengths below the solar cutoff of 295 nm will give better, more accurate results, but the price for increased correlation is reduced acceleration. Users must educate themselves to make this choice.

In addition, we should point out that despite many chemists' fascination with light energy, the spectrum of a test device is only one part of the picture. With any accelerated tester, there are a number of parameters that must be programmed: UV spectrum, moisture, humidity, temperature, and test cycle. Furthermore, the parameters that one chooses are, to a certain extent, arbitrary. No single test cycle or device can reproduce all the variables found outdoors in different climates, altitudes, and latitudes. Consequently, even the most elaborate tester is really just a screening device. Accelerated weathering data are comparative data. The real usefulness of accelerated testers is that they can give a reliable, relative indication of which material performs best under a specific set of conditions.

Acknowledgments

Most of the data in this paper were originally presented at the Society of Plastics Engineers Automotive RETEC, November 1987. The authors are grateful for the cooperation of Kitt Peak National Observatory, Kitt Peak, Arizona, and Ohio Spectrographic Service, Parma, Ohio.

References

1. N. Searle and R. Hirt, "UV SED of sunlight," *J. Opt. Soc. Am.*, 55, 11 (1965).
2. CIE Standard No. 20, 19.
3. D. Grossman, "Know your enemy: The weather," *J. Vinyl Technol.*, 3, 1 (1981).
4. G. Zerlaut, "Accelerated weathering & UV measurements," ASTM STP 781. Philadelphia: American Society for Testing and Materials, 1982.
5. G. Grossman, "Correlation of weathering," *J. Coat. Technol.*, 49, 633 (1977).
6. J. Dick, et al., "Weathering of pigmented plastics," SAE Technical Paper No. 850350, 1985.
7. R. Fischer, "Accelerated test with fluorescent UV-condensation," SAE Technical Paper No. 841022, 1984.

13

Cure Monitoring: Microdielectric Techniques

13.1 The Dielectric Response	13-1
13.2 Changes In Resistivity During Cure	13-2
Process Control through Dielectric Feedback • Process Control through Dielectric–Thermal Feedback	
13.3 Summary.....	13-5
References.....	13-5

David R. Day

Micromet Instruments, Inc.

Developments in the area of microelectronics now enable the fabrication of microdielectric sensors that can analyze drying, curing, and diffusion phenomena in coatings.¹ Several types of microdielectric sensors have evolved in the past few years, the most sensitive being based on interdigitated electrodes and field effect transistors fabricated on a 3 × 5 mm silicon chip.² The chip sensor is housed in a polyamide package and configured for ease of placement in various processing environments (Figure 13.1).

13.1 The Dielectric Response

The dielectric response arises from mobile dipoles and ions within the material under test. As a coating cures, the mobilities of dipoles and ions are drastically reduced, sometimes by as much as seven orders of magnitude. Microdielectric sensors are sensitive enough to follow those changes and are therefore useful for cure monitoring, cure analysis, and process control.³

The dielectric response is typically expressed by the quantities of permittivity or dielectric constant (E') and loss factor (E''):

$$E' = E_u + \frac{E_r - E_u}{1 + \omega\tau^2} \quad (13.1)$$

$$E'' = \frac{s}{e_0\omega} + \frac{E_r - E_u}{1 + \omega\tau^2} \omega\tau \quad (13.2)$$

where $(E_r - E_u)/(1 + \omega\tau^2)$ is the dipole term, $se_0\omega$ is the conductivity term, and

E' = dielectric constant

E'' = loss factors

s = bulk ionic conductivity

e_0 = permittivity of free space (a constant)

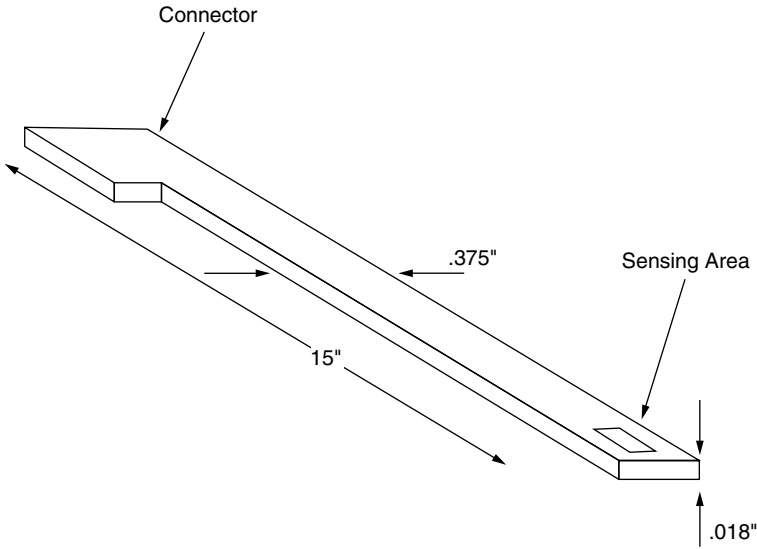

FIGURE 13.1 Schematic diagram of microdielectric sensor.

ω = frequency $\times 2\pi$

τ = dipole relaxation time

E_r = relaxed permittivity (low frequency E')

E_u = unrelaxed permittivity (high frequency E')

In addition to ions and dipoles, other factors, such as electrode polarization⁴ or inhomogeneities, may influence the dielectric response; however, these generally play a minor role and are usually ignored.

The dielectric loss factor is the most useful quantity for monitoring cure reactions. Dipole relaxation times or ionic conductivity levels may be monitored during cure. However, dipole relaxation times are usually difficult to determine, because the conductivity response often dominates the dipole term in Equation 13.2. On the other hand, conductivity usually can be determined throughout the entire cure process, especially if low frequencies (<10 Hz) are monitored during the end of cure. The inverse of the measured conductivity, resistivity, is often proportional to viscosity of the material under test before gelation and is related to rigidity after gelation.⁵ Figure 13.2 shows loss factor data during an isothermal cure of an epoxy resin. Figure 13.3 compares the log (resistivity) calculated from the data in Figure 13.2 to degree of conversion as determined by the fractional generated heat method using differential scanning calorimetry (DSC). Figure 13.3 shows that the dielectric response can monitor the entire cure and is far more sensitive to the last few percent of cure than DSC.

13.2 Changes In Resistivity During Cure

Figure 13.4 plots changes in resistivity during isothermal cure versus changes in the glass transition temperature. These data demonstrate the utility of microdielectric sensors for monitoring and process control in coatings.

Using the previously described techniques, ionic conductivity (or its reciprocal, resistivity) can be obtained in real time by continuously monitoring a range of frequencies. It can then be used to control the reaction through variation in either temperature or pressure. Several ways exist in which dielectric feedback may be used. Some of these are as follows:

- Temperature may be held constant or controlled until a desired viscosity (measured dielectrically) is attained.
- Viscosity may be held constant or varied at will through controlled variation in temperature.

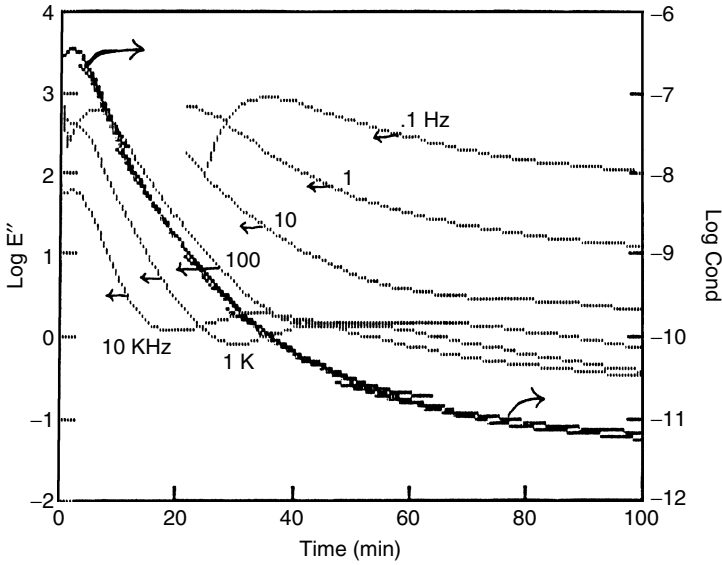

FIGURE 13.2 Dielectric loss factor data of isothermal (392°C) epoxy-amine cure. Frequencies range from 10^{-1} to 10^4 Hz.

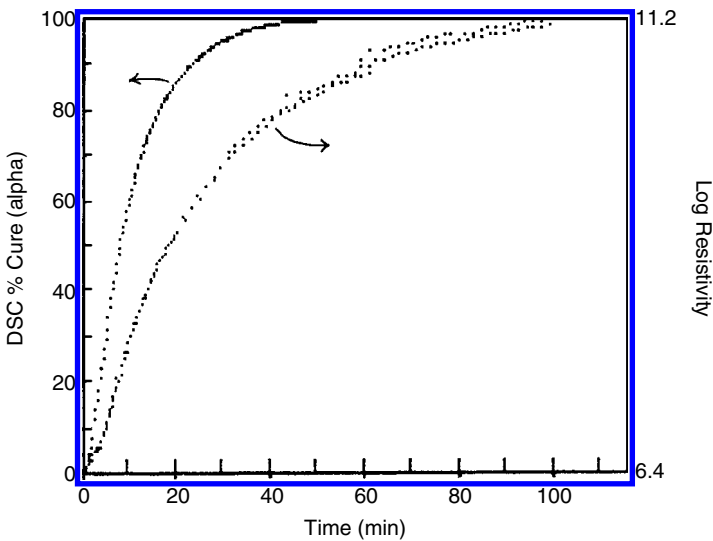

FIGURE 13.3 Ionic resistivity data from Figure 13.1 and degree of conversion as determined by DSC versus time.

- Pressure, vacuum, or mold opening may be activated upon attainment of a critical viscosity of dielectric reaction rate.
- Reaction may be terminated when the dielectric reaction rate decreases below some critical value.

13.2.1 Process Control through Dielectric Feedback

Figure 13.5 shows an example of a process-controlled cure of a graphite epoxy using microdielectric feedback. Control was achieved using an IBM PC with modified Micromet Instruments dielectric software and hardware. The cure was carried out in a hot press with temperature controlled from the computer. The process control software sequence was as follows:

1. Heat and hold at 250°F until a log resistivity of 7.0 is reached (allows for degassing while preventing premature cure).
2. Hold log resistivity (viscosity) at 7.0 until 350°F is reached (allows for controlled curing and prevents second viscosity minimum).
3. Hold at 350°F until the dielectric reaction rate is near zero (allows reaction to go to completion).
4. Cool and notify operator that cycle has been completed.

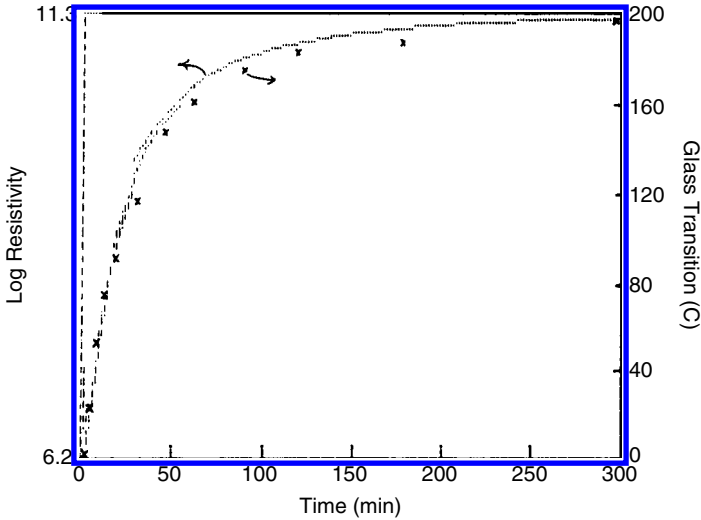

FIGURE 13.4 Ionic resistivity data and T_g during isothermal epoxy-amine cure.

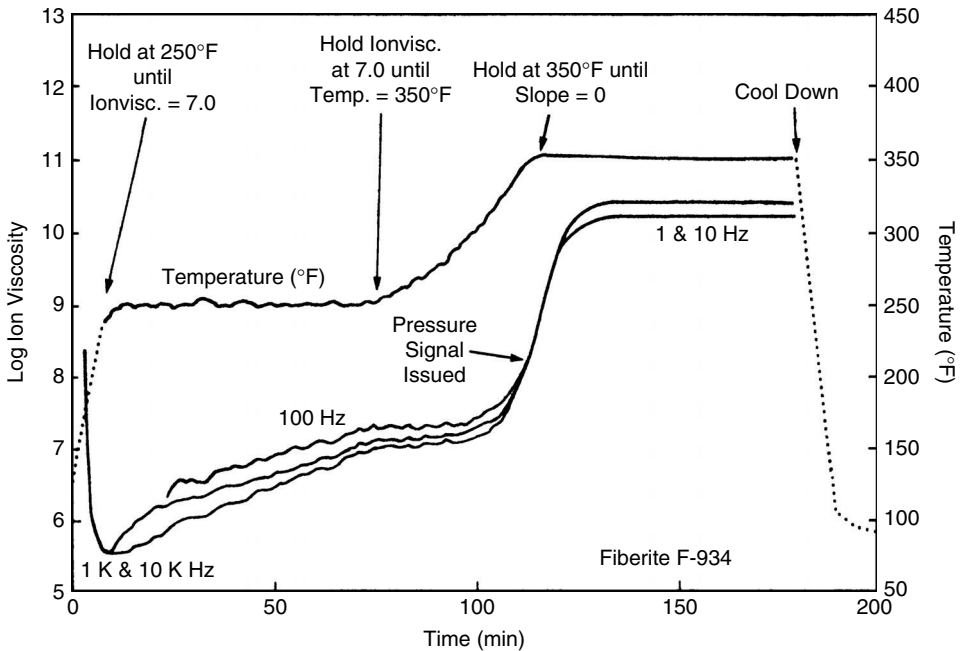

FIGURE 13.5 Process control of epoxy graphite cure utilizing microdielectric feedback.

13.2.2 Process Control through Dielectric–Thermal Feedback

The cure in Figure 13.5 was completely controlled through both dielectric and thermal feedback from the microdielectric sensor in contact with the graphite epoxy material. Note that the second viscosity (resistivity) minimum typical of these materials was completely eliminated through the use of viscosity control. This technique is useful for limiting excessive bleed in composites that are prone to such problems. Finally, the endpoint was detected and the reaction stopped, eliminating unnecessary over-curing time.

13.3 Summary

Microdielectric sensors are useful for monitoring cures of coatings under actual processing conditions. The ionic resistivity portions of the loss factor data correlate to viscosity during the early stages of reaction (before gelation or solidification). As the reaction progresses, the slope of the ionic resistivity can be used to monitor reaction rate and to detect when cure is complete. The microdielectric sensors provide a unique capability to correlate measurements made in the laboratory to those in the factory and to provide the necessary feedback information for adaptive process control.

References

1. D. R. Day and D. D. Shepard, *J. Coat. Technol.*, 60(760), 57 (1988).
2. (a) S. D. Senturia, N. S. Sheppard, Jr., H. L. Lee, and D. R. Day, *J. Adhes.*, 15, 69 (1982). (b) N. F. Sheppard, Jr., D. R. Day, H. L. Lee, and S. D. Senturia, *Sensors Actuators*, 2, 263 (1982).
3. (a) W. E. Baumgartner and R. Ricker, *SAMPE J.*, 19(4), 6 (1983). (b) D. R. Day, *Proceedings of the SAMPE Symposium*, Las Vegas, 1986, p. 1095. (c) D. E. Kranbuehl, *Proceedings of the SAMPE Symposium*, Anaheim, CA, 1988. (d) D. R. Day, *Proceedings of the SAMPE Symposium*, Anaheim, CA, 1988, p. 594.
4. D. R. Day, T. J. Lewis, H. L. Lee, and S. D. Senturia, *J. Adhes.*, 18, 73 (1985).
5. J. Gotro and M. Yandrasits, *Proceedings of the 45th SPE ANTEC*, Anaheim, CA, 1987, p. 1039.

14

Test Panels

Douglas Grossman

Q-Panel Lab Products

Patrick Patton

Q-Panel Lab Products

14.1 Cold Rolled Steel Panels	14-1
Surface Profile • Surface Carbon • Surface Preparation • Applications	
14.2 Aluminum Panels.....	14-4
Surface Finish • Pretreatment • Applications	
14.3 Zinc-Coated Steel Panels	14-6
Surface Preparation	
14.4 Handling and Storage of Test Panels	14-7
Bibliography	14-7

When performing coatings tests, it is important to make sure that problems with the metal substrate do not skew the test results. Test standards exist for all sorts of coatings characteristics, including adhesion, flexibility, corrosion resistance, and appearance. These standards establish test conditions designed to control variables, which can influence test results. These variables include the method of application, the film thickness, the cure method, and the test substrate.

In a controlled laboratory environment, the application method, film thickness, and cure method can be controlled with some degree of precision. In many cases, it is not possible to exercise the same degree of control over the test substrate. For this reason, coatings technicians use standardized test panels when conducting critical tests. A standardized panel is produced from carefully specified material and is prepared in a tightly controlled process designed to yield a consistent test surface that can be relied upon to provide reproducible results from test to test and from batch to batch.

There are many different types of standardized test panels available. The requirements for these panels have been described in both national and international standards. These include ISO 1514: *Paints and Varnishes — Standard Panels for Testing*, ASTM D 609: *Standard Practice for Preparation of Cold-Rolled Steel Panels for Testing Paint, Varnish, Conversion Coatings and Related Coating Products*, and ASTM D 2201: *Standard Practice for Preparation of Zinc Coated and Zinc Alloy Coated Steel Panels for Testing Paint and Related Coating Products*. The following is a general description of the different types of test panels included in these standards, along with a discussion of the primary applications and sources of variability for each panel type.

14.1 Cold Rolled Steel Panels

There are a number of points to consider when preparing a specification for standardized cold rolled steel test panels. The type of steel selected should be of a standard grade and quality. It is important that the steel be widely available. SAE 1008 and 1010 are examples of suitable grades of steel for test panel production. The steel used should also be free from rusting and staining. Standardizing on a particular grade of steel helps to eliminate variability in the chemical composition that can influence the results of some types of testing.

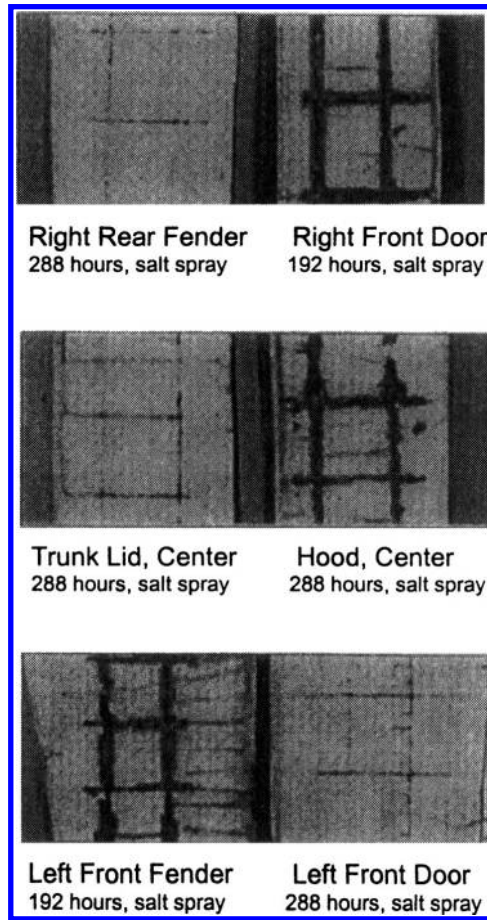

FIGURE 14.1 Metal substrates and their effects on paint.

Specifying a particular grade of steel may be all that is required for many industrial applications, but this is not the case when the steel will be used to produce test panels. It has been well documented that different batches of seemingly identical steel, even when produced by the same mill, have shown drastic differences in performance under paint (see Figure 14.1). Over the years, several researchers have undertaken to explain this problem of “good steel” versus “bad steel.” A number of these studies have been successful in isolating the factors contributing to this variability. It is important that specifications for steel to be used in the manufacture of test panels take these factors into account.

14.1.1 Surface Profile

Surface roughness, waviness, and peak count are some of the parameters that make up the surface profile of a steel panel. Surface profile is an important consideration in designing an effective test panel specification. Steel mills typically characterize different finishes as matte, light matte, commercial bright, etc. These characterizations represent fairly broad ranges in terms of surface profile. While these characterizations may be suitable for most applications, the surface profile for steel used in the production of standardized test panels must be more narrowly defined. For example, if a specification calls for steel with a “matte” finish, the surface roughness of the steel as received may be anywhere from 25 to 65 μ inches, or even higher. Different mills define a matte finish differently. In addition, depending on the condition and degree of wear of the finish rolls, the “matte” finish produced by a given rolling mill can vary greatly from shipment to shipment. For these reasons, a specification for steel used in the production

of test panels must call out a more narrowly defined range for surface roughness (i.e., 35 to 45 μ inches). The actual range specified is not necessarily as important as the fact that a range is defined.

Some applications in which surface profile is particularly critical include appearance measurement and testing of phosphate coatings. The surface profile of a steel panel can have a significant impact on the appearance of a subsequently applied coating. Reliable evaluations of gloss, distinctness of image, and other appearance-related properties cannot be made if the consistency of the surface profile of panels used in the evaluations is in question. Similarly, steel test panels are often used to evaluate phosphate coating processes. Line technicians expect that a standardized test panel will accept a coating with given characteristics, assuming the phosphate process parameters are in order. However, normal mill variability in steel surface profile can contribute to differences in phosphatability. For example, a rougher steel surface has a greater surface area than a relatively smooth steel surface. This difference in surface area can lead to differences in coating weight. Surface profile is by no means the only factor bearing an impact on the phosphatability of a steel surface. It is, however, an important factor and must be controlled as a source of variability.

14.1.2 Surface Carbon

Over the years, steel suppliers and automotive companies have funded numerous research projects aimed at determining the source of variability in performance between different lots of seemingly identical steel. The results have not been ambiguous. In study after study, surface carbon has been identified as an important factor contributing to variations in phosphatability and under-paint corrosion resistance of commercial cold rolled steel.

When cold rolled steel panels are phosphated and painted under identical conditions and tested for salt spray resistance in accordance with ASTM B 117, there is a strong correlation between high levels of surface carbon and premature failure in salt spray testing. Surface carbon is a highly adherent material and cannot be removed by typical cleaning operations. In addition, it is impossible to determine the level of surface carbon on a steel surface without sophisticated and expensive laboratory evaluation. For these reasons, it is important to understand where surface carbon comes from and how it can be controlled.

During the process of cold reduction, a stress is imparted to the steel sheet, resulting in work hardening. This work hardening must be relieved by annealing, or holding the steel at an elevated temperature for a specified period of time. Annealing softens the metal, resulting in improved formability. Rolling oils are applied to the steel surface during cold reduction. These oils act as a lubricant for the rolling process. Residual rolling oils remaining on the steel surface after cold rolling can decompose when exposed to the elevated temperatures in the annealing furnace, resulting in the deposition of carbon compounds on the surface. The carbon is essentially baked into the surface, making it virtually impossible to remove without mechanical abrasion.

Because it is not really possible for a test panel manufacturer to remove surface carbon through typical cleaning methods, it is necessary to purchase steel that is low in surface carbon. There are effective methods for limiting surface carbon at the mill. It is important to identify steel mills that are willing and able to enact such measures to control surface carbon. An effective specification for steel to be used in the fabrication of test panels should include a maximum allowable surface carbon content. Various studies have demonstrated that surface carbon begins to have a detrimental effect on phosphatability and salt spray resistance when present in amounts greater than 0.4 to 0.6 mg/ft².

14.1.3 Surface Preparation

When preparing test panels, it is important to standardize not only the material used but also the method of surface preparation. There are a number of different surface preparation methods discussed in ASTM D 609 and ISO 1514. These include alkaline cleaning, solvent cleaning, vapor degreasing, and phosphate conversion coatings.

Any of the preparation methods described in ASTM D 609 or ISO 1514 is suitable for test panel preparation. The most important consideration should be to institute tight control of all process param-

eters for the selected preparation method. Parameters requiring control may include cleaning time, bath temperatures, concentration, rinse water purity, and spray pressure. Pertinent process parameters should be maintained within narrowly defined ranges. Regardless of the preparation method selected, the panels should be free from water break after processing. This can be determined by spraying a film of distilled or deionized water on the cleaned surface. If the water forms a continuous unbroken film over the entire surface, without gathering into discrete droplets or other water breaks, this should be taken as an indication that all organic soils have been adequately removed from the surface. A white cloth wipe test should also be conducted to indicate whether inorganic particulate soils have been adequately removed, as the water break test is not sensitive to the presence of inorganic soils on the surface.

Tight control of process parameters is especially critical when preparing panels by applying an iron or zinc phosphate conversion coating. Such characteristics as coating weight and morphology require close monitoring in order to ensure consistent test panel performance.

14.1.4 Applications

ASTM D 609 specifies three types of steel test panel. The following is a description of each type, along with some information regarding the typical applications.

Type 1 steel panels are produced from steel with a matte finish. This type of finish is generally representative of steel used for painted surfaces on appliances of general sheet metal applications. This type of surface is suitable for testing coatings systems used in these applications, along with many automotive and general purpose applications. It is also suitable for testing zinc and iron phosphate coating systems. However, it is important to remember that paint performance on this type of surface can vary significantly if factors such as surface profile, surface carbon, and the method of surface preparation are not tightly controlled.

Type 2 steel panels have a flat polished surface. This type of finish is not available from a mill. It is produced by removing the original mill surface in a controlled grinding or polishing process. The purpose for removing the mill surface is to eliminate the normal variability between different mill surfaces. The grinding process effectively eliminates surface carbon and surface profile as variables, simply by removing the mill surface completely. This type of surface is suitable for applications in which good reproducibility is critical, and variability due to surface characteristics cannot be tolerated. One problem with this type of surface is that, while it is highly uniform and reproducible, it is not really representative of any surface that would be coated in a field application.

Type 3 steel panels have a smooth finish produced by rolling with polished rolls. This type of finish is most suitable for evaluating color, gloss, distinctness of image, and other appearance properties of coatings, along with flexibility and adhesion. The surface finish on this type of steel is more easily controlled, resulting in less lot-to-lot variability in terms of surface profile.

14.2 Aluminum Panels

In many paint testing applications, it is more convenient to use aluminum test panels. Aluminum is much lighter than steel and is not subject to corrosive attack in most environments. Aluminum panels can be prepared from many different alloys, with all kinds of pretreatment. As it is not possible to describe all the different types of aluminum panels, an effort will be made to describe standardized aluminum panels intended for general purpose testing.

Aluminum panels intended for general applications should be produced from a common grade of mill finish aluminum sheet that is readily available. Aluminum Association alloys 3003, 3105, and 2024 have all been found suitable for test panel production. Standardized panels need to be cleaned in a tightly controlled process so that they are free from oil and particulate soils. Solvent and aqueous cleaning are both acceptable methods. Regardless of the cleaning method, it is essential to identify critical process parameters, establish narrow ranges for each, and closely monitor the parameters to ensure they are

always in order. The cleaning process should be evaluated by conducting water break and white cloth wipe tests at predetermined intervals on processed panels.

14.2.1 Surface Finish

The Aluminum Association defines mill finish sheet as “sheet having a non-uniform finish that may vary from sheet to sheet and within a sheet, and may not be entirely free from stains or oil” (from Aluminum Association of America literature). The standard mill finish produced by a given mill can vary considerably, in terms of appearance, from the standard mill finish produced by another mill. Some mills tend to roll a very shiny, reflective mill finish, while other mills produce a duller finish with lower reflectivity. There can also be lot-to-lot variability in the mill finish produced by a given mill. This surface finish variability can impact the results of some color and appearance evaluations. To minimize this variability to some degree, aluminum used in the production of test panels should be purchased only from prequalified mills, which have been evaluated for surface quality and consistency.

14.2.2 Pretreatment

An untreated aluminum surface will oxidize immediately upon exposure to air or water, resulting in the formation of a protective surface oxide layer. This oxide layer protects the aluminum from corrosive attack in most environments. However, it also creates some problems when the aluminum surface needs to be painted. First, the oxide layer tends to be nonuniform, and it inhibits adhesive bonding between an applied coating and the aluminum surface. In addition, the surface oxide is soluble in environments where the pH falls below 4 or above 10. For these reasons, an untreated aluminum surface is not suitable for conducting critical performance evaluations, such as adhesion and corrosion resistance, of coatings.

There are a number of different types of pretreatments designed to improve the performance of aluminum under paint. Most aluminum pretreatment systems are essentially designed to modify the surface oxide layer in such a manner as to increase its stability in mildly acidic and alkaline environments and to significantly improve the paint bonding characteristics of the surface. Several different types of pretreatment are described in ASTM D 1730 *Standard Practices for Preparation of Aluminum and Aluminum-Alloy Surfaces for Painting*. It is not necessary to discuss each of these pretreatment methods in detail. It is sufficient to state that when designing a specification for test panel pretreatment, it is important to identify critical process parameters, establish narrow tolerances for each, and institute controls to ensure that the process remains within specified tolerances.

Test panels can be supplied pretreated in accordance with any of the methods described in ASTM D 1730. However, many of these methods are specific to certain applications or alloys. In such cases, it is not practical to use such methods to prepare standardized panels for general purpose testing. On the other hand, chromate conversion coating is easily the most widely used method to prepare aluminum surfaces for painting. A chromate conversion coating greatly increases the paint bonding properties and the corrosion resistance of an aluminum surface. Standardized test panels supplied pretreated with a chromate conversion coating can be used to evaluate various performance characteristics of coatings, including adhesion and corrosion resistance.

It is, however, absolutely critical that chromated panels intended for performance testing be produced in a tightly controlled process, with close monitoring of all important process parameters. Variations in the chromate process conditions can result in different chromate coatings characteristics, which in turn result in inconsistent performance under paint. Some of the process parameters requiring close control include the temperature and concentration of the process baths and the contact time and the conductivity of water used in rinse and process solutions. It is not sufficient to control these factors within normal commercial tolerances, as this will most likely not yield the consistency in results that is to be expected from a standardized test substrate. For example, ASTM B 449, *Standard Specification for Chromates on Aluminum*, classifies a paint base chromate coating as having a coating weight of 10 to 35 mg/ft². This is a fairly wide range, and a panel with a coating weight at the low end of the range cannot be expected

to demonstrate performance under paint that is consistent with that of a panel with a coating weight at the higher end of the range in certain types of testing. Therefore, when preparing a specification for chromating standardized test panels, a more narrow coating weight range is required, 15 to 20 mg/ft², for example.

14.2.3 Applications

Untreated aluminum panels are suitable for conducting appearance-related measurements, such as color, gloss, and distinctness of image. They can also be used to evaluate pretreatment and coatings systems for aluminum, as well as in many general purpose applications. Aluminum panels supplied with a chromate pretreatment should be used when testing for adhesion, flexibility, impact resistance, corrosion resistance, and similar properties.

14.3 Zinc-Coated Steel Panels

Some paint testing applications may require steel panels with a zinc or a zinc alloy coating. Because there are so many varieties of zinc and zinc alloy coatings available, these will not be discussed in detail. Some examples of the different types of zinc coatings include hot-dipped zinc-coated steel (galvanized), electrolytically zinc-coated (electrogalvanized), zinc-iron-alloy-coated (galvanneal), and zinc-5%-aluminum-alloy-coated (galfan). Each of these coatings is available in a wide variety of coating designations, as well as with differential and one-side-only coatings. The following is a set of general guidelines regarding the preparation of zinc and zinc-alloy-coated steel panels.

When purchasing zinc- or zinc-alloy-coated steel for use in the preparation of test panels, it is important to prepare a detailed specification for the metal to be used. Information that should be listed in the purchase specification includes the type of zinc coating required, the quality of the metal, the finish requirements, and the requirements for oiling and chemical treatment. Seemingly minor differences in the zinc coating can significantly impact the performance of applied coatings.

The metal used in the preparation of zinc-coated steel panels should be completely free from wet storage stain or white rust. Wet storage stain is a deposit of white or gray zinc corrosion products appearing on a zinc surface, which has been stored or shipped in damp or poorly ventilated conditions. The steel mills routinely apply a chromate passivating treatment to zinc-coated steel surfaces in order to help minimize this wet storage stain. This passivating treatment acts as a barrier, directly inhibiting the bonding of paints and other coatings to the zinc surface. Zinc-coated steel that has received a passivating treatment should not be used for test panel production. It is necessary to special order the metal without a passivating treatment, as this treatment is standard procedure at the mills. The passivating treatment can be removed from a surface through abrasion, but this alters the surface profile significantly.

14.3.1 Surface Preparation

Zinc-coated steel panels must be cleaned in order to remove any oils and particulate soils that may interfere with successful coating of the surface. Solvent cleaning and aqueous alkaline cleaning are both suitable methods for cleaning the panels, as described in ASTM D 609. It is important to note, however, that zinc, like aluminum, is subject to corrosive attack by a strongly alkaline cleaning solution. When an alkaline cleaning process is used to prepare zinc-coated panels for painting, take care to ensure that the cleaner concentration, temperature, and contact time are appropriate for a zinc surface. After cleaning, zinc-coated panels should be completely free from water break and from particulate soils.

Zinc-coated steel panels may be supplied treated with a zinc phosphate conversion coating to provide an improved surface for painting. It is more difficult to successfully phosphate a zinc-coated steel surface than it is to phosphate a cold rolled steel surface. For this reason, close control of the zinc phosphate process parameters is especially important. A zinc phosphate solution containing nickel and fluoride is most suitable for treating a zinc-coated steel surface.

14.4 Handling and Storage of Test Panels

Good painting practice dictates that a test panel should be coated as soon as possible after preparation for painting. In situations where this is not practical, test panels may be cleaned and pretreated in large batches and then stored for future use. However, once the panels have been cleaned and pretreated, it is important to handle them in such a manner as to avoid recontamination. Precleaned panels should be handled only by the edges and only with a gloved hand or a clean instrument, such as a pair of tongs.

Another concern is the storage of precleaned panels in such a manner that they are protected from corrosive attack. This is especially important when dealing with steel panels. Steel shipped from the mill is generally coated with a rust preventative oil. The cleaning process removes this protective oil, making the steel panel susceptible to rusting. If steel panels are to be stored for any period of time, they must be protected with some type of corrosion inhibitor. The most effective method to use to accomplish this is to wrap the steel panels in paper that has been impregnated with a volatile corrosion inhibitor compound (VCI). Steel panels wrapped in a suitable VCI paper can normally be stored for years without rusting. This is because the volatile corrosion-inhibiting compounds, including nitrites and amines, in the paper vaporize and are adsorbed onto the surface of the steel panel. The presence of these compounds on a steel surface has been shown to have a negative impact on the performance of applied coatings in certain types of testing. In such cases, the panels should be recleaned prior to painting in order to remove the residual corrosion inhibitors. However, traditional cleaning methods are generally ineffective. Thorough wiping with a cloth wet with warm distilled water is the best method for removing the VCI compound from the surface. Wet abrasion is another effective method, but this changes the surface profile.

VCI papers designed for use with zinc-coated panels are also available. Aluminum panels should be wrapped in plain kraft paper or in a plastic bag to protect them from dust. They do not require any special packaging to prevent corrosion. It is sufficient to store them in a dry, clean area, where they will not be exposed to moisture.

Bibliography

- Buser, K. R., *J. Coat. Technol.*, 54(689), 29 (1982).
- Coduti, P. L., *Effects of Steel Processing on the Surface Carbon of Cold-Rolled Steel*. Chicago, IL: Inland Research Laboratories.
- Grossman, G. W., *Official Digest*, 31, 1688 (1959).
- Grossman, G. W., *Paint Industry*, September (1961).
- Skerry, B. S., W. J. Culhane, D. T. Smith, and A. Alavi, *J. Coat. Technol.*, 60(788), 55 (1990).

15

Design of Experiments for Coatings

Mark J. Anderson

Stat-Ease, Inc.

Patrick J. Whitcomb

Stat-Ease, Inc.

15.1 Introduction	15-1
15.2 Standard Two-Level Factorial Designs.....	15-2
Case study — Screening Factors thought to Affect a Spin Coater	
15.3 Optimization via Response Surface Methods (RSMs)	15-4
15.4 Mixture Designs for Optimal Formulation.....	15-5
References	15-6

15.1 Introduction

The traditional approach to experimentation changes only one process factor at a time (OFAT) or one component in a formulation. However, the OFAT approach does not provide data on interactions of factors (or components), a likely occurrence with coating formulations and processes. Statistically-based design of experiments (DOE) provides validated models, including any significant interactions, that allow you to confidently predict response measures as a function of the inputs. The payoff is the identification of “sweet spots,” where you can achieve all product specifications and processing objectives.

The strategy of DOE is simple and straightforward:

1. Use screening designs to separate the vital few factors (or components) from the trivial many.
2. Follow up by doing an in-depth investigation of the surviving factors. Generate a “response surface” map and move the process or product to the optimum location.

However, the designs must be tailored for the nature of the variables studied:

- Components in a product formulation
- Factors affecting a process

Traditionally, the experiments on formulations versus processing are done separately by chemists and engineers, respectively. Obviously, collaboration between these two technical professions is essential to the success of any study. Furthermore, mixture components can be combined with process factors into one design for final optimization. In other words, you can mix your cake and bake it too, but this should be done only at the final stages of development — after narrowing the field of variables to the vital few.

We will devote most of this short discussion to process screening, because these designs are relatively simple, yet are incredibly powerful for making breakthrough improvement. Mastering this level of DOE puts you far ahead of most technical professionals and paves the way for more advanced tools geared to optimization of processes or formulated products.

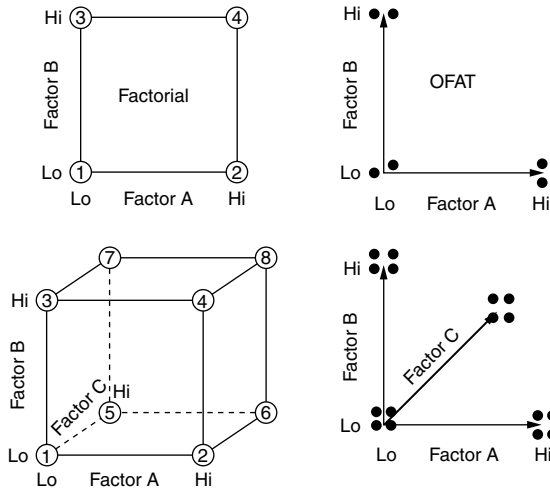

FIGURE 15.1 Comparison of two-level factorial designs (left) versus OFAT (right) for two factors (top) versus three factors (bottom).

15.2 Standard Two-Level Factorial Designs

Two-level factorial design involves simultaneous adjustment of experimental factors at high and low levels. By restricting the tests to only two levels, you minimize the number of runs: Do not bother setting three levels of every factor until you get close to the optimum. By then, the number of factors (k) should be much reduced via screening studies. The math is simple — as k increases, the number of runs goes up exponentially. Therefore, apply 2^k (two-level) designs when screening many factors versus 3^k to optimize the vital few.

The contrast between two levels provides the necessary driving force for process improvement via the 2^k designs. This parallel-testing scheme is much more efficient than the traditional, serial approach of OFAT, as illustrated by Figure 15.1, which shows designs with equivalent power for calculating effects from the contrasts between high and low levels.

For example, the factorial design at the top-left offers two runs at the high level for A and the same for the low level. Similarly, factor B is run twice at the high level as well as at the low level. Therefore, the OFAT design at the upper right has two runs each at the high levels to provide similar power for effect estimation. However, this necessitates a total of six runs for OFAT versus only four for the two-level factorial. The efficiency advantage for factorials becomes more pronounced as the number of factors increases, as evidenced by the side-by-side comparison of the two bottom designs in Figure 15.1. Here you see experiments on three factors, in which case, OFAT comes out far worse than the two-level factorial, with 16 versus only eight runs, respectively.

Factorial design offers two additional advantages over OFAT:

- It covers a broader area or volume of factor-space from which to draw inferences about your process.
- It reveals “interactions” of factors. Revelation of two-factor interactions (2fis) often proves to be the key to understanding a process, especially one involving chemicals, such as coatings.

Table 15.1 shows how many runs are required to do full two-level designs for up to eight factors. You must run full factorials for four or fewer factors if you want to resolve 2fis. We advise that if you want to study only two factors that you replicate the design. However, if you need to screen five or more factors, only a fraction of all the combinations need be applied. Ideally, resources will be available to achieve high resolution (see column in Table 15.1 labeled “High-Res”) and thus detect 2fis, but when runs come at a premium, choose a smaller, medium-resolution design to screen for main effects only.

TABLE 15.1 A Select Set of Two-Level Factorials

Factors (<i>k</i>)	Number of Runs Full	Number of Runs High-Res	Number of Runs Med-Res
2	4 (2^2)	8 ($2 \times$)	NA
3	8 (2^3)	NA	NA
4	16 (2^4)	NA	8 ($1/2$)
5	32 (2^5)	16 ($1/2$)	NA
6	64 (2^6)	32 ($1/2$)	16 ($1/4$)
7	128 (2^7)	32 ($1/4$)	16 ($1/8$)
8	256 (2^8)	32 ($1/8$)	16 ($1/16$)

Layouts for these and many other fractional designs, including far more factors, can be found in DOE textbooks,¹ or better yet, with the aid of statistical software packages.² You can choose two-level designs with as little as $k + 1$ runs, where k equals the number of factors you want to test. For example, you could test seven factors in eight runs, or 15 factors in 16 runs. However, these “saturated” designs provide very poor resolution: main effects will be confused with two-factor interactions. We advise that you avoid running such low-resolution designs.

Be sure to randomize the run order of your entire design. Otherwise, you leave yourself open to “lurking factors,” such as ambient temperature and humidity changes, that could confound your factor estimates. After completing the experiments, standard statistical analyses provide significance tests on the overall outcome and individual effects. Textbooks provide hand-calculation schemes for doing analysis of two-level factorials, but it is much easier to let statistical software² do this work for you.

15.2.1 Case study — Screening Factors thought to Affect a Spin Coater

The following study comes from a short course on DOE.³ It will be described only briefly to give you an idea of what is required by a two-level factorial design. A spin coater used to apply a photo resist to a silicon wafer can be controlled by four machine settings:

- A. Speed (spin)
- B. Acceleration (spin up)
- C. Volume of resist
- D. Time (spin)

These four factors are numerical, because they can be adjusted to any value. However, for purposes of experimentation, they will be kept within ranges thought reasonable for keeping coating thickness in proximity to manufacturing specifications. Two more factors, both categorical, are thought to affect the process:

- E. Vendor of resist (two candidate suppliers)
- F. Cover for exhaust (on or off)

At this stage, it is uncertain which, if any, of these factors will significantly affect thickness, so it will be advantageous to perform the 16-run ($1/4^{\text{th}}$ fraction) medium-resolution design shown in [Table 15.2](#).

The data shown for thickness are collected by performing the design in random run order. Analysis reveals that only four factors are statistically significant: A, B, C, and E. With the aid of an eight-run follow-up study, it is further revealed that an interaction exists between factors C and E, as shown in [Figure 15.2](#).

Notice how the effect of changing volume of resist (factor C) depends on which vendor supplies the material (factor E). The bars at either end of each plotted line indicate the least significant difference (LSD) at the 95% confidence level. The overlap of these LSD bars at the low level of volume (3.0) indicates that it may be possible to run the spin coater in a way that will be robust to which vendor supplies the resist, thus freeing up the purchaser to pick whichever may be cheapest at any given time. Insights like

TABLE 15.2 Spin-Coater Design of Experiments

Standard	A: Speed (rpm)	B: Acceleration	C: Volume (cc)	D: Time (sec)	E: Vendor	F: Cover	Thick (Average)
1	6650	5	3	6	X	Off	4475
2	7350	5	3	6	Y	Off	4630
3	6650	20	3	6	Y	On	4334
4	7350	20	3	6	X	On	4534
5	6650	5	5	6	Y	On	4455
6	7350	5	5	6	X	On	4478
7	6650	20	5	6	X	Off	4222
8	7350	20	5	6	Y	Off	4523
9	6650	5	3	14	X	On	4440
10	7350	5	3	14	Y	On	4664
11	6650	20	3	14	Y	Off	4330
12	7350	20	3	14	X	Off	4515
13	6650	5	5	14	Y	Off	4566
14	7350	5	5	14	X	Off	4456
15	6650	20	5	14	X	On	4115
16	7350	20	5	14	Y	On	4467

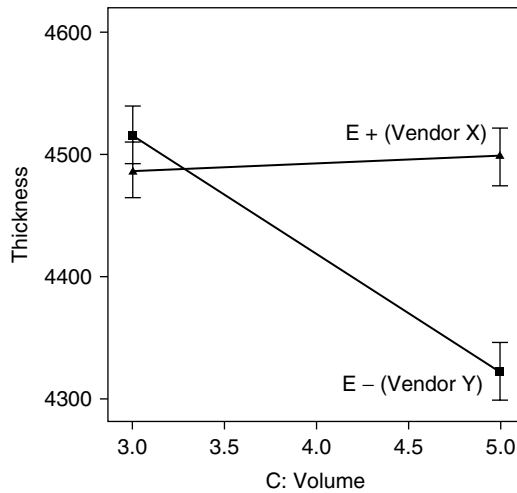
**FIGURE 15.2** Plot of two-factor interaction for spin-coater.

this can never be revealed by OFAT experimentation. Only by running combinations of factors at two levels do you learn about interactions.

15.3 Optimization via Response Surface Methods (RSMs)

If you believe your experiments are near the optimum, consider putting a “center point” in your design. This point represents one set of conditions at the middle of all factor levels (or component ranges in a mixture). For example, in the case study presented above, the center point of factors B, C, and D is (12.5, 4, 10). To get a reasonable estimate of curvature, repeat the center point several times mixed in randomly with the remaining design points. For example, four center points (all at identical conditions) could be added to the design in Table 15.2, increasing the number of runs from 16 to 20. If you are close to a peak of performance, you will see a significantly higher than expected response from the center points, thus

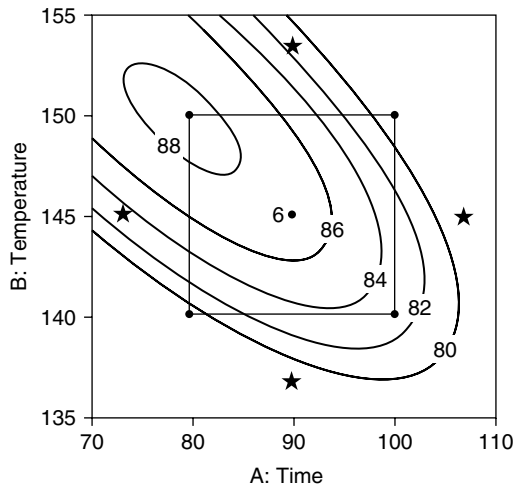

FIGURE 15.3 Contour plot showing points for central composite design.

revealing curvature (nonlinearity) in your response. Then, you will need to run additional factor levels and employ response surface methods (RSMs).

The central composite design (CCD) is a good choice for response surface experiments. It is composed of a core two-level factorial surrounded by axial points. Figure 15.3 shows the layout of points for a CCD on two process factors.

The axial points are symbolized by the stars. Any predictions outside of the two-level factorial square, including the star-point locations, require extrapolation, which may be dangerous. This design included six center points (time 90, temperature 145), half of which were done with the original factorial, and the others were included in a second block of star points.

Textbooks⁴ provide details on CCDs and a variety of other designs for RSMs. Statistical software supporting RSM is an absolute necessity for fitting the mathematical models (done via regression), validating them via statistical analysis, and generating the response surface graphs.

15.4 Mixture Designs for Optimal Formulation

For coatings experiments that focus only on formulation, we recommend the use of designs geared for mixtures. This involves using triangular coordinates set up to maintain a total of 100% for all ingredients. Figure 15.4 shows a three-dimensional view of a response surface generated from a mixture design on an automotive coating with three ingredients.

Details on the methodology can be found in textbooks⁵ and case-study articles on coatings experiments.^{6,7}

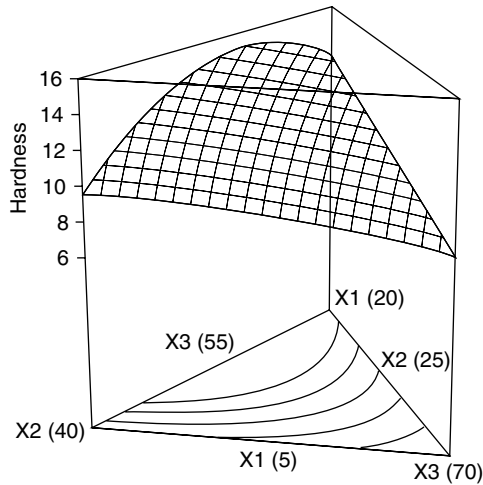

FIGURE 15.4 Three-dimensional response surface from a mixture design.

References

1. M. J. Anderson and P. J. Whitcomb, *DOE Simplified — Practical Tools for Effective Experimentation*. New York: Productivity, Inc., 2000.
2. T. J. Helseth, et al., Design-Expert® software. Minneapolis, MN: Stat-Ease, Inc.
3. P. J. Whitcomb, et al., *Experiment Design Made Easy*. Minneapolis, MN: Stat-Ease, Inc.
4. M. J. Anderson and P. J. Whitcomb, *RSM Simplified — Powerful Tools for Optimizing Processes via Response Surface Methods*. New York: Productivity, Inc., 2004.
5. J. A. Cornell, *Experiments with Mixtures*, 3rd ed. New York: John Wiley & Sons, Inc., 2002.
6. M. J. Anderson and P. J. Whitcomb, "Optimization of paint formulations made easy with computer-aided DOE for mixtures," *J. Coat. Technol.*, July, 71–75 (1996).
7. M. J. Anderson and P. J. Whitcomb, "Designing experiments that combine mixture components with process factors," *Paint & Coat. Ind.*, November, 68–72 (1999).

16

Top 10 Reasons Not to Base Service Life Predictions upon Accelerated Lab Light Stability Tests

16.1	Light Spectra.....	16-1
	Fluorescent Lamps • Xenon Arc Lamps	
16.2	Light Intensity	16-4
16.3	Temperature Sensitivity of Materials.....	16-4
	Standard Temperature • Humidity • Dark Stability • Linearity of Degradation • Reciprocity Failure	
16.4	Gas (Ozone) Fading.....	16-5
16.5	Catalytic Fading.....	16-5
16.6	Lux versus UV	16-5
16.7	Light Stability Testing Standards.....	16-5
16.8	Conclusion	16-6
	References	16-6

Eric T. Everett

Q-Panel Lab Products

The popularity of personal computers and digital cameras has ushered in an exploding new market of digital images printed from consumer printers. There is an endless combination of inkjet inks and commercial photo papers currently available in the marketplace. However, no one is really sure how long these printed images will remain lightfast. Image permanence is a big issue. Many OEM computer printer manufacturers, inkjet ink, and paper suppliers are rushing to develop a standardized light stability test protocol that will generate meaningful test data. But, this is inherently complex. There are a myriad of factors that can cause degradation of image quality besides ultraviolet (UV) light: ozone (or gas) fade, catalytic fading, humidity, dark stability, and temperature. Together or individually, each can wreak havoc on a treasured image. Following is a review of the major issues related to light stability testing of inks and substrates.

16.1 Light Spectra

It must first be stated that there is no standard light spectrum to replicate indoor lighting conditions. However, a recent Kodak study concluded that indirect window-filtered daylight is the dominant indoor lighting condition in homes.¹ Let us review some widely used laboratory light sources for light stability testing of printed images.

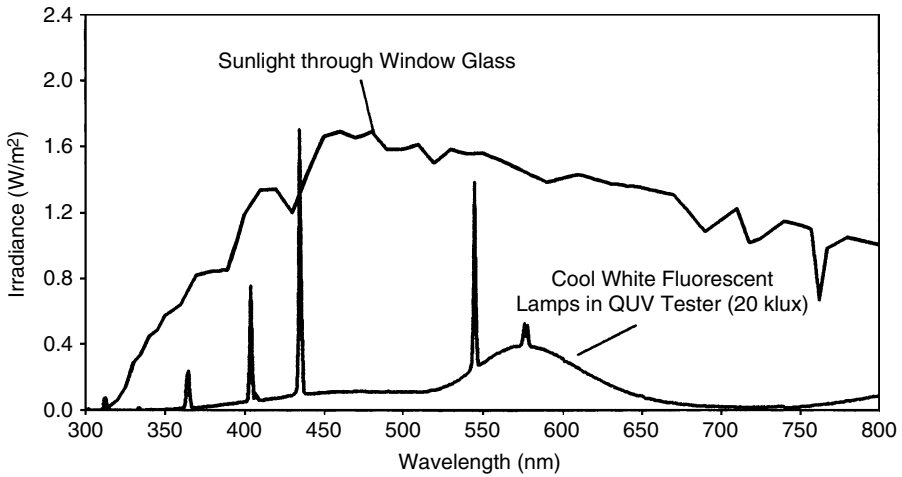

FIGURE 16.1 Cool white fluorescent lamp versus sunlight through window glass.

16.1.1 Fluorescent Lamps

Historically, light stability tests using high-output cool white fluorescent lamps have been used for color photographs. For example, the standard photography test condition (low-watt cool white fluorescent light at 450 lux/12 h per day, 60% relative humidity, and 70°F ambient room temperature) is not even close to approximating the variety of end-use environments of computer-generated images printed with inkjet inks. While the output of cool white fluorescent lamps may somewhat reproduce low light or office environments, the spectrum of these lamps is limited. That is, the lamp's output does not match the spectral power distribution of other commercially used light sources or sunlight through window glass (see Figure 16.1).

Cool white fluorescent lamps are useful for testing products with a primary end use that is in lighted display cases or in retail environments. (See Figure 16.2.) However, making service life predictions with this lamp type for images displayed in typical indoor environments (i.e., home or office) is inaccurate at best. For example, images displayed near windows, sliding glass doors, skylights, and the like can receive up to 50,000 lux of full spectrum sunlight (i.e., UV, visible, and infrared [IR]) in the morning hours on a clear day.



FIGURE 16.2 Accelerated cool white fluorescent testing is fast and easy in the QUV accelerated weathering tester.



FIGURE 16.3 The Q-Sun Xenon Arc Test Chamber is ideal for subjecting printing inks and substrates to full-spectrum sunlight.

16.1.2 Xenon Arc Lamps

The xenon arc was adapted for accelerated weathering in Germany in 1954. Xenon arc testers, such as the Q-Sun Xenon Test Chamber, are appropriate for photostability of materials because they provide the best available simulation of full spectrum sunlight: UV, visible, and IR light (see Figure 16.3).

Xenon arcs require a combination of filters to reduce unwanted radiation and to achieve the appropriate spectrum (e.g., outdoor sunlight or sunlight filtered through window glass). The “window glass” filter simulates sunlight through window glass. It is typically used to test products with a primary service life that will be indoors. Figure 16.4 shows the spectral power distribution (SPD) of noon summer sunlight behind glass compared to a Q-Sun Xenon arc with a Window Glass Filter.

The bottom line is that fluorescent lamps produce a much different light spectrum than sunlight or xenon-arc lamps. A lab light source should be selected to best match the product’s actual service environment. To help illustrate the significance of lamp selection, consider the following example.

An ink predicted to last 35 yr by using a cool white fluorescent lamp (450 lux/12 h per day) will only last for 1 yr at 50,000 lux at 3 h/day (equivalent to morning sunshine penetrating through a window).

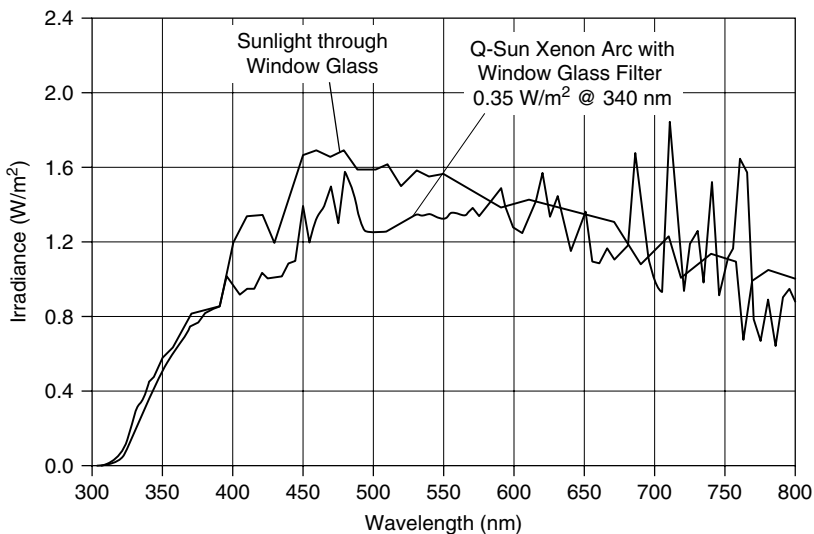

FIGURE 16.4 Q-Sun Xenon Arc with Window Glass Filter versus sunlight through window glass.

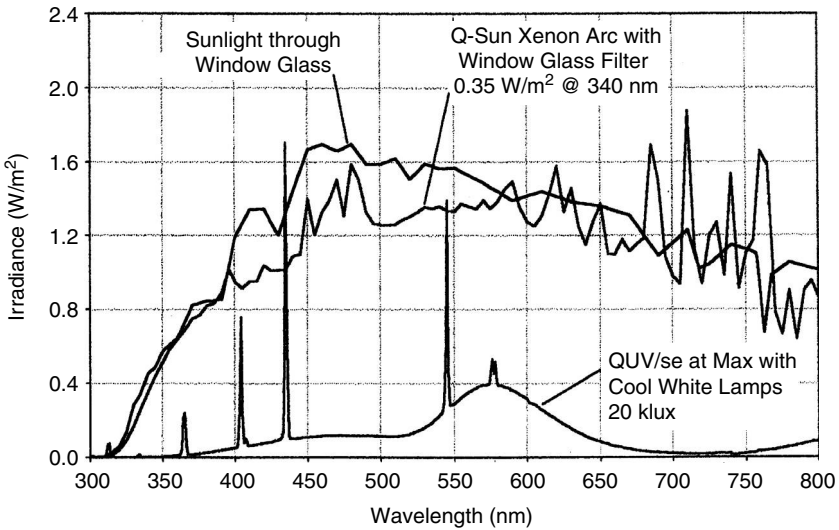

FIGURE 16.5 Xenon arc with window glass filter and cool white fluorescent lamp versus sunlight through window glass.

The explanation for this discrepancy is that the spectral output of the cool white fluorescent lamp source is very different than the spectral power distribution of window-glass filtered sunlight.

This example clearly demonstrates the danger of making service life predictions using a low intensity light source that does not account for high intensity, full-spectrum sunlight.

Figure 16.5 compares the SPDs for the cool white fluorescent lamp and Q-Sun Xenon Arc with Window Glass Filter versus sunlight filtered through window glass.

16.2 Light Intensity

There is no standard light intensity (irradiance) for indoor environments. As noted already, there are dozens of possible indoor environments, each with its own unique lighting conditions. As such, there is not one specific lab irradiance level to address all of these situations. In-service lux levels can range from 100 lux to 100,000 lux, depending upon the light source.

16.3 Temperature Sensitivity of Materials

Photochemical responses are material dependent and are influenced by temperature. In combination with UV light, high temperature will accelerate the photodegradation of many materials.

16.3.1 Standard Temperature

There is no standard indoor ambient temperature level. Ambient temperatures vary greatly between different regions of the world, and this can affect image durability. Images may degrade faster in a subtropical location like Miami, Florida, but remain relatively lightfast in a cool location like London.

16.3.2 Humidity

Like temperature, there is no standard ambient humidity level for indoor environments. Humidity levels can range from very low (e.g., air-conditioned home in Arizona) to very high (e.g., non-air-conditioned home in Florida). For inks, high humidity levels may cause dyes to migrate, causing uneven densities on substrate, resulting in color hue shifts (e.g., “blue shift”) or dye smear.

Humidity can also affect the substrate on which an image is printed. This may result in yellowing from photochemical reactions taking place in the ink receiving layers. A nonporous media is less sensitive to light and ozone but is more sensitive to humidity. Conversely, a porous media is more sensitive to light and ozone but is less sensitive to humidity.

16.3.3 Dark Stability

An image not only has to remain lightfast, but it must also be darkfast. Photochemical dye reactions can continue in the absence of light. These photochemical reactions are accelerated by temperature. An unstable ink may, therefore, “fade” in the dark.

16.3.4 Linearity of Degradation

Some images fade or change color in a linear fashion, while others may show very little change over an extended period of time. Then, suddenly, there can occur a dramatic color shift in the image.

16.3.5 Reciprocity Failure

Reciprocity failure refers to the condition when inks fade faster when exposed at a lower light intensity for a longer time period than inks exposed to higher-intensity light for a shorter time period. One explanation for this phenomenon is that, over a longer time period, inks are susceptible to other stressors besides light (i.e., ozone and humidity).

16.4 Gas (Ozone) Fading

Photooxidation of inks and media causes fade and color shift. Indoor air quality is yet another stressor to image permanence. Inks applied to porous media (e.g., paper) are more susceptible to gas fading than are “swellable” or gelatin-based media, where the inks are encapsulated.

16.5 Catalytic Fading

This phenomenon occurs when a particular combination of inks fades quickly, even though the individual inks are lightfast.

16.6 Lux versus UV

Photography test standards specify the use of lux as a means to time radiant dosage. But, lux is not a useful measurement tool when evaluating light stability of printed images. While it would seem logical to use lux because it is based upon the human eye’s response to light (centered around 520 nm), significant photodegradation may result from the short-wave UV region that goes undetected when one uses lux as a measurement device, especially for substrates. A more appropriate measurement would be to use radiant energy measured in watts per square meter (W/m^2).

16.7 Light Stability Testing Standards

There is work underway within the ISO Working Group 3/Task Group 5, Methods of Measuring Stability of Color Pictorial Images to write test standards for indoor light stability and outdoor durability. The subcommittee is also developing standards addressing humidityfastness, ozone fade, and thermal degradation/dark stability.

The proposed ISO indoor light stability standard will specify three test conditions: (1) cool white fluorescent lamps, (2) xenon arc, and (3) tungsten lamps. These three light sources were chosen to cover

various indoor lighting conditions. Xenon arc with a Window Glass Filter is the preferred test condition for light stability testing in the proposed ISO standard. It provides the best available simulation of full-spectrum sunlight through window glass. This standard is in the early draft stages and will probably not be approved and published for at least 1 to 2 yr.

The ASTM D01.56 Printing Inks Subcommittee revised one of their existing test methods that addresses light stability of printing inks. ASTM D3424, "Lightfastness and Weatherability of Printed Matter," specifies Outdoor behind Glass exposure in Florida, Xenon Arc with Window Glass Filter, and Cool White Fluorescent lamp exposure in accordance with ASTM D4674, "Color Stability of Plastics." Radiant dosage for the natural outdoor exposure is 1260 mJ at 300 to 400 nm, while the xenon arc exposure is 510 kJ at 340 nm. Also, the ASTM F05.07 Ink Jet Imaging Products Subcommittee has recently approved and published in 2005 a new ASTM standard for light stability testing of digital ink jet inks. The standard is titled ASTM F2366, "Lightfastness of Ink Jet Prints Exposed to Window-Filtered Daylight."

There are several accelerated light stability testing options available depending upon one's needs. For example, fluorescent UV testing in a QUV using cool white lamps is appropriate for simulating indoor lighting conditions. Xenon arc testing with a window glass filter is appropriate for simulating sunlight through a window, while xenon arc testing with a daylight filter is appropriate for simulating direct outdoor exposure to sunlight. In addition to accelerated laboratory testing, natural outdoor exposure testing should always be conducted (i.e., direct and behind glass exposures) to establish an appropriate benchmark for end-use applications and service environments.

16.8 Conclusion

These "top 10" reasons confirm that predicting a printed image's service life is difficult, at best. Because of the multitude of environmental factors that can work independently or in tandem with UV light, one should be extremely cautious when estimating an image's lightfastness. In addition, there is a complex interrelationship between coating, ink, and substrate.

One cannot simply input data in the form of absolute values into a mathematical equation to generate accurate lifetime predictions. However, by using rank order correlation, one can compare the relative performance of one particular ink and substrate to another. In correlating accelerated and real exposure tests, the rank performance of the materials exposed to both environments is compared, and the strength of the association between the tests is therefore established.

With the correct choice of operating conditions, accelerated laboratory lightfastness testing can provide extremely useful results that are typically much faster than natural, real-time testing. These results can be used to rapidly assess probable product performance.

Comparative data are powerful. While accelerated testing of any type is not capable of producing the "silver bullet" to determine absolute correlation with real-world results, the benefits of comparative data cannot be ignored. It can be used to qualify new or existing printing ink systems, develop ink and substrate reformulations that have improved lightfastness and durability, expedite the approval process to bring a new product to market, establish baseline quality control requirements, and ultimately, establish an industry standard for the printing of digital images.

Accelerated testing can quickly provide critical information about an ink or substrate's durability under varying service environments, which is essential to meet the ever-changing demands of this new and dynamic industry.

References

1. Bugner, D. et al. "Survey of environmental conditions relative to display of photographs in consumer homes." *13th International Symposium on Photofinishing Technology Proceedings*, 31–36, 2004.

17

Under What Regulation?

17.1	Introduction	17-1
17.2	Code of Federal Regulations	17-1
17.3	Title 29 (Labor)	17-1
17.4	Protection.....	17-2
17.5	Biocides	17-3
17.6	Testing	17-3
17.7	Volatile Organic Substances (VOCs)	17-3
17.8	Food and Drug Administration (FDA)	17-3
17.9	Which Regulation?	17-4

Arthur A. Tracton
Consultant

17.1 Introduction

Civilization is based on laws and regulations for the common good. Way back, the law was as simple as, “don’t kill each other.” As time passed and technology grew, the laws and regulations became more complex to keep up with the technology. Regulations were and are issued by the federal government, the state government, the county government, and the local government. With everyone enacting regulations, confusion abounds. There are just too many regulations to compile in a single list. The following looks at some of the major regulations governing the coatings and inks industries.

17.2 Code of Federal Regulations

The government of the United States of America discusses possible regulations and publishes the discussion in the *Federal Register* on a daily basis. When it is concluded that a regulation, or change in regulation, is needed, it will be published in the Code of Federal Regulations (CFR). This CFR is an enormous work comprising some 50 titles, each subdivided into a number of books.

17.3 Title 29 (Labor)

In Title 29 (Labor) is section XVII (Occupational Safety and Health Administration, Department of Labor). Under this section is part 1910.1200, Material Safety Data Sheet (MSDS). The MSDS started by proposing safety considerations for asbestos during the process of cutting ships apart. It has progressed to cover almost all chemicals used in industry and commerce. The MSDS lists the manufacturer responsible for the product, the composition, and safety and health concerns. This form has gone, in practice, from seven sections to 16 or more. An example listing of the section titles is as follows:

- Section 1: Chemical Product and Company Identification
- Section 2: Composition Information or Ingredients
- Section 3: Hazards Identification
- Section 4: First-Aid Measures
- Section 5: Fire Fighting Measures
- Section 6: Accidental Release Measures
- Section 7: Handling and Storage
- Section 8: Exposure Controls and Personal Protection
- Section 9: Physical and Chemical Properties
- Section 10: Stability and Reactivity
- Section 11: Toxicological Information
- Section 12: Ecological Information
- Section 13: Disposal Considerations
- Section 14: Transport Information
- Section 15: Regulatory Information
- Section 16: Other Information

Note that the MSDS for each product is to be updated every year and distributed to product users. Under the section on Regulatory Information, all sorts of abbreviations and acronyms can be found. Some of these are as follows:

- WHMIS (Canada): Controlled Substances
- WHMIS (Canada): Hazard Classification
- Superfund SARA 311-312: Hazard Classification
- Superfund SARA313: Disposal
- TSCA: U.S. Toxic Substances Control Act
- DSL: Canadian Domestic Substances List
- CEPA: Canadian Environmental Protection Act
- EINECS: European Inventory of Existing Commercial Chemical Substances
- AICN: Australian Inventory of Chemical Substances
- NICNAS: Australian National Industrial Chemical Notification and Assessment Scheme
- MITI: Japanese Handbook of Existing and New Chemical Substances
- ECL: Korean Toxic Substances Control Act
- CPM: Inventory of Existing Chemical Substances in China
- RICRA: Resource Conservation and Recovery Act
- State Right to Know: Including Massachusetts, New Jersey, and Pennsylvania California Proposition 65
- CONEG: Coalition of New England Governors

17.4 Protection

We want to protect the environment and materials in transit. Some of these regulations and abbreviations include the following:

- DOT: Department of Transportation
- 49 CFR (Title is Transportation) 107: Packing for Hazardous Material
- 49 CFR 172: Shipping
- 40 CFR (Title is Protection of Environment) 60 and 61: Clean Air Act
- 40 CFR 261.20 to 261.24: Classification as Hazardous Waste
- 40 CFR 401: Clean Water Act

17.5 Biocides

If biocides are used, they are regulated under The Federal Insecticide, Fungicide and Rodenticide Act (FIFRA). Some exemptions may be found in 40 CFR 152. This may include working through an EPA (Federal Environmental Protection Agency) approach for biocides used in Paints and Coatings.

17.6 Testing

A lot of testing is performed by governmental and independent laboratories to determine if a hazard exists, and if so, what is tolerable. The following list contains terms found in several sections of the MSDS:

OSHA: Occupational Safety and Health Administration
NIOSH: National Institute for Occupational Safety and Health
TLV: Threshold Limit Value
TWA: Time Weighted Average
PEL: Permissible Exposure Level
NTP: National Toxicity Program
IARC: International Agency for Research on Cancer
ANSI: American National Standards Institute
ISO: International Standards Organization
ACGIH: American College of Governmental Industrial Hygienists
NFPA: National Fire Protection Association
CPSC: Consumer Products Safety Commission
FHSA: Federal Hazardous Substances Act (administered by CPSC)

17.7 Volatile Organic Substances (VOCs)

Around 1966, Los Angeles, California, enacted a regulation called Rule 66 to try to stop the release of photogenic materials into the atmosphere which cause “smog.” This rule dictated what materials are controlled and at what levels. Xylene could only be at 12 volume percent in a paint. Toluene was at 20 volume percent. Soon afterwards, San Francisco enacted Regulation 3, which is the same thing. Years later, the concept of photochemically reactive solvents spawned the volatile organic compounds (VOCs) concept of total release of any solvent into the atmosphere. These rules and regulations have gone through a number of iterations. Some solvents were banned and then reinstated for use as more testing was performed. Now we have “Hazardous Air Pollutants” (HAPs). Some solvents meet this ever-changing standard, and some do not.

17.8 Food and Drug Administration (FDA)

When a coating or ink is related to food, drugs, or cosmetics, another set of regulations covers the area. This is Title 21 of the CFR (Food and Drugs). Section I, Food and Drug Administration, Department of Health and Human Services, covers the materials that may come in direct or indirect contact with foods and what materials may be used in cosmetics and drugs. For example, colorants (pigments and dyes) are covered in one area, while resins and binders are covered in another area. Note that neither the FDA nor the USDA (United States Department of Agriculture, another set of regulations) will stipulate the compliance of a paint or ink to a regulation. The best you can get is that the ingredients are listed somewhere.

17.9 Which Regulation?

The above lists are by no means complete. They give an indication of what is happening. Many companies retain employees just to handle the regulations to make sure they are in compliance. In the long run, the question is, “What are the regulations for your product?”

II

Coating and Processing Techniques

18

Wire-Wound Rod Coating

18.1	Introduction	18-1
18.2	History	18-2
18.3	Theory and Principle	18-3
18.4	Film Thickness.....	18-4
18.5	The Rod Coating Station.....	18-4
	Rod Station Variations	
18.6	Advantages and Disadvantages.....	18-7
	Low Cost • Precise Coat Weights • Lower Setup Cost • Less Edge Wear • Limitations	

Donald M. MacLeod
Industry Tech

18.1 Introduction

Wire-wound metering rods have been used for more than 75 years to apply liquids evenly to flexible materials. They were the first tools used to control coating thickness across the full width of a moving web. The 1980s saw a new popularity in rod use because of improved quality and the industry trend toward shorter converting runs. Wire-wound rods are used in a wide range of applications but find their greatest appeal in the manufacture of tapes, labels, office products, and flexible packaging. The first rods were made of ordinary carbon steel, wrapped with music wire. Today's metering rods use precision-ground core rods made of stainless steel, tightly wound with polished stainless steel wire at high speeds, on custom-designed winding machines. The resulting product is a laboratory-quality precision tool that can control coating thicknesses accurately within 0.0001 in. (0.1 mil). A typical wire-wound rod station is shown in [Figure 18.1](#).

Also called applicator rods, Mayer bars, equalizer bars, coating rods, and doctor rods, this equipment has found uses in a wide variety of production applications, from the manufacture of optical films to wallboard panels. Wire-wound metering rods look deceptively simple. A stainless steel rod is wound with a tight spiral of wire, also made of stainless steel. The wire can be so small that it is almost invisible to the naked eye, or so large that the windings look like the coils of a hefty spring. Today, the industry has standardized on stainless steel rods because they can be used with almost every coating liquid. Earlier problems with rust and corrosion have been virtually eliminated. Where abrasive wear is a problem, some converters use chrome plating to prolong the life of the rod because of the hard surface presented by chromium. Chrome has its drawbacks, however, as it builds up unevenly at the extreme tops of the wires, changing the shape of the wires and the resulting coating thickness. Also, if not applied properly, chrome can acquire pitting marks or can flake off, contaminating the coating bath or causing uneven coating. Several new products introduced since 1985 have further expanded the market for rods. Where streaking or rod cleaning is a problem, rods with a Teflon surface are available. Particles that might wedge between stainless steel wires tend to slide through, preventing buildups and subsequent streaks in the

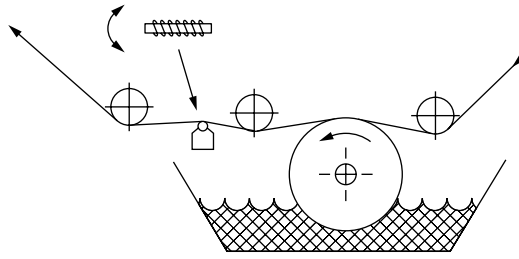

FIGURE 18.1 Typical coating station.

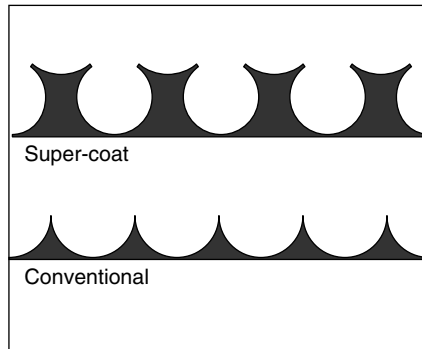

FIGURE 18.2 Super-Coat flow pattern.

coating. Other users find the Teflon surface easier to clean, and a few claim increased rod life up to eight times that of stainless steel rods. Super-Coat* rods are conventional rods with a second, smaller wire wound around the primary wire of a normal rod. The shape of the grooves between the wires is altered drastically, which allows certain coaters to produce controlled coatings more than twice as thick as with conventional rods (see Figure 18.2). Others users find that for any given coating thickness, the deeper grooves between the wires are spaced closer together and provide a smoother finish on the product.

Today's coating machines have wider webs and run at higher speeds, outproducing earlier equipment many times over. Meanwhile, the market for coated material requires more and more specialized products, and hence, more frequent changeovers and setups. Compared with other coating methods, changing coating rods requires little downtime for changeover and makes precise control of coating weight without changing formulations a practical consideration for many coaters.

18.2 History

In 1905, Charles W. Mayer founded the Mayer Coating Machines Company in Rochester, New York. The firm made equipment for manufacturers of carbon and wax papers, two new and growing industries. These machines used "equalizer bars" or "doctor rods," the forerunners of today's precision metering rods. The rods were made of carbon steel wound with different sizes of music wire. Mayer was issued a series of patents on his coating machines, including one in 1912 that covered his equalizer bars. Coaters of carbon and wax papers found that they could easily change the thickness of their coating by switching rods, so they began ordering rods with different wire sizes. Also, the early rods tended to rust and wear out, so Mayer found a ready and growing market for replacement rods, which became an important part of his business as more machines were shipped. Mayer's success in the coating machinery business became the target of federal antimonopoly laws, and he was forced to release his designs and patents to others

*Product of Consler Scientific Design, Inc., St. Petersburg, Florida.

in the 1930s. New companies sprang up, and their machines used doctor blades and roll coating methods, in addition to wire-wound rods. Under the federal guidelines, Mayer was not required to expose his proprietary techniques for making equalizer bars. The Mayer factory continued to produce these rods on special winding machines that were developed for this purpose. As his machinery business declined, rod manufacturing continued to expand.

During this period, Mayer hired Ralph J. Consler on a contract basis, as a design engineer to develop new equipment for the still-growing carbon paper industry and the new “multiform” carbon coating market. Consler and another designer, Bruce DeNeve, formed DeNeve & Consler Company, a partnership in Rochester, New York, in 1940.

18.3 Theory and Principle

Coating thickness is governed by the cross-sectional area of the grooves between the wire coils of the rod, as shown in Figure 18.3. The geometry of this system creates a wet film thickness directly proportional to the diameter of the wire used. For example, you can double the coating thickness by doubling the wire size.

The groove between the wires determines the precise amount of coating material that will pass through. The initial shape of the coating is a series of stripes, spaced apart according to the spacing of the wire windings. Almost immediately, normal surface tension pulls these stripes together, forming a flat surface, ready for drying in air or under heat. Wet film coating thicknesses, accurate to 0.1 mil, can easily be achieved using metering rods. Mathematically, the average thickness of the area between the wires, and therefore the coating thickness, is 0.173 times the wire diameter. From a practical standpoint, most users use a 1:10 ratio to select the best theoretical rod size for a given wet coating thickness. A rod wound with an 0.015 in. diameter wire, for example, will ideally produce a wet film that is 0.0015 in. (1.5 mil) thick. In production coating, other physical factors can influence the actual coating thickness. The most important of these is the phenomenon of shearing action of the liquid. In effect, not all the coating material passes through the gaps; some liquid adheres to the surface of the wire. The impact of this is usually small, but it can be significant when small (0.025 to 0.005 in.) wires are used or when viscosities are high. In high volume coating operations, the speed of the web, web tension, penetration into the base material, and other factors will also affect the coating thickness. The sum of all these variations seldom exceeds a 20% difference from the theoretical coating weight; however, the differences can be large enough to suggest a trial-and-error procedure for selecting the ideal wire size for each coating application. Because of the relatively low cost of rods, and the ease of changing from one wire size to another, the selection process is both economical and practical. Most coatings laboratories have a set of “lab rods,” which are shorter versions of production coating rods in a variety of wire sizes. To test a coating for coverage, adhesion, opacity, or other characteristics, drawdown samples are made and examined. A piece of the substrate material is attached to the flat surface, and some coating liquid is puddled near the top of the substrate sample. A lab rod with a preselected wire size is chosen and pulled manually through the liquid, meeting a precise thickness of coating on the substrate.

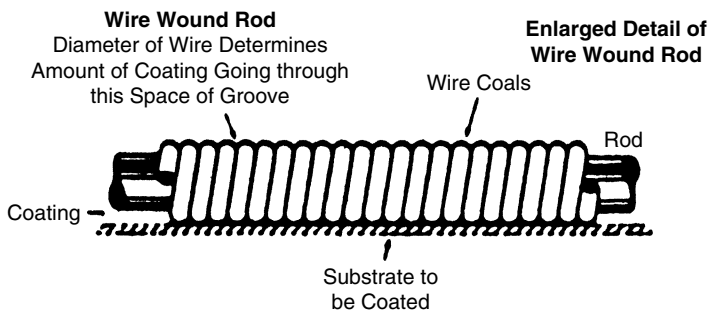

FIGURE 18.3 Rod design.

TABLE 18.1 Wire Size Selection Chart

Wire Size	Wire Diameter (inches)	Wet Film Thickness (mils)	Wet Film Thickness (microns)	Wire Size	Wire Diameter (inches)	Wet Film Thickness (mils)	Wet Film Thickness (microns)
#0	None	0.00	0.0	#38	0.038	3.8	96.5
#2	0.0025	0.25	6.4	#40	0.040	4.0	101.6
#3	0.003	0.3	7.6	#42	0.042	4.2	106.7
#4	0.004	0.4	10.2	#44	0.044	4.4	111.8
#5	0.005	0.5	12.7	#46	0.046	4.6	116.8
#6	0.006	0.6	15.2	#48	0.048	4.8	121.9
#7	0.007	0.7	17.8	#50	0.050	5.0	127.0
#8	0.008	0.8	20.3	#52	0.052	5.2	132.1
#9	0.009	0.9	22.9	#54	0.054	5.4	137.2
#10	0.010	1.0	25.4	#56	0.058	5.6	142.2
#11	0.011	1.1	27.9	#58	0.058	5.8	147.3
#12	0.012	1.2	30.5	#60	0.060	6.0	152.4
#13	0.013	1.3	33.0	#62	0.062	6.2	157.5
#14	0.014	1.4	35.6	#64	0.064	6.4	162.6
#15	0.015	1.5	38.1	#66	0.066	6.6	167.6
#16	0.016	1.6	40.6	#68	0.068	6.8	172.7
#17	0.017	1.7	43.2	#70	0.070	7.0	177.8
#18	0.018	1.8	45.7	#72	0.072	7.2	182.9
#19	0.019	1.9	48.3	#74	0.074	7.4	188.0
#20	0.020	2.0	50.8	#76	0.076	7.6	193.0
#22	0.022	2.2	55.9	#78	0.078	7.8	198.1
#24	0.024	2.4	61.0	#80	0.080	8.0	203.2
#26	0.026	2.6	66.0	#82	0.082	8.2	206.3
#28	0.028	2.8	71.1	#84	0.084	8.4	213.4
#30	0.030	3.0	76.2	#86	0.086	8.6	218.4
#32	0.032	3.2	81.3	#88	0.088	8.8	223.5
#34	0.034	3.4	86.4	#90	0.090	9.0	228.6
#36	0.036	3.6	91.4	a			

^a For coating up to 0.190 in. thick, use Super-Coat rods.

The quality of test samples made by hand is largely dependent on the skill of the technician. Variations in rod pressure, angle of stroke, and speed can cause differences in the thickness and consistency of drawdown samples.

18.4 Film Thickness

A wire-wound rod applies a finite thickness of liquid to a web of base material. In production coating operations, it is difficult to measure the actual thickness of a wet coating before it starts to dry through evaporation, although there are gauges made for this purpose. In addition, many substrate materials are absorbent, so there may be little or no actual increase in thickness after coating. If the coating is applied to a hard, nonabsorbent material and is allowed to dry, its dry thickness can be measured accurately with micrometers or other dry thickness gages. Table 18.1 compares the calculated wet film thickness to the wire diameter of metering rods. The 10:1 ratio between wire diameter and wet film thickness allows an easy selection of the required rod.

18.5 The Rod Coating Station

In production coating, the web must pass through a wetting station and then to the metering rod, where a measured thickness of coating is allowed to pass between the wires, and the excess liquid is returned to the reservoir. The coating liquid may be applied at the wetting station by several different methods.

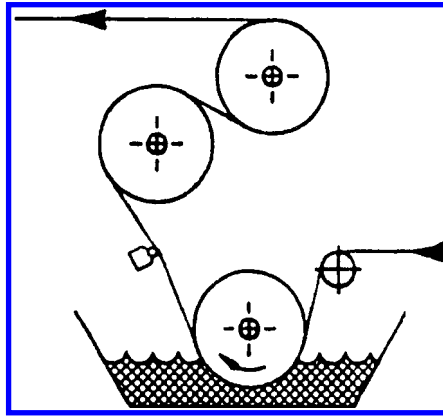

FIGURE 18.4 Web immersion method.

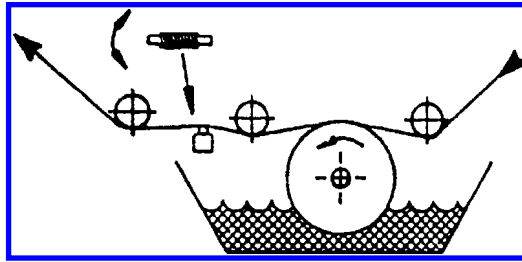

FIGURE 18.5 Applicator roller method.

The web can be immersed directly into a tank (Figure 18.4); or an applicator can be rotated in the reservoir to transfer the liquid to the web at the top of its rotation (Figure 18.5). It is important to apply an excess of coating liquid at this station, to let the metering rod do its job.

When an applicator roller is used in a rod coating system, the speed of the applicator is not a critical factor. In addition, the machine operator can adjust the applicator roller speed within a side range, even while the machine is running. The web passes over the metering rod, which may be stationary or may be rotated slowly. The rotation may be either in the same direction as the web or in the opposite direction. The choice of stationary rod depends on movement with different coaters and with different products. Establishing the ideal speed of rotation will also be different from job to job, and converters experiment to find the best procedure for each run. The most common procedure, however, is to rotate the rod slowly in the opposite direction to the movement of the web. The rotation flushes the coating material between the wires, keeping the wire surfaces wet, and preventing setting up and hardening of some liquids. The rotation also distributes any abrasive wear evenly on the wires and prevents flat spots from forming. The purpose of the metering rod is to remove excess coating liquid, allowing a measured amount to pass between the wire windings. The web should pass above the rod, to allow the excess liquid to fall back into the tank. The web, however, need not be perfectly horizontal, as long as the surplus coating can return to the tank through gravity. Metering rods for production coating can be made in a wide variety of sizes. The most common core rod diameters are quite small (3/16 and 1/4 in.), although sizes up to 1 in. diameter are also used. The main advantages of small-diameter rods are their low cost and ease of storing and handling.

These thin rods must be supported in the coating machine, because they are not rigid and will deflect with pressure from the web. There are several types of rod holder in common use; the simplest is a square of a rectangular steel bar, with a “V” groove machined into it. This rod holder is mounted between the side frames of the coating machine, and the metering rods are placed in the grooves. The “V” groove

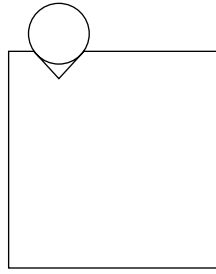

FIGURE 18.6 Rod holder.

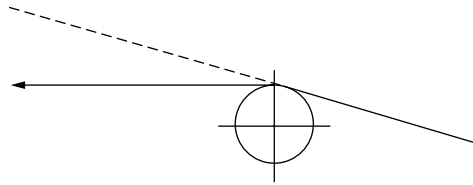

FIGURE 18.7 Wrap angle.

should be ground and polished to minimize wear on the rod and should be mounted accurately, at a right angle to the direction of web travel and parallel to the idler rollers of the machine (Figure 18.6).

The design of a rod coating station should ensure that the web makes intimate contact with the wires of the metering rod. The wrap angle, the angle between the web direction as it approaches the rod, and its direction as it leaves the rod, should be 15° for a heavy web tension or up to 25° for a light web tension (Figure 18.7).

Web tension is a critical factor in the design of a rod coating station. With a wrap angle of 15 to 25° , the web must be tight enough to ensure intimate contact with the metering rod, yet not so tight that the web is deformed by the wires. Adhesives and some other liquids can solidify between the wire windings of the rod whenever the coater is stopped. Many coating machines have a “throw-off” feature, a mechanical means of separating the web from the rod automatically, whenever the machine is turned off. This allows for quick removal of the rod for flushing and cleaning before the coating material has a chance to congeal between the wires (Figure 18.8).

This automatic releasing feature also simplifies rod changing between production runs. One method used by coating machine manufacturers is a rocker arm throw-off system. A series of idler rollers presses the web against the metering rod while the coating machine is running. Whenever the coater is stopped, the idlers automatically rise, lifting the web up, away from the metering rod. At the same time, a water flushing system can be triggered to remove coating material from the rods before it can set up. Other techniques involve lowering the metering rod and its holder when the coater is turned off.

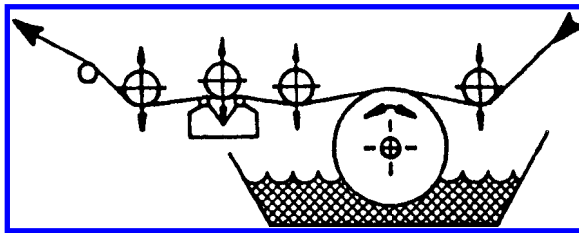

FIGURE 18.8 Automatic throw-off.

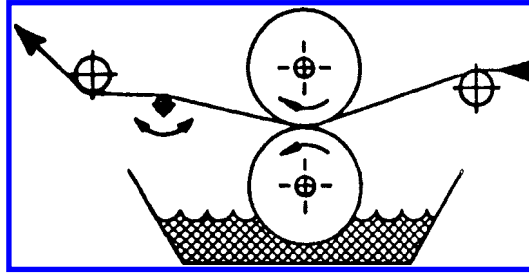

FIGURE 18.9 Smoothing rod.

18.5.1 Rod Station Variations

Every coating application is different. Converters have created many unique systems for rod coating that they developed through experimenting in the lab or in actual production. A smoothing rod is a finely polished metering rod without wire, which is used several different ways. It can be used in the web path after printing with a gravure cylinder, to eliminate the etched pattern and enhance the coated surface. It also can be used after a wire-wound metering rod, when the viscosity of the coating liquid prevents it from leveling through the surface tension effect (Figure 18.9).

When a large amount of coating liquid must be metered off the web, two wire-wound rods are used in tandem, spaced 1 or 2 in. apart. The first rod has a larger wire size for doctoring off most of the excess liquid, and the second, smaller wire rod controls the finished coating thickness.

A typical coating station may use one or two metering rods and also have a position for a smoothing rod, which can be engaged for certain applications. The coating roll applies liquid to the moving web that is metered off by one or two rods, and then it can be flattened by the smoothing rod. The complete coating station design must also consider draining, filtering, and pumping the coating liquid, controlling the wet edge of the web, and disengaging the metering rods when the machine is stopped.

18.6 Advantages and Disadvantages

Metering rod coating is the third most popular method in use today, behind gravure and reverse roll coating.

18.6.1 Low Cost

Rod coating stations are relatively inexpensive and easy to add to existing coaters. Replacing worn or damaged rods, and changing from one coating weight to another, are both inexpensive and fast. The machine downtime for changing rods or cleaning them can be measured in minutes instead of hours, using much less labor than is required by other coating systems.

18.6.2 Precise Coat Weights

Metering rods can be selected to control the wet coating thickness in 0.1 to 0.2 mil increments, without changing the coating formulation.

18.6.3 Lower Setup Cost

Another important factor in the new popularity of rod coating is the worldwide trend toward shorter and shorter production runs. The faster setups inherent to rod coating allow the converter more productive running time, in addition to lower labor costs for changeovers.

18.6.4 Less Edge Wear

Rod coating offers the converter other advantages because of the method used to control wet edges. In a rod coating system, the dry edge is controlled by wipers or deckle straps on each edge of the applicator roll. Because the wipers are constantly wet with coating liquid, the tendency to scratch the roller is reduced. Even when scoring eventually occurs, it is on the applicator roll, not on the metering rod (which controls the final coating thickness). Also, because the wipers are easily moved, their positions can be adjusted while the coater is operating, with no downtime.

18.6.5 Limitations

Standard metering rods work best with low viscosity liquids, which will flow easily between the wire windings. Two-wire Super-Coat rods can be used where viscosities are higher, however. Rod coating also can be used for a flat web, without tight or baggy edges. In production rod coating, the actual thickness of the coating can be affected by web speed, viscosity, and other factors. Depending on the application, rod coating speeds are usually limited to 1000 ft/min, although some coaters claim web speeds up to 2000 ft/min. The critical factor in the web speed of a rod coating system is the time required for the striations formed by the rod to level. The rod meters liquid by allowing a measured amount to flow through the spaces between the wires. Normal surface tension forces the raised portions to flow out and form a flat, even coating, but there is a time element involved, which is different for each coating material. The web speed must be controlled to allow time for leveling before the web is dried.

19

Slot Die Coating for Low Viscosity Fluids

19.1	Introduction	19-1
19.2	Manifold Theory and Design	19-1
19.3	Air Entrapment	19-4
19.4	Lip Design	19-4
	Lip Adjustment Design • Lip Wiping Face Design	
19.5	Die Adjustment as It Relates to Manifold Design	19-6
19.6	Coat Weight Adjustment	19-6
19.7	Adhesive Selection	19-6
19.8	Die Steel and Piping Selection	19-6
19.9	Proximity versus Contact Coating	19-6
19.10	Die Positioning	19-8
	Slot Head-to-Roll Position and Angle of Contact • Lip Profiling • Die Support Design and Operation • Support and Adjustment System Design Specifications • Die-to-Roll Positioning • Angle of Attack Position Adjustment • Lip Opening Setup • Die-to-Roll Gap Setup	
19.11	Backup Roll Design	19-12
19.12	Automatic Control	19-12
	Die Control • Die-to-Roll Position Adjustment System	
19.13	Deckling	19-14
	Air Entrapment behind Deckling	
19.14	Die Cleanup	19-14

Harry G. Lippert
Extrusion Dies, Inc.

19.1 Introduction

Slot head coating has spawned a wide range of designs, some quite radical in their concept. This chapter discusses conservative manufacturing experience along with the experience of a wide variety of processors currently utilizing the proximity or wipe-on method.

19.2 Manifold Theory and Design

The primary purpose of a die is to define a width and provide an even coating in terms of cross-sectional thickness and smoothing. The manifold and coat-hanger section of the die is the main component in accomplishing uniform distribution. Smoothing will be addressed in a later section.

There are two basic styles of manifold design in use today: coat-hanger shaped, with a volumetrically reducing cross section (Figure 19.1), and T-shaped, with a constant cross section (Figure 19.2).

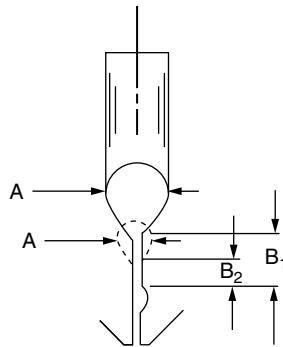
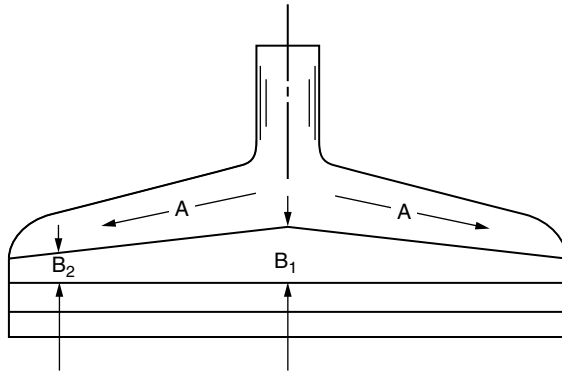

FIGURE 19.1 Coat-hanger volumetrically diminishing manifold.

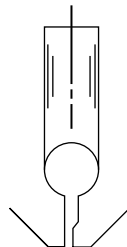
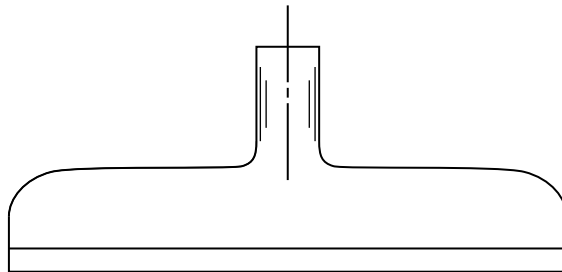

FIGURE 19.2 Constant cross-sectional manifold.

In either style, flow through the manifold is analogous to flow through a pipe in that there is an increasing resistance to material flow as the length increases. The wider the die (the longer the pipe), the greater the resistance to flow. It follows then that the primary criterion in a good die design is to ensure adequate flow to the ends of the die as the width requirements increase.

The coat-hanger-style die utilizes a slot section (preland) with a varying length downstream of the manifold to compensate for this pressure increase (see area B , Figure 19.1). The pressure drop in the preland section must decrease at the same rate it increases in the manifold section. If the sum of these two components is equal at any point in the overall flow stream, the result is an even flow.

It can be seen that while the generic coat-hanger-style design is fixed, the overall dimensions may vary greatly, depending on a given die width, flow rate, or general coating material requirements. Generally, as the die gets wider, the length of the preland section (B_1) must get longer and the manifold larger; as the flow rate increases, the manifold must get larger as well as the height of the gap at B_1 . The compensating preland section downstream of the manifold allows the die design to be varied greatly to suit a given application.

These large internal designs are used for applications characterized by coating materials that vary greatly in viscosity levels or call for an extreme range of flow rates. Larger flow channels are less sensitive to rate and viscosity changes than are small channels. Small internal designs are used for materials that require a low residence time in the die because of thermal degradation, or high shear rates to prevent gelation (thixotropic materials).

In analyzing the coat-hanger manifold, it must be emphasized that the manifold decreases in cross section as it approaches the ends of the die (dimensions A in Figure 19.1); this rate of reduction may also be changed to suit a specific application. Because material is flowing out of the front of the die along its entire width, less material is presented to the manifold as it approaches the ends of the die. The reduction in manifold volume is an attempt to keep the velocity of the material at the ends of the die to a maximum, to compensate for the lower flow rate, and to prevent carbonization of the resin or changes in viscosity in a thixotropic or dilatant adhesive.

In summary, it can be seen that the coat-hanger manifold design can be modified to suit an application and still accomplish the primary criterion of even flow distribution. To adequately design a coat-hanger die, the following information is required:

1. Rheology curve (see Figure 19.3) — a rheology curve, a fingerprint of a particular resin, predicts its viscosity level at a given shear rate; this is required for all non-Newtonian or shear thinning fluids
2. Flow rate or range of rates
3. Material density at processing temperatures
4. General material characteristics, such as heat degradability or thixotropy

The T-shaped manifold in the constant cross-sectional style (see Figure 19.2) has no compensating preland section; this is because of its inherent design. Rather, this style of die design relies on a larger manifold section to reduce the resistance to flow to the ends of the die; the larger the manifold, the less the resistance and the better the flow distribution. In theory, there can never be an even distribution, because no matter how large the manifold is, there will always be some pressure drop across it and, therefore, less flow to the ends of the die when compared to the center.

The larger manifold has some drawbacks in that the residence time is greatly increased and flow at the ends of the die is nearly stagnant. The overall internal flow channel design cannot be increased or decreased to suit a given application, as it is restricted by the need for manifold size to achieve some flow distribution.

If the flow presented to the die is not constant over time, if the fluid is not homogeneous in terms of temperature and mix, and because there are inherent errors in viscosity measurement and theoretical flow calculations, thickness variations will sometimes occur. To adequately adjust these flow variations, a flexible lip is required as a fine-tuning adjustment.

Having multiple entrances or a pump within a die simply represents attempts at producing uniform distribution, minimizing the effect of transverse pressure drop, and simplifying the job of manifold design.

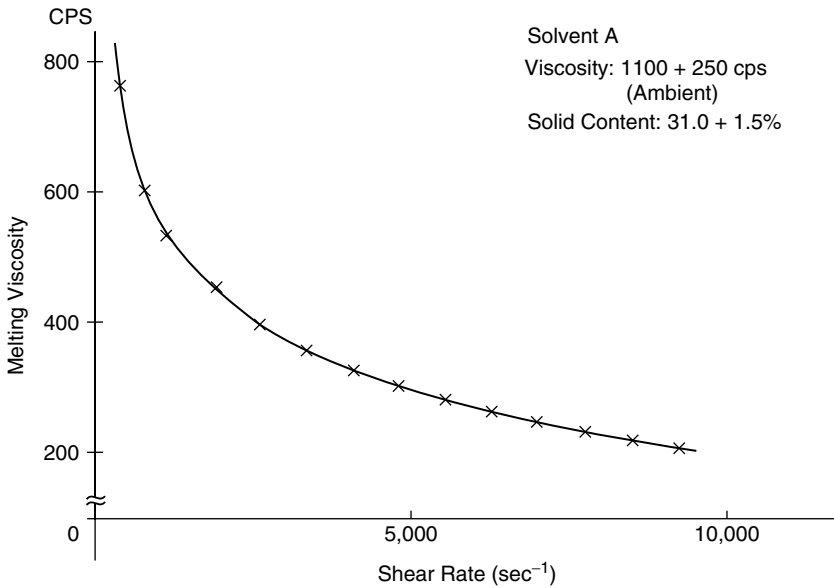

FIGURE 19.3 Rheology curve.

While a multiple-entrance design attempts to minimize the problem of flow distribution, it actually complicates it by introducing two pressure drops for every entrance installed. This can cause steps in the coating thickness and, with high viscosity fluids, parting lines, or “zippers,” in the coating.

Pumping devices built into the die can improve flow distribution on simple T-slot manifold dies; however, they have some inherent disadvantages. Because of their complex design, streamlined flow and self-purging are compromised. With gear pumps built into a die, high shear causes a breakdown of some adhesives. The real question is, Why make tooling more complicated than necessary?

19.3 Air Entrapment

Precautions to avoid air entrapment in the entire system must be considered carefully. Complicated piping runs or die manifolds will entrap air, resulting in excessive start-up times before complete purging is accomplished. It is also important to eliminate any point at which air can be induced into the system. We point out that a pan that is open to atmospheric pressure is placed just before the die manifold, such as on a gear pump die, can create air bubbles in the coating.

19.4 Lip Design

19.4.1 Lip Adjustment Design

The two methods for adjusting lip opening are flexible lip (see Figure 19.4) and sliding lip (see Figure 19.5). Both designs have proved to be effective in wipe-on coating. Flexible lip die design is based on the hinge effect (see Figure 19.4), allowing smooth, precise adjustment on relatively narrow centerlines. This single-piece concept also eliminates parting lines and flow-disrupting steps in the internal surface.

Sliding lip dies (see Figure 19.5) have the lip bolted to the die body and use push-pull adjusting bolts to adjust lip position. This system has distinct disadvantages. The clamping force must be great enough to seal between body and lip. During production, however, this force must be overcome when moving lip position, and the movement between lip and body will result in a series of unpredictable jumps. A further disadvantage is the cross-sectional size of the lip and the physical spacing of the web. The third disadvantage of the sliding lip is that lip face parallelism is distorted after adjusting.

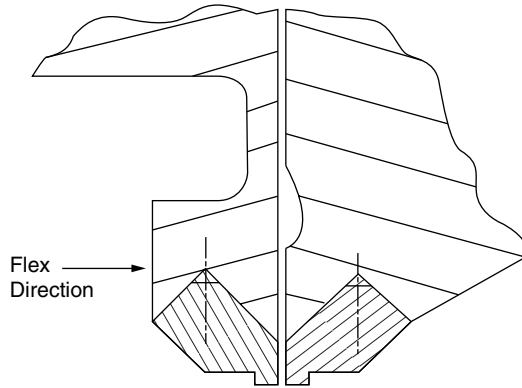

FIGURE 19.4 Flexible lip adjustment.

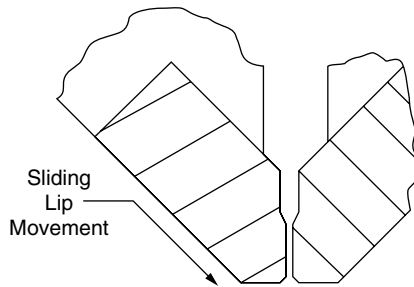



FIGURE 19.5 Sliding lip design.

19.4.2 Lip Wiping Face Design

Most low viscosity coatings will require some wiping shear to smooth the fluid onto the web. This wiping action is a balancing act of creating enough shear to force the coating to lay down without the lip face acting like a dam.

Different fluids being coated on varying substrates at different coat weights and speeds require changes in wiping face design. These designs have been a takeoff from the technology used prior to slot die coating (roll smoothing bar and knife).

In general, four basic lip styles are being used today:

High shear flat wiping lip: 

Medium shear flat wiping lip: 

Medium shear rod wiping lip: 

Sharp knife blade wiping lip: 

19.5 Die Adjustment as It Relates to Manifold Design

Precise coating weight control depends on the stability of the total system and on operator experience. Die performance will be at its best when a balance of pressure and flow is reached at the lip area. This balance is hard to define; changes in materials and rate will affect it. We can best describe this through the voice of an operator when he talks about the die being “jumpy or nervous” in one case and “lazy or unresponsive” in the other. In the case of the “jumpy” adjusting die, the pressure balance is too high; with the “lazy” one, pressure is too low. We will refer to this performance parameter as the operating window. When a die must be profiled excessively to improve end flow, the operating window will vary across the die; therefore, the die adjusting characteristics will differ (e.g., jumpy center, lazy ends). This effect is magnified in automatic control. When a die is set up at 0.010 in. opening in the center and 0.020 in. at ends to achieve balanced flow, a 3% change in opening at the ends is 0.0006 in., and in the center it is a 0.0003 in. change. As we develop more dynamic computer programs to respond faster or to predetermine a target point, uniform die response becomes very important.

19.6 Coat Weight Adjustment

Base coat weight is controlled by pump and line speed. Transverse area coat weight is a function of the lip gap adjustment. It is important to remember that the pump will always deliver a given amount of fluid to the web. When the operator adjusts the lip, material is not taken away — it is only moved from one place to another. This difference between roll or knife coating and slot die coating is often overlooked by the operator.

19.7 Adhesive Selection

Adhesives formulated for roll coating, in some cases, are not compatible with slot die heads. This is because roll coaters are high shear devices, whereas slot dies develop low shear. Any fluid that requires very high shear to create smoothing will not perform well on a low shear coating head. The shearing device or lip face can be modified to change shear level in two ways: changing the face-to-web gap (see [Figure 19.6](#)) and changing the face length ([Figure 19.7](#)). Provision should be made for ease of changing the shear level, as frequent changes of adhesive and formulation are common.

19.8 Die Steel and Piping Selection

Recent developments and reformulations of adhesives have led to highly corrosive or aggressive fluids. The die steel or plating must be carefully selected to ensure chemical compatibility, machinability, and reasonable cost. We find the majority of problems centering around highly acidic adhesives. A pH level of 4 will severely attack a chrome-plated die and render it unusable in a matter of 2 to 3 months. Several stainless steels offer reasonable prices and a highly corrosion-resistant makeup.

19.9 Proximity versus Contact Coating

Traditional die designs require being pushed into the backup roll to produce even coating distribution (contact coating). Utilizing modern manifold technology, we can reduce the roll contact pressure significantly and, therefore, reduce roll damage and lip wear. Most important, when this application technique is chosen, the flex lip concept can be used.

In any system, it is of utmost importance to have inserts that are quickly replaceable, a lip step differential that can be easily changed, and the capability to increase the shear without having the infeed lip rotate into and make contact with the web and roll ([Figure 19.8](#)).

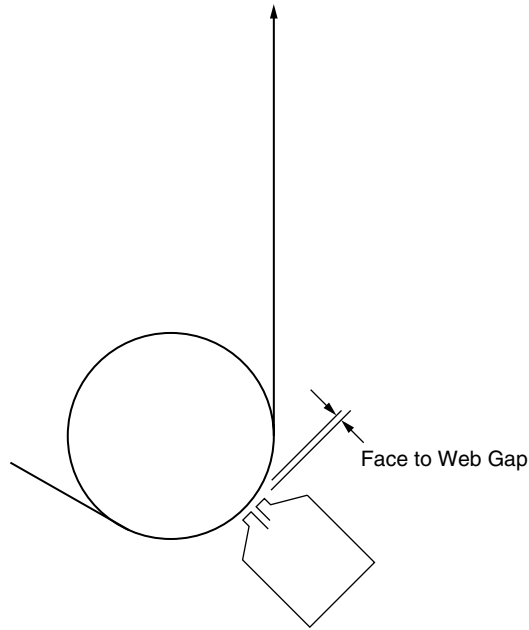

FIGURE 19.6 Changing gap between lip face and web.

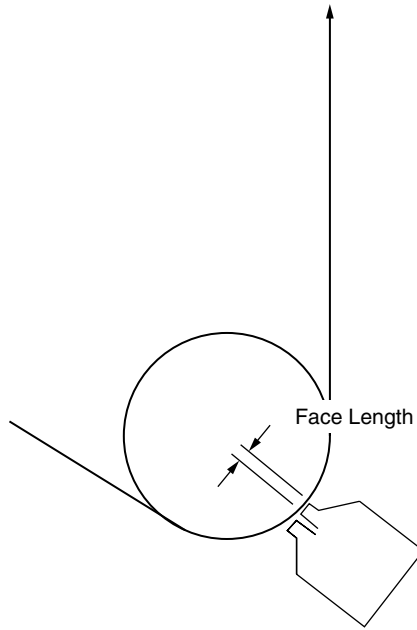

FIGURE 19.7 Changing lip face length.

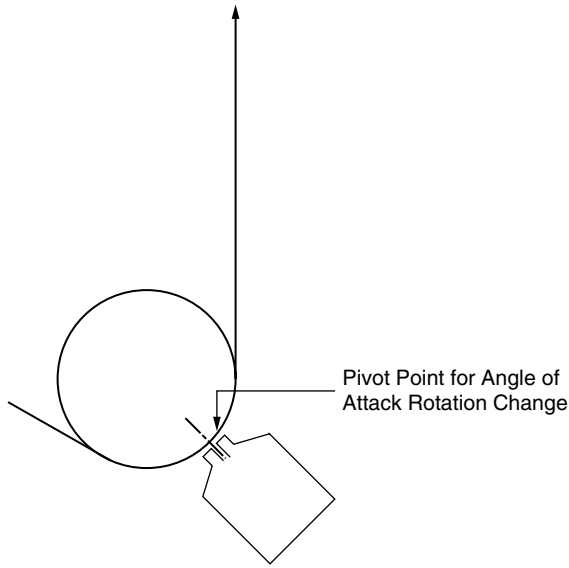

FIGURE 19.8 Proximity coating setup.

19.10 Die Positioning

19.10.1 Slot Head-to-Roll Position and Angle of Contact

Several trends are evident within the industry:

1. In the past, a 12 o'clock (Figure 19.9B) or 6 o'clock contact position was most generally used. We find a 4 o'clock or 5 o'clock contact point to be in favor in most cases today (see Figure 19.9A). This is due to improved operator accessibility and the elimination of drool after pump shutdown.

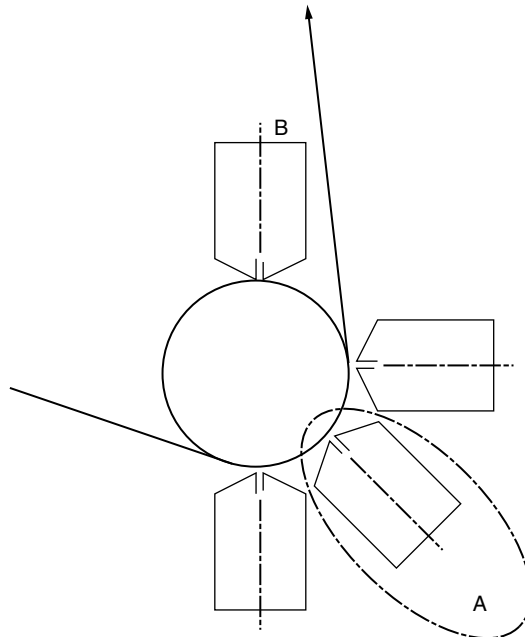

FIGURE 19.9 Die positions.

2. The angle of contact depends on lip profile, die-to-roll gap, roll hardness, roll diameter, lip step difference, lip profile, and material spreading tendency. It is impossible to predict this angle without all these factors and in-depth experience.
3. Reduced contact pressure is necessary to reduce roll and die lip damage.
4. Because roll deflection is very hard and expensive to eliminate, a die that can be deflected or bent to conform to roll variance is required if roll deflection is a problem. It is common to use a steel roll backing up the elastomer roll to lessen the deflection problem, and with heated adhesives to help cool the elastomer roll.
5. Angle of attack of the die to roll must be pivoted around the pivot point indicated in [Figure 19.8](#) for the best and most reproducible coating surface.

19.10.2 Lip Profiling

Lip shape and the relative position of the lead and trailing wipers to each other are of utmost importance in today's coating technology.

In some cases, using today's high technology coatings, a uniform and proper level of wiping action is required to produce satisfactory coating. As a result of the shear thinning characteristics in today's more difficult adhesives, proper profiling and angle to attack will produce a smooth and even coating. Any variance in lip profile will create differential wiping, causing an uneven appearance. Because, with modern coating heads, uniform distribution is not a function of the lip face, we can confine the lip face to a single function — namely, creating a proper environment at lay-down.

No hard data are available on lip face design as the interrelation between roll diameter, roll hardness, line speed, substrate, lip design, and adhesive viscosity characteristics come into play. There seem to be two technical camps. One group adheres to the flat, fixed wiping lip, with a differential step between the infeed lip and the wiping, or outfeed, lip. The other group tends to favor a rotating or fixed rod in the wiping area. This rod style design is as old as die coating, and several patents have been issued.

19.10.3 Die Support Design and Operation

The interrelationship of die and mounting require that the two units act as one, both being equally important. Absolutely necessary to the successful operation of a slot coating head are the items in the series of design specifications indicated in [Figure 19.10](#) and explained in Section 19.9.4.

Application and utilization of existing equipment designs will determine the best die-to-roll position. Operator convenience and the ability to view the point of laydown are very important. It is our opinion that mounting position A in [Figure 19.9](#) is the most advantageous, and position B is the least.

The support bed must be completely rigid and vibration-free. Any sag or bow in the die will create problems in the die-to-roll alignment. For this reason, we do not recommend that the die be supported from its ends. On heated dies, the designer must also allow for thermal growth while maintaining die straightness.

19.10.4 Support and Adjustment System Design Specifications

Item 1 in Figure 19.10: The die should be supported on precision-ground pads, with die straightness (contouring) adjustments for roll warp correction. On heated dies, insulation should be provided between die frame, and allowance made for die growth.

Item 2 in Figure 19.10: A heavy-duty rectangular tubing cross frame should be used for maintaining straightness during operation and adjustment.

Item 3 in Figure 19.10: An "X" in/out adjustment utilizing machine tool slideways, with fast air actuation and hydraulic soft stop cushions is used. A micro stop correction adjustment with dial indicator or LVDT should be provided for each end.

Item 4 in Figure 19.10: This "Y" adjustment is provided for roll axis position alignment.

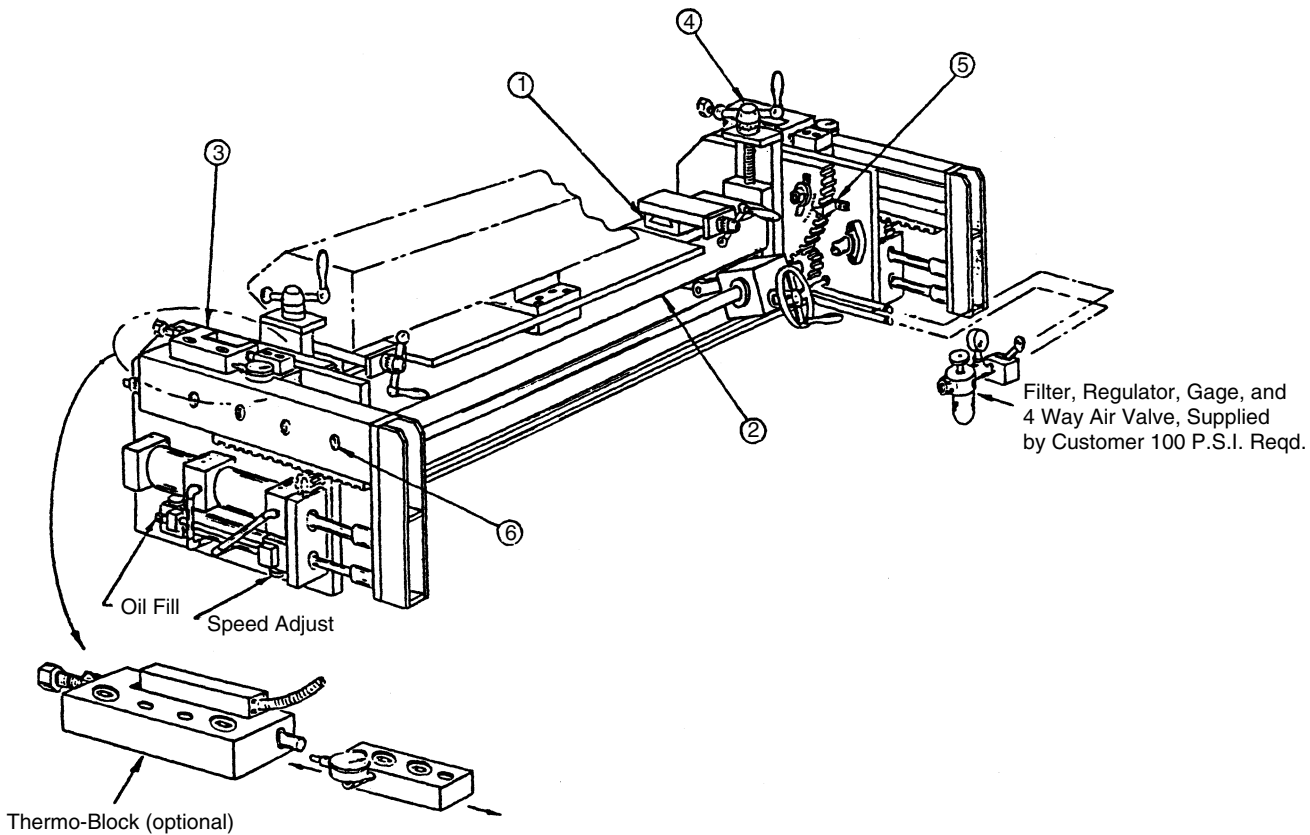

FIGURE 19.10 Coating die support; for explanation of numbered items, see Section 19.9.4.

Item 5 in [Figure 19.10](#): This is an angle of attack positioning adjusted through a rack-and-pinion gear arrangement, with indicator markings in degrees. Note that the angle of attack movement is centered at the die lip (coating contact) point.

19.10.5 Die-to-Roll Positioning

Flexibility and repeatability are primary requirements. Difficult adhesives, speeds, and substrates will require different setup positions, and the ability to vary the die-to-web position easily with exact repeatability is of prime importance. The support frame must allow in/out movement and angle of attack adjustment (see [Figure 19.10](#)).

In/out adjustment will have two functions: (a) fast movement with 5 to 8 in. (130 to 200 mm) of travel, allowing lip cleaning; and (b) micro in/out to fine-tune roll-to-lot gap distance. This adjustment should allow differential end-to-end gapping.

The in/out adjustment must be on a straight line, always moving directly at the roll centerline. (Pivot-style mountings are not recommended.)

19.10.6 Angle of Attack Position Adjustment

To create different shear levels for proper film forming at varying speeds, the angle of attack must be adjustable. This movement should be accurate and smooth, and movement should cover about $\pm 5^\circ$.

It is important that when one positioning point is adjusted, the other roll-to-die relationships remain unaltered. Angle of attack adjustment must pivot about the point indicated in [Figure 19.8](#).

19.10.7 Lip Opening Setup

Depending on materials and laydown, a 0.008 to 0.012 in. even lip opening gap ([Figure 19.11](#)) should be set before start-up and adjusted for proper flow and laydown after start-up.

The lip opening setting adjusts coat weight thickness, not die-to-roll gap. Roll coaters will have difficulty with this, as they have traditionally used roll-to-roll gap as the coat weight adjustment.

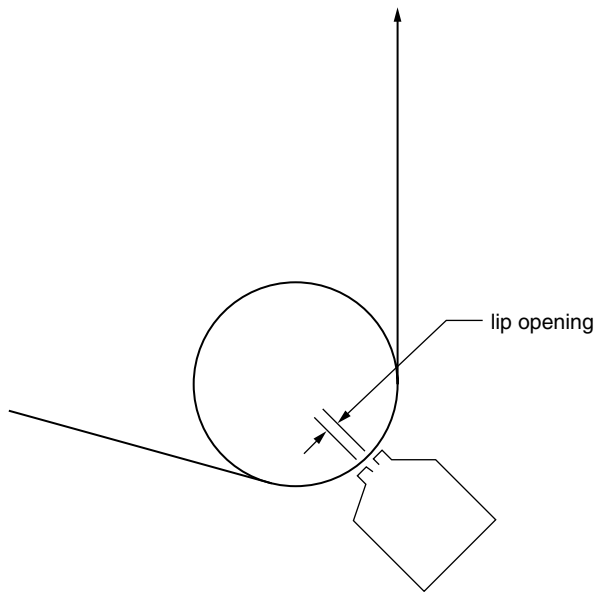

FIGURE 19.11 Lip opening setup.

19.10.8 Die-to-Roll Gap Setup

The distance from die to roll or substrate is, in general, determined by web thickness and the viscosity of the fluid to be applied. The more clearance that can be maintained, the less damage there may be due to positioning or start-up mistakes.

We suggest, as a rule of thumb, that a clearance equal to the substrate thickness be set between substrate and infeed lip face. This distance may be less for materials of very low viscosity or for hard to smooth materials. Make sure the gap is from web to lip face, as shown earlier (Figure 19.6), not from roll to lip face.

19.11 Backup Roll Design

Processors and equipment manufacturers alike would like to utilize steel backup rolls to improve runout (T.I.R.) and to mitigate heat transfer problems. In some cases on lab or narrow production systems, steel rolls have been successful. In most cases, however, steel rolls are not as forgiving as an elastomer roll and therefore have not yet been accepted for production. We expect this to change as the technology matures.

Elastomer rolls have improved over the past several years to allow the precise roll-to-lip conformation absolutely required for proximity coating. When specifying an elastomer roll, the following items must be carefully considered:

- Runout tolerance
- Release characteristics
- Heat transfer
- Hardness
- Hardness uniformity
- Roll deformation (bow)
- Resistance to attack by the coating or cleaning agent

We see the use of rolls covered with urethane or Viton being most evident with diameters of around 300 mm and hardness of up to 90 durometer, Shore A. Runout tolerances of 0.0005 in. and better are being achieved.

The elastomer roll will be deformed by a given width web, and rolls must be provided to match web width changes. Spare rolls are also necessary, as damage often occurs.

19.12 Automatic Control

19.12.1 Die Control

All commercially acceptable automatic die adjustment systems available today use flexible lip and heated bolt arrangements (see Figure 19.12). Minor disagreements exist on details, but total overall performance does not seem to be greatly affected. The greatest confusion surrounds the effect of pure mechanical response time and how it relates to process analysis and its relation to response. All systems to date simply read the variation from target and make a corrective response. Polymer lot-to-lot differences, temperature changes, in-plant drafts, and many other factors that affect gauge have made it impossible to anticipate flow changes. Anticipation-based programs can be used in product changes, however, if known effects will happen over a relatively fixed period or on start-up.

During a production run, if a variance is seen, make sure that it is not a short-term effect, gone in the time it would take to make a change. We also may want to determine the variance trend. Only after careful analysis of the problem can we make a die adjustment. The time from discovery until an adjustment takes effect varies from line to line, however start-up to $\pm 5\%$ control, assuming the total system has reached some stability, will be 10 to 20 min, and $\pm 3\%$ control in 15 to 30 min.

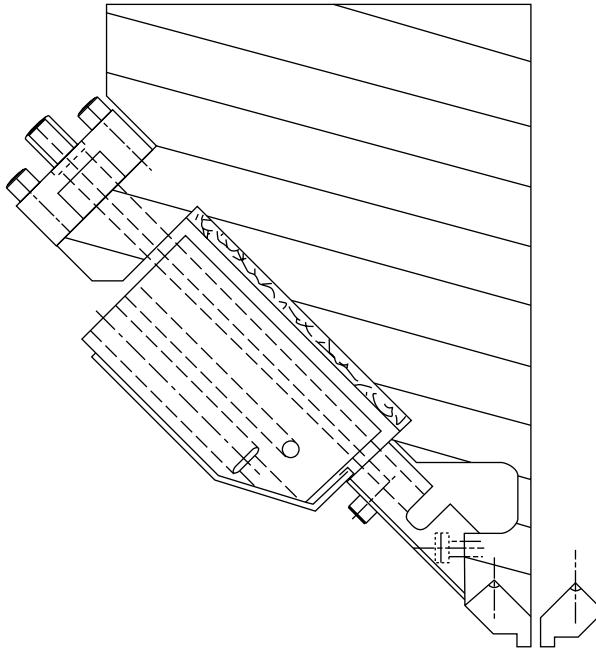

FIGURE 19.12 Automatic transverse coat weight control.

Total and substrate weight separation, the first steps in the process control cycle, are achieved by a layout similar to that shown in Figure 19.13. Existing technology is available and has been proved in production for nearly a decade.

The Autoflex die features thermal expansion and contraction of the lip adjusting bolts to make finer adjustments in lip opening than are possible with strictly mechanical means.

Each lip adjusting bolt is fitted with a block containing a heater and air cooling path. Approximate gauge uniformity is established in the conventional manner before the Autoflex system is engaged.

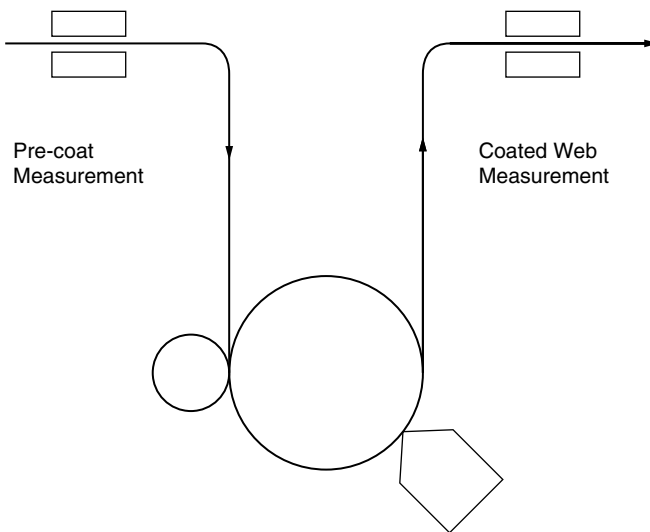

FIGURE 19.13 Schematic drawing of total and substrate weight separation in production control cycle.

Thickness variations are converted to lip opening correction by increasing or decreasing power to the individual lip bolt control blocks to trim variations to a minimum.

The key to the transverse thickness control is a microprocessor-based controller that is tied into the conventional computer control system.

On ambient operation dies, care must be taken to isolate the heat from the Autoflex bolts from the die body.

19.12.2 Die-to-Roll Position Adjustment System

The ability to repeat the original roll-to-die setup position is critical during start-ups and normal web splice coating interruption.

During operation, minor changes in die position may have to be made to accommodate roll expansion, changes in adhesive viscosity and smoothability, and substrate thickness variance. An automatic positioning device is available that will allow continuous adjustment, if necessary, of the web to the lip face. This is accomplished through a device similar to the Autoflex die bolt adjustment system. A heating and cooling device is installed in the manual adjustment system (U.S. Patent 3,940,221) for die-to-roll gap setup. Heating or cooling of this device will expand or contract the steel block and increase or decrease the die-to-roll gap. A usable method for monitoring smoothing must be employed and interfaced with the Autoflex computer.

19.13 Deckling

Deckling may be necessary to reduce die width or to make stripe coatings. Be careful when attempting this, to make sure that shim materials are soft. We recommend Teflon/filled, Teflon/aluminum, foil/aluminum shim stock, or soft brass. For room-temperature applications, an adhesive/foam/adhesive mounting tape works very well.

In many applications, a rake-type device may be used for stripe coating (Figure 19.14A). This device does not clamp into the lip and can be changed very quickly.

If excessive force is applied when the deckle is clamped into the lip, the lip will distort, causing lip wear or uneven coating at this point (Figure 19.14B).

Deckling or stripe coating cannot be used in a system featuring the rotating rod lip design.

19.13.1 Air Entrapment behind Deckling

When the die ends are deckled in, it is common for air to become trapped in this area. This air is slowly released, causing voids in the coating at the edges. A purge port with shutoff valve should be installed at the die ends to eliminate this problem.

19.14 Die Cleanup

In most cases, it is important to change coatings or coating formulation frequently. Therefore, it is necessary to be able either to purge out the system or to clean the die completely. This holds true for the complete system, including pump filters and piping.

Purging is the easiest and most common method; but extreme care is necessary to streamline all flow areas to eliminate dead areas.

The opening and cleaning of a die can be an easy 30 min experience or a 3 to 4 day nightmare. Slot die designs differ greatly; some are simple two-piece designs, while others have complex assemblies.

It is common to have a dual pumping and piping system, allowing quick changeover from one coating to the next, cleanup then taking place after the line is up and running.

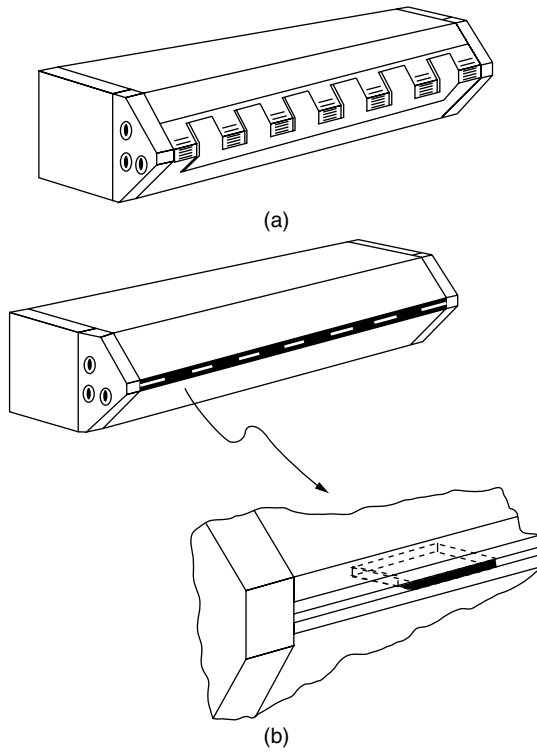

FIGURE 19.14 Deckling: (A) rake style and (B) shim style.

20

Extrusion Coating with Acid Copolymers and Ionomers

Donald L. Brebner

E. I. du Pont de Nemours & Company

20.1	Product Considerations	20-1
20.2	End-Use Considerations	20-3
	Foil Adhesion • Heat Seal Characteristics	
20.3	Processing Conditions.....	20-5
	Melt Temperatures • Other Considerations	

20.1 Product Considerations

Acid copolymers and ionomers are high-performance resins that offer adhesion, heat seal, and barrier properties markedly superior to those of conventional polyethylenes. Figure 20.1 shows the structure of acrylic and methacrylic acid copolymers, the two types of acid copolymer commercially available in the United States at this time. The presence of the methyl side group in the methacrylic acid copolymers results in some subtle differences between the two resin types, but they can be regarded as equivalent after allowing for the difference in molecular weight of the comonomers. For example, a 10 wt% acrylic acid copolymer is equivalent to a 12 wt% methacrylic acid copolymer in carboxyl group content.

Ionomers (Figure 20.2) are derived from acid copolymers by partial neutralization of the carboxyl group with either sodium or zinc ions. Because the neutralization reaction results in a substantial increase in melt viscosity, it is commonly referred to as ionic cross-linking.

In both acid copolymers and ionomers, the melt and solid state properties are strongly influenced by intramolecular hydrogen bonding, as illustrated in Figure 20.3. The forces involved in hydrogen bonding are almost 10 times stronger than the intramolecular forces in the nonpolar polyethylenes.

The ionomers are distinguished by the combination of hydrogen bonding and interchain ionic forces perhaps an order of magnitude stronger than the hydrogen bonds. As a consequence, the ionomers have a wide spectrum of melt and solid state properties, including better hot tack and grease resistance than acid copolymers of equivalent acid content.

With the acid copolymers, melt index and acid content are the major variables available to the resin producer. Because melt index is a measure of melt viscosity, it is related primarily to the processing characteristics of the resin. The resins now used for extrusion coating applications fall in the 5 to 15 melt index range to accommodate a broad field of processing needs.

Resins with acid contents of 3 to 15% are currently available on the market. The effects of increasing acid content are as follows:

- Better foil adhesion
- Better hot tack

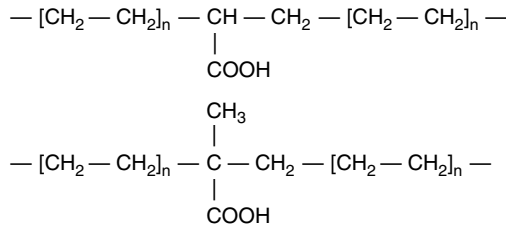

FIGURE 20.1 Structure of ethylene acrylic (top) and methacrylic acid (bottom) copolymers.

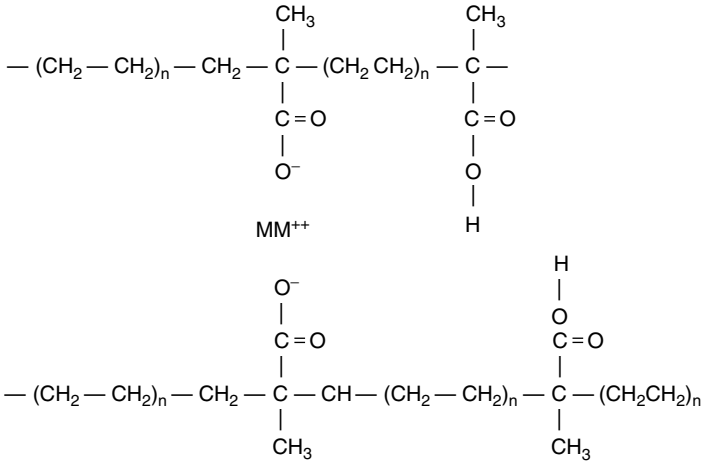

FIGURE 20.2 Ionomer structure.

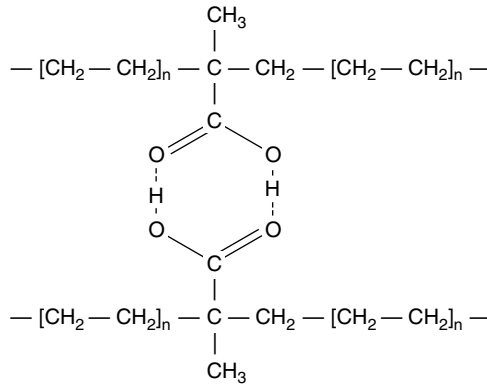

FIGURE 20.3 Intramolecular hydrogen bonding.

- Lower seal initiation temperature
- Better oil and grease resistance
- Better abrasion resistance
- Higher gas and moisture permeability

The most important effect is the improved adhesion to unprimed aluminum foil, as most commercial applications of acid copolymers involved foil adhesion.

The ionomers are characterized by additional variables that can be manipulated to obtain a broader spectrum of properties in the final product. These variables include the following:

- Melt index (molecular weight) of base resin
- Percentage of acid in base resin
- Degree of ionic cross-linking (percent acid neutralized)
- Type of ion used for neutralization (Na or Zn)

In particular, the use of the sodium and zinc ions produces families of resins with distinctly different properties. The zinc ionomers are used for the majority of extrusion coating applications because of their excellent adhesion to unprimed foil.

The effects of composition on ionomer properties are shown in Table 20.1. In general, the ionomers based on high acid copolymers and with a high degree of neutralization have the best heat seal and product resistance characteristics. However, these advantages are balanced by a need for relatively high free carboxyl content for optimum foil adhesion.

In practice, most extrusion coating resins used for coextrusion with nylon have a relatively high degree of neutralization. There are limited uses of sodium ionomers in extrusion coating applications that call for maximum grease resistance, but these applications are on either paper or primed foil.

20.2 End-Use Considerations

20.2.1 Foil Adhesion

One of the primary reasons for the selection of an acid copolymer or ionomer for use in extrusion coating is adhesion to unprimed aluminum foil. Extensive studies in Du Pont laboratories have found that acrylic and methacrylic acid copolymers of equivalent acid content have equal adhesion to foil. At a particular acid content, a zinc ionomer will have 15 to 20% lower foil adhesion. Resins with high acid content (10 to 13%) have 20 to 25% better adhesion than resins with low acid content (3 to 5%).

The acid copolymers and ionomers have additional utility because of the enduring nature of their adhesion to foil. High levels of adhesion of polyethylene to foil can be achieved with primers or high melt temperatures in extrusion, but the bonding is often deteriorated by extended exposure to aggressive environments. With acid copolymers and ionomers, most hard-to-hold products can be packaged without sacrificing long-term durability of the coating adhesion. Acid copolymers and ionomers of equal acid content are essentially equivalent in product resistance.

20.2.2 Heat Seal Characteristics

The heat seal properties of acid copolymers and ionomers constitute the second major area of superiority over low-density polyethylene (LDPE). Seal initiation temperatures are lower and strengths higher than LDPE. Figure 20.4 is a generalized plot of seal strength versus interface temperature for acid copolymers, ionomers, and LDPE. The acid copolymers and ionomers have similar seal initiation characteristics, but the acid copolymers have a higher ultimate seal strength. Both have much higher seal strengths than LDPE.

TABLE 20.1 Ionomer Properties versus Composition

Higher Percentage of Acid	Higher Ion Linking	Higher Free Carboxyl: Greater Adhesion to Polar Substrates (Foil, Nylon)	
		Na	Zn
Greater stiffness	Greater stiffness	Better oil resistance	Less water sensitive
Better oil resistance	Better oil resistance	Higher gloss	Better adhesion (foil, nylon)
Higher gloss	Higher gloss	Lower haze	Less "neck-in"
Higher tensile and impact strength	Higher tensile and impact strength	Higher draw	
Lower haze	Higher toughness	Higher toughness	
Lower melt and softening points	Higher hot tack		

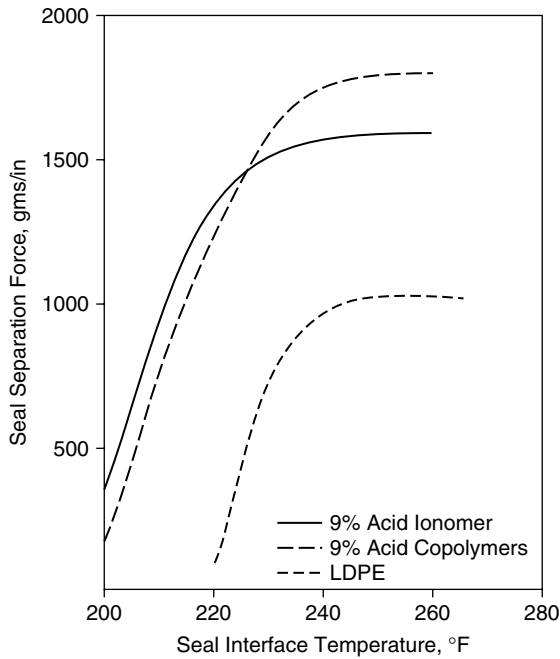

FIGURE 20.4 Heat seal strength versus bar temperature (1 mil coatings on 30 lb kraft paper).

Hot tack strength is the ability of a heat seal to remain together when a force is applied while it is still in the molten state. This is a critical property in vertical form-fill-seal applications, in which the product is loaded immediately after the seal is made. It is also critical in any high speed packaging operation in which the package is exposed to some form of abuse before the seal has cooled.

One method of measuring hot tack strength is the Du Pont spring test. A series of springs of different thicknesses and widths at the narrowest point provides varying levels of spring tension (Figure 20.5). Figure 20.6 shows how the spring is located inside the sample. The sample is heat sealed for 3 sec at a pressure of 40 psi. The 3 sec dwell time allows an accurate measurement of the interfacial seal temperature by using a very fine thermocouple hooked up to a rapid response recorder.

When the heat seal bars are released, the springs apply an instantaneous force to the seal. The separation of the 1 in. wide seal is measured to the nearest tenth of an inch. The results are plotted as the force required to obtain 20% seal separation as a function of temperature.

Figure 20.7 shows the hot tack characteristics of an ionomer and acid copolymers of equivalent acid content in comparison with LDPE. LDPE, a completely nonpolar material, has very low hot tack strength.

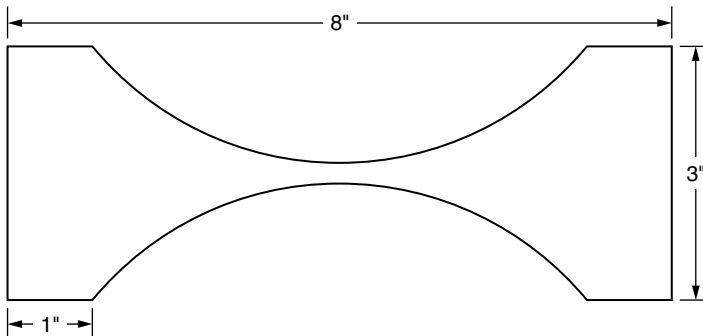

FIGURE 20.5 Spring for Du Pont hot tack tester.

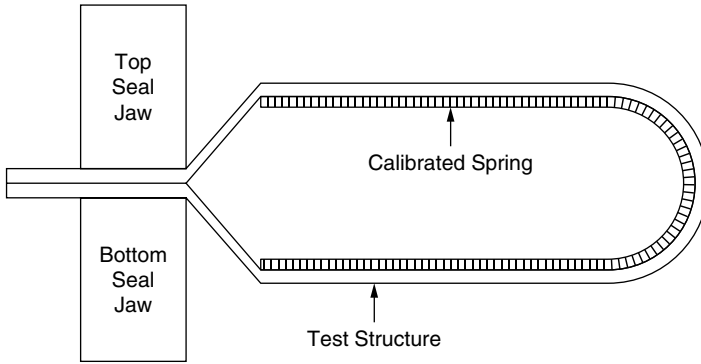

FIGURE 20.6 Hot tack spring test.

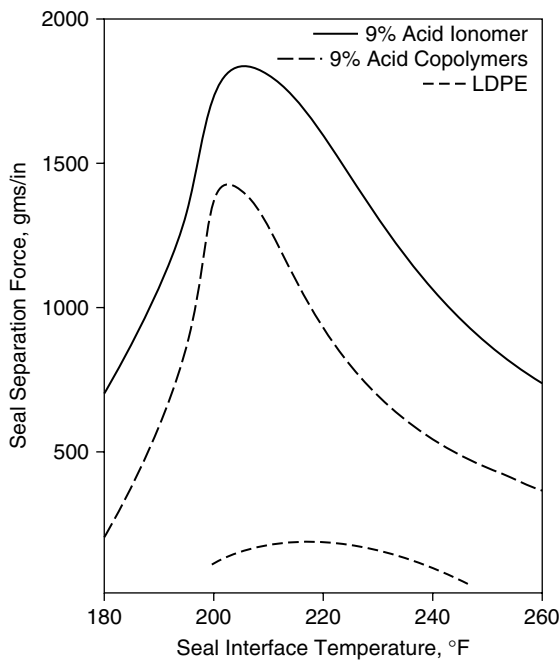

FIGURE 20.7 Hot strength versus interface temperature (1 mil coatings on 30 lb kraft paper).

The acid functionality of the copolymers results in much higher hot tack strength because of interchain hydrogen bonding. The combination of hydrogen bonding and ionic bonding in the ionomers produces an even greater maximum hot tack strength and a broader hot tack range. In practice, this means that the ionomers will tolerate the broadest range of sealing conditions and offer the highest speeds on packaging lines.

20.3 Processing Conditions

20.3.1 Melt Temperatures

LDPE is typically processed at melt temperatures in the range of 600 to 630°F. These high temperatures are necessary to promote surface oxidation of the resin and to ensure adequate adhesion to the substrate. However, it is not necessary to oxidize the acid copolymers or ionomers because the acid functionality is responsible for adhesion to either foil or paper. These resins should be processed at the lowest melt

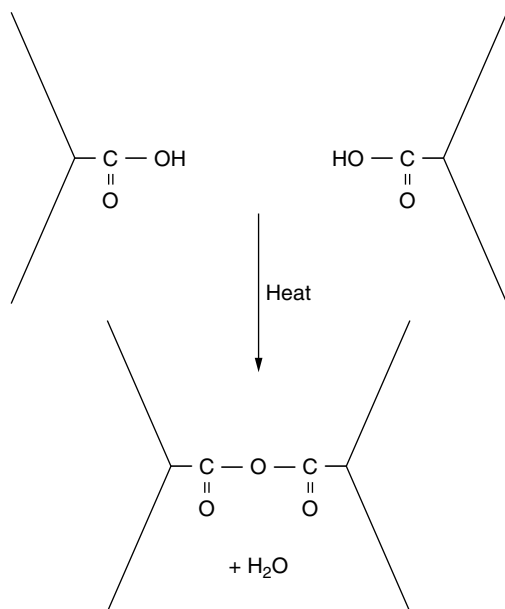

FIGURE 20.8 Anhydride cross-linking.

TABLE 20.2 Melt Temperatures

Product	Melt Temperature (°F)
High acid, high melt index	450–500
Intermediate acid and melt index	500–550
Low acid and melt index	550–590

temperature consistent with adequate product performance. One obvious reason to prefer a lower melt temperature is to reduce the chance of odor or taste problems in packaging sensitive products. Another reason is shown in Figure 20.8. Both the acid copolymers and ionomers can undergo a process called anhydride cross-linking in which carboxyl groups in adjoining molecules react to form an anhydride cross-link and produce water as by-product. This reaction occurs at a significant rate in the temperature range at which the copolymers and ionomers are normally processed. The cross-linking reaction causes gel formation, while the water causes die buildup problems. As approximate guidelines, the melt temperatures shown in Table 20.2 are recommended for acid copolymers and ionomers, assuming that desired product properties can be achieved under these conditions.

20.3.2 Other Considerations

Both the acid copolymers and ionomers are slightly corrosive, so that metal parts exposed to these products at high temperatures should be plated with nickel or chrome. Another factor to be considered is the moisture sensitivity of the ionomers. The ionomers are hygroscopic and, as a consequence, are packaged in foil-lined bags and boxes. When a box is opened, only a corner of the liner should be cut off to permit insertion of the transfer pipe. If this is done properly, it is easy to reseal the liner of a partially used box by folding it over and taping it securely. With normal precautions, the moisture sensitivity of ionomers does not present an operational problem.

21

Porous Roll Coater

Frederic S. McIntyre
Acumeter Laboratories, Inc.

21.1 Introduction	21-1
21.2 Extrusion Porous Roll System	21-1
Development • Details and Disadvantages	

21.1 Introduction

Recent progress had been made in silicone-coated products that are curable by electron beam (EB) and ultraviolet (UV). Advantages of UV and EB converting processes are shown in [Table 21.1](#). Of these new products, in which the release levels range between 25 and 50 g per 25 mm wide strip, typical viscosities of the materials tested are in the range of 500 to 1000 cp at room temperature. These silicone products are manufactured by Th. Goldschmidt, in West Germany, and Lord Corporation, in Pennsylvania, and other companies. The UV products are either one-part premixed/ready-to-use materials, or two-component products that require nitrogen inerting to overcome surface smear and to achieve a complete cure at web speeds up to 30 m/min per each UV lamp. A schematic diagram of the nitrogen inerting process is shown in [Figure 21.1](#). The UV lamps used for curing are rated at 300 W/in. (120 W/cm per lamp). The EB products are also premixed/ready-to-use, and as with the UV chemistries, they also require nitrogen inerting to obtain a full cure at typical web speeds of 200 m/min. The energy dosage is approximately 2 megarads (Mrad). A schematic diagram of an EB processor is shown in [Figure 21.2](#).

21.2 Extrusion Porous Roll System

21.2.1 Development

One recently developed extrusion roll coating system incorporates a slot nozzle coating head, located adjacent to a slow speed “nozzle roll” (see [Figure 21.3](#)). The fluid is coated onto the “nozzle roll” and transferred to an adjacent “applying roll,” which in turn, contacts the coating web for fluid transfer. The relative speed ratio between the “nozzle roll” and the “applying roll” is approximately 1:30.

Reports on trials have noted that the curable coatings possess poor shear properties and that the speed ratio between the rolls is somewhat dependent on this limitation. The shear properties can be improved by heating the rolls, but this method is not always productive, with the result that the coated web has the appearance of small blotches, 1 to 2 mm or larger, or lateral bands (chatter) of coating, rather than a smooth, uniform coating. Likewise, conventional roll coaters that contain multiple rolls experience a similar effect (see [Figure 21.4](#)). This phenomenon is associated with fluids that have poor flow properties and dilatant characteristics. Viscosity of dilatant fluids increases with increasing shear rate, as shown in [Figure 21.5](#). The actual coat weight applied in either case is influenced by the web substrate material, surface conditions, silicone product properties, and the method of applications.

Most coating processes are able to apply these coatings between 1.3 to 1.6 g/m² within industry standards; however, the type of web material greatly influences the final coating weight. Our research to reexamine the current methods for applying curable silicones enabled us to develop an alternative method

TABLE 21.1 Advantages of Radiation Curing

-
- Nonpolluting
 - More efficient (less energy required)
 - Can be used on both films and papers
 - Nonthermal cure allows machine stop and start with minimal product loss
 - Multiple process permits silicone in-line with hot melt products
 - Low heat energy allows coating of thermal-sensitive web materials
-

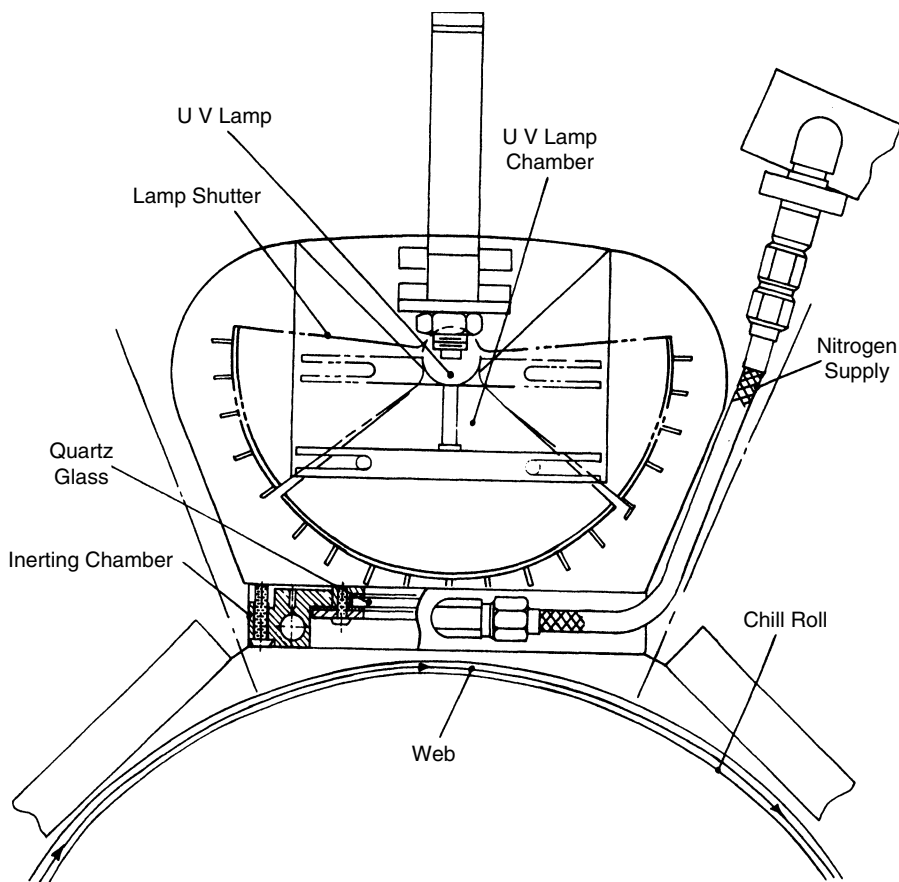
**FIGURE 21.1** UV irradiation with nitrogen inverting.

for overcoming the shear problem. This design became Acumeter's Extrusion Porous Roll Applying System. The system consists of a porous, stainless steel metal roll, an adjacent applying rubber-coated roll, and a laminating roll. A schematic diagram of such a coater is shown in [Figure 21.6](#). The porous roll receives a fluid supply from a positive displacement metering system, which is synchronous yet proportional to machine speed. A detailed diagram of a porous roll is shown in [Figure 21.7](#).

21.2.2 Details and Disadvantages

The relative differential of the porous roll to the applying roll can be either equal or slightly different. The applying roll can operate at the same surface speed as the web, or slightly less, to create an additional smear of the coating on the web. The unique feature of the porous roll system is that shear is eliminated throughout the fluid transfer process. This means that the fluid material can be reasonably shear sensitive and dilatant. The porous roll coating system simulates a printing process, similar to rotary screen ink

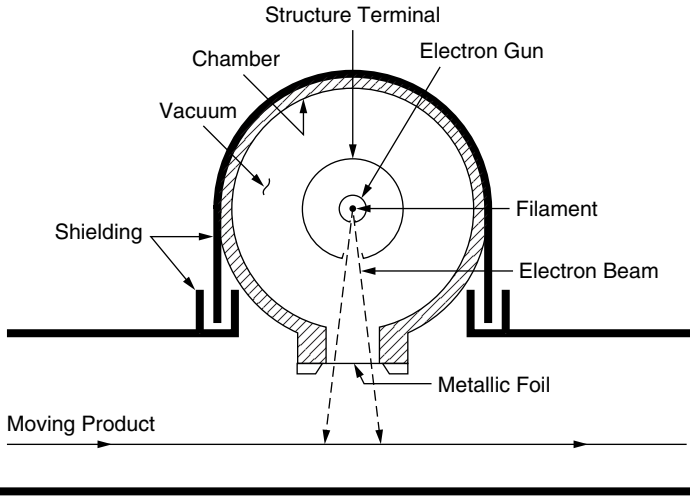

FIGURE 21.2 EB process.

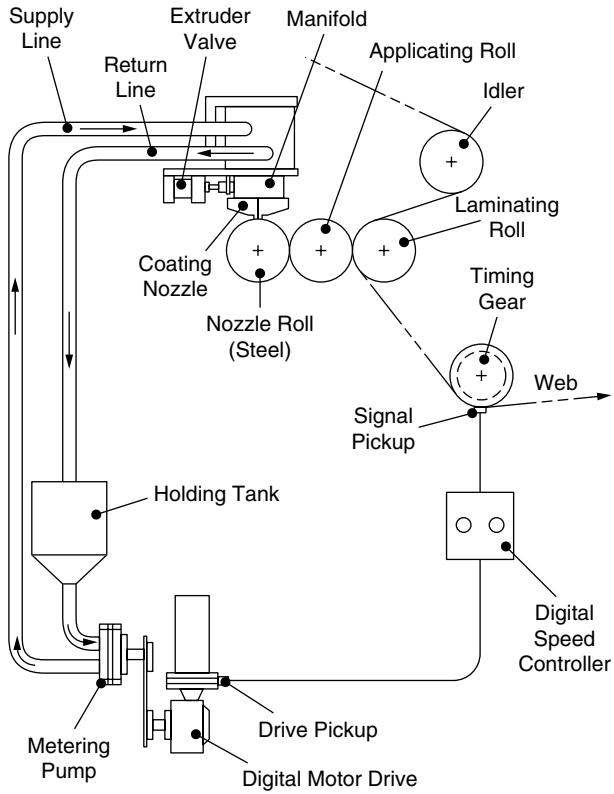

FIGURE 21.3 Roll coater with extrusion feed.

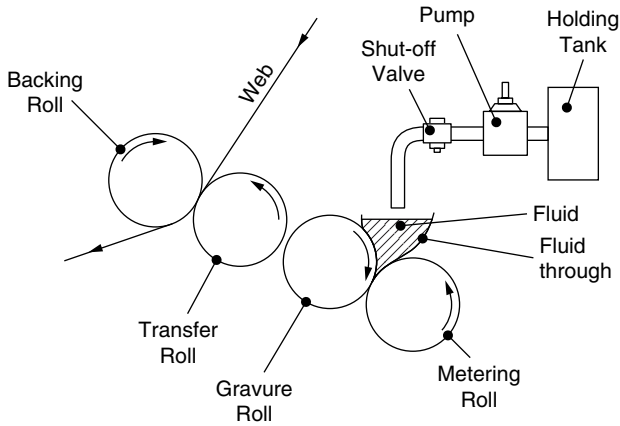

FIGURE 21.4 Transfer roll coater.

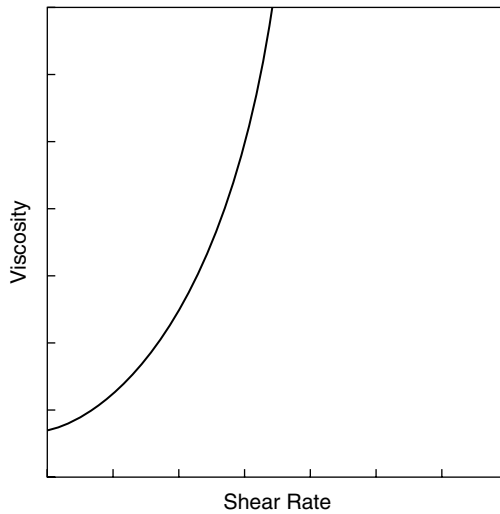

FIGURE 21.5 Viscosity dependence on shear rate of a dilatant fluid.

printing (see Figure 21.8). The major difference is that the porous roll system receives a fluid supply synchronous to machine speed, whereas the rotary screen printing process utilizes a doctor blade mechanism, located on the inside of the screen cylinder. The rotary screen printing process speed is influenced by the viscosity of the ink. This means that inks of high viscosity will limit machine speed.

In contrast, the porous roll system with synchronous positive displacement fluid supply is insensitive to viscosity change. The important element is synchronous fluid metering to obtain consistent and controlled coating weights applied at wide ranges of machine speeds.

Manufacturers of curable silicones have indicated that higher viscosity materials are desirable for obtaining special release levels. As mentioned earlier, conventional multiple-roll coating systems perform best when handling fluids less than 1000 cp. The porous roll system has been tested with coatings having viscosities to 10,000 cp.

Changing the micrometer openings in the porous roll applicator will permit handling of higher viscosity materials (see Figure 21.9). For example, coatings of polyvinyl resin emulsion adhesives, having a viscosity of 5000 cp at a coating thickness of approximately 30 μm have been successfully applied without difficulty. Silicone products or other coating materials that have higher viscosities such as 10,000 cp may require a

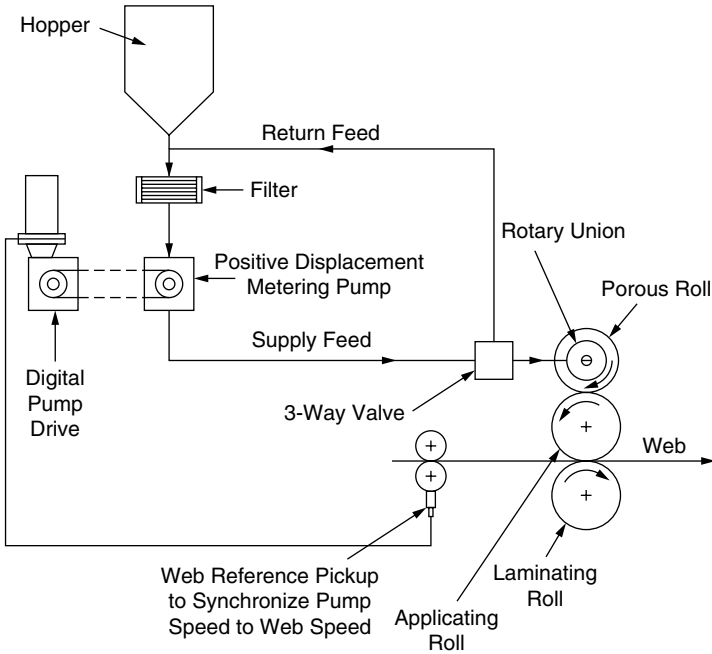

FIGURE 21.6 Porous roll coater.

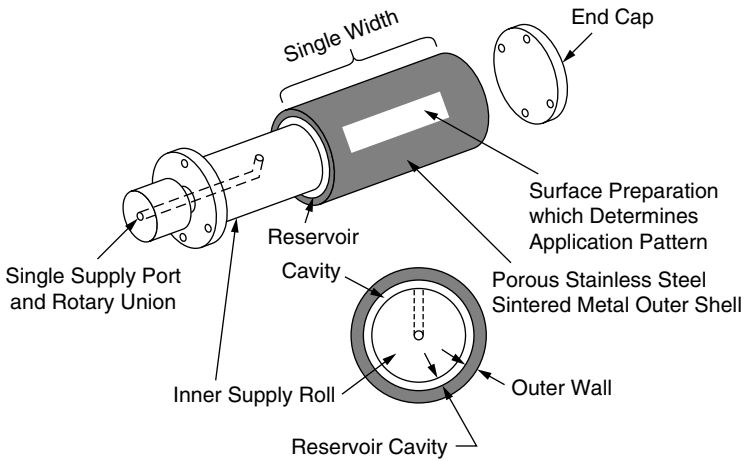

FIGURE 21.7 Diagram of a porous roll.

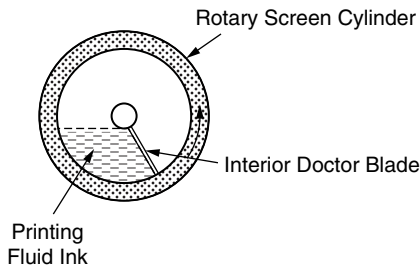

FIGURE 21.8 Rotary screen printer.



FIGURE 21.9 Porous roll applicator porosity.

porous roll having larger openings, depending on flow properties. The larger porous openings will minimize the fluid backpressure and allow for consistent coat weights at various machine speeds.

The porous roll surface can be sealed for printing of fluids in patterns, as shown in Figure 21.10. This means that special coating patterns required in flexible packaging products, business forms, envelopes, tapes, and labels can utilize curable silicone coatings in the final converting process, rather than having pre-silicone-printed web materials.

The porous roll system can also be configured to handle multiple coating materials within the same applicator. A cross section of the applicator is illustrated (Figure 21.11) to show the different chambers within which the multiple fluids are supplied. This feature permits the converter to coat different materials simultaneously, yet from the same applicator. Special tape products that require different release levels on the same web material can utilize this concept. For example, a pattern of 25 g/25 mm release can be applied on the left-hand side of the sheet, whereas a 100 g release coating can be applied in the center or adjacent location on the same sheet. Products such as double-sided, release-coated webs used in transfer tapes can be coated easily by utilizing two separate porous roll coating systems, located on either

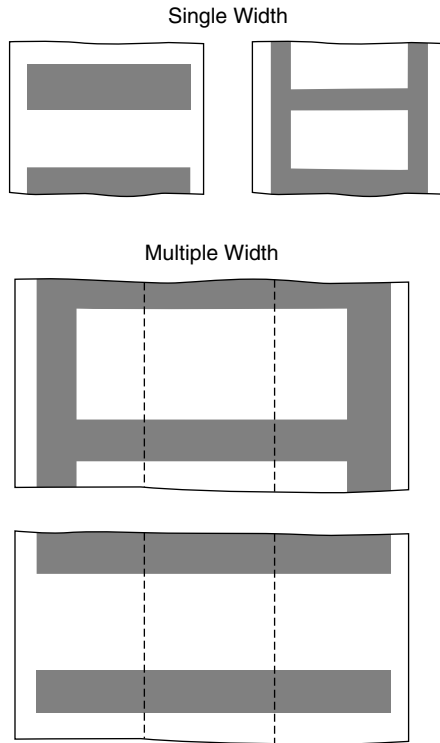

FIGURE 21.10 Pattern printing with porous roll.

side of the web, as shown in Figure 21.12. UV or EB curing equipment is incorporated for cross-linking the coatings as dictated for completing the final products.

The porous roll system also allows for obtaining high release levels, such as 100, 200, and 400 g/25 mm, by using a two-component silicone system. This concept utilizes two porous rolls that are in direct contact with a single rubber coated applying roll (Figure 21.13). Component A is supplied through porous roll B. Component A represents the base silicone coating material, whereas component B is the diluent. The objective is to intermix the diluent into the base silicone. The proportional ratio of A to B determines the fluid release level. This concept is experimental at this stage, but tests have indicated that the two-component system is an alternative process for obtaining future “dial-in” release levels. A schematic diagram of a laboratory coater is shown in Figure 21.14, and diagrams of production-size units are shown in Figure 21.15 and Figure 21.16.

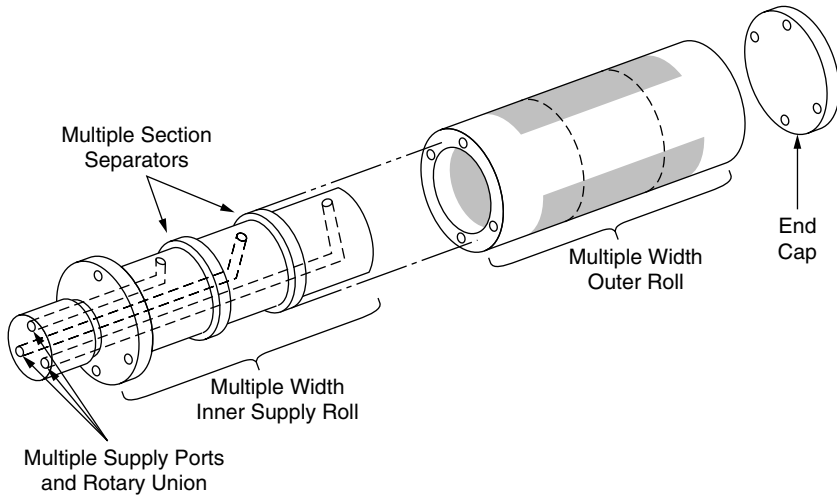

FIGURE 21.11 Cross section of a porous roll applicator.

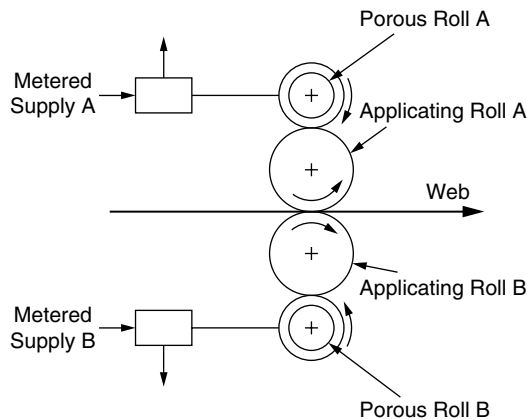

FIGURE 21.12 Two-side coating with porous rolls.

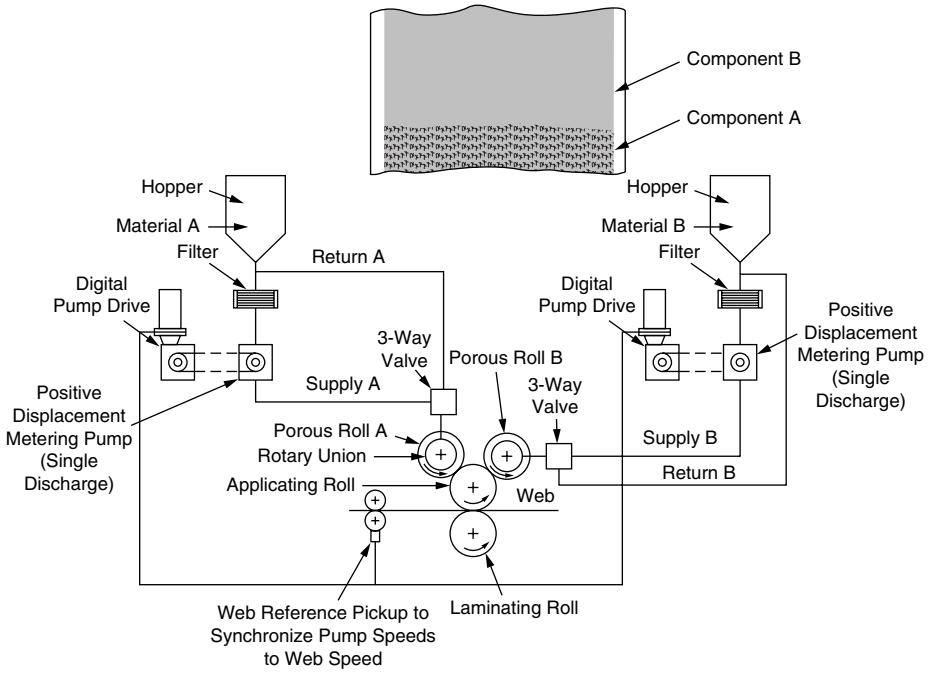

FIGURE 21.13 Application of two-component silicone system.

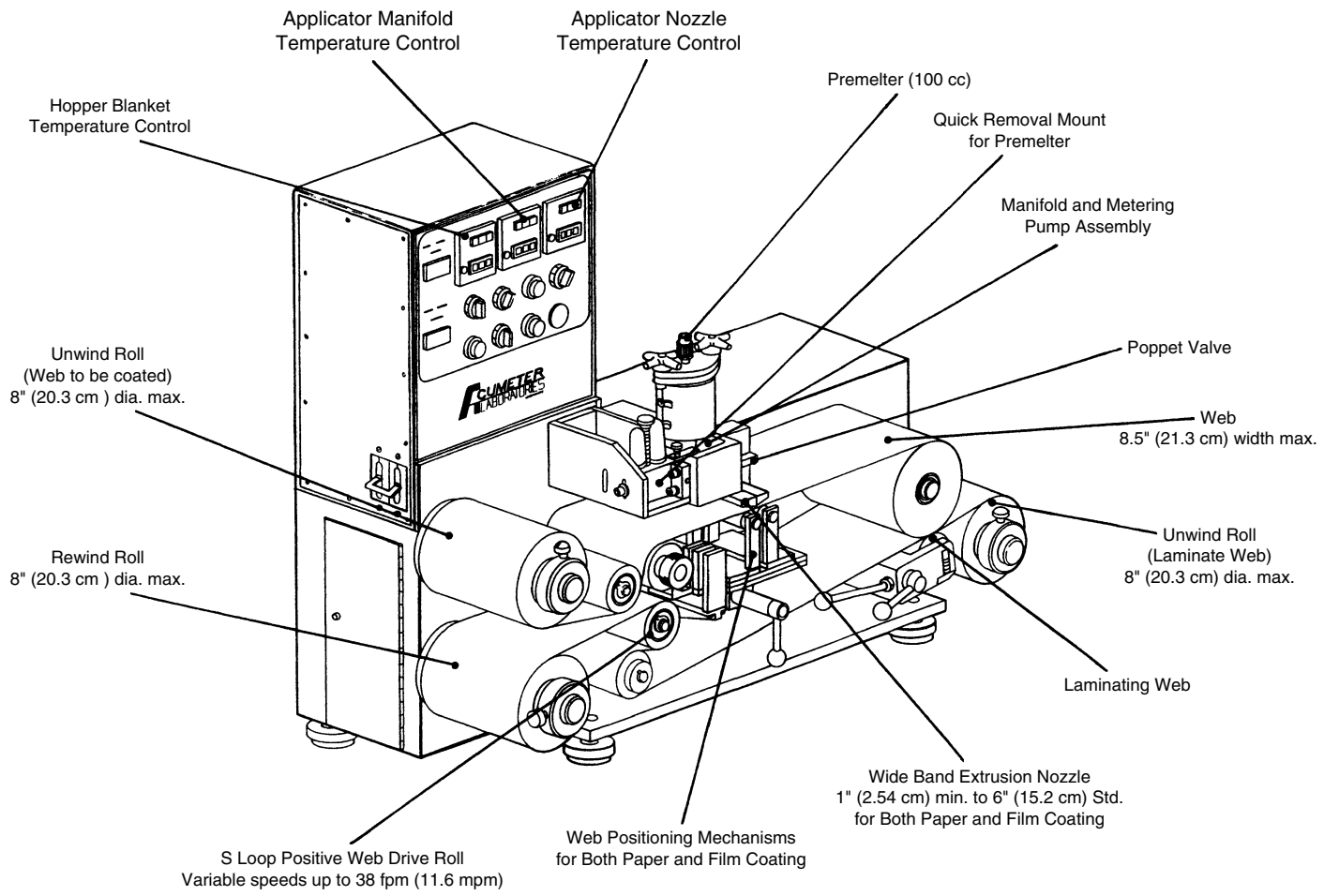

FIGURE 21.14 Schematic diagram of a porous roll laboratory coater.

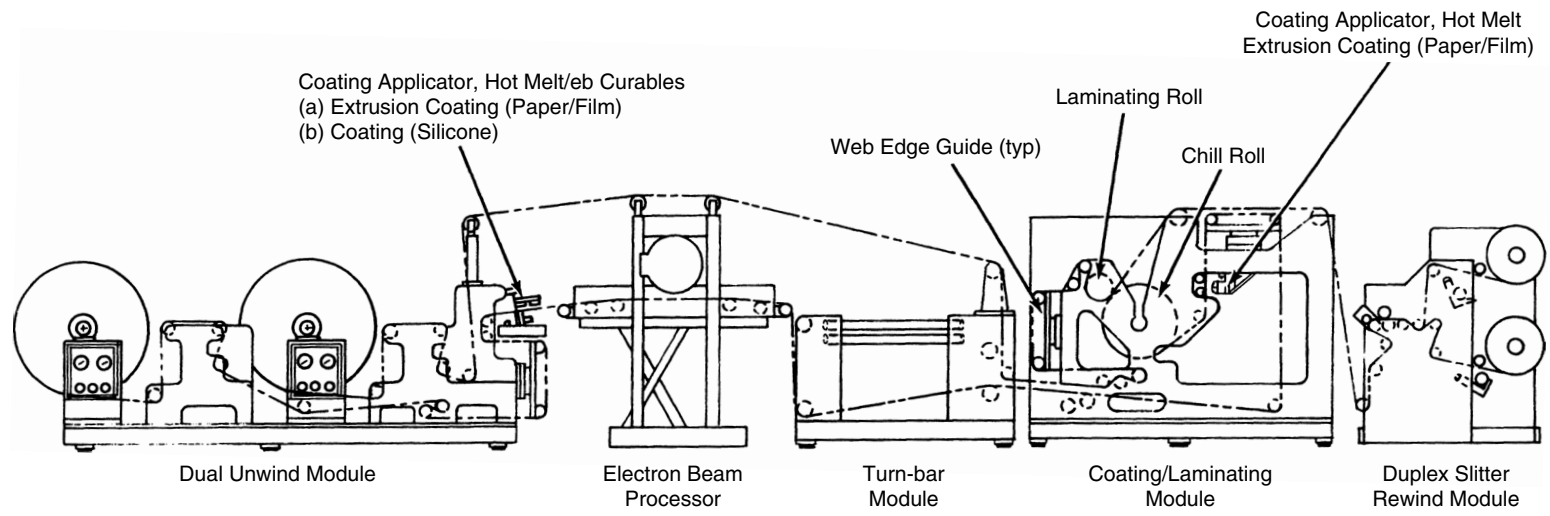

FIGURE 21.15 A coating line with a porous roll coater.

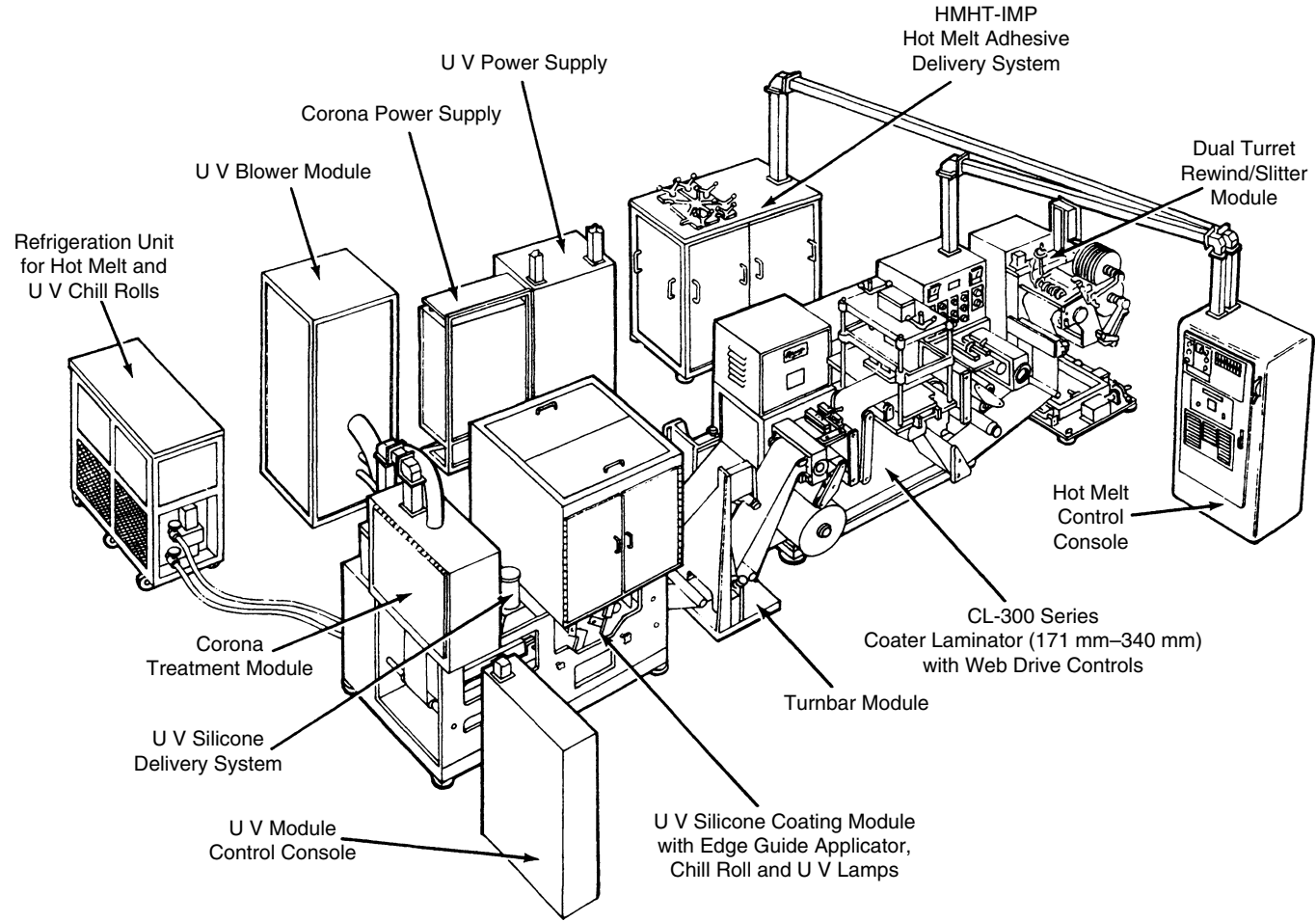

FIGURE 21.16 Label stock manufacturing line.

22

Rotary Screen Coating

22.1	Introduction	22-1
22.2	Equipment	22-1
22.3	Products	22-1
	Pattern-Type Coatings • Dot Coating • Overall Paste Coatings • Foam Coatings	
22.4	Advantages	22-4

F. A. Goossens

Stork Brabant

22.1 Introduction

Not long after the introduction of multicolor printing machines, the one-color printing unit was also introduced, which through the years has found its way to a wide range of application areas such as wall cover printing, production of hard floor covering, technical coatings, artificial leather production, and last but not least, as a one-color printing machine.

22.2 Equipment

Screen coating equipment (Figure 22.1) consists of the following:

- The screen, which is a seamless, perforated, nickel sleeve. The degree of perforation is expressed in the so-called mesh number, indicating the number of holes per linear inch.
- The squeegee, which is mounted in the screen and serves as the supply and distribution pipe of the paste. The squeegee blade, which is mounted to this pipe, pushes the paste out through the wall of the screen.
- The whisper blade smooths the applied coating layer.

The amount of coating to be applied is determined by four factors:

- The choice of mesh number
- The squeegee pressure: that is, the angle formed between squeegee blade and screen (The smaller this angle, the higher the add-on.)
- The viscosity of the paste
- The squeegee setting with regard to the counter-pressure roller

22.3 Products

The coatings that can be applied by rotary screen are discussed in Sections 22.3.1 through 22.3.4.

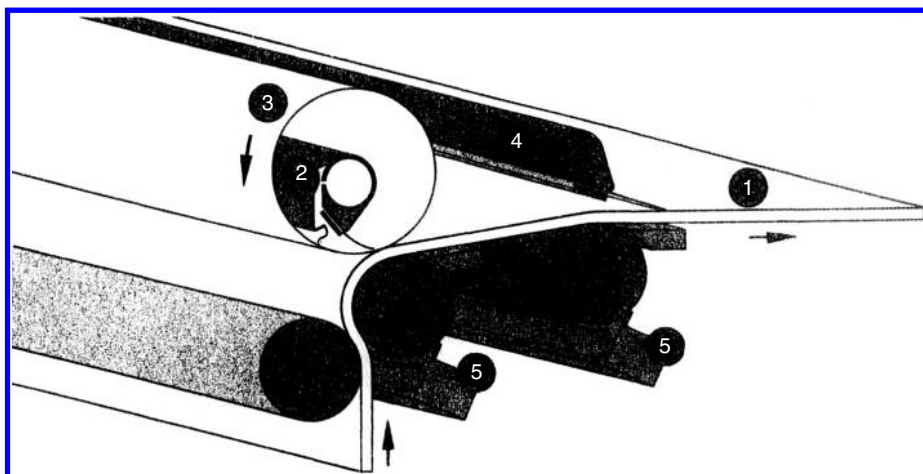

FIGURE 22.1 Screen coater. 1: web; 2: squeegee; 3: screen; 4: whisper blade; 5: doctor blade.

22.3.1 Pattern-Type Coatings

In view of the quantities required for pattern-type coatings and flock glue application, frequent use is made of 125 mesh and 40 mesh screens with a repeat size of 25 in. (64 cm).

End uses include women's fashions, wall-covering curtains, and partial chintz rainwear.

22.3.2 Dot Coating

Two types of screen are available to accommodate dot coatings: for regular dot coating, the dots are arranged in diagonal rows; for computer dot coating (CP), the dots are arranged at random.

For regular dot coating, the 17, 25, and 30 mesh screens find the widest application, and the CP 30, CP 40, and CP 46 (where 30, 40, and 46 designate the number of perforations per square centimeter) are the most frequently used CP screens.

Because of the need to apply an oscillating squeegee on the outside surface of the screen (only used for dot-coating applications), which has been designated to suit 64 cm repeat screens, dot coating can be effected with 64 cm repeat screens only.

End uses for dot coatings include fusible interlinings (woven and nonwoven) and print-bonding of nonwoven materials.

Advantages of screen coating compared to traditional coating by means of an engraved roller are as follows:

- Screen costs are considerably lower than the cost of an engraved roller.
- The time for exchanging screens is extremely short (~10 min).
- The application amount is easy to control.
- Light-sensitive nonwovens (20 g/m²) or knitted fabrics can be processed without problems thanks to the frictionless application system.
- There is no penetration, resulting in effective use of paste and a good controllable hand.
- The constant paste supply ensures precise level control by means of a past processor.

A new development is the application of foam-dot coating, in which the foam is applied with the so-called closed system (see Figure 22.2). The foam, which has been made in the foam processor, is applied directly on the substrate via a "closed" squeegee, as shown (Figure 22.2). The foam processor will be adjusted for the application weight wet.

For example, suppose we have a polyamide paste with 33% solids. To apply a dot coating with a 10 g/m² dry add-on, the foam processor is adjusted for 30 g/m² wet add-on.

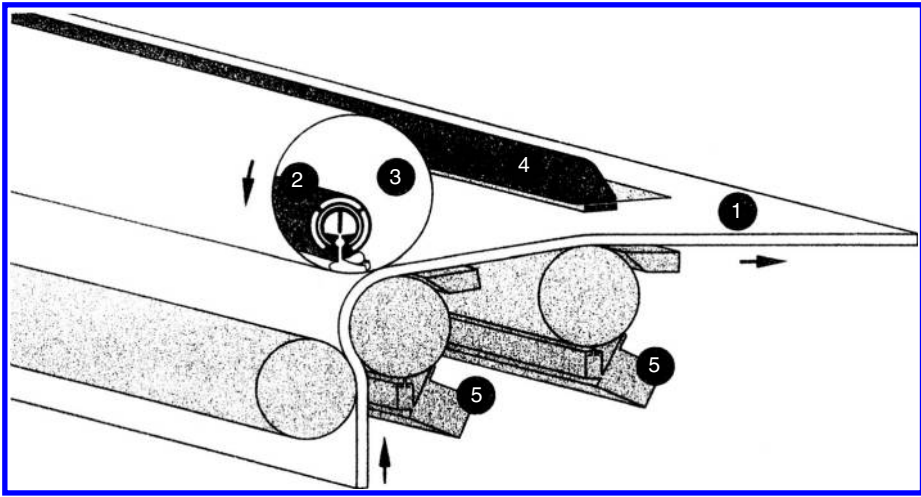

FIGURE 22.2 Foam coater. 1: web; 2: squeegee; 3: screen; 4: whisper blade; 5: doctor blade.

22.3.3 Overall Paste Coatings

Fine or thin coatings are in a range of 5 to 25 g/m² of dry application weight. Sorters used are 80 mesh 12% open area, 100 mesh SP (special) 20% open area, and 125 mesh SP 12% open area, 130 μm thickness (indication only).

End uses include anoraks, skiwear, sportswear, rainwear, umbrellas, pressure-sensitive coatings (medical), and shift-fast coatings.

Medium coatings fall in a range of 15 to 20 g/m² of dry application weight. Screen used are 60 mesh LR (long run) 14% open area, 125 μm thick, and 40 mesh LR 20% open area, 130 μm thickness.

End uses include roller blinds, aluminum-coated curtains, bag material, and ironing bar covers.

Heavy past coatings, having a dry application weight of 15 to 130 g/m² are frequently applied with the 40 mesh HX (hexagonal) screen with 30% open area and 300 μm thickness.

End uses include vertical blinds, flame-retardant coatings on upholstery and technical coatings, and tablecloths.

Screens for paste coating always have a 64 cm (25 in.) repeat size.

The squeegee blade is 28 mm × 0.2 mm.

22.3.4 Foam Coatings

Only three types of screen are applicable when coatings are applied by means of thermally unstable foam (foam collapses in drier/stenter) or stable foam:

1. 40 mesh HX (50% open area, 300 μm thick, 91.4 cm [35.8 in.] repeat) for foam coatings having a dry weight of 20 to 60 g/m²
2. 14 mesh HX (40% open area, 450 μm thick, 91.4 cm [35.9 in.] repeat) for foam coatings having a dry weight of 50 to 100 g/m²
3. 25 mesh HX (30% open area, 350 μm thick, 91.4 cm [35.9 in.] repeat) for average foam coatings

Stable foam is applied by means of a squeegee blade 40 mm wide and 0.2 mm thick.

End uses include black-out curtains or roller blinds, breathable coatings for anoraks and rainwear, and flock adhesive on curtains and shower curtains.

Thermally unstable foam coatings are applied directly by means of the “closed” system (see Figure 22.2) via the foam processor and the closed squeegee through the screen on the fabric. The wet application weight can be adjusted on the foam processor.

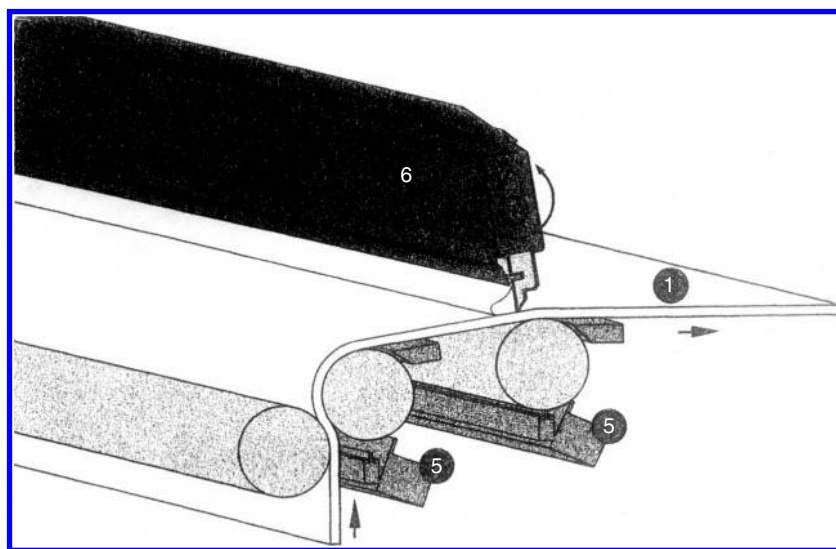

FIGURE 22.3 Adaptation of screen coater for knife coating.

For example, to apply 30 g/m² dry of an acrylic or polyurethane binder (50% solids), simply adjust the wet application weight on the foam processor at 60 g/m².

End uses include velour backcoatings, automotive backcoatings, mattress ticking, fixation of pile on pile fabrics, flame retardant and cigarette-proof coatings, imitation suede, and antislip coatings.

22.4 Advantages

1. Because substrate, screen, and counterpressure rollers have the same speed, coating is done without tension and friction. Thus, virtually all substrates can be processed on this system, including knitted fabrics, velours, nonwovens, and shift-sensitive materials, such as skiwear, mattress ticking, and Lycra fabrics.
2. The user has penetration control: penetration into the substrate can be completely avoided or, if desired, controlled.
3. Thanks to the low system content, the coating method is clean, and fast changes are possible.
4. Coatings are exactly reproducible. As parameters, squeegee pressure, squeegee setting, mesh number, and viscosity can be measured and read off, and any given coating can easily be repeated.
5. Chemical savings (up to 20% of the coating weight) are realized in two ways: (a) through accurately controllable application and because the screen follows the web structure exactly (thus, the textile character is maintained, and an excess of paste, such as occurs with knife coating, is avoided); and (b) through great accuracy, in left/right and longitudinal directions, of the application amount.
6. Application is both tensionless and frictionless.
7. By means of the closed system, the user has total process control.
8. The knife coating option can be attached above the whisper blade roller, mentioned earlier.

This knife coating (see Figure 22.3) can be used as a knife-on-air system for paste or unstable foam coatings and in the knife-over-roll coater made for foam applications. In both cases, the apparatus is fitted with a paste or foam distribution system over the full working width. In this way, it is possible to apply colored coatings with a totally even appearance.

The schematic diagram of a rotary screen coating line is shown in [Figure 22.4](#).

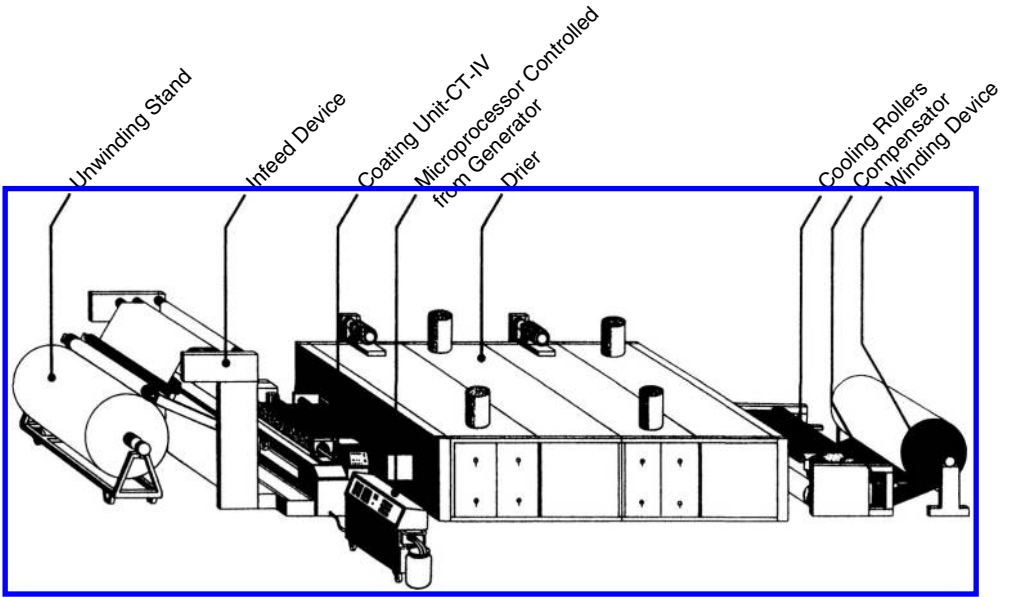

FIGURE 22.4 Screen coating line.

23

Screen Printing

23.1	Introduction	23-1
23.2	Geometry of the Printing Screen	23-2
	The Rotary Screen	
23.3	The Stencil	23-3
23.4	Dynamics of the Squeegee.....	23-3
23.5	Coating Transfer	23-4
23.6	Converting the Applied Coating	23-4
23.7	Conclusion	23-4
	References	23-4

Timothy B. McSweeney

*Screen Printing Association
International*

23.1 Introduction

The screen printing process is markedly different from most imaging processes generally associated with the graphic arts. First, the printing plate is actually porous, formed by a woven mesh of synthetic fabric threads or metal wire (or in at least one case, by a nonwoven, electroformed metal matrix), which is then combined with a selective masking material, commonly called a stencil. Because the coating material flows under pressure into and through this mesh or matrix before being deposited onto a substrate, the resulting coating has a thickness far greater than that of a material printed onto the substrate by offset lithography, gravure, flexography, xerography, or ink-jet printing.

For this and other reasons, the screen printing process has many practical applications in industrial manufacturing areas in which other printing media have few or none.

The basic process steps are as follows (see also [Figure 23.1](#)). The woven mesh (or matrix) is affixed to a rigid framework of aluminum or steel. In most applications, this framework forms a rectangular plane. However, variations are possible, including the cylindrical screen, which is affixed and sealed at both ends. In the case of mesh, whether of synthetic polyester monofilaments or stainless steel wire, tension is applied simultaneously in opposing directions to obtain a semirigid planar surface. This stretched printing screen then performs three distinct functions: (a) meters the fluid coating (or ink) that flows through it under pressure, (b) provides a surface for shearing the viscous columns of coating material that form during transfer to the substrate, and (c) provide support for the imaging elements (the stencil).

Ink or coating transfer is initiated by the imposition of pressure on the screen by means of a flexible plastic blade, the squeegee. Because of the flexibility of the blade material and its physical profile, a hydraulic action is caused by force exerted in two directions. The blade presses into the screen, and its inherent flexibility enables it to be put into direct contact with the substrate, thus effecting ink transfer. The blade also sweeps in a horizontal direction, thus applying the ink or coating as it moves, and causing the columns of material to shear as the printing screen rebounds after the squeegee has passed.

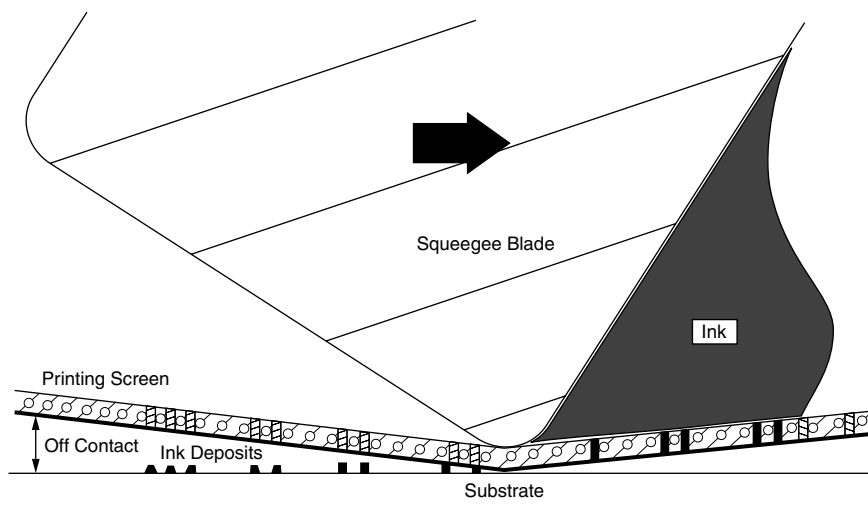

FIGURE 23.1 Ink transfer by screen printing.

It is the combination of the horizontal print stroke and the vertical (downward) pressure, effected by the squeegee blade, that forces the ink of coating into the ink “wells” created by the areas of intersection of woven mesh. (Similar wells, though shaped differently, are produced within the matrix of electroformed metal printing screens.) The elasticity of the printing screen then allows temporary contact with the substrate and subsequent ink or coating transfer.

23.2 Geometry of the Printing Screen

Due to a variety of materials and manufacturing methods, the geometry of the printing screen can vary considerably. Of most common use in industrial applications is the woven mesh, consisting of extruded polyester threads that have been woven into a precise and regular pattern known as “plain weave.” For a given linear measurement, the number of thread crossings or intersections, called the mesh count, may be expressed, as produced, in either metric (European) or British (Japanese) increments. At 130 intersections (meshes) per centimeter and higher, it is common to weave the fabric in a twill weave, where one x -axis fiber crosses under and over every other y -axis fiber (instead of every y -axis fiber in the plain weave). Weaving produces thousands of roughly cubical apertures formed by fiber intersections at each of the four corners. It is the length, width, and depth of these apertures that form the inkwells and exert the primary influence on amounts of coating deposit.

Thread diameter, though consistent within each woven fabric, is a variable that allows a wide choice of fabric thicknesses and thus substantial control over applied coating thicknesses. Threads that are available range from over 700 μm down to just over 30 μm (0.0275 to 0.0012 in.) in diameter. The fabric thickness and, therefore, the inkwell depth, is approximately 1.85 times thread diameter.

The woven mesh is tensioned to predetermined levels and affixed to a frame. For synthetic fabrics, the effects of tensioning can also reduce aperture depth slightly by reducing fabric thickness by up to 3%. For steel wire, however, there is no such reduction.

A stencil material, when present, blocks the aperture either partially or totally, thus diminishing the amount of deposit, while adding depth to the walls of the aperture, thus increasing coating deposit.

The total volume of ink or coating deposited is thereby determined by the fabric thickness (the area of the screen/stencil that encompasses the image) minus the volume of the threads (or wires) within the image area.

The coating flow through the mesh aperture is also affected by its viscosity and the operation of the squeegee.

23.2.1 The Rotary Screen

In principle, the action of the cylindrical screen used in rotary screen printing is similar to that of flat screens, in that the coating material flows through open areas perforating a thin printing “plate.” This differs, however, in the basic configuration, which is cylindrical rather than flat. The ink or coating is pumped into the interior of the cylinder, which is sealed at either end by printing heads. Also positioned within the cylinder is the squeegee.

The screen is composed (in one variation) of a seamless electroformed nickel mesh tube that then receives an emulsion coating for producing the patterned stencil. Other methods for producing rotary printing screens achieve similar results.

Rotary screen printing has the advantage of continuous operation, without the intermittent sweep and return of the printing squeegee as in flat printing. Thus, the opportunity to increase speed of production is presented, particularly for substrates printed on a web.¹

23.3 The Stencil

The masking of open mesh, known generically as the stencil, serves to control the pattern or shape of coating deposit (and to a lesser degree, the thickness of deposit). A variety of masking materials and applications are available, from CAD-generated cut films to photosensitive polymers and emulsions. Compatibility between the masking material and the ink or coating chemistry is necessary to preserve the stencil during printing.

Film stencils are adhered to the substrate side of the printing screen, while liquid emulsions are coated onto both sides. Positive-image photo film masters are then positioned on the screen prior to exposure of photosensitized masks. Exposed areas harden to form the mask, while unexposed portions are washed away in the development procedure.

Where the stencil blocks a mesh aperture, the ink or coating material is prevented from flow-through to the substrate, whereas partial blocking only restricts deposition. In this way, imaging is achieved.

23.4 Dynamics of the Squeegee

The printing tool in screen printing is the squeegee, an instrument bearing some resemblance to the doctor blade used in gravure. However, the squeegee blade is much more flexible, consisting in most cases of a high-density polyurethane elastomer, chosen for characteristic durability and solvent resistance. Other elastomers and rubber can also be used, depending on the application.

In flat screen printing, the squeegee makes intermittent and repetitive sweeps across the printing screen, thus forcing the fluid coating into the empty apertures of the mesh, and then into contact with the substrate (with the aid of the flexing of the screen). This action necessarily involves the application of force, applied in vertical (typically downward) and horizontal directions simultaneously; thus, the friction involved calls for wear resistance on the part of the blade.

Because the blade is made of a flexible elastomer, it also flexes, which produces an angle of attack with the mesh, typically about 80° from horizontal.

The properly tensioned screen has a force of several pounds per inch, more commonly expressed in newtons per centimeter, which resists the force of the squeegee. The ink or coating has a lesser force, dependent on its viscosity, which contributes to the hydraulic activity. Immediately following passage of the squeegee in the horizontal direction, the screen begins to separate from the substrate, and the coating shears away from the screen flowing into deposition on the substrate.

An additional tool, known as the floodbar, is a common component of automated flatbed screen printing presses. This thin, wide, and relatively flat metal bar passes in contact across the printing screen between squeegee print strokes, filling the open mesh with coating material. The flood stroke does not, however, exert sufficient pressure to cause the screen to flex into contact with the substrate. Therefore,

no coating transfer out of the screen will take place. The flood stroke helps to ensure uniformity of the printing or coating application.

23.5 Coating Transfer

As a result of the application of the squeegee force, the mesh forms an area of contact with the substrate, and part of the ink or coating that fills the mesh aperture now adheres to the substrate. Cohesive forces within the viscous fluid (now in “columns”) tend to hold the coating material together while it flows. As the squeegee passes, the flexing mesh separates from the substrate, and shearing forces cause the fluid to separate at the mesh. Even though the coating adheres to the aperture surfaces of the mesh, only a relatively small layer of material actually remains within the mesh, as the coating separates from itself in obedience to shearing forces, thus the relatively thick deposit of coating material achieved by the screen printing process.

For proper ink or coating release from the screen, the rate of ink shearing must equal the speed of the printing squeegee and the rate of ink release from the mesh. Following transfer to the substrate, the ink or coating that has been released has a further tendency to flow, from a series of “column-shaped” deposits, into a more uniform layer. This spreading phenomenon is largely dependent on the viscosity of the material that has been printed, the amounts of coating material deposited, and the time that elapses until the coating begins to dry.²

23.6 Converting the Applied Coating

Because the majority of inks and coatings applied by the screen printing process are liquid or at least in a semifluid state, complete conversion of the end product requires a drying or curing process. Among the methods used to achieve a solid film state are (from the slowest to the most rapid) evaporation, oxidation, catalytic curing, infrared radiation, ultraviolet radiation, and electron beam radiation. Each of these processes is most appropriate to specific coatings chemistries. In web systems and nonweb conveyerized systems, the speed of production depends not only on the ink or coating chemistry, but also on the stability of the substrate when under temperature (and other) conditions imposed by the conversion process, as well as the thickness of the applied coating film. Factors such as surface reflectivity, ambient humidity, and head absorption can also come into play.

23.7 Conclusion

The screen printing process is a unique method used for the application of inks or liquid coatings to a wide variety of substrate types, shapes, materials, and surfaces. It is easily adapted to the problem at hand, capable of depositing relatively thick wet films in a short time in either a repetitive or continuous fashion. The process can be integrated with other production processes, whether specifically related to graphic arts or otherwise. Applications may be practical (e.g., conductive printed circuitry) or decorative, pigmented or transparent, or finely detailed or broad in coverage. A comprehensive industry support system draws from the fields of photography, chemistry, industrial engineering, and manufacturing technology to provide a vast array of process variations and potential uses for this most flexible of printing techniques.

References

1. M. Taylor, “Automatic printing of textile yard goods,” *Technical Guidebook of the Screen Printing Industry* N4. Fairfax, VA: Screen Printing Association International, 1981.
2. E. Messerschmitt, *Screen Print.* 72(10), (1982).

24

Flexography

24.1	Introduction	24-1
	Historical Development of the Aniline and Flexographic Printing Process • The Flexo Process	
24.2	Flexo Press Systems	24-2
	End Printers • Stack Presses • In-Line Systems • Central Impression Machines	
24.3	The Most Important Flexo Deck System	24-5
	Three-Roller System (Fountain Roller Color Deck) • Two-Roller or Fountainless Printing Deck	
24.4	Printing Forms or Plates.....	24-7
	Rubber and Photopolymer Plate Making • Printing Plate Mounting and Proofing	
24.5	Print Substrates and Printing Inks.....	24-9
	Print Substrates • Flexo Inks	

Richard Neumann
Windmüller & Hölscher

24.1 Introduction

Throughout the printing industry, flexography, or flexo, has established its reputation as a quality printing process bearing comparison with letterpress, gravure, and offset, which have been used industrially for many years. Today, the whole packaging sector and other areas of the printing industry would be unthinkable without this highly economical quality printing process. This is attributable primarily to the high flexibility flexo offers, its qualification for a wide range of materials, the large and variable range of print repeat lengths, the different press widths available, and the quite extraordinarily high production speeds. Other advantages include the highly diversified flexo press specifications and the possibility of using flexo in line with other printing techniques and processing operations.

Finally, the developments and improvements achieved in the field of press engineering, flexo printing plates, and flexo inks have recently contributed quite decisively to the position the process holds today.

24.1.1 Historical Development of the Aniline and Flexographic Printing Process

Today's flexo process is far more than 100 years old. According to historians, extremely primitive aniline work was produced in the United States as far back as 1860.

The original name of this letterpress process, "aniline printing," is traceable to the aniline dyes used in the mid-19th century that were diluted in alcohol and had been used in printing for many years. This rubber printing process — until 1970, rubber printing plates were used exclusively — was initially employed for the printing of wrapping papers. The first aniline printing apparatuses are said to have been used in England and Germany beginning in 1890. From about 1910, some European machine manufacturers started to supply aniline printers in combination with paper bag machines to permit printed paper bags to be produced in a single pass. From the early 1920s until approximately 1940, aniline

printing machines were slow speed units of simple design and lightweight construction, and, for the most part, were intended to operate in line with paper bag machines. However, the first four-color roll-to-roll presses also were developed and introduced to the packaging industry at this time; in addition, printing inks were substantially improved, the first drying arrangements were installed on printing machines, and there were new packaging materials such as cellophane and other nonabsorptive substrates that had to be printed by this process.

In the course of the 1950s, this special letterpress technique gained in importance for a variety of packaging applications. The first pigment inks were developed, and machines providing improved stability, higher precision, and faster operation were designed, built, and even mechanized to some extent. It was also in the 1950s when — again in the United States — the name of “flexography” was created, which rather quickly became general usage in the trade worldwide. Flexography is defined as “a letterpress printing method utilizing rubber printing plates and liquid, quick-drying inks.”

Over the past 25 years, this printing process has become a widespread technology; it has been improved consistently, especially since 1972, when the photopolymer printing plate was developed and introduced. Over the past 5 to 8 years — and this is attributable first and foremost to the relatively low printing plate costs and the good print quality achieved, as well as to the versatile application possibilities — flexo has developed into an industrial printing process and is now a serious competitor of the established printing methods, offset and gravure.

24.1.2 The Flexo Process

Like the letterpress process, flexo utilizes raised printing plates of rubber or soft-elastic polymer, the raised areas of the plates transferring the ink onto the substrate. The low-viscosity, quick-drying ink, which is diluted by means of solvents or water, is conveyed by a fountain roller or, more recently, by an ink chamber–doctor assembly and a transfer or anilox roller to the printing plates or stereotypes, as they are also called.

The most widespread mode of operation today is the roll-to-roll technology and printing in line with surface finishing machines. Whereas in former times only bags, sacks, and paper packaging materials were printed flexographically, the use of flexo today includes a great number of plastic packages in the food and hygiene sector, applications in the aluminum industry, and carrier bags, labels, wallpaper, corrugated board and cartons, newspapers, handkerchiefs, magazines, envelopes, stationery, and other articles requiring printing.

As a result of its high flexibility, flexo has succeeded in continually conquering new market areas and has penetrated into many a domain previously reserved for offset or gravure.

24.2 Flexo Press Systems

The most usual flexo press layouts, which are known worldwide, can be subdivided into four main groups:

- End printers
- Stack presses
- Central impression machines
- In-line systems

Color decks and other machine components may often be identical for these different press versions. Nevertheless, to get the best possible final product, it is quite important and decisive to select the correct machine for a specific application.

The different machine versions are used for both printing and surface finishing of a wide range of products including packaging materials of paper, plastic films, and aluminum foil (i.e., from thinnest flexible polyethylene [PE] films to heavy-duty cartons). Number of colors, working width, print repeat length, and machine speed may vary quite substantially and may, accordingly, call for different machine layouts and conceptions.

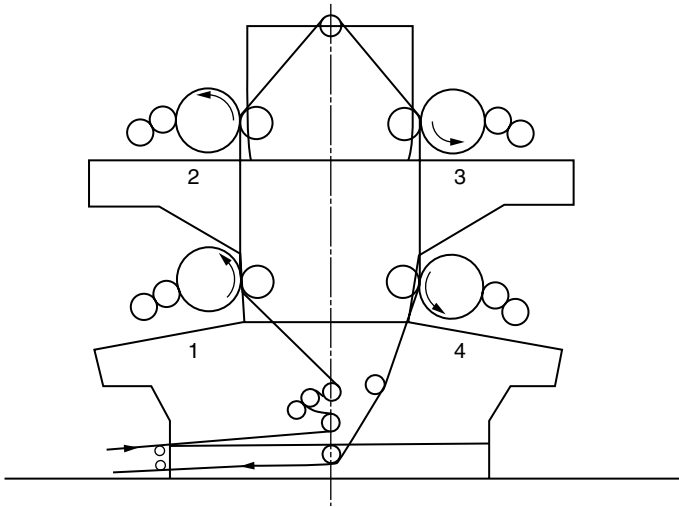

FIGURE 24.1 Flexo end printer with four color decks.

24.2.1 End Printers

Today's flexo end printers have their origin in the aniline printing units developed around the turn of the century. Initially attached to paper bag machines, they served for one- or two-color "mechanized stamping" of paper bags, and later also for the printing of sacks and sheets. In the middle of our century, several thousand machine combinations were installed throughout the world, consisting of flexo end printers and paper converting machines for the printing and making of paper bags and sacks in a single operation (Figure 24.1). Following the development of polyethylene, this highly efficient printing technique was extended to include PE items as well.

These machine combinations dispense with a separate operation and reduce roll handling requirements; in addition, they save personnel, space, and capital expenditures, in addition to reducing waste. All these factors together generate improved economics. Today, end printers are available in working widths between 25 and 320 cm.

Depending on the capacity of the converting machines, speeds up to 400 m/min are achieved. Usually, three- or four-color stack printers with separate impression cylinders are used, but one- and six-color units are in use as well. Such end printers are employed exclusively for printing line drawings, solids, and type. They do not lend themselves to actual quality printing, which is reserved to roll-to-roll flexo presses featuring the appropriate optional equipment.

24.2.2 Stack Presses

The first flexo press working from roll to roll was a stack-type press developed on the basis of an end printer. Stack presses normally consist of four- or six-color decks with two- or three-color decks incorporated on top of each other on either side of the print unit frame. The configuration of such roll-to-roll presses is almost identical with all press manufacturers. Over recent years, a high level of standardization of press layout has been reached (Figure 24.2).

The web is fed from a simple or fully mechanized unwind unit for automatic reel splicing via a constant feed-draw assembly to the print unit frame, where it is printed in several colors, with a drier for drying the applied printing ink arranged after each deck. Leaving the last color deck, the web passes through a drying tunnel or other final drying arrangement for thorough drying of the ink and is then led via one or two chill rolls, combined with adjustable nip rolls, to the rewind unit or to a fully automatic, dc-motor-driven winding machine featuring a roll splicing facility.

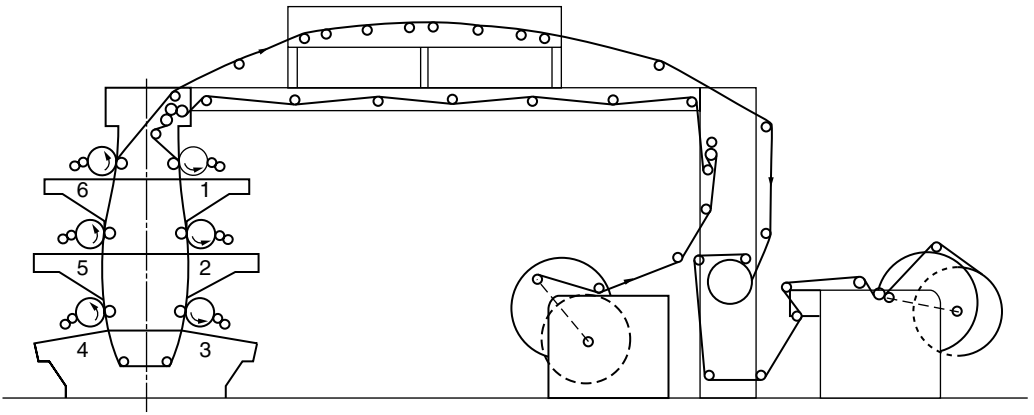

FIGURE 24.2 Stack-type flexo press with six color decks.

Stack presses are used for printing rigid materials. The between-color register accuracy in the machine direction is approximately ± 0.2 mm T.I.R. (total indicator runoff).

Four-color presses are used in the market, but the majority of central impression machines are six-color presses permitting four-or-six-color halftone process printing using screen counts of the plate of 48, 60, or even 70 lines to the centimeter. This obviously calls for a perfect printing plate, appropriate printing inks, and a high precision machine. These requirements have been met, and as a result, even flexible materials can today be printed flexographically with a quality approaching that achieved by the gravure and offset processes.

For the reasons outlined, the demand for central impression machines has drastically increased over recent years, this design also being presently used to print rigid materials such as papers and compounds. Apart from this, the application of these presses has been extended to the wallpaper and corrugated board industry. The biggest machines have a 2 to 3 m diameter impression cylinder and cover a working width of approximately 2.5 m. They achieve printing speeds of approximately 300 m/min, and 400 m/min is not unusual with standard design presses.

24.2.3 In-Line Systems

These machines are similar in configuration to gravure presses. For each color, a separate frame is used, with the option of having any desired number of printing stations arranged one after the other, the drive connection between the individual frames being provided by universal joint shafts or the like. These machines call for a large floor space and involve substantial capital expenditure. This, in turn, means that they can be economically used only for long production runs at high speeds. Their main field of application is in the printing of aluminum foils, papers, and cartons (Figure 24.3).

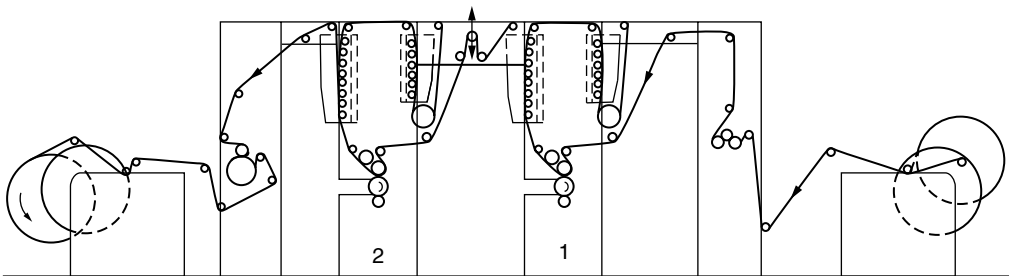

FIGURE 24.3 Flexo in-line machine with two printing stations.

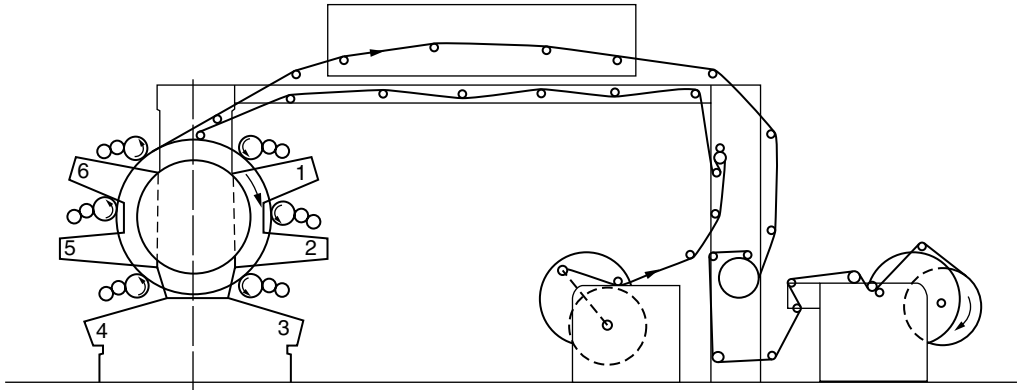

FIGURE 24.4 Central impression flexo press with six color decks.

The essential advantage of this machine configuration lies in the long interunit drying paths that permit wet-on-wet printing at high speeds. Modern high speed presses of the type achieve rates of up to 600 m/min (10 m/s) under production conditions. Stack presses allow the web to be printed with six colors on one side, with five colors on the face and one on the reverse or in configurations of 4:2 or 3:3. Stack presses normally achieve production speeds of 400 m/min on paper. They are built in working widths between 25 and 250 cm.

This press design, which was the best-selling machine version about 25 years ago, has been continuously superseded by central impression machines over the past decade, and today only 10 to 15% of all new web-fed presses are built on the stack principle.

24.2.4 Central Impression Machines

The first central impression flexo press (i.e., a press with the color decks arranged like satellites around a large-diameter common impression cylinder), was developed in 1953–1954 and introduced to the trade. The suggestion for the design of this press system came from the plastic film industry, where the need for a printing machine giving better web control had become obvious. And this need has been satisfied indeed: the web comes from the unwind, passing through a draw unit to the first color deck on the central impression cylinder, where it is pressed onto the cylinder surface and firmly held to it until it leaves the last printing deck. This working principle guarantees an immovably fixed position of the web so that no register variations are liable to occur during printing. With the use of an appropriate drive system, maximum longitudinal register tolerances keep within 0.1 mm T.I.R. (Figure 24.4). Hence, it follows that this rotary press offers the best register accuracy without any mechanical or electronic aids and additional equipment.

The key component of the central impression machine is the common impression cylinder designed for maximum concentricity ($5 \pm$ T.I.R.) and perfectly constant temperature over the full width of the cylinder ($\pm 0.5^\circ\text{C}$) during printing.

Central impression machines are built in working widths of 60 to 160 cm. Apart from standard systems, there are also available today press versions utilizing so-called slide-in printing units or subunits, thereby reducing idle time on job changeover. Moreover, printing stations are being used that are designed for changing from flexo to gravure with or without the use of subunits. This concept adds to the application possibilities of the press and ensures optimal utilization.

24.3 The Most Important Flexo Deck System

Having explained the four different flexo press versions available today in the marketplace, we turn to the most important and most interesting color deck system.

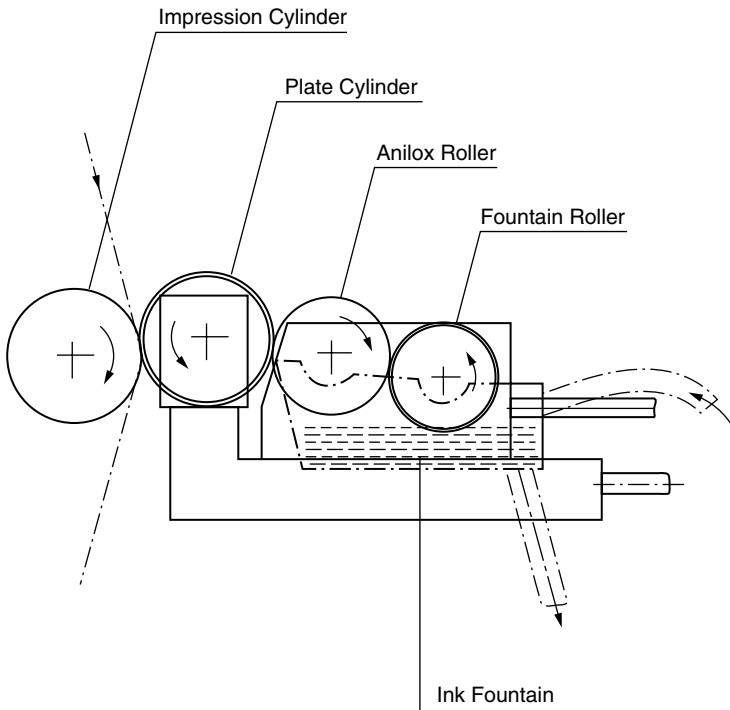

FIGURE 24.5 Three-roller system of fountain roller color deck.

As a matter of fact, the color deck is the most important component of a flexo press. Today, only two printing deck systems are still of general and topical interest — the three-roller system or fountain roller color deck, and the two-roller system or fountainless color deck. The latter has gained increasing importance over recent years and enjoys steadily growing popularity, because it achieves higher print quality.

24.3.1 Three-Roller System (Fountain Roller Color Deck)

The three-roller printing deck was developed many decades ago and has been continually improved. It is today the most commonly used deck version found in flexo presses. It is relatively simple to operate and to set up, offers great flexibility, and, until some years ago, was the appropriate design to meet all user requirements. The conventional three-roller printing deck is mounted on a pair of frames or consoles and normally consists of a pair of angular bearing blocks to take the plate cylinder and a pair of inking roller bearing blocks to accommodate the inking rollers (i.e., the anilox and the fountain roller). Also, an arrangement to receive the ink fountain would usually be incorporated. For changing the plate cylinder to print a different repeat length (or, for the purpose of impression adjustment), the plate cylinder, together with its angular bearing brackets, is horizontally loaded to or unloaded from the impression cylinder. This is done mechanically, hydraulically, or by motor. The same applies for the fountain and anilox rollers and for the ink duct (Figure 24.5). This is accomplished through manual or motorized adjustment by threaded spindles or, more recently, by computerized systems providing different automation levels.

The moment the machine stops (i.e., when printing is interrupted), the plate cylinder must be lifted clear of the impression cylinder and of the web in order to prevent the plate and the substrate from sticking together. Thus, the plate cylinder is slightly lifted or retracted in the horizontal and vertical directions. At the same time, the plate cylinder must stop and come off the anilox roller so that no more ink is transferred to the plate. To prevent the ink from drying on the rollers while the press is standing still, the anilox and fountain rollers must continue rotating, powered by a separate motor. To prevent

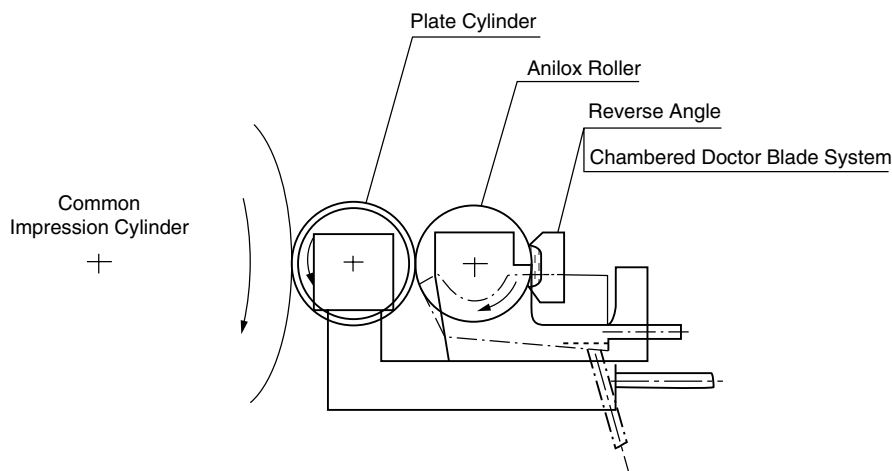

FIGURE 24.6 Two-roller or fountainless printing deck.

grinding and damage to the printing plates, the circumferential speeds of the anilox roller must always be equal to the surface speeds of the plate on the print cylinder.

With the three-roller printing deck, the amount of ink to be transferred to the substrate can be varied by altering the gap between fountain and anilox roller. This is an advantage with the three-roller system. The inherent disadvantage is, however, that changes in speed necessarily result in variations of the quality of ink transferred to the printing plates, which, in turn, results in color deviations in the printed image.

24.3.2 Two-Roller or Fountainless Printing Deck

The latest technology in flexo deck system design is relatively new, and a great deal of engineering work and extensive experiments were necessary to accomplish an acceptable solution.

In the two-roller system, a plate cylinder and an anilox roller with doctor blade assembly has superseded the previously used fountain roller (Figure 24.6). Almost all doctor blade units are designed for laterally reciprocating doctor blade motion. Loading the doctor blade to the anilox roller is mostly done pneumatically, with fine adjustment of the contact pressure.

Initially, the anilox roller was being doctored only conventionally or positively, but over the past two years, negative or reverse-angle doctoring has been generally accepted and preferred. Press operators throughout the trade assert that especially when performing fine process work on high-speed wide-web presses, reverse-angle chambered doctor blades achieve more consistent and better results. This is attributable to the capability of such decks to provide even finer, more uniform, and exactly defined ink application over the full web width and throughout the machine's speed range. As an added benefit, anilox roller and doctor blade wear are minimized, provided the doctor blade is carefully set to the anilox roller with minimum contact pressure. Also, ink consumption is drastically reduced, no surplus ink is being transferred from the anilox-roller surface to the printing plates. This two-roller or fountainless printing deck with the reverse-angle chambered doctor blade system has been increasingly used throughout the industry and can be considered to be the printing deck system of the future. Most of the attachments and options found with flexo presses are identical to those used with offset and gravure presses and do not feature any specific process-related characteristics.

24.4 Printing Forms or Plates

Apart from the press design, printing plates are of paramount importance to quality flexo. To better understand flexo technology as a whole, some knowledge of printing plates and how they are made is indispensable.

Flexography owes its name to the exclusive use of flexible, elastic printing plates. They were made from natural and rubber compounds for decades, until the appearance on the market in 1972 of the first photopolymer plates for flexo, which have since succeeded in capturing quite a substantial market share. For many applications, however, rubber plates are still used today.

24.4.1 Rubber and Photopolymer Plate Making

As with any other printing process, good artwork is essential to making good rubber plates. For single-color printing, one negative is needed; for multicolor printing, one negative for each color is needed, with continuous tones being separated into dots. From these negative films, an original plate or a metal etching is prepared by photographic transmission using copper, magnesium, or zinc. On the basis of these metal blocks, so-called matrices are molded from board soaked in phenolic resin; this is done in a special molding press. After cooling, the molded matrix is used for making the rubber plate in the same press, using natural rubber compounds in thicknesses from 2 to 10 mm (normally 2.76 mm) and of a Shore hardness, depending on intended application, between 40° and 70° Shore A. Minor corrections of plate thickness are achieved by grinding the back of the plate. For the printing of solids, even today, plates are cut from vulcanized rubber by hand.

It takes less time and work to make photopolymer plates than rubber plates because the former are prepared directly from the negative, dispensing with metal etching and matrices.

There are two photopolymer systems, solid and liquid, the solid system being clearly preferred to the liquid technology. The solid system calls for a distinction between single-layer and multilayer plates. The latter utilize a soft base layer as a buffer layer, which serves to improve pressure compensation. On the back or in the middle, a layer of polyester film is provided to ensure dimensional stability. The light-sensitive polymer or relief layer is on top, covered with protective film, which is removed prior to exposure.

The plate-making process starts with back exposure to ultraviolet (UV) light for the purpose of sensitizing and polymerizing the plate. Next, UV main exposure takes place on the emulsion layer, through the negative, the latter being firmly held to the plate surface by vacuum. The decisive factors for proper polymerization of the printing area or image elements during exposure are the intensity of UV radiation and the time. Subsequent final exposure ensures perfect polymerization of the relief plate.

During the subsequent washout process using a special washout solution, the unexposed, nonpolymerized photopolymer is dissolved and removed from the plate. The plate is then dried by hot air and posttreated in an acid solution to get the final plate surface, with the final exposure of the plate increasing its resistance to solvents. Photopolymer printing plates are used in many different thicknesses and with variable relief depths to cover a wide range of applications. Hardness ranges from 45 to 60° Shore A.

Other plate-making methods have only minor importance and are not discussed here.

24.4.2 Printing Plate Mounting and Proofing

For production printing on the flexo press, the finished plates are pasted on the plate cylinder surface. This is mostly done using double-sided adhesive tape and whatever auxiliary equipment or machines will permit register-true plate mounting on the cylinders. The thickness of the adhesive film depends on the plate thickness; with a great number of flexo presses, the combined thickness is 3.0 mm.

Other mounting methods are also employed, but these are confined to special areas and therefore do not need to be discussed here.

Mounting the printing plates always takes place off the printing machine. With a view to avoiding unnecessary press downtime, the plate cylinders with the plates mounted on them are proofed before production begins. This is done using different methods and different apparatuses and machines. The proofing process is to demonstrate and ensure that the printing plates have been correctly and perfectly mounted, in accurate register, and without blisters. Following this, the proofed plate cylinder can be installed in the flexo press for trouble-free production printing.

It is also possible to test the design of a new printing subject before plates are made. As far as rubber plates are concerned, a print proof can be produced from the metal block by letterpress printing, whereas

with photopolymer plates, a color proofing system can be used to prepare a high quality color proof from the negative.

If the printing plates are to be reused, they must be cleaned thoroughly after completion of the production run and carefully stripped off the print cylinder; they should be stored lying as flat as possible and, especially when photopolymer plates are involved, they must be wrapped in lightproof material. It is, of course, also possible to store the complete cylinders with the plates mounted.

24.5 Print Substrates and Printing Inks

Because of the flexibility and versatility the flexo process offers, there is hardly any material that has not been printed flexographically, regardless of material thickness, elasticity or rigidity, surface properties, intended application, or many of numerous other material-related characteristics. Moreover, flexo permits printing of metal strips only a few centimeters wide or paper rolls as well as paper and film webs up to 3 m wide. Also, newspapers are printed by flexo today at production rates of approximately 700 m/min.

Obviously, then, there is a need for appropriate printing inks, bearing in mind that extremely varied demands are made on the ink to be used according to the specific material being printed, its proposed application, and the press speed. Also important in this respect are the very stringent statutory regulations that exist in the field of food packaging.

24.5.1 Print Substrates

The materials that can be flexo printed include paper, carton, cellophane, plastic films (both mono- and multilayer films), aluminum foils, and a wide range of special materials. Ranking first in the packaging industry, now as before, are wrapping papers, mostly consisting of blends of different pulps.

Sulfate kraft paper is a single-sided glazed pulp paper used primarily in the production of bags and sacks of all kinds. Sulfite and sulfate papers intended for similar applications are also flexographically printed. A drastic growth has recently been experienced in the field of kraft or test liner preprint for the corrugated board industry. Another area of flexo application includes tissue papers used as wrapping and toilet papers, hygienic papers for handkerchiefs and towels, as well as many other specialty papers. Also worth mentioning in this respect is the direct printing of corrugated board for use as outer packaging and the printing of cartons (e.g., liquid packs).

The first film to be printed flexographically, which raised substantial problems for all concerned, was cellulose film. Depending on its finish, cellulose film was mainly used in the packaging of foodstuffs and textiles. Since the arrival of plastic films, cellophane has lost a great deal of its former importance.

Polyethylene and polypropylene films possess many desirable properties and now rank first in the field of flexible packages. They are printed and processed in many different thicknesses (~10 to 250 μm), as either sheeting or tubing. Their main applications include carrier bags, food bags of all kinds, hygienic and sanitary articles and many other products, fertilizer and peat sacks, garbage sacks, cover films, shrink hoods, and the like. This wide selection of films is completed by polyvinyl chloride and polyvinyl dichloride films and other special films used as mono films or in combination with other materials for packaging or to impart to the container specific properties desired for a certain product to be packaged. This is achieved by laminating different materials, by coating, and by coextrusion.

All these materials and material combinations are printed by the flexo process. This also applies for aluminum foil, which may be plain or laminated or lacquered or coated in thicknesses from 7 mm up. It is used primarily in the sweets and candy industry, as lid foil, and in the packaging of butter, soups, coffee, and bread, as well as for many other packaging applications.

24.5.2 Flexo Inks

The substrates named in Section 24.5.1 call for a great variety of flexo inks offering many different properties. Flexo inks are similar in composition to the inks used in gravure package printing; they always

consist of colorants (dyes or pigments), binding agents (natural resins, artificial resins, or plastics), and a solvent or solvent blend. Whereas flexo inks used to be based on basic (soluble) dyes, pigment inks are used primarily today because of more exacting demands on the ink's fastness. To obtain the desired properties such as brilliance, adhesion, and qualification for laminating, the correct binding agents and additives must be selected.

Apart from the aforementioned properties, flexo inks are required to generate a quality end product. Fast and perfect drying of inks on the substrate during printing is another aspect of paramount importance, and in this respect, the solvent of the solvent mixture used is the decisive factor.

The drying system involves evaporation of solvents after the ink has been applied to the web. This drying process is substantially accelerated within the printing press using hot air, which is blown onto the web, and appropriate exhaust arrangements.

The most important solvents are hydrocarbons, alcohols, glycols, esters, and ketones. Recently, water-soluble pigment inks, once used exclusively in the printing of multiwall paper sacks, gift wrap, corrugated board, and wallpaper, have been playing an increasingly important role and also have been adopted in the fields of newspapers and plastic films. The obvious reason for the growing trend to use water-soluble inks in package printing and for plastic films is the new set of laws calling for reduction of solvent emissions into the environment.

25

Ink-Jet Printing

25.1	Introduction	25-1
25.2	Continuous Jet Printing.....	25-1
25.3	Impulse Jet (Drop-On-Demand) Printing.....	25-2
25.4	Ink-Jet Inks	25-3
	Bibliography	25-4

Naomi Luft Cameron
Datek Information Services

25.1 Introduction

Ink-jet printing refers to any system in which droplets of ink are ejected onto a printing surface to form characters, codes, or other graphic patterns. The ink-jet concept dates from the 1860s, when Lord Kelvin developed the first practical jet for pattern generation. Early commercialization was in the oscillographic recorder area in the 1950s. Since the 1960s, ink-jet developments have focused on computer output, with major contributions made by such scientists as Hellmuth Hertz in Europe (Lund Institute, Sweden) and Richard Sweet (Stanford University) and Steven Zoltan (Brush Instruments) in the United States.

Current commercial products range from printers for direct coding of packages, to high-speed-low-resolution direct mail printers (from Diconix), to graphic arts quality color plotters (from Iris Graphics), to graphic arts quality color plotters (from Hewlett Packard). To address this range of applications, several variants of the technology have been developed. Each approach involves trade-offs among cost, speed, reliability, and print quality, determined by interactions between hardware and supplies.

Ink-jet printing functions include the following:

- Creation of an ink stream or droplets under pressure
- Ejection of ink from a nozzle orifice
- Control of drop size and uniformity
- Control of which drops reach the paper
- Placement of drops on the recording surface

Control of these processes depends on several design variables, such as nozzle size, firing rates, drop deflection methods, and ink viscosity. Changing any variable typically requires adjustments to other system variables, making R&D advances slow and expensive.

Ink-jet printers fall into two basic categories: continuous jet (synchronous) and impulse jet (drop-on-demand). Most early development took place in the continuous jet arena, but recent emphasis has shifted to the less complex (and therefore less costly) drop-on-demand approaches.

25.2 Continuous Jet Printing

Continuous ink-jet systems operate by forcing pressurized ink in a cylinder through nozzles in a continuous stream. Nozzle diameters range from 3 to 0.5 mil; the smallest nozzles can require up to 600 psi of pressure to eject the ink. The ink stream is unstable, breaking into individual droplets either naturally

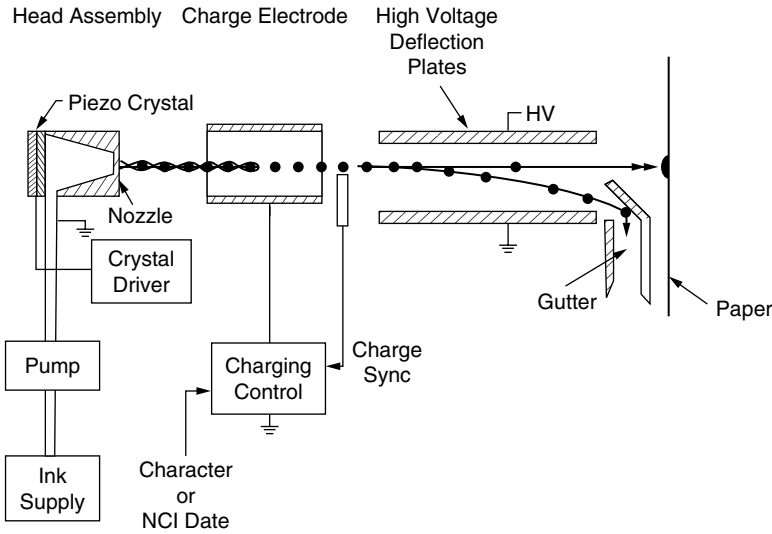

FIGURE 25.1 Continuous ink-jet print system. (From Sweet, R. G. et al., U.S. Patent 3,373,437.)

or through some applied stimulation such as ultrasonic vibration. Electrostatic deflection is used to control the droplets, which either reach the page in the desired pattern or are deflected into a “gutter” or “catcher” (see Figure 25.1). Deflection can be binary or variable.

Continuous jet printers either recycle or discard the unused ink, which can account for up to 98% of the generated droplets. Although preferable in terms of supply costs, recycling adds substantially to system complexity because of the need for pumps and ink purity safeguards (such as filters and solvent balance controls).

Continuous ink-jet systems are capable of very high speed printing, with drop frequency rates sometimes in excess of 100 kHz. At these rates, it is difficult to control individual droplets: their tendency to combine into larger drops leads to print quality concerns. Ideally, however (i.e., when controlled), this tendency can yield enhanced image quality: because each printed pixel may be composed of multiple droplets, it is possible to control the pixel size, resulting in halftoning capabilities. High-resolution halftoning cuts the speed of continuous ink-jet systems considerably, however.

25.3 Impulse Jet (Drop-On-Demand) Printing

In contrast to continuous jet printers, drop-on-demand ink delivery systems create drops only as needed, thereby eliminating the need to control excess droplets. These systems are inherently binary; either a drop is ejected for placement on the receiver sheet or it is not.

Most of the system complexity of an impulse jet printer is in the printhead because no recycling mechanism is required. Typically, an impulse jet printhead has a pressurized reservoir of ink held directly behind a nozzle or orifice. When activated by electrical pulses, drops of ink are ejected and directed to the page.

There are two basic methods of activating the ink droplets. The earliest impulse jet models used piezoelectric transducers that squeeze the ink chamber or impulse the chamber at one end. Figure 25.2 shows a schematic of the piezoelectric approach. The alternative approach, thermal activation of ink drops, is gaining popularity as a result of developments by Hewlett Packard and Canon. A heater creates a bubble of ink vapor that forces ink drops from the nozzle (Figure 25.3).

Most newer ink-jet printers use impulse jet technologies to address general-purpose printing applications. Advantages include mechanical simplicity, low hardware cost, and simplified logic. However, there are disadvantages as well: drop-on-demand printers are more sensitive to shock and vibration and have

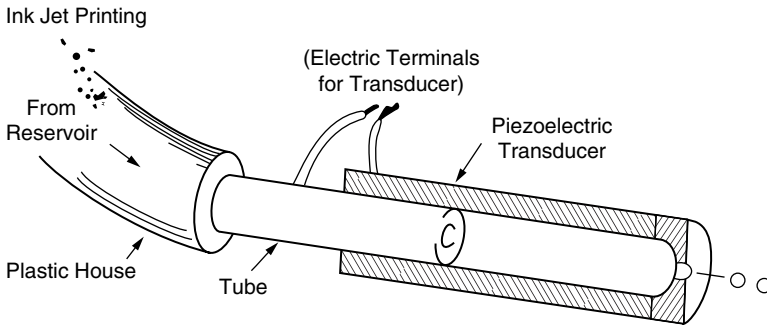

FIGURE 25.2 Piezoelectric impulse jet nozzle. (From Zoltan, S., U.S. Patent 3,683,212.)

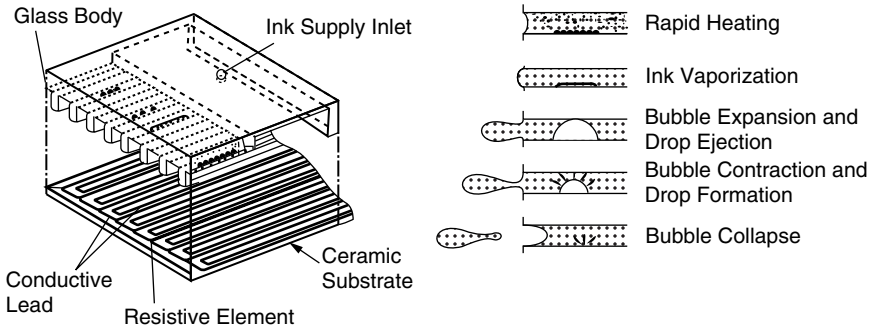

FIGURE 25.3 Thermally activated Canon impulse jet printhead. (From Jaffe, A. B. and Mills, R. N., “Color hardcopy for computer systems,” in *SID Proceedings*, Vol. 24/3, 1983, pp. 219–234.)

slower dot ejection rates (sometimes as low as 3 kHz). In addition, market acceptance has been slow, partly because of early reliability problems due to nozzle clogging from dried ink or paper dust.

25.4 Ink-Jet Inks

Ink-jet printer design requires close matching of mechanical components, imaging inks, and, in many cases, the receiver materials. Ink chemistry is a critical link, determining diverse attributes such as viscosity, drop flight, corrosive properties, surface tension, drying time, dot shape, optical density and edge acuity, fade resistance, and compatibility with printing surfaces.

Traditionally, inks have been liquid, with a water or solvent base. Continuous jet inks are usually based on one of a wide range of solvents, which permit fast drying on both porous and nonporous substrates. Impulse-jet printers require high boiling point inks, usually water based. Several recently commercialized or wax materials are melted for ejection but solidify immediately on the receiver. Proponents claim that solid inks solve print quality problems from undesirable wicking of ink into paper fibers, although at the cost of considerable system complexity and embossed output, which is objectionable to some.

Ink formulation involves a series of trade-offs, depending on type of printing system and the requirements of target applications. For instance, in impulse jet systems, where danger of nozzle clogging exists, inks must not dry within the nozzle; yet once ejected, they must dry fast enough on the paper to minimize feathering in the paper fibers. The difficulty of this undertaking is evident from the fact that few current ink-jet printers offer true plain paper printing; most systems require special clay-coated papers to prevent wicking, and this is a drawback in office environments.

Coloring agents in ink-jet inks also present a challenge. Because pigment particles could make the ink too viscous and might cause clogging or undue wear, dyes are used instead. Resulting problems include lack of optical density (a grayish hue) and archival problems due to a tendency to fade.

The success of ink-jet printing depends on developments that match systems' capabilities to printing requirements. Ink-jet products have been highly successful for years in environments where speed and surface independence have been more important than image quality (e.g., for package coding and direct mail). Recent improvements in reliability, resolution, paper tolerance, and coloring agents could ultimately bring high quality office printing and color applications within reach.

Ink-jet has been among the most challenging output technologies to perfect, with enormous R&D outlays and a long history of failed products. However, recent progress suggests that the allure of ink-jet as a potentially elegant, low cost printing solution will finally be justified.

Bibliography

“Advances in non-impact printing technologies for computer and office applications,” in *Proceedings from the First International Congress on Non-impact Printing*, Venice, June 1981, Joseph Gaynor, Ed. New York: Van Nostrand Reinhold, 1982.

Ink Jet Printing — Its Role in Word Processing and Future Printer Markets. Newtonville, MA: Datek Information Services, August 1988.

Solid Ink Jet Color Imaging Technology. Newtonville, MA: Datek Information Services, August 1988.

26

Electrodeposition of Polymers

26.1	Introduction	26-1
26.2	Advantages	26-1
26.3	History	26-2
26.4	Process.....	26-2
	Throwing Power • Maintaining a Steady State • Rupture Voltage	
26.5	Equipment	26-3
	Conveyors • Metal Preparation • Tank Enclosures • Dip Tanks • Rectifiers • Counterelectrodes • Agitation • Temperature Control • Ultrafilter • Paint Filters • Paint Makeup • Deionized Water • Bake or Cure	
26.6	Laboratory 5	
	References	26-5
	Bibliography	26-6

George E. F. Brewer*

*George E. F. Brewer Coating
Consultants*

26.1 Introduction

The electrodeposition of polymers is an extension of painting techniques into the field of plating and, like plating, is a dip coating process. The art of metal plating utilizes the fact that metal ions, usually Ni^{2+} or Cu^{2+} , can be discharged on the cathode to give well-adhering deposits of metallic nickel, copper, etc. The chemical process of deposition can be described as $1/2 \text{Me}^{2+} + 1F$ (or 96,500 coulombs) of electrons gives $1/2 \text{Me}^0$. In the case of electrodeposition of ionizable polymers, the deposition reaction is described as $\text{R}_3\text{NH}^+\text{OH}^- + 1F \rightarrow \text{R}_3\text{N} + \text{H}_2\text{O}$ or the conversion of water-dispersed, ammonium-type ions into ammonia-type, water-insoluble polymers known as cathodic deposition. Alternatively, a large number of installations utilize the anodic deposition process $\text{RCOO}^- + \text{H}^+ \text{ less } 1F \rightarrow \text{RCOOH}$. It should be mentioned that “R” symbolizes any of the widely used polymers (acrylics, epoxies, alkyds, etc.).

The electrodeposition process is defined as the utilization of “synthetic, water dispersed, electrodepositable macro-ions.”¹

26.2 Advantages

Metal ions, typically $1/2 \text{Ni}^{2+}$, show an electrical equivalent weight $1/2 \text{Ni}^{2+}$ equal to approximately 29.5 g, while the polymeric ions typically used for electrodeposition exhibit a gram equivalent weight (GEW) of approximately 1600. Thus, $1F$ plates out of 30 g of nickel and deposits 1600 g of macroions. If we

* Deceased.

consider the thickness of the deposit, the advantage is even larger because nickel has a specific gravity of 9, whereas pigmented organic coatings have a specific gravity of approximately 1.4.

Another advantage, and probably the reason for the rapid and still continuing industrial growth of the polymeric electrodeposition process, is the formation of uniformly thick coats on all surfaces of a formed workpiece, including such extreme recesses as the insides of car doors. This ability to extend coats into recesses is known as throwing power.

Still another advantage is the extremely small emission of vapors of volatile organic compounds (VOCs), ranking electrodeposition with powder coating and radiation cure as the least polluting coating processes. Finally, the cost of operating an electrocoating tank is lower than that of any other painting method.

26.3 History

The earliest observation of migration in an electrical field was made in Moscow in 1808, by Reuss, who observed colloidal clay in water moving toward the anode. In 1861 Quinke in Berlin referred to migration observations made by Faraday and described the anodic migration of 30 substances in water and cathodic migration in turpentine. The first observation of an electrodeposition was made in London in 1905, by Picton and Linder, who found that ferric hydroxide in the presence of alcohol forms "hornlike" deposits on the cathode.

An electrophoretic separation of toxins and antitoxins was observed by Field and Teague, also in London, in 1907. The use of electrophoresis as an analytical tool culminated in 1948 when Tyselius received a Nobel Prize.

The earliest industrial application for electrophoresis seems to have been made in 1919 when Davis, at General Electric, in Schenectady, New York, received a patent for the electrodeposition of bituminous matter on wires. In 1923 Klein of London received a patent for the electrodeposition of rubber. A number of patents were granted after 1936 to Clayton, at Crosse & Blackwell, London, for the deposition of waxes from emulsions. All of these processes utilized naturally occurring substances, and none of them met with lasting success.

In 1965 Bogart, Burnside, and Brewer reported on the Ford electrocoating system which, by that time, had produced several million automotive wheels, hundreds of complete car bodies, and large numbers of samples of automotive, appliances, and general sample pieces.²

It is currently estimated that 1500 electrodeposition coating lines are in operation in the United States and that another 1500 lines operate overseas.

26.4 Process

Spray painting and dip coating use a carefully prepared and thinned batch of paint in a pot, agitated to ensure uniformity. Then the paint is transferred onto the workpiece until the pot is empty. Opposed to this, electrodeposition essentially transfers only the paint solids onto the workpiece. Thus, after the painting is done, the tank is still full of the aqueous portion of the paint, except for the paint bath increments that have been lifted out. These volumes of bath cannot be rinsed back into the tank by the use of water, because this would cause the tank to overflow. A fraction of the bath is, therefore, passed through an ultrafilter, which retains the paint solids, while the aqueous phase passes through filtration or permeation. The ultrafiltrate is then used to rinse the freshly coated workpieces and returns the lifted paint to the tank. For the same reason, paint of comparatively high concentration is used to replace the coated-out solids. The chemistry of the paint dispersion and deposition can be symbolized by the following equations:

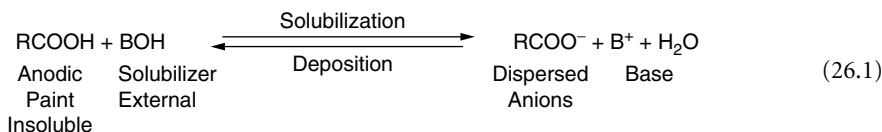

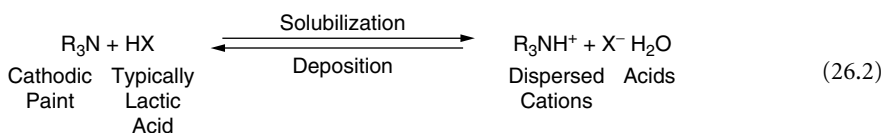

These two processes use bases or acids as external solubilizers, and the equations show that the bulk of the solubilizer stays in the bath. Thus, insufficiently solubilized paint has to be used as feed material, while the bath provides its excess solubilizer to balance the requirement.

A promising invention uses self-solubilizing cathodic materials called sulfonium bases.

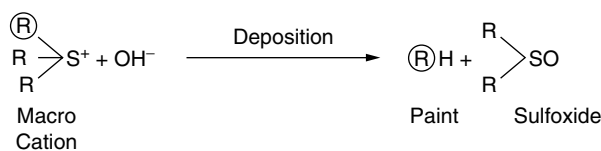

26.4.1 Throwing Power

Throwing power is measured as the depth of deposited paint in a standard cavity formed by test panels and narrow spacers. Indeed, the most important feature of the electrocoating process is the ability to extend durable paint films into extreme recesses, for instance, automobile doors.

While throwing power is a property of the paint, it can be increased through higher applied voltage and higher bath conductivity (which helps transport electricity into recesses), lower coulomb per gram paint requirement (more efficient use of the electricity), larger openings for entrance into a cavity, and a larger perimeter of the opening. In other words, slits are more effective than round holes.

26.4.2 Maintaining a Steady State

Unlike other paint processes, the operation of an electrocoating tank is similar to electroplating in that a balance of incoming and outgoing materials is necessary. Paint solids and evaporated water as well as other incidentally lost materials must be replaced. More precisely, the original tank fill is formulated to give one or more test pieces, meeting all the required solidities. For instance, a certain combination of resin, pigments, solvents, cross-linkers, and other materials gives the required deposited coating. Yet the coating may contain these components in somewhat different proportions. Typically, a tank fill of 70 wt% resin plus 30 wt% pigment may produce a deposited coating of 68 wt% resin plus 32 wt% pigment. If so, the paint replenishment (feed) must be richer in pigment than the original composition (fill). In general terms, the feed must replace all the materials leaving the tank. This is merely an analytical problem, but it can be cumbersome until solved.

26.4.3 Rupture Voltage

Of the factors that increase throwing power, increased voltage is the easiest to apply. There is, however, a limit called rupture voltage. It seems to be a dielectric breakthrough of the forming film and it depends on the surface of the metal being coated. At any rate, when voltages higher than the rupture voltage are applied, blemished (pockmarked) films and lower solidities (which reduce saltspray resistance, etc.) result.

26.5 Equipment

Figure 26.1 represents a typical electrocoating installation.

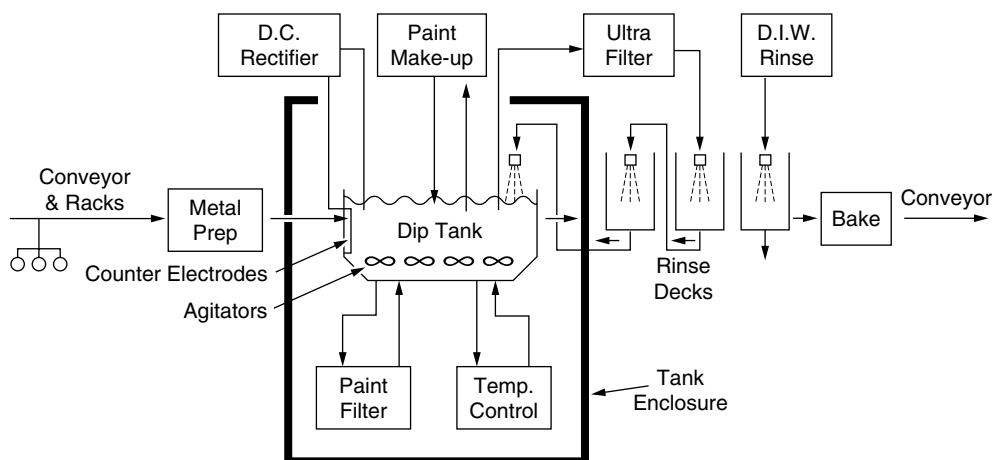

FIGURE 26.1 Schematic diagram of electrodeposition process; D.I.W. = deionized water.

26.5.1 Conveyors

High volume production uses overhead conveyors entering the tank at a 30° angle. To save energy and space, free and power conveyors providing 90° vertical entry sometimes are combined with bulk-coating.

26.5.2 Metal Preparation

Most electrocoating installations use seven- to nine-stage zinc phosphate. Iron phosphate is also widely used. For nonferrous metals, special pretreatments are applied.

26.5.3 Tank Enclosures

Safety is provided by a tank enclosure, which is interlocked with the power source and conveyor. Any entry deenergizes the system.

26.5.4 Dip Tanks

Tanks are operated on a continuous basis (conveyor or coil stock) or batch-type entry, in the latter case using “power and free” conveyors. The workplace is usually completely submerged 15 cm below the surface with 15 cm clearance on all sides. Tanks provide a workplace residence of approximately 3 min, though coating of cans and coils is done in seconds.

26.5.5 Rectifiers

Direct current power sources of less than 5% ripple factor over the full range are employed.

26.5.6 Counterelectrodes

Most electrocoating tanks are lined with an epoxy coat approximately 10 mil thick. In this case, the tank, the conveyor, the merchandise, and so on, are all grounded: only the counterelectrodes, inserted below the surface of the paint, are of opposite (hot) polarity. The inserted electrodes are protected by plastic grates. If it is required to collect the counterions (acid or base groups), then the counterelectrodes are separated from the tank fill by membranes through which counterions pass by a process called electro dialysis. The tank itself can be used as counterelectrode unless separation of counterelectrode fluid is desired.

26.5.7 Agitation

Electrocoating baths of up to 500,000 liter volume contain from 10 to 20 wt% of solids and approximate the viscosity of water. Ejector nozzles and other agitating devices are used to move the entire bath volume in 6 to 30 min to prevent the solids from settling.

The dwell time in the bath is described as “turnover rate.” For instance, the fill of an average tank of 100,000 liter volume contains about 10,000 kg of paint solids. One turnover is reached when 10,000 kg of solids (feed) has been added, which takes from 10 working days up to 10 months depending on the configuration of the merchandise and the production rate. At this time, by the law of probability, much of the original fill material still dwells in the tank. Considerable pumping stability is, therefore, required.

26.5.8 Temperature Control

Most tanks operate between 75 and 95°F. Practically all the required electrical and agitational energy is converted into heat and must be removed by use of chillers.

26.5.9 Ultrafilter

Paint savings and removal of dissolved impurities are accomplished by ultrafiltration, using membranes permeable to water, salts, and substances of less than 300 molecular weight. The ultrafiltrate (permeate) is used for usually three spray rinses and sometimes one dip rinse, followed by a deionized water rinse.

26.5.10 Paint Filters

Filter bags, wound filters, and indexing filters 5 to 50 μm pore size are used.

26.5.11 Paint Makeup

Symbolized in Equations 26.1 and 26.2, paint makeup is actually the last step in the manufacture of water-borne paints and is accomplished by mixing tank contents with all the needed paint components.

26.5.12 Deionized Water

Evaporated or otherwise lost water is replaced by the use of 75,000 $\Omega\text{-cm}$ of water, which is also used as a final rinse.

26.5.13 Bake or Cure

Most electrocoats require a bake of 20 min at 350°F. However, lower baking materials are available; even ambient temperature curing materials are on the market.

26.6 Laboratory

The tank control is carried out in about 3 h/day by a technician, using the procedures found in the ASTM *Paint Testing Manual*.¹

References

1. G. E. F. Brewer and A. D. Hamilton, “Paint for electrocoating,” ASTM Gardner-Sward *Paint Testing Manual*, 13th ed. Philadelphia: American Society for Testing and Materials; 1972, Section 8.10, pp. 486–489.
2. SAE J., 81–83 (August 1965).

Bibliography

- Brewer, G. E. F., Ed., *Electrodeposition of Coatings*, ACS Advances in Chemistry Series, Vol. 119. Washington, DC: American Chemical Society, 1973.
- Brewer, G. E. F., Chairman, "ACS Symposium on newer developments in electrocoating." *Org. Coatings Plast. Chem.*, 45, 1-22, 92-113 (August 1981).
- Chandler, R. H., "Advances in electrophoretic painting," *Bi- or Triannual Abstracts*. Braintree, Essex, England: R. H. Chandler, since 1966.
- Duffy, J. I., Ed., *Electrodeposition Processes and Equipment*. Park Ridge, NJ: Noyes Data Corp., 1982.
- Kardomenos, P. I., and J. D. Nordstrom, "Polymer compositions for cathodic electrodeposition coatings," *J. Coating Technol.*, 54(686), 33-41 (March 1982).
- Machu, W., *Handbook of Electropainting Technology*. Ayr, Scotland: Electrochemical Publications, Ltd., 1978.
- Raney, M. W., *Electrodeposition and Radiation Curing of Coatings*. Park Ridge, NJ: Noyes Data Corp., 1970.
- Robinson, T., organizer of "Electrocoat" Conferences (even years, since 1982), Products Finishing, Cincinnati, OH.
- Yeates, R. L., *Electropainting*. Teddington, England: Robert Draper Ltd., 1970.

27

Electroless Plating

27.1	Introduction	27-1
27.2	Plating Systems	27-2
27.3	Electroless Plating Solutions.....	27-3
	Deposition Rate • Solution Life • Reducing Agent Efficiency Factor • Solution Sensitivity to Activation	
27.4	Practical Applications.....	27-4
27.5	Mechanisms of Autocatalytic Metal Ion Reduction	27-5
27.6	Stability of Plating Solutions.....	27-7
27.7	Electroless Plating.....	27-7
	Copper Deposition • Nickel Plating • Cobalt, Iron, and Tin Plating • Deposition of Precious Metals • Deposition of Metal Alloys	
27.8	Properties of Chemically Deposited Metal Coatings....	27-10
	References	27-11

A. Vakelis

Lithuanian Academy of Sciences

27.1 Introduction

In electroless plating, metallic coatings are formed as a result of a chemical reaction between the reducing agent present in the solution and metal ions. The metallic phase that appears in such reactions may be obtained either in the bulk of the solution or as a precipitate in the form of a film on a solid surface. Localization of the chemical process on a particular surface requires that the surface must serve as a catalyst. If the catalyst is a reduction product (metal) itself, autocatalysis is ensured, and in this case, it is possible to deposit a coating, in principle, of unlimited thickness. Such autocatalytic reactions constitute the essence of practical processes of electroless plating. For this reason, these plating processes are sometimes called autocatalytic.

Electroless plating may include metal plating techniques in which the metal is obtained as a result of the decomposition reaction of a particular compound; for example, aluminum coatings are deposited during decomposition of complex aluminum hydrides in organic solvents. However, such methods are rare, and their practical significance is not great.

In a wider sense, electroless plating also includes other metal deposition processes from solutions in which an external electrical current is not used, such as immersion, and contact plating methods in which another more negative (active) metal is used as a reducing agent. However, such methods have a limited application; they are not suitable for metallization of dielectric materials, and the reactions taking place are not catalytic. Therefore, they usually are not classified as electroless plating.

Electroless plating now is widely used in modifying the surface of various materials, such as nonconductors, semiconductors, and metals. Among the methods of applying metallic coatings, it is exceeded in volume only by electroplating techniques, and it is almost equal to vacuum metallization.

Electroless plating methods have some advantages over similar electrochemical methods. These are as follows:

1. Coatings may be deposited on electrically nonconductive materials (on almost any surface that is stable in electroless plating solutions).
2. Coatings have more uniform thickness, irrespective of the shape of the product to be plated.
3. Deposition is simple — it is enough to immerse the (pretreated) product in the electroless plating solution.
4. It is possible to obtain coatings that have unique mechanical, magnetic, and chemical properties.

Application of electroless plating, in comparison with electroplating techniques, is limited by two factors: (a) it is more expensive because the reducing agent costs more than an equivalent amount of electricity, and (b) it is less intensive because the metal deposition rate is limited by metal ion reduction in the bulk of the solution.

27.2 Plating Systems

To ensure chemical reduction of metal ions in a solution, the solution must contain a sufficiently strong and active reducing agent; that is, it must have a sufficiently negative redox potential. The more easily the metal ions are reduced, the greater is the number of available reducing agents. Because only auto-catalytic reduction reactions may be used successfully for deposition of coatings, the number of electroless plating Me-Red (metal-reducing agent) systems suitable for practice is not great (see Table 27.1).

Currently known electroless plating methods may be used to deposit 12 different metals, including metals belonging to the groups of iron, copper, and platinum (the well-known catalysts of various reactions) as well as tin and lead (only one solution has been published for deposition of the latter). Although deposition of chromium and cadmium coatings is described in the patent literature, autocatalytic reduction is not realized in these cases. Coatings are deposited on some metals by immersion plating only.

In some widely used processes, the deposition of metal is accompanied by precipitation of the reducing agent decomposition products — phosphorus and boron — and so, the respective alloys are obtained. It is not difficult to deposit two or more metals at a time; electroless plating methods are known for deposition of more than 50 alloys of different qualitative composition, mostly based on nickel, cobalt, and copper.

The majority of reducing agents used in electroless plating are hydrogen compounds, in which H is linked to phosphorus, nitrogen, and carbon. It is in the reactions of these compounds that significant catalytic effects are possible because in the absence of catalysts, these reactions proceed slowly.

The most effective autocatalysis is obtained when the strongest reducer — hypophosphite — is used. In the absence of catalysts, the reducer is inert and does not react even with the strong oxidants; only a

TABLE 27.1 Coatings Obtained by Electroless Plating

Metal	Reducing Agent						Others
	H ₂ PO ₂ ⁻	N ₂ H ₄	CH ₂ O	BH ₄ ⁻	RBH ₃	Me ions	
Ni	Ni-P	Ni		Ni-B	Ni-B		
Co	Co-P	Co	Co	Co-B	Co-B		
Fe				Fe-B			
Cu	Cu	Cu	Cu	Cu	Cu	Cu	
Ag		Ag	Ag	Ag	Ag	Ag	Ag
Au		Au	Au	Au	Au		Au
Pd	Pd-P	Pd	Pd	Pd-B	Pd-B		
Rh		Rh					Rh
Ru				Ru			
Pt		Pt		Pt			Pt
Sn						Sn	
Pb			Pb				

few catalysts are suitable for it (e.g., Ni, Co, and Pd), but they provide for a catalytic process of the highest rate without reduction in the bulk of a solution. Other reducers are more versatile, for example, by using borohydride, we may deposit coatings of almost all the metals mentioned. The reducing capacity of hydrogen compounds increases with an increase in pH of a solution. For this reason, the majority of electroless plating solutions are alkaline.

Such simple reducing agents as metal ions of variable valences (Fe^{2+} , Cr^{2+} , and Ti^{3+}) usually are not suitable for deposition of coatings, because noncatalytic reduction occurs rather easily. Recently, conditions have been established for autocatalytic deposition of tin and silver coatings using as reducing agents such metal complexes as $\text{Sn}(\text{OH})_4^{2-}$ and $\text{Co}(\text{NH}_3)_6^{2-}$.

Depositions of some metals (Ag, Au, Cu) by chemical reduction techniques was known as long ago as the 19th century, but it became popular after Brenner found (in 1945) a very efficient electroless nickel plating process using hypophosphite.¹ It was then that the term “electroless plating” was coined.

27.3 Electroless Plating Solutions

The electroless plating solutions used in practice, in addition to the basic components (the salt of the metal to be deposited and a reducing agent), contain other substances as well. Usually, these are as follows:

1. Ligands, which form soluble complexes with metal ions, are necessary for alkaline solutions. Also, the use of stable complexes sometimes enhances the autocatalytic effect.
2. Substances controlling and maintaining a certain pH value of the solution are used: buffer additions are especially important, because in the course of metal reduction, hydrogen ions are formed.
3. Stabilizers that decelerate reduction reaction in the bulk of a solution and, hence, enhance autocatalysis can be used.

Sometimes, agents such as brighteners are also added to the solution.

The basic technological parameters of electroless plating solutions are discussed in Sections 27.3.1 through 27.3.4.

27.3.1 Deposition Rate

Deposition rate usually is expressed in micrometers per hour ($\mu\text{m}/\text{h}$; or mil/h , $\mu\text{in.}/\text{h}$, $\text{mg}/\text{cm}^2\text{h}$). In the course of deposition, if the concentrations of reacting substances are not maintained at a constant level, this rate decreases. The values given in the literature are often averages, reflecting only the initial period. Such average rates depend on the ratio of the surface to be plated to the solution volume (dm^2/l).

The dependence of the deposition rate (ν) on the concentration of reacting substances for a general case is rather complicated. It is often described by empirical equations, for example:

$$\nu = k[\text{Me}^{n+}]^a[\text{Red}]^b[\text{H}^+]^c[L]^d \quad (27.1)$$

where k is the rate constant (a constant value for a system of the given type), and $[L]$ is the concentration of a free ligand (not bound with metal ions in a complex). The exponents a and b are usually smaller than unity, which c is a negative value (in alkaline solutions OH^- -ion concentration is used, and in such a case, the exponent is often positive, $0 < c < 1$). Exponent d is usually close to zero; when the ligand is substituted, however, the deposition rate may change substantially. With constant concentrations of other solution components, the deposition rate decreases when the stability of a metal complex increases (when the concentration of free metal ions is lowered); however, this relationship for a general case is not rigorous.

The electroless deposition rate of most metals under suitable conditions is about 2 to 5 $\mu\text{m}/\text{h}$, and only electroless nickel plating rate may be as high as 20 $\mu\text{m}/\text{h}$ (this corresponds to an electroplating process at current densities of 200 A/m^2).

27.3.2 Solution Life

Solution life represents the maximum duration of solution usefulness. The beginning of metal ion reduction in the bulk of a solution may terminate its exploitation. In most modern electroless plating solutions, however, the reduction in the bulk usually does not occur under normal operating conditions, and the solution life is limited by the accumulation of reaction products or impurities. Thus, it is better to characterize the life of a solution not by time, which depends on the intensity of exploitation, but rather by the maximum amount of metal deposited from a volume unit of the solution (g/l or $\mu\text{m}/\text{l}$) or by turnover number showing how many times the initial amount of metal in the solution may be deposited in the form of a coating. This number may be as big as 10 to 20. After removal of undesirable substances accumulated in the solution, it may be used longer, just like electrolytes for electroplating.

After protracted exploitation of solutions, a certain amount of sediment may appear, as the bulk reaction may proceed on a limited scale even in fully stable solution.

27.3.3 Reducing Agent Efficiency Factor

The amount of reducing agent (in moles or grams) that is consumed for deposition of a mole or gram of coating is indicated by the reducing agent efficiency factors. The required amount (according to the reduction reaction) of a reducing agent, which is equal, for example, to 2 moles for 1 mole of metal (nickel ion reduction by hyposphosphite or copper ion reduction by formaldehyde) is exceeded in real electroless plating processes as a result of the side reactions taking place.

27.3.4 Solution Sensitivity to Activation

The minimum amount of catalyst that must be present on the dielectric surface to initiate a reduction reaction is shown by the solution sensitivity to activation. This parameter is related to solution stability. The lower the stability of a solution, the easier is the initiation of a reaction, even on surfaces with low catalytic activity. A high sensitivity of a solution to activation is not always desirable because metal from such solutions may be deposited even on surfaces that had not been activated; in such cases, selective plating becomes impossible. When palladium compounds are used for activation, there should be no less than 0.01 and 0.03 to 0.05 μg of lead per square centimeter of a dielectric surface for nickel and copper plating, respectively. When silver is used as an activator, which is suitable only for some electroless copper plating solutions, it is necessary to have about 0.4 μg of silver per square centimeter.

27.4 Practical Applications²⁻⁴

The applications of chemically deposited coatings may be divided into two groups. For decorative metallization of plastics, a thin (0.3 to 1.0 μm) layer of metal is chemically deposited on a dielectric surface, and its thickness is then increased by electroplating techniques. In this case, the properties of chemically deposited coatings and the nature of the metal are not of great significance; it is important only to ensure compactness and sufficient electrical conductivity of such coatings for subsequent electroplating and for providing the required adhesion of the metal layer. The metal for the chemically deposited underlayer is selected for process convenience and cost. For this purpose, nickel and copper coatings are used. Nickel is more convenient, since electroless nickel plating solutions are more stable and their compositions simpler than those of similar electroless copper plating solutions.

The adhesion of a coating to the nonconducting surface is essentially determined by the state of the surface, while the nature of the metal (at least for nickel and copper) usually has only a slight effect on adhesion. Copper coatings might be preferred because of their higher electrical conductivity. A copper underlayer is almost always used in the production of printed circuit boards.

Chemically deposited finished coatings, on the other hand, are thicker, and their use is determined by their mechanical, electrical, and magnetic properties. The most popular are nickel (Ni-P and Ni-B) coatings deposited on metal products. Copper coatings 20 to 30 μm thick, deposited on plastics, exhibit

good electrical conductivity and ductility and, therefore, are used in the production of printed circuit boards by additive processes. The entire circuit pattern is obtained by electroless techniques.

Coatings of cobalt and its alloys may be used to take advantage of their specific magnetic properties; silver and gold coatings are used because of their good electrical conductivity, optical properties, and inertness.

Electroless plating may be performed by using the plating solution once (until a greater part of any component in the solution is consumed and the reaction rate has sharply decreased) or by replenishing the substances that have been consumed in the course of plating. Long-term exploitation of solutions reduces the amount of plating wastes and ensures a higher labor productivity, but at the same time, it imposes more stringent requirements on plating solutions: they must be stable, and their parameters should not vary significantly with time. Besides, special equipment is required for monitoring and controlling the composition of such solutions. For this reason, long-term exploitation of solutions is applied only in large-scale production processes.

Single-use solutions are more versatile, but they are less economical and less efficient. A single-use method may be applied rather efficiently, however, when the solution has a simple composition and the basic components (first of all, metal ions) are fully consumed in the plating process, while the remaining components (such as ligands) are inexpensive and do not pollute the environment. In this case, single-use processes may be practically acceptable even in mass production.

An extreme case of single use of plating solutions is aerosol spray plating,⁵ in which droplets of two solutions begin sprayed by a special gun collide on, or close to, the surface being plated. One solution usually contains metal ions, while the other contains the reducing agent. Metal ion reduction in this case should be rapid enough to permit a greater part of the metal to precipitate on the surface before the solution film runs off it. This method is practical for deposition of such easily reducible metals as silver and gold, though such aerosol solutions are known for deposition of copper and nickel as well. The aerosol spray method is highly suitable for deposition of thin coatings on large, flat surfaces: this process is similar to spray painting.

Since the components of electroless plating solutions, first of all metal ions, may be toxic and pollute the environment, techniques have been developed for recovery of metals from spent plating solutions and rinse water. Other valuable solution components, such as ligands (EDTA, tartrate), may also be recovered.

Electroless plating usually does not require sophisticated equipment. The tank for keeping plating solutions must exhibit sufficient chemical inertness, and its lining should not catalyze deposition of metals. Such tanks are usually made of chemically stable plastics; metal tanks may be used as well — they can be made of stainless steel or titanium. To prevent possible deposition of metals on the walls, a sufficiently positive potential is applied to them using a special current source (anodic protection). Parts for plating may be mounted on racks; small parts may be placed in barrels immersed in the plating bath. Heating and filtration of solutions are carried out in the same way as in electroplating processes. Special automatic devices have been developed for monitoring and controlling the composition of plating solutions.

27.5 Mechanisms of Autocatalytic Metal Ion Reduction

Autocatalytic metal ion reduction processes are highly complex: they contain many stages, and their mechanism is not understood in detail. At present, it is possible to give an accurate description only of the basic stages of the catalytic process. Localization of the reduction reaction on the metal–catalyst surface (the cause of catalysis) is usually attributed to the requirement for a catalytic surface for one or more stages of the process to proceed. In accordance with one of the earlier explanations, only on a catalytic surface is an active intermediate product obtained, which then reduces metal ions. First, atomic hydrogen and, later, a negative hydrogen ionhydride were considered to be such products. A reaction scheme with an intermediate hydride gives a good explanation of the relationships observed in nickel and copper plating processes.⁵ However, there is no direct proof that hydride ions are really formed during these processes. Moreover, the hydride theory explains only the reactions with strong hydrogen-containing reducers, which really may be H⁻ donors.

A more versatile explanation of the causes of catalysis in these processes is based on electrochemical reactions. It is suggested that reducing agents are anodically oxidized on the catalyst surface and the electrons obtained are transferred to metal ions, which are cathodically reduced. The catalytic process comprises two simultaneous and mutually compensating electrochemical reactions. In this explanation of the catalytic process, electrons are the active intermediate product. However, electrons are fundamentally different from the conversational intermediate products of reactions. They may be easily transferred along the catalyst without transfer of the mass, and for this reason, the catalyst reaction, contrary to all other possible mechanisms (which are conventionally called “chemical mechanisms”), occurs not as a result of direct contact between the reactants, or the reactants, or the reactant and an intermediate substance, but because of the exchange of “anonymous” electrons via metal.

On the metal surface, when anodic oxidation of the reducer



and cathodic reduction of metal ions



proceed simultaneously, a steady state in the catalytic system of electroless plating is obtained, in which the rates of both electrochemical reactions are equal, while the metal catalyst acquires a mixed potential E_m . The magnitude of this potential is between the equilibrium potentials E_c of the reducer and of the metal. The specific value E_m depends on the kinetic parameters of these two electrochemical reactions.

Electrochemical studies of catalytic metal deposition reactions have shown that the electrochemical mechanism is realized practically in all the systems of electroless plating.^{4,6,7}

At the same time, it has become clear that the process is often not so simple. It appears that anodic and cathodic reactions occurring simultaneously often do not remain kinetically independent but affect each other. For example, copper ion reduction increases along with anodic oxidation of formaldehyde.⁸ The cathodic reduction of nickel ions and the anodic oxidation of hypophosphite in electroless nickel plating solutions are faster than in the case in which these electrochemical reactions occur separately. This interaction of electrochemical reactions probably is related to the changes in the state of the metal–catalyst surface.

Electrochemical reactions may also hinder each other: for example, in reducing silver ions by hydrazine from cyanide solutions, their rate is lower than in separate Ag–Ag(1) and redox systems.

The electrochemical nature of most of the autocatalytic processes discussed enables us to apply electrochemical methods to their investigation. But, they must be applied to the entire system of electroless plating, without separating the anodic and cathodic processes in space. One suitable method is based on the measurement of polarization resistance. It can provide information on the mechanism of the process and may be used for measuring the metal deposition rate (both in laboratory and in industry).⁹ The polarization resistance R_p is inversely proportional to the process rate i :

$$i = \frac{b_a b_c}{R_p (b_a + b_c)} \quad (27.4)$$

$$R_p = \left(\frac{dE}{di} \right)_{i=0} \quad (27.5)$$

where b_a and b_c are Tafel equation coefficients ($b \approx 1/\alpha n f$), α is the transfer coefficient, n is the number of electrons taking part in the reaction for one molecule of reactant, and $f = F/RT$ ($F = \text{Faraday number}$).

Autocatalytic metal reduction reactions also may not proceed in an electrochemical manner. Two courses of such reactions have been shown: (a) an intermediate metal hydride is formed, which decomposes to metal and hydrogen (reduction of copper ions by borohydride); and (b) the metal complex is hydrolyzed, resulting in precipitation of metal oxide on the surface, which then is reduced to metal by the reducer present in the solution (reduction of silver ions by tartrate).

27.6 Stability of Plating Solutions

Electroless plating solutions containing metal ions and reducing agents are thermodynamically unstable systems. Metal ion reduction must proceed in the bulk of the solution.

The difference in the rate of metal ion reduction on the required surface (controlled catalytic reaction) and that of a reduction reaction in the bulk of a solution shows the effect of catalysis, and it determines, to a substantial degree, the practical usefulness of plating solutions. In an ideal case, the reaction in the bulk of a solution should not occur at all.

Formation of metal in the bulk of a solution is hindered by energy barriers: the activation barrier of homogenous reactions between metal ions and reducer and the barrier of the formation of a new phase (metal). The magnitude of the second barrier may be evaluated on the basis of thermodynamic principles.¹⁰

It was established empirically that the stability of plating solutions decreases with an increase in the concentration of reactants and temperature, with a decrease in the stability of metal ion complexes, and with the presence of solid foreign particles in the solution. Besides, it was found that stability decreases as the catalytic process rate and load increase. This may be attributed to the transfer of intermediate catalytic reaction products from the catalytic surface to the solution, where they may initiate a reduction reaction. To enhance the stability of solutions, it is recommended that lower concentration solutions and more stable metal complexes be used and that solid particles in the solution be removed by filtration. The most effective solution stabilization method is the introduction of special addition agents — that is, stabilizers.^{4,11} Stabilizers, the number of which is very great, may be divided into two large groups: (a) catalytic poisons, such as S(II), Se(II) compounds, cyanides, heterocyclic compounds with nitrogen and sulfur, and some metal ions, and (b) oxidizers. It is assumed that stabilizers hinder the growth of fine metal particles, close to critical ones, by absorbing on them (catalytic poison) or passivating them (oxidizers).

Modern electroless plating solutions always contain stabilizers. Their concentration may be within the range of 1 to 100 mg/l. Stabilizers, by hindering deposition of metal on fine particles, usually slow the rate of the catalytic process on the surface being plated. This process may stop completely at a sufficiently high concentration of the stabilizers. In some cases, however, small amounts of stabilizers increase the deposition rate.

27.7 Electroless Plating

27.7.1 Copper Deposition

Though copper coatings may be deposited using various reducers, only formaldehyde copper plating solutions are of practical importance. Autocatalytic reduction of copper ions by formaldehyde proceeds at room temperature in alkaline solutions (pH = 11–14); here, copper ions must be bound into a complex. Suitable Cu²⁺ ligands for electroless copper plating solutions are polyhydroxy compounds (polyhydroxy alcohols, hydroxyacid anions) and compounds having a tertiary amine group and hydroxy groups (hydroxyamines, EDTA, and others). In practice, tartrate, EDTA, and tetraoxypropylethyl ethylenediamine (Quadrol) are used most often.

In the course of copper plating, along with the main reduction reaction,

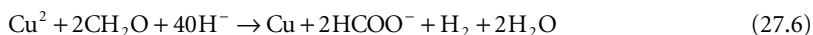
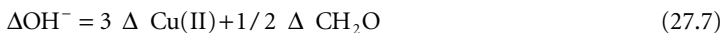

TABLE 27.2 Examples of Electroless Copper Plating Solutions

Components (g/l) and Parameters	Solutions		
	A	B	C
CuSO ₄ · 5H ₂ O	7	15	15
K-Na tartrate	25		
Na ₂ EDTA		30	45
NaOH	4.5	10	10
Formaldehyde (40%) ml/l	25	20	10
Additives ^a	2	1–0.005	1–0.03
		2–0.03	2–0.05
pH	12.2–12.5	12.7	12.6
Temperature, °C	20	20	70
Deposition rate μm/h	0.4–0.5	2	3

^a Solution A: NiCl₂ · 6H₂O; solution B: sodium diethyldithiocarbamate, K₄Fe(CN)₆; solution C: 2,2'-dipyridyl, polyethylene glycol (MW = 600).

formaldehyde is consumed in the Cannizzaro reaction, and a total of 3 to 6 moles of CH₂O is consumed for the deposition of 1 mole of copper. During copper plating, much alkali is used including the Cannizzaro reaction. Consumption of OH⁻ may be determined according to the following equation (amounts of substances in moles):



Various formulations of copper plating solutions, which are totally stable and suitable for long exploitation (e.g., solution B in Table 27.2), have been developed. Three types of electroless copper plating solution have been distinguished in the literature: (a) low deposition rate solutions (0.5 to 1.0 μm/h), suitable for deposition of a copper underlayer; (b) solutions giving deposition rates of 4 to 5 μm/h (i.e., exhibiting a higher autocatalytic effect); and (c) solutions for deposition of highly ductile and strong copper coats (e.g., solution C in Table 27.2). All these solutions, essentially, have the same composition: they differ mostly by their additives. Besides, highly ductile coatings, which are used in the production of printed circuit boards by additives processes, are obtained at higher temperatures (>40°C) and at a relatively low copper deposition rate.

27.7.2 Nickel Plating

Electroless nickel plating, in which hypophosphite is used as a reducer, is the most popular process.^{12,13} Autocatalytic nickel ion reduction by hypophosphite occurs both in acid and in alkaline solutions. In a stable solution with a high coating quality, the deposition rate may be as high as 20 to 25 μm/h. This requires, however, a relatively high temperature, about 90°C. Because hydrogen ions are formed in the reduction reaction,



a high buffering capacity of the solution is necessary to ensure a steady-state process. For this reason, acetate, citrate, propionate, glycolate, lactate, or aminoacetate is added to the solutions; these substances, along with buffering, may form complexes with nickel ions. Binding Ni²⁺ ions into a complex is required in alkaline solutions (here, besides citrate and aminoacetate, ammonia and pyrophosphate may be added); moreover, such binding is desirable in acid solutions, because free nickel ions form a compound with the reaction product (i.e., phosphate), which precipitates and hinders further use of the solution.

TABLE 27.3 Examples of Electroless Nickel Plating Solutions

Components (g/l) and Parameters	Solutions		
	A	B	C
NiCl ₂ ·6H ₂ O	30	30	25
NaH ₂ PO ₂ ·H ₂ O	10	20	30–40
Sodium acetate	8		
NH ₄ Cl			30
NH ₄ OH (25%), ml/l			30–35
Glycine		20	
NaNO ₂			0.02–0.1
pH	5	6	9
Temperature, °C	90	80–90	30
Nickel deposition rate μm/h	15	7–15	1.8

Stabilizing additions for nickel plating solutions are less necessary than for copper solutions; nevertheless, they are added to ensure the stability of long-lived solutions.

Phosphorus is always present in the coatings when reduction is performed by hypophosphite. Its amount (in the range of 2 to 15 mass percent) depends on pH, buffering capacity, ligands, and other parameters of electroless solutions.

Borohydride and its derivatives may also be used as reducers for electroless nickel plating solutions. While temperatures of 60 to 90°C are required for the reduction of nickel ions by borohydride, dimethylaminoborane (DMAB) enables the deposition of Ni–B coatings with a small amount of boron (0.5 to 1.0 mass percent) at temperatures in the range of 30 to 40°C. Neutral and alkaline solutions may be used, and their compositions are similar to those of hypophosphite solutions (Table 27.3).

27.7.3 Cobalt, Iron, and Tin Plating

Deposition of cobalt is similar to that of nickel — the same reducers (hypophosphite, borohydride, and its derivatives) are used, and reduction relationships are similar.¹⁴ Reduction of cobalt is more difficult, however, and cobalt deposition rates are lower than those of nickel; it should be noted that it is difficult to deposit cobalt from acid solutions. The Co–P and Co–B coatings obtained are of particular interest due to their magnetic properties.

Electroless iron plating is more difficult, and only one sufficiently effective iron plating solution is known, in which Fe ions form a complex with tartrate and NaBH₄ is used as a reducer. Fe–B coatings (about 6% B) are obtained in an alkaline solution (pH 12) at a temperature of 40°C and a deposition rate of about 2 μm/h.

It is rather difficult to realize an autocatalytic tin deposition process. A sufficiently effective tin deposition method is based on the tin (II) disproportionation reaction in an alkaline medium.¹⁵ In 1 to 5M NaOH solutions at 80 to 90°C, it is possible to obtain a deposition rate of a few micrometers per hour.

27.7.4 Deposition of Precious Metals

Electroless silver plating is the oldest electroless metallization process; its present performance however, lags behind nickel or copper plating.¹ Unstable single-use ammonia silver plating solutions (with glucose, tartrate, formaldehyde, etc., as reducers) are usually employed. The thickness of coatings from such solutions is not great (<1 μm). Such unstable solutions are more suitable for aerosol spray.

More effective electroless silver plating solutions have been developed using cyanide Ag(I) complex and aminoboranes or hydrazine as reducers: at temperatures of 40 to 50°C, the deposition rate is 3 to 4 μm/h, and in the presence of stabilizers, these solutions are quite stable. Sufficiently stable electroless silver plating solutions may be obtained using metal ions such as Co(II) compounds as reducers.

Gold coatings may be deposited employing various reducers: however, the solutions are usually unstable. Solutions of sufficient stability have been developed with borohydride or DMAB as reducers using a stable gold cyanide complex.¹⁶ At temperatures of 70 to 80°C, the fold deposition rate reaches 5 Am/h, and gold coatings of sufficient purity are obtained.

Thin gold coatings may be deposited on plastics by an aerosol spray method: gold complexes with amines are employed with hydrazine as a reducer, and a relatively thick coat (deposition rate as high as 0.4 μm/min) may be obtained.

Palladium coatings are easily deposited with hypophosphite as a reducer in alkaline solutions, in which Pd²⁺ ions are bound in a complex with ammonia, EDTA, or ethylenediamine. Palladium plating is performed at 40 to 50°C, the deposition rate of the Pd-P (4 to 8 P) coat being in the range of 2 to 5 μm/h.

Coatings of platinum, ruthenium, and rhodium may be deposited using borohydride or hydrazine as a reducing agent. The process rate in a stable solution is low (0.5 to 2 μm/h).

27.7.5 Deposition of Metal Alloys

About 60 coatings of a different qualitative composition containing two or more metals may be deposited. Such metals as copper, iron, zinc, tin, rhenium, tungsten, molybdenum, manganese, thallium, and platinum group metals may be introduced into nickel and cobalt coats, and nickel, cobalt, tin, zinc, cadmium, antimony, bismuth, lead, and gold into copper coats.

In the electroless deposition of metal alloys, the same thermodynamic relationships as those of alloy deposition by electroplating techniques are valid; it is clear that it is difficult to introduce into coatings metals that are difficult to reduce, such as chromium and manganese. Besides, in the case of chemical reduction, an additional factor — catalytic properties of metals — becomes apparent. Great amounts of additional metal may be introduced into a coat of nickel, copper, and so on, only when that metal is catalytic or, at least, inert with respect to oxidation of the reducer. The amount of metals–catalysts in the alloy may be as high as 100%, that of catalytically inert metals may be up to 50%, and that of metals–inhibitors may be only 10 to 20%. When a less catalytically active metal is introduced, the deposition rate decreased.

27.8 Properties of Chemically Deposited Metal Coatings

Only in rare cases are chemically deposited metal coatings so pure, and have so regular a structure, that their properties are the same as those of the corresponding chemically pure substance. Very different properties may be exhibited by coatings containing a nonmetallic component — phosphorus or boron.

The density of coatings is a little lower than that of bulk metal. This is related to a rather irregular coatings structure: they contain more defects (pores and inclusions of foreign matter). For example, chemically deposited copper usually has a great number of microscopic voids 20 to 300 Å in diameter, formed by the hydrogen occluded in the coating. Ni-P and Ni-B coatings usually have a layered structure, which results from the nonuniform distribution of phosphorus and boron in the coatings.

Mechanical properties of the coatings may vary within a wide range depending on the electroless plating conditions, plating solutions composition, and deposition rate.

For chemically deposited finish copper coatings, such as those on printed circuit boards, sufficient resistance and ductility are of great importance. Coatings that have a tensile strength of about 40 to 50 kg/mm² may be obtained at a temperature of 50 to 70°C. Their ultimate elongation, which characterizes ductility, may be as high as 6 to 8%. Copper coatings obtained at room temperature are more brittle. Highly ductile coatings may be obtained only from solutions containing special additives. Ductility increases when deposited coatings are heated in an inert atmosphere at temperatures of 300 to 500°C.

Ni-P and Ni-B coatings are relatively hard; after deposition, their hardness, which depends on the amount of P and B, is 350 to 600 kg/mm² (3400 to 5900 MPa) of Ni-P coatings and 500 to 750 kg/mm² (4900 to 7400 MPa) for Ni-B coatings, while after heating at about 400°C, it is 800 to 1000 kg/mm² for

Ni-P and 1000 to 1250 kg/mm² for Ni-B. Hence, such coatings have the same hardness as that of chromium coatings. The tensile strength of Ni-P coatings is in the range of 40 to 80 kg/mm².

The ductility of nickel coatings, if their hardness is taken into account, is rather high: their ultimate elongation is less than 2%. Such a combination of hardness, wear resistance, and ductility is unique.

The electrical conductivity of chemically deposited coatings is usually lower than of the respective pure metals. Resistivity of thin copper coatings (0.5 to 1.0 μm) deposited at room temperature is $3 \text{ to } 4 \times 1.0^{-8} \Omega\text{-m}$ — twice as great as that of pure bulky copper. The surface resistance of such coatings is 0.03 to 0.07 Ω/m. However, ductile copper coatings that are obtained at temperatures of 50 to 70°C have a resistivity of $2 \times 10^{-8} \Omega\text{-m}$, close to that of pure copper.

The resistivity of Ni-P and Ni-B coatings depends on the amount of nonmetallic component, and it is usually in the range from $3 \text{ to } 9 \times 10^{-7} \Omega\text{-m}$; that is much higher than that of pure bulky nickel ($0.69 \times 10^{-7} \Omega\text{-m}$). Heating causes reduction in resistivity.

Magnetic properties of the coatings of such ferromagnetic materials as nickel and cobalt may vary within a very wide range. With an increase in the amount of phosphorus in nickel coatings, their ferromagnetism decreases, and coatings containing more than 8 mass percent of phosphorus or 6.5 mass percent of boron are nonmagnetic.

Coatings of Co-P, Co-B, and cobalt alloys with other metals have highly different magnetic properties. These depend on the composition of the coating, their structures, and their thicknesses, and they may be controlled by changing the composition, pH, and temperature of electroless plating solutions. Usually, cobalt coatings exhibit a high coercivity (15 to 80 kA/m); however, soft magnetic coatings (0.1 to 1.0 kA/m) may be deposited as well.

Optical properties of coatings are less varied and do not differ so much from those of pure metals. Chemically deposited coatings are usually dull; when special additives are introduced, bright coatings are obtained. Since they are not used as finish decorative coatings, properties of appearance and brightness usually are not essential.

Silver and gold coatings are often used as mirrors, but the light-reflecting surface is usually the inner surface, which is adjacent to the smooth glass surface. Chemically deposited thin gold films are employed as optical filters; they pass visible light but reflect infrared rays and radio waves.

Chemically deposited coatings are usually less porous than the respective electroplates; therefore, they provide better protection of the basis metal against corrosion. Corrosion resistance of the coatings themselves may be different depending on structure and composition. Ni-P and Ni-B coatings are more resistant to corrosion than nickel electroplates; this may be due to their fine crystalline structure.

References

1. A. Brenner and G. Riddell, *J. Res. Natl. Bur. Stand.*, 37, 31 (1946).
2. W. Goldie, *Metallic Coating of Plastics*. Hatch End, Middlesex, England: Electrochemical Publications Ltd., Vol. 1, 1968; Vol. 2, 1969.
3. F. Pearlstein, "Electroless plating," in *Modern Electroplating*, 3rd ed., F. A. Lowenheim, Ed. New York: Wiley, 1974, p. 710.
4. M. Žalkauskas and A. Vakelis, *Khimicheskaya Metallizatsiya Plastmass*. Leningrad: Khimiya, 1984.
5. R. M. Lukes, *Plating*, 51, 969, 1066 (1964).
6. M. Paunovic, *Plating*, 55, 1161 (1968).
7. F. M. Donahue, *Oberfläche-Surface*, 13, 301 (1972).
8. A. Vakelis and J. Jaciauskienė, *Elektrokhimiya*, 17, 816 (1981).
9. I. Ohno and S. Haruyama, *Surface Technol.*, 13, 1 (1981).
10. A. Vakelis, *Elektrokhimiya*, 14, 1970 (1978).
11. E. B. Saubestre, *Plating*, 59, 563 (1972).
12. K. M. Gorbunova and A. A. Nikiforova, *Physicochemical Principles of Nickel Plating*, Translated from Russian, 1963, TT 63-11003.

13. G. Gawrilov, *ChemischelStromläse/Vernickelung*. Saulgau, Wurt.: Eugen Leuze Verlag, 1974.
14. K. M. Gorbunova et al., *Fiziko-Khimichesklye Osnovy Processa Khimicheskogo Kobaltirovaniya*. Moscow: Nauka, 1974.
15. A. Molenaar and J. J. C. Coumans, *Surface Technol.*, 16, 265 (1982).
16. Y. Okinaka, in *Gold Plating Technology*, H. Reid and W. Goldie, Eds. Hatch End, Middlesex, England: Electrochemical Publications, Ltd., 1974, p. 82.

28

The Electrolyzing Thin, Dense, Chromium Process

28.1	General Definition	28-1
28.2	Applications	28-2
	General • Specific	
28.3	Surface Preparation	28-4
28.4	Solution	28-5
28.5	Properties	28-5
	Thickness • Adhesion • Corrosion • Wear Resistance (Surface Hardness) • Lubricity • Conformity • Heat Resistance • Brightness • Hydrogen Embrittlement	

Michael O'Mary
The Armoloy Corporation

28.1 General Definition

The Electrolyzing process uniformly deposits a dense, high chromium, nonmagnetic alloy on the surface of the basic metal being treated. The alloy used in Electrolyzing provides an unusual combination of bearing properties: remarkable wear resistance, an extremely low coefficient of friction, smooth sliding properties, excellent antiseizure characteristics, and beneficial corrosion resistance. Electrolyzed parts perform better and last up to 10 times longer than untreated ones.

The solution and application processes are carefully monitored at all Electrolyzing facilities. The result is a fine-grained chromium coating that is very hard, thin, and dense and has absolute adhesive qualities. The Electrolyzing process deposits a 99% chromium coating on the basis metallic surfaces, whereas normal conventional chromium plating processes tend to deposit 82 to 88% chromium in most applications.

Electrolyzing calls for the cleaning and removal of the matrix on the basis metal's surface by multi-cleaning process, using a modified electrocoating process that causes the chromium metallic elements of the solution to bond to the surface porosity of the basis metal. It is during this process that the absolute adhesive characteristics and qualities of Electrolyzing are generated. The Electrolyzing coating will not flake, chip, or peel off the basis metal substrate when conventional ASTM bend tests and impact tests are performed. Three basic factors are always present after applying Electrolyzing to metal surfaces:

- Increased wear (Rockwell surface hardness of 70 to 72 R_c)
- Added lubricity characteristics
- Excellent corrosion resistance

TABLE 28.1 Uses for Electrolyzing

Basis Metal Hardness Range (R_c)	Application	Thickness of Electrolyzing Recommended (in.)
18–30	Electrolyzing will handle low-loaded or stress conditions and provide basic corrosion resistance.	0.0001
30–40	Electrolyzing increases wear resistance where the metal will basically support the wear factor. Corrosion resistance is good in this range.	0.0007–0.0009
40–50	Corrosion resistance increases as basis metal gets harder. Wear resistance properties begin to improve greatly.	0.0003–0.0005
≥ 50	This is the most common and recommended range for an Electrolyzing application. Corrosion resistance is superior, and the maximum wear resistance benefits are exhibited.	0.00005–0.0003

28.2 Applications

28.2.1 General

Electrolyzing can meet a variety of engineering needs: chrome plating according to specifications, flash chrome plating, repair or salvage work, and heavy chrome application before grind. Electrolyzing increases wear resistance, reduces friction, prevents galling and seizing, minimizes fretting corrosion, offers resistance to erosion, and provides corrosion resistance. It can be applied to all commonly machined ferrous and nonferrous metals, including aluminum, titanium, stainless steels, coppers, brass, and bronze. The coating is not recommended for magnesium, beryllium, columbium, lead, and their respective alloys.

On aluminum, Electrolyzing increases wear life and surface strength, reduces oxidation and corrosion, enhances appearance, and prevents galling, seizing, and erosion. Electrolyzing is also conductive, whereas other treatments to aluminum are nonconductive. The result with Electrolyzing is no static buildup.

Because it is a thin, dense coating, Electrolyzing exhibits its best wear and lubricity properties on hardened surfaces. It is most effective when the basis metal is 40 R_c or harder. In severe wear applications, a basis metal should be hardened to the 50 to 62 R_c range before Electrolyzing is performed. Electrolyzing will improve performance on any basis metal, but it is not a substitute for heat treating.

Table 28.1 lists appropriate uses for Electrolyzing at various basis metal Rockwell hardness ranges.

28.2.2 Specific

Electrolyzing is used across a variety of industries for a multitude of purposes. With Electrolyzing, dies and molds for both rubber and plastics have better release characteristics and reduced wear (especially when abrasive materials are involved); cutting tools experience longer wear life; nuclear components exhibit better antigalling and corrosion resistance properties; dies used in stamping, drawing, forming, and blanking have sharper cuts and increases in work life; engine and transmission parts (such as valves, valve guides, pistons, gears, and splines) are protected without detrimental tolerance changes or variations; standard pumps and meters handle corrosive liquids and materials much better; and bearing and bearing surfaces can run longer and cooler and are superior to a 400 series stainless steel for corrosion protection. In fact, Electrolyzing makes it possible to use standard ferrous steels in place of stainless steel in many applications, including food processing, medical environments, and ball or roller bearing applications.

Other applications include drive transmissions, power transmissions, gears, molds, screws, sleeves, threaded parts, and valves. In the automotive industry, applications include not only engine parts, but also large metal form dies for auto body parts. Electrolyzing has been utilized on applications in these and other industries:

- Aerospace
- Aircraft and missiles
- Armament

- Automotive
- Business machines
- Cameras and projectors
- Computers
- Cryogenics
- Data processing
- Electronics
- Food processing
- Gauges and measuring equipment
- Medical instruments
- Metalworking
- Molds (plastic and rubber)
- Motor industry
- Nuclear energy
- Pharmaceutical
- Photography (motion and still)
- Refrigeration
- Textile industry
- Transportation

Specifically, Electroplating is approved and meets the following aerospace, nuclear, and commercial specifications:

- Air Research Company, Garrett, CO
- American Can Company
- AMS 2406
- AMS 2438
- AVCO Lycoming — AMS 2406
- Bell Helicopter
- Bendix Company
Utica, NY, division
Teterboro, NJ, division
Kansas City, MO, division
South Bend, IN, division
- Boeing
BAC 5709 Class II, Class IV
QQC 320
- Cleveland Pneumatic Tool-CPC Specs (Chromium), QQC320
- Colt Industries
Menasco, TX, division
- DuPont
- Fairchild Camera
- Fairchild Republic
- General Dynamics
- General Electric
Lynn, MA
Cincinnati, OH (aircraft)
Wilmington, MA
Wilmington, NC (nuclear)
Fitchburg, MA
- Gillette Company, Boston
- Grumman Aircraft

- IBM, 40 to 45
- Johnson & Johnson, New Jersey
- Kaman Aircraft
QQ-C-320
AMS 2438
- McDonnell/Douglas
PS 13102
QQC320
- MIL-C-23422
- Nabisco Company
- Ozone Industries
- Perkin Elmer Company, most divisions
- Pratt & Whitney
QQC320
PWA 48
AMS 2406
- Procter & Gamble, Cincinnati, OH
- QQ-C-320 B Class II
- Raytheon
- U.S. Navy
Newport News, Electric Boat, Portsmouth Naval Shipyard
Hamilton Standard
HS 332, HS246
QQ-C-320B
- Western Gear Company
- Western Electric Company
- Westinghouse

28.3 Surface Preparation

Substrate surfaces must be free of oil, grease, oxides, and sulfides. Parts should be surface finished before shipment to an Electrolyzing facility, where they will undergo further cleaning and surface preparation through a multicleaning process. Surfaces will not be changed significantly in configuration by the Electrolyzing process.

A clean surface is very important. When conventional chrome is utilized, component failure is often erroneously attributed to "spalling." The effect is actually due to a residual contaminant, which was covered or surrounded by electrodeposited chrome and subsequently dislodged as a result of sliding or other mechanical action. This leaves a void in the chrome plating which, in turn, causes further deterioration of the surface.

The surface must be free from scale and soils to secure the best corrosion resistance. Any scale left on the surface will gradually acquire a rusty appearance and act as a nucleus for additional rust to form. On articles that are to have a "stainless" appearance, every trace of scale must be removed by grinding, pickling, or polishing.

The solution of Electrolyzing, Inc., is to use a multicleaning procedure. Multicleaning is not a trade name, nor is it a novel, or supercleaning, technique. It is merely a designation for a carefully planned cleaning program prescribed for each individual part, utilizing every possible cleaning method available — such as vapor degreasing; solvent, detergent, diphase, and alkaline cleaning; dry vapor honing; electrolytic and ultrasonic cleaning; vibratory cleaning; and hydroblasting. Maintained throughout are high level quality control standards, consisting of microscopic before-and-after inspection of each part, intermittent inspection between processing phases, and disciplined handling procedures.

The significant surfaces to be coated should be completely finished prior to processing. For best results, the surface finish should be 32 RMS or better. The finer the surface, the better it is to Electrolyze. This is true to a finish of 2 to 4 RMS or better. Surface finishes that are received by Electrolyzing with 4 RMS or less may show some slight roughing of the surface after application. In most cases, these finishes can be tapped or polished back to their original condition. All surfaces should be free from plated coatings. Parts that have been nitrided should be machined or vapor-blasted before processing. The Electrolyzing coating will not adhere to brazed or welded areas unless these are machined or vapor-blasted to remove all impurities before processing. Unless otherwise specified, the coating should be applied after all basis metal processing has been completed. This includes heat treatment, stress relieving (when required), machining, brazing, welding, and forming. The coating should be applied directly to the basis metal without any intermediate coating.

Electrolyzing is a low temperature process. The temperature of parts during the cleaning and coating process does not exceed 180°F. There is no distortion or annealing of the basis metal.

Generally, parts should be less than 20 ft long, 30 in. in diameter, and 4000 lb in weight. Parts exceeding these limits should be discussed with Electrolyzing, Inc.

28.4 Solution

Electrolyzing is a blend of some of the best chrome salts and selected proprietary catalysts and additives that create its unique proprietary features. The solution is carefully monitored and its quality maintained through the use of exacting, sophisticated equipment and laboratory controls. The materials are distributed only of accredited licenses within the Electrolyzing licensee program.

28.5 Properties

28.5.1 Thickness

Electrolyzing is applied in a very thin, dense layer on the basis metal. The Electrolyzing process does not create a buildup on corners or sharp edges; it conforms exactly to the surface. There is no change in either the conductivity or magnetic properties of the basis metal.

Electrolyzing deposits range from 0.000010 to 0.003 in. per side. The practical coating range is from 0.000025 to 0.01 in. The average deposit is 0.0004 to 0.0008 in. per surface. Thickness tolerances of ± 0.000010 to ± 0.000050 in. can be maintained, depending on thickness specified and the quality level of the part. Coating thickness that may exceed 0.001 in. can be applied, and tolerances can be maintained to eliminate post-Electrolyze grinding operations. Table 28.2 and Table 28.3 list thickness ranges and tolerances for most metals. It is recommended that the coating thickness and tolerance be established by consulting with Electrolyzing, Inc.

TABLE 28.2 Thickness Ranges for Most Metals

Coating/Side (in.)	Tolerance (in.)
0.000050	± 0.000010
0.0001	± 0.000020
0.0002	± 0.000050
0.0003	± 0.000050
0.0004	± 0.000050
0.0005	± 0.000050
0.0006	± 0.000075
0.0007	± 0.0001
0.0008	± 0.0001
0.0009	± 0.0001
0.001	± 0.0002

TABLE 28.3 Thickness Ranges for Aluminum

Coating/Side (in.)	Tolerance (in.)
0.0001	±0.000020
0.0002	±0.000050
0.0003	±0.0001
0.0004	±0.0001
0.0005	±0.0002
0.0006	±0.0002
0.0007	±0.0002
0.0008	±0.0003
0.0009	±0.0003
0.001	±0.0003

Electrolyzing thickness is always in direct relation to the basis metal and will vary from one basis metal to another. However, the thickness established for each will remain constant and predictable. In all applications calling for a close inspection to monitor deposit thickness, Electrolyzing, Inc., recommends the use of an exacting reverse etchant method of ascertaining deposit thickness. This method is nondestructive to the basis metal. If necessary, destructive microphotos will verify deposit thickness and consistency.

28.5.2 Adhesion

Electrolyzing has outstanding adhesive characteristics. The adhesion of the coating is such that when examined at four diameters, it will not show separation from the basis metal on test specimens bent repeatedly through an angle of 180°, on a diameter equal to the thickness of the specimen, until fractured.

The Electrolyzing coating forms a lasting bond with the surface by permeating the surface porosity of the basis metal, but it can be removed by licensed Electrolyzing plants without detrimental effects to the basis metals.

28.5.3 Corrosion

Electrolyzing resists attack by most organic and inorganic compounds (except sulfuric and hydrochloric acids). The Electrolyzing coating is typically more noble than the substrate; therefore, it protects against corrosion by being free of pores, cracks, and discontinuities, and by providing a uniform structure and chemical composition. Porosity, hardness, and imperfect surface finishes of basis metals will affect the corrosion-resistant properties of Electrolyzing; however, all basis metals that are Electrolyze coated will have enhanced corrosion-resistant characteristics.

Samples can be subjected to standard ASTM B-117 and B-287 salt spray tests. The Electrolyzing process also meets the following specifications: QQ-C-320, AMS-2406, Mil-C-23422, Mil-P-6871, ANP-39, and NASA ND-1002176.

28.5.4 Wear Resistance (Surface Hardness)

Electrolyzing is one of the hardest chromium surfaces available, measuring 70 to 72 R_c, as applied. "As applied" refers to the measurable hardness of the Electrolyzing coating when measured on the basis metal to which it is applied. The basis metal plays an important role in determining how wear resistant the Electrolyzing surface will be. Generally speaking, Electrolyzing increases measurable hardness 10 to 15 points, as shown in Table 28.4.

In all cases, Electrolyzing is 70 to 72 R_c. However, the basis metal directly affects the measurable hardness that can be achieved. The harder the basis metal, the higher the Electrolyzing measurable hardness will be. Test measurements of the surface hardness should be made using the Knoop or Vickers method with a 5 to 10 g load on a diamond point.

TABLE 28.4 Measurable Hardness (R_c)

Basis Metal	Electroplating Coating
≤18	18–25
18–35	30–50
35–50	50–70
50+	70+

High hardness values indicate good wear resistance, but there are other factors to consider, such as coating surface texture, coating density, substrate cleanliness before coating application, interfacial energy of adhesion between the coating and the substrate, energy of adhesion between coating surface and the opposing sliding material, type of lubricant used, and the combination of opposing materials.

Increased density improves wear resistance, because it results in fewer cracks, inclusions, and voids, which in turn, reduces the rate of corrosive attack and provides more resistance to fragmentation, spalling, and wear.

Surface fatigue wear — the category to which true spalling belongs — also affects wear resistance in conventional QQ-C-320 chrome plating. The stress concentrations here are generated during the electrodeposition, an integral phenomenon when chromium crystals are formed. The Electroplating coating — essentially a chromium alloy — is virtually devoid of these internal stress concentrations, and therefore has minimal tendency to spall. This is one of the reasons for the substantial superiority in wear resistance under mechanical impact conditions of Electroplating to most conventional chrome platings.

The Electroplating coating also has a lower kinetic friction coefficient, and in wear resistance, it is superior to all other chrome platings (including electroless nickel and a tungsten-carbide coating), as measured on three different test machines: the Taber, the Falex, and the LFW-1.

Finally, the Electroplating coating exhibits extremely low adhesive wear coefficients: 1.72×10^{-7} on steel against a copper alloy, and 1.19×10^{-7} on steel against steel with a petroleum oil (10^{-8} representing the ultimate or best wear coefficient ever measured).

28.5.5 Lubricity

An Electroplated coating has a coefficient of friction of 0.11. Electroplating also produces kinetic friction coefficients as low as 0.045 under unidirectional sliding test conditions with fluorosilicone oil on the LFW-1 test machine, and a 0.069 with an additive-free white mineral oil on the Falex lubricant tester. Electroplating's low friction factor is invaluable when extreme temperatures are involved.

28.5.6 Conformity

Electroplating works best when applied to a relatively smooth surface (12 to 32 RMS or finer). Below 4 RMS, the process may deter slightly from the fine finish of the part, requiring post-Electroplating operations.

Internal and external surfaces of nearly all shapes and configurations can be uniformly processed. Slots or grooves less than 0.187 in. wide, having a depth greater than width, and bores less than 0.187 in. diameter will require special engineering to assure a uniform coating. Electroplating, Inc., recommends test runs for such parts and special discussions with Electroplating engineers on dimensions less than 0.187 in.

28.5.7 Heat Resistance

The maximum operating temperature recommended for the Electroplating coating is approximately 1600°F (710°C). Time at temperature should be reviewed with Electroplating, Inc., before testing or specifying Electroplating. In general, oxidation occurs around 1100°F (430°C), progressing to 1650°F (740°C), and then to diffusion.

28.5.8 Brightness

The Electroplating coating is smooth, continuous, fine-grained, adherent, uniform in thickness and appearance, and free from blisters, pits, nodules, porosity, and edge buildup. Electroplating is used as the final coating on parts and equipment. The Electroplating coating is shiny by application. However, satin (matte) finishes can be attained, if specified.

28.5.9 Hydrogen Embrittlement

During conventional chrome plating processes, a detrimental side effect occurs: hydrogen occlusion. Hydrogen penetrates into the substrate and causes embrittlement of the metal part with subsequent reduction of mechanical properties, particularly fatigue strength. Most conventional chrome plating control documents, therefore, specify a final 375°F bake to remove hydrogen gas.

The longer the plating cycle, the more likely it is that hydrogen embrittlement will occur. Embrittlement is also more likely to occur after an acid clean. Shot peening and/or liquid honing can be used to relieve embrittlement stress.

Hydrogen embrittlement is extremely unlikely with Electroplating because the Electroplating processing avoids most of the causes of a true hydrogen embrittlement. Electroplating, Inc., does not include post-process baking in its process technique. However, if postprocess baking is required by a customer, Electroplating, Inc., is able to include it as a standard procedure.

29

The Armoloy Chromium Process

29.1	General Definition	29-1
29.2	Applications	29-1
	General Applications • Specific Applications	
29.3	Surface Preparation	29-2
29.4	Properties	29-2
	Thickness • Adhesion • Corrosion • Wear Resistance • Lubricity • Conformity • Heat Resistance • Brightness • Hydrogen Embrittlement	

Michael O'Mary
The Armoloy Corporation

29.1 General Definition

The Armoloy process is a low temperature, multistate, chromium alloy process of electrocoating based on a modified chromium plating technology. However, instead of the customary chromium plating solutions, the Armoloy process uses a proprietary chemical solution. The solution and application process are carefully monitored at all Armoloy facilities. The result is a satin finish chromium coating that is very hard, thin, and dense and has absolute adhesive qualities. Armoloy deposits a 99% chromium coating on the basis metallic surfaces, whereas conventional chromium plating processes tend to deposit 82 to 88% chromium in most applications.

The Armoloy process involves cleaning and removing the matrix on the basis metal's surface by special proprietary means and using a modified electrocoating process that causes the chromium metallic elements of the solution to permeate the surface porosity of the basis metal. It is during this process that the absolute adhesive characteristics and qualities of Armoloy are generated. The Armoloy coating actually becomes part of the basis metal itself, and the result is a lasting bond and a continuous, smooth, hard surface. The surface will not chip, flake, crack, peel, or separate from the basis metal under conditions of extreme heat or cold, or when standard ASTM bend tests are involved.

Three basic factors are always present after applying Armoloy to metal surfaces:

- Increased wear (70 to 72 R_c surface hardness)
- Added lubricity characteristics (including the ability to utilize Armoloy against Armoloy)
- Excellent corrosion resistance

29.2 Applications

29.2.1 General Applications

All ferrous and most nonferrous materials are suitable for Armoloy application. Service life of parts has been increased to 10 times normal life and even higher in certain applications. However, basis metals of aluminum, magnesium, and titanium are not good candidates for the Armoloy process.

TABLE 29.1 Uses for Armoloy

Basis Metal Hardness Range (R_c)	Application
18–30	Armoloy will handle low-loaded or stress conditions and provide basic corrosion resistance.
30–40	Armoloy increases wear resistance where the metal will basically support the wear factor. Corrosion resistance is good in this range.
40–50	Corrosion resistance increases as basis metal gets harder. Wear resistance properties begin to improve greatly.
>50	This is the most common and recommended range for an Armoloy application. Corrosion resistance is superior, and the maximum wear resistance benefits are exhibited.

Because it is a thin, dense coating, Armoloy exhibits its best wear and lubricity properties on hardened surfaces. It is most effective when the basis metal is 40 R_c or harder. In severe wear applications, a basis metal should be hardened to the 58 to 62 R_c range before Armoloy application. Armoloy will improve performance on any basis metal, but it is not a substitute for heat treating.

Table 29.1 lists appropriate uses for Armoloy at various hardness ranges.

29.2.2 Specific Applications

Armoloy is used across a variety of industries for a multitude of purposes. With Armoloy, dies and molds for both metal and plastics have better release characteristics and reduced wear (especially when abrasive materials are involved); cutting tools experience longer wear life; nuclear components exhibit better antigalling and corrosion resistance properties; dies used in stamping, drawing, forming, and blanking have sharper cuts and increases in work life; engine and transmission parts (such as valves, valve guides, pistons, gears, and splines) are protected without detrimental tolerance changes or variations; standard pumps and meters handle corrosive liquids and materials much better; and bearings and bearing surfaces can run longer and cooler and are superior to a 440C stainless steel for corrosion protection. In fact, Armoloy makes it possible to use standard ferrous steels in place of stainless steel in many applications, including food processing, medical environments, and ball or roller bearing applications.

Other applications include drive transmissions, power transmissions, gears, molds, screws, sleeves, threaded parts, and valves. In the automotive industry, applications not only include engine parts, but also large metal form dies for auto body parts.

29.3 Surface Preparation

Substrate surfaces must be free of oil, grease, oxides and sulfides. Parts should be surface finished before shipment to Armoloy, where they will undergo further cleaning and surface preparation through proprietary means. Surfaces are not changed significantly in configuration by the Armoloy process. Armoloy does not fill scratches, pits, or dents, but rather conforms to such imperfections and may highlight them.

The preparation by Armoloy of the surface conditions tends to improve overall surface finish on most parts submitted for processing. The special mechanical methods utilized by Armoloy do not feature any acids, etching, or reversing methods used in conventional chromium plating; consequently, there is no detrimental effect to the basis metal. Surface finishes that are received by Armoloy with 8 RMS or less may show some slight roughing of the surface after application. In most cases, these finishes can be lapped or polished back to their original condition. It is important to be aware that Armoloy is a silver-satin finish and does not exhibit the maximum reflective properties of some conventional chromium processes.

29.4 Properties

29.4.1 Thickness

Armoloy is applied in a very thin, dense layer on the basis metal. The coating will range from 0.000040 to 0.0006 in. (1 to 15 μm) per side. Normal proven average deposits per side are in the 0.0001 to 0.0002

TABLE 29.2 Measurable Hardness (R_c)

Basis Metal	Armoloy Coating
≤ 18	18–25
18–35	30–50
35–50	50–70
> 50	> 70

in. (2.5 to 5 μm) range. Tolerances can be held to ± 0.000050 in. ($\pm 1 \mu\text{m}$) on deposits up to 0.0002 in. (5 μm) per side. If required, Armoloy can be controlled to ± 0.000025 in. ($\pm 0.5 \mu\text{m}$) per surface. There is no change in either the conductivity or magnetic properties of the basis metal.

Armoloy thickness is always in direct relation to the basis metal, and it will vary from one basis metal to another. However, the thickness established for each will remain constant and predictable. In all applications calling for a close inspection to monitor deposit thickness, the Armoloy Corporation recommends the use of an exacting reverse etchant method of ascertaining deposit thickness. This method is nondestructive to the basis metal.

29.4.2 Adhesion

Armoloy will not chop, flake, crack, peel, or separate from the basis material under standard ASTM bend tests or under conditions of extreme heat or cold (from -440 to 1600°F). The Armoloy coating forms a lasting bond with the surface by permeating the surface porosity of the basis metal. Armoloy can be removed by licensed Armoloy plants without detrimental effects to the basis metals.

29.4.3 Corrosion

Armoloy resists attack by most organic and inorganic compounds (except sulfuric and hydrochloric acids). The Armoloy coating is typically more noble than the substrate; therefore, it protects against corrosion by being free of pores, cracks, and discontinuities, and by providing a uniform structure and chemical composition. Porosity, hardness, and imperfect surface finishes of basis metals will affect the corrosion-resistant properties of Armoloy; however, all basis metals that are Armoloy coated will have enhanced corrosion-resistant characteristics. Samples are subjected to standard ASTM B-287 salt spray tests. Armoloy also conforms to Mil QQC-320B, AMS 2406, and AMS 2438.

29.4.4 Wear Resistance

Armoloy is one of the hardest chromium surfaces available, measuring 70 to 72 R_c , as applied. "As applied" refers to the measurable hardness of the Armoloy coating when measured on the basis metal to which it is applied. The basis metal plays an important role in determining how wear resistant the Armoloy surface will be. Generally speaking, Armoloy increases measurable hardness 10 to 15 points, as shown in Table 29.2.

Armoloy is always 70 to 72 R_c . However, the basis metal directly affects the measurable hardness that can be achieved. The harder the basis metal, the higher the Armoloy measurable hardness will be. Test measurements of the surface hardness should be made using the Knoop or Vickers method with a 5 to 10 g load on a diamond point.

High hardness values indicate good wear resistance, but there are other factors to consider. Corrosion and lubrication also affect wear. Armoloy improves wear resistance not only by being extremely hard, but also by resisting corrosion and by improving lubricity with its nodular microsurface.

29.4.5 Lubricity

Special techniques used in its application render Armoloy self-lubricating, creating a nodular surface. Armoloy's low friction factor is invaluable under condition of extreme temperatures. Table 29.3 gives coefficients of friction on various materials at 72°F with no lubricants.

TABLE 29.3 Comparison of Coefficients of Friction

Materials			Coefficients	
1	versus	2	Static	Sliding
Steel		Steel	0.30	0.20
Steel		Babbitt metal	0.25	0.20
Steel		Armoloy	0.17	0.16
Babbitt metal		Armoloy	0.15	0.13
Armoloy		Armoloy	0.14	0.12

An added feature of the Armoloy coating is its ability to be run against itself in friction-related applications. The special modular (orange peel) surface that is created by the Armoloy process allows for the special “Armoloy-to-Armoloy” feature to reduce frictional characteristics. The modular surface creates excellent retention of lubricants and a continuous dispersion of them, which help to provide other low friction features. Special attention must be paid in the engineering of tolerances when Armoloy will be operated against another Armoloy surface.

29.4.6 Conformity

Armoloy conforms exactly to the basis metal surface. All threads, flutes, and even scratches are reproduced in detail. Armoloy works best when applied to a relatively smooth surface (12–32 RMS). RMS finish will improve slightly, to a low of about 8 RMS. Below 4 RMS, the process may deter slightly from the fine finish of the part.

Internal and external surfaces of nearly all shapes and configurations can be uniformly processed. Slots or grooves less than 0.187 in. wide, having a depth greater than width, and bores less than 0.187 in. in diameter will require special engineering to assure a uniform coating.

29.4.7 Heat Resistance

Armoloy will withstand temperatures of –440 to 1800°F. At temperatures above 1600°F, Armoloy will react with carbon monoxide, sulfur vapor, and phosphorus and begin to soften. At bright red heat, oxidation occurs in steam or alkaline hydroxide atmospheres. Hardness, wear resistance, and corrosion properties will be reduced at temperatures above 1600°F. Conversely, the Armoloy coating will remain basically stable at temperatures below –200°F.

29.4.8 Brightness

Armoloy is used as the final coating on parts and equipment. It has a very attractive satiny-silver matte and “micro-orange peel” finish. If necessary, Armoloy can be polished after application to enhance its surface finish and reflectivity.

29.4.9 Hydrogen Embrittlement

In all electrochemical plating processes, free ions of hydrogen are created and released. Frequently, these ions entrap themselves in the molecular structure of the basis material, resulting in hydrogen embrittlement. The following conditions make hydrogen embrittlement extremely unlikely with the Armoloy process:

- No acids are used in the preparation process.
- The vapor blast (liquid hone) or dry hone procedure aids in relieving residual surface stress.
- No “reverse clean” or etchant is used before the part is Armoloy processed.

The plating cycle times are very short, and the Armoloy chrome is deposited so rapidly that Armoloy seals the surface porosity of the basis metal before hydrogen ions can invade the surface of the basis metal. However, if required, Armoloy can be and will be postplate heat treated to specification.

30

Sputtered Thin Film Coatings

30.1	History	30-1
30.2	General Principles of Sputtering.....	30-1
30.3	Sputter Deposition Sources.....	30-3
	Direct Current Diode Sputtering • Triode Sputtering • Radio Frequency Sputtering • Magnetron Sputtering • Beam Sputtering • Reactive Sputtering	
30.4	Other Process Considerations	30-8
30.5	Properties of Sputtered Thin Film Coatings.....	30-8
30.6	Thin Film Materials	30-9
30.7	Applications for Sputtered Thin Films.....	30-9
	Electrical • Magnetic • Optical • Mechanical • Chemical • Decorative	
30.8	Additional Resources.....	30-10
	Bibliography	30-10

Brian E. Aufderheide
W. H. Brady Company

30.1 History

Sputtering was discovered in 1852 when Grove observed metal deposits at the cathodes of a cold cathode glow discharge. Until 1908 it was generally believed that the deposits resulted from evaporation at hot spots on the cathodes. However, between 1908 and 1960, experiments with obliquely incident ions and sputtering of single crystals by ion beams tended to support a momentum transfer mechanism rather than evaporation. Sputtering was used to coat mirrors as early as 1887, finding other applications such as coating fabrics and phonograph wax masters in the 1920s and 1930s. The subsequent important process improvements of radio frequency (rf) sputtering, allowing the direct deposition of insulators, and magnetron sputtering, which enables much higher deposition rates with less substrate damage, have evolved more recently. These two developments have allowed sputtering to compete effectively with other physical vapor deposition processes such as electron beam and thermal evaporation for the deposition of high quality metal, alloy, and simple organic compound coatings, and to establish its position as one of the more important thin film deposition techniques.

30.2 General Principles of Sputtering

Sputtering is a momentum transfer process. When a particle strikes a surface, the processes that follows impact depend on the energy of the incident particle, the angle of incidence, the binding energy of surface atoms, and the mass of the colliding particles (Figure 30.1).

In sputtering, the incident particles are usually ions, because they can be accelerated by an applied electrical potential. If the kinetic energy with which they strike the surface is less than about 5 eV, they

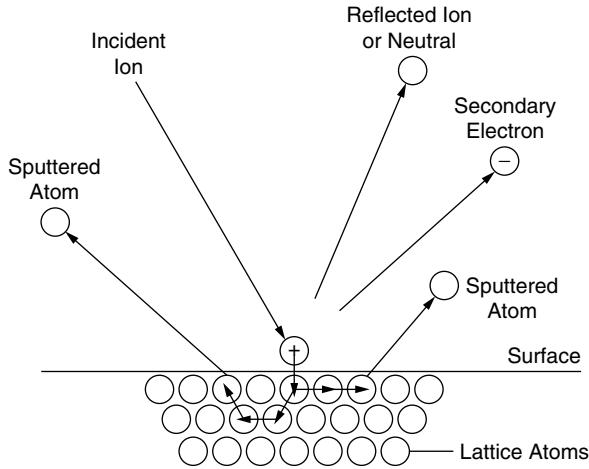

FIGURE 30.1 Schematic representation of some of the processes that follow ion impact during sputtering. (Courtesy of W. H. Brady Co.)

will likely be reflected or absorbed on the surface. When the kinetic energy exceeds the surface atom binding energy, surface damage will occur as atoms are forced into new lattice positions. At incident ion kinetic energies above a threshold, typically 10 to 30 eV, atoms may be dislodged or sputtered from the surface. At normal incidence, multiple internal collisions are required, but at lower angles, sputtered atoms can be produced directly. These sputtered atoms and ions can be condensed on a substrate to form a thin film coating.

Energetic ion bombardment is usually achieved by a low pressure process of the glow discharge type. The basic process configuration, in this case diode, is shown in Figure 30.2. The vacuum chamber is equipped with a target (cathode), the source of coating material, and a substrate to be coated. To dissipate the considerable heat generated in the target during the sputtering process, it is usually bonded to a water-cooled metal (copper) backing plate with solder or conductive epoxy. The target also may be directly cooled by water for greater cooling capacity. The chamber is evacuated and then backfilled with an inert gas, usually argon, to a pressure of 10^{-3} to 10^{-1} torr.* An electrical potential is applied between the target (cathode) and substrate holder (anode). This produces a low pressure glow discharge

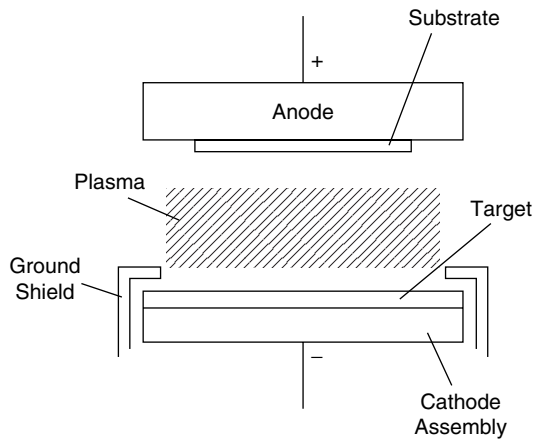

FIGURE 30.2 Schematic representation of a diode sputtering assembly. (Courtesy of W. H. Brady Co.)

*1 Pascal (Pa) = $1 \text{ N/m}^2 = 0.075 \text{ Torr}$.

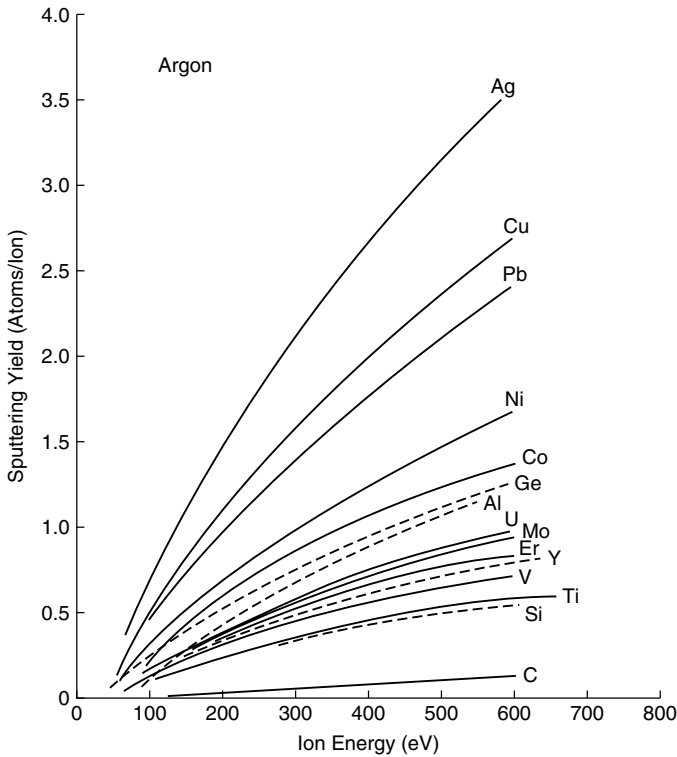

FIGURE 30.3 Variation of sputtering yield with ion energy at normal angle of incidence. (From J. A. Thornton, in *Deposition Technologies for Films and Coatings*, R. K. Bunshah, Ed. Park Ridge NJ: Noyes Publications, 1982, p. 179.)

or plasma between the two electrodes. Grounded dark space shields are used to prevent a discharge from forming in undesirable areas. In a dc glow discharge of this type, current is carried by electrons that are collected from the plasma by an anode and by positive ions leaving the plasma as they are accelerated toward the target. A continuous supply of additional ions and electrons must be available if the discharge is to be sustained. Some of the ions striking the target surface generate secondary electrons, which are accelerated by the cathode potential. These electrons, with energies approaching the applied potential, enter the plasma and ionize gas atoms, producing the necessary additional ions and electrons to sustain the discharge.

The relative rates of deposition for different materials depend largely on the sputter for different materials, the sputter yield (Figure 30.3), defined as the number of target atoms ejected per incident particle. Sputter yield depends on the target material, silver showing the highest yield, and generally increases with incident ion energy and mass.

30.3 Sputter Deposition Sources

30.3.1 Direct Current Diode Sputtering

The simplest and oldest sputter deposition source is dc diode. The two electrodes are usually parallel to each other, spaced 4 to 8 cm apart and the substrate is placed on the anode as in Figure 30.2. The applied potential is typically 1000 to 3000 V dc with argon pressures of about 0.075 to 0.12 torr. The dc diode configuration has important disadvantages, including low deposition rate ($\sim 400 \text{ \AA}/\text{min}$ for metals), high working gas pressure, targets limited to electrical conductors, and bombardment of the substrate by plasma electrons, resulting in substrate heating. The cathode systems discussed next can be used to improve on the performance of the dc diode.

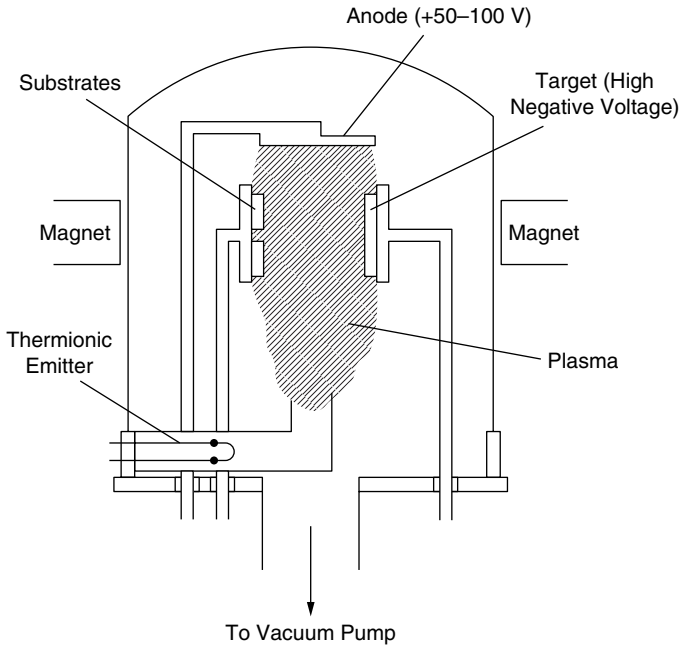

FIGURE 30.4 Schematic representation of a triode sputtering process. (Courtesy of W. H. Brady Co.)

30.3.2 Triode Sputtering

A heated filament (Figure 30.4) is used as a secondary source of electrons for the discharge; an external magnet can also be used to confine electrons and increase isolation probability. Triodes can produce much higher deposition rates, up to several thousand angstroms per minute, at lower pressures (0.5 to 1×10^{-3} torr) and voltages (50 to 100 V). The usefulness of triodes has been limited by difficulties in scaling up to large cathode sizes and corrosion of the emitter filament by chamber gases.

30.3.3 Radio Frequency Sputtering

Nonconducting materials cannot be directly sputtered with an applied dc voltage because of positive charge accumulation on the target surface. If an ac potential of sufficiently high frequency is applied, an effective negative bias voltage is produced such that the number of electrons that arrive at the target while it is positive equals the number of ions that arrive while it is negative. Because the mass of the electron is very small relative to ions present, the target is positive for only a very short time, and deposition rates for rf diode are almost equivalent to dc diode. This resulting negative bias allows sputtering of an insulating target. The frequency used in most practical applications is usually 13.56 MHz, a radio frequency band allocated for industrial purposes by the Federal Communications Commission. Rf sputtering allows insulators as well as conductors and semiconductors to be deposited with the same equipment and also permits sputtering at a lower pressure (5 to 15×10^{-3} torr). One major disadvantage of rf sputtering is the need for electromagnetic shielding to block the rf radiation. Also, the power supplies, matching network, and other components necessary to achieve a resonant rf network are very complex.

30.3.4 Magnetron Sputtering

The magnetron cathode is essentially a magnetically enhanced diode. Magnetic fields are used to form an electron trap that, in conjunction with the cathode surface, confines the $E \times B$ (electric field strength \times magnetic flux density) electron drift currents to a closed-loop path on the surface of the target. This

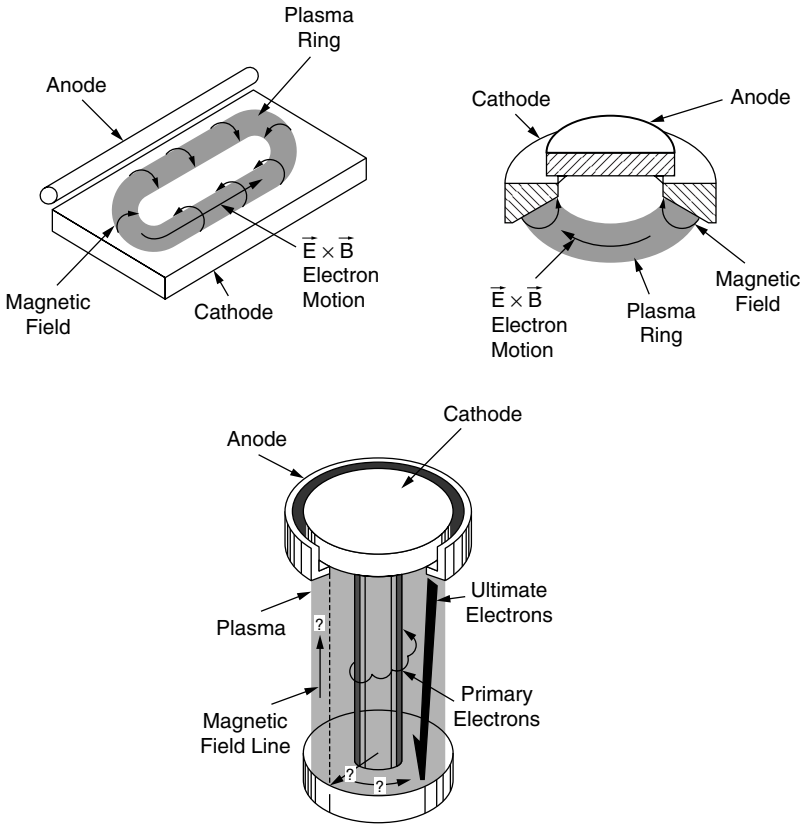

FIGURE 30.5 Clockwise from upper left: schematic representations of planar magnetron, gun-type magnetron, and cylindrical post magnetron sputtering sources. (Adapted from J. A. Thornton, in *Deposition Technologies for Films and Coatings*, R. F. Bunshah, Ed. Park Ridge NJ: Noyes Publications, 1982, pp. 194–195.)

“racetrack” effectively increases the number of ionizing collisions per electron in the plasma. The magnetic confinement near the target results in higher achievable current densities at lower pressures (10^{-3} to 10^{-2} torr), nearly independent of voltage. This manner of cathode operation is described as the magnetron mode and is capable of providing much higher deposition rates (10 times dc diode) with less electron bombardment of the substrate and therefore less heating. Factors affecting deposition rate are power density on the target, erosion area, distance to the substrate, target material, sputter yield, and gas pressure. Dc is usually used for magnetron sputtering, but rf can be used for insulators or semiconductors. When magnetic materials are sputtered, a thinner target is often necessary to maintain sufficient magnetic field strength above the target surface. The three most common magnetron cathode designs, described below, are illustrated in Figure 30.5.

30.3.4.1 Planar Magnetron

An array of permanent magnets is placed behind a flat, circular or rectangular target. The magnets are arranged such that areas in which the magnetic field lines are parallel to the target surface form a closed loop on the surface. Surrounding this loop, the magnetic field lines generally enter the target, perpendicular to its surface. This produces an elongated electron racetrack and erosion pattern on the target surface. Because of the nonuniformity in target erosion, utilization of target material is poor, typically 26 to 45%. This also results in nonuniform deposition on a stationary target. Uniformity is provided by substrate motion, usually linear or planetary, combined with uniformity aperture shielding. Planar magnetron cathodes are usually operated at 300 to 700 V providing a current density of 4 to 60 mA/cm² or a power density of 1 to 36 W/cm².

Deposition rates are generally proportional to the power delivered to the target. Much of this power is dissipated as target heating. The primary factor limiting magnetron deposition rates is the amount of power that can be applied to the target without causing it to melt, crack, or warp. This is controlled by the cathode water cooling design, and the thermal conductivity of the target, the backing plate, and the interface between them. The planar magnetron cathode has been scaled up in production applications to several meters in length and serves as an important industrial coating tool.

30.3.4.2 Cylindrical Magnetron

Two variations on a cylindrical cathode design can be used to coat large surface areas: the cylindrical post magnetron, which sputters outward from a central post target, and the cylindrical hollow or inverted magnetron, which has target erosion on the inner wall of a cylindrical target. Operating parameters are similar to the planar magnetron. The $E \times B$ current closes on itself by going around the post or cylinder. Electrostatic or magnetic containment is often used to minimize end losses. Erosion is uniform along the post or inside of the cylinder. This enables fairly uniform coating without substrate movement. Hollow cathodes are especially effective at coating objects of complex shapes. Another cylindrical cathode, the rotatable magnetron, uses a magnet array similar to a planar magnetron and rotates the target or magnets to obtain uniform erosion.

30.3.4.3 Ring or Gun Magnetron

The ring or gun magnetron source includes a circular cathode and a concentric centrally located anode. As with other magnetrons, high deposition rates are possible with little substrate heating. Because of the circular design, planetary substrate motion is necessary for deposition uniformity. This design is extensively used for small-scale applications but has not been scaled up to larger dimensions. Arrays of these cathodes have been used to coat large areas.

30.3.5 Beam Sputtering

A separate ion beam source (Figure 30.6), as opposed to a glow discharge, may be used to erode the surface of a target. The energy, direction, and current density of the ion beam may be controlled independently, and it is possible to work at background pressures lower than other sputter deposition methods used. Unique film properties can sometimes be obtained using ion beam deposition, but it is generally limited to coverage of rather small areas and lower deposition rates.

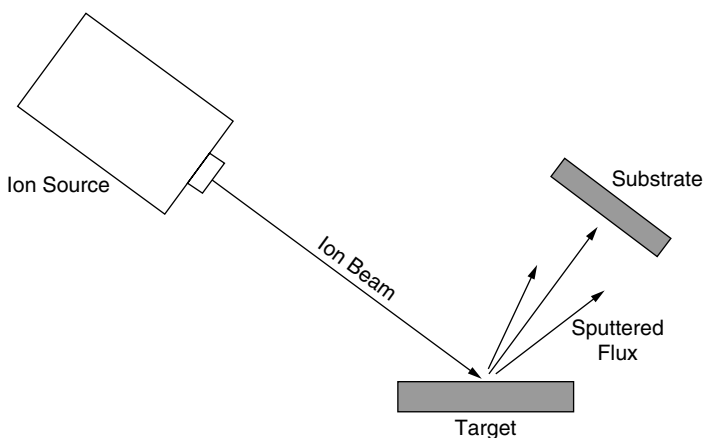

FIGURE 30.6 Schematic representation of ion beam sputtering source showing relative locations of target and substrate. (From J. A. Thornton, in *Deposition Technologies for Films and Coatings*, R. K. Bunshah, Ed. Park Ridge, NJ: Noyes Publications, 1982, p. 211.)

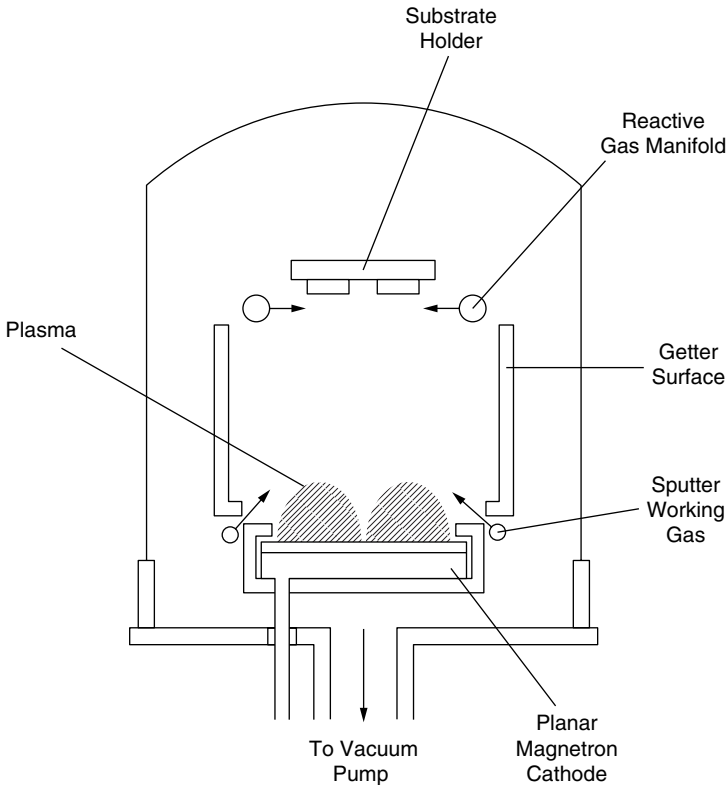

FIGURE 30.7 Schematic representation of a reactive sputtering apparatus. (Courtesy of W. H. Brady Co.)

30.3.6 Reactive Sputtering

Argon is usually employed as the working gas in sputter deposition processes. It is relatively inert, being incorporated in the growing film only when trapped or embedded in its surface. Other more reactive gases such as water vapors, oxygen, and nitrogen are normally present in the deposition chamber as low level contaminants, which have been outgassed from the substrate, target, and chamber walls. These gases may be incorporated into the growing film by reacting with condensed atoms on the substrate surface, forming small amounts of oxides, nitrites, carbides, and other similar compounds of the sputtered material.

In reactive sputtering, gases are intentionally introduced into the deposition chamber to completely react with the forming thin film. A gas manifold system (Figure 30.7) is often used to provide uniform distribution of the reactive gas at the substrate and minimize reactive gas at the target surface.

Reactive sputtering is a very nonlinear process. The growing film on the substrate acts like a getter pump for the reactive gas up to the pressure at which a stoichiometric compound is formed. At this point, the pumping rate of the substrate decreases substantially, and reactive gas pressure increases in the chamber. This gas may react with the surface of the target, resulting in decreased deposition rates due to lower sputter yields of compounds and other factors. Consequently, most reactive deposition processes attempt to work near the transition region of the target, where stoichiometric compounds are formed at the substrate and the cathode target is metallic. Reactive sputtering therefore permits the formation of compounds from simple metallic targets in the dc mode or rf mode. This process is widely used for deposition of oxides and nitrites such as silicon oxides, silicon nitrite, titanium nitride, and indium tin oxide.

30.4 Other Process Considerations

Vacuum chambers used for sputtering have to be capable of producing a vacuum better than 5×10^{-4} torr to minimize contamination from background gases. A load lock is used on some devices when contamination of the sputter chamber by gas absorbed when the chamber is opened is unacceptable, or to decrease pump down time. A wide variety of pumping systems are used including diffusion, turbomolecular, and cryogenic pumps. Throttling of the pumps is necessary in many cases due to high working pressures.

Most target materials have considerable surface contamination accumulated during manufacture and storage. Targets are presputtered to a depth sufficient to remove these contaminants before deposition. A shutter is often used to protect the substrate from the contamination while the target is being cleaned.

The sputtering process can be very dependent on such equipment design factors as gas distribution systems, position of pumps, and distance from target to substrate. These factors and others must be carefully considered when transferring a process from one chamber to another or when scaling up to production levels.

A major factor controlling equipment configuration is the nature of the substrate. The substrate may be small rigid pieces such as microelectronic circuitry or much larger rigid items such as architectural glass. If the substrate is flexible, roll-to-roll processing is often used. Equipment is designed to handle the substrate in a manner that will promote the achievement of coating uniformity.

30.5 Properties of Sputtered Thin Film Coatings

The electrical, optical, and other properties of thin films often vary from the properties measured in bulk materials. Conditions present at the substrate during deposition can have a significant influence on these properties. When a sputtered atom condenses on a substrate, it transforms its kinetic energy to the surface lattice. The resulting loosely bonded atom has mobility on the surface and will migrate over the surface, interacting with other adsorbed atoms until it finds a permanent low energy site, or is desorbed. As the film thickness builds, atoms within the lattice move to more stable positions by bulk diffusion.

For many metals, the mobility of surface and bulk atoms is related to the ratio of substrate temperature (T) and the melting point of the metal (T_m). At low T/T_m values, surface and bulk diffusion play only a small role because atoms have insufficient energy to move from their initial position. In films deposited under these conditions (Figure 30.8), the internal crystal structure is poorly defined and has many defects; voids are also present due to shading effects. Conditions tending to produce lower T/T_m are higher melting temperature target materials (e.g., refractory metals), substrate cooling, higher working gas pressures (which “thermalize” or reduce sputtered atom energies), and reactive gases adsorbed on the surface. Higher T/T_m values result in more surface and bulk diffusion in the growing film, producing denser columnar grains with fewer defects and defined boundaries.

In addition to substrate heating, T can effectively be raised by bombarding the substrate with ions or electrons during deposition. In a diode system, the substrate is often in the plasma, resulting in film heating due to high energy electron impact. A bias voltage can also be applied to the substrate to accelerate incoming ions, increasing the kinetic energy transferred to the surface. When depositing alloys or compounds, higher T values may decrease the sticking coefficient of one component, changing the overall film composition. An important point to remember is that the kinetic energy of sputtered atoms typically is 10 times that of evaporated species. This factor plays a significant role in determining the difference in properties between sputtered and evaporated films.

Most sputtered thin films are in a state of compressive or tensile stress. The stress is due to the mismatch in thermal coefficients of expansion between the substrate and the thin film and to internal stresses built up within the film as a result of imperfections in the crystal lattice. In higher T_m materials, deposited at low T/T_m , internal stresses usually dominate and may reach the yield strength of the film, resulting in fracture. Both magnitude and type of internal stress have been found to be influenced by working gas pressure. Thermal stress usually predominates in higher T/T_m coatings.

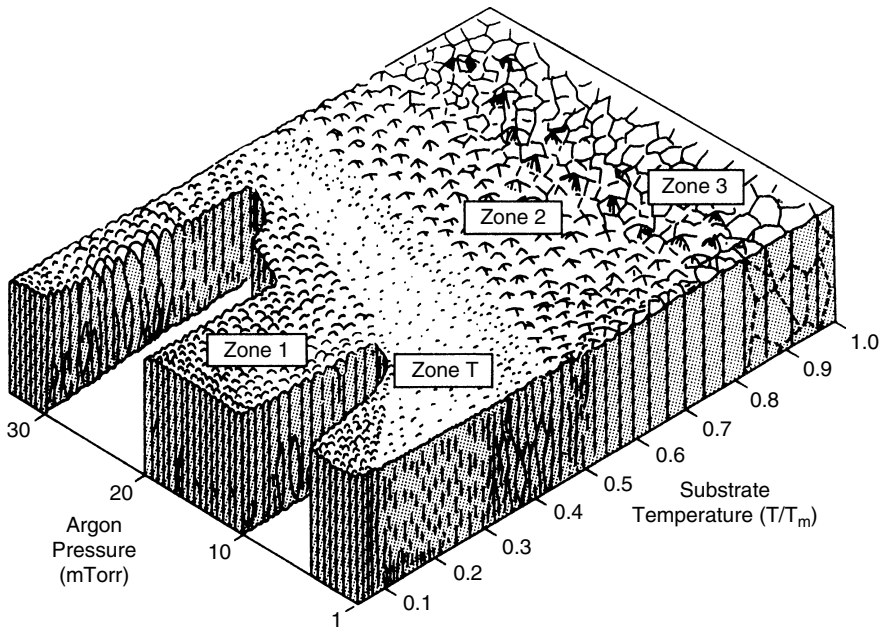

FIGURE 30.8 Schematic representation of the relationship between substrate temperature and argon pressure on the structure of metal coatings deposited by sputtering using a cylindrical magnetron source. T is the substrate temperatures and T_m is the melting point of the coating material in absolute degrees. (From J. A. Thornton, in *Deposition Technologies for Films and Coatings*, R. F. Bunshah, Ed. Park Ridge, NJ: Noyes Publications, 1982, p. 214.)

30.6 Thin Film Materials

Most metals have been deposited by sputtering; some of the more commonly used metals are aluminum, chromium, copper, gold, molybdenum, nickel, platinum, palladium, silver, tantalum, titanium, tungsten, vanadium, and zirconium. This group of metals represents an extremely broad range of electrical, magnetic, mechanical, optical, and other physical properties. If a single metal does not provide the necessary properties, alloys such as stainless steel, nichrome, and cobalt chrome may also be sputtered. The different elements comprising an alloy may have widely ranging sputter rates, but because of concentration at the target surface of the slower sputtering species, alloys can generally be sputter deposited with the same composition as the target. Semiconductors such as silicon and carbon can also be sputtered, but if conductivity of the target is too low, rf power may be necessary. Oxides, nitrides, carbides, sulfides, and other compounds of the metals, alloys, and semiconductors listed above may be made via reactive sputtering with added oxygen, nitrogen or ammonia, methane or other gaseous hydrocarbons, and hydrogen sulfide, respectively.

30.7 Applications for Sputtered Thin Films

Sputtered coatings are used for a wide variety of applications, some of which are listed below, according to the function performed by the thin film.

30.7.1 Electrical

Metals and alloys are used as conductors, contacts, and resistors, and in other components such as capacitors. Transparent conductors such as indium tin oxide and thin metals serve as electrodes for LCDs, touch panels, other display devices, and solar cells. Thin films are also extensively used in microelectronic devices.

30.7.2 Magnetic

Some high-performance magnetic data storage media are deposited via sputtering. Cobalt alloys such as cobalt–chromium and, to a lesser extent, nickel, iron, and samarium alloys are typically used.

30.7.3 Optical

Thin metal and dielectric coatings are used to construct mirrors, antireflection coatings, light valves, laser optics, and lens coatings, and to provide architectural energy control and optical data storage.

30.7.4 Mechanical

Hard coatings such as titanium carbide, nitride, and carbon produce wear-resistant coatings for cutting tools. Molybdenum sulfide serves as a solid lubricant.

30.7.5 Chemical

Thin film coatings can be used to provide high-temperature environmental corrosion resistance for aerospace and engine parts, catalyst surfaces, gas barrier layers, and lightweight battery components.

30.7.6 Decorative

Titanium nitride is deposited on watch bands and jewelry as a hard gold-colored coating. Metals are deposited for weight reduction in automotive and decorative graphics applications.

30.8 Additional Resources

The following professional societies include sections dealing with sputtered coatings: American Vacuum Society (offers short courses in sputtering and coatings), Society of Vacuum Coaters, Electrochemical Society, and Materials Research Society. Journals that cover developments in sputtered coatings include *Journal of Vacuum Science and Technology*, *Thin Solid Films*, *Journal of Applied Physics*, *Vacuum*, *Progress in Surface Science*, and the *Journal of the Electrochemical Society*.

Bibliography

- Bunshah, R. F. et al., *Deposition Technologies for Films and Coatings*. Park Ridge, NJ: Noyes Publications, 1982.
- Chapman, B., *Glow Discharge Processes, Sputtering and Plasma Etching*. New York: Wiley, 1980.
- Coutts, T. J., *Active and Passive Thin Film Devices*. New York: Academic Press, 1978.
- Maissel, L. I. and R. Glang, *Handbook of Thin Film Technology*. New York: McGraw-Hill, 1970.
- Vossen, J. L. and W. Kern, *Thin Film Processes*. New York: Academic Press, 1978.

31

Vapor Deposition Coating Technologies

31.1	Introduction	31-1
31.2	Physical Vapor Deposition.....	31-3
	Thermal Evaporation • Electron Beam Evaporation • Sputter Deposition in Plasma • Reactive Sputter Deposition • Cathodic Arc Deposition	
31.3	Chemical Vapor Deposition	31-16
	Thermal Chemical Vapor Deposition • Plasma-Enhanced Chemical Vapor Deposition (PECVD)	
31.4	Decorative and Barrier Coatings.....	31-22
	Decorative Coatings • Barrier Coatings	
31.5	Conclusions	31-28
	References	31-28

Lindas Pranevicius
Vytautas Magnus University

31.1 Introduction

For over 25 years, the thermal evaporation of aluminum onto thin polymeric webs, such as polyester (PET) and polypropylene (PP), has generated large volumes of barrier packing films, decorative films, capacitor films, and some window films. The experience of wide web handling was combined with deposition technologies, such as electron beam evaporation, magnetron sputtering, and plasma-enhanced chemical vapor deposition, to create a large number of new, exciting, coating materials, including oxides and nitrides of most elements. More particularly, combinations of these coating layers into a complex coating stack led to new products, such as low emissivity, solar heat reflecting, architectural glazing films, electrochromic devices, and high-performance optical reflectors. With these technologies, unique coating characteristics can be realized, e.g., transparent electrodes, flexible glassy barriers for moisture and gases, and amorphous soft magnetic materials for security devices.

To build highly functional components with vacuum-coated webs, severe quality standards should be employed for the flexible substrates used for vacuum coating. [Table 31.1](#) gives a survey of most substrates in use today.¹ Many different characteristics are important for further functionality after coating, e.g., mechanical tensile strengths, Young's modulus, surface finish, optical clarity (e.g., transparency haze), and resistance to corrosion and UV irradiation. Many special additional surface treatments have also become indispensable in attaining necessary product performance. [Table 31.2](#) lists most of the coating materials that have been used industrially to date. Recently, the technical availability of low-cost SiO₂ and Al₂O₃ coatings has created very interesting coating stack building blocks.²

Since 1980, tool coatings formed by physical vapor deposition (PVD) technologies have become a reality, and an industry has evolved around PVD tool coatings based on the work of the early pioneers in this field.³⁻⁶

TABLE 31.1 Flexible Substrates for Vacuum Coating

Polymer Films	Metal Foils	Others
Polyester (PET)	(Anodized) aluminium	Paper
Polypropylene (PP)	Copper	Nonwoven fabrics: glass fiber, carbon fiber, steel fiber
Polyimide (PI)	Carbon steel	
Polycarbonate (PC)	Stainless steel	
Polyethylene naphthalate (PEN)	Nickel	
Polystyrene (PS)	High temperature and corrosion	Aramid
Polyamide (PA)	Resistant steels (e.g., FeCr alloys)	
Polytetrafluoroethylene (PTFE)		
Polyethersulphone (PES)		
Polyetherimide (PEI)		
Polyetheretherketone (PEEK)		

TABLE 31.2 A Survey of Most Industrial Coatings

Metals	Alloys	Oxides	Nitrides	Others
Al, Zn	Stainless steels	ITO ($\text{In}_x\text{Sn}_y\text{O}_z$)	TiN	ZnS
Ag, Au, Pt, Pd	NiCr	SiO_x	Si_3N_4	MgF_2
Co, Ni	CoCr	Al_2O_3		Cr_2Si_2
In, Bi, Sn	Co/Ni glassy alloys	TiO_2 , Nb_2O_5		
Ti, Ta		ZnO, ZnO_2		SiC
Cu, Cr		Ta_2O_5 , Cr_2O_5		
Mo, W		SnO_2 , MgO		
Si		In_2O_3 , WO_3		

Mainly all PVD hard coating techniques are reactive processes, i.e., the metal species are vaporized, and a gas is fed into the coating chamber which reacts with the metal species to form the desired compound. In addition, all of the successful hard coating processes today involve ion-assisted deposition of the hard coating. The ion irradiation during deposition assures a fully dense, well-adhered hard coating. Prior to deposition, all substrates are given a sputter etch to remove any oxide layer, and heat is used to bring the substrate temperature to the 450 to 500°C range when high-speed steel (HSS) tooling is used.

Today there are four basic types⁷ of equipment in use for depositing PVD tool coatings, and they all fall under the broad category of ion plating. The differences between the four types are the way that the source material is vaporized, either by evaporation or sputtering; the way that the plasma is created; and the number and types of ions, electrons, and gas atoms that constitute the plasma. The four PVD hard coating techniques are low-voltage electron beam evaporation,⁸ cathodic arc deposition,⁹ triode high-voltage electron beam evaporation,¹⁰ and balanced and unbalanced magnetron sputtering.¹¹

Although there are many similarities between these four PVD processes, there are also many differences that can make a difference in the types of film that can be deposited in these systems. Each method has advantages and disadvantages, and no one method is best for all applications. The low-voltage electron beam evaporation process is very effective in ionizing the evaporating reactive gas atoms, and estimates¹² have put the amount of ionization at 50%. Low-voltage electron beam deposition is a very consistent process for producing a very hard and smooth TiN, which has become the industry standard.

Sputter deposition is one of the most complex methods and, in many cases, is more expensive. However, sputter deposition permits better control of the composition of multielement films and greater flexibility in the types of materials that may be deposited.

The primary deposition variables that determine the film growth kinetics, microstructural evolution, and, hence, physical properties of film grown from the vapor phase by techniques such as thermal or electron beam evaporation, chemical vapor deposition, and sputter deposition are the chemical state of

precursors; the incident precursor fluxes, kinetic energies, and trajectories; the film growth temperature; and the flux and chemical state of incident contaminants and the substrate material, surface cleanliness, crystallinity, and orientation. These represent the control variables that the film producer has at his or her disposal to tailor the properties of as-deposited materials. It is important to know that, in some cases, the contaminant flux competes with the flux of film material for incorporation during deposition, and it is strongly dependent upon the base pressure, pumping speed, and the design of the reactor vacuum system (e.g., whether the substrate load-lock is used to circumvent repeated air exposures), while substrate surface cleanliness also influences the predeposition processing.

The kinetic energy of the incident flux during growth by thermal evaporation is determined by the temperature of the evaporant source and is of the order of 0.1 eV. However, in plasma or ion beam deposition techniques, the kinetic energy of the incident flux can be increased up to several hundred eV. Low energy (often <100 eV) ion irradiation during vapor phase film growth has been shown^{13,14} to be useful in controllably altering the physical properties of as-deposited layers through trapping, preferential sputtering, enhanced atom diffusion, and dynamic collisional mixing.

The different methods of the formation of the vapor phase are widely described.¹⁵ When emphasizing the plasma and ion beam sputter deposition techniques, a brief overview of other vapor deposition techniques relevant to the subject of the review is helpful in establishing a proper perspective of the formation of multicomponent films by plasma and ion beam sputter deposition. The advantages and disadvantages of the techniques discussed in this review may vary depending on the particular material being incorporated in thin film.

Progress in thin film research is a remarkable example of the interplay between basic studies and practical applications. The demands for improved methods and properties have helped to drive new discoveries, which, in turn, have opened even more opportunities for applications.

Electronic devices, coatings, displays, sensors, optical equipment, and numerous other technologies depend on the deposition of thin films. Even when well-established methods exist for the production of high-quality films, there is still considerable interest in alternative methods that may be less expensive, more reliable, or capable of producing films with novel or improved properties. In this chapter, we focus on some areas in which new technologies are challenging established routes to making thin films.

31.2 Physical Vapor Deposition

31.2.1 Thermal Evaporation

The vast majority of web coaters used for capacitor and packaging applications have resistance-heated intermetallic boats as a coating source. The small boats are aligned in series to allow the coating of wide webs (up to 2500 mm in width), and the aluminum is provided to the boats by wire feeding.

This technology is limited to the evaporation of metals with relatively low melting points, such as aluminum and zinc. The major advantage of this coating method is that high web speeds of 8 to 10 m/s can be realized. The uniformity of the coating thickness is (slightly) “wavy” as a result of the effect of the boat array.

31.2.2 Electron Beam Evaporation

This technique has typically been implemented by using individual thermionically produced electron beams that are accelerated through 5 to 10 kV potentials, are magnetically deflected, and are then focused onto spatially separated elemental targets located in water-cooled holders symmetrically positioned in front of the substrate. Process parameters, particularly precise film stoichiometry and abrupt interfaces, are difficult to control because direct shuttering of individual beams near each source is difficult without disturbing the focused electron beam and thus quenching the target material evaporation. The evaporation of the elemental materials from different spatial locations involves complex hardware and tends to produce nonuniform films across large area substrates.

The availability of reliable, high-power, electron beam guns has opened up new potential markets for web coating. The electron beam guns can be programmed to scan a number of points with individual dwell times in a large crucible containing the material to be deposited. The maximum scan width is about 1 m, so that for wide web coating, several electron beams (usually two) in parallel are needed.

Electron beam technology is probably the fastest deposition source available today, reaching web speeds of 12 m/s and above. It is also, in theory, the most economical process. However, although it has the potential to replace resistance and induction heating in the aluminizing market, few of these machines are in use. The considerable investment cost, compared with a conventional coater, and the high degree of technical complexity, combined with some conservatism at the metallizers' end, have made it too large a step to take.

This coating source can handle most pure metals, including those with higher melting points. Alloys can be evaporated as long as the vapor pressures are not too far apart, e.g., Cr and Ni, as can several oxides, nitrides, for the occasional decomposition of the compounds.

Applications in use today include magnetic data storage media, transparent barrier coatings, and ultra-high-rate aluminization.

31.2.3 Sputter Deposition in Plasma

Sputtering involves the bombardment of a solid target of the material to be coated with ions extracted from a concentrated plasma cloud positioned very close to the target surface. High-energy atoms are dislodged from the target surface and directed toward the substrate.

Sputtering is a versatile technique with respect to coating options. It can be used for all pure metals and alloys, even the more complex materials. Also, most oxides and nitrides can be deposited with accuracy.

Virtually all thin film deposition technologies utilize the knock-on sputtering region, which is the most energy efficient. It is also technically more practical to sputter surfaces at energies less than 1000 eV range. This lessens the complexity in the power supplies, feedthroughs, and insulation, as well as reduces the safety risk of high voltages.

Physical sputtering by energetic neutrals is effectively the same as sputtering by ions. Because sputtering is effectively a momentum and energy transfer process, the electrical state (charge) on the incident particle is mostly irrelevant. In reality, ions are typically neutralized as they approach the surface (within a few Angstroms) and strike the surfaces as neutral. Therefore, the sputter yield of an ion and a neutral are indistinguishable. However, experiments used to measure the sputter yield have no reliable way to measure an incident neutral flux. Therefore, the topic is virtually ignored, although in some circumstances, it can lead to a significant underestimate of the rate of sputtering or deposition. The energy spectrum atoms emitted during the sputtering process differs significantly from evaporated atoms. Sputtered atoms have much higher kinetic energy than evaporated atoms. As an example, a sputtered Cu atom may have an average of 8 eV kinetic energy, whereas an evaporated atom has typically less than 1 eV. This energy difference results in differences in the resultant film properties, particularly density, microstructure, and adhesion.¹⁶

As a result of the intrinsic high particle energy, coatings realized with this technology generally show a superior adhesion to the substrate and dense crystallographic structures of excellent quality. Uniform coatings ($\pm 2\%$) can be deposited at widths well over 2.5 m.

Despite all of these advantages, the process is still considerably slower than the evaporation methods. In recent years, however, remarkable progress has been made with respect to speed. The standard planar magnetron configuration with its limitation of a moderate target efficiency of about 25% has been upgraded using computer-aided design magnet array structures to an optimized target utilization of over 50%. All these developments have led to sputtering machines with maximum web speeds of about 6 m/s.

The plasma provides an in situ source of "activated" gas and energetic ionic species that can be used to enhance various physical and chemical processes that can influence the growth and properties of deposited films. One of the motivating factors for the use of plasma-activated processes is the low-temperature requirement encountered in various applications. Plasma-assisted processes offer the pos-

sibility of deposition at relatively low substrate temperatures. The major roles of the plasma in various plasma-assisted processes are related to activation and enhancement of the reactions that are necessary for deposition compound films, and modification of the growth kinetics and, hence, modification of the structure and morphology of the deposits.

Due to the above consideration, plasma is used in a variety of physical and chemical vapor deposition processes.

The most commonly used techniques for plasma-assisted PVD are as follows: (1) sputtering, including direct current (dc), radio frequency (rf), triode, or magnetron geometries and reactive sputtering using dc, rf, triode, or magnetron sources; and (2) activated reactive evaporation.

The presence of the plasma in the source–substrate space significantly affects the processes occurring at each of these steps in film deposition, which are generation of species, transport from source to substrate, and film growth on the substrate.

Moreover, the effect of the plasma on the above three steps differs significantly between various processes. Such differences are manifest in terms of the types and concentrations of the metastable species, ionized species, and energetic neutrals that, in turn, influence the reaction paths or steps involved in the overall reaction of film formation and the physical location of these reaction sites. Moreover, it should be noted that the ionizing probability is maximum for electrons in the range of 50 to 60 eV and decreases with further increase in energy. It is, therefore, advantageous to have low-energy electrons for ionization of the gas and vapor species.

31.2.3.1 Diode Plasmas

The dc-diode plasma device is the simplest form of a plasma used for sputtering and sputter deposition. The system consists of a cathode, an anode, a dc power supply, and an enclosure. The interrelation between gas density, electrode spacing, and applied voltage needed for the breakdown of the gas and the formation of plasma is given by Paschen curves.¹⁷ Only a tiny fraction (about 0.01%) of the gas atoms are ionized — the majority are neutral. The electrons in the plasma are relatively hot, with a Maxwellian energy distribution and an equivalent thermal temperature of 10,000 to 50,000 K. The electron temperature is usually described with energy units (eV), where 1 eV is about 11,600 K.

Because the plasma is conductive, there is virtually no potential gradient with the plasma itself. All of the electric fields occur at the edge of the plasma in a region called a sheath. Due to the large proportion of neutral gas atoms to ions, the ions are in thermal equilibrium with the gas atoms (through collisions) and are only at a temperature in the range of 100 to 1000°C. And due to the much higher electron temperature and lower mass, the electrons move rapidly around the plasma. This last effect results in the appearance of several different potentials within the system.

The plasma potential is the apparent voltage on the bulk of the plasma away from the sheath. The floating potential is the potential reached by an electrically isolated object immersed in the plasma. It is also the potential (on any surface, conductive or not) at which the arriving ion and electron fluxes are equal. The floating potential is always the negative of the plasma potential, typically by a factor 3 times the electron temperature.

For objects floating electrically in the plasma, the energy is usually less than 20 eV and causes little sputtering. For a surface such as the cathode, the ion energy is equal to the difference between the plasma potential (a few more volts positive than the anode) and the cathode voltage. These energies can be several hundreds of eV and will cause significant sputtering of the cathode surface. Therefore, a sample to be coated with a thin film of sputtered atoms could be located on the anode surface or virtually anywhere within the chamber.

Dc-diode plasmas are characterized by low etching and deposition rates. The reason for the low rates is a low plasma density due to a cross for electron-impact ionization that is fairly small. Therefore, to get a high plasma density and, hence, a high ion bombardment rate, the gas pressure must be increased to pressures near 133 Pa. In addition, the voltages needed for moderate currents are fairly high, several kV. The resultant sputtered atoms are rapidly scattered by the background gas, and the net deposition rate on a sample surface is fairly low.

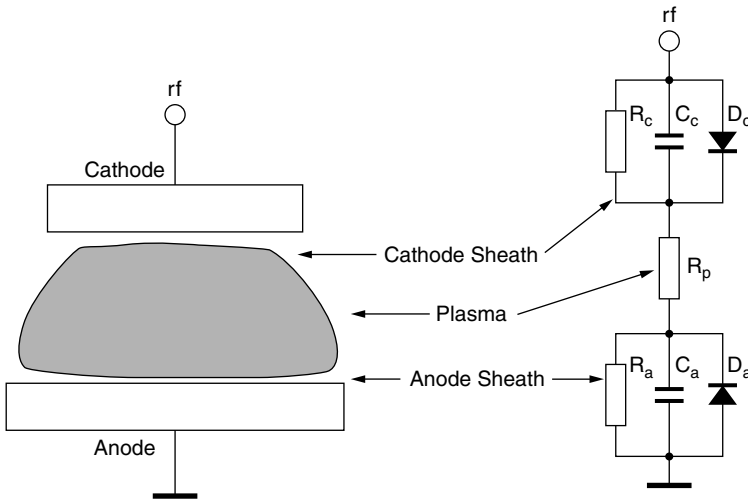

FIGURE 31.1 The rf excitation system: R_a and R_c — anode and cathode sheath resistances; R_p — plasma resistance; C_a and C_c — the geometric sheath capacitances.

Dc-diode sputtering is also constrained by the requirement that the electrodes must be metallic conductors. If one of the electrodes is insulating, it charges rapidly, and additional current is suppressed. This effect can occur if a reactive gas, such as oxygen or nitrogen, is introduced into the plasma, resulting in the oxidations of metal surfaces on the electrodes. Therefore, dc-diode sputtering is not an appropriate technology for the deposition of most compounds and dielectrics.

By operating the plasma diode with an ac potential, rather than dc, these problems can be overcome (Figure 31.1). At the most commonly used frequency of 13.6 MHz, there is little voltage drop across the insulating electrode or layer. The electrodes will not charge up, and therefore, it is possible to sputter dielectrics or reactively sputter metals. There is an additional degree of ionization with an rf-powered plasma due to additional energy transmitted to the plasma electrons at the oscillating sheath. The net result is a higher plasma density, compared to dc-powered plasmas, and the ability to operate at lower system pressures (0.5 to 120 mPa).

The cathode of a typical rf-diode system is usually powered through an impedance-matching device known as matchbox. The function of the matchbox is to maximize the power flow from the rf generator, which has an output impedance of 50 ohms, to the plasma, which has a complex impedance usually in the 1000 ohm range. A series capacitor is included in the matchbox to allow the formation of a dc bias on the cathode. This occurs due to the higher electron mobility and results in a negative dc potential on the powered electrode of up to one-half applied rf peak-to-peak voltage. The ions in the plasma that are accelerated to the cathode are too massive to respond to the 13.6 MHz fields and respond only to the dc bias.

The most common application of rf-diode sputtering is for the deposition of dielectric films. Often, the sample surface is biased slightly during the deposition to provide some level of ion bombardment that results in changes to the density and microstructure of the films and some degree of resputtering that leads to increased planarization.

31.2.3.2 Magnetically Enhanced Plasmas

Electrons in a magnetic field are subjected to Lawrence force, which in a homogeneous magnetic field perpendicular to the electron motion would cause the electron to move in a circular path with radius, known as the Larmor radius. In the direction of the magnetic field, there is no net magnetic force, so the electrons are unconfined. The net result is that electrons tend to spiral along magnetic field liners in a helical path. By constraining the electron to this motion, the effective path length of the electron is increased significantly, and hence, the probability of an ionizing electron-atom collision is increased. For

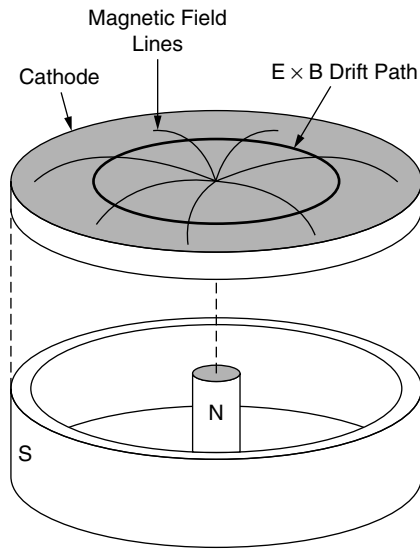

FIGURE 31.2 Circular planar magnetron showing an expanded view of the pole-piece configuration. Water cooling is not shown, but it typically occupies the volume between the cathode and the back of the pole-piece assembly.

a given applied power, then, the effect of the magnetic field is to reduce the plasma impedance, resulting in higher discharge currents at lower voltages. The increased density also allows significant reductions in the background pressure, such that the magnetically enhanced plasmas can operate at pressures as low as the 10^{-2} Pa range.

Magnetrons are the most common form of magnetically enhanced plasmas. In the device, a magnetic field is configured to be parallel to the surface of the cathode. There is a resulting electron drift, caused by the cross-product of the electric and magnetic fields (known as an E-cross-B-drift) that tends to trap electrons close to the cathode surface. The drift motion is directional, and in a magnetron it is configured to close on itself. A common example of this is shown in Figure 31.2, for a circular geometry, and is called a circular planar magnetron. In this case, the magnetic field is configured to be radial pole and a perimeter, or ring magnetic pole.

The magnetron device, which is defined as having a closed-loop $E \times B$ drift path for the secondary electrons, has been developed in a number of geometries.¹⁸ Perhaps the most common alternative is to use a rectangular configuration, known as a “racetrack” magnetron (Figure 31.3). This geometry has some intrinsic advantages for the automated handling of parts.

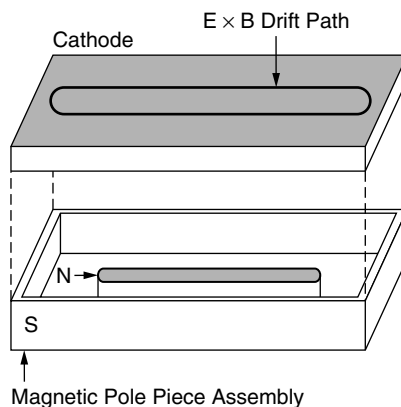

FIGURE 31.3 A rectangular or racetrack magnetron.

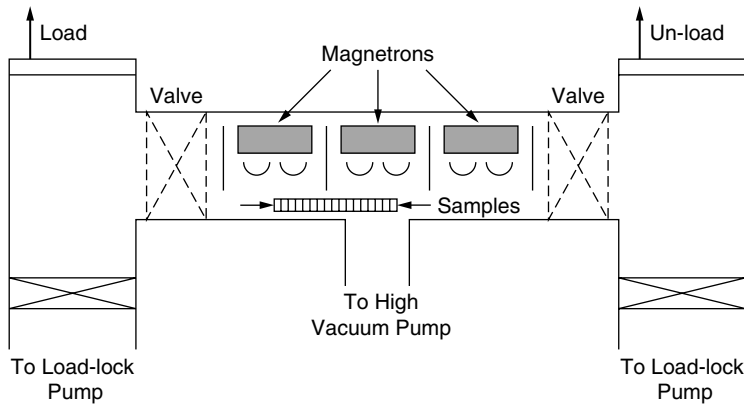

FIGURE 31.4 An automated in-line system based on rectangular planar magnetrons.

Magnetron plasmas have a unique feature in that the secondary electrons are strongly constrained to the region near the cathode surface. This causes dense plasma to form near the cathode in the region of the drift loop. The dense plasma results in very high levels of ion bombardment of the cathode surface and, hence, high rates of sputtering. The high-rate ion bombardment is localized on the cathode directly under the $E \times B$ path. The resultant sputter emission of atoms is also localized, which means that deposition uniformity is usually not good. Therefore, for most deposition systems, it will be necessary to either move the sample or alter the magnetron location to attain good deposition uniformity. In addition, the erosion of the cathode is also localized, which results in poor utilization of the cathode material, as deep grooves are eroded into the cathode surface in the vicinity of the $E \times B$ drift path. The wide grooves are called the “etch track” and are characteristic of magnetron sputtering. Typically, only 10 to 15% of the cathode material can be used before the grooves start to etch through the back of the cathode.¹⁹

At high pressures, the distribution of sputtered atoms is smeared out due to gas scattering and deposition homogeneity increases, but the cost is a real reduction in the sputtered atom's kinetic energy and a potential change in the film properties. There are two obvious solutions to the nonuniformity. The first is to move the sample in some way to average the deposition over the sample surface. For circular planar magnetrons, this requires a fairly complicated planetary motion. The alternative, using conventional rotating-sample motion, is to use deposition shields located between the cathode and the sample, which effectively collect the sputtered flux locally. This process, however, reduces the net deposition rate over the entire sample to the lowest level of the original distribution.

For rectangular or other elongated magnetrons, the solution for increased uniformity is to translate the samples past the magnetron perpendicular to the “long” direction of the cathode. An example is shown in Figure 31.4, which shows a rectangular magnetron system viewed end-on, in which the samples move from one end of the system to the other. The dimensions of these systems on a manufacturing scale can be rather large. A common size uses cathodes 2 m in length in a sputtering system with an overall length that exceeds 20 m.²⁰

For some industrial applications, in particular those where contamination is a critical concern, it may not be desirable to move the samples during deposition. In this case, magnetrons have been developed that have a moving etch track.²¹ Over time, the eroded area is fairly uniform, and a high degree of uniformity can be obtained when depositing films on large, stationary substrates. The moving etch track is set up by rotating the magnet assembly in the cooling water behind the cathode face. An industrial cathode of this design might have a diameter of 25 cm and be rated at a power of 25 kW. The second important advantage of these magnetrons is that the utilization of the cathode is very efficient: up to 80% of the cathode material can be used for sputtering, compared to 15% for a nonrotating magnetron. This results in much better efficiency and longer time periods between cathode changes. Because of this

intrinsic efficiency, this type of magnetron is becoming more common and is being used in such varied applications as hard coatings and roll or web coating.

31.2.3.3 Unbalanced Magnetron Deposition

The balanced magnetron sputtering has one peculiarity. It has a strong decrease of the substrate ion current with increasing distance of substrates from the magnetron target. It limits the possibilities to activate the substrate during deposition.

In principle, there are two possible ways to increase the ion current density on substrates in magnetron sputtering, i.e., by (1) additional gas ionization, for instance, by a hot cathode electron beam or a hollow cathode as a source or (2) a magnetic confinement of plasma, for instance by an unbalanced magnetron.^{22,23}

In an unbalanced magnetron, a conventional magnetron is intentionally configured with an array of magnetic pieces or coils that add an additional vertical component to the magnetic field at the cathode. Three common configurations are shown in Figure 31.5. The first two configurations (Figure 31.5a and Figure 31.5b) are based on additional permanent magnets in the pole-piece configuration behind the magnetron cathode. In the first case, the central pole piece has been made much stronger than the

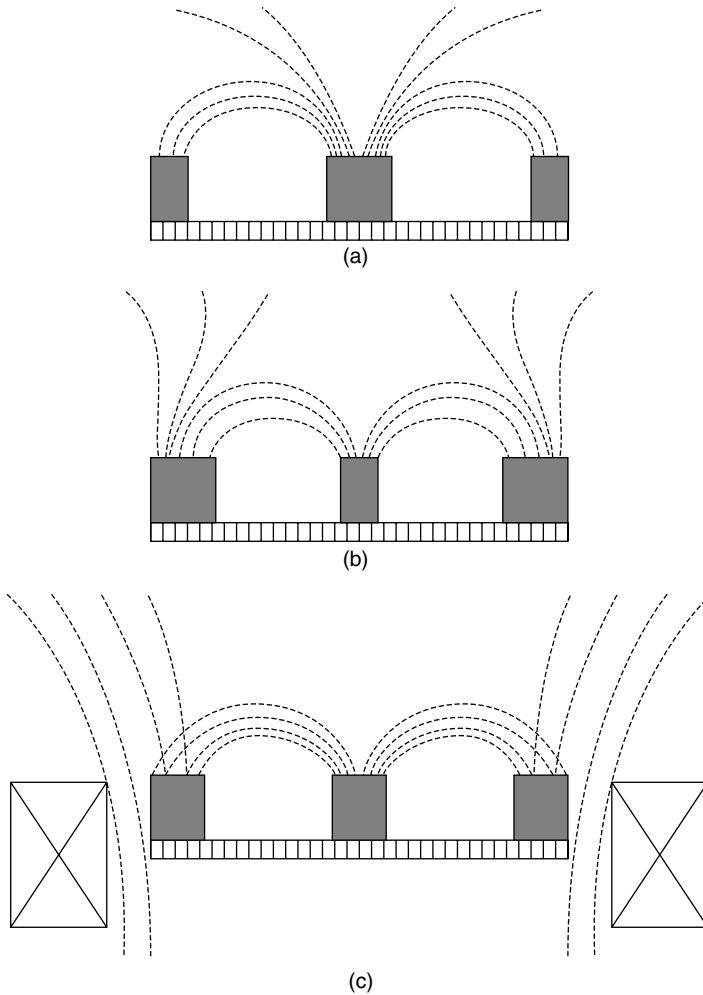

FIGURE 31.5 Unbalanced magnetrons: (a) with a strong axial pole, (b) with a strong perimeter pole, and (c) with an additional electromagnet.

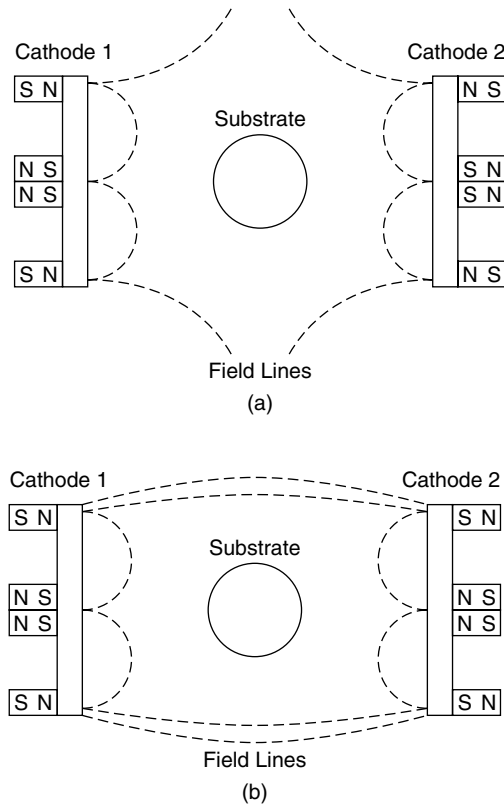

FIGURE 31.6 The mirrored and closed-field magnet configurations: (a) mirrored, where like poles face each other; (b) closed field, where opposite poles face each other.

perimeter pole piece, resulting in an additional axial field. In the second case, the perimeter pole has been made stronger, resulting in an additional cylindrical component to the field. In the third case (Figure 31.5c), an electromagnet has been added externally to the magnetron to provide a simple axial field.

The unbalanced magnetrons are characterized by the addition of magnetic field lines that are no longer constrained between the central and perimeter pole pieces of the magnetron. Additional field lines leave the region of the magnetron and intersect the sample region. Electron motion along these field lines is unconstrained by the $E \times B$ trapping effect near the cathode and is actually enhanced due to the drift of electrons from high-strength magnetic field regions to lower strength regions. As a result, electrons can leak away from the near cathode region. This sets up a very weak potential that tends to draw ions from the cathode region out to the near-sample region. It is these ions that can then be used to form the basis of a sample bias necessary for the enhancement of the TiN reaction.

Titanium nitride has extensive applications in the commercial world for hard and decorative coatings. The unbalanced magnetron approach has been used successfully on a manufacturing scale for the production of TiN and related compounds. To cover large numbers of parts, or else to cover large parts with unusual shapes, systems are often configured with multiple magnetrons within a single chamber.²⁴ A simple example of this is shown in Figure 31.6, where two unbalanced magnetrons have been configured across from each other, with the sample placed in the middle. The magnetrons can be configured to be coupled or repelling, which results in a significant difference in the observed bias current densities at the sample.

In sputtering systems equipped with unbalanced magnetrons, high ion current densities can be transported to substrates, which are even greater than the magnetron current. If the magnetic field of unbalanced magnetron reaching substrates is sufficiently strong (several mT), the discharge strongly differs

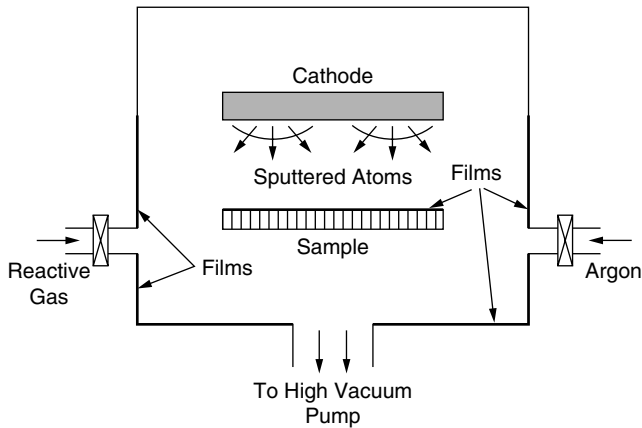

FIGURE 31.7 A reactive deposition chamber.

from that in a weak magnetic field. Such discharge can be sustained at both the magnetron and substrate sites, and so it is called the double-site-sustained discharge.

The sputtering systems with double-site-sustained discharge allow the production of dense, compact, bright golden TiN films with microhardness greater than 2200 kg mm^{-2} and good adhesion (a high critical load up to 64 N) even at pressures as high as 5 Pa and substrate voltage $U \approx -40 \text{ V}$ and in the range of target to substrate distance 200 mm . The latter is comparative with distances typical for ion plating systems with a low-energy electron beam or arc evaporation sources. Nevertheless, the pressure and bias ranges used for sputtering are not common for electron beam and arc techniques.

31.2.4 Reactive Sputter Deposition

Reactive sputtering is widely used for producing coatings of compounds.^{25,26} Metal is sputtered from a pure target, and sufficient reactive gas is added to the process to form the desired compound at the substrate (Figure 31.7). Reactive sputtering is often an undesired artifact of sputtering in the presence of an air leak or a high background pressure of water. In each case, the film is altered from the desired purity by the incorporation of gas species.

As a reactive gas is added to this process, the gas atoms combine with depositing film atoms to form compound films of varying stoichiometries. At this point, even though additional gas is being added to the chamber, there is no rise in chamber pressure, because all of the gas atoms are absorbed by the films. With increasing flow of the reactive gas, the films become more reacted, and eventually, at a sufficiently high reactive gas flow, the films reach their “final” reacted state. This is typically a stable, or “terminal,” compound. Once this point is reached, additional reactive gas atoms cannot be absorbed by the depositing film. Now, any additional flow of reactive gas results in the formation of a reacted, compound film on the cathode surface. This compound almost invariably has a lower sputter yield than the pure metal cathode, which results in a reduction of the rate of metal atoms sputtered from the cathode. Reducing the rate of metal deposition reduces the rate at which the film can absorb the reactive gas, further increasing the residual background of the reactive species. This, in turn, causes additional reaction at the cathode surface, which reduces the metal sputtering rate even farther. In effect, the cathode undergoes a transition from a metallic to a compound state, and the deposition process slows dramatically. This can be seen in Figure 31.8, in which the deposition rate is plotted as a function of increasing reactive gas flow (Figure 31.8a), and the chamber pressure is plotted in Figure 31.8b.

The severity of the hysteresis effect can be reduced by increasing the pumping speed of the system such that the quantity of gas removed by the pumps is much greater than that consumed chemically.²⁷ In this way, the destabilizing pressure swings at the target are greatly reduced when the target changes from the metallic to the compound mode. Increasing the pumping speed can eliminate hysteresis, but

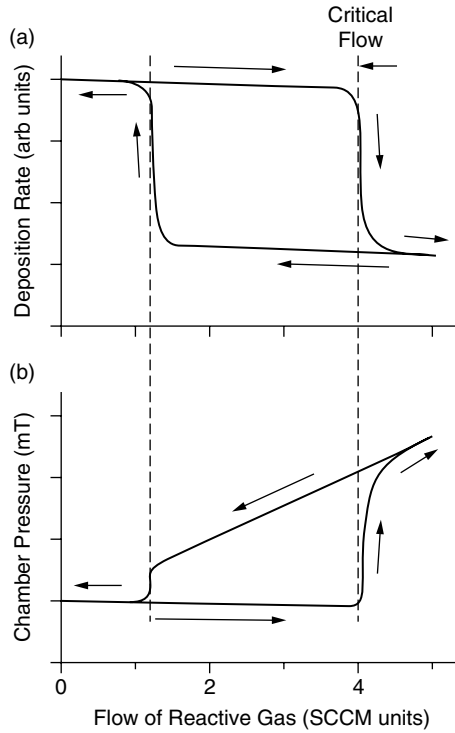

FIGURE 31.8 Hysteresis curves for the deposition rate (a) and the chamber pressure (b) for the case of reactive sputtering.

it is costly in terms of the expense of added pump capacity and increased gas consumption. The added gas flow has the advantage of reducing contamination from vessel outgassing and leaks through dilution.

Through partial-pressure control of the reactive gas, it is possible to produce all material compositions in spite of the hysteresis effect. If the reactive gas partial pressure is held constant at the same time that the power to the sputtering target is held constant, a balance between consumption and availability of the reactive gas is maintained. The partial pressure sets the flux of gas atoms at every surface. If the partial pressure is controlled, the availability of that gas will be controlled. If there is a process disturbance, such as an arc on the target, a partial-pressure controller will momentarily reduce flow to maintain constant partial pressure. Once the plasma is reestablished (after the arc is quenched) and the metal is being sputtered at the full rate, the flow will once again be increased to maintain the desired partial pressure. In partial-pressure control, there is inherent stability. The removal of material from the target is nearly constant except for perturbations such as arcs, and at the substrate, the metal and gas atoms arrive in the proper ratio to produce the stoichiometric compound.

Partial-pressure control requires a species selective means of monitoring the gases in the process chamber in real time. The most frequently used piece of equipment is the quadrupole mass analyzer, which has the ability to separate gases by their mass ratios and which generally provides a unique signal for each gas present. Good partial-pressure control is achieved when an adequate signal-to-noise ratio is obtained by the analyzer in a time frame that is short enough that the flow can be adjusted before the inherent process instabilities take the partial pressure too far from equilibrium.

To form the stoichiometric compound, the arrival rate of metal atoms must be matched by an appropriate arrival rate of the desired reactive gas atoms at the substrate. If these arrival rates are not balanced, the resulting film will not be of the desired composition. By controlling the partial pressure of the reactive gas in the region of the substrate, it is possible to maintain the required arrival rate of gas atoms so that, when they are combined with the arriving metal atoms, the proper material phase is produced.

The partial pressure of the reactive gas should be controlled closely so that wide variations in pressure are not experienced. Even short periods of low pressure result in gas deficits that will produce several monolayers of metal-rich composition, while a short-term overabundance will lead to lower deposition rates and possibly the formation of an undesired phase. These regions of nonstoichiometric composition will reduce the performance of the coating and, generally, are the cause of early coating and possibly part failure.

Maintaining a constant metal arrival rate is not always easy. A well-conditioned metal target in a pure argon atmosphere will have a constant metal removal rate if the power to a magnetron sputtering target is constant. This constant metal removal rate at the cathode translates into a constant transport rate to the substrate and a constant flux of available metal.

There are different methods to increase the energy of arriving atoms. The simplest one is to bias the sample to a negative voltage during deposition. The bias causes ions from plasma to be accelerated to the sample, depositing additional energy in the near-surface region. The required level of ion bombardment scales with the deposition rate. For high-rate depositions (up to a $\mu\text{m}/\text{min}$ or so), the required bias current density approaches $2 \text{ mA}/\text{cm}^2$. High levels of bias current are, unfortunately, difficult to achieve with conventional deposition systems considered above. The plasma is confined close to the cathode, which is desirable for high-rate sputtering of the cathode, but this results in an inability to draw ions to the sample region many centimeters away.

31.2.5 Cathodic Arc Deposition

The cathodic arc deposition technique is one of the important PVD methods, successfully used mainly for the preparation of hard, wear-resistant coatings for tools and different mechanical parts.^{28,29} It has many good properties, such as high ionization and good homogeneity of coatings on substrates of complex shape, but it also suffers from some drawbacks. Its main disadvantage is the formation of macroparticles, which leads to a deterioration of the quality of the deposited coatings.

Arc deposition technique is based on the physics of arc that can be sustained over a wide range of ambient gas pressures from vacuum to several bars. According to the type of emission of electrons from the cathode arc, discharges are defined as those with heated cathodes, thermionic cathodes, hollow cathodes, cathode spots, or distributed current. Electrodes of arc discharges are exposed to high fluxes of energetic particles. Therefore, arc discharges can be used for electrode material evaporation.

The cathode can be evaporated in cathode spots (arc discharge with a “cold” cathode) or in broad active cathode regions (distributed arc). In these cases, the arc creates a conducting medium necessary for sustaining the discharge by intensive evaporation of the cathode material.

Spots on metal cathodes are of different types, depending on time, cathode material and its purity, and other factors. The spots in a stationary condition (10 to 100 μm diameter) are characterized by their tendency toward spontaneous disintegration, their chaotic movement on the cathode surface with speeds of about 1 to 10 m/s, and their extinction. At small currents (about 1 to 100 A), all arc current is concentrated in one spot. At higher currents, the spot divides, and two or more spots exist.

An external magnetic field strongly influences the behavior of arc discharges with cathode spots. It increases the discharge stability and also influences the direction and velocity of cathode spots. The magnetic field can be used to localize cathode spots on the cathode surface and to control the shape of the trajectories of cathode spots.

Evaporation of material in cathode spots arises as a consequence of the high local cathode surface temperatures and the formation of small molten pools due to a very high concentration of power density (up to 10^{10} Wcm^{-2}). The evaporated material is ionized in collisions with electrons and accelerated away from the cathode due to a nonuniform potential distribution and plasma expansion. The flux of dense plasma (about 10^{13} to 10^{14} cm^{-3}) contains electrons, ions, atoms, and microparticles (0.1 to 100 μm) in the form of droplets. The flux of evaporated material and the content of individual components depend on many parameters, e.g., the cathode material and its purity, the temperature of the cathode surface, the total arc current, and the composition and pressure of the working gas.

The spatial distributions of particles, which is of great importance because it determines the homogeneity of the coating on large area substrates, are very different. Macroparticles are emitted mainly in the cathode plane, ions are emitted mainly perpendicular to the cathode surface, and the spatial distribution of particles emitted from a cathode of high melting material is close to a cosine distribution.

Each cathode spot produces a high velocity jet of highly ionized cathode material. The ion current component in the plasma jet ranges from about 7 to 12% of the total arc current. Ions move mainly in the direction normal to the cathode, and the speed of the directed movement is considerably higher than that of chaotic thermal movement. High ion content in the evaporated flux is sometimes used to construct efficient high current metallic ion sources. The energy of the ions is in the range of 1 to 100 eV. However, the energy decreases with increasing gas pressure due to collisions with gas particles. The flux of evaporated material also contains multiple-charged ions.

Macroparticle generation is an integral part of cathode spot operation. There are several processes that can result in formation and acceleration of macroparticles: Joule heating accompanied by explosive evaporation; material fracture by thermoelastic stresses; expulsion of weakly bonded material by a high local electric field; and expulsion of material by ion and plasma pressure.

Once generated, the macroparticles are heated, accelerated, and negatively charged by their contact with the cathode spots plasma jets.

While macroparticle inclusions are clearly deleterious in most microelectronic and optical applications, they may be neutral or even possibly beneficial in other applications. Macroparticle generation can be reduced by using magnetically induced cathode spot motion, reduced cathode current density, and effective cooling to reduce the cathode surface temperature in the vicinity of the cathode, and by the presence of a reactive gas forming high melting point surface layers on the cathode. The macroparticle spray can be filtered from the plasma flow using correct geometric placement, substrate bias, and magnetic collimation and direction of the plasma flow. The last method has been successfully implemented by a number of investigators in the form of quarter-turn turns, and high-quality, macroparticle-free coatings of metals, ceramics, and diamond-like carbon have been produced.

The separation of macroparticles from the plasma flux is based on the significant differences that exist in the basic parameters of ions, atoms, and macroparticles, e.g., the velocity or the charge-to-mass ratio. The separation according to the charge-to-mass ratio is based on the control of ion movement in magnetic and electric fields and can be realized in different systems.

The cathodic arc evaporation exhibits the following important features: high ionization of metallic particles (up to 100%), high kinetic energy of emitted ions (40 to 100 eV), and high evaporation efficiency and low effect of reactive gas on the evaporation rate.

These features, together with operating and user benefits, such as simple construction of evaporator, the simple low voltage power supply units, operation of the evaporator in any orientation, and the high utilization of cathode material, are the main advantages of this deposition technique.

The substrate can be heated by radiation, heat conduction from the substrate holder, or accelerated particles (electrons, gas phase, and metallic ions). Accelerated ions with energy levels over the threshold energy for sputtering (10 to 25 eV) cause a sputtering of the substrate surface of the growing film. This means that deposition takes place simultaneously with ion bombardment of growing film. The sputtering rate depends on the ion energy, the types of ions, and the substrate material. Usually, ion energy is given by a negative substrate bias of about 0.2 to 2 kV. Significant differences exist in sputtering with gas-phase and metallic ions.

The sputtering with gas-phase ions includes sputtering, particle trapping or implantation, mixing, and particle diffusion (thermal or radiation enhanced, e.g. ion nitriding). The sputtering with metallic ions includes self-sputtering condensation of metal, implantation, mixing, and diffusion. Some problems can occur in the sputtering of multicomponent substrates when the sputtering rates of components are very different. This results in changes of the composition, topography, and roughness of the sputtered surface. A schematic of the cathodic arc plasma deposition system is shown in [Figure 31.9](#).

The properties of the deposited films depend on the energy and fluxes of all the impinging particles (metallic and gas-phase atoms and ions), the substrate material, and the substrate deposition temperature.

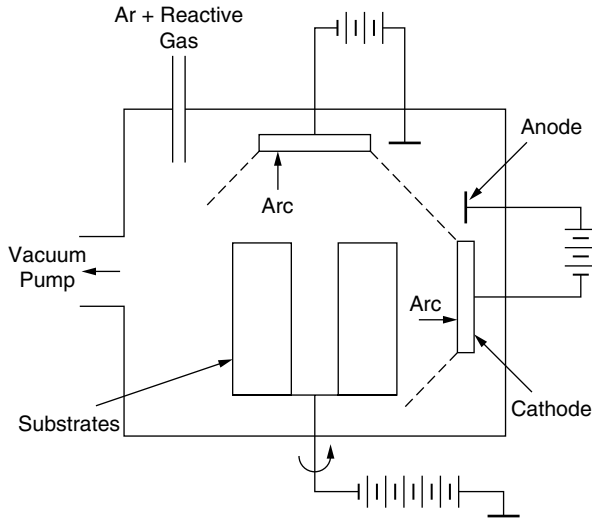

FIGURE 31.9 Cathodic arc plasma deposition.

High-density titanium films without microvoids can be produced during bombardment with 50 eV ions at an ion to neutral particle flux ratio F_i/F_n of about 0.2 or higher. This is easily satisfied with the cathodic arc deposition technique; therefore, this method is suitable for the deposition of high-density films. The reactive gas pressure (flux of reactive gas F_r) influences the evaporation rate due to formation of compounds on the cathode surface and the film stoichiometry that depends mainly on the ratio F_m/F_r , i.e., the metal to reactive gas flux.

The uniformity of the film depends mainly on the uniformity of the flux of the metal gas F_m and flux of ions F_i on differently oriented substrate surfaces. At low pressures of the working gas, when the mean free path is larger than the substrate to cathode distance (collisionless regime), the fluxes F_m and F_i are strongly nonuniform. An improvement of the deposition uniformity can be reached at higher pressures of the working gases where collisions of evaporated atoms and ions with gas particles play a dominant role (diffusion regime).

Arc evaporation is successfully used for the deposition of hard coatings such as nitrides and carbides of titanium, zirconium, molybdenum and chromium, Al_2O_3 films, and diamondlike carbon films. The properties of the films deposited by arc evaporation are mainly influenced by two factors: the high ionization, high energy, and high flux of metallic particles, and the emission of particles from the cathode. The microstructure of the film mainly depends on the energy of the impinging particles, which is determined first by negative bias voltage V_s . For $V_s = 0$, the TiN coating structure is coarse grained and columnar. This is a consequence of the low ion bombardment and low substrate temperature. At $V_s = -400$ V, partial epitaxial growth has been observed. The surface structure of TiN coating consists of a large number of rounded concave depressions, the formation of which is not fully understood. The number and size of the depressions are strongly sensitive to the deposition parameters, and their formation may be related to the flux and penetration depth of impinging ions.

The preferred orientation of films can also be strongly modified by bias voltage. Experiments show that randomly oriented TiN films are formed at low ion energies. At medium energies (100 to 500 eV), films have a strong (111) texture, and at high energies (1 keV and higher), (220) orientation is dominant.

With regard to the composition of films prepared by the reactive deposition process, it is difficult to ensure that the ratio F_m/F_r remains constant over a large coated volume and on complex shaped substrates. This practically excludes the creation of substoichiometric films with the same composition on all substrate surfaces. Therefore, industrial deposition systems usually work in a regime of saturation (with an abundance of the reactive gas), and films are almost stoichiometric. Experiments show that the stoichiometry of TiN films is 1.0 ± 0.06 over a wide range of nitrogen partial pressure (0.4 to 6 Pa). This

can be explained by the high reactivity of nitrogen with titanium on the substrate surface due to high activation energy supplied by the incoming ions and the preferential resputtering of excess nitrogen in the growing film.

The adhesion of hard TiN coatings prepared by arc evaporation is very high, and critical loads up to 10 N on HSS can be achieved. This is probably due to interface formation during ion etching.

Although TiN films are the most commonly used hard coating, other nitrides and carbides have been studied, e.g., ZrN³⁰ for cutting of titanium alloys, HfN,³¹ and TiCN.³² Arc evaporation can be used for alloy evaporation, e.g., TiAl, TiZr, and TiHf.³³ The evaporated flux has the same composition as the cathode alloy, but the film composition can be different due to preferential resputtering.

The incorporation of macroparticles into the growing film is a very serious problem. The macroparticles negatively influence many properties of the coatings, e.g., friction, wear and corrosion resistance, reflectivity, etc. Therefore, the number of applications for coatings deposited by cathodic arc deposition technique is, so far, relatively low.

31.3 Chemical Vapor Deposition

31.3.1 Thermal Chemical Vapor Deposition

The three main chemical vapor deposition (CVD) techniques are thermal CVD, plasma-enhanced CVD (PECVD), and laser CVD (LCVD). All of them need volatile precursors, the chemical composition of which is changed during the deposition process. In thermal CVD, the precursor forms a deposit when it comes into contact with a hot surface. In PECVD, the vapor of the precursor is decomposed by contact with the plasma. This might have already happened in the gas phase, or the precursor is adsorbed at the substrate and subsequently decomposed by the bombardment of charged particles or photons. In LCVD, the precursor is decomposed in a photochemical process or by pyrolysis when it comes into contact with a surface that has been heated by laser.

Laser CVD opens new opportunities, including localized deposition and tailoring of reaction pathways. CVD technology opens possibilities of preparing new materials and structures for various applications. The scope of this part of the chapter is to consider the CVD activated by physical affections in the form of plasma (PECVD). For the thermally activated CVD, the reader is referred to the literature.^{34,35}

The following precursors and overall reactions are used for CVD of TiC, TiN, and Al₂O₃:

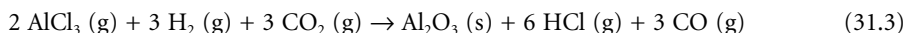

For CVD, a fully dense coating, heterogeneous reactions occurring on the substrate surface are required. In addition, homogeneous reactions in vapor are required in many processes. In these reactions, species that can adsorb are generated; thus, these reactions prepare the gas species for the heterogeneous deposition reactions. For CVD of the compounds given above, heterogeneous reactions are needed. In CVD of TiC, TiN, and Al₂O₃, generation of CH_x, NH₃, and H₂O, respectively, in the vapor is important. This means that an experimental setup favoring the homogeneous reactions should be used. In that case, a hot-wall CVD reactor is preferred. In a cold-wall reactor, these reactions are suppressed, and the deposition rate will be reduced considerably.

In the conventional high-temperature CVD process, which is used widely today, single and multiple layers of TiC, TiN, HfN, and Al₂O₃ are deposited onto tools at temperatures between 900 and 1100°C. Coating deposition rates depend on the temperature and the partial pressure of the gases in the reactor. [Figure 31.10](#) shows a schematic diagram of such a reactor.

Higher temperatures favor higher coating rates but also result in coatings with coarse grains and lower hardness. Additionally, the tendency to decarburize and embrittle the carbide substrate through the

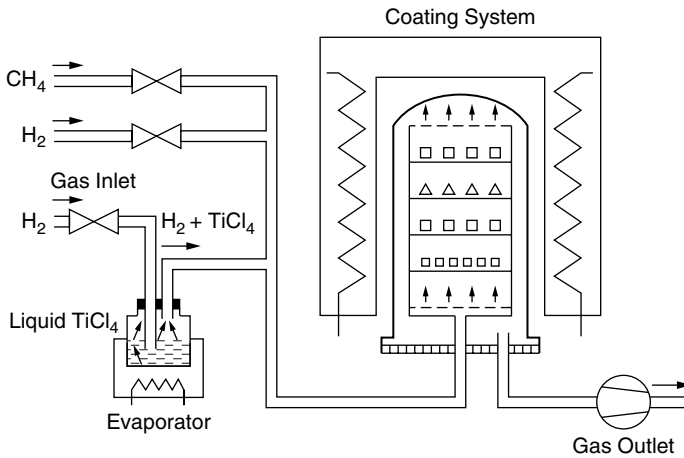

FIGURE 31.10 A CVD coating system.

formation of η phase is promoted by the higher coating temperature. A solution of the toughness problem was found by applying coatings of TiN and HfN, and later, multilayer coatings of TiC–Ti(C_xN_y)–TiN, without forming η phase at the coating–substrate interface.

The moderate-temperature CVD can be accomplished by using an organic precursor. The moderate-temperature process permits the deposition of Ti(C_xN_y) coatings in a temperature range of 700 to 900°C. An organic precursor is the source for carbon and nitrogen and is more effective than CH₄ and N₂ used in high-temperature CVD.³⁶ The reaction for moderate-temperature CVD is



By combining this new coating technology with special substrate materials, new grades for milling — both dry and with coolant — were developed and represent a technological breakthrough in this field. The outstanding performance observed is primarily due to the reduction in thermal load on the substrate material, to the absence of brittle phase, and to the excellent bonding of the coating to the substrate.³⁷

31.3.2 Plasma-Enhanced Chemical Vapor Deposition (PECVD)

CVD and PECVD can use the same precursors, but there are differences resulting from the mechanism of deposition. CVD uses high temperatures, and consequently, thermodynamic processes govern the nature of the resulting deposit. The same precursors react in PECVD at temperatures several hundred degrees Celsius lower, and the deposition processes are controlled by kinetics. The lower deposition temperatures might be an advantage for sensitive substrate materials or might cause the formation of metastable phases of the deposit. For example, yttria-stabilized zirconia (YSZ) can be prepared by PECVD using the tetramethylheptanedionato complexes, Zr(thd)₄ and Y(thd)₃, as precursors. According to the phase diagram, the cubic phase of YSZ is stabilized at 1000°C by 10 to 40 mol% Y₂O₃ and at 500°C by 15 to 30 mol% Y₂O₃. Deposits by PECVD³⁸ at 500°C form the cubic phase in the range 3.5 to 80 mol% Y₂O₃ and keep this structure when annealed at 900°C for several hours. The extended range of compositions offers the possibility to adjust the lattice constant over much wider ranges of YSZ than would be possible with other techniques.

Apart from microelectronics, a very strong motivation for the development of new systems came from the field of hard and protective coatings. Many materials formed by this technology reached an advanced state of perfection. New precursors, coatings, and deposition techniques are continuously developed. It is not possible to cover all recent results. Some of the possibilities of the plasma techniques and the use of organometallics³⁹ will be demonstrated by selected examples. Current knowledge regarding the true

nature of the chemical reactions involved in the plasma CVD process is insufficient. The most significant mechanisms involved will shortly be discussed.

All materials necessary for the deposition of coating (e.g., TiN) are fed into the reactor as gases (e.g., TiCl_4 , H_2 , N_2 , Ar) in the same way as in conventional CVD. The creation of species that can be deposited is achieved by decomposition of the process gas in a glow discharge. Because the plasma volume reactions are necessary for the creation of species deposited, the process steps cannot be clearly separated. The radicals generated and the excited species are mostly polyatomic particles. Their kinetic energy corresponds to the temperature of the process gas. In many cases, the creation of these species takes place at the first contact of the process gas with the plasma. Therefore, the initial spatial distribution of the radicals created will be determined by the gas inlet and distribution system and by the geometrical shape of the plasma region.

In the most frequently used ranges of pressure (10 to 10^3 Pa) and the mean residence time (0.1 to 1 s), the gas flow can be described as slow, viscous, and laminar. The mean free path of the species in the process gas, a small fraction of a millimeter, is much smaller than the dimension of the flow channel. Typical diffusion times are a few milliseconds. Therefore, the transport of the radicals to the substrate is dominated by diffusion and gas flow.

The plasma volume reactions are complex because of the large number of different species and possible reaction channels. One important process is the decomposition of the polyatomic carrier gas by electron impact dissociation. The energetic electrons also generate some free radicals and ions that are able to decompose the neutral carrier gas and polyatomic radicals by radical–molecule and ion–molecule reactions. The efficiency of the decomposition of the process gas is usually very high. Often, 10 to 100% of the carrier gas fed into the reactor can be decomposed.

The formation of the coating takes place on the substrate and on the film surface by absorption of radicals, by chemical bonding to the neighbor atoms on the surface, and by desorption of volatile compounds. The temperature as well as the bombardment of the coating by photons, electrons, and ions can influence the film growth. The ions, especially, can gain significant energy in the cathode fall. This leads to higher mobility of the atoms at the surface and to sputtering of weakly bonded atoms.

For technical realization of plasma CVD process, two parts of the deposition system are of great importance, namely, the glow discharge configuration and the gas inlet and distribution system. As a power source, dc, pulsed dc, rf, or microwaves can be used. For the deposition hard coatings, especially TiN, planar electrode systems powered by dc, pulsed dc, or rf are usually used.

The standard equipment for PECVD is a parallel reactor (Figure 31.11) with two electrodes of 10 to 60 cm diameter and a spacing of a few centimeters. In commercial equipment for anisotropic etching, the substrate-bearing electrode is smaller (to build up a self-bias), while for deposition, both electrodes have the same diameter. In deposition experiments, it is sometimes advantageous to use an asymmetrical arrangement. The temperature control of the substrate-bearing electrode is important. For simplicity of construction, this electrode normally is grounded. More versatile devices have the heated electrode insulated to take advantage of this bias. Apart from the parallel plate reactor, there are occasionally arrangements used that separate plasma from the substrate.

The equipment surrounding the reactor depends mainly on the vapor pressure of the precursor. If this is high enough, distillation or sublimation can be simply carried out from a thermostatted reservoir (Figure 31.11). If the precursor has to be heated to reach the required vapor pressure, all tube connections have to be heated to avoid condensation. For substances that are difficult to vaporize, the tubes connecting the vaporizer and the reactor should be as short as possible.

Films coated using CVD techniques show excellent step coverage and adhesion to the base metal. In general, they have the disadvantage of needing high process temperatures to form ceramic films. In contrast, the PVD technique provides films with good adhesion at low temperatures, although its step coverage capability prevents the uniform coating of ceramics over base metals with complicated shapes. A remarkable expansion of plasma CVD technique application could be expected if the PECVD technique could be used at temperatures as low as those used by the CVD technique and if it produces highly adhesive films.

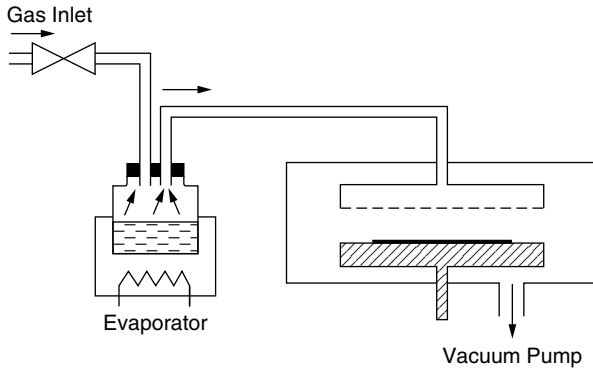

FIGURE 31.11 Parallel plate reactor.

To attain highly adhesive coatings at low temperatures, the triode method is developed⁴⁰ using a grid electrode (Figure 31.12). The grid electrode, set between the anode and the cathode, is 20 mesh stainless steel, and rf power is applied to it. The anode electrode is the gas feeder and is connected to ground. The cathode electrode is the substrate holder, and a dc bias voltage is applied to the substrate and to the cathode.

Of special importance for uniform deposits and high deposition rates is the vaporization of the precursor. Most compounds are transported by a flow of carrier gas passing over it. In flow systems, the partial pressure of the precursor in the gas stream is far below the equilibrium pressure. The actual value might be as low as 1/1000 of the equilibrium pressure and depends on the size of the crystallites and the level of substance in the reservoir.

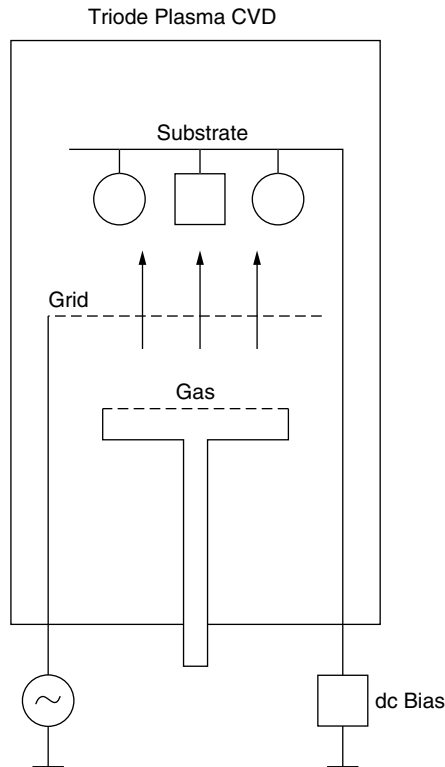

FIGURE 31.12 The triode plasma CVD system.

TABLE 31.3 Acetylacetonate and Its Modifications^a

acac	CH ₃ - CO - CH ₂ - CO - CH ₃
fta	CH ₃ - CO - CH ₂ - CO - CF ₃
hfa	CF ₃ - CO - CH ₂ - CO - CF ₃
thd	(CH ₃) ₃ C-CO - CH ₂ - CO - C (CH ₃) ₃
tpm	(CH ₃) ₃ C - CO - CH ₂ - CO - CF ₃
ppm	(CH ₃) ₃ C - CO - CH ₂ - CO - C ₂ F ₅
fod	(CH ₃) ₃ C - CO - CH ₂ - CO - C ₃ F ₇

^a See also J. Narayan, N. Biunno et al., in *Laser and Particle Beam Modification of Chemical Processes on Surfaces*. A. W. Johnson, G. L. Loper, and T. W. Sigmond, Eds., *Mater. Res. Symp. Proc.*, 129, 425 (1989).

Steady evaporation is easier to realize with liquid precursors. Bulky and asymmetrical substituents lower the melting points. Sometimes the introduction of a single methyl group lowers the melting point sufficiently. For example, (C₅H₅)₂Zr(CH₃)₂ is a solid, whereas (CH₃-C₅H₄)₂Zr(CH₃)₂ at room temperature is a liquid and is, thus, much easier to apply. Of all parameters, the partial pressure of the organometallic compound is the most difficult to control. In most experiments, its rate of vaporization is determined by the weight loss of the reservoir during the experiment. The partial pressure is then estimated from the flow and pressure data of the other gases. This procedure is uncertain, because some substances decompose when kept at the temperature of vaporizer. In such cases, its temperature has to be continuously adjusted. To realize this, the gas stream can be monitored by mass spectrometry or the optical emission from the discharge can be used.

For achieving reasonable deposition rates in PECVD, the precursor should have a vapor pressure of at least 10 Pa at room temperature, or it should withstand heating without decomposition until such vapor pressure is reached. Some elements form halides or hybrids that meet this condition (e.g., WF₆ or SiH₄), but the majority of elements of interest for hard coatings and for other applications form no volatile inorganic compounds. However, carbon compounds from all elements are known, and of these, some are quite volatile.

Little is known about volatility or thermal or photostability of organometallics, but recently, some concepts on structure–volatility relationships have been developed. To improve the volatility, the tendency of the molecules to associate has to be reduced. This can be achieved by introducing bulky groups, by using asymmetric substituents, and by introducing fluorine atoms instead of hydrogen. For example, in the series of β-diketonates, the volatility increases from acac to fod (Table 31.3). The use of organometallics for PECVD is reviewed in the literature.^{34,41–43}

Tetramethylene is used extensively to form volatile alkyl compounds of various metals (aluminum, gallium, indium, silicon, germanium, tin, and lead). PECVD in Ar–H₂ leads to tin films; with Ar–O₂, SnO₂ is formed. Similar results are formed for germanium and indium.

The carbonyl compounds of iron, cobalt, nickel, chromium, molybdenum, tungsten, and manganese have been used in PECVD.³⁴ Ni(CO)₄ and Co₂(CO)₈ in thermal CVD yield pure metallic films; in PECVD, the deposits are contaminated by carbon and oxygen. Only by careful adjustment of the parameters and the use of H₂ as the carrier gas can metallic films be made. The carbonyl compounds of chromium, molybdenum, and tungsten yield films that contain various amounts of oxygen and carbon. For example, films made from Mo(CO)₆ in argon plasma have a composition of MoC_{0.1}O_{2.5} in H₂–Ar of MoC_{0.3}O_{0.3}. The reason for this is the dissociation of CO₂ into CO and carbon; the latter is incorporated into the growing film.

π-Complexes have sufficient volatility for CVD applications. Complexes with alkyl ligands might be quite volatile. In particular, (π-C₃H₇)Pd(π-C₅H₅) and (π-C₃H₇)₂Pd by PECVD are converted into palladium films.⁴⁴

The interest in oxide films stimulates the development of β-diketonates. The acetylacetonates are not very volatile but are used in some cases (copper and aluminum). The hfa and the htd complexes have

TABLE 31.4 The Vickers Hardness of Various Compounds^a

Compound	HV 00.5	Compound	HV 00.5	Compound	HV 00.5
TiC	3000	ZrC	2700	HfC	2600
VC	2900	NbC	2000	TaC	1800
Cr ₃ C ₂	1350	β-Mo ₂ C	1500	WC	1200–2500
TiN	2100				
VN	1580	ZrN	1600	HfN	1700
CrN	1100	NbN	1400	TaN	1150
Cr ₂ N	1580				
TiB ₂	3400	ZrB ₂	2250	HfB ₂	2900
VB ₂	2100	NbB ₂	2600	TaB ₂	2500
CrB	2140	MoB	2500	WB	3750
CrB ₂	2100	MoB ₂	2350	W ₂ B ₅	2600
TiSi ₂	950	ZrSi ₂	1025	HfSi ₂	975
TaSi ₂	1250	MoSi ₂	1290	WSi ₂	1200

^a See also W. Buechner, R. Schliebs, G. Winter, and K. H. Buechel, *Industrielle Angewandte Chemie*: Weinheim: Verlag Chemie, 1984.

found wider application because of their higher vapor pressure. Thus, Cu (acac)₂ needs a temperature of 140°C, Cu (thd)₂ –110°C, and Cu (hfa)₂ only 40°C to reach a sufficiently high vapor pressure.⁴⁵

The oxygen in the diketonater limits their use. Only chelates of the late transition metals (e.g., copper or palladium) can be converted into metal films: all others tend to form the oxides. When flourine-containing ligands are used, the deposits might be a fluoride (iron and nickel). The diketonates of yttrium, barium, copper, and the rare earths⁴⁶ have been studied in order to prepare superconducting oxide films.

There are many publications devoted to the analysis of the properties of their films and coatings formed by PECVD. TiN, which is widely used as a hard coating, is studied in many publications. It is normally prepared by CVD from TiCl₄. Because of the problems involved with the use of halides as precursors, CVD work is looking for alternatives. Table 31.4 shows a number of other materials that might be equally attractive as TiN. As follows the carbides of titanium, zirconium, hafnium, vanadium, niobium, and tungsten, the nitrides of zirconium and hafnium and several borides, cubic BN, SiC, Al₂O₃, and diamond show very interesting properties.

The metallic oxide, nitride, boride, and carbide films are obtained using PECVD. Copper, silver, palladium, gold, platinum, rhodium, and their alloys films have been prepared in recent years.^{47,48} Most precursors of these elements when decomposed in argon or Ar–H₂ plasma yield shiny metallic films, but they very often include carbon contamination. To deposit the pure metal, it is necessary to remove all organic ligands. To achieve this, the deposition rate should not be too high, and substrate temperature and bias have to be properly adjusted. Precursors of niobium, molybdenum, tungsten, iron, cobalt, nickel, zinc, indium, and tin have been treated in a H₂ and H₂–Ar plasma. Their deposits show considerable contamination by both carbon and oxygen.

For hard coatings, metallic films do not serve directly, but their softness makes metals useful as intermediate layers. If the thermal expansion coefficients of substrate and coating do not match, temperature changes might cause cracks or the separation of bulk and coating. Intermediate layers of a soft metal such as nickel can greatly improve the adhesion in such systems. W(CO)₆ under certain conditions yields tungsten films with a few percent of carbide. It is known that the hardness of tungsten increases from 4 to 8 Mohs where there is some carbon in the lattice.

Oxide films are easily prepared by PECVD, because the ligands can be removed completely by oxidation. Almost all volatile organometallics can be used to prepare oxide films. These processes are carried out in O₂ or Ar–O₂ mixtures. Some oxygen-containing precursors such as Cr(CO)₆ and Ti(OR)₄ form oxides directly. Most research on oxides has been aimed at high T superconductors (barium, strontium, yttrium, and copper), semiconductors (tin and indium), and optical fibers (silicon, boron, and germanium).

As hard coatings, Al₂O₃ and ZrO₂ might be of interest, their hardnesses being 9.5 and 7 to 9, respectively, on Mohs scale. Al₂O₃ films can be prepared from several precursors. The alkyl compounds AlR₃ are very

TABLE 31.5 Organometallic Precursors for TiN^a

Formula	Vaporizer Temperature (°C)	Substrate Temperature (°C)
Ti(N(CH ₃) ₂) ₄	70	200–300
Ti(N(C ₂ H ₅) ₂) ₄	100–110	300
CH ₃ -Ti(N(C ₂ H ₅) ₂) ₃	70	400
Cp ₂ Ti(CO) ₂	70	300
(CH ₃ -Cp) ₂ Ti(CO) ₂	80	400

^a See also J. Narayan, N. Biunno et al., in *Laser and Particle Beam Modification of Chemical Processes on Surfaces*. A. W. Johnson, G. L. Loper, and T. W. Sigmond, Eds., *Mater. Res. Symp. Proc.*, 129, 425 (1989).

sensitive to oxygen and water and will form oxides even with hydrogen as the carrier gas, because small leaks supply enough oxygen for their reaction. Other aluminum compounds are easier to control. Al(acac)₃ and Al(O-C₃H₇)₃ can be vaporized at 170°C.³⁴

To prepare ZrO₂ films, several precursors have been tested.⁴⁹ Cp₂Zr(CH₃)₂ was vaporized at 80°C and yielded stoichiometric ZrO₂ films at substrate temperatures of 300°C or above. Zr(OCH(CH₃)₂)₄, with pure argon as a carrier gas, formed ZrO₂ films with the vaporizer at 160°C and substrate temperatures of 300°C. Of the diketonates, Zr(hfa)₄ can be vaporized at 60°C and deposited at 25 to 150°C, but the deposit seems to be an oxyfluoride rather than the oxide. When Zr(thd)₄ is used as the starting material, only at high temperatures (400°C) and high power densities (5 W cm⁻²) are pure ZrO films obtained.

TiN and other nitrides have been widely studied. The CVD of TiN at temperatures of 800 to 1000°C makes posttreatments of the substrate necessary. By PECVD, TiN has been deposited at lower temperatures using TiCl₄. Several organometallic titanium compounds have been tested as precursors for the deposition of TiN films (Table 31.5).

Films deposited from compounds 1 and 2 initiated in Table 31.5 contain about 60 wt% Ti, 15 to 25 wt% C, and only 5 wt% N. Compound 3 yielded films with 8 to 21 wt% C and 4 to 9 wt% N. Compound 4 led to films with 70 wt% Ti and 20 wt% C, but they decomposed in part during distillation. Compound 5 with H₂ as the carrier gas deposited films with 55 wt% Ti and 6 to 9 wt% C. All five precursors are possible precursors for CVD. The possibilities of borides as hard coatings have been pointed out in several reviews.^{50,51} Such films, in most cases, are prepared by sputtering or thermal CVD of the halides. With these techniques using temperatures in the vicinity of 1000°C, TiB₂ has been prepared from TiCl₄ + BCl₃ + H₂ at 480 to 650°C by PECVD.⁵² Recently, there has been increasing interest in the formation of cubic boron nitride. Coatings of this compound have been prepared by PECVD starting with B₂H₆,⁵³ B₁₀H₁₄,⁵⁴ and BHAL₃.⁵⁵

Carbides are also promising as hard coatings. The best chance of forming carbides is to have compounds that contain only the metal, carbon, and hydrogen. The neogentyl derivatives of titanium, zirconium, and hafnium that form carbides by CVD form carbides by PECVD.³⁴

31.4 Decorative and Barrier Coatings

31.4.1 Decorative Coatings

Initially optical coatings have been deposited simply by evaporating the compound using either a resistant-heated or an electron beam evaporation source. The coatings thus produced are invariably nonstoichiometric. To improve the stoichiometry and, thus, the refractive index of the coatings, the reactive evaporation technique was subsequently used. Next, plasma-enhanced evaporation techniques were developed to obtain better control of stoichiometry. One such technique called the activated reactive evaporation process, discussed earlier, has been used to deposit a variety of optical films. High-threshold optical films of TiO₂, ZrO₂, and HfO₂ have been synthesized.⁵⁶

While color is an essential characteristic of any decorative coating, hardness is of second importance. A compromise often has to be accepted when matching both aspects. In the literature,⁵⁷ significant

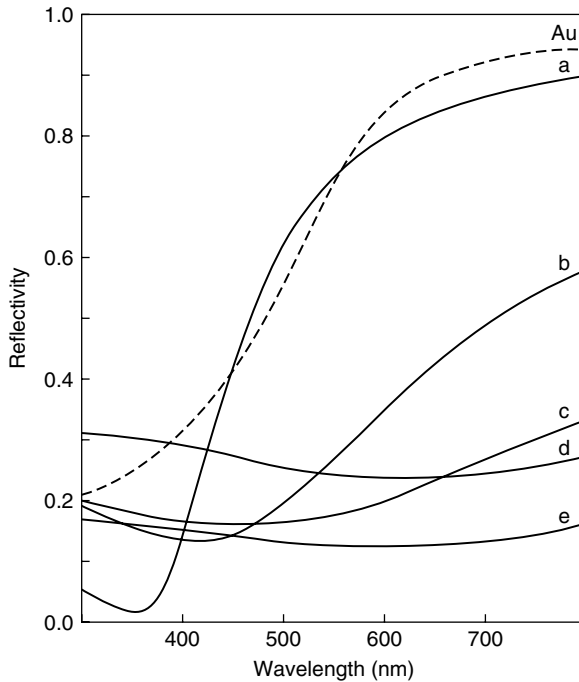

FIGURE 31.13 Reflectivity spectra of some decorative hard coatings: (a) gold-yellow ZrN; (b) bronze-colored TiN_{1+x} ; (d) and (e) bluish black Ti (N, O) and black Ti (N, O, C). Dotted line: 24 carat gold.

deviations of color from gold-yellow to brown, violet, reddish, and grey were described in the TiC–TiN–TiO ternary system. This was observed on bulk samples obtained by high-temperature sintering, and consequently very close to the 50:50 composition. According to this data, all compositions with the binary system TiN–TiO are yellow; by admixing some TiC, the color goes through brown and blue toward metallic grey. Somewhat different results are obtained by PVD, because of the low substrate temperature, nonequilibrium compositions with large deviations from stoichiometry are readily obtained. Compositions where the sum of nitrogen and oxygen is less than 50% are light yellow or even metallic white, while a small excess of these two components gives dark tones with increasing optical absorption.

X-ray spectra indicate that no real solid solubility takes place at low-temperature synthesis. It is supposed that a large excess of nitrogen or oxygen is not incorporated into the basic cubic structure but is deposited on defect sites of a highly perturbed lattice and in grain boundaries, thus increasing the optical absorption.

The reflectance spectra of ZrN- and TiN-based coatings, obtained by reactive magnetron sputtering, are presented in Figure 31.13.⁵⁸ Closely stoichiometric ZrN coatings have gold-yellow color. The TiN-based coatings with the increased amounts of oxygen and nitrogen have been studied. Two effects have been observed: the surplus of nitrogen reduces the reflectivity on the long-wavelength side; the coatings become darker yellow (old gold) and then bronze colored. The reflectance minimum, situated in the near-UV for yellow samples, is shifted to longer wavelength. Oxygen addition combined with excess nitrogen acts in the same direction, reducing the red-side reflectivity to very low values. Due to displacement of the minimum, the blue-side reflectance increases, neutralizing the red and yellow component and giving blackish, or even bluish, tints. Carbon additions act essentially by further lowering the total reflectance, giving still darker black. More recently, some other binary and ternary systems have been explored, when titanium is substituted by aluminum and vanadium.

Activated reactive ion plating processes are used to produce well-adhering, dense nitride, carbide, and oxide films at relatively low substrate temperatures. They are in commercial use to produce films for optical applications.

TABLE 31.6 Optimal Properties of Ion Plated Films^a

Film Material	Refractive Index (550 nm)
Nb ₂ O ₅	2.40 ± 1
Ta ₂ O ₅	2.23 ± 1
ZrO ₂	2.20 ± 1
HfO ₂	2.17 ± 1
Si ₃ N ₄	2.06 ± 1
Y ₂ O ₃	1.95 ± 1
Al ₂ O ₃	1.66 ± 1
SiO ₂	1.485
SiO _x N _y	1.5–2.0

^a See also J. Narayan, N. Biunno et al., in *Laser and Particle Beam Modification of Chemical Processes on Surfaces*. A. W. Johnson, G. L. Loper, and T. W. Sigmond, Eds., *Mater. Res. Symp. Proc.*, 129, 425 (1989).

With ion-plated oxidized processes, no absorption can be measured with simple photometric intensity methods in the high transmittance range. Measurements of the refractive indices of the films give values close to those of the bulk material. In all cases, the refractive indices are much higher than those of evaporated films. Various values are listed in Table 31.6 for comparison.

The optical characteristics remain constant even during repeated heat treatment cycles. Heating ZrO₂-SiO₂ and Ta₂O₅-SiO₂ multilayers on glass for several hours at 400°C and, subsequently submersing them in water for 3 days produces no change in optical and mechanical properties.

The matching of optical and mechanical properties requires that some compromises would have been made. This is particularly true when color from the gold-yellow tints is changed to dark, obtained due to the overstoichiometric composition. From very high values (over 2500 VH) in the case of yellow coatings, the hardness can be as low as 1000 VH for very dark ones. This is still acceptable as protection from wear by friction of cloths or by conventional cleaning products.

It is obvious that adhesion has to be “ideal,” i.e., no peeling should appear, even on deep scratching. In plasma-assisted PVD methods, adhesion is usually good. The adhesion depends not on the coating alone but also on the substrate. The hardest coating will behave poorly when deposited on a soft metallic substrate because of the very limited resistance to shock and scratching. Simultaneously, problems with corrosion proofing may arise; coatings may not be continuous and pin-hole free as deposited or may become discontinuous after being exposed to mechanical damage.

An ideal case is represented by the combination of a cemented carbide substrate (watch case) with a hardness of 1500 VH or more, but of a dull grey color, coated by gold-yellow TiN or ZrN, even harder than this (2500 to 3000 VH). This solution is unfortunately very expensive.

There have been attempts made to improve the situation by first using low-pressure plasma nitriding in an intensified glow discharge to obtain a hardness gradient within the first microns beneath the surface of alloyed steel substrates, and then by depositing a TiN or ZrN coating, further increasing the hardness and the corrosion resistance.

Direct deposition of hard coatings on brass and similar soft alloys results in dull coatings and in poor protection from scratching and shock. A hard chromium undercoat with a thickness of many microns, deposited by well-known electrochemical methods, gives an acceptable solution.

Activated reactive ion plating processes are becoming more important for optical applications. Ion bombardment during deposition causes cascades of atomic collisions in growing film. The recoiled and displaced atoms cause a kind of continuous atomic mixing and also enhance surface migration. This results in the filling up of voids and in smoothed or graded grain boundaries. Another result of ion bombardment is a high concentration of point defects. These are frozen in the structure under growth conditions that are comparable to rapid quenching. High compressive intrinsic stress is the direct consequence of these defects.

In wear protection applications, density, high adhesive strength, and compressive stress are features underlying the huge success of these thin brittle films. Adhesive strength is needed to compensate for the buckling forces caused by the high compressive intrinsic growth stress, and this stress is needed as a mechanical prestressing that is relaxed by the mechanical load placed on the films in actual use. The consequence of this prestressing is the fact that as long as the deformation of the substrate remains in the elastic range, such loads do not damage the film.

A thermal compressive stress is added when the thermal expansion coefficient of the film is less than that of the substrate and when the film was deposited at a temperature higher than or equal to the maximum expected operating temperature. The thermal stress also relaxes in use when operating temperature is higher than room temperature, which is normally the case.

Optical films produced in processes without ion bombardment show properties associated with low mobility of condensing atoms and molecules due to their low thermal energies of between 0.1 and 0.2 eV. As no current can flow in or on an insulating substrate, ion bombardment of such substrates or films requires that exactly the same number of positive and negative charges impinge onto every point of the surface in order to achieve charge balance.

Plasma-assisted ion plating makes use of the negative self-biasing potential that does not only occur on the surface of thin insulating substrates placed on an rf electrode. In dc plasmas, the big difference between the mean velocities of the electrons and the ions in the plasma causes a self-bias potential of more than 10 V with respect to the plasma. This bias accelerates positive ions toward the substrate surface. Their energies are usually not sufficient to cause sputtering, but they are nevertheless at least 50 times higher than the thermal energies of the vapor atoms and molecules and are higher than crystalline binding energies.

Dissociation is a problem with compound films. Even in evaporation, which is the gentlest PVD process, chemical compounds are dissociated to a certain extent. Due to their low sticking coefficient, gaseous components can be pumped off, resulting in substoichiometric composition of the deposited film. In reactive deposition, the gaseous components are continuously replaced. Because of the high reactivity of oxygen, only oxide films have been successfully produced industrially by reactive evaporation. Oxides or suboxides are used as evaporation materials, and the oxygen partial pressure in the chamber is stabilized at about 10^{-2} Pa using a controlled gas inlet valve. The actual oxidation takes place to a great extent on the substrate surface. The chemisorption rate of oxygen is the critical factor for the completion of the reaction.

Nevertheless, optical coatings produced by reactive evaporation alone are often still slightly substoichiometric and thus slightly absorbing. These films have rough surfaces and columnar or spongy microstructures with large void volumes and great internal surface areas. As a consequence of the low density, the refractive indices of these films are considerably lower than the values of the bulk oxides. These films absorb water vapor and other gases from the atmosphere that change the refractive index and other physical properties. Their adhesion to the substrate is poor, and their abrasion resistance and hardness are low. It is possible to improve most of these properties by heating the substrates to about 300°C before reactive evaporation. Substrate heating is, in fact, a standard procedure in this process.

Many years of experience have shown that bombardment of the growing film with predominantly film-forming species of atoms has many advantages. Therefore, the combination of ion plating with those activated reactive evaporation processes in which the coating material is activated using anodic or cathodic evaporation sources results in a process yielding superior results. The activated reactive ion plating includes not only the biased activated reactive evaporation process, but also the three most important industrial PVD processes for the deposition of wear-resistant coatings. They are based on arc discharges, i.e., gas discharges in which most of the electrons are generated by electron emission from a hot cathode spot. After ignition, this hot spot may be maintained by ion bombardment heating (self-sustaining arc), or it may be initiated, maintained, and localized by an independent energy source such as a heated filament (thermionic arc). Working conditions (pressure, temperature) when depositing on various metallic objects are often such that a typical columnar structure appears. One of the consequences of this type of texture is the microscopical roughness, which is approximately proportional to the coating thickness. In the case

of decorative coatings, which are generally thinner than those deposited, for example, on cutting tools, this phenomenon is not pronounced, but it appears when the fresh surface is touched with fingers. Fingerprints cannot be wiped away by simple rubbing because of traces of greasy deposits in the microscopical depressions between single columnar crystals. This roughness, representing, in the worst case, up to 10% of the total coating thickness, can be drastically reduced under conditions where equiaxial texture is favored. It is well known that intense low-energy ion bombardment during activated reactive ion plating creates favorable conditions for such a texture and thus more brilliant surfaces.

In order to move the gold-colored stoichiometric nitrides, additional quantities of nitrogen, oxygen, or even carbon have to be incorporated into the coating.

When nitrides alone are deposited, the final nitrogen content is roughly proportional to the partial pressure of the gas present. To obtain darker-colored oxynitrides, the simplest way is to start with a yellow nitride and add some oxygen. The affinity of both titanium and zirconium for this gas is markedly higher than for nitrogen, the first gas is more quantitatively gathered by the metal vapor than the second. One result is that relatively small quantities of oxygen are needed.

Obviously, carbon cannot be introduced in elementary form. One possibility is to use gaseous hydrocarbons. Partial splitting of hydrogen from these molecules leaves free radicals behind. The probability that such radicals react between themselves, creating new organic molecules, is higher than the formation of metal carbides. A series of organic syntheses takes place in the plasma, seriously contaminating the chamber and condemning the next experiment to fail in the reproduction of color. A partial solution to this problem lies in the use of carbon oxides, unavoidably giving oxycarbonitrides, or even carbon-halogen compounds, provided the pumping unit is compatible with these gases.

Precise quantitative prescriptions for obtaining various colors are evidently impossible. Parameters adapted to every coating system have to be found out experimentally by trial and error. Further development trends point toward new binary or ternary compositions, giving new colors and potentially even better mechanical and chemical properties.

31.4.2 Barrier Coatings

Advances in source and materials technology for high-speed, vacuum, and web-coating operations have produced several products of interest to the converting industry, including transparent glass-barrier coatings and antiabrasion/antireflection coatings for windows, solar cells, and packaging film and sheet. Plastic films with glass-barrier coatings produced by plasma deposition and plasma polymerization processes are providing new alternatives in the coatings industry.

Antiabrasion/antireflection coatings on plastic film should have these physical properties: refractive index in the range of 1.3 to 1.4 (the lower the better); thickness of 0.25 wavelength of visible light, at least for the top layer if the material is multilayered or has a graded refractive index; hard surface; low coefficient of friction; and weather and pollution resistance for glazing applications.

The source and the deposition environment are designed to suit the desired material, material structure, and coating grade. For barrier and antiabrasion/antireflection coatings made at high speed from oxides, three plasmas are employed: a plasma to clean the substrate and provide the polar surface necessary for good nucleation and adhesion, a plasma near the source to ionize a large portion of the deposited material to provide the energy for adatom mobility and close packing, and a plasma to anneal the coating for closer packing.

The coating process usually takes place at a high vacuum to avoid interaction of background gases and the material being deposited. High vacuum helps to avoid substrate heating by electrons and photons. Because well-nucleated, low-lateral stress oxide barriers have about 5% elongation, they can be processed by web-handling machine rollers. Poor nucleation leads to nonbarrier, columnar structures, even though the coatings are amorphous. An order-of-magnitude increase in barrier properties of plasma-activated CVD of SiO_x on polyester can be obtained with a plasma pretreatment of helium or methane. The pretreatment is preferably done in-line but does not eliminate the need for corona treatment at atmospheric pressure.

High vacuum in plasma-activated CVD processes prevents gas-phase nucleation, and in electron beam deposition processes, low pressure allows adatoms to reach the substrate with high kinetic and electron-excitation energy.

The major differences between plasma-activated CVD and electron beam processes are as follows:

1. The electron beam process requires separate plasmas for cleaning and nucleating the substrate, ionizing the adatoms, and annealing the coating. In the plasma-activated CVD process, these three plasmas are combined into one.
2. Plasma-activated CVD pressures are higher than those of electron beam CVD, so while electron beam coatings are deposited in line-of-sight and form pinholes around dust particles, plasma-activated CVD tends to incorporate the dust particles into the coating.
3. The higher pressure of plasma-activated CVD allows the background inert gas to remove most of the heat of condensation before it reaches the substrate, so plasma-activated CVD does not require a chill drum.

There are two complementary approaches to improving the barrier performance of SiO_x — modification of the material deposited and modification of the deposition source. Modifiers or replacements for silica can reduce its porosity, melting point, and solubility and can change its nucleation density or refractive index to match adjacent materials.

Silica is preferred as the primary ingredient because of its unusual glass-forming ability to resist crystallization on cooling and consequent high elastic elongation. Some of the materials that have been shown to enhance one or more of these properties of SiO include the oxides of magnesium, carbon, barium, boron, aluminum, germanium, zinc, and titanium.

For example, glass containing 35% magnesium oxide and 65% SiO has a lower melting point, which allows the film to anneal and increases its packing density before it solidifies. Silica is slowly soluble in water, and about 10% zirconium prevents acid and alkali attack. It is established that its x factor in SiO_x varies from 1.55 to 1.8 and oxygen permeability varies from 0.1 to 0.4, with the film becoming yellow as barrier properties improve.

High-speed deposition technologies other than electron beam, which are suitable for barrier and antiabrasion/antireflection coating production, include new methods of CVD. These coatings on plastic can be made by two closely related processes: plasma-activated CVD and plasma polymerization. Similar equipment is used for both processes.

For applications requiring a high refractive index, tetraalkoxy-titanium compounds are nonvolatile and nontoxic, so they can be substituted for siloxanes to yield titanium-dioxide coating for the starting material to yield intermediate refractive indices. These processes offer three advantages over electron beam coating: they are conformal, because they are made at relatively high pressures; because a broader range of starting materials and reaction conditions are available, a broader range of chemical-bond structures can be produced in the coating, or the coating can be tailored for the flexibility of the polymer or for the hardness of the oxides; and the heat load on the plastic being coated is much lower, so cooling is not necessary. This is a result of the adatoms agglomerating in the gas phase into liquid particles that are large enough to greatly reduce the heat of condensation load on the substrate, energetic enough to allow adatom mobility for annealing and close packing, yet small and hot enough to prevent “snow” formation.

The primary disadvantages of plasma-activated CVD is that for most coatings, the starting materials are frequently highly toxic and sometimes pyrophoric.

Materials that have been plasma polymerized include methane, ethane, ethylene, tetrafluoroethylene, acrylic-acid methylene, methacrylate, and other monomers. Plasma-polymerized coatings differ from bulk polymers made from the same monomers in that they are highly cross-linked, making them harder than less elastic. Plasma-polymerized barriers have been reported with oxygen permeabilities less than 0.01.

One of the advantages of plastic films with glass-barrier coatings is the ability to be recycled. Plastic films with glass-barrier coatings can be reextruded, whereas coextruded polymeric barriers cannot. Most likely, $\text{SiO}_{1.8}$ will remain the major component of glass-barrier coatings. Its bonds are flexible regarding angle and length, which imparts to the coating high elastic elongation and resistance to crystallization

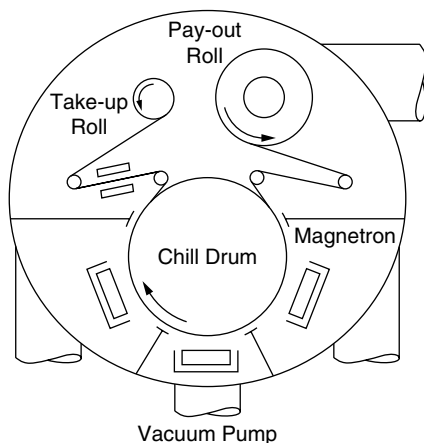

FIGURE 31.14 A cross section of a sputter roll coater.

during coating. Its refractive index is low, so it does not add glare to plastic film. It is also relatively insoluble. The oxygen transmission of coated film is of 0.02 cc/100 in²/day to 0.06 cc/100 in²/day and water-vapor transmission of 0.05 g/100 in²/day to 0.07 g/100 in²/day.

In many cases, reactive magnetron sputtering is chosen as the deposition process. It is a well-proven industrial deposition process used to coat webs to film such as Kapton. Reactive sputtering gives maximum control over the coating process and high deposition rates. There are wide possibilities for the variations on this process, which include plasma deposition (introduction of additional silicon into the discharge as silane, to increase the deposition rate) and plasma polymerization.

Figure 31.14 shows a cross section of a sputter roll coater. A roll of film is unwound in vacuum, passing over a chill drum that stabilizes the film as it is coated by one or several magnetron sputtering sources, and the coating properties are monitored in-line before the film is rewound. This configuration allows for continuous monitoring and feedback control of the coating process and properties. Various optical and electrical properties can be monitored, depending upon the coating being made.

31.5 Conclusions

In years to come, it is expected that the coating technologies described will be improved to yield better performance, reliability, and efficiency. Much is expected from the combination of coating methods, e.g., the sputtering of an excellent adhesion layer, followed by an electron beam evaporated thick metallic layer.

Fundamental investigations have shown that plasma activation becomes necessary to produce layers with acceptable properties by PVD processes. A combination of conventional boat evaporation and plasma activation in compliance with the principle of a magnetron discharge allows us to approach a solution for large-area coating with technically reasonable means. The recently improved understanding of the mechanisms of plasma production and diffusion in magnetic field structure has stimulated the development of new concepts for the production of uniform plasmas and the scaling-up reactors. It removes obstacles to the development of plasma-activated deposition processes.

Although major progress in deposition technologies has been made, the ideal coating design remains elusive. Real coating designs either fail to meet all of the requirements set or are overly expensive to produce. Significant room for improvement remains.

References

1. H. Lievens, *Surf. and Coat. Technol.*, 76–77, 744–753 (1996).
2. K. N. Lee, *Surf. and Coat. Technol.*, 133–134, 1–7 (2000).

3. S. Schiller, U. Heisig, K. Goedicke, K. Schade, G. Teschner, J. Henneberger, *Thin Solid Films*, 64, 455–467 (1979).
4. A. Matthews and D. G. Teer, *Thin Solid Films*, 72, 541 (1980).
5. R. Buhl, K. Pulker, and E. Moll, *Thin Solid Films*, 80, 78 (1981).
6. R. F. Bunshah, R. J. Schramm, and R. Nimmagadda, *Thin Solid Films*, 40, 169 (1977).
7. G. Håkansson, L. Hultman, J.-E. Sundgren, J. E. Greene, W.-D. Münz, *Surf. and Coat. Technol.*, 48, 51–67 (1991).
8. T. M. Anklam, L. V. Berzins, D. G. Braun, C. Haynam, T. Meier and M. A. McClelland, *Surf. and Coat. Technol.*, 76–77, 681–686, (1995).
9. J. Vetter, *Surf. and Coat. Technol.*, 76–77, 719–724 (1995).
10. A. Matthews and D. G. Teer, *Thin Solid Films*, 80, 41 (1981).
11. G. Beister, E. Dietrich, C. Schaefer, M. Scherer and J. Szczyrbowski, *Surf. and Coat. Technol.*, 76–77, 776–785 (1995).
12. E. Bergman, *Surf. and Coat. Technol.*, 57, 133 (1993).
13. G. K. Hubler and J. A. Sprague, *Surf. and Coat. Technol.*, 81, 29–35 (1996).
14. F. A. Smidt, *Int. Mater. Rev.*, 35, 61 (1990).
15. R.F. Bunshah, *Handbook of Deposition Technologies for Films and Coatings*. New York: Noyes Publication, 1994.
16. P. J. Martin, A. Bendavid, and T. J. Kinder, *Surf. and Coat. Technol.*, 81, 36–41 (1996).
17. F. Pashen, *Wied. Ann.*, 37, 69 (1889).
18. E. D. McClanahan and N. Laegreid, in *Sputtering by Particle Bombardment*, 3. R. Behrisch and K. Wittmaack, Eds. Heidelberg: Springer-Verlag, 1993, p. 339.
19. L. Pranevicius, *Coating Technology: Ion Beam Deposition*. Warwick, RI: Satas and Associates, 1993.
20. J. Reschke, K. Goedicke, and S. Schiller, *Surf. and Coat. Technol.*, 76–77, 763–769 (1995).
21. Y. Arnal, R. Burke, J. Cocagne, T. Lagarde, J. Pelletier, *Surf. and Coat. Technol.*, 76–77, 770–775 (1995).
22. B. Window and G. L. Harding, *J. Vac. Sci. Technol.*, A8(3), 46 (1990).
23. T. Levendecker, O. Lemmer, S. Esser, and I. Ebberink, *Surf. and Coat. Technol.*, 48, 175 (1991).
24. S. Schiller, K. Goedicke, F. Milde, and G. Hotsch, *Surf. and Coat. Technol.*, 76–77, 725–730 (1995).
25. W. D. Sproul, *Surf. and Coat. Technol.*, 81, 1–7 (1996).
26. M. Benmalek and H. M. Dunlop, *Surf. and Coat. Technol.*, 76–77, 821–826 (1995).
27. D. Bouchier and W. Moler, *Surf. and Coat. Technol.*, 51, 190 (1992).
28. S. Karagöz and H. F. Fischmeister, *Surf. and Coat. Technol.*, 81, 190–200 (1996).
29. D.M. Sanders, A. Anders, *Surf. and Coat. Technol.*, 133–134, 78–90 (1995).
30. P. C. Johnson and H. Randhawa, *Surf. and Coat. Technol.*, 33, 53 (1987).
31. H. Freller and H. Haessler, *Thin Solid Films*, 153, 67 (1992).
32. H. Randhawa, *Thin Solid Films*, 153, 209 (1987).
33. H. M. Gabriel, *Galvanotechnik*, 78(11), 2 (1987).
34. J. Narayan, N. Biunno, J. Reddy, S.M. Kanetkar, P. Tiwari, N. Parikh, in *Laser and Particle Beam Modification of Chemical Processes on Surfaces*. A. W. Johnson, G.L. Loper, and T. W. Sigmond, Eds., *Mater. Res. Symp. Proc.*, 129, 425 (1989).
35. A. A. Voevodin, M. S. Donley, J. S. Zabinski, and J. E. Bultman, *Surf. and Coat. Technol.*, 76–77, 534–539 (1995).
36. M. Boman and J. -O. Carlsson, *Surf. and Coat. Technol.*, 49, 221 (1991).
37. W. Buechner, R. Schliebs, G. Winter, and K. H. Buechel, *Industrielle Angewandte Chemie*: Weinheim: Verlag Chemie, 1984.
38. H. Holzschuh, C. Oehr, H. Suhr, and A. Weber, *Mod. Phys. Lett.*, B2, 1252 (1988).
39. J. Narayan, J. Reddy, N. Biunno, S. M. Kanetkar, P. Tiwari, N. Parikh, *Materials Science and Engineering B*, 26, 49–53 (1994).
40. H. Demiryont, L. R. Thompson, and G. J. Collins, *Appl. Opt.*, 25, 1311 (1986).
41. H. Takatsuka, M. Noda, Y. Yonekura, Y. Takeuchi, Y. Yamauchi, *Solar Energy*, 77, 951–960 (2004).

42. A. Etspuler and H. Suhr, *J. Appl. Phys.*, A48, 373 (1989).
43. E. Feurer, S. Kraus, and H. Suhr, *J. Vac. Sci. Technol.*, A7, 2799 (1989).
44. H. Holzschuh and H. Suhr, *J. Appl. Phys.*, A51, 486 (1990).
45. H. Holzschuh and H. Suhr, *Appl. Phys. Lett.*, 59, 470 (1991).
46. M. D. Hudson, C. Trundle, and C. J. Brierly, *J. Mater. Res.*, 3, 1151 (1988).
47. R. A. Kant and G. K. Huber, *Surf. and Coat. Technol.*, 51, 247 (1992).
48. R. Prange, R. Cremer, D. Neuschutz, *Surf. and Coat. Technol*, 133–134, 208–214 (2000).
49. E. Kubel, *Metall. Powder Rep.*, 43, 832 (1988).
50. B. Leon, A. Klumpp, M. Perez-Amor, and H. Sigmund, *Appl. Surf. Sci.*, 46, 210 (1990).
51. Y. S. Liu, in *Tungsten and Other Refractory Metals for VLSI Applications*. R. L. Blewer, Ed., *Mater. Res. Soc. Proc.*, 43 (1985).
52. C. Mitterez, M. Rauter, and P. Rodhammer, *Surf. and Coat. Technol.*, 41, 351 (1990).
53. S. Motojima and H. Mizutani, *Appl. Phys. Lett.*, 54, 1104 (1989).
54. A. Chayahara, H. Yokoyama, T. Imura, and Y. Osaka, *Appl. Surf. Sci.*, 33/34, 561 (1988).
55. C. Oehr and H. Suhr, *J. Appl. Phys.*, A49, 691 (1989).
56. D. Hofmann, S. Kunkel, H. Schussler, G. Teschner, R. Gruen, *Surf. and Coat. Technol*, 81, 146–150 (1996).
57. R. D. Arnell, *Surf. and Coat. Technol.*, 43/44, 674 (1990).
58. E. Bergmann, E. Moll, in *Plasma Surface Engineering*, Vol. 1. E. Broszeit, W. Muenz, H. Oechsner, G. Wolf, Eds, Heidelberg: DGM-Verlag, Oberursel, 1989, p. 547.

32

Cathodic Arc Plasma Deposition

32.1	Introduction	32-1
32.2	Cathodic Arc Plasma Deposition Process	32-1
32.3	Cathodic Arc Sources.....	32-3
32.4	Cathodic Arc Emission Characteristics	32-3
32.5	Microdroplets	32-4
32.6	Recent Developments.....	32-5
	References.....	32-7

H. Randhawa

Vac-Tec Systems, Inc.

32.1 Introduction

The cathodic arc plasma deposition (CAPD) method^{1,2} of thin film deposition belongs to a family of ion plating processes that includes evaporative ion plating^{3,4} and sputter ion plating.^{5,6} However, the CAPD process involves deposition species that are highly ionized and possess higher ion energies than other ion plating processes. All the ion plating processes have been developed to take advantage of the special process development features and to meet particular requirements for coatings, such as good adhesion, wear resistance, corrosion resistance, and decorative properties.

The cathodic arc technique, having proved to be extremely successful in cutting tool applications, is now finding much wider ranging applications in the deposition of erosion resistance, corrosion resistance, decorative coatings, and architectural and solar coatings.

32.2 Cathodic Arc Plasma Deposition Process

In the CAPD process, material is evaporated by the action of one or more vacuum arcs, the source material being the cathode in the arc circuit (Figure 32.1). The basic coating system consists of a vacuum chamber, a cathode and an arc power supply, an arc ignitor, an anode, and substrate bias power supply. Arcs are sustained by voltages in the range of 15 to 50 V, depending on the source material; typical arc currents in the range of 30 to 400 A are employed. When high currents are used, an arc spot splits into multiple spots on the cathode surface, the number depending on the cathode material. This is illustrated in Figure 32.2 for a titanium source. In this case, an average arc current/arc spot is about 75 A. The arc spots move randomly on the surface of the cathode, typically at speeds of the order of tens of meters per second. The arc spot motion and speed can be further influenced by external means such as magnetic fields, gas pressures during coatings, and electrostatic fields.

Materials removal from the source occurs as a series of rapid flash evaporation events as the arc spot migrates over the cathode surface. Arc spots, which are sustained as a result of the material plasma generated by the arc itself, can be controlled with appropriate boundary shields and/or magnetic fields.

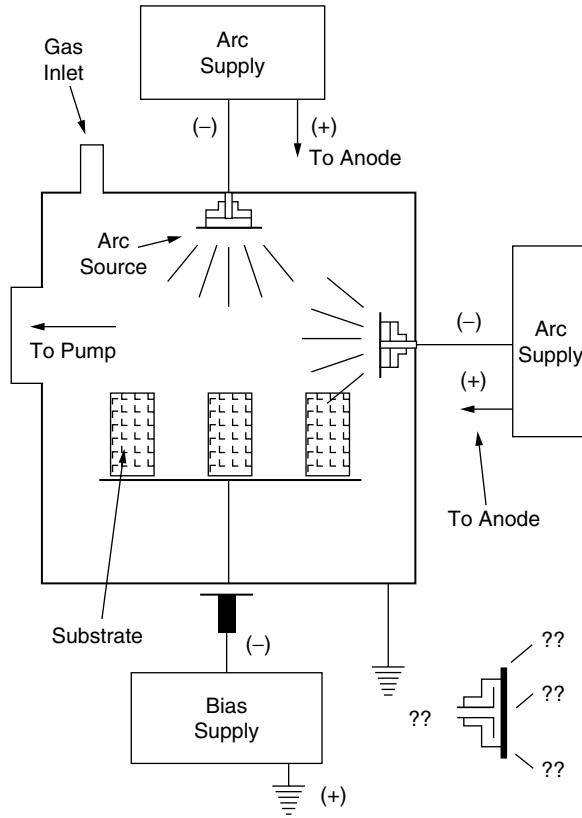

FIGURE 32.1 Schematic of a cathode arc deposition system.

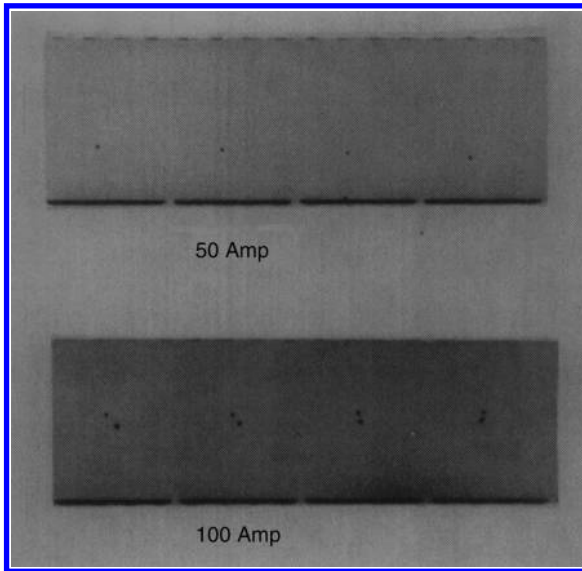

FIGURE 32.2 Number of arc spots on the titanium cathode arc source as a function of arc current.

CAPD is markedly different from the physical vapor deposition process. Some of its characteristic features are as follows:

1. The material plasma is generated by one or more arc spots.
2. A high percentage (30 to 100%) of evaporation material is ionized.
3. The ions exist in multiple charge states (e.g., in case of Ti, Ti^+ , Ti^{2+} , Ti^{3+} , etc.).
4. The ions possess very high kinetic energies (10 to 100 eV).

These characteristics of CAPD result in deposits that are of superior quality in comparison to other plasma processes. Some of these advantages are as follows:

1. Good quality films over a wide range of deposition conditions (e.g., stoichiometric reached films with enhanced adhesion and film density can be obtained over a wide range of reactive gas pressures and evaporation rates)
2. High deposition rates for metals, alloys, and compounds with excellent coating uniformity
3. Low substrate temperature
4. Retention of alloy composition from source to deposit
5. Ease of producing reacted compound films

32.3 Cathodic Arc Sources

A schematic cross section of a cathodic arc source is shown as an inset in [Figure 32.1](#), in a photograph of a typical large area source. The arc source comprises a cathode (source material), an anode, an arc ignitor, and a means of arc confinement.

The method of arc confinement is a key factor in arc source design and configuration. Cathodes using magnetic fields or boundary shields are limited to small sizes of the order of a few inches in diameter. This limits the uniformity attained from such sources. It is generally necessary to use a multitude of such sources to obtain a reasonable coating quality. Arc sources employing confinement passive boarders ([Figure 32.3](#)) with predetermined electronic characteristics may be built much larger and over a wide range of sizes. Such cathode sources provide good uniformity over a wide range of substrate sizes in various industrial applications. Typical thickness uniformity observed using an 8 in. \times 24 in. titanium cathode at a source to substrate distance of 10 in. was approximately 10% over a flat area measuring 5 in. \times 20 in. Furthermore, the target utilization of such arc sources exceeds 70% — much higher in comparison to the magnetron sputtering source (N 40%).

32.4 Cathodic Arc Emission Characteristics

The cathodic arc results in a plasma discharge within the material vapor released from the cathode surface. The arc spot is typically a few micrometers in size and carries current densities as high as $10 \text{ A}/\mu\text{m}^2$. This high current density causes flash evaporation of the source material, and the resulting evaporant consists of electrons, ions, neutral vapor atoms, and microdroplets. Emissions from the cathode spots are illustrated in [Figure 32.4](#). The electrons are accelerated toward the cloud of positive ions. The emissions from the cathode spots split into a number of spots. The average current carried per spot depends on the nature of the cathode material. The extreme physical conditions present within cathode spots are listed in [Table 32.1](#).

It is likely that almost 100% of the material may be ionized within the cathode spot region. These ions are ejected in a direction almost perpendicular to the cathode surface. The microdroplets, however, have been postulated to leave the cathode surface at angles up to about 30° above the cathode plane. The microdroplet emission is a result of extreme temperatures and forces that are present within emission craters. The microdroplet emission is greater for metals with low boiling points. [Figure 32.5](#) shows such results for copper, chromium, and tantalum.

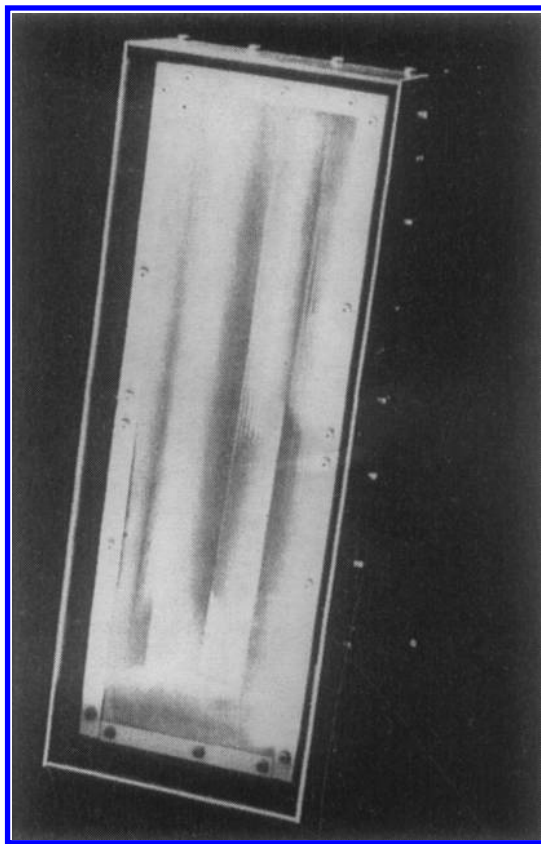

FIGURE 32.3 Typical large-area cathodic arc source.

32.5 Microdroplets

Microdroplets are emitted as one of the products of the flash evaporation events. In an uncontrolled situation, very high microdroplet densities may be produced and deposited onto the substrates. The microdroplets are found to be metal-rich in composition in the case of reacted compound films. Microdroplet size and density can be controlled in the arc deposition process. Parameters and source design are the key factors that influence the density and size of the microdroplets.

As previously reported, microdroplet density and size vary with the material. Zirconium nitride films, deposited under the same conditions as titanium nitride, exhibit a much lower density of much smaller microdroplets (N 0.1 to 0.2 μm). It is believed that the smaller microdroplets result from the higher melting point and low vapor pressure of zirconium coupled with the higher arc spot velocity observed on a zirconium cathode surface. The higher arc spot velocity results in a low mean residence time of the arc spot on a given localized area; thus, it minimizes localized overheating and, hence, the size and density of the microdroplets.

The arc motion of a conventional arc source was studied using a very high speed photographic technique. The arc speed was measured to be approximately 8 m/sec. The application of suitable external magnetic fields was found to enhance the arc speed to 17 m/sec. A corresponding reduction in macro-particles was observed. The source design as well as the operating gas pressure during deposition had an effect on the microdroplet emission. A new arc source using these modified microdroplets could be totally illuminated. This is illustrated for films of titanium and zirconium nitrides and titanium dioxide, as shown in [Figure 32.6](#).

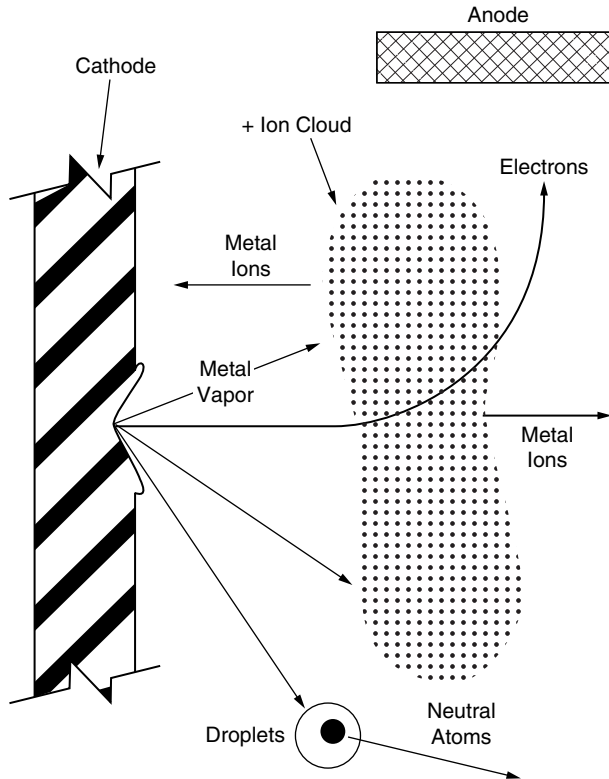

FIGURE 32.4 Emission characteristics of a cathodic arc source.

TABLE 32.1 Physical Conditions:
Cathode Arc Spot

Temperature (K)	4×10^3 – 10^4
Pressure, Mpa	0.1–10
Power density, W/cm ²	10^7 – 10^9
Electric field, V/cm ⁻¹	10^4 – 10^5
Current density, A/cm ⁻²	10^6 – 10^8

32.6 Recent Developments

A major interest in the cathodic arc process until recently has been in the deposition of hard coatings for tribology, wear, and decorative applications. Deposition, characterization, and performance evaluations of nitrides, carbides, and carbonitrides of several materials [Ti, Zr, Hf, (Ti–Al), (Ti–Zr)(Ti–6Al–4V), etc.] using the cathodic arc deposition process have been investigated in detail and will not be discussed here. Some of the most recent developments involve deposition of oxides and multicomponent materials for architectural glass, solar reduction applications, barrier films, and so on. Thin films of tin, zirconium nitride, titanium dioxide, zirconium dioxide, oxide of copper, and other metallic materials have been investigated for these applications. Films of TiO₂ and ZrO₂ were deposited in a reactive mode using an oxygen–gas mixture. ZrO₂ and TiO₂ films with very low absorption (<5%) in the visible light range and excellent adhesion to plastics and glass substrates have been deposited. In fact, TiO₂ films with a sharp cutoff at approximately 400 nm were found to be very suitable for UV filters.

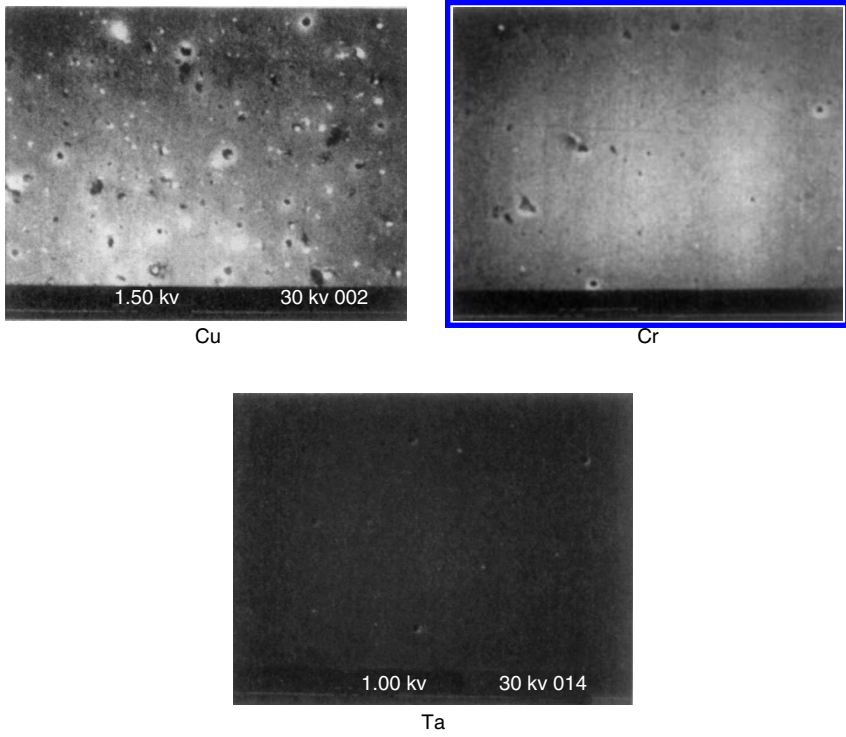

FIGURE 32.5 Microdroplet emission from metals having different melting points.

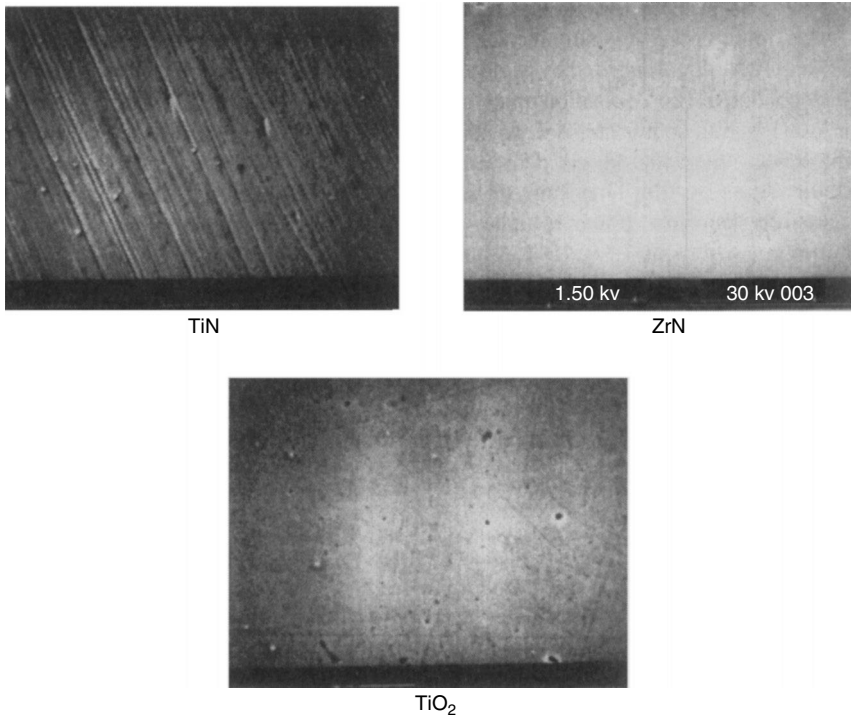

FIGURE 32.6 Scanning electron micrographs showing surface topography of various films using modified arc technology.

TiN and ZrN films deposited by cathodic arc have also been investigated for architectural glass coatings. The deposition rates and stoichiometry control were found to be superior to magnetron sputtering. A deposition rate as high as 10 times that of magnetron sputtering for production scale was demonstrated.

Multicomponent films consisting of Inconel and Ni–Cr–Al–Y alloys have also been successfully deposited at rates as high as 1 mm/min. The film composition as analyzed by spectroscopic techniques (e.g., ESCA and AES) was found to be within 10 to 15% of the source material. This makes cathodic arc an excellent choice for multicomponent materials.

The cathodic arc deposition process has proved to be capable of fulfilling the most exacting demands in applications as diverse as tool coatings, decorative coatings, architectural glass coatings, and turbine engine coatings. Developments are continuing to broaden the range of various potential applications of the cathodic arc.

References

1. H. Randhawa and P. C. Johnson, "A review," *Surf. Coat. Technol.*, 31, 303 (1987).
2. J. L. Vossen and W. Kem, Eds., *Thin Film Processes*. New York: Academic Press, 1978.
3. J. A. Thornton, in *Deposition Technologies for Films and Coatings*. R. F. Bunshah, Ed. Park Ridge, NJ: Noyes Publications, 1982.
4. W. M. Mullarie, U.S. Patent No. 4,430,184 (1984).
5. H. Randhawa and P. C. Johnson, *Surf. Coat. Technol.*, 33, 53 (1987).
6. H. Randhawa, presented at ASM International Strategic Machining and Materials Conference, Orlando, FL, 1987.

33

Industrial Diamond and Diamondlike Films

Arnold H. Deutchman

BeamAlloy Corporation

Robert J. Partyka

BeamAlloy Corporation

33.1 Introduction	33-1
33.2 Diamond and Diamondlike Films	33-1
33.3 Film Deposition Techniques.....	33-2
Plasma-Assisted Chemical Vapor Deposition (PACVD)	
Techniques • Ion Beam Enhanced Deposition (DIOND)	
33.4 Diamond and Diamondlike Film Properties	33-3
33.5 Potential Applications	33-4
References	33-5

33.1 Introduction

The mechanical, electrical, thermal, and optical properties of diamond make it attractive for use in a variety of different applications ranging from wear-resistant coatings for tools and engineered components to advanced semiconductor structures for integrated circuit devices.¹ Until recently, diamond “coating” was done by bonding single-crystal diamond grits to the surfaces of the components to be coated. Applications for diamond coatings were limited, therefore, to tooling used for cutting and grinding operations.

Recent advancements in plasma-assisted chemical vapor deposition (PACVD) and ion beam enhanced deposition technologies make it possible to form continuous diamond and diamondlike carbon films on component surfaces. These new films have many of the mechanical, thermal, optical, and electrical properties of single-crystal diamond, and they make possible the diamond facing of precision tools and wear parts, optical lenses and components, and computer disks, as well as the production of advanced semiconductor devices. The most flexibility, in terms of properties of the deposited diamond films and types of material coatable, is found when the films are formed using ion beam deposition techniques.

33.2 Diamond and Diamondlike Films

The ability to diamond-coat tools and engineered components required that diamond precursor material be condensed from a vapor phase as a continuous film onto the surface of the component to be coated. Furthermore, the deposition must proceed so that the vapor-deposited material condenses with the structure and morphology of diamond. Diamond is a metastable form of carbon; as such, when condensed from a vapor or from a flux of energetic particles, it will tend to assume its most thermodynamically stable state or form — graphite. With advanced processes like chemical vapor deposition (CVD) and ion beam enhanced deposition, it is possible to influence, to a certain degree, the energy and charge states of the particles in the vapor phase, thus allowing some control over the energy state (stable or metastable) and crystallographic and stoichiometric form of the deposited films. Thus, it is feasible to

synthesize a variety of diamond and diamondlike films with a range of mechanical, chemical, optical, electronic, and thermal properties.²⁻⁶ Practical applications for the various films on actual engineered components will be determined by the film properties desired (i.e., hardness, resistivity, optical transmission, etc.) and the nature of the deposition process used to produce the films.

33.3 Film Deposition Techniques

The development of techniques and technologies capable of the deposition of continuous thin diamond and diamondlike carbon films has been sparked by advances in the semiconductor and thin film deposition industry.⁷⁻⁸ These new techniques enable diamond film deposition on the surfaces of both semiconductor and nonsemiconductor materials for potential use in a wide variety of applications, both electronic and nonelectronic. Two distinct coating methodologies have been developed, one relying on deposition from an excited plasma discharge sustained in a low pressure atmosphere of hydrocarbon gases (plasma-assisted CVD), and one relying on the direct deposition of carbon films, either without or with simultaneous bombardment by an intense flux of high energy ions (ion beam enhanced deposition).

33.3.1 Plasma-Assisted Chemical Vapor Deposition (PACVD) Techniques

Deposition of diamondlike carbon films with the plasma-assisted CVD technique proceeds by exciting hydrogen-hydrocarbon-argon gas mixtures either in a glow discharge⁹⁻¹⁵ or with microwave radiation¹⁶⁻¹⁸ (Figure 33.1). In both cases, a plasma is produced, and free carbon atoms are generated by the thermal decomposition of the hydrocarbon gas component. The carbon atoms liberated in the plasma have enough energy to allow tetragonal carbon-carbon (diamond) bonding, making possible the condensation of diamond and diamondlike carbon films. The films produced are actually mixtures of trigonally bonded carbon (graphite), tetragonally bonded carbon (diamond), and other allotropic crystalline forms.^{7,8}

To dissociate the hydrocarbon starting gas and provide enough thermal energy to allow formation of trigonal and/or tetragonal carbon bonding, temperatures in the plasma discharge must exceed 2000°F. Deposition rates on the order of 1 $\mu\text{m}/\text{h}$ are achievable. The presence of free hydrogen in the processing

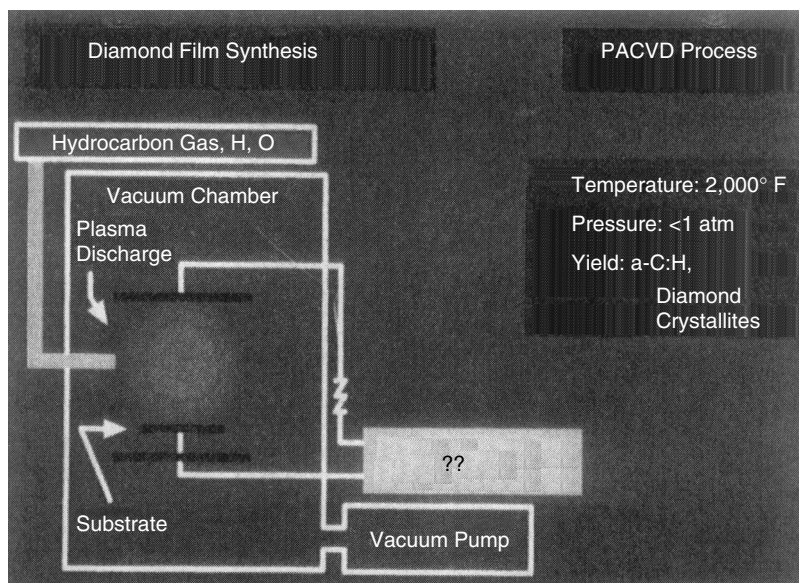

FIGURE 33.1 Diamond films synthesis with the plasma-assisted chemical vapor deposition process (PACVD). A range of hydrogenated diamond and diamondlike film structures can be produced at low pressure, and temperatures in the 2000°F range.

gas helps to promote film growth with higher concentrations of tetragonally bonded diamond versus trigonally bonded graphite. This occurs because graphitic bonds are much more chemically reactive than are diamond bonds, resulting in selective etching of the graphite component of the films by free hydrogen gas in the plasma. However, the presence of hydrogen trapped in the deposited diamond films can produce high levels of tensile stresses, leading to embrittlement and buckling.

Applications for diamond films formed by the PACVD techniques are limited to those in which the substrate can be raised to temperatures in excess of 2000°F. Also, the diamond films deposited by this technique grow epitaxially and therefore condense on and adhere best to crystalline substrates like silicon and germanium. Therefore, diamond films deposited by PACVD techniques are best suited for applications in semiconductor structures and devices. Field effect transistors have been made by forming ohmic and Schottky contacts on semiconducting diamond substrates deposited by the CVD process. The films can also be useful as passivation layers on integrated circuits, since they can be made very hard, as well as resistant to attack by acid, alkali, and organic solvents. Formation of diamondlike carbon films on metallic, ceramic, and certainly plastic substrates calls for techniques that do not require high temperatures and are not as sensitive to the metallurgy of the substrate to be coated.

33.3.2 Ion Beam Enhanced Deposition (DIOND)

The high temperatures and pressures required for the formation of tetragonally bonded diamond structures can be provided on a microscopic level by the bombardment of films of carbon atoms with energetic ions. Bombarding ions with energies of only 100 eV produce picosecond temperature and pressure spikes at the target surface in excess of 7300°F and 120,000 atm. The thermal agitation and shock wave accompanying 100 eV ion impingement is capable of forming single-crystal diamond nuclei approximately 1 nm in diameter. Thus, under ion bombardment, carbon atoms deposited in continuous films on a substrate surface can combine at the surface to form all possible combinations of carbon-carbon bonding, including the uniform tetragonal bonding exhibited by natural diamond.

Ion beam based deposition processes can be implemented either by direct acceleration and implantation of carbon atoms²⁰⁻²³ or by deposition of thin carbon films with simultaneous bombardment of the films by an additional energetic ion beam²⁴⁻²⁷ or by deposition of thin carbon films with simultaneous bombardment of the films by an additional energetic ion beam,²⁴⁻²⁷ termed ion beam enhanced deposition. The latter technique is more flexible in that a wider latitude of film morphologies and properties can be produced, higher deposition rates are achievable, and a wider variety of materials can be coated. During the ion beam enhanced deposition process, carbon films are deposited on the surface to be diamond coated, while the surface is, at the same time, illuminated with a secondary energetic ion beam (Figure 33.2). The energy of the carbon atoms can be varied during the deposition, as can the energy of the secondary ion beam. No additional energy in the form of heat is required, so coating temperatures can be held below 150°F. In addition, the films are initially mixed into the surface being coated, thereby allowing them to be formed easily on virtually any substrate material, and optimizing film adhesion.

33.4 Diamond and Diamondlike Film Properties

The operating parameters of both the PACVD and the DIOND deposition processes can be adjusted to optimize the mechanical, electrical, optical, and thermal properties of the deposited films. For resistance to wear and erosion, film hardness can be optimized. Films with hardnesses in the 3000 to 4500 (DPHN) range are produced routinely, and even though they are thin (0.1 to 5.0 μm), they produce dramatic increases in wear resistance on wear components and tools.

The surfaces of natural diamond are lubricious, with extremely low coefficients of friction. The lubricity of diamondlike carbon films can be further enhanced by adjusting process parameters to increase concentrations of trigonally bonded graphitic structures. Coefficients of friction as low as 0.001 have been produced in diamondlike films rubbing against steel.

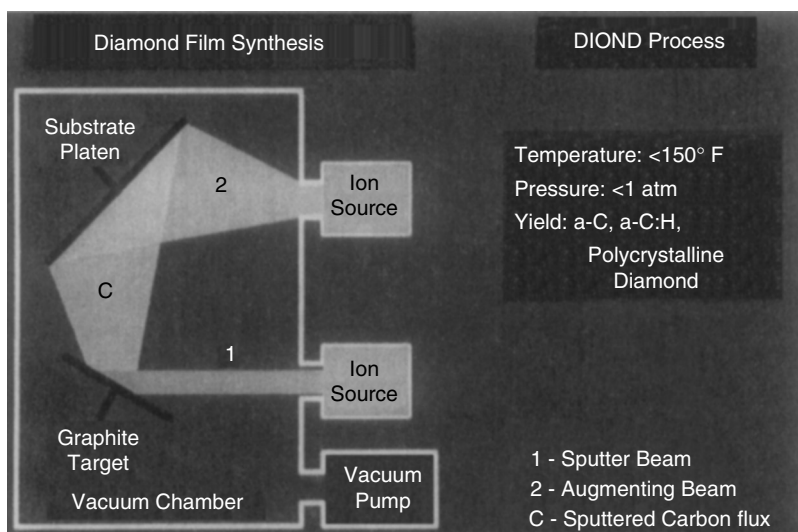

FIGURE 33.2 Diamond film synthesis with the ion beam enhanced deposition process (DIOND). A range of diamond and diamondlike film structures can be produced at low pressure, and temperatures that do not exceed 150°F.

Optical properties can also be optimized by adjusting process parameters. Diamondlike films that are optically transparent in the visible and infrared regions of the electromagnetic spectrum, as well as films that are colored, can also be produced.

Films with an extremely wide range of electrical resistivities can be deposited by varying process parameters. By adjusting the relative concentration of trigonally and tetragonally bonded carbon atoms, the resistivities of the films can be varied from as low as $1 \Omega \text{ cm}$ to as high as $1 \times 10^{12} \text{ cm}$.

33.5 Potential Applications

The development of the PACVD and the DIOND ion beam enhanced deposition techniques enable the deposition of a range of diamond and diamondlike films with a variety of operating properties. The applications for each technique will be determined by the film properties required and the temperatures that components to be treated can sustain during coating (Figure 33.3).

The high temperature PACVD process is finding primary applications in the semiconductor device area because semiconducting and ceramic substrate materials can sustain high processing temperatures. Applications in the semiconductor electronics area include production of active semiconducting elements (amplifiers, oscillators, and electro-optic elements) that operate at higher switching speeds and higher temperatures (and thus power levels), high efficiency heat sink layers, and insulating layers for protection against oxidation and chemical contamination.

The availability of the DIOND ion beam enhanced deposition process, which is able to produce a range of diamond and diamondlike carbon films at low temperatures, and depositable on virtually any substrate material, makes a number of applications for diamond coatings feasible. Wear-resistant surfaces for a wide variety of precision tools and wear components (e.g., gears and bearings) are now being produced. The dielectric properties of the films allow them to be used as protective coatings for the magnetic recording media on fixed disks for computers, as well as the magnetic recording heads themselves. Because the films can be made optically transparent, optical components like lenses and mirrors can be surfaced for resistance to erosion and scratches. The films can also be used to reduce surface friction on components as well as to produce graphitic self-lubricating layers for applications in which conventional lubricants cannot be used.

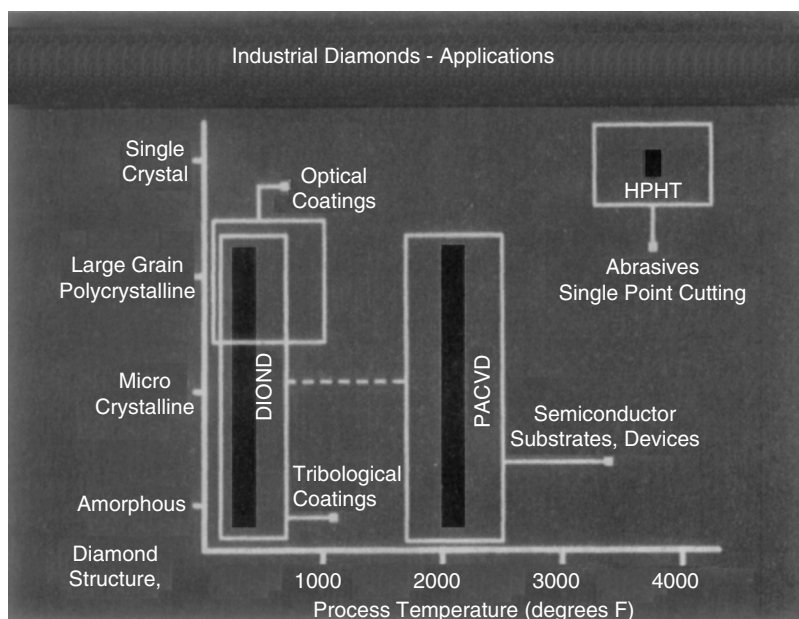

FIGURE 33.3 Potential application areas for diamond and diamondlike films shown on a continuum of film properties and processing temperatures. The PACVD process will find primary use in semiconductor electronic applications, in contrast to the ion beam enhanced deposition (DIOND) process, which will find broader use in the deposition of tribological coatings for engineered mechanical and optical components.

The availability of processes capable of depositing diamond and diamondlike films on the surfaces of engineered components offers opportunities to improve the operating performance of many existing products and to develop a wide variety of new ones in the semiconductor, electronic, optical, computer, and mechanical components industries. Key to the successful use and application of these new industrial diamond and diamondlike films are a solid understanding of the range of film properties that can be produced and proper selection of the techniques used to deposit them.

References

1. G. Graff, *High Technol.*, 7, 44 (1987).
2. J. C. Angus et al., *Thin Solid Films*, 118, 311 (1984).
3. C. Weissmantel, in *Thin Films from Free Atoms and Particles*, K. J. Klabunde, Ed. Orlando, FL: Academic Press, 1985, p. 153.
4. J. C. Angus, *Thin Solid Films*, 142, 145 (1986).
5. D. B. Kerwin et al., *Thin Solid Films*, 148, 311 (1987).
6. R. Messier et al., *Thin Solid Films*, 153, 1 (1987).
7. R. C. DeVries, *Annu. Rev. Mater. Sci.*, 17, 161 (1987).
8. J. C. Angus et al., *Science*, 241, 913 (1988).
9. D. S. Whitmell et al., *Thin Solid Films*, 35, 255 (1976).
10. B. V. Spitsyn et al., *J. Cryst. Growth*, 52, 219 (1981).
11. K. Enke, *Thin Solid Films*, 80, 227 (1981).
12. S. Matsumoto et al., *J. Appl. Phys.*, 21, 1183 (1982).
13. E. T. Prince, *J. Vac. Sci. Technol. A3*, 3, 694 (1985).
14. J. D. Warner et al., *J. Vac. Sci. Technol. A3*, 3, 900 (1985).
15. A. R. Nyaiesh et al., *J. Vac. Sci. Technol. A3*, 3, 610 (1985).
16. O. Matsumoto et al., *Thin Solid Films*, 128, 341 (1985).

17. O. Matsumoto et al., *Thin Solid Films*, 146, 283 (1986).
18. N. Fujimori et al., *Vacuum*, 36, 99 (1986).
19. S. Aisenberg et al., *J. Appl. Phys.*, 42, 2953 (1976).
20. E. G. Spenser et al., *Appl. Phys. Lett.*, 29, 228 (1976).
21. J. H. Freeman et al., *Nuclear Instrum. Methods*, 135, 1 (1976).
22. T. Miyazawa et al., *J. Appl. Phys.*, 55, 188 (1984).
23. J. W. Rabalais et al., *Science*, 239, 623 (1988).
24. C. Weissmantel, *Thin Solid Films*, 92, 55 (1982).
25. M. J. Mirtich et al., *Thin Solid Films*, 131, 245 (1985).
26. C. Weissmantel et al., *J. Vac. Sci. Technol. A4*, 6, 2892 (1985).
27. A. H. Deutchman et al., *Ind. Heating*, LV(7), 12 (1988).

34

Tribological Synergistic Coatings

34.1	Introduction	34-1
34.2	What Are Synergistic Coatings?	34-2
34.3	Wear Testing	34-3
34.4	Coating Families.....	34-3
	Polymer Coatings (Lectrofluor) • Magnesium (Magnadize) and Titanium (Canadize) • Titanium Nitride (Magnagold)	

Walter Alina

General Magnaplate Corporation

34.1 Introduction

The solution of wear and many related problems for any application is very much experience dependent. A scientific basis for resolving these problems unfortunately has not yet been found. Using experience and history, it is possible to recommend a number of potential solutions; however, the ultimate proof is in the actual trial of the application. This is because there are so many variables within each application that the slightest change could make a difference in the selection of the appropriate coating. Even though applications appear to be identical, there are always slight differences such that the same coating selection will not always perform in the same manner.

The production of synergistic coatings on steel (Nedox) or aluminum (Tufram) is based on the principle of infusion of a dry lubricant or polymer into the coatings. General Magnaplate has developed a family of such coatings (Nedox), each one representing specific properties, such as hardness, lubricity, corrosion protection, and dielectric strength. The standard hardfacing for steel is an electroless nickel coating. There are a number of electroless nickels that vary the phosphorus content and consequently have differences in hardness and corrosion resistance. Choice of such a coating varies and is based on the application requirements.

Synergistic coatings for aluminum (Tufram) have been used successfully for many years. The system can accommodate almost all aluminum alloys, provided a copper content of 5% and a silicon content of 7% are not exceeded. Higher percentages of these constituents (set up too great a change in substrate resistivity, hence) prevent the buildup of required film thickness.

The prime purpose of the Tufram system is to produce films having properties such as improved wear resistance, better surface release (lower coefficient of friction), good corrosion resistance, and high dielectric strength.

The principle of these coatings is based on a hardcoat after which a polymer or dry lubricant is infused into the coating substrate.

All coatings are used in a wide variety of industries. Some are in compliance with the regulations of the U.S. Food and Drug Administration and can be used in food and medical applications.

The improvement in wear resistance to aluminum ranges from 5 to 25 times that without the coatings. It is difficult to put an exact number on the improvement, since it varies from one application to another.

34.2 What Are Synergistic Coatings?

Synergistic coatings are not really “coatings” in the conventional sense of the word. They are created during multistep processes that combine the advantages of anodizing or hardcoat plating with the controlled infusion of low friction polymer and/or dry lubricants. These “coatings” become an integral part of the top layers of the base metal rather than merely a surface cover. Since the resulting surfaces are superior in performance both to the base metal and to the individual components of the coatings, the proprietary processes that produce them are identified as “synergistic.” Why do they work?

The Tuftram process, a family of coatings for aluminum alloys, converts the hydrated aluminum oxide $\text{Al}_2\text{O}_3 \cdot \text{H}_2\text{O}$ and replaces the H_2O of the newly formed ceramic surface with inert polymeric material that provides a self-lubricating surface. In the process, the aluminum crystals expand and form porous anchor crystals that remain hygroscopic for a short period of time.

The particles of the specific polymer selected are then introduced under controlled conditions of properly balanced solutions, time, and temperature, to permanently interlock with the newly formed crystals.

This results in a harder-than-steel continuous lubricating plastic-ceramic surface of which the polymeric particles become an integral part (Figure 34.1).

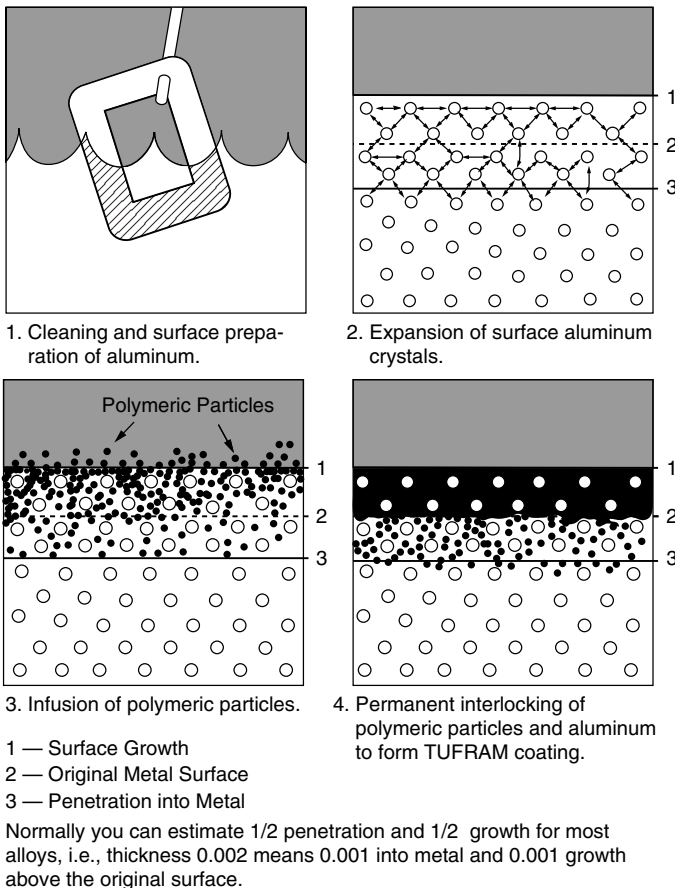

FIGURE 34.1 The Tuftram process sequence.

Synergistic coatings are a great asset in solving many wear problems, but how were these problems resolved years ago? Their solution was expensive, time-consuming, and very frustrating.

Normally a surface was built up with 0.005 to 0.020 in. of hard chrome, then precision machined to a specification. After this surface had been polished to 4 RMS or better, it basically qualified as a wear surface, because it was hard and the 4 RMS microfinish reduced the coefficient of friction. If the coefficient of friction of such a surface were compared to the coefficients for synergistic coatings (see [Table 34.1](#)), the latter would be seen to have much lower numbers, consequently lower frictional values.

It is important to have some familiarity with the coefficient of friction between materials. [Table 34.1](#) gives both static and dynamic coefficients of friction of many basic coatings. Each fractional number implies the frictional forces applied against two surfaces.

The coefficients in [Table 34.1](#) are to be considered only as a guide. Many factors can alter figures derived from these laboratory constants, including the following:

- Applied loads
- Point loading
- Loading stresses
- Substrate hardness
- Temperature conditions
- Ambient moisture present
- Environmental variations
- Microfinish components

Because of the complexity of the wear and friction phenomena, all these conditions must be considered when designing any system.

All testing was standardized as follows:

1. Specimens were ground and polished to 4 to 6 RMS.
2. Laboratory temperature was maintained at 72°F, with a relative humidity of 54%; absolute humidity of Hg. 10.6.
3. An average of five readings per test run was taken.
4. A T.M.I. Slip and Friction Tester (model 98.5) was used, with a constant load of 200 g.
5. The materials and coatings are listed in [Table 34.2](#).
6. The friction tester used was the T.M.I. slip and friction tester model No. 98-5, using a constant 200 gram load. It is shown in [Figure 34.2](#).

34.3 Wear Testing

Wear tests are difficult for most people to comprehend. However, a system that is considered a reasonably good standard is the Taber Abraser ([Figure 34.3](#)). This instrument requires a 4 panel 4 in. square, coated with the material that is being tested. It can vary loads (grams), the number of cycles (generally 10^3 to 10^4), and the type of abrasive wheel (either CS-10 or CS-17) being used.

After a set of conditions has been established, it is easy to use them as a standard for new coatings, because there now is a basis for comparison.

The principle of this wear method is a weight loss of coating based on the degree of wear.

Note the conditions and weight loss in [Figure 34.4](#) and [Figure 34.5](#) for aluminum and steel, respectively.

34.4 Coating Families

34.4.1 Polymer Coatings (Lectrofluor)

The properties that can be easily achieved using polymer or organic coatings are dielectric, chemical corrosion, and radiation resistance; in addition, special organic coatings can be used with food and pharmaceutical applications in compliance with regulations of the U.S. Food and Drug Administration.

All coatings are proprietary, since they are new developments, and specific nomenclature (601, 604, 615, 611, etc.) is used for identification.

Coatings can be applied by spraying, by dipping, or by an electrostatic powder process. In most cases, a curing temperature in the range of 300 to 750°F will achieve maximum surface hardness and minimize porosity. Polymer coatings normally range from 0.001 to 0.015 in. in thickness.

Salt spray resistance of these coatings is excellent: approximately 2000 h (6 yr in the atmosphere). The chemical resistance is the main property of the 601 coatings, which can withstand strong acids and alkalis at temperatures up to 2000°F. The 604 material has similar resistance but can be utilized in food applications. The 615 is a tough, durable coating (D-80 durometer) that can withstand temperatures from -400 to 500°F, and can also be used in food applications. The 611 coating, which has good release characteristics, also is used in applications in the baking industry and comes in a variety of colors.

34.4.2 Magnesium (Magnadize) and Titanium (Canadize)

Since magnesium and titanium are widely used materials, especially in the field of aerospace and computers, their users often are confronted with very severe problems.

A system for hardfacing each material has been developed that is basically an electrochemical process. The synergistic coating system is still far the best for a wear application, however, and special fluoropolymers or dry lubricants are infused into the hardfacing. For magnesium the synergistic coating is called Magnadize, and for titanium it is called Canadize.

For magnesium the thickness can vary from a minimum of 0.0002 in. to a maximum exceeding 0.0015 in. Normal application thickness is approximately 0.0005 to 0.001 in.

It is more difficult to build up thickness for titanium, so the normal application thickness is between 0.0002 and 0.0005 in.

A typical application for Magnadize would be a magnesium engine mount for aircraft. The entire mount would be hardcoated, and the gear spline would receive dry lubricant to improve the efficiency of the part.

A classic application for Canadizing is titanium hardware for aircraft. Such components are anodized with an infusion to a thickness of 0.0002 to 0.0004 in. to prevent the titanium from seizing.

34.4.3 Titanium Nitride (Magnagold)

Since the introduction of titanium nitride to the industrial sector, coating companies have been offering this service without sufficient knowledge of its engineering properties. The coating was known to be extremely hard, and it was being applied to cutting tools exclusively. A study of this coating material, however, revealed some interesting properties, noted in [Table 34.3](#), [Table 34.4](#), and [Table 34.5](#).

One of the unique features of the titanium nitride process is the uniformity of the coating. This is critical for many applications involving missile, computer, and semiconductor applications. Other excellent applications are found in the plastic extrusion industry (which utilizes the superior release properties in molds and dies); the medical industry (for coating delicate surgical instruments, and preventing solder adherence when special heat treatments are employed in the complex multistep process).

In this Magnagold process, a uniform coating, held to within a few millionths of an inch thickness, can be applied safely to even the most critical, closest tolerance parts via special cleaning fixturing mechanisms and techniques that enable the part to be rotated 360° while traveling through the vapor stream. The process sequence is outlined in [Figure 34.6](#); a production setup appears in [Figure 34.7](#).

Because the parts to be coated are rotated both radially and axially within the unique ion bombardment chamber, there are no restrictions on shapes. In addition, all surfaces, except clamp and fixture areas, are uniform in coating thickness. Normally, the thickness ranges from 0.00003 and 0.0002 in., with final determination being edge sharpness and/or wear. (Load life is the ultimate criterion for the final decision.)

Since the condition of the substrate surface is a key element in the effectiveness of any physical vapor deposition (PVD) process, General Magnaplate has engineered an exclusive, proprietary predeposition

TABLE 34.1 Friction Data by Materials

Upper Plate ^a	Lower Plate ^a	Coefficients of Friction	
		Static	Kinetic
Ice	Ice	0.000	0.000
Hi-T-Lube	Hi-T-Lube	0.251	0.217
Hi-T-Lube	Steel	0.056	0.049
Hi-T-Lube ^b	Hi-T-Lube ^b	0.034	0.034
Lectrofluor 604	Glass	0.190	0.172
Lectrofluor 604P	Teflon	0.106	0.089
Magnagold	Magnagold	0.245	0.211
Magnagold	Magnagold + Ni	0.484	0.357
Magnagold	Teflon	0.150	0.123
Magnagold	Steel	0.300	0.246
Magnagold	Nickel	0.326	0.259
Magnagold	Glass	0.177	0.155
Magnagold	Aluminum	0.248	0.220
Magnagold	Chromium ^a	0.193	0.174
Magnagold	Steel	0.313	0.285
Magnagold	Nickel	0.367	0.329
Magnagold	Titanium P	0.559	0.494
Magnagold	Copier paper	0.518	0.497
Magnagold	MOS/2	0.304	0.270
Magnagold	Hi-T-Lube	0.264	0.244
Magnagold	Graphite over paper	0.260	0.234
Magnaplate TFE	Magnagold + TFE	0.225	0.174
Magnaplate HCR	Magnaplate HCR	0.198	0.174
Magnaplate HCR	Glass	0.138	0.125
Magnaplate HCR	Aluminum	0.346	0.289
Magnaplate HCR	Teflon	0.142	0.120
Magnaplate HMF	Hi-T-Lube ^b	0.032	0.031
Magnaplate HMF	Magnaplate HMF	0.160	0.147
Magnaplate HMF	Teflon	0.059	0.053
Magnaplate HMF	Glass	0.251	0.192
Magnaplate HMF	Steel	0.212	0.181
Nedox S/F 2	Steel	0.301	0.260
Nedox S/F 2	Teflon	0.103	0.090
Nedox S/F 2	Nedox S/F 2	0.179	0.123
Nedox S/F 2	Glass	0.137	0.130
Tufram 604	Aluminum	0.429	0.371
Tufram H-2	Tufram H-2	0.171	0.139
Tufram H-2	Glass	0.203	0.169
Tufram H-2	Aluminum	0.377	0.264
Tufram H-2	Teflon	0.134	0.120
Tufram H-0	Tufram H-0	0.249	0.223
Tufram H-0	Glass	0.180	0.150
Tufram H-0	Aluminum	0.251	0.219
Tufram H-0	Teflon	0.121	0.103
Tufram L-4	Tufram L-4	0.184	0.173
Tufram L-4	Aluminum	0.353	0.294
Tufram L-4	Glass	0.256	0.189
Tufram L-4	Teflon	0.142	0.130
Tufram R66	Glass	0.162	0.149
Tufram R66	Tufram R66	0.148	0.115
Tufram R66	Aluminum	0.329	0.272
Tufram R66	Teflon	0.133	0.100
Aluminum	Titanium A	0.413	0.376
Aluminum	Titanium P	0.614	0.531
Aluminum	Teflon	0.237	0.186
Aluminum	Glass	0.175	0.137

TABLE 34.1 Friction Data by Materials (Continued)

Upper Plate ^a	Lower Plate ^a	Coefficients of Friction	
		Static	Kinetic
Aluminum	Aluminum	0.646	0.563
Aluminum	Magnagold	0.304	0.263
Aluminum	Chromium	0.199	0.185
Aluminum	Nickel	0.258	0.233
Aluminum	Steel	0.466	0.375
Chromium	Chromium A	0.176	0.159
Chromium	Aluminum	0.266	0.216
Chromium	Magnagold	0.176	0.149
Chromium	Nickel	0.405	0.356
Chromium	Steel	0.254	0.210
Copier paper	Copier paper	0.275	0.259
Graphite over paper	Graphite over paper	0.322	0.302
Hard chromium	Titanium P	0.344	0.304
Hard chromium	Teflon	0.095	0.078
Hardcoated aluminum	Glass	0.151	0.127
Hardcoated aluminum	Teflon	0.178	0.157
Hardcoated aluminum	Hardcoated aluminum	0.264	0.220
MOS/2	MOS/2	0.433	0.418
Nickel	Teflon	0.148	0.120
Nickel	Chromium	0.192	0.174
Nickel	Aluminum	0.330	0.253
Nickel	Magnagold	0.308	0.267
Nickel	Nickel	0.317	0.279
Steel	Titanium P	0.493	0.410
Steel	Hi-T-Lube	0.254	0.218
Steel	Graphite over paper	0.245	0.225
Steel	Aluminum	0.349	0.247
Steel	Magnagold	0.377	0.308
Steel	Magnagold + Ni	0.675	0.607
Steel	Teflon	0.269	0.269
Steel	Nickel	0.723	0.553
Steel	Glass	0.127	0.116
Steel	Chromium	0.202	0.174
Steel	Nickel	0.431	0.333
Steel	Magnagold	0.218	0.194
Steel	Nickel	0.353	0.315
Steel	Steel	0.423	0.351
Teflon	Titanium A	0.232	0.205
Teflon	Titanium P	0.291	0.240
Teflon	Hard chromium	0.210	0.191
Teflon	Magnagold + Ni	0.209	0.160
Teflon	Magnagold	0.161	0.114
Teflon	Magnaplate HCR	0.178	0.167
Teflon	Magnaplate HMF	0.172	0.154
Teflon	Nedox SF2	0.149	0.120
Teflon	Tufram H-2	0.137	0.127
Teflon	Tufram H0	0.167	0.138
Teflon	Tufram L4	0.149	0.131
Teflon	Tufram R66	0.180	0.149
Teflon	Teflon	0.083	0.070
Teflon	Steel	0.184	0.157
Teflon	Nickel	0.223	0.190
Teflon	Hardcoated aluminum	0.207	0.183
Teflon	Glass	0.097	0.097
Teflon	Aluminum	0.194	0.177
Titanium A	Steel	0.358	0.317

TABLE 34.1 Friction Data by Materials (*Continued*)

Upper Plate ^a	Lower Plate ^a	Coefficients of Friction	
		Static	Kinetic
Titanium A	Magnagold	0.264	0.226
Titanium A	Hard chromium	0.375	0.332
Titanium A	Aluminum	0.345	0.288
Titanium P	Steel	0.369	0.283
Titanium P	Magnagold	0.290	0.258
Titanium P	Hard chromium	0.328	0.288
Titanium P	Alumium	0.430	0.321
Titanium A	Titanium A	0.359	0.303
Titanium A	Teflon	0.174	0.142
Titanium P	Titanium A	0.415	0.370
Titanium P	Teflon	0.223	0.193

^a A superscript “a” indicates additional polish after coating; a “b” indicates postburnishing — comparable to breaking in the surface.

TABLE 34.2 Key to Materials and Coatings Listed in [Table 34.1](#)

Designation in Table 34.1	Description
Aluminum	6061 T6 grade (0.250) thickness
Steel	1032 grade H32 (0.250) thickness
Titanium A	6Al/4V (0.250) thickness
Titanium P	Vacuum deposited at 10 to 5 torr, 2 μm thickness, purity 99.99%
Glass	Tempered (0.250) thickness
Teflon	White, virgin grade (0.250) thickness
Nickel	Autocatalytic 6/8% phosphorus (0.001)
Hard chromium	Industrial grade (0.0003)
Hard anodize	6061 T6 (0.002)
Tuftram	Proprietary aluminum coating
Nedox	Proprietary treatment for steel and stainless steels and nonferrous metals
Hi-T-Lube	Proprietary solid film metal alloy lubricant
Magnagold	Proprietary method for vacuum coating of titanium nitride
Magnaplate HMF	Proprietary ultrahard, high microfinish for most base metals
Magnaplate HCR	Proprietary ultrahard and exceptionally corrosion-resistant coating for aluminum

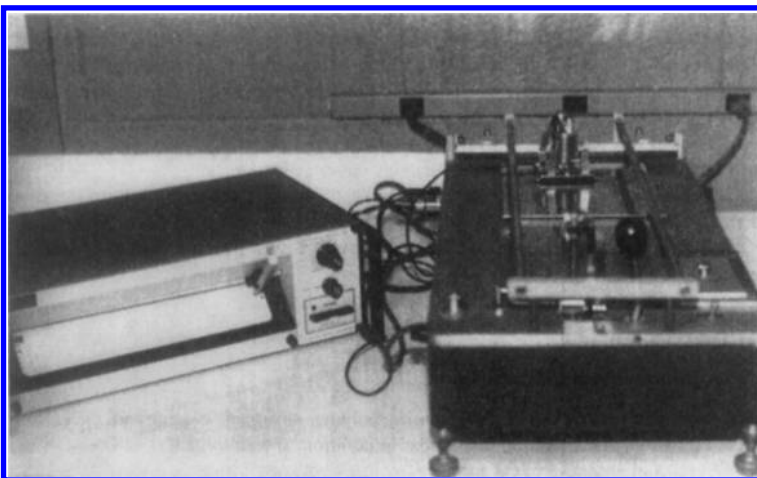
**FIGURE 34.2** T.M.I. slip and friction tester.

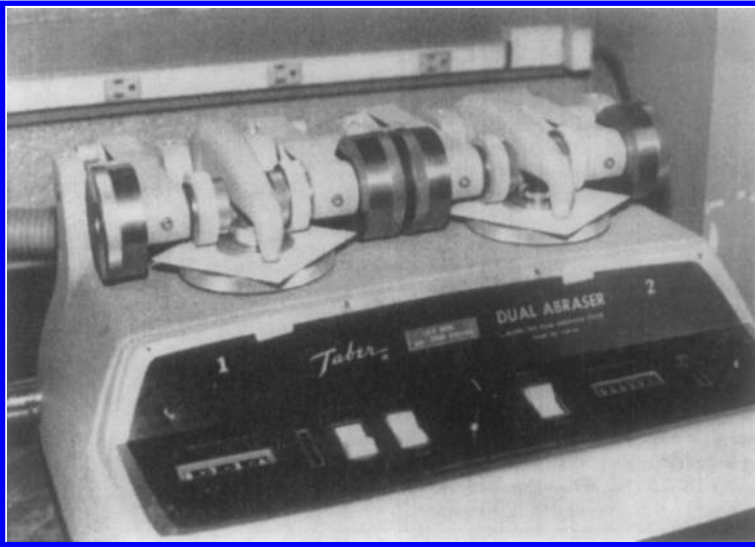

FIGURE 34.3 The Taber Abraser.

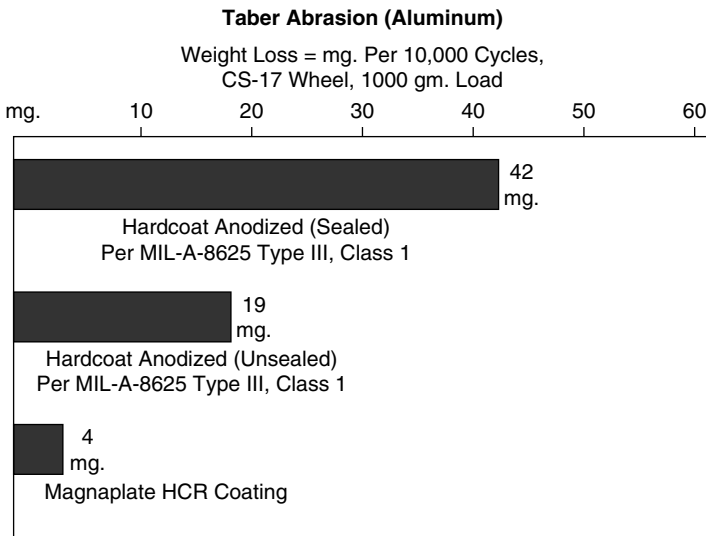

FIGURE 34.4 Weight loss following Taber abrasion for aluminum samples with various coatings.

surface preparation. A combination of specialty designed equipment and chemical cleaning techniques prepares the component surface to assure permanently interlocked anchoring of the “coating.” Conventional vapor deposition applicators are not equipped with the extensive facilities that permit the meticulous care and attention required in the precleaning phase of the process. The parts are mounted on a specially designed cylindrical fixture, and then the entire work cylinder enters the vacuum chamber. A vacuum (1×10^{-6} torr) is achieved, after which the system is purged with argon gas as an additional cleaning step. Titanium metal (99.9%) is then vaporized by a plasma energy source. This is followed by the precise introduction of nitrogen, the reactive gas, into the chamber. The parts to be coated are cathodically charged by high voltage (dc), thereby attracting accelerated ions of titanium. Simultaneously, they combine with nitrogen to produce the tightly adhering, highly wear-resistant titanium nitride PVD coating.

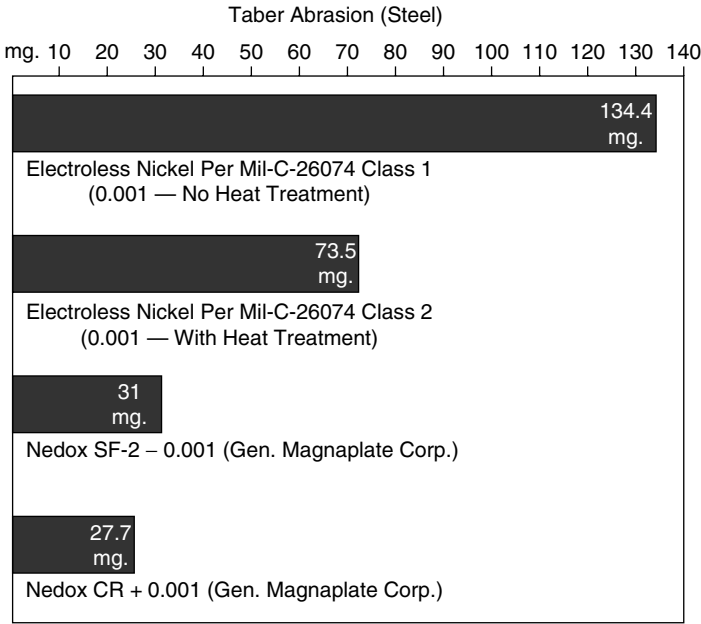

FIGURE 34.5 Weight loss following Taber abrasion for steel samples with various coatings.

TABLE 34.3 Some Physical Properties of Magnagold Coatings

Hardness	R, 80 to 85
Chemical resistance to 30% concentrations of nitric and sulfuric acids on copper and steel substrates at ambient temperature	Virtually no attack
Alkali resistance	Virtually no attack
Taber abrasion test, CS 10 wheel, 1000 g load, 10,000 cycles	Average weight loss >0.5 mg
Coating thickness	1 to 3 μm
Uniformity of thickness	15 × 10 ⁻⁵ 0.000015 in. (max.)
Crystal lattice	Body-centered cubic, a = 4.249 Å
Density	5.44 g/cm ³
Thermal conductivity, cal/cm/sec/°C	~0.162 (at 1500°C) ~0.167 (at 1600°C) ~0.165 (at 1700°C) ~0.136 (at 2300°C)
Coefficient of thermal expansion	× 10 ⁻⁶ cm/°C 9.35 ± 0.04 (at 25 ~1100°C)
Electrical resistivity	40 μΩ (at 27°C)
Thermionic emission work function	3.75 eV
Microhardness (Hu)	2050 kg/mm ² (load 100 g)

Note: Some alloys are sensitive to temperatures up to 900°F and can be reduced in hardness if the substrate material selected is not heat compatible with this process. It is possible to lower processing temperature to prevent certain steels from annealing; however, there may be a slight reduction in the hardness of the titanium nitride coating.

TABLE 34.4 Wettability of Various Metal Surfaces

Wettability Metal	Contact	(Temperature/Condition)
Cu	180°	(1100°C vac)
	126°	(1180°C vac)
	148°	(1560°C NH ₃)
	136°	(1130°C Ar)
Al	147°	(850 to 1000°C vac)
	135°	(900°C Ar)
Cd	139°	(450°C vac)
Pb	102°	(450°C vac)
Sn	140°	(350°C vac)
Bi	147°	(370°C Ar)
Fe	100°	(1500°C vac)
	132°	(1550°C Ar)
Co	104°	(1550°C vac)
Ni	~70°	(1550°C vac)
	110°	(1450 to 1500°C N ₂)

TABLE 34.5 Static (S) and Kinetic (K) Coefficients of Friction for Various Coated Components of a Panel Assembly

Lower Panel	Upper Panel	
	Steel (4 to 8 μm in. RMS)	Teflon
Steel (4–8 RMS)	S: 0.534 ± 0.079	0.184 ± 0.029
	K: 0.400 ± 0.093	0.157 ± 0.029
Magnagold (4–8 RMS)	S: 0.218 ± 0.028	0.161 ± 0.014
	K: 0.194 ± 0.030	0.114 ± 0.017

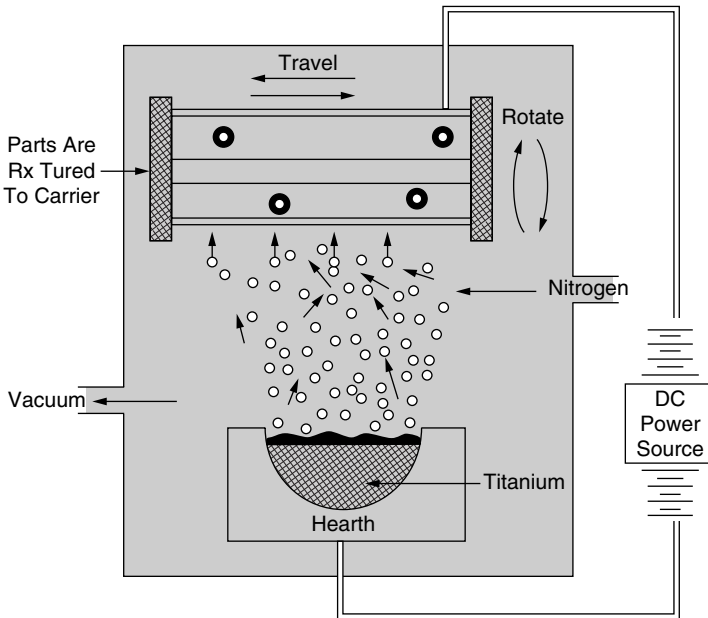

FIGURE 34.6 The Magnagold process sequence.

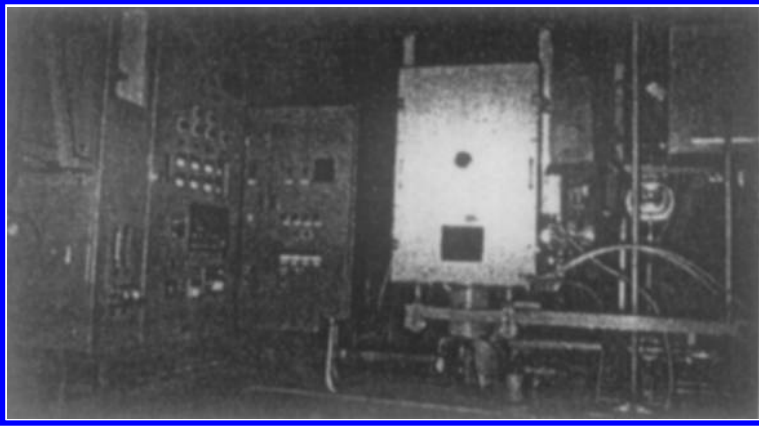

FIGURE 34.7 The Magnagold production setup.

35

Chemical Vapor Deposition

35.1 Introduction	35-1
35.2 Process.....	35-1
35.3 Applications.....	35-3
35.4 Summary.....	35-9
Bibliography	35-10

Deepak G. Bhat
GTE Valenite Corporation

35.1 Introduction

Chemical vapor deposition (CVD) is a technique of modifying properties of surfaces of engineering components by depositing a layer or layers of another metal or compound through chemical reactions in a gaseous medium surrounding the component at an elevated temperature. In formal terms, CVD may be defined as a technique in which a mixture of gases interacts with the surface of a substrate at a relatively high temperature, resulting in the decomposition of some of the constituents of the gas mixture and the formation of a solid film of coating of a metal or a compound on the substrate.

35.2 Process

A modern CVD system includes a system of metering a mixture of reactive and carrier gases, a heated reaction chamber, and a system for the treatment and disposal of exhaust gases. [Figure 35.1](#) shows the basic arrangement of various components of industrial CVD systems.

The gas mixture (which typically consists of hydrogen, nitrogen, or argon, and reactive gases such as metal halides and hydrocarbons) is carried into a reaction chamber that is heated to the desired temperature by suitable means. The various techniques include resistance heating with Kanthal, Global (SiC) or graphite heating elements, or induction. In some cases, the substrate is heated directly by passing an electric current through it.

Typical operating parameters for a conventional CVD process are shown in [Table 35.1](#). Different variations of the conventional method have been developed over the last few decades. These include moderate-temperature CVD (MTCVD), plasma-assisted CVD (PACVD), and laser CVD (LCVD). In the MTCVD process, the reaction temperature is reduced to below about 850°C by the use of metalorganic compounds as precursors. Therefore, this technique is also referred to as metalorganic CVD (MOCVD). In the microelectronics field where this technique is widely used, it is also commonly referred to as organometallic vapor phase epitaxy (OMVPE). In the PACVD technique, the heating of the gas mixture is accomplished by creating a high energy plasma that activates the chemical reactions at considerably reduced temperatures as compared to the conventional CVD. In the case of LCVD techniques, the same effect is achieved by using a laser beam to heat the gas volume or the substrate.

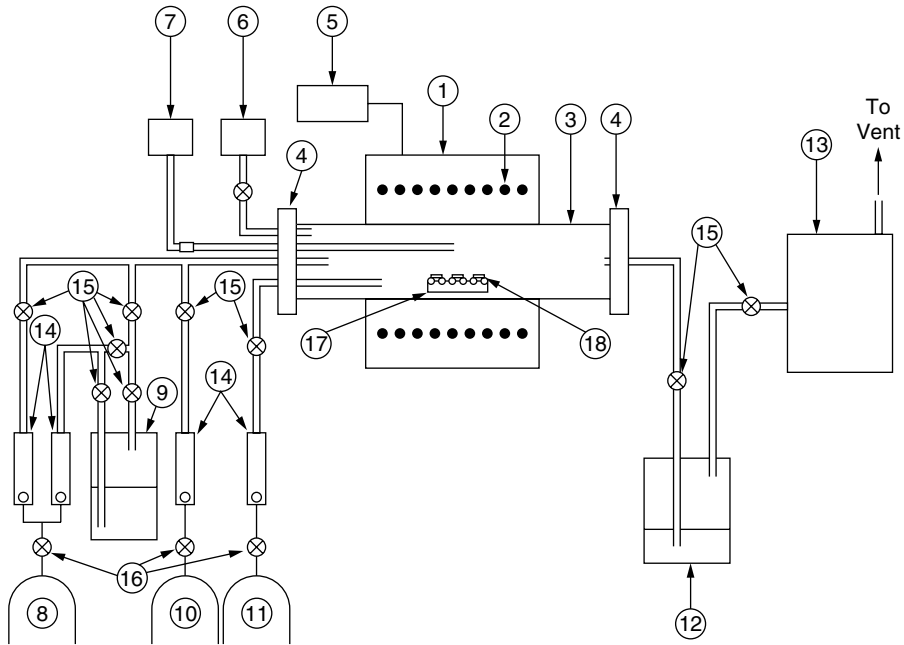

FIGURE 35.1 Schematic diagram showing various components of a typical chemical vapor deposition system operating at one atmosphere pressure: 1: Reactor, 2: Heating elements, 3: Reaction chamber, 4: Water-cooled end flanges, 5: Power controller, 6: Pressure gauge, 7: Temperature sensor and controller, 8, 10, and 11: Precursor gas sources, 9: Metal halide (liquid) vaporizer, 12: Particulate trap, 13: Gas scrubber, 14: Flow meters, 15: Flow control valves, 16: Gas tank regulators, 17: Substrate support, 18: Substrate. For a system operating at low pressures, the vacuum pumping system is connected between 12 and 13.

TABLE 35.1 Typical Parameters in Conventional Chemical Vapor Deposition

Temperature	Pressure	Precursors
$\geq 800^{\circ}\text{C}$; typically up to 2000°C	$\leq 10^{-6}$ torr to 1	Reactive gases: metal halides, carbonyls Reducing gases: H_2 Inert gases: Ar, N_2 Other gases: CH_4 , CO_2 , NH_3 , other hydrocarbons

All CVD systems require a mechanism by which the products of the chemical reaction are treated. These products contain various reactive and potentially hazardous constituents, as well as particulate matter, which must be trapped and neutralized before the gases are exhausted to the atmosphere. In addition, as most CVD processes are carried out at subatmospheric pressures, the pumping equipment must be protected from the relatively hot, corrosive gases. This is usually done by using nonreactive materials for the pump components.

The deposition of coatings by CVD can be achieved in a number of ways. The chemical reactions utilized in CVD are shown in [Table 35.2](#). These reactions between various constituents occur in the vapor phase over the heated substrate, and a solid film is deposited on the surface. The coatings are, therefore, termed “overlay” coatings. On the other hand, a surface film can also be deposited by causing a reaction between the substrate surface and one or more of the constituents of the vapor phase. One example of this technique is the formation of a nickel aluminide film on the surface of nickel by a reaction of aluminum trichloride and hydrogen from the vapor with the surface of nickel at a high temperature. Such a coating may, therefore, be called a conversion coating.

TABLE 35.2 Chemical Reactions in CVD

Reaction	Equation
Thermal decomposition, or pyrolysis	$\text{CH}_3\text{SiCl}_3 \rightarrow \text{SiC} + 3\text{HCl}$
Reduction	$\text{WF}_6 + 3\text{H}_2 \rightarrow \text{W} + 6\text{HF}$
Oxidation	$\text{SiH}_4 + \text{O}_2 \rightarrow \text{SiO}_2 + 2\text{H}_2$
Hydrolysis	$2\text{AlCl}_3 + 3\text{H}_2\text{O} \rightarrow \text{Al}_2\text{O}_3 + 6\text{HCl}$
Coredreduction	$\text{TiCl}_4 + 2\text{BCl}_3 + 5\text{H}_2 \rightarrow \text{TiB}_2 + 10\text{HCl}$

TABLE 35.3 Typical Materials Deposited by CVD

Material	Example
Metals	Al, As, Be, Bi, Co, Cr, Cu, Fe, Ge, Hf, Ir, Mo, Nb, Ni, Os, Pb, P, Re, Rh, Ru, Sb, Si, Sn, Ta, Th, Ti, U, V, W, Zr, also carbon and boron
Compounds	II–VI and III–V compounds, borides, carbides, nitrides, and silicides of transition metals, as well as sulfides, phosphides, aluminides, etc.
Ceramics	Al_2O_3 , AlN, B_2O_3 , BN, SiC, Si_3N_4 , UO_2 , Y_2O_3 , ZrO_2 , etc.

TABLE 35.4 Applications of the CVD Technique

Tribological coatings	Decorative films
Wear-resistant coatings	Superconducting films
High-temperature coatings for oxidation resistance	Emissive coatings
Dielectric insulating films	Coatings for fiber composites
Optical/reflective films	Free-standing structural shapes
Photovoltaic films	Powders and whiskers

35.3 Applications

The CVD technique is applicable for the deposition of a wide variety of materials, such as metals, compounds, ceramics, powders, and whiskers. Typical materials deposited by CVD and applications of the CVD technique are summarized in Table 35.3 and Table 35.4. One of the earliest applications of CVD was in the manufacture of pigments. Powders of TiO_2 , SiO_2 , carbon black, and other materials such as Al_2O_3 , Si_3N_4 , and BN, have been routinely made by CVD. In a variation of the conventional CVD technique, powders of nuclear fuel materials from the fuel rods used in nuclear reactors have been coated in a fluidized bed with coatings of SiC, graphite, and ZrC for containment of fission products.

Because of the nature of the process, CVD is used to deposit high-purity metals from their halide or carbonyl precursors, and the technique has been especially useful for synthesizing refractory metals. The most commonly used precursors for CVD are metal halides. For a successful application of CVD, it is necessary to be able to decompose the halides at relatively moderate temperatures (e.g., $\leq 1000^\circ\text{C}$). Thus, many metals with halides that are stable in this temperature range are difficult to deposit successfully. In many of these cases, organometallic compounds have been used successfully. Typical examples of metallic components deposited by CVD are shown in Figure 35.2.

In recent years, another interesting application of the CVD technology has achieved prominence. Deposition of whiskers of metals and refractory compounds is of significant technological importance because of the potential for development of composite materials. Composites have become a very important new class of engineering materials for aerospace structural applications.

Whiskers are needle-shaped single crystals of materials, typically 1 μm or less in diameter and several micrometers long. It has been demonstrated that the addition of whiskers to ceramics, which are inherently brittle, significantly improves their fracture toughness. Various refractory compounds have been deposited in the form of whiskers by CVD. These include Al_2O_3 , Cr_3C_2 , SiC, Si_3N_4 , TiB_2 , TiC, TiN, ZrC, ZrN, and ZrO_2 . Figure 35.3 shows an example of TiC whiskers deposited by CVD. It is to be expected

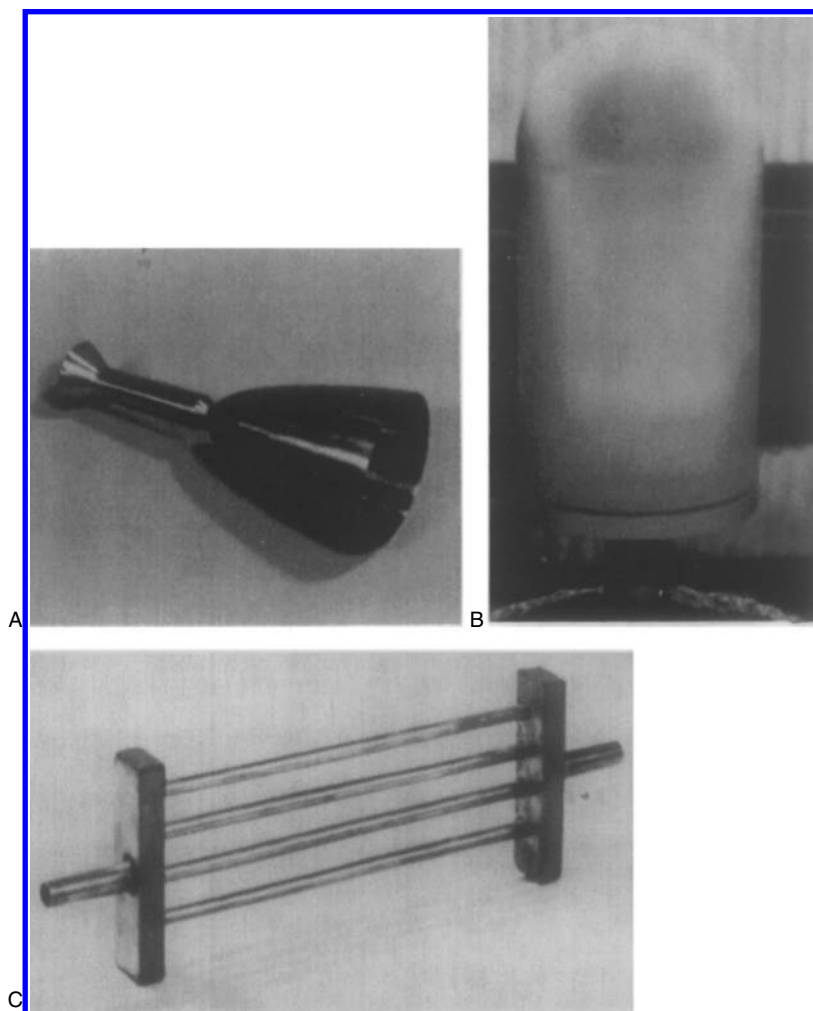

FIGURE 35.2 Metallic compounds deposited by CVD. (A) Iridium-coated rhenium thrust chamber for liquid rockets, 75 mm major diameter \times 175 mm length \times 0.75 mm wall thickness; (B) Tungsten crucible, 325 mm diameter \times 575 mm height \times 1.5 mm wall thickness; (C) Tungsten manifold, about 175 mm long. (Photographs courtesy of Ultramet Corporation, Pacoima, California; reprinted with permission. Figure 2 of “A review of chemical vapor deposition techniques, materials & applications,” by D. G. Bhat, *Surface Modification Technologies*, pp. 1–21, The Metallurgical Society, 420 Commonwealth Drive, Warrendale, PA 15086.)

that with the increasing prominence of the composite materials in the advanced engineering components, many more materials will be synthesized in the whisker and fiber forms for these applications.

As stated earlier, the conventional CVD calls for relatively high temperatures. This requirement imposes certain limitations on the type of substrate that can be successfully used for deposition. Typically, most ceramic materials, graphite, and refractory metals such as tungsten and molybdenum are found to be quite suitable because of their high thermal and chemical stability in typical CVD process environments. Steels have also been used successfully, but certain precautions must be taken for best results. For example, most steels other than austenitic or ferritic steels undergo solid state phase transformation in the 700 to 800°C temperature range. This transformation is accompanied by changes in microstructure, physical properties, and dimensions that could be detrimental for the coating or the component in the intended application. In addition, the chemical stability of steel may be compromised in some CVD coating operations, as in the case of tungsten deposition as a result of the reaction of steel with the fluoride gases.

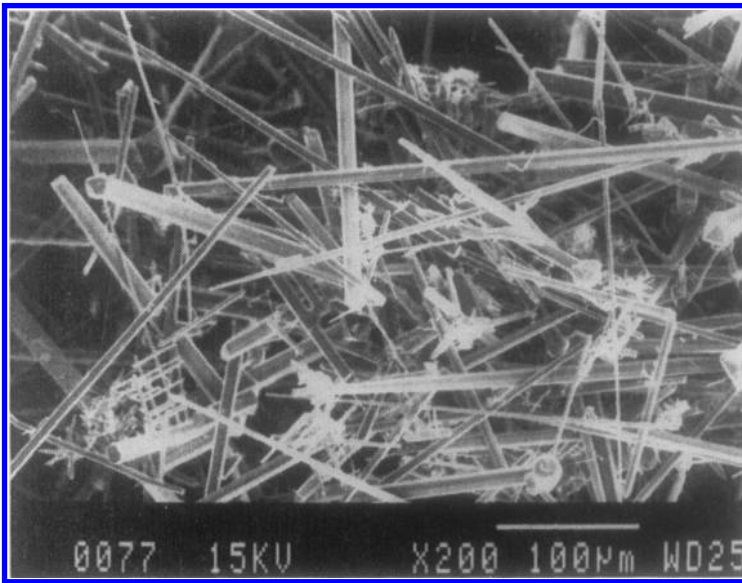

FIGURE 35.3 Scanning electron micrograph showing whiskers of TiC deposited by CVD from a gas mixture containing TiCl_4 , H_2 , and CH_4 at about 1100°C . The formation of whiskers is enhanced by nickel, which acts as a catalyst during the growth of whiskers by the vapor–liquid–solid (VLS) mechanism.

Methods to avoid these possibilities exist; for example, one can deposit a film of nickel by electrolytic or electroless means to protect the substrate. [Figure 35.4](#) shows an example of a stainless steel compressor blade coated with a CVD tungsten carbide coating by a moderate-temperature CVD process. The component was electroless nickel plated before CVD.

One of the most widely known and practiced applications of CVD is in the manufacture of coated cemented carbide cutting tools. These tools are made of tungsten carbide–cobalt alloys on which a wear-resistant coating of a refractory compound is applied by CVD. The commonly used coatings include TiC, TiN, and Al_2O_3 , and their combinations. Other coatings include $\text{Ti}(\text{C},\text{N})$, TaC, HfN, and ZrN. [Figure 35.5](#) shows several cemented carbide cutting tool inserts coated with TiC and TiN.

Another application of wear-resistant CVD coatings is in areas involving erosion and abrasion, such as sand blast nozzles, slurry transport and handling equipment, coal gasification equipment, and mining equipment. In these applications, air- or waterborne particles of sand, fly ash, or other particulate matter traveling at speed and under pressure can cause abrasion and erosion of surfaces they contact. Conventionally, many of these surfaces are protected by applying wear-resistant coatings by various means, such as electroplating, flame or plasma spraying, laser cladding, and weld overlay coating techniques. Chemical vapor deposition has also been used successfully in many of the applications. The graph in [Figure 35.6](#) shows the relative wear rates of various coatings, other hardfacing materials, and ceramics against sand, indicating that CVD coatings can be successfully used in these applications.

Tribological coatings present another use for CVD coatings: to improve the coefficient of friction between sliding or rolling surfaces in contact, thereby reducing wear due to adhesion, abrasion, or other causes. Typical coatings used in these applications include refractory compounds such as carbides, nitrides, and borides of transition metals. The important properties of coatings in these applications include hardness, elastic modulus, fracture toughness, adhesion, grain size, and to a certain extent, chemical stability depending on the service environment.

One of the elegant applications of CVD tribological coatings is for ball bearings. As shown in [Figure 35.7](#), the wear resistance and service life of a steel ball bearing improved dramatically when either the balls or the races were coated with CVD TiC. Other applications of tribological coatings include various steel components such as coatings on dies used in molding, extrusion, and similar metalworking operations.

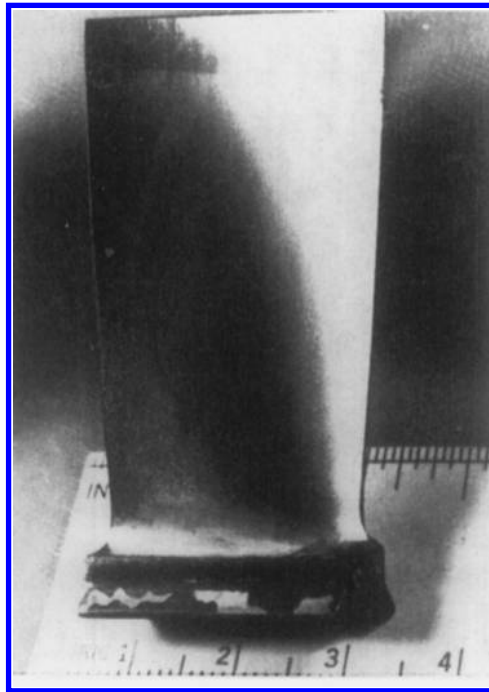

FIGURE 35.4 Photography showing a 17-4 PH stainless steel compressor blade coated with a tungsten carbide coating in a MTCVD process. The blade is first coated with an interlayer of nickel by electrolytic or electroless plating techniques to protect it from the corrosive action of hydrofluoric acid gas generated during the deposition reaction.



FIGURE 35.5 Photography showing cemented tungsten carbide cutting tool inserts coated with TiC and TiN coating in a conventional CVD process. These coatings impart improved wear resistance to the carbide tools, allowing them to run at higher speeds and chip loads in the machining of various materials.

Coatings used for high-temperature applications require high thermal stability. Refractory compounds having low vapor pressure and high decomposition temperature are generally suitable in these cases, depending on service environment. Other properties, such as abrasion resistance, oxidation resistance, thermal shock resistance, and compatible thermal expansion characteristics, are also important. Thus, typical coatings used in these applications include certain refractory metals, Al_2O_3 , B_4C , SiC , Si_3N_4 , SiO_2 , and ZrO_2 , and refractory metal silicides. Composite coatings such as $\text{Al}_2\text{O}_3 + \text{ZrO}_2$ and $\text{Al}_2\text{O}_3 + \text{Y}_2\text{O}_3$ have also been studied. Most of these coatings can be deposited by CVD. Typical applications for these coatings include rocket nozzles, reentry cones, ceramic heat exchanger components, afterburner parts in rocket engines, and gas turbine and automotive engine components. Another well-known example of a protective refractory coating is the SiC-coated hardware used in the microelectronics field for manufacturing coated silicon wafers. [Figure 35.8](#) shows typical examples of graphite susceptor components coated with SiC. An iridium-coated rhenium thrust chamber for spacecraft was shown in [Figure 35.2](#).

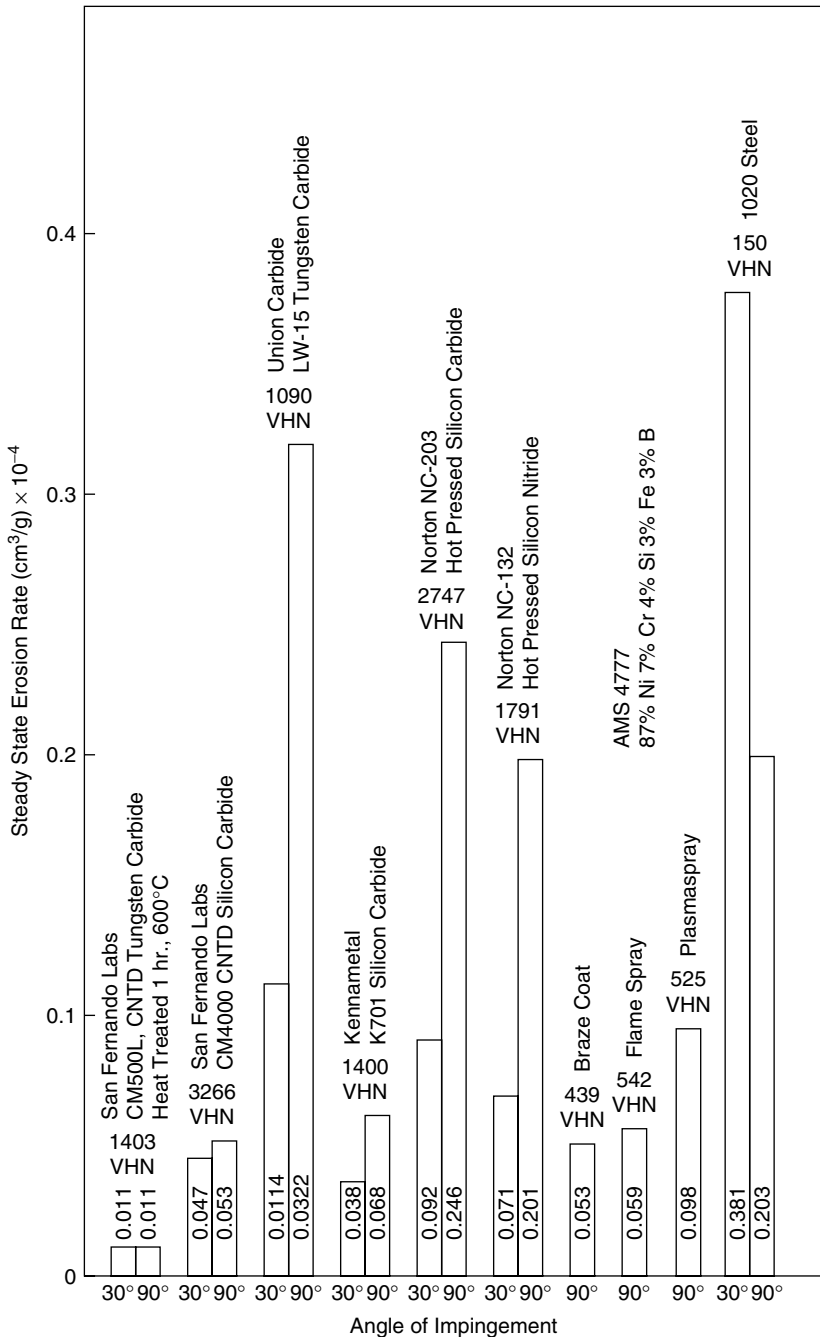

FIGURE 35.6 Steady state erosive wear rate of ultrafine-grained CVD tungsten-carbon (CM 500L) and SiC (CM 4000) coatings and other hardfacing materials, coatings, and ceramics. The eroding medium is 200-micron SiC particles impinging at a velocity of 30 ms⁻¹ at room temperature. [Data from Hickey et al., *Thin Solid Films*, vol. 118, p. 321 (1984). Reprinted with permission from Elsevier Sequoia, S.A., Switzerland.]

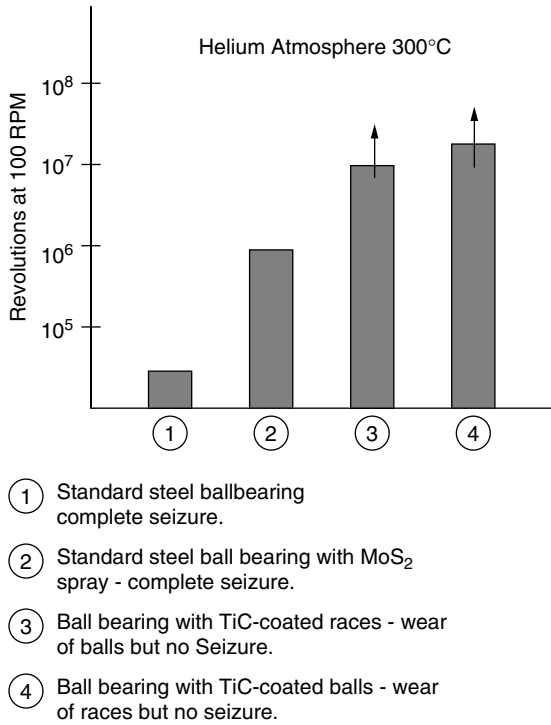

FIGURE 35.7 Effect of CVD TiC coating on the frictional and wear behavior of steel ball bearing components. (Data from Hintermann, H.E., *Thin Solid Films*, vol. 84, p. 215 (1981). Reprinted with permission from Elsevier Sequoia, S.A., Switzerland.)

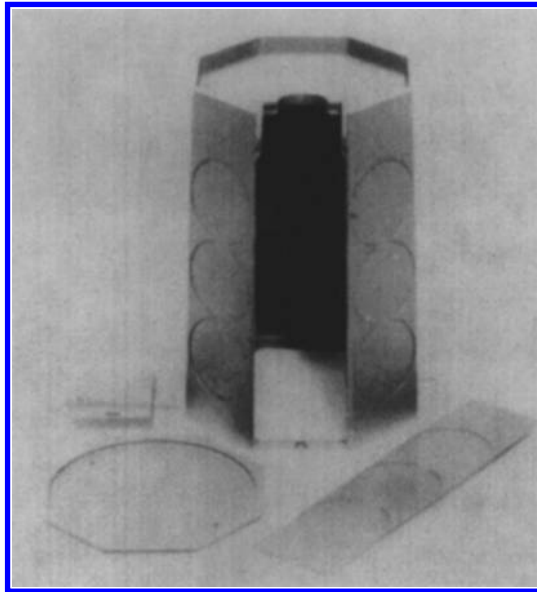

FIGURE 35.8 Photograph of graphite susceptor components coated with CVD SiC. These components are used in the microelectronic industry as supports for wafers during deposition of various thin films.

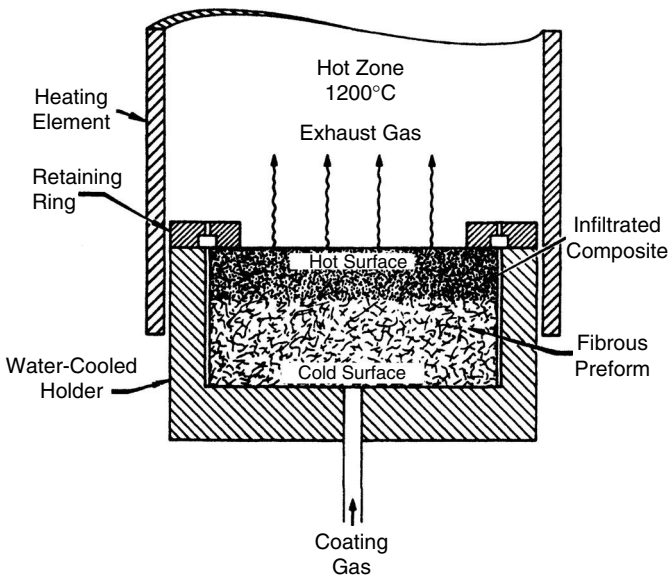

FIGURE 35.9 Schematic diagram showing a technique of chemical vapor infiltration of porous fiber preforms, in which a coating of a protective material such as SiC is deposited. In this method, a thermal gradient across the preform allows diffusion of the reactive gas mixture progressively from the hot surface to the cold surface, uniformly coating the preform. [Data from Stinton et al., *Ceramic Bulletin*, vol. 65, p. 347 (1986). Reprinted with permission from The American Ceramic Society.]

In recent years, advances in the technology of carbon–carbon composites have led to the fabrication of components out of these materials, which are then coated by CVD or the new technology of chemical vapor infiltration (CVI) with various refractory compound coatings, most notably SiC. Other ceramic fiber composites based on alumina and silica have also been coated in a similar manner for high temperature service. Figure 35.9 illustrates one of the techniques used for coating of porous fiber preforms by CVI.

The more exotic CVD techniques that were mentioned earlier, such as PACVD and LCVD, have found important applications for the deposition of new types of coatings. One of the most interesting applications is the deposition of diamond films by PACVD. The diamond films have unique properties and application potential ranging from wear-resistant coatings for cutting tools to coatings for laser mirrors, fiber-optics, dielectric films, and heat sinks in microelectronic circuits. Figure 35.10 shows an example of a diamond film deposited on silicon, with the characteristic Raman peak at 1332 cm^{-1} . Coatings deposited by the LCVD technique find applications in laser photolithography, repair of VLSIC masks, laser metallization, and laser evaporation deposition.

35.4 Summary

The chief characteristics of CVD may be summarized as follows:

1. The solid is deposited by means of a vapor phase chemical reaction between precursor compounds in gaseous form at moderate to high temperatures.
2. The process can be carried out at atmospheric pressure as well as at low pressures.
3. Use of plasma and laser activation allows significant energization of chemical reactions, permitting deposition at very low temperatures.
4. Chemical composition of the coating can be varied to obtain graded deposits or mixtures of coatings.

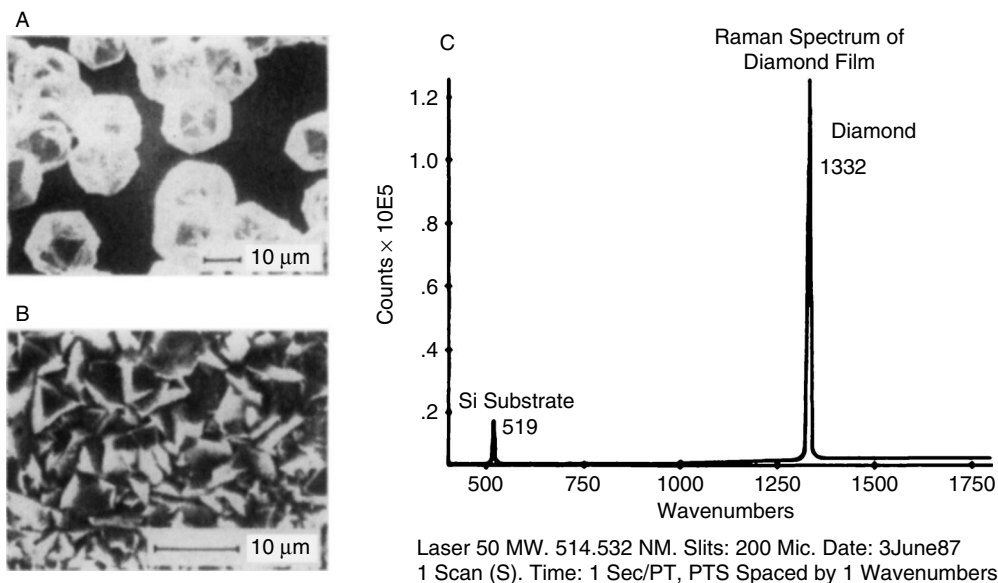

FIGURE 35.10 Photographs showing diamond crystals (A) and polycrystalline diamond film (B) deposited on a silicon wafer substrate by microwave plasma-enhanced CVD, from a gas mixture containing hydrogen and methane. The Raman spectrum (C) clearly shows the characteristic Raman shift for diamond at 1332 cm^{-1} . (Data courtesy of Drs. R. Messier, Materials Research Laboratory, The Pennsylvania State University, and P. K. Bachmann, Philips Research Laboratories, Eindhoven, The Netherlands.)

5. Controlled variations in density and purity of the coating can be achieved.
6. Coatings on substrates of complex shapes and on particulate materials can be deposited in a fluidized-bed system.
7. Gas flow conditions are usually laminar, resulting in thick boundary layers at the substrate surface.
8. The deposits usually have a columnar grain structure, which is weak in flexure. Fine-grained, equiaxed deposits can be obtained by gas-phase perturbation of chemical reactions by various techniques.
9. Control of vapor phase reactions is critical for achieving desirable properties in the deposit.
10. A wide variety of metals, alloys, ceramics, and compounds can be manufactured as coatings or as free-standing components.

It is clear that chemical vapor deposition is a versatile technique for the deposition of coatings of a wide variety of materials, as well as for the fabrication of free-standing structural components.

Bibliography

- Besmann, T. M., D. P. Stinton, and R. A. Lowden, "Chemical vapor deposition techniques," *MRS Bulletin*, November 1988.
- Bhat, D. G., "Chemical vapor depositor," chap. 2, in *Surface Modification Technologies — An Engineer's Guide*. T. S. Sudarshan, Ed. New York: Marcel Dekker, 1989, p. 141.
- Blocher, J. M. Jr., "Chemical vapor deposition," chap. 8, in *Deposition Technologies for Films and Coatings: Developments and Applications*. R. F. Bunshah et al., Eds. Park Ridge, NJ: Noyes Publications, 1982, p. 335.
- Bryant, W. A., "Chemical vapor deposition," chap. 6, in *Surface Modification Engineering, Vol. I: Fundamental Aspects*. R. Kossowsky, Ed. Boca Raton, FL: CRC Press, 1989, p. 189.

- Holz, R. A., "Chemical vapor deposition techniques," *Techniques of Materials Preparation and Handling — Part 3* (Techniques of Metals Research Series, vol. 2). R. F. Bunshah, Ed. New York: Interscience Publishers, 1968, p. 1377.
- Pierson, H. O. (Ed.), *Chemically Vapor Deposited Coatings*. Columbus, OH: American Ceramic Society, 1980.
- Powell, C. F., J. H. Oxley, and J. M. Blocher, Jr. (Eds.), *Vapor Deposition*. New York: John Wiley & Sons, 1966.
- Yee, K. K., *International Metals Reviews*, Review No. 226 (1978).

36

Solvent Vapor Emission Control

36.1	Regulatory Background	36-1
36.2	Alternative Control Processes for Volatile Organic Compounds.....	36-2
	Safety • Operating Costs	
36.3	Vapor Oxidation.....	36-3
36.4	Solvent Recovery	36-5
	Carbon Adsorption • Direct Vapor Condensation	

Richard Rathmell
Consultant, Londonderry, NH

For business operations that include the wet coating of a surface, followed by drying, the amount of volatile organic compound (VOC) released to the atmosphere is important. Increased awareness of ambient air quality, and various regulations affecting solvent vapor emissions do not change the need to make a business economically profitable.

36.1 Regulatory Background

For a perspective on the VOC regulations, the government now monitors ambient air quality to measure several contaminants: particulates (dust), sulfur dioxide (SO₂), ozone, and others. The amount of ozone is associated with “smog” and volatile organics in the air; it is most noticeable on hot summer days and in metropolitan areas. Industrial coating operations are important point sources that may emit tons of VOC. Automotive traffic and refueling release much more VOC, but the thousands of smaller sources are not as easy to control.

The federal Clean Air Act of 1961 promulgated an important set of regulations that establish limits and also require the states to act to meet ambient air quality standards. State regulations may be more stringent than federal regulations, but not less. Also, local regulations, such as county, municipal, or regional authority, may be more stringent. In some areas, the state or local authorities are judged by some to be too lenient toward emissions and by others to be antibusiness in enforcement of regulations. In many areas, the industrial emissions have been reasonably well controlled, but the ambient ozone standard of 0.12 ppm ozone has not been attained. (This is unrelated to the “ozone depletion” problem at high altitudes.)

The federal government now discriminates between “attainment areas” and “nonattainment areas.” Regulations also discriminate between New Sources and Existing Sources. New source performance standards may be based on a cost–benefit analysis, but in some nonattainment areas, a more stringent LAER (lowest achievable emission rate) may be required, to be negotiated on a case-by-case basis. Existing sources and some new sources may be subject to RACT (reasonable available control technology).

Typically, a state agency will control the permit applications and approval for an industrial operation. However, it must be determined locally what regulations and limits are applicable and who will control the permitting process.

36.2 Alternative Control Processes for Volatile Organic Compounds

The business and process decisions facing those who apply and dry a wet surface coating to a product require consideration of several factors, including the following:

1. Product quality needs
2. Safety
3. Regulatory and air quality restrictions
4. Costs
5. Ease and reliability of operation

The process alternatives include the following:

1. Reformulation
 - A. Conversion from solvent-based to a water-based wet formulation
 - B. Conversion to a high solids formulation with little or no volatile component
2. Vapor destruction
 - A. Thermal oxidation of the organic compound to produce carbon dioxide and water vapor
 - B. Catalytic oxidation
3. Vapor recovery
 - A. Absorption–desorption using activated carbon
 - B. Direct vapor condensation

Reformulation has been the subject of considerable research, which is beyond the scope of this chapter. Much success has been achieved, but in many cases, the use of VOCs gives a superior end product quality or advantage. Safety in handling solvents and costs require examination.

Vapor destruction, or oxidation, typically requires less capital expense than vapor recovery, but the extra cost for recovery facilities may be cost justified if an appreciable amount of solvent can be reused, reducing the required annual purchase of new solvent. If oxidized, some heat energy may be recovered from the solvent, but in all cases, additional energy must be purchased to operate the vapor oxidizer.

Where carbon adsorption–desorption facilities are used to recover solvents, it sometimes costs more to recover the solvent than to purchase new solvent; such extra costs are justified by the need to avoid air pollution.

There is no control process that is preferred for all situations. It is necessary to consider specific cases to determine what will be preferred. Typically, however, thermal oxidation will be preferred for smaller rates of vapor emissions or where the solvent cannot be reused, and catalytic oxidation will be considered only where the airflow required for fume capture leads to relatively dilute vapor concentrations. Solvent recovery by direct vapor condensation will be preferred where larger amounts of vapor can be reused and new dryers are planned.

36.2.1 Safety

Process safety while handling volatile organic compounds requires sure methods of avoiding fire and explosion damage.

The conventional procedure, in which solvent-based coatings are applied and dried, is to sweep the organic vapors away with an excess airflow, such that the vapor concentration is too low to sustain combustion, should an ignition temperature develop.

Typically, at least 300 to 400 volumes of air are used to dilute one volume of vapor so that it cannot be ignited, and it is not uncommon to use several thousand volumes of air per volume of vapor.

It should be understood, however, that fire and explosive hazards also can be controlled by maintaining an oxygen concentration too low to sustain combustion. The common solvents will not ignite or sustain combustion in an atmosphere containing less than 10 to 13% oxygen (versus air with 21% O₂). This control procedure is a key to an economical condensation solvent recovery process.

36.2.2 Operating Costs

The cost for controlling vapor emissions is largely dependent on the amount of air that is admixed with the vapor. Excess air can provide the advantage of more assured safety and/or greater percentage of vapor capture in a fume hood, but the excess air greatly adds to the cost of removing the vapor from the air.

In industrial operations that incorporate a vapor incinerator or vapor recovery system, it is important to minimize the flow of dilution air to a degree that does not sacrifice safety. For example, toluene vapor in concentrations below 1.2% vapor in air are too lean to sustain combustion if ignited, and toluene vapor concentrations above 7.1% are too rich to sustain combustion if ignited. These limits are called LEL (lower explosion limit) or LFL (lower flammable limit), or UEL or UFL for the upper limits. Other solvents have slightly different limits, which are applicable under "normal" dryer conditions up to 200°F.

It is common practice to ensure that a dryer exhaust flow is not more than 25% LEL (a fourfold safety factor) to minimize the risk of combustible mixtures within the dryer. The National Fire Protection Association standards will permit vapor concentrations "not to exceed 50% of the LEL," provided a continuous indicator and alarm setup is arranged to shut the system down at a somewhat lower wet point. However, when the average exhaust concentration is in the range of 40 to 50% LEL, the absence of higher concentrations within the dryer cannot be guaranteed. Relatively few dryers are normally operated with 40% or higher LEL vapor concentrations.

On the other hand, where printing is applied to a small percentage of a surface, such as in a multicolor rotogravure line or flexographic line, it is typical for substantially more air to be used per unit of solvent applied, and for the total exhaust mixture to be relatively low in LEL concentration.

Effective vapor capture sometimes requires more airflow than the LEL safety consideration.

36.3 Vapor Oxidation

Most of the common solvent vapors may be oxidized and converted into clean and harmless carbon dioxide and water vapor. However, chlorinated solvents would produce objectionable hydrochloric acid vapors if oxidized.

A thermal oxidizer typically is operated in the 1200 to 1500°F range, with a hot gas retention of 0.3 to 0.6 sec to achieve substantially complete oxidation of the organic materials.

Catalytic oxidizers typically are operated several hundred degrees cooler than thermal oxidizers, with temperatures depending on the specific catalyst used and the concentration of vapors oxidized.

The more expensive noble metal catalysts, such as platinum, will tolerate temporarily higher temperatures than cheaper catalysts, which are susceptible to thermal deactivation. Some impurities in the air may poison any catalyst.

The heat energy released by the vapor oxidation may, in some cases, be useful for heating the process dryers or ovens. Usually, the high temperature gases from the oxidizer are used to preheat the cooler vapor-laden air, and residual heat is still sufficient to process needs.

The cost of oxidizing a given amount of vapor depends on how much dilution air is present or, for a given amount of air, how much vapor is present. More air requires a larger incinerator to retain the hot gases for the minimum time required to complete the oxidation reaction, and more energy is required to bring the air to the combustion (oxidation) temperature.

TABLE 36.1 Operating Variables^a for Thermal and Catalytic Incinerators

Variable	Type of Incinerator				
	Thermal		Catalytic		
LEL in exhaust, %	40	25	10	10	5
Volume of exhaust, ft ³ /min	208	333	833	833	1667
Assumed exhaust temperature	200	200	200	100	100
Assumed combustion temperature	1400	1400	1400	900	900
Temperature rise required	1200	1200	1200	800	800
Temperature rise resulting from vapor oxidation	1160	725	290	290	145
Temperature rise required from preheater or auxiliary fuel	40	745	910	510	655
Requirement from preheater or other fuel, Btu × 10 ³ /h	9	170	820	460	1180
Available temperature differential across heat exchanger (with no other fuel used)	1160	725	290	290	145
Ratio of heat exchanger area ^b required (to avoid auxiliary fuel consumption)		1	12	6.75	35

^a All temperatures in degrees Fahrenheit.

^b Assuming equal coefficient; $A = Q/\Delta T$, where A = the heat transfer area, Q = heat flow, and ΔT = temperature differential.

However, if the vapor concentration is maintained close to 40% LEL or above, the solvent vapor can supply substantially all the energy required. At lower concentrations, it becomes increasingly necessary to supply auxiliary fuel or to provide more air–air heat transfer to preheat the vapor laden air.

For example, one cubic foot of toluene vapor diluted with more or less air in the exhaust flow to be incinerated will be as shown in Table 36.1.

From Table 36.1, it can be appreciated that a reduction in airflow (for a given flow of solvent vapor) will proportionately reduce the size of the vapor incinerator, but the size of heat exchanger or the amount of added fuel required is affected to a much greater degree.

It is theoretically possible to provide enough heat exchanger capacity to obviate the need for additional fuel for normal operation. In practice, an auxiliary fuel burner is needed for start-up, and it must be kept ignited and ready to heat the air when the vapor concentration decreases.

Heat exchangers for vapor thermal oxidizers usually are the shell-and-tube type, using stainless steel tubes, or ceramic beds. Some metal plate–plate exchangers also are used, but in every case, it is important to prevent leakage or short-circuiting of vapor-laden air to the exhaust gases, or bypassing the combustion zone. Such leakage or bypassing can generate objectionable odors from partially oxidized organics.

The ceramic bed heat exchangers operate by periodically reversing the flow direction through at least two or more beds, which are alternately heated and cooled. Outgoing hot combustion gases flow through a bed until the ceramic pieces reach a set temperature, then the flow is reversed and vapor-laden gases are heated so they flow through the hot bed into the combustion zone. There is no problem if the vapor-laden gases ignite in the bed prior to the combustion space, but before flows are switched back, it is desirable to first purge vapor-laden gases from the cooking bed into the combustion zone. Nonoxidized vapors should not be pushed out with exhaust flow. With relatively large beds, it is practical (but not inexpensive) to provide the high heat transfer area needed to accommodate relatively dilute vapor flows. The bed size required can be minimized by a high frequency of flow switching; the airtight dampers may be switched every few minutes. The ceramic pieces must be selected to tolerate frequent temperature changes and to accommodate the thermal expansion–contraction cycle that occurs. If dust is released by thermal movements or abrasion, it may prevent direct usage of the residual hot gases in the dryers and ovens.

Metal surface heat exchangers, with hot combustion gases in one side and the cooler vapor-laden gases on the other side, operate continuously, without flow reversal or switching dampers. Thermal expansion–contraction can be a problem, leading to torn welds or fractures and to leakage of the higher pressure vapor-laden air into the lower pressure oxidized discharge flow. Such leakage can generate objectionable odors by the scorching of the vapors.

In heat exchangers of the shell-and-tube type, longer tubes with baffled counterflow over the tubes are more efficient than short tubes with cross-flow.

A recent development, patented by the Wolverine Corporation (Merrimac, MA), overcomes the expansion problem with long-tube heat exchangers; the tube is free to expand and contract at one end within a slip tube that acts as an air aspirator. In this arrangement, a small amount of lower pressure oxidized vapor is allowed to leak back into the oxidation zone; leakage in this direction is acceptable.

36.4 Solvent Recovery

Solvent recovery may be preferred to vapor oxidation if the solvent can be reused, allowing a company to save substantially on the purchase of new solvent. Although vapor oxidation can return some energy value from the solvent, usually the “chemical” value is appreciably more than the energy value.

There are two important approaches to solvent recovery: activated carbon and direct condensation. The carbon approach is substantially more costly. The condensation approach is not always applicable, but it can be much less expensive when the dryers for a coated web and condensers are designed as a system.

36.4.1 Carbon Adsorption

When a carbon bed is installed to capture solvent vapors exhausted with air from a dryer, it is usual to provide two or more carbon beds and to periodically desorb from one while adsorbing in the other(s). Desorption is accomplished by heating the bed and sweeping the vapors out, typically with steam.

The steam and vapors are then condensed, and the steam condensate (water) must be separated from solvent. Typically about 3 to 4 or up to 10 lb of steam is used per pound of solvent recovered. If the recovered solvent is soluble in water (alcohols, ketones, etc.), the need to separate the water presents additional expenses. Some vapors, such as methyl ethyl ketone, adsorb onto carbon with so much heat release that precautions are needed to prevent spontaneous ignition from burning up the air-swept carbon bed.

There are many carbon adsorption systems in which the value of solvent recovered exceeds the cost of operation. Often, however, it costs more to recover the solvent than to buy new solvent. In such cases, the higher recovery cost is charged to the need to avoid air pollution.

36.4.2 Direct Vapor Condensation

Direct vapor condensation can be more economical than using carbon beds for solvent recovery. The energy consumption is usually less than 10% of the energy to operate a conventional air-swept dryer and carbon bed, and there is no water added to the solvent by the process. Also, there is no exhaust flow to the atmosphere in the preferred designs. The vapor condensers are much smaller than required for carbon bed recovery system, and there is another advantage in that when two or more dryers are operated with different solvents or blends of solvents, separate vapor condensers avoid the mixing of solvents and the costs of separating them. Usually, a water chiller type of refrigeration system is required, but one system can serve all the condensers.

However, there are limitations on the applicability of this process: the process dryers must be substantially “airtight” to permit the contained atmosphere be recirculated countless times with a minimum of interchange with outside atmosphere. Indirect heaters, such as steam coils, are necessary. Also, the oxygen level in the contained atmosphere should be kept below the limit (10 to 13% O₂) that would sustain combustion; otherwise, it is necessary to use very cold condensers and relatively high recirculation rates to keep the vapor levels safely below the vapor LEL limits. There is a need for a relatively small flow of inert (low oxygen content) gas to offset the tendency for the wet web to drag air (21% O₂) into the dryer, and it is necessary to maintain a ready reservoir of pressurized inert gas (a) to facilitate a rapid air purge and dryer start-up after the dryer has been opened for any reason, and (b) to provide a safety cushion for a fail-safe shutdown during an electrical power outage.

The sources of inert (low oxygen) gas required include the flue gas of a gas-fired steam boiler and purchased liquid nitrogen or carbon dioxide. Where flue gases are used, the gas burner must be of the type that can maintain a low ratio of excess air to fuel for various fuel firing rates. A compressor and pressurized storage tank can provide the ready reservoir for last start-up and fail-safe shutdowns, or a tank of liquid nitrogen with vaporization facilities can be used.

In some important respects, the operation of an inerted airtight dryer is inherently safer than a conventional air-swept dryer. In an air-swept dryer there is a transition zone between a flammable wet interface and a nonflammable exhaust, and there is the potential for a temporary excess solvent loading into the dryer to produce a large volume of combustible mixture. In an inerted dryer, there is no flammable interface, and any temporary excess solvent loading will not make a combustible mixture. When the coating process and wet web is stopped for any reason, there is no tendency for outside air to exchange with the atmosphere contained in the dryer, except as air may be drawn in to replace the volume of vapor condensed, or to make up for gas volume contraction as the contained gas cools down. In the Wolverine systems, the normal operating vapor concentration in the dryer is designed to prevent the condensation due to vapor volume of any unsafe air inhalation into the dryer. Normally, the vapor condenser temperature is selected to draw the vapor concentration below the organic LEL level when the coating process is stopped. This then provides a double safety factor with both a safe O₂ LEL level and a safe organic-in-air LEL level.

When a dryer is shut down overnight or for a weekend, it is not necessary or desirable to purge the contained atmosphere to the outside atmosphere.

37

Surface Treatment of Plastics

37.1	Introduction	37-1
37.2	Functions of Surface Preparation	37-1
	Removal of Contamination • Control of Surface Roughness • Matching of Surface to Adhesive • Providing a Boundary Layer • Control of Oxide Formation • Control of Absorbed Water	
37.3	Factors Impacting Preparation Intensity.....	37-2
	Type of Plastic • Surface Contamination • Initial and Ultimate Strength Requirements • Service Environment • Time • Component Size • Cost 2	
37.4	Surface Preparation Techniques.....	37-3
	Solvent Cleaning • Detergent Cleaning • Mechanical Treatment • Chemical Treatment • Other Treatments	
37.5	Evaluation of Surface Preparation	37-6
	Bibliography	37-7

William F. Harrington, Jr.
*Uniroyal Adhesives and Sealants
Company, Inc.*

37.1 Introduction

No single step in the coating process has more impact on film adhesion than surface preparation. Film adhesion to a plastic is primarily a surface phenomenon and requires intimate contact between the substrate surface and the coating. However, intimate contact of that plastic surface is not possible without appropriate conditioning and cleansing.

Plastic surfaces present a number of unique problems for the coater. Many plastics, such as polyethylene or the fluorinated polymers, have a low surface energy. Low surface energy often means that few materials will readily adhere to the surface. Plastic materials often are blends of one or more polymer types or have various quantities of inorganic fillers added to achieve specific properties. The coefficient of thermal expansion is usually quite high for plastic compounds, but it can vary widely depending on polymer blend, filler content, and filler type. Finally, the flexibility of plastic materials puts more stress on the coating, and significant problems can develop if film adhesion is low due to poor surface preparation.

37.2 Functions of Surface Preparation

Treatment of the plastic surface performs a great many functions depending on the individual polymer type involved.

37.2.1 Removal of Contamination

Any substance that interferes with the contact between the coating film and the plastic must be removed. Process oils, dirt and grime, waxes, mold release agents, and poorly retained plasticizers must all be removed.

37.2.2 Control of Surface Roughness

No surface is perfectly smooth, and various techniques enable the coater to match the finish on the plastic component to the coating viscosity for improved film adhesion.

37.2.3 Matching of Surface to Adhesive

Conversion of the outside surface of the plastic can provide an interface that is more like, or more compatible with, the chemical structure of the coating.

37.2.4 Providing a Boundary Layer

Plating or coating the surface with a primer often provides a more suitable surface for coating adhesion.

37.2.5 Control of Oxide Formation

Polymers generally exhibit good resistance to oxidation, but because an oxidized surface has a higher level of surface activity, several procedures promote oxide formation.

37.2.6 Control of Absorbed Water

Many plastics readily absorb moisture from the surrounding atmosphere. This moisture can interfere with film adhesion, especially for coatings that require heat cure cycles.

37.3 Factors Impacting Preparation Intensity

Often the goal of surface preparation is to accomplish several of the functions listed in Sections 37.2.1 to 37.2.6. A sequential series of cleaning techniques is appropriate where a single step or process might prove inadequate. In fact, the intensity of surface preparation procedures used depends on a variety of factors, all of which must be considered in the product design process.

37.3.1 Type of Plastic

Higher surface activity reduces the need for surface preparation. Some molded thermoplastic parts that require a high melt temperature and a fast cool-down cycle are more easily coated. Many thermoset plastics, such as phenolic, are readily coated.

37.3.2 Surface Contamination

The type and level of contamination will dictate the degree of cleaning required. Silicone release agents on molded parts require intense cleaning procedures.

37.3.3 Initial and Ultimate Strength Requirements

Film adhesion develops faster on prepared and clean surfaces. In addition, higher adhesion values are achievable with higher levels of surface cleaning.

37.3.4 Service Environment

Better surface adhesion generally indicates a more permanent coating, one more adaptable to end-use conditions.

37.3.5 Time

Delays between surface preparation and coating application often require repetition of preparation steps to reclean, or higher levels of cleaning to start with, to overcome possible recontamination.

37.3.6 Component Size

Typically, large parts are more difficult to process than small parts, and certain processes are not suitable or available for large parts.

37.3.7 Cost

Within the manufacturing/product cost cycle, certain limitations have an impact on the degree of preparation utilized. Limitations on surface preparation procedures can affect returned goods and warranty claims, costs often overlooked in the design phase.

37.4 Surface Preparation Techniques

As may be expected, there are nearly as many procedures for cleaning and preparing plastic surfaces as there are polymer types. Some procedures are inexpensive and easy to accomplish; others are not. Most plastic types have a few highly recommended procedures for achieving the best finish for coating, but often the user is faced with many equally valid choices, or worse, conflicting advice on the level of intensity.

Plastics can be obtained in a variety of forms: molded, sheet, shaped part, foam, and film. Many polymers can be readily blended together to achieve specific properties. Fillers and plasticizers are also included in the resin matrix to yield certain characteristics. Obviously, the same surface preparation procedure may not be appropriate in each of these cases, even though the major ingredient remains the same.

The manufacturers of both the plastic and the coating should be prepared to give advice on appropriate surface preparation techniques to use with the product. However, because user needs differ so widely, even the manufacturer may not have a definitive answer for an individual circumstance. Considerable experimentation may be required to identify the appropriate technique for a given operation.

The procedures outlined in the remainder of this chapter concentrate on the technique, rather than the plastic. Where appropriate, however, certain techniques have a listing of the polymer types for which they are most suitable.

Finally, many of the processes utilize hazardous, corrosive, toxic, flammable, or poisonous chemicals. Safe handling methods, worker training, and appropriate control procedures are essential to minimize risk in the work environment.

37.4.1 Solvent Cleaning

Solvent action removes surface contamination by dissolving the unwanted substance. This is the easiest and most commonly used procedure and often serves as a first step in more complex procedures.

Organic solvents and water are the solvents recommended. The organic solvents can be flammable or nonflammable. Most commonly used for plastics are acetone, methyl ethyl ketone, isopropyl alcohol, methyl alcohol, toluol, 1,1,1-trichloroethane, naphtha, and sometimes Freon (either by itself or blended with another solvent). Water is cheap and readily available but often has trace levels of impurities, which can also contaminate surfaces. Most often recommended is distilled or deionized water. Water is frequently used as a rinse for other surface preparation procedures.

These solvents can be used in processes as simple as the wiping of a dampened cloth across the plastic. Immersion is a technique usually accomplished by submerging the part in a swirling bath with heat applied to speed the solvent action. Spray cleaning has the advantage of washing off the contamination with the force of the spray. Vapor degreasing requires that the plastic part be suspended over a boiling tank of solvent. As the vapors condense on the part, the constant flow over the surface washes it clean. Ultrasonic degreasing utilizes high frequency vibration from sonic waves to dislodge the contaminants in a solvent bath.

In all cases, frequent changing or filtering of the solvents is recommended to prevent residue buildup and recontamination. Compatibility of the solvent with the plastic should be thoroughly checked. Since some plastics absorb water, care should be taken. Heat is often used to dry the parts after washing, but heat can readily distort thermoplastics.

37.4.2 Detergent Cleaning

Soaps and detergents do for plastic components what they do in the dishwasher and washing machine at home.

Emulsification of oils, greases, and some mold releases is easily achieved in either hot or cold water solutions. Detergent cleansing is often used as a preliminary step to mechanical treatments.

The names of the cleaners are familiar, as they are frequently items found in the home. Ivory soap, Ajax, Borax, and trisodium phosphate are all recommended in various cleaning operations and do quite well.

An immersion wash is quite effective, unless the plastic is water sensitive. Scouring with a medium-to-stiff bristle brush is excellent for dislodging many contaminants.

Solution cleanliness must be monitored. A clean water rinse is essential because soaps can act as contaminants if not washed off. Thorough drying at elevated temperatures is recommended.

37.4.3 Mechanical Treatment

Physical scrubbing of plastic surfaces removes oxides and contaminated layers. A solvent or detergent cleaning must precede the mechanical treatment to avoid scrubbing surface contaminants into the roughened surface. This process often comes before chemical treatments.

Sanding, either wet or dry, is a commonly used procedure, using a grit size of 40 to 400, depending on the amount of surface to be removed and the surface finish desired. Softer plastics are obviously more susceptible to damage. For parts that have a complex configuration, grit blasting (wet or dry) or wire brushing is more appropriate. Grit size and type can be varied to obtain the proper finish. Machining can be used to expose fresh layers of plastic to coat.

In all cases, the roughened surface should be vacuumed or air blasted to remove residual dust or grit. A solvent wipe or water rinse followed by elevated temperature drying is also recommended.

37.4.4 Chemical Treatment

Generally, the most effective surface preparation is a chemical etch of the plastic to be coated. Both physical and chemical characteristics can be altered to improve wet-out and film adhesion. Nearly always, chemical treatment is preceded by one or more cleaning operations to remove surface contamination. These prior operations reduce solution contamination and ensure optimum interaction between the solution and substrate.

Most often, the surface is washed or immersed in a bath containing an acid, base, oxidizing agent, chlorinating agent, or other highly active chemical. Each procedure requires control of the parts by weight of active ingredients, the temperature of the solution, and the elapsed time of immersion. Some procedures have a wide range of ingredient ratios, while others are quite specific. Temperature of the solution is inversely related to time of the immersion; that is, the higher the temperature, the shorter the exposure.

Virtually all chemical etch procedures require water rinsing (once or twice), and an elevated temperature drying is recommended. With active ingredient treatments, it is imperative that solution strength be monitored and renewed at appropriate intervals.

37.4.4.1 Sulfuric Acid–Dichromate Etch

By far the most commonly recommended chemical treatment for plastic parts, the sulfuric acid–dichromate etch is used on acrylonitrile–butadiene–styrene (ABS), acetal, melamine or urea, polyolefins, polyphenylene oxide, polystyrene, polysulfone, and styrene–acrylonitrile (SAN). For each plastic, a different ingredient ratio and immersion temperature and time may be recommended.

The following list is offered as a guide to a possible range of parameters:

Ingredient	Parts by Weight	Range
Potassium or sodium dichromate	5	0.5–10.0
Concentrated sulfuric acid	85	65.0–96.5
Water	10	0–27.5
Time	10 sec to 90 min	
Temperature	Room temperature to 160°F	

While the ranges are extremely wide, experimental trials coupled with test results will allow the user to identify the most appropriate values for a given plastic.

37.4.4.2 Sodium Etch

For truly difficult surfaces to coat, such as the various fluoroplastics and some thermoplastic polyesters, highly reactive materials must be used. Metallic sodium (2 to 4 parts) is dispersed in a mixture of naphthalene (10 to 12 parts) and tetrahydrofuran (85 to 87 parts).

Immersion time is approximately 15 min at ambient temperatures, followed by thorough rinsing with solvent (ketone) before water rinsing.

37.4.4.3 Sodium Hydroxide

A mixture of 20 parts by weight of sodium hydroxide and 80 parts of water is an effective treatment of thermoplastic polyesters, polyamide, and polysulfone. Heating the solution to 175 to 200°F and immersing for 2 to 10 min is appropriate.

37.4.4.4 Satinizing

Satinizing is a process developed by DuPont for their homopolymer grade of acetal (U.S. Patent 3,235,426). Parts are dipped in a heated solution of dioxane, paratoluene sulfonic acid, perchloroethylene, and a thickening agent. After the dip cycle, parts are heat treated, rinsed, and dried according to a prescribed procedure.

37.4.4.5 Phenol

Nylon is often etched with an 80% solution of phenol in water. Generally, the treatment is conducted at room temperature by brushing onto the surface and drying for about 20 min at approximately 150°F.

37.4.4.6 Sodium Hypochlorite

A number of plastics, particularly the thermoplastic types and the newer thermoplastic rubbers, can be chlorinated on the surface by applying a solution of the following ingredients (parts by weight):

Water: 95 to 97

Sodium hypochlorite, 15%: 2 to 3

Concentrated hydrochloric acid: 1 to 2

Parts can be immersed for 5 to 10 min at room temperature, or the solution can be brushed onto the surface for the same period.

37.4.5 Other Treatments

A variety of other cleaning and preparation techniques are available. Many of these procedures are unique to plastic processing and were developed to overcome the low surface activity many plastics exhibit. For best results in most cases, these treatments require the prior removal of surface contamination by solvent or detergent cleaning.

37.4.5.1 Primers

Primers are an adhesion-promoting coating used to develop better adhesion of the final coating to the plastic substrate. The primer can be any number of chemical types, including silanes, urethane polymers, isocyanates, nitrile phenolic, or vinyl. To protect the substrate from recontamination, a primer is usually coated onto the surface soon after other surface preparation procedures have been completed.

37.4.5.2 Flame Treatment

The impingement of a flame on many plastics, such as the polyolefins, acetal, fluoropolymers, and polycarbonate, oxidizes the surface to provide a higher level of surface energy and better film adhesion. This process can be especially effective on complex shapes and molded parts. Superheated air (1000°F) performs much the same function as a flame.

37.4.5.3 Exposure to Ultraviolet Radiation

Highly intense radiation from an ultraviolet source provides an ionized or highly polar surface.

37.4.5.4 Drying

Since many plastics readily absorb atmospheric moisture, simple oven drying can be effective.

37.4.5.5 Plasma Treatment

Most plastics benefit from a plasma treatment. Parts are exposed to gases, which are ionized by radio frequency or microwave discharge. Effective gases include neon, helium, oxygen, and moisture vapor. Although very effective in improving surface conditions that promote better film adhesion, this process usually is limited by equipment restrictions to smaller components and parts.

37.4.5.6 Corona Discharge

For film and other thin gauge plastics, surface tension can be improved by passing between two electrodes. This treatment is suitable for high speed operations.

37.5 Evaluation of Surface Preparation

In the early stages of developing an appropriate surface preparation technique, it is necessary to have an adequate screening test to determine the effectiveness of the process. There are several methods and tests available:

Water break test. Water poured on a clean surface will be smooth and will sheet across the face. On an oily or poorly treated surface, however, water will bead. This test has limited effectiveness on low polarity surfaces such as polyolefins and fluoroplastics, and it is not recommended for surfaces that absorb moisture.

Contact angle test. A drop of a standardized reference fluid will have a defined contact angle at the edge of the drop. Well-prepared surfaces are easier to wet and will exhibit lower contact angles than unprepared surfaces.

Tape test. A flexible tape can be applied to the surface and a peel test conducted. The tape should be applied under controlled conditions, with standardized pressure and a defined dwell time. For consistent results, the type, width, and brand of tape should remain constant.

Quick strip test. After a part has been coated and properly conditioned, a grid pattern of cuts through the coating is made. A standard tape is applied with constant pressure to the surface and then

quickly stripped. Counting the number of squares of the grid that were removed gives an indication of film adhesion.

Environmental testing. Once parts have been treated, coated, and conditioned, conducting a series of heat cycling, weatherometer, stress tests, and various exposure tests will determine the effectiveness of the coated part to meet end-use conditions.

Bibliography

Cagle, Charles V., *Adhesive Bonding*. New York: McGraw-Hill, 1968.

Military Standardization Handbook: Adhesive Bonding, MIL-HDBK- 691B, U.S. Department of Defense, 1987.

Snodgren, Richard C., *Handbook of Surface Preparation*. New York: Parmerton Publishing, 1974.

38

Flame Surface Treatment

38.1	Introduction	38-1
38.2	Surface Treatment	38-1
38.3	Burners	38-2
	Atmospheric Burners • Power Burners	
38.4	Film Treatment	38-4

H. Thomas Lindland
Flynn Burner Corporation

38.1 Introduction

The need for surface treatment was recognized shortly after the development of polyolefin materials, resulting in the evolution of various treatment methods. W. H. Kreidl pioneered the process of using an oxidizing flame on polyolefins to produce a surface receptive to printing and coating. At the same time, Kreidl's assistant, Kritchever, was developing the concept of using an electrical corona to produce the same result. The two men went their separate ways, and both methods have been widely used for the past 30 years for various surface treating applications.

38.2 Surface Treatment

The exact mechanism of surface treatment is still unknown. In spite of repeated efforts, using sophisticated instrumentation and complex laboratory methods, we still do not have an accurate understanding of the process. Fortunately, we do not need this information to use the process.

Solid surfaces have a surface energy specific for various materials. For a liquid drop to spread on a given surface, the liquid surface tension must be lower than the critical surface tension of the solid. Metal and glass exhibit a high surface energy, whereas plastics have a low surface energy. Pretreatment increases the surface energy and therefore its wettability. It may also eliminate a weak boundary layer, thus improving adhesion.

In flame treating, the high temperature of the combustion gases causes oxygen molecules to become disassociated, forming free, highly chemically active oxygen atoms. In addition, because of the energy in the high temperature combustion process, oxygen atoms may also lose electrons to become positively charged oxygen ions. Such an electrically neutral gas made of equal amounts of positively and negatively charged particles is known as a plasma. Plasma may be hot or cold.

In flame treating, these high speed, energetic, very reactive oxygen ions or free oxygen atoms bombard the plastic surface and react with the molecules. This process oxidizes the surface and requires an oxidizing flame, which is a flame with an excess of oxygen.

In corona treating, high voltage fields cause the oxygen molecules to break into free atoms, which can react with the plastic. Those that do not react with the surface recombine into molecules of normal

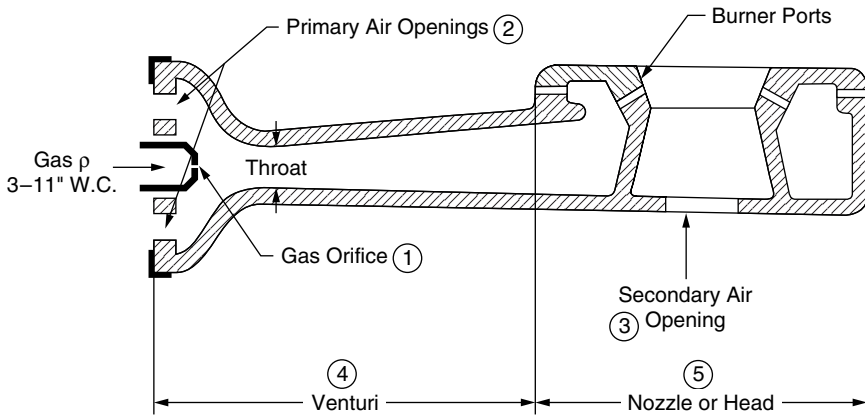

FIGURE 38.1 Atmospheric burner.

diatomic oxygen or into unstable molecules of ozone — triatomic oxygen. In addition, surface treatment involves many other complex reactions.

In many cases, the objective is to treat the surface to a predetermined critical surface tension expressed in dynes per centimeter. ASTM specification D-278-84 describes a method of evaluating the level of surface treatment. An increase in surface energy is usually related to an improved adhesion. However, sometimes a substrate may be wettable and still not provide the desired adhesion level. Flame treatment to a consistent level is required. This calls for maintaining the operating parameters constant and having a uniform substrate surface.

38.3 Burners

Several burner designs are available.

38.3.1 Atmospheric Burners

In an atmospheric gas burner, part of the air required for combustion is premixed with the gas prior to the point of ignition. The air premixed with gas is referred to as primary air. The remaining air, called secondary air, is drawn from the surrounding atmosphere at atmospheric pressure, and hence, the name atmospheric burner. The forerunner of the atmospheric burner system is the well-known Bunsen burner.

To deliver the air–gas mixture to the burner head, the principles developed by Venturi and Bunsen were utilized (Figure 38.1). Delivering gas through an orifice (1) at a pressure ranging from 3 to 11 in. of water column would produce about 40 to 60% of the primary air (2) required. As long as sufficient secondary air (3) is present, proper combustion can take place. The venturi mixer (4) coupled with a burner nozzle (5) or head became the mainstay of early gas applications. Many varieties of such burners exist today.

The need to distribute the flame in a wider pattern was resolved by providing a pipe with drill holes (Figure 38.2). Such burners work well but are limited to low energy output.

38.3.2 Power Burners

Once the flame has been established, the flame front burns back toward the source of the air–gas mixture. The front is stable only if the air–gas velocity matches the rate at which the mixture burns. If the velocity is too high, the flame will lift off the ports. If the velocity is too low, the flame will retract toward the source of the air–gas mixture and will cause a flashback. This tendency can be minimized by keeping the port areas small. The ignition temperature is also important. It takes approximately 630°C to ignite

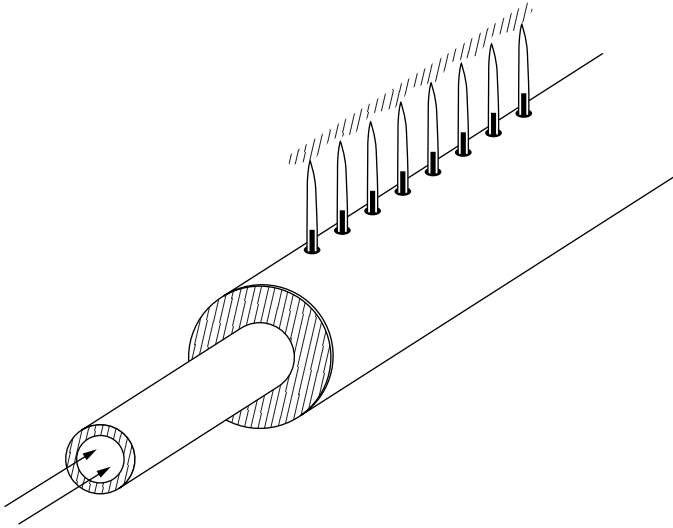

FIGURE 38.2 Pipe burner with drilled holes.

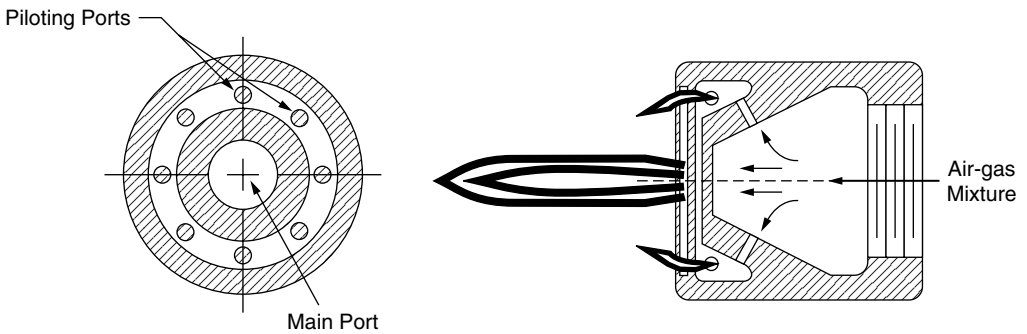

FIGURE 38.3 Gun-type nozzles.

natural gas, but only 480°C to ignite propane. The cool metal surrounding a port will quench the flame, provided there is sufficient mass to absorb the heat. This explains the need for a certain port depth.

The key in resolving these problems is to lower the velocity of a portion of the air–gas mixture or to limit the capacity of the burners. Gun-type nozzles were developed, as illustrated in Figure 38.3. A portion of the air–gas mixture is diverted into the small protected area (1). The velocity of this portion of the mixture is reduced until the piloting will provide continuous ignition to the main air–gas stream emitting from the large center port (2).

This allows the rate of mixture velocity out of the nozzle to be increased, increasing the heat output. This feature, known as flame retention, is inherent in all power burners. Unlike atmospheric burners, power burners utilize a power source of combustion air.

The flame retention feature was introduced to lie burners, such as drilled pipe burners. A single row of ports was drilled down the center and, following the pattern of the flame retention nozzle, rows of small holes were drilled on each side. Deflectors or ignition rails were placed over the two rows of piloting holes (Figure 38.4). Figure 38.5 illustrates a cross section of a typical drilled port line burner that is widely used in the industry today.

Ribbon burners (Figure 38.6) were developed by Harold Flynn. A suitable slot was milled out on a casting and the ribbon stack inserted. The velocity of a portion of the air–gas mixture was reduced, establishing piloting along each side of the rows of main ports, which were produced by the ribbon

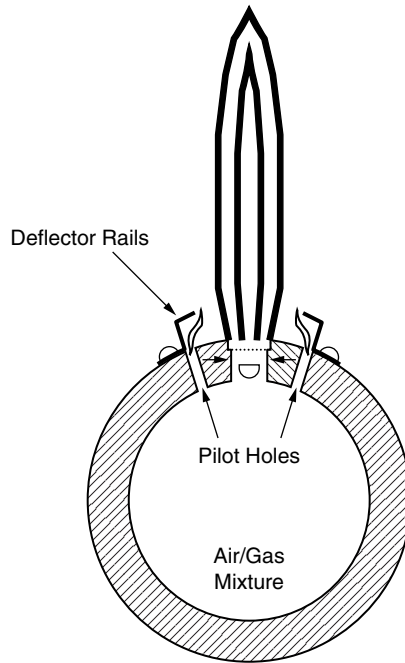

FIGURE 38.4 Line burner with deflector rails.

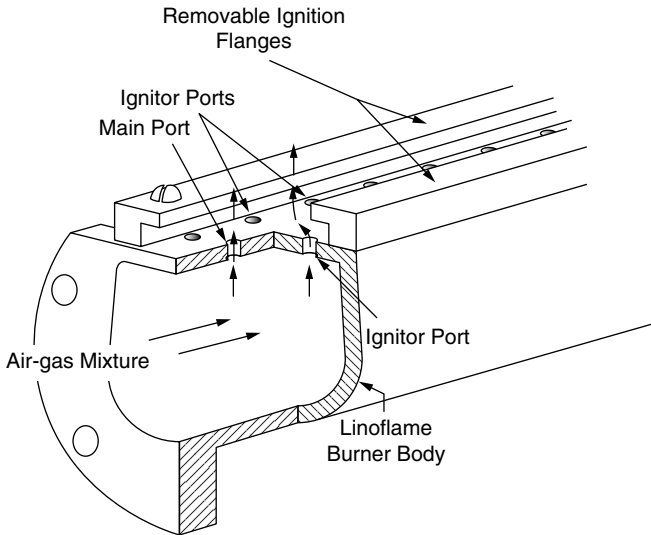

FIGURE 38.5 Drilled port line burner.

configuration (Figure 38.7). This eliminated any external deflectors or rails. Further refinements of ribbon line burners have made it possible to manufacture various slot widths and ribbon configurations to produce a variety of flame patterns.

38.4 Film Treatment

One of the problems associated with the attempt to utilize line burners for the treatment of polyolefin films was the requirement of increasing the flame velocity enough to penetrate the boundary air layer

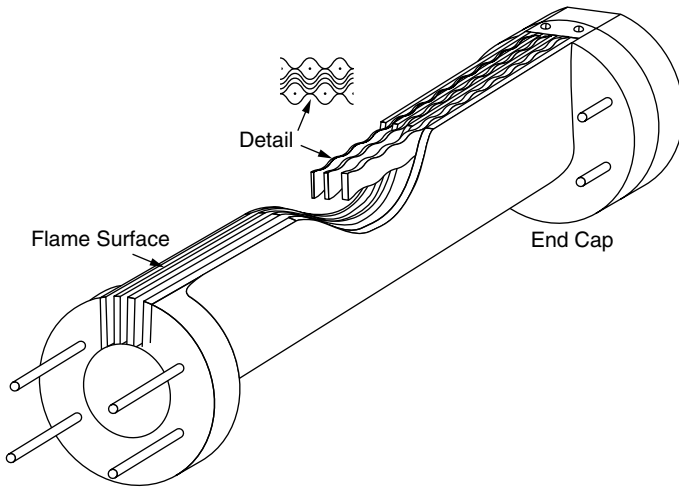

FIGURE 38.6 Ribbon burner.

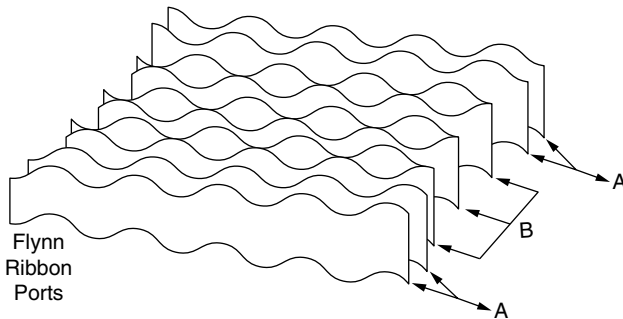
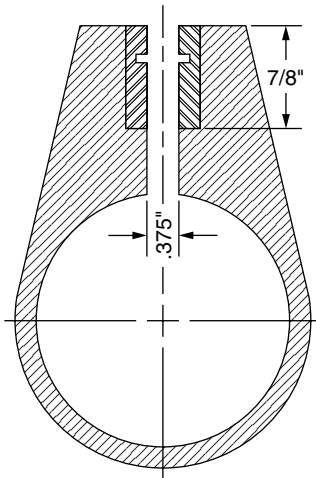

FIGURE 38.7 Ribbon burner details.

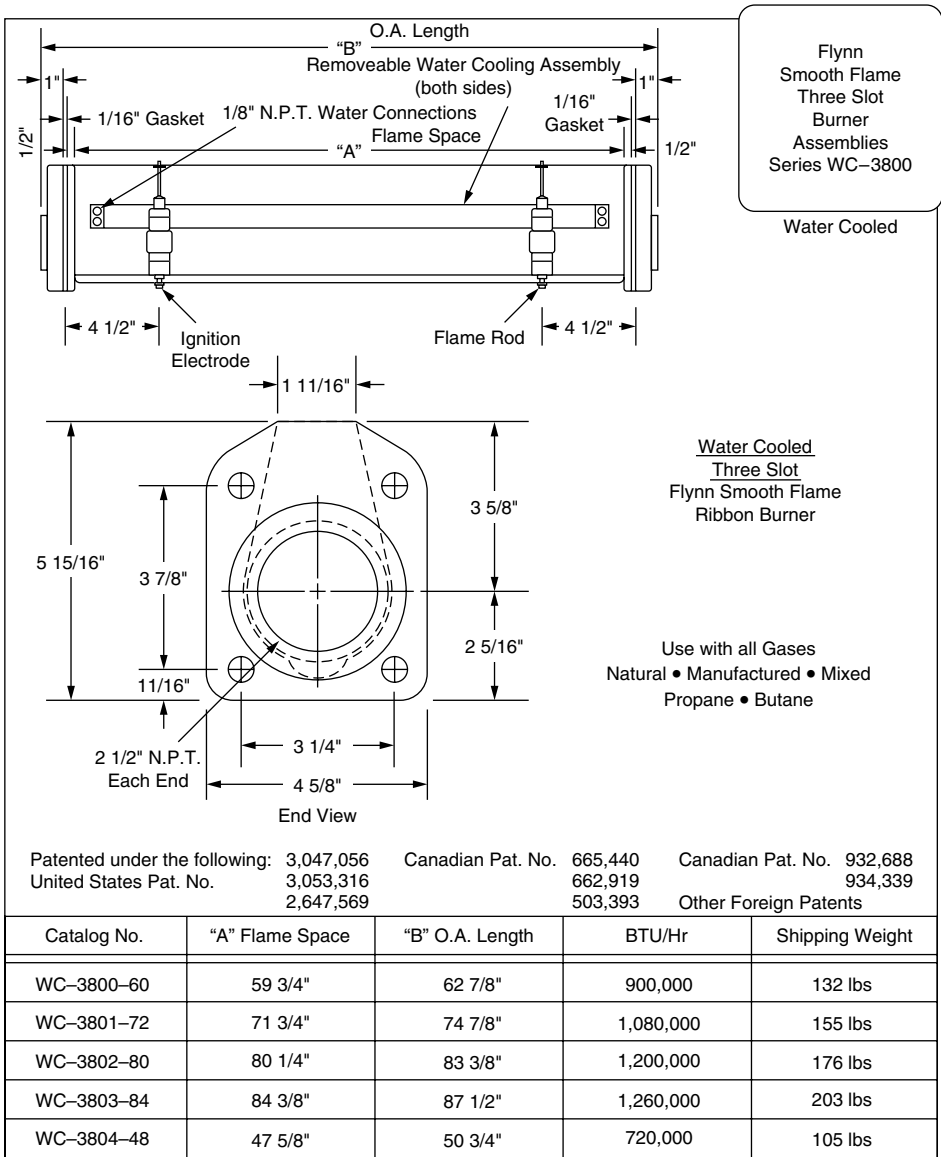

FIGURE 38.8 Type 3800 water-cooled smooth flame burner.

but not the web surface. To treat the substrate with direct flame, sufficient thermal energy had to be developed to penetrate this layer. Furthermore, the exit velocity of the burner flame had to be adjusted to varying web speeds.

The principle of a burner design to meet these requirements is shown in Figure 38.8. The ribbon channels of piloting or ignition flames firing at reduced exit velocities provide a constant supply of ignition to the center ribbon channel, enabling it to fire at exit velocities far in excess of the normal speed of flame propagation, greatly increasing the energy output of the burner.

Figure 38.9 shows a burner designed for film posttreatment application. It has a single slot due to the lower energy output requirement. The water cooling is built into the face. The side bars assure a smooth flame, which is required for the posttreatment process. The capacity, flame velocity, and flame retention capability are all related to the ribbon configuration. By varying the number of ports and the width of the ribbon stack, it is possible to produce a customized flame pattern for each application.

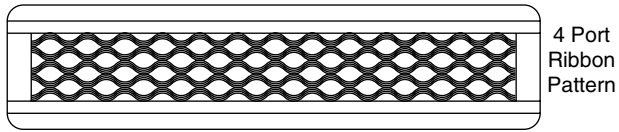

FIGURE 38.9 Details of four-port ribbon burner.

39

Plasma Surface Treatment

39.1	Introduction	39-1
39.2	Types of Plasma.....	39-1
39.3	A Typical Plasma Process Cycle	39-2
39.4	Plasma Chemistry	39-2
39.5	Surface Treatment Approaches.....	39-3
39.6	Plasma Activation of Plastics.....	39-4
39.7	Adhesion	39-5
39.8	Summary.....	39-6
	References.....	39-6

Stephen L. Kaplan
Plasma Science, Inc.

Peter W. Rose
Plasma Science, Inc.

39.1 Introduction

Gas plasmas make up 99% of our universe, existing mainly as stars. Although rare on earth, natural plasmas include lightning, the aurora borealis, and St. Elmo's fire. [Table 39.1](#) lists certain plasmas and characterizes them by particle density and temperature.

Plasmas can be produced and controlled by ionizing a gas with an electromagnetic field of sufficient power. One useful form of gas plasma is made by introducing gas into a reaction chamber, maintaining pressure between 0.1 and 10 torr, and then applying radio frequency (rf) energy. Once ionized, excited gas species react with surface of materials placed in the glow discharge.

The physical and chemical properties of plasmas depend on many variables; chemistry, flow rate, distribution, temperature, and pressure of the gases. Additionally, rf excitation frequency, power level, reactor geometry, and electrode design are equally important. Dissociated gas molecules quickly recombine to their natural state when the plasma's power source is shut off.

39.2 Types of Plasma

Plasmas occur over a wide range of temperatures and pressures, however, all plasmas have approximately equal concentrations of positive and negative charge carriers, so that their net space charge approaches zero.

In general, all plasmas fall into one of three classifications. Elements of high-pressure plasmas, also called *hot plasmas*, are in thermal equilibrium (often at energies >10,000°C). Examples¹ illustrated in [Table 39.1](#) include stellar interiors and thermonuclear plasmas. *Mixed plasmas* have high temperature electrons in mid-temperature gas (~100 to 1000°C) and are formed at atmospheric pressures. Arc welders and corona surface treatment systems use mixed plasmas. *Cold plasmas*, the focus of this chapter, are not in thermal equilibrium. While the bulk gas is at room temperature, the temperature (kinetic energy) of the free electrons in the ionized gas can be 10 to 100 times higher (as hot as 10,000°C),² thus producing an unusual, and extremely chemically reactive environment at ambient temperatures.

TABLE 39.1 Ranges of Particle Densities and Temperatures for Plasmas of Various Types

Plasma Type	Particle Density (no./cm ³)	Temperature (K)
Natural Plasmas		
Stellar interiors	10 ²² –10 ²⁵	~10 ⁸
Stellar atmospheres	10 ¹⁰ –10 ¹⁶	10 ⁴ –10 ⁶
Earth's ionosphere	10 ¹⁰ –10 ¹²	10 ² –10 ³
Man-made Plasmas		
Thermonuclear plasma	10 ¹² –10 ¹⁴	10 ⁸ –10 ⁹
Constructed arc plasma jets	10 ¹⁶ –10 ¹⁸	1–5 × 10 ⁴
Free-burning electric arcs	10 ¹⁶ –10 ¹⁷	7–10 × 10 ³
Combustion flames	10 ¹⁶ –10 ¹⁵	3–5 × 10 ³
Low pressure arcs	10 ¹⁰ –10 ¹²	1–3 × 10 ³
Cold gas plasma	10 ¹⁰ –10 ¹²	300–600

There are two types of cold plasma, as determined by electrode configuration. *Primary plasmas* are generated directly by rf energy between the electrodes of a reaction chamber. *Secondary plasmas* exist downstream of the energy field, carried by gas flow and diffusion. Secondary plasmas are less desirable for surface modification because the farther downstream from the rf field the parts to be treated are, the less reactive the plasma becomes. One part may shield another, creating nonuniformity, and less surface area can be treated before all active species are locally depleted, reducing effectiveness with larger loads.

39.3 A Typical Plasma Process Cycle

Modern plasma processing equipment is entirely automated. Typical continuous treatment equipment is pictured in [Figure 39.1](#).

To prepare for treatment, the process engineer enters set points into a microprocessor controller. The conditions of the process have been determined previously to be effective for the specific application. A key switch locks out the set points, so that the operator cannot inadvertently modify the process. A process may consist of single or multiple process steps, each comprising a complete plasma cycle.

Loading the chamber, the machine operator places parts on the electrode/shelves. After closing the door, the operator starts the process by pressing the start button. The controller monitors and controls the process until it is complete.

The first step the controller takes is evacuating the reaction chamber by opening the isolation valve to the vacuum pump. At a predetermined base pressure, process gases enter the chamber. A delay lets the reaction chamber's pressure stabilize, and then the power is switched on, creating a plasma. The controller begins the process timer. An impedance-matching network continuously and automatically minimizes power mismatch between generator and chamber as long as the rf power is on.

The step ends after the process time has expired, or after an optional temperature set point has been achieved, at which time the rf power and the process gases are shut off. The vacuum pump evacuates the process gas and by-products from the chamber, and the system repeats the entire cycle for the next step. If the last step has been completed, the chamber vents to atmosphere and the controller alerts the operator that the process is complete.

39.4 Plasma Chemistry

Three properties of the cold gas plasma — chemical dissociation, kinetic energy from ionic acceleration, and photochemistry — make this unique environment effective for surface treatment.

Exposing gases to sufficient electromagnetic power dissociates them, creating a chemically reactive gas that quickly modifies exposed surfaces. At the atomic level, plasma contains ions, electrons, and various

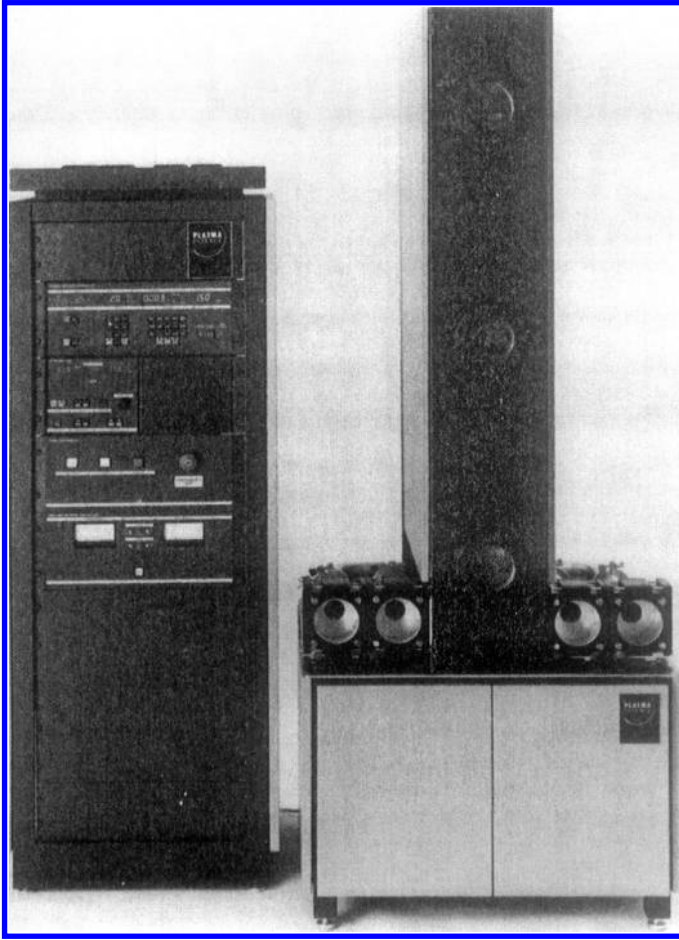

FIGURE 39.1 Typical continuous treatment equipment.

neutral species at many different energy levels. One of the excited species formed is the free radical, which can directly react with the surface of organic materials, leading to dramatic modifications to their chemical structure and properties. Modification sites also occur when ions and electrons bombarding the surface have gained enough kinetic energy from the altering electromagnetic field to knock atoms or groups of atoms from surfaces. Furthermore, gas-phase collisions transfer energy — forming more free radicals, atoms, and ions.

Combining dissociated species gives off photons as they are returning to their ground state. The spectrum of this glow discharge includes high energy UV photons, which will be absorbed on the top surface layers of the substrate, thus creating even more active sites. The color of the glow discharge depends on the plasma chemistry, and its intensity depends on the processing variables.

The plasma process modifies only several molecular layers, thus appearance and bulk properties are usually unaffected. In addition, plasma changes the molecular weight of the surface layer by scissioning (reduction in molecular length), branching, and cross-linking organic materials. The chemistry of the plasma determines its effects on a polymer.

39.5 Surface Treatment Approaches

Like many polymer processes, plasma is a chemical process. Three types of cold plasma treatments are used in processing polymers:

1. *Activating plasmas* use a gas or gases that react with the product to modify its chemistry. Such plasmas use oxygen, ammonia, air, halogens, and other gases for cleaning surface contaminants, microablating the surface, and substituting various chemical groups onto the polymer chain. Activating plasmas are discussed below.
2. *Grafting plasma* treatment first activates the surface by exposure to a chemically inert plasma, then bathes the surface in a vapor of an unsaturated monomer (without plasma generation). The free radicals previously formed on the polymer surface initiate grafting reactions with the reactive monomers.
3. *Plasma polymerization* utilizes plasma energy to initiate gas phase polymerization reactions, causing the deposition of organics onto surfaces within the plasma chamber.²

39.6 Plasma Activation of Plastics

Activating plasmas have three competing molecular reactions that alter the plastic simultaneously. The extent of each depends on the chemistry and the process variables. They are as follows:

1. *Ablation* (microetching), or removal by evaporating surface material either for cleaning or for creating surface topography
2. *Cross-linking*, or creating covalent bonds or links between parallel long molecular chains
3. *Substitution*, the act of replacing atoms in the molecule with atoms from the plasma

Ablation is an evaporation reaction in which the plasma breaks the carbon-to-carbon bonds of the hydrocarbon polymer. As long molecules become shorter, their volatile monomers or oligomers boil off (ablate), and they are swept away with the exhaust. Ablation is important for surface cleaning, and where desired, for surface etching. Cleaning removes from polymer surfaces such external organic contaminants as hydraulic oils and mold releases. Equally important is the removal of internal contaminants such as processing aids and internal lubricants that have bloomed to the surface. Often, an oxygen-containing plasma is selected to facilitate rapid breakdown of the suspected contaminant into a volatile by-product. Cleaning by plasma is more effective than cleaning by vapor degreasing or by other methods. Plasma produces a "superclean" surface; but if gross contamination exists, parts may be precleaned by ultrasonic cleaning, or solvent-vapor degreasing so that the plasma process time is kept to a minimum and thus remains cost effective.

Once cleaned, the plasma begins ablating the top molecular layer of the polymer. Amorphous, filled, and crystalline portions will be removed at different rates, giving a technique effective for increasing surface topography with a view to increasing mechanical adhesion or for removing weak boundary layers formed during molding.

Cross-linking, on the other hand, is done with an oxygen-free noble gas (argon or helium). After the plasma has generated surface free radicals, these react with radicals on adjoining molecules or molecular fragments to form cross-links. This process increases the strength, the temperature resistance, and the solvent resistance of the surface.

Unlike ablation or cross-linking, substitution replaces one atom or group from the surface with active species from the plasma. In this case, free radical sites on the surface are free to react with species in the plasma, including, but not exclusively, free radicals, thus altering surface chemistries by the addition of covalently bonded functional groups. The selection of the process gas determines which groups will be formed on the modified polymer. Gases or mixtures of gases used for plasma treatment of polymers include nitrogen, argon, oxygen, nitrous oxide, helium, tetrafluoromethane, water, and ammonia. Each gas produces a unique plasma chemistry. Surface energy can be quickly increased by plasma-induced oxidation, nitration, hydrolyzation, or amination.

Very aggressive plasmas can be created from relatively benign gases. For example, an oxygen and tetrafluoromethane (Freon 14) plasma contains free radicals of fluorine. Oxidation by fluorine free radicals is known to be as effective as oxidation by the strongest mineral acid etchant solutions, with one important difference: hazardous and corrosive materials are not used. As soon as the plasma is shut off,

the excited species recombine to their original stable and nonreactive form. In most cases, treatment of the exhaust effluent is not required.

Gases that contain oxygen are generally more effective at increasing the surface energy. For example, plasma oxidation of polypropylene increases the initial surface energy of 29 dynes/cm to well over 73 dynes/cm in just a few seconds. At 73 dynes/cm, the polypropylene surface is completely water wettable. Increased surface energy results in a plasma that yields polar groups, such as carboxyl, hydroxyl, hydroperoxyl, and amino. A higher energy (hydrophilic) surface translates to better wetting and greater chemical reactivity of the modified surface to adhesives, paints, inks, and deposited metallic films, providing for improved adhesion and permanency.

The enhanced surface reactivity is characterized in the laboratory by studying water wettability. Wettability describes the ability to spread over and penetrate a surface; it is measured by the contact angle between the liquid and the surface. The relationship between contact angle and surface energy is inverse — the contact angle decreases with increasing surface energy. Wettability can easily be induced on normally nonwetable materials such as polyolefins, engineering thermoplastics, fluoropolymers, thermosets, rubbers, and fluoroelastomers.

Noble gases (argon, helium, etc.) generate surface free radicals that react either with other radicals on the surface, yielding molecular weight changes, or with the air, when the part is removed from the chamber, thus increasing the surface energy.

Process gases such as fluorocarbons will generally provide a lower energy, or hydrophobic, surface by substitution of abstracted hydrogen with either fluorine or trifluoromethyl radicals to form a fluorocarbon surface. Fluorination is favored in some medical applications, where it is undesirable to have catheters be wetted by blood. The nonwetable barrier layer also inhibits chemical penetration, a consideration that is important for specialty packaging.

39.7 Adhesion

Bonding in manufacturing processes is a specialized field, but generally, cleanliness and wettability are necessary for good adhesion.

High surface energy alone does not guarantee better adhesion; however, the versatility of the process enables tailoring of the surface chemistry for optimal adhesion or superior product performance. It is not uncommon to move the focus of failure from the bond line into the adherent or into the adhesive with a many-fold increase in the adhesion. Examples of typical plasma improvement on a range of materials for epoxy bonding^{3,4} and for coating⁵ are shown in Table 29.2 and Table 39.3.

TABLE 39.2 Typical Bond Improvement^a after Surface Treatment: Solvent-Washed Plasma

Material	Shear Strength (psi)	Failure Mode ^b
Valox (polyester)	522	Adh
	1644	Coh
Noryl (polyphenylene oxide)	617	Adh
	1799	Coh
Durel (polyarylate)	250	Adh
	2161	Coh
Vectra (LCP)	939	Adh
	1598	Coh
Lexan (polycarbonate)	1705	Adh
	2242	Coh
Delrin (polyacetal)	165	Adh
	857	Adh

^a Lap shear strength 3M Weldbond #2256.

^b Adh = adhesive failure, Coh = cohesive failure of adherent.

TABLE 39.3 Paint Adhesion on Polyethylene: Urethane Heat-Cured Automotive Paint

Test Condition	Failure	Liftoff (%)
Control (no plasma)	0B ^a	100
Plasma treated	5B	0

^aASTM Test Method D3359-83. "Measuring Adhesion by tape test."

Extremely mobile polymers, like elastomers, have shelf lives measured in minutes or hours. The flexible molecular chains rotate the high energy functional groups into the bulk. Once an active surface has been treated and properly coated with adhesive, the modification is permanently tied to the surface. Thus, priming of a treated elastomer fixes the surface chemistry.

39.8 Summary

Plasma surface treatment is an effective, efficient method of modifying a wide variety of polymeric and elastomeric surfaces. Adhesion strength of treated materials often exceeds that of the adherent. The plasma process is not operator-sensitive; its other significant characteristics include reproducibility, cleanliness, and the ability to more consistently provide high reliability bonds.

References

1. B. Chapmen, *Glow Discharge Processes*. New York: Wiley, 1980.
2. J. R. Hollahan and A. T. Bell, *Techniques and Applications of Plasma Chemistry*. New York: Wiley, 1974.
3. S. L. Kaplan and P. W. Rose, "Plasma surface treatment of plastics," presented at the SPE 46th Annual Technical Conference, Atlanta, April 1988.
4. S. L. Kaplan and P. W. Rose, in *Plastics Finishing & Decorating*. D. Satas, Ed. New York: Van Nostrand Reinhold, 1986.
5. S. L. Kaplan and S. Rines, "Plasma pretreatment for plastics," *Prod. Finish.*, January 1988.

40

Surface Pretreatment of Polymer Webs by Fluorine

40.1	Introduction	40-1
40.2	The Fluorination Process.....	40-1
	Fluorine • Plant for Continuous Surface Fluorination • Safety Precautions	
40.3	Pretreatment with Fluorine: Application Examples	40-4
	Polyethylene–Vinyl Acetate Copolymer Foam • Plastic Sheeting • Air Cushion Sheetting • Terpolymer Rubber	
40.4	Advantages of Surface Pretreatment with Fluorine.....	40-6
40.5	Summary.....	40-6
	References	40-6

R. Milker

Lohmann GmbH

Artur Koch

Ahlbrandt System GmbH

40.1 Introduction

Bonding, coating, laminating, painting, and printing require good substrate adherence. This requires, above all, surface polarity, which permits mechanical and, in particular, chemical bonds. For this reason, polymeric materials are treated by means of oxidation processes entailing three main groups: corona discharge, flame treatment, and chemical.

All processes are more or less disadvantageous. The chemical methods have been proved only in narrow, limited fields of application (e.g., as liquid pickling agents), or they require high supervision and a substantial maintenance effort (e.g., ozone treatment). State-of-the-art fluorination is troublesome, because it is a discontinuous process and is not feasible in many cases, especially for web-shaped substances. Corona pretreatment requires high investment and is strongly liable to interference. In the area of the dielectric material, fires occur frequently, causing short circuits in the pretreatment station. Additionally, only one side of the web material can be activated by the corona discharge.

This chapter describes an attractive new pretreatment method implemented by Lohmann GmbH, featuring the continuous fluorination of web materials.¹

40.2 The Fluorination Process

The surface of web-shaped, polymeric substrates is subjected continuously, for a short time, in a suitable reaction chamber, to elemental fluorine — attenuated with an inert gas. Thus, the surface energy of the polymeric material is increased to such an extent that excellent adherence to other polymers (e.g., lacquers and adhesive agents) is attained.²

The fact that this fluorination technique is feasible at all, on an industrial scale, is due to the astonishing chemical–technological developments realized during the past 20 years, which have made fluorine not only an important initial substance but even a component in large-scale technical operations.

40.2.1 Fluorine

Fluorine, an almost colorless gas, is one of the strongest oxidizing agents; it is surpassed only by a few other oxidants (e.g., chlorine fluoride, chlorine trifluoride). It reacts with almost all organic and inorganic substances; the few exceptions include, first of all, nitrogen and the inert gases helium, neon, and argon, plus some metal fluorides in the highest valence state, as well as other fully fluorinated compounds (e.g., CF_4 or SF_6). Fluorine's great reactivity can be explained by the interaction of the low dissociation energy of the molecule itself and the very strong bond fluorine forms with other atoms. Moreover, since the fluorine atom is rather small, the spatial relations in fluorine compounds admit high coordination numbers of the relevant central atom.

For a long time, the extreme aggressiveness of fluorine has limited its use in industrial applications.

Indeed, as late as 1936, a technical encyclopedia stated: "Due to the difficult manufacture and storage, fluorine has no practical importance for industry." It was only a little more than two decades ago that all difficulties impairing the manufacture of fluorine on a large scale could be considered to have been overcome.

Nowadays, elementary fluorine in the liquefied state is transported even in fuel trucks. It is mainly used for the manufacture of the highly volatile uranium hexafluoride, which is known to serve for the separation of the uranium isotopes U^{235} and U^{238} . Thus, fluorine has become a key product for the nuclear industry. In Germany, Kali Chemie AG, which has had a leading part in fluorochemistry in general, is the only manufacturer of this extremely reactive substance.³

40.2.2 Plant for Continuous Surface Fluorination

Figure 40.1 diagrams the construction of a plant for the pretreatment of web-shaped materials with fluorine.⁴ Figure 40.2 illustrates an actual setup. Fluorine supplied in steel pressure bottles is attenuated to a certain concentration with inert gas (nitrogen, rare gases, and compressed air) in a corresponding dose discharge device. This fluorine–inert gas compound is available for the system via the line 9 in Figure 40.1. The attenuation step can be dispensed with by connecting instead to a steel pressure bottle filled with a fluorine–nitrogen compound.

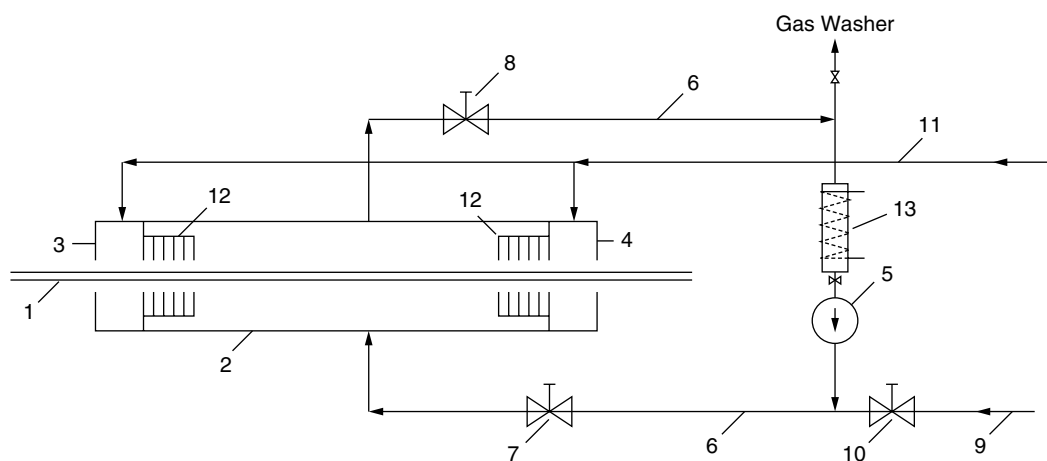

FIGURE 40.1 Schematic diagram of a continuous surface fluorination pretreatment plant. Numbered components are identified in the text.

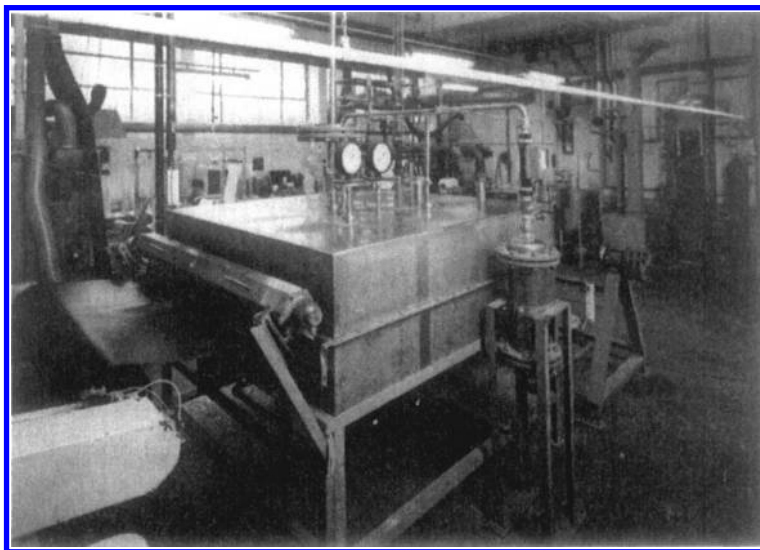

FIGURE 40.2 The surface fluorination pilot plant of Lohmann GmbH, Neuweid, Germany.

The fluorine delivery amounts for a 10 vol% standard compound — due to the higher filling pressure — to 50% of that obtained with the pressure bottle containing elementary fluorine. After the reaction chamber (2: [Figure 40.1](#)) has been filled with attenuated fluorine, the fluorine–inert gas compound is circulated through reaction chamber 2 by the pump (5) via pipe 6 and the two stop valves (7 and 8). The web-shaped material to be pretreated is fed into chamber 2 via the intake airlock (3) and leaves it via the outlet airlock (4).

The parameters time of contact and concentration of fluorine influence the surface energy of the polymer. The surface effect attainable depends additionally on the chemical quality of the polymer. Because of the extreme reactivity of the elemental fluorine, all polymeric materials disposing of substitutable hydrogens can, in principle, be activated. Airlocks 3 and 4 are supplied with inert gas via pipe 11. The airlocks, as well as the series-connected flow resistors (12) prevent, to a great extent, the escape of fluorine and hydrogen fluoride (HF) into the ambient air. Such a system of airlocks is described in detail in Reference 5. From pipe 9 and via dosing valve 10, the escaped portion of fluorine is replaced, but a small quantity of it is lost as HF by virtue of the chemical conversion with the reactant. Since a partial fluorination causes surface activation, which is sufficient for many purposes, the quantity of fluorine actually consumed or the resulting quantity of HF is rather small.

The low portions of HF in the system are removed by means of a hydrogen fluoride absorber (13 in [Figure 40.1](#)). Such a cleaning is also necessary if the fluorine is to be dosed by a glass rotameter. The absorber comprises a pipe made of Monel, nickel, or steel (diameter, 50 mm; length, 450 mm), and filled with granular, porous sodium fluoride. Welded to both sides of the pipe are caps that carry supply and drain pipes. The absorber can be heated up to 300°C by means of an electric tube furnace. The HF absorption ensues at room temperature. For regeneration, the absorber is heated in the nitrogen flow to +300°C. A suitable porous sodium fluoride can be produced by heating grained or pelleted sodium bifluoride to 250 to 300°C in a nitrogen flow.

If required, the entire system can be rinsed via a gas washer: the F_2 and HF portions in the rinsing gas are absorbed in counterflowing diluted potash lye and are made innocuous. The exhaust air is completely free from pollutants.

40.2.3 Safety Precautions

The hazard associated with the gases fluorine and hydrogen fluoride being delivered through the airlock to the open air is comparable to the one caused by ozone released, which occurs inevitably as a result of

TABLE 40.1 Adhesive Bonding versus Pretreatment

Foamed Plastic	Surface Tension (mN/m)	Pebra Test ⁶	Force Test ⁷ (N/625 mm ²)
Not pretreated	<30	3 sec	99
Corona pretreated	50	>2 min	129–149
Fluorine pretreated	54	>2 min	153

the corona pretreatment. The safety measures known and approved for ozone apply also to fluorine and hydrogen fluoride. For these gases, a threshold limit value of 0.1 ppm in air was fixed, as for ozone. Biological assays have shown that the toxicity of fluorine and hydrogen fluoride is many times less than that of ozone.

Since fluorine is perceptible by its smell rather like heavily chlorinated water, even in rather low concentrations, cases of poisoning are extremely rare.

On-the-job safety is safeguarded by installing a chemical detector giving an acoustic alarm and interrupting the fluorine supply if the threshold contents of fluorine admitted to the air is exceeded.

40.3 Pretreatment with Fluorine: Application Examples

Extensive serial tests on a pilot plant as described in Section 40.2.2 illustrate the following:

A concentration of 5 to 10 vol% fluorine in the plenum chamber is fully sufficient to raise the surface energy of the polymer above 50 mN/m.

Average fluorine consumption is only 2.5 kg for the pretreatment of approximately 100,000 m² of polymer surface. (The fluorine costs are thus practically negligible.)

All tests described below were performed with a working width of 1 m; the reaction chamber to which the fluorine–nitrogen was admitted had a length of 1 m and a height of 30 cm, for a volume of 300 l.

40.3.1 Polyethylene–Vinyl Acetate Copolymer Foam

A closed-cell foam, 1 mm thick, is to be pretreated on both sides at a web speed of 5 m/min.

After having passed the fluorine atmosphere, the surface tension of the foam material increases from 30 mN/m to 54 mN/m. If the foam material is used as, for example, supporting material for double-sided, pressure-sensitive adhesive tapes, the adhesive bond is as good as with the corona-pretreated material. This is shown in Table 40.1.

Electron spectroscopy for chemical analysis (ESCA) research⁸ indicates that activation of the foam selected in this example is predominantly based on the partial fluorination of the terminal methyl group of the comonomeric vinyl acetate. As with the corona pretreatment, the surface tension degrades gradually, but it stabilizes on a higher level, as indicated in Figure 40.3. Pure polyethylene foam, however, maintains for weeks the conferred surface tension of more than 50 mN/m.

40.3.2 Plastic Sheeting

With the maximum web speed of 24 m/min (F₂ concentration 5 vol%) attained in the pilot plant, common film or sheeting qualities of differing widths were successfully pretreated on one or two sides, as shown in Table 40.2. The pretreatment effect remained constantly high throughout an observation period of 6 weeks.

40.3.3 Air Cushion Sheeting

For certain applications, an adhesive agent coating that is applied on the burl side has to be firmly bonded to the surface of the sheeting or film, even in the interstices. Here, the fluorination technique is, in fact,

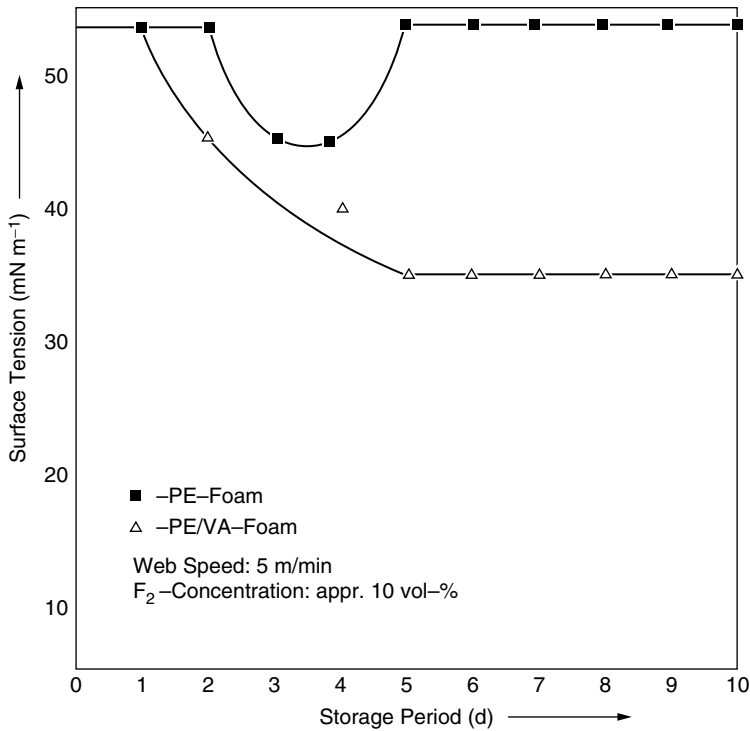

FIGURE 40.3 Storage stability of the surface energy of polyethylene (PE) and PE–vinyl acetate (VA) copolymer foams subjected to fluorine pretreatment.

TABLE 40.2 Surface Tension Values Obtained with Corona and Fluorine Pretreatments

Type of Sheeting	Surface Tension Values (mN/m)		
	Initial	Corona	F ₂
Low density polyethylene	30	35	>54
High density polyethylene	32	<32	>54
Biaxially oriented polypropylene	32	35	>54
Polyethylene sulfide	35	>54	>54
Polyvinyl chloride	40	>54	>54
Polyurethane resin	32	<32	>45
Polyethylether ketone	35	>54	>54

predestined to be a solution for problems. As expected, such a polyethylene air cushion sheeting or film can be pretreated as well as other polyethylene sheetings.

40.3.4 Terpolymer Rubber

Ethylene propylene rubber monomer (EPDM) belongs to the materials that will be used to an ever-increasing extent in the future — in particular, in the automobile industry.

The negative side of this versatile, almost indestructible polymer body is its obstinate pretreatment behavior. So, after the conveyance of EPDM sectional cuts on an endless belt through the fluorination chamber, only 45 mN/m is measured. This surface energy, however, guarantees satisfactory substrate adherence.

40.4 Advantages of Surface Pretreatment with Fluorine

Compared with other pretreatment processes, the fluorination method not only features a wide spectrum of applications but unlike corona pretreatment and ozonization, it does not require electrical apparatus, which is susceptible to interference and requires intensive maintenance. Additionally, the basic investment for fluorine fittings (discharge station) and for a reaction chamber is lower than the prime cost of a corona pretreatment station.

A particular advantage of continuous fluorination can be seen in the application to web-shaped bodies, which — when wound in a compact roll — are not accessible for fluorination by present state-of-the-art means. Such materials can be continuously surface activated now from roll to roll, independent of roll length.

Another very important argument for the fluorination technique is the fact that the surface treatment effect, unlike corona pretreatment, is long-lasting — at best, irreversible — on both sides. This is of enormous importance for practical applications in industry, as subsequent surface refining processes need not follow immediately the surface activation.

Furthermore, the fluorination process provides effective pretreatment of the following materials:

- Burled, embossed, or otherwise irregularly formed surfaces of sheetings or films
- Narrow fabrics
- Foams wider than 2 mm
- Biaxially stretched polypropylene sheeting of any width

40.5 Summary

Now that the fluorination technique has become controllable, it offers promising and beneficial prospects for the pretreatment of polymeric, web-shaped materials. It cannot and will not displace corona pretreatment, which has proved its usefulness for decades, but is surely an attractive solution for a number of special applications.

References

1. R. Milker, *Coating*, 11, 294–298 (1985).
2. EP 0 214 635.
3. KC-Fluor, Kali-Chemie AG Literature.
4. G 87 03 823.4.
5. DOS 30-38-741.
6. Test instruction AW 14, Pebra.
7. Test instruction 0400, Lohmann GmbH, Neuwied, West Germany.
8. Dr. Ruppert, Chemical Institute of the University of Bonn, personal communication.

41

Calendering of Magnetic Media

John A. McClenathan
IMD Corporation

41.1 Introduction	41-1
41.2 Calendering Magnetic Media Products	41-1
41.3 Calender Design	41-2
References	41-3

41.1 Introduction

Calendering is a continuous web process: two or more cylindrical rolls are nipped together under mechanical load and driven via a system motor. This chapter discusses the calendering of coatings in the manufacture of magnetic media products.

41.2 Calendering Magnetic Media Products

In the magnetic tape industry, the calendering process relates to improving performance of the manufactured product. Improvements to the surface of the applied coatings on the substrate, usually polyester film, can be varied depending on the end use of the magnetic media product; they include the following:

- Improved surface finish
- Densified coating
- Improved aesthetics
- Reduced product thickness
- Improved product electrical output
- Reduced recorder head wear
- Promotion of coating durability

Some of the product improvements listed are interrelated and can be optimized. As an example, improvement of the surface finish will be achieved by the calendering process, and the coating will be densified. Iron oxide in the coating binder system must be maintained at the coating surface and not caused to migrate toward the base film. The surface can become very smooth if a percentage of binder system is caused to migrate to the coating surface, displacing the iron oxide particles away from the eventual recording head. The condition of “too smooth” can also be achieved, and the lack of surface boundary lubrication air will allow contact between the tape and recording head, resulting in excessive drag on the tape.

The surface conditions required on the magnetic media products are critical. The hydrodynamic lift clearances are 5 to 10 microinches ($\mu\text{in.}$) (0.12 to 2.5 μm), as compared to a coated surface roughness (after calendering) of 0.6 to 1 $\mu\text{in.}$ (0.014 to 0.025 μm) for the magnetic media products. To achieve this smooth finish, the coating to be calendered is placed in contact with the polished surface of a steel hot

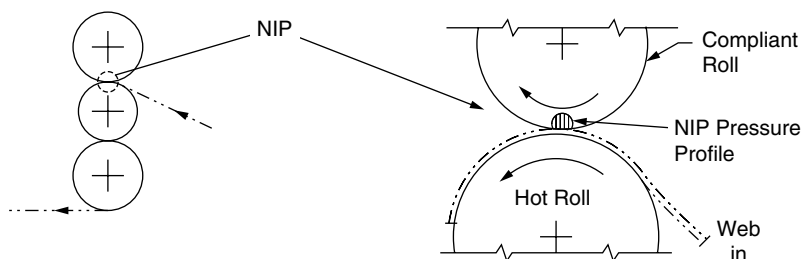

FIGURE 41.1 Nip definition.

roll. The basic nip area, as shown in Figure 41.1, is the physical contact area between two rolls. One roll is the compliant roll and has a lower modulus of elasticity than the second roll, which is usually steel. Calendering results from the process, which consists of a controlled nip pressure and controlled heat applied to the product. Optimization of these two basic parameters will, in most cases, cause product quality improvements.

The most noted factors to be controlled during calendering are as follows:

1. *Variable and controlled nip pressure.* The calenders are usually hydraulically loaded to achieve loadings from 500 to 4000 PLI pounds per inch of roll face (89 to 714 kg/cm).
2. *Steel (or hot) roll surface finish.* Roll surfaces are hardened and chrome plated to provide optically perfect surfaces of better than 0.5 $\mu\text{in.}$ (0.012 μm).
3. *Temperature of the product.* The temperature of the hot steel roll and the compliant roll surfaces must be controlled. The steel roll is heated internally by water, oil, or electricity and controlled to $\pm 1^\circ\text{C}$.
4. *Cleanliness.* Compliant rolls must not be a source of particle contaminants. Any foreign particles or dirt will mark the product when passed through the high pressure nip area.
5. *Rolls must be of good physical design.* Deflection must be minimum. Roll runout of 0.001 in. (0.025 mm) TIR or better must be maintained. The face surfaces on all rolls must be straight. Tolerances depend on the compliant roll material's ability to conform to the steel roll surface.
6. *Compliant roll.* A variety of compliant roll materials with different surface finishes and hardnesses are available and include the following: paper-filled cottons, polyester, nylon, polyimide, rubber, steel, and epoxy glass. The hardness range of most of the compliant rolls (excluding steel) that are used is 80 to 90 Duro Durometer "D."
7. *Temperature.* Control of the web temperature during passage through the calender must be held at an acceptable level to provide plasticity to the coating binder system without distorting the base film. Roll diameters, number of nips, web speed, web thickness, and the web wrap angles on the rolls provide controllable variables for calendering success.

41.3 Calender Design

Calender configurations vary from a simple two-roll configuration to a multiroll stack of 11 rolls. Unsupported compliant rolls require larger diameters to provide high nip loading capability. This results in the most common arrangement, featuring the two external rolls made of steel (not compliant) to provide the required nip stiffness. This concept creates stacks of three, five, seven, nine, or 11 rolls. The arrangement can be horizontal or vertical (Figure 41.2). The loading methods can vary but most often are from the bottom on a vertical stack to allow easy opening for emergencies.

Intermediate and end steel rolls can be cooled as well as heated, if required, to control the process web temperature. The sizes of the intermediate rolls also are often reduced in a multiroll stack machine to reduce the required overhead installation space and reduce the nip area, thereby providing a high unit area loading.

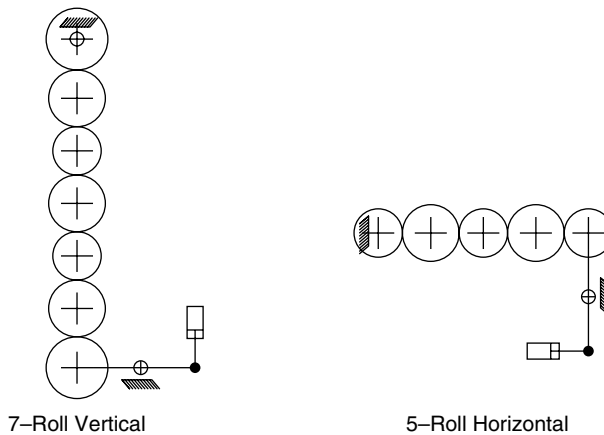

FIGURE 41.2 Typical calender arrangements.

The loading system is usually hydraulic but can also be pneumatic or mechanical. Direct loading requires larger loading cylinders than a moment arm mechanical advantage system.

The calender stack power requirements vary with the speed, web width, pressure, and type of compliant rolls used. The usual power source consists of a motor and reducer driving through a coupling directly to the bottom steel roll in a vertical stack, or the fixed-end steel roll in a horizontal stack. All rolls can be driven with separate drive motors if space allows. If only one prime mover is provided on the stack, a means of rotating all rolls is required to allow transporting the product with the nips open and also allow closing of the nips without product damage.

Calenders are provided with emergency stop cables, nip guards, and drive stop interlocks to open all nips.

References

1. J. J. Brondijk, P. E. Lvierenga, E. E. Feekes, and W. J. J. M. Sprangers, "Roughness and deformation aspects in calendaring of particulate magnetic tape," *IEEE Trans. Magn. MAG*, 23(1), January (1987).
2. Alex N. Tabenkin, "The growing importance of surface finish specs," *Machine Design*, September 20 (1984).
3. J. A. McClenathan, *The Design of a Magnetic Tape Calender*. Birmingham, AL: IMD, February 17, 1970.
4. Harold Bredin, "Tribology and the design of magnetic storage system," *Mech. Eng.*, March (1985).
5. A. J. Holloway, "Polyester film surface definition and control," presented at the Symposium of Magnetic Media Manufacturing Methods, Hawaii, May 1983.

42

Embossing

John A. Pasquale III
Liberty Machine Company

42.1	General.....	42-1
42.2	Thermoplastic Webs.....	42-1
	Embossing Machines for Thermoplastic Webs	
42.3	Nonthermoplastic Embossing.....	42-5

42.1 General

Embossing is a method by which a web is textured by the use of a pattern roll pressing against a backup roll under controlled conditions. One can emboss both thermoplastic and nonthermoplastic webs by choosing the proper roll arrangement to deform the web.

To emboss thermoplastic materials, the web is deformed by preheating and pressing it with a cooled embossing (pattern) roll to set the pattern and cool the web to retain that pattern.

The degree of preheating to soften the web must be carefully controlled so that no melting or degrading of the web will take place. To make the heat removal process as efficient as possible, no more heat should be applied than is needed to satisfactorily emboss the product.

To emboss a nonthermoplastic web, such as paper, textile, or foil, one must apply pressure that exceeds the elastic limit of the substrate and imparts the pattern. This type of embossing involves the use of male and female rolls, either two rolls with matched patterns made of steel or other metal, or a steel pattern roll that comes in contact with a filled backup roll, which takes a permanent deformation for a given pattern by running the steel embossing roll in contact with the backup roll during a “running in” period. In some cases, special rubber-covered rolls can be used; their behavior eliminates the need for “running in.”

42.2 Thermoplastic Webs

Embossing thermoplastic webs is achieved by using an engraved metal roll pressing against a rubber-covered backup roll. The metal roll is cooled with a refrigerated solution to remove heat from the product and to set in the embossed pattern. The backup roll is internally cooled, mainly to increase the life of the rubber covering. The roll may also be cooled externally by a water bath and squeeze roll system, especially if the web is an unsupported thermoplastic film having a tendency to adhere to a hot rubber surface.

Embossing of a web depends on many variables, such as the following:

- Degree of preheating and rheological properties of the product
- Sheet thickness
- Hardness of the rubber backup roll
- Embossing roll pattern and its cooling capacity
- Postemboss cooling

A fine balance exists between the preheating and the removal of heat to set the pattern. Applying the appropriate amount of preheat but insufficient cooling results in the inability to deform the web, which

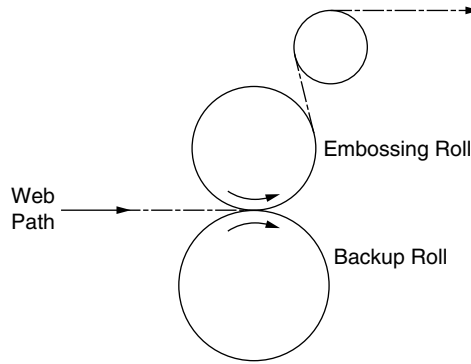

FIGURE 42.1 Vertical embossing unit.

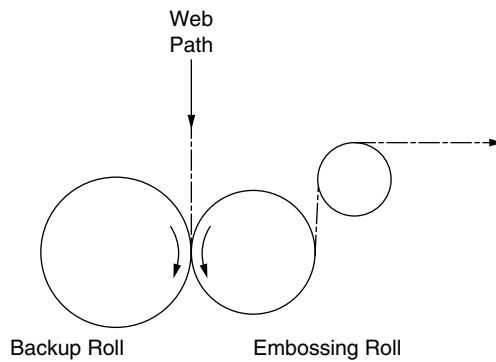

FIGURE 42.2 Horizontal embossing unit.

has not been softened enough. The best embossing system is one that optimizes heat input and removal for a given thickness and speed.

The hardness of the backup roll plays a role in the finished product's texture. If a roll is too hard, a good definition of fine surface patterns might be achieved, however, displacement of material within the product for deep embossings may not be possible. If the roll is too soft, it will allow deep embossings to show through the back of the product, an effect that is objectionable in some applications.

The need to cool the product after it has left the embossing roll is another important factor. Appropriate postcooling facilities, usually cooling rolls, are used to bring the sheet temperature as close to ambient conditions as possible before the product is rewound into a roll. When cooling a thin sheet, the problem of retained heat is minor, because a thin sheet releases heat easily. In heavy sheet embossing, although the surface of the web might feel cool, the heat is retained in the body of the sheet. This heat, if it remains, will cause a loss of embossed grain when the product is later rewound for further processing.

Embossing units can be placed in various geometric positions. They are usually either vertical, where the web path enters in a horizontal manner, as shown in Figure 42.1, or they can be placed in a horizontal fashion, as shown in Figure 42.2. Under special conditions and for certain applications, it might also be advantageous to find them disposed at a particular angle, as shown in Figure 42.3.

The preheated web should enter the embossing nip perpendicular to the line of action of the embossing and backup rolls, to ensure that the web is not prematurely cooled by striking either the embossing roll or the backup roll first. It is acceptable and sometimes desirable, however, that the backup roll be contacted first. Many webs are unstable in their preheated condition and will be easily creased if they enter the nip unsupported. A short arc of contact before the embossing action of the nip allows the web to be flattened. It is also preferable to contact the backup roll first, because the surface temperature of the backup roll is higher than that of the cool embossing roll; thus, the amount of heat removed from

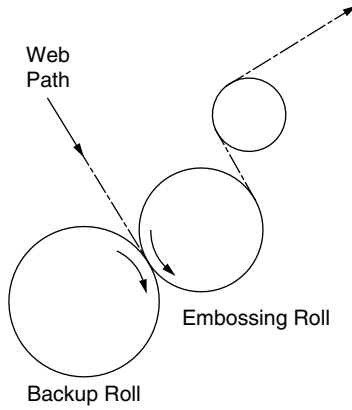

FIGURE 42.3 Embossing unit at an angle.

the preheated web is minimized. Furthermore, the heat is removed from the back side rather than the face that is to be embossed.

42.2.1 Embossing Machines for Thermoplastic Webs

Figure 42.4 shows an embossing machine that incorporates a preheating drum with the addition of a surface radiant heater, an embossing section consisting of a metal embossing roll and a rubber-covered backup roll, and appropriate cooling rolls.

Polyvinyl chloride (PVC) film having a moderate thickness of 0.2 to 0.3 mm (0.008 to 0.012 in.) is unwound from a tension-controlled unwind to assure that it is not stretched during the process. It enters the preheating area by passing over a spreader roll and is applied to the heat drum by use of a lay-on roll. The lay-on roll is a rubber-covered, pneumatically operated roll, whose function is to lay the web onto the heated drum surface, allowing for intimate contact and preheating.

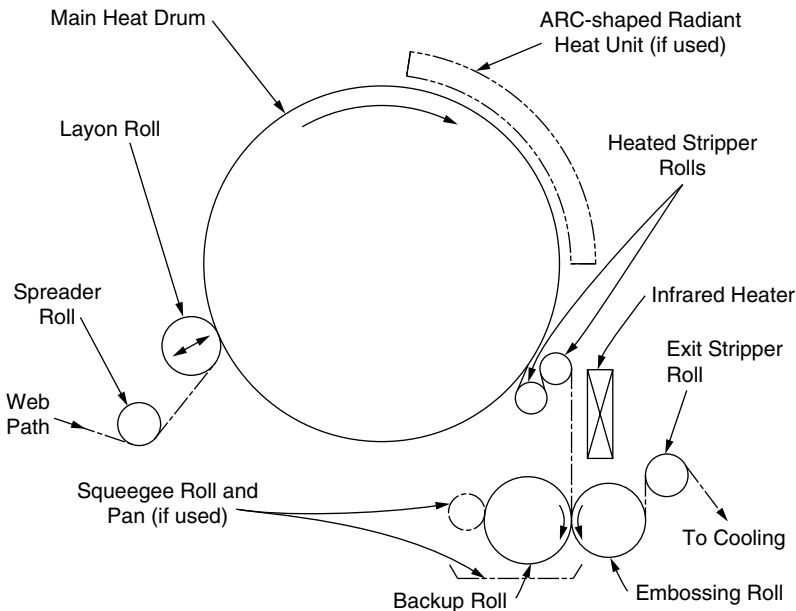

FIGURE 42.4 Embossing machine.

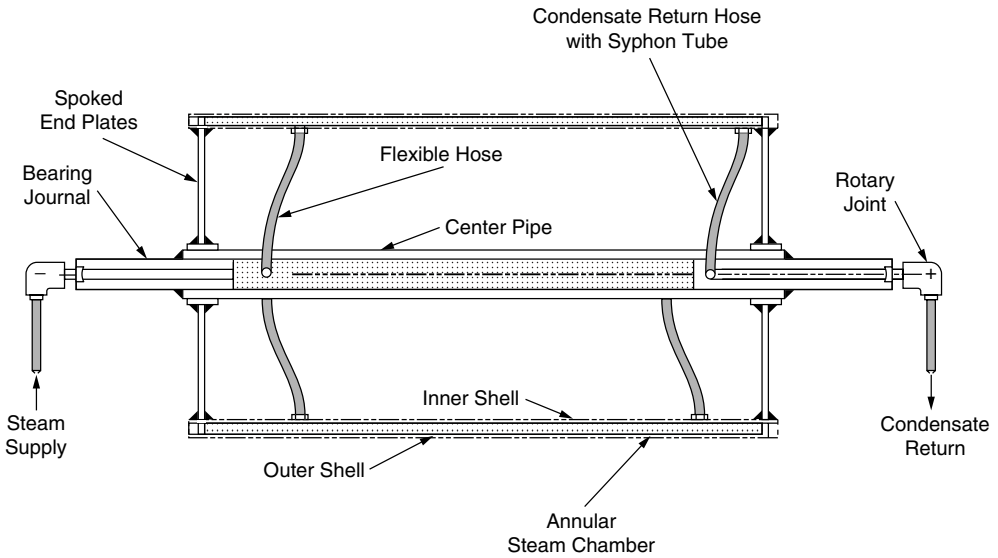

FIGURE 42.5 Steam-heated drum.

The drum is heated by steam or hot oil and is usually 1 to 1.5 m (36 to 60 in.) in diameter. Steam heat is preferred, as it responds to temperature changes more readily than does hot oil. For this thickness of web, the arc-shaped radiant heat unit around the periphery of the drum is not required.

The steam-heated drum has a double-shell construction as shown in Figure 42.5. Saturated steam enters from one end and passes through the center shaft of the drum; then it is fed through passages to the annular section formed by the inner and outer shells of the drum. As the steam fills the annular chamber and performs its work, condensation takes place and is removed through similar passages at the opposite end of the drum by a siphon tube and exits through the shaft opposite the steam inlet. Both the steam and the condensate enter and leave the drum through rotary joints furnished with bronze hoses to withstand the temperature of the steam. The rotary joints are pipe connections, which allow the drum to rotate freely while they remain stationary to provide a solid connection to the steam pipe and condensate return system.

The embossing section consists of a 250 to 300 mm (10 to 12 in.) diameter, double-shelled embossing roll, which is designed to allow a cooling solution to pass through it in an efficient manner to remove heat as rapidly as possible, thereby setting in the embossing.

Embossing rolls typically have a double-shell design with a spiral wrap for the most efficient passage of the cooling medium.

For drums heated by hot oil, the construction is similar, but spiral windings forming passageways or channels are provided in the annular space between the inner and outer shells to allow the oil to flow in a prescribed path and in the most efficient manner, to promote good heat transfer. The hot oil is pumped through the center shaft of the drum and enters through conduits similar to the steam-heated drum design; after it has done its work, it leaves by similar passages at the opposite end of the drum. It is appropriate to pump the hot oil at rates that will cause it to flow in a turbulent manner through the drum annulus passageways, to provide the best heat transfer coefficient for optimal results.

The preheated web is stripped away from the main heating drum by use of the heated stripper rolls. These rolls help to maintain the temperature of the web and allow it to be passed into the embossing section. The stripper rolls are of single-shell construction and vary in size from 100 to 150 mm (4 to 6 in.) for steam-heated systems.

The infrared heater shown on the drop into the embossing section is used to maintain the ambient temperature around the web and to assure that the surface to be embossed will be entering the nip at approximately 160°C (320°F).

The embossing roll design is also important because pressure is exerted between the embossing roll and the rubber-covered backup roll. The double-shell construction, along with the spiral winding, produces a roll that is structurally strong while still having excellent heat transfer capability.

The cooling solution is supplied to the roll through the use of rotary joints with rubber hoses; the solution goes in one end, flows through the spiraled annular construction of the roll, and is discharged at the other end.

Roll design becomes very important from the standpoint of heat transfer efficiency, and care must be taken to properly size the entrance and exit ports (to permit the required flow rate) and the annulus (to assure that the cooling solution is passing through it in the turbulent region of flow), thereby promoting the highest heat transfer coefficient and maximizing the cooling effect.

The backup roll is rubber covered and is cored for internal cooling, but primarily to keep the interface of the steel and rubber covering cool to avoid premature bond failure. The covering used on the roll should be abrasion resistant and able to withstand heat.

The two rolls are brought together hydraulically or pneumatically, with the embossing roll usually being the nondriven roll, while the backup roll is motor driven. To prevent stretching the product as it passes from one section to the other, it is important that synchronization between the main heating drum and the embossing section be accurately maintained.

It is important that the embossing roll be wrapped by the thermoplastic web. This enables cooling to take place while the web is still in intimate contact with the textured embossing roll.

Postcooling is more important on heavier gage materials, where residual heat in the web will later result in temperature rise in the rewound roll, causing a loss of embossing. In a sheet of this thickness, most of the cooling is achieved by the embossing roll and exit cooling roll. For the heavier sheets, it is recommended that dual-shell cooling rolls averaging 460 to 610 mm (18 to 24 in.) diameter and cooled through rotary joints be used to complete the cooling system.

42.3 Nonthermoplastic Embossing

Nonthermoplastic materials are embossed in a manner similar to the thermoplastic materials except that the force between the embossing roll and the backup roll is greater, so that the elastic limit of the material being deformed can be exceeded.

The predominant factor in embossing nonthermoplastic materials is the use of male and female rolls. This roll combination includes either metal male and female rolls, a metal embossing roll operating against a filled roll, or a metal embossing roll acting against a special compound, rubber-covered roll.

The use of metal male and female embossing rolls gives the most concise and definitive texture possible. The engraved patterns on both rolls are carefully matched to allow for insertion of the respective male parts into their counterparts.

The most commonly used combination of rolls is the metal embossing roll and the filled backup roll. This backup roll has either a saturated paper or a textile fabric composition, both of which are densely packed to form a very solid homogeneous structure. The roll is then finished to a specific diameter and when placed in the embossing machine is usually “run in” by bringing the metal embossing roll into contact with the filled roll under load. By continually running the two rolls in contact with each other, the embossing roll pattern is imparted to the surface of the backup roll, giving a male–female characteristic without the use of two mating metal rolls. This combination is excellent for thin as well as heavier materials, as embossing roll–backup roll contact is inconsequential with one metal roll and a composition backup roll.

The use of a rubber-covered backup roll for nonthermoplastic materials depends strictly on the embossing load. There are certain rubber compositions, such as cast urethanes, which will act similar to a composition roll. They do not require “running in” but will deform under the load of the embossing roll.

The backup rolls for nonthermoplastic materials have a much larger diameter than those used for the thermoplastic webs. This is due to embossing loads and wear. The larger surface gives less revolution of the roll and, hence, less wear of the surface as compared to a similar roll. The larger diameter gives a better structural member to resist deflection.

43

In-Mold Finishing

Robert W. Carpenter
Windsor Plastics, Inc.

43.1 Introduction	43-1
43.2 Process.....	43-2
Laminates • Foiling • New Materials	
43.3 Conclusion.....	43-4

43.1 Introduction

In the past few years, a lot of attention has been focused on the utilization of in-mold finishing of thermoplastic parts. In-mold foiling, available since the early 1970s, has recently developed into an important market because of refinements in tool design and improvements in foils, and through the expansion of in-mold capabilities. Insert molding has also been available for a number of years and has continued to develop as manufacturers' search for technologies that will provide them with superior part quality.

In-mold foiling offers the customer a product that benefits from the economics of having the part finished simultaneously with the injection molding process. The part is also more durable than a component finished with one of the conventional techniques because of foil quality and the inherent benefits of transferring the finish at the melt temperature of the thermoplastic. In-mold foiling also provides the designer with new opportunities because this application of finishes is not restricted to flat surfaces.

Developing technologies include the application of specialized films such as wood, vinyls, and leathers, and the expansion of design capabilities through interfacing in-mold components with other techniques like electroplating.

With the opportunity to look at designs in their earliest stages, instead of trying to fit the process to an awkward design, the processors began to fully utilize the benefits afforded by in-mold applications. The obvious benefits lie in the reductions in labor and burden, because the part is partially or completely finished in the molding cycle and, in many cases, without a drastic change in the cycle time required. Another positive aspect of the in-mold processes is the ability to conform to geometries that would be impractical or impossible to finish by more conventional techniques. A third benefit is the variety of materials that may be utilized in the process, which allows for efficiencies of scale when a single mold is utilized to produce a variety of versions with different colors or patterns; moreover, the materials selected can be customized without regard to physical or chemical properties.

In-mold decoration has a long history. Inserts, preformed and trimmed, have been utilized for decorative components with deep draws for at least two decades, and commercial applications of in-mold foiling began in the early 1970s.

43.2 Process

43.2.1 Laminates

Insert molding consists of using pressure or heat to form a laminate with matched metal dies and inserting the formed laminate in the mold before each shot. Tooling to remove excess laminate from the edges is normally required, and where openings are required to match the molded part, cutting dies must be capable of locating these openings in the laminate within 0.002 in. Through the development of melt flow and laminate construction, extremely deep draws and complicated geometries have been accomplished with this technique. The laminate is a very important consideration in this technique, as the physical properties of the finished part are totally reliant on its construction. Utilizing heavy clear films as top coats, these laminates have developed systems capable of high abrasion resistance. In some of the earliest laminate films, trade-offs existed between abrasion and weathering. In these cases, the laminate film would pass 1000 cycles on a Taber Abrader with a CS-17 wheel and a 1000 g load but would be subject to delamination when subjected to severe weathering conditions involving heat, humidity, and UV exposure. Through years of development, present systems have been improved, and now specialized laminate formulations utilizing fluorocarbon-based systems are being designed for use on exterior automotive applications.

43.2.2 Foiling

In-mold foiling has been gaining more acceptance in the past 5 years, although as mentioned, the technology existed in the early 1970s. In-mold foiling differs from insert molding in that the foil is transferred from a carrier that is continuously fed through the molding machine; moreover, the carrier is not preformed, but is formed in the cavity during the injection cycle. To accomplish this, a foil must be selected with a carrier substantially different from that conventionally used for hot stamping. This is necessary because of the potential for stretching and wrinkling as the foil is moved through the tool and as it is formed during injection. In addition, the release must not allow premature flaking when the melt contacts the foil surface, and the bonding coat must be compatible with the temperatures and pressures associated with injection molding. Foil development for in-mold applications has resulted in dramatic improvements for this process throughout the 1980s. Not only have many of the concerns over splitting, stretching, and wrinkling been resolved, but more advanced coating systems have improved resistance to abrasion exposure.

The in-mold foiling process produces an excellent bond between the substrate and the foil, because the transfer occurs at the melt temperature of the substrate material. Because the foil is formed in the tool, there is no requirement for preforming, trimming, or cutting, as in insert applications. The foil can be fed on a continuous carrier without interrupting the molding cycle, and the relatively thin film will conform to surface patterns utilized to enhance the visual characteristics of the part, such as ticking for woodgrain applications. In-mold foiling can be successfully incorporated where windows and slots are required because the film is relatively thin (0.0003 in.), and after the transfer, any excess covering the opening can be removed with a simple blow-off operation at the molding machine.

To further enhance the capabilities of in-mold techniques, processors have begun to look into ways to accurately register foils to allow for the application of patterns and graphics in specific areas. Such registration can be accomplished through a guidance mechanism based on holes punched in the side of the foil, or by utilizing an electronic scanning device that locates voids along the edge of the foil and registers the foil accordingly. Because this system requires locating a specific pattern at a point on the molded surface, accuracy in both lateral and transverse alignments is more critical, and the use of statistical process controls for gauging and appearance values is highly recommended. Generally, the development work in this area is performed with the application of logos on flat surfaces.

Successful experiments have been run in which the logo is transferred to a nonflat surface, such as radiused sidewalls or recessed graphics, however. In conjunction with these attempts, work has been done to accomplish the simultaneous transfer of registered foils on both the first and second surfaces of a clear methacrylate part. By starting with a preprinted foil and utilizing this latter technique, some sample parts have been produced by in-mold means that would have required as many as 10 additional secondary operations to achieve the required finish. Still in its early stages of development, this process holds promise for providing the domestic supplier with a competitive technique for decorative acrylic logos.

43.2.3 New Materials

In addition to the processing innovations for in-mold applications, the use of unconventional materials offers opportunities for the market expansion of in-mold products. Although some restrictions do apply, vinyls, leathers, and even wood materials have been successfully applied to plastic substrates. These materials not only offer the designer a much greater variety of colors and textures, but also provide the opportunity to add a tactile element to the design through the feel of the materials and through the use of techniques such as backing the selected material with a compatible carrier. Testing to determine the effect of environmental exposures is underway at this time to analyze the properties of these new materials and thereby their application potentials. Work is also being done at present to apply conductive films in-mold to effect shielding from electromagnetic interference, and basic development work is under way to electroplate a film onto a mold surface and then injection mold the part structure behind the plate surface to produce an electroplated part in the mold.

One important note to both the designer and the processor: the in-mold processes must be viewed as integral parts of system designs. It is difficult to retrofit an in-mold process for an existing component, and the conversion is less cost effective if the job is at a mature market stage. Practice early involvement, determine whether an in-mold application will be cost effective, design the part to accommodate the technique, and interface the in-molded part with other decorative components to maximize the appearance and economic values. A case in point is a door trim panel.

The interior trim panel assembly consists of the chrome-plated back bezel, a custom color-injection-molded support bezel, and an overlay that has been produced with an in mold foil process. With respect to its impact on the electroplating-on-plastics industry, this application broadens the scope for decorative interiors because of its unique design and cost effectiveness.

Before this three-component system was developed, such parts were produced by an insert molding process followed by masking a vacuum metallization. The major benefit was that the component part was of a one-piece construction. It was felt that this was the most cost-effective way of producing interior trim panels. As a result, less chrome plating was required for interiors.

In this new application, chrome plating the backup bezel adds rigidity to the overall construction, and through this rigidity, large areas of plastic may be removed without affecting the integrity of the overall assembly. Once assembled, the chrome-plated backup bezel also serves to form the bright bead to frame the color and foil applications utilized in the assembly.

These three components are essentially assembled by a series of snap fits. This assembly arrangement produces a tight, secure assembly and as each decorative element is a separate component, the lines of separation between the color, foil, and the bright work are very crisp and distinct.

A benefit of multiple-component assembly over one-piece assembly is that a variety of color combinations can be achieved with the basic set of tools by changing the custom color or by changing the foil. A large number of color and design variations can be achieved. This enables the manufacturer to utilize his tooling over a number of years. An additional advantage is the natural appearance and inherent integrity of the chrome-plated bead, which are superior to these properties in products made by conventional metallization or foiling. Because no top coating is required and no individual masking, secondary tooling costs can also be reduced. This means that the assembly is cost competitive as well. This product is an example of what early involvement and preengineering can accomplish.

43.3 Conclusion

One of the most formidable arguments for the use of in-mold products is the potential requirement in the future for the reduction of volatile organic compounds (VOCs) in the finishing of plastics. The printing of the carriers produces far less VOC emissions than does the painting of the part, and because the in-mold process does not degrade the transferred film, release of volatiles at the molding machine is minimal. In the final analysis, in-mold finishing techniques offer great promise, because they simultaneously address the areas of quality improvement, environmental control, and cost effectiveness, and these are precisely the factors that have plagued the domestic processor for the past decade.

HVLP: The Science of High-Volume, Low-Pressure Finishing

44.1	The Principles behind HVLP	44-1
44.2	The Benefits of HVLP	44-1
44.3	HVLP versus Conventional Air Spray	44-3
44.4	HVLP versus Airless and Air-Assist/Airless.....	44-3
44.5	HVLP versus LVLP	44-4
44.6	Compliant Technologies: HVLP and Electrostatic	44-4
44.7	Components of an HVLP System.....	44-4
44.8	Differences between HVLP Systems	44-5
44.9	Operating an HVLP System	44-7
44.10	The Use of Air Cap Test Kits.....	44-7

Steve Stalker

ITW Industrial Finishing

44.1 The Principles behind HVLP

High-volume, low-pressure (HVLP) atomization utilizes a high volume of air delivered at 10 psi or less to atomize fluid material into a soft, low-velocity pattern. This reduction in the velocity of the airstream over the 40 to 70 psi typically delivered by conventional spray methods results in a more controlled spray pattern, less bounceback, and enhanced transfer efficiency. Transfer efficiency can be defined as the amount of paint sprayed that goes onto the part as compared to the amount lost due to overspray and bounceback.

In general, HVLP can be used with most low-to-medium solids materials including two-component paints, urethanes, acrylics, epoxies, enamels, lacquers, stains, and primers. Some HVLP application equipment can atomize higher viscosity materials and/or higher fluid flow rates.

44.2 The Benefits of HVLP

High transfer efficiency enhances both productivity and finish quality. Less overspray improves visibility, which limits operator error. It also reduces deposits on adjacent surfaces, which typically results in a dry, sandy finish. Reducing overspray will reduce spray booth maintenance, filter replacement, waste disposal, and materials costs ([Figure 44.1](#) and [Figure 44.2](#)).

Depending on the application, two-thirds or more of every gallon of material sprayed by conventional methods can be lost to overspray. But with HVLP, typically one-third or less is lost to overspray. Productivity does not suffer either because more paint is applied per pass, and fewer passes are required.

But while finish quality and materials savings are important benefits, perhaps the most compelling reason to consider HVLP is the current trend toward legislated transfer efficiency requirements. The

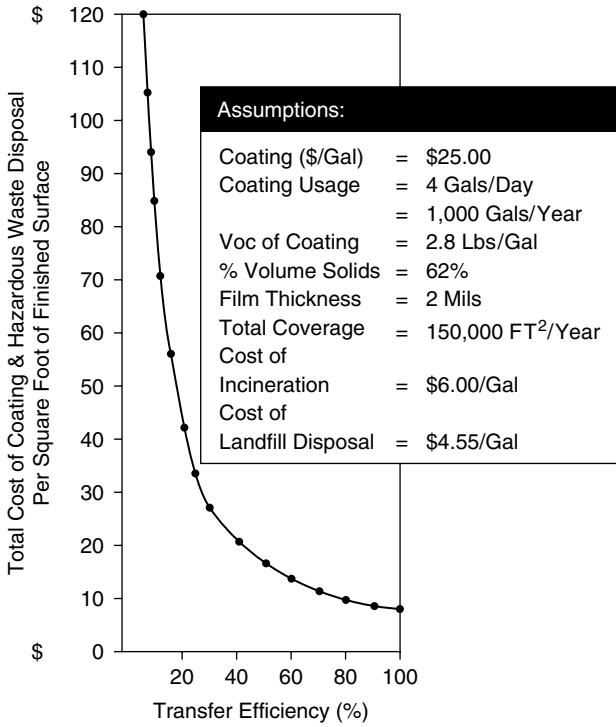

FIGURE 44.1 Effect of transfer efficiency on cost for a medium-size facility.

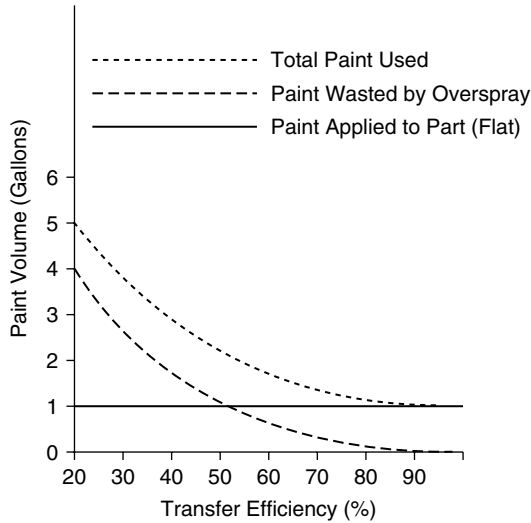

FIGURE 44.2 Why HVLP?

“National Emission Standards for Hazard Air Pollutants” (NESHAP) and California’s “South Coast Air Quality Management District” (SCAQMD) are two of the major regulations/agencies designed to reduce the effect of finishing operations on the environment. While currently only aerospace and wood furniture fall under NESHAP regulations, many other industries including general metal fabrication and auto/light truck, are in the planning stages.

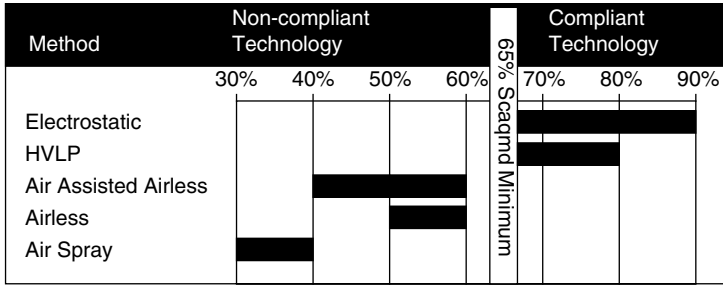

FIGURE 44.3 Typical transfer efficiency of spray-coating methods.

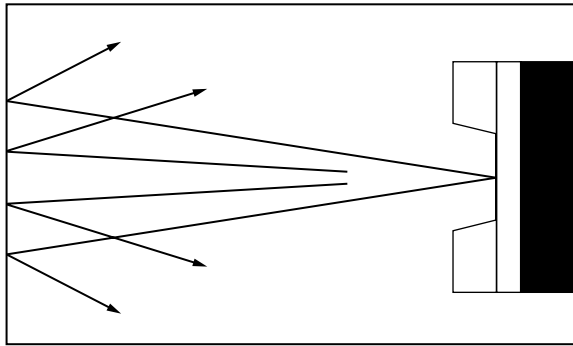

FIGURE 44.4 High-pressure spray (conventional air spray).

SCAQMD VOC legislation requires that all spray equipment deliver at least 65% transfer efficiency. Similar legislation is pending in many other states, and it is expected that high transfer efficiency will soon be required nationwide. In establishing its VOC requirements, the SCAQMD specified HVLP and electrostatic as the only two spray methods to meet that criteria. In so doing, it has defined HVLP as any spray finishing system that delivers an atomization pressure of between 0.1 and 10 psi measured at the air cap (Figure 44.3).

44.3 HVLP versus Conventional Air Spray

HVLP is most often compared with conventional air spray. Both use compressed air for atomization, but HVLP is limited to 10 psi, whereas conventional air spray is limited only by available plant air supply. It is common to see air pressures of 60 or greater psi used with conventional air spray when much less is actually required. Conventional air spray produces typical transfer efficiency of 25 to 40% and a great deal of overspray and bounceback. All of the benefits of high transfer efficiency and reduced overspray mentioned previously for HVLP are directed toward the comparison between HVLP and conventional air spray (Figure 44.4 and Figure 44.5).

44.4 HVLP versus Airless and Air-Assist/Airless

Most airless and air-assist airless spray methods do not meet minimum transfer efficiency requirements. In many instances, airless spray does not provide small enough particle size to meet quality requirements. Air-assist airless can improve particle size but may not meet minimum transfer efficiencies. HVLP, however, provides more control over film wetness and less mottling of metallics than air-assist while meeting minimum transfer efficiency requirements.

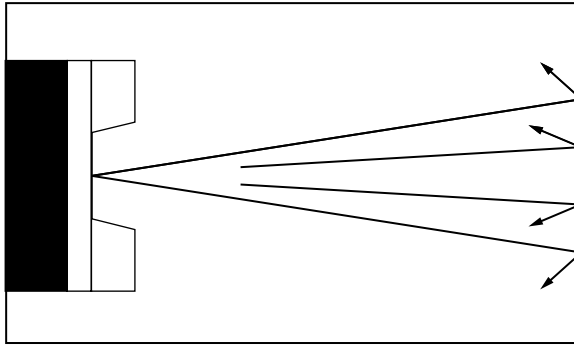

FIGURE 44.5 Low-pressure spray (HVLP).

44.5 HVLP versus LVLP

Some manufacturers have modified their existing technologies to function at 10 cfm or less. One of these, low-volume, low-pressure (LVLP) seems intended for low-viscosity materials such as stains, varnishes, and lacquers. But with paints, even medium solids might make the material too viscous for proper atomization. Thinning the material reduces the solids content (possibly making the material noncompliant), nullifying the benefits of transfer efficiency.

There is, however, a direct relationship between an HVLP spray gun's ability to atomize and the cfm required at 10 psi. Typically, spray guns that operate at 10 cfm or less are only able to atomize low-viscosity/low-solids materials at less than 6 oz/min. On the other hand, ratings of spray guns in the 15 cfm or more range can atomize the more viscous materials at flow rates exceeding 10 oz/min while maintaining finish quality requirements.

44.6 Compliant Technologies: HVLP and Electrostatic

Both HVLP and electrostatic are considered compliant technologies. In general, electrostatic spray delivers higher transfer efficiency than HVLP, particularly on metal tubular parts where electrostatic "wrap" is a real advantage. Here are some other facts to consider when choosing HVLP or electrostatic for your application.

HVLP is ideal for applying finishing material to nonconductive parts, such as plastic and wood, because it does not require a prep coat or other process to make the parts conductive. HVLP and electrostatic are both widely used to coat metal parts, with HVLP not requiring continuity to ground. HVLP is well suited to parts with recessed areas where the Faraday cage effect can prevent electrostatic spray from delivering effective coverage or can cause heavy buildup of material on corners and edges.

Recent technology changes have greatly improved HVLP's ability to atomize higher solids materials and/or higher fluid flows, with special air cap, fluid tip, needle, and baffle combinations designed for this purpose.

HVLP electrostatic combines electrostatic technology with limiting the air pressure to 10 psi at the air cap. This technology combines some advantages of both HVLP and electrostatic.

When considering HVLP or electrostatic (or the combination of both), the best way to decide which best meets specific needs is to test the equipment using end-user-specified material, parts, and painters and then do a payback analysis (Figure 44.6).

44.7 Components of an HVLP System

An HVLP system consists of a high-volume air source, a material supply system, and special HVLP spray guns. Air sources can be centralized, serving multiple spray guns, or dedicated to single spray gun use.

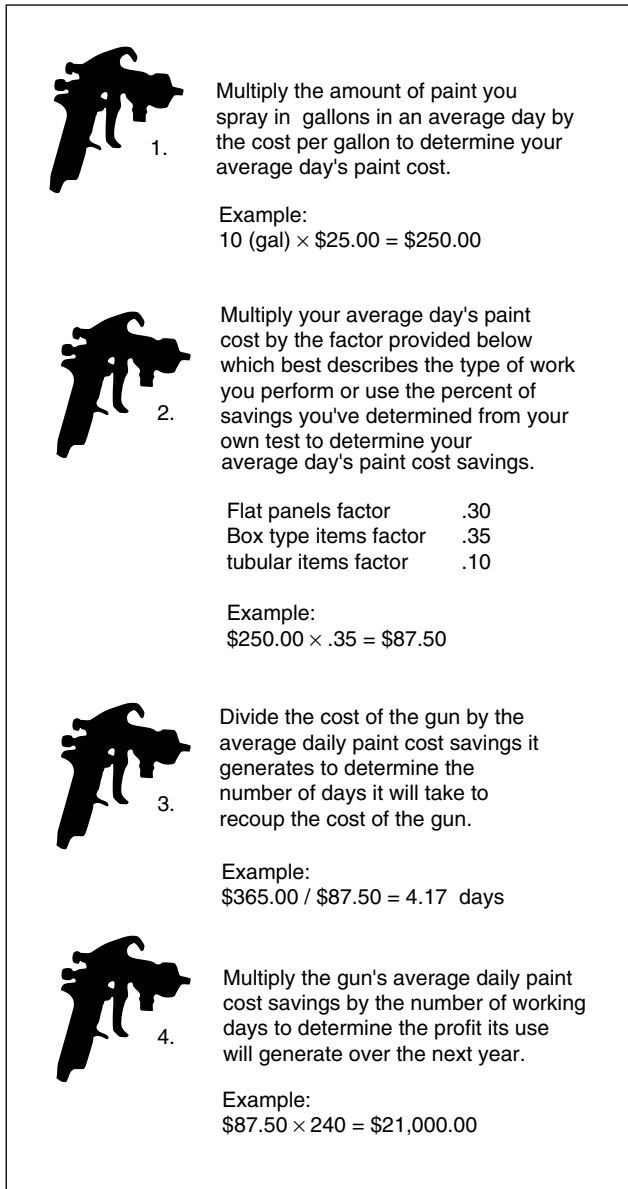

FIGURE 44.6 Payback rate formula.

Material may be supplied through any conventional supply system. Air caps and fluid tips are available to meet most production and quality requirements.

44.8 Differences between HVLP Systems

Generally, the factors that affect which spray finishing method will be selected will also affect which specific HVLP system is selected. Among these are atomization quality, finish quality, product reliability, and the suppliers' technical support. Once the decision to go with HVLP has been made, there are other factors to consider, including three basic HVLP air supply designs.

The first design generates air flow from a turbine generator (Figure 44.7), which offers portability and assures air volume that is not always available when using shop air lines. However, the temperature of

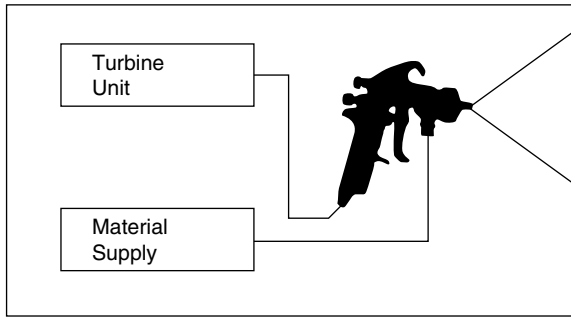

FIGURE 44.7 Turbine generator air supply configuration.

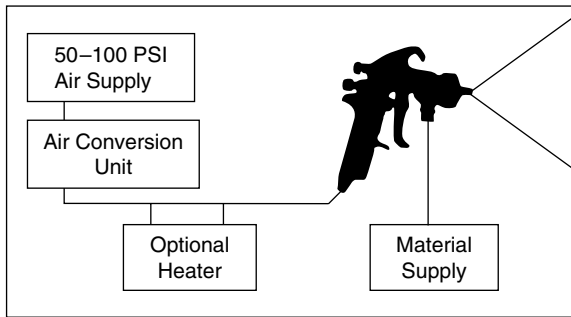

FIGURE 44.8 Shop air supply with air conversion unit configuration.

the air from a turbine is not always controllable; pressure is not always sufficient to provide effective atomization with higher viscosity materials; and turbines generally require a higher level of maintenance.

The second design (Figure 44.8) diverts shop air through an air conversion unit, which reduces atomization air pressure to 10 psi or less before the air reaches the spray gun. When fitted with air heaters, the heat can be adjusted or eliminated. They can also be regulated to deliver consistent pressure. Plus, they are more reliable than turbine generators. However, larger internal diameter (ID) air hose and a separate air conversion are required.

The final design also utilizes shop air (Figure 44.9). However, it reduces the air pressure to the required 10 psi or less within the gun. This design eliminates the need for a separate air conversion unit while delivering the same degree of control over air pressure. In addition, it offers added convenience because it can be connected with a standard air line (1/4" fitting and 3/8" or 5/16" air hose).

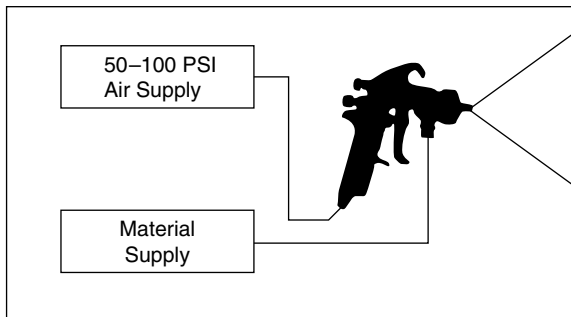

FIGURE 44.9 Shop air supply with gun air conversion configuration.

44.9 Operating an HVLP System

Operating an HVLP spray gun is slightly different from operating a conventional air spray gun. Because of HVLP's higher transfer efficiency, the fluid flow rate should be decreased. In addition, as particle velocity is slower with HVLP, the spray gun should be held 6 to 8 in. from the target part as compared to the 8 to 10 in. typically used with air spray guns. Finally, keep in mind that HVLP spray guns can produce less noise than air spray guns because of the greatly reduced atomization pressure generated.

44.10 The Use of Air Cap Test Kits

Air cap test kits may be required by some air quality agencies, but they are highly recommended for the proper setup and HVLP equipment. These kits are supplied with a special air cap and test gauge to demonstrate actual pressure being used at the cap because it will vary depending on the hose length, hose ID, and connection fittings between the air regulator and the spray gun. They can be used as a quality control device for consistent spraying each day.

45

A Practical Guide to High-Speed Dispersion

45.1	What Is a Dispenser?	45-1
45.2	How Does It Work?.....	45-1
45.3	What Is the Difference between a Dispenser and an Agitator?.....	45-2
45.4	When Do I Need to Use a Dispenser rather than an Agitator?.....	45-3
45.5	What Are the Limitations of a Dispenser?.....	45-3
45.6	What Different Types of Dispensers Are Available, and What Type Is Best for Me?.....	45-4
45.7	How Do I Select the Proper Size Dispenser?.....	45-5
45.8	How Do I Select the Proper Size Tank for My Dispenser?	45-5
45.9	How Do I Select the Proper Size Blade for My Dispenser?	45-5
	How Do I Know When It Is Time to Replace My Blade? • What Type of Blade Works Best on My Dispenser?	
45.10	What Other Factors Affect the Performance of My Dispenser?	45-6
45.11	How Do I Operate My Dispenser for Optimum Performance?	45-7
45.12	What Safety Measures Must I Follow and Why?	45-7

Herman Hockmeyer

Hockmeyer Equipment Corporation

Every year, new people join the various businesses that use mixing machines in their laboratories and manufacturing facilities. What seems obvious to many experienced personnel can be complicated and frustrating to these newcomers. The purpose of this chapter is to present a fundamental explanation of the “what, how, when, and why” about high-speed dispensers. This chapter is dedicated to those newcomers who will become the experts of the future.

45.1 What Is a Dispenser?

A dispenser is a type of mixer used to rapidly break apart lumps of powdery material, uniformly distributing and wetting them in a liquid. It is also used to dissolve soluble solids in a liquid.

45.2 How Does It Work?

A dispenser works on the principle of energy transfer. A disc-type blade is mounted at the bottom end of the mixing shaft and rotated at relatively high tip speed (Figure 45.1). (Tip speed is the speed at the



FIGURE 45.1 Disperser.

outer tip or edge of the rotating disc. Tip speeds typical of dispersers are measured in feet per minute, calculated by multiplying the constant 3.14 times the diameter in feet of the disc times the revolutions per minute of the mixing shaft. (The industry terminology for tip speed is peripheral velocity.) The solids and liquids are drawn into the rotating disc by the suction it creates. This suction usually results in a visible whirlpool from the top of the mixture down to the top of the disc. A similar whirlpool is created below the disc, extending from the bottom of the tank to the underside of the disc. The whirlpools are actually two individual vortices, although common industry practice refers only to the visible upper one known as the vortex.

When the solids–liquid mixture enters the vortices and is sucked into the high-speed disc, the energy (horsepower used to drive the disc) is instantaneously transferred from the disc to the mixture. This intensively focused energy transfer creates tremendous, instantaneous velocity changes in the mixture as it progressively contacts the disc. (Think of the mixture as a series of individual horizontal layers descending downward from the top and upward from the bottom onto the face of the rotating disc.) As each layer contacts the disc, it is instantaneously accelerated from the slow moving vortex into the very high speed of the disc and projected outward away from the disc and toward the wall of the tank. The rapid tearing apart of layer upon layer of the mixture is shear force, commonly referred to as shear.

45.3 What Is the Difference between a Disperser and an Agitator?

Both the disperser and the agitator will mix. Mixers are sometimes compared to pumps. The performance of a pump is usually measured in the horsepower required for its gallons per minute discharge capacity. A disperser is a high-powered, low-volume pump. Considering its substantially higher horsepower per gallon requirement, a disperser is an inefficient mixer. An agitator is a low-powered, high-volume pump. It is an efficient mixer. A typical dispersion application (such as dispersing pigment to make paint) requires about 1 hp for every 10 gal compared to an agitator application (such as thinning the pigment dispersion with solvent) that requires about 1 hp for every 100 gal. Although the agitator is the more efficient pump, it does not create sufficient shear to disperse most solids into the liquids.

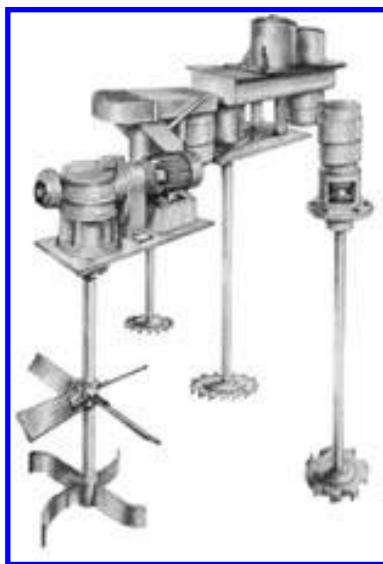

FIGURE 45.2 Agitators.

Moderate shear dispersers operating at about one-half the normal blade speed of high shear dispersers are sometimes used in place of agitators when some shear is required. Typically, the discs have larger teeth to promote better pumping and require about one-third the horsepower of a high shear disperser but still three times more than an agitator (Figure 45.2).

45.4 When Do I Need to Use a Disperser rather than an Agitator?

A disperser will generate the shear force necessary to rapidly delump powders in a liquid. This delumping process is called dispersion. The agitator is an efficient mixer, but it typically cannot generate sufficient shear to disperse powders, regardless of how long they are mixed. This is because the forces holding the agglomerates (lumps) together are stronger than the force of the mixer trying to pull them apart. Mixers can do an excellent job of holding dispersed (sheared) mixtures in suspension, but they typically cannot disperse (shear) the mixture.

45.5 What Are the Limitations of a Disperser?

The limitations of dispersers are product rheology dependent. That means much has to do with the flow characteristics of the product being dispersed. If it is too thick, it will not move freely to and from the blade from the wall of the tank, and hence, there will be dead zones of undispersed materials in the tank. If it is too thin, there may not be sufficient body to generate tearing between the layers of product as they consecutively contact the rotating disc. Tacky or “sticky” products may also hinder the ability of the blade to generate proper flow within the tank. Proper flow should resemble a doughnut, with the blade acting as the hole. Product should flow in a circumferential pattern around the tank wall while simultaneously rolling inward to contact the blade. This type of flow is sometimes referred to as a doughnut roll. If undispersed particles stick to the walls of the tank or the flow is insufficient to roll the entire dispersion into the blade, a thorough dispersion is unachievable. Without flow, there is no “go”.

Adding supplementary agitation to help feed the disperser blade can extend the operating range of a disperser. This type of machine is typically called a dual or triple shaft mixer, it has a shaft with a slow-moving sweeper blade passing close to or scraping the tank wall to promote mass flow, and one or more additional mixing shafts with disperser blades to generate high shear.



FIGURE 45.3 Tank mounted disperser.

45.6 What Different Types of Dispersers Are Available, and What Type Is Best for Me?

Dispersers are available with single-speed, two-speed, and variable-speed mixing shafts. Some are directly mounted atop a tank and are fixed to operate with the blade in only the original mounting position (Figure 45.3). Other tank-mounted dispersers can raise and lower the blade by several feet (to better control the vortex) without exiting the tank. Another design, perhaps the most popular, places the disperser atop a hydraulic lift (similar to the ones used at gas stations to lift automobiles) that is mounted to the floor (Figure 45.4). The lift enables the operator to raise the blade completely out of the mixing vessel and change to another vessel. This technique uses small portable tanks (up to 500 gal) that can be rolled away on wheels or picked up with a fork truck. Larger stationary tanks are often centered within the arc of rotation from the center of the hoist to the center of the mixing shaft. The bridge containing

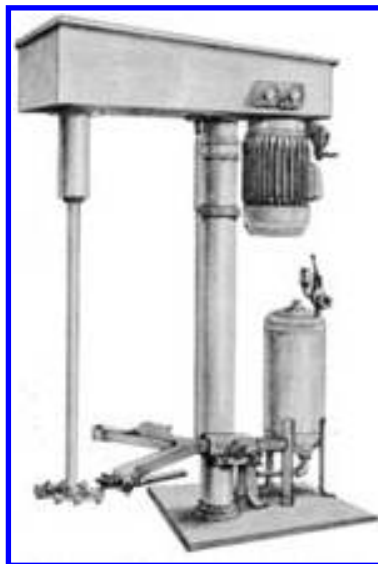

FIGURE 45.4 HV-HVI disperser.

the mixing shaft at one end and the motor at the other is then rotated from one tank to the next. Choosing the best configuration of available designs is a combination of functional need and economic justification. An experienced process engineer or consultant familiar with dispersers is a good investment.

45.7 How Do I Select the Proper Size Disperser?

The size of a disperser is generally thought of in terms of horsepower. However, there are dispersers that are dimensionally very large but use relatively small amounts of horsepower. These are exceptions to the rule.

The horsepower of the disperser is related to the blade diameter and the anticipated load the blade will create at a given speed and resistance. The resistance is a function of the rheology of the dispersion as well as the viscosity and density. However, as the blade diameter increases, the horsepower increases disproportionately. For example, if a 12 diameter blade were to draw 20 hp in a non-Newtonian system (viscosity changes with shear), doubling the blade diameter could increase the horsepower demand by a factor of 5. That means a 24 diameter blade of the same design, working in the same product, would require 100 hp. The larger blade would also pump considerably more so it would lend itself to working in a much larger (perhaps five times the volume) tank and producing a much greater amount of finished product in the same time period.

Horsepower requirements are interrelated with blade diameter, tank diameter, batch size, rheology, viscosity, and density. Variations outside recommended operating parameters usually result in compromises in performance, such as poor particle separation, extended dispersion times, and a decrease in quality of the finished product.

45.8 How Do I Select the Proper Size Tank for My Disperser?

The ideal tank for most dispersers is slightly taller than wide. Dished- or bowl-shaped bottoms aid in preventing solids from accumulating in sharp corners associated with flat bottoms. Equally as important, dished bottoms drain to the center, where a discharge valve can be installed. Flush bottom ball valves welded into the center of the dished bottoms further enhance the ease of discharge and cleaning. Optimum tank geometry is an integral part of several aspects that need be considered and are listed later in this chapter.

45.9 How Do I Select the Proper Size Blade for My Disperser?

The blade is sized based upon the flow characteristics of the product and the desired degree of dispersion. The thicker the product, the larger the blade diameter must be in comparison to the tank diameter. Conversely, the thinner the product, the smaller the blade diameter must be in comparison to the tank diameter. This comparison is called the blade-to-tank ratio. Thick products like heavy, flowable pastes may require a ratio of 1/2:1. Moderate products like paint require 1/3:1 ratio, and thin products like stains can work with up to a 1/8:1 ratio.

For example, if the blade-to-tank ratio is 1/3:1, and the tank diameter is 6 ft, the blade diameter would be 2 ft.

45.9.1 How Do I Know When It Is Time to Replace My Blade?

Once the batch formula has been process optimized, the typical time required to reach maximum dispersion should range from 20 to 30 min after the last ingredients have been added. Longer times do not usually result in better dispersions and, in some cases, can be detrimental because of the higher batch temperatures generated by the high shear disperser blade. As the blade begins to wear, longer batch times are required to get to the optimized dispersion standard. Sawtooth-type disperser blades should be replaced once the blade tips are worn to one-half their original height.

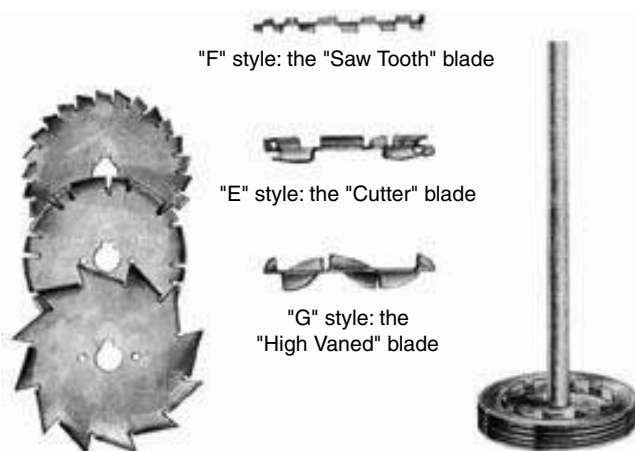

FIGURE 45.5 Disperser blades.

45.9.2 What Type of Blade Works Best on My Disperser?

High shear disperser blades are available in a range of styles and sizes (Figure 45.5). They can be generally categorized into two groups: open sawtooth and ring type. Both categories work well when used under the proper operating conditions.

The open sawtooth blade is the most popular because of its low cost, ease of cleaning, and general utility. It is available in a wide range of tooth designs. As the teeth increase in size and become more aggressive in shape, the pumping ability of the blade increases. However, as pumping (turbulent flow) increases, shear decreases. A high pumping saw blade still generates significant shear compared to a low shear paddle blade agitator. This aspect is an important consideration when determining exactly what is to be achieved in the finished product.

The ring-type blade is a powerful tool for optimizing disperser performance. It is more expensive to purchase and consumes more horsepower than the saw blade. It typically runs at higher tip speeds (5700+ fpm) and performs more like a rotor stator. Instead of solely depending upon the face of the disc and the configuration of the sawtooth for shear and flow, much of the ring blade's work is done hydraulically, as centrifugal force forces the product between the contoured rings, creating velocity differentials and a high-pressure zone within, and then instantaneously discharging into the low-pressure area outside the rings, creating a film splitting venturi effect. Additional heat is created as a by-product of the higher shear. However, in some cases, this higher shear level eliminates or greatly reduces any subsequent milling that may have previously been required.

45.10 What Other Factors Affect the Performance of My Disperser?

Formulating for a disperser is an important part of reaching optimum dispersion. Optimizing a formula can sometimes have more to do with how and when ingredients are added, because basic recipe changes may not be acceptable. In most instances, rapid addition of about one-half the total amount of powders into the liquid vehicle is acceptable, although careful observation of each initial formula is prudent to ensure that powders are not floating on top of the batch for more than a few seconds. Adding dry powders too rapidly can "choke" the blade and may result in an incomplete, unstable dispersion. The last half of the powders should be added progressively more slowly until the final percentage completes the formula. The blade speed should be adjustable from a minimum of one-half the final tip speed at the beginning of the powder addition to the maximum of the final tip speed as the batch thickness and flow slow. This procedure helps prevent splashing and overvortexing, which are inefficient for dispersion and can cause

excessive air entrapment in the dispersion. Assuming the rules of tank size, horsepower, blade size, etc., have been followed, most dispersions are completed within 20 to 30 min after the last of the powders have been properly added. Continuing the dispersion process beyond that time is usually unproductive and can actually cause harm to some ingredients if the temperature continues to rise.

Typically, dispersers perform best when the flow pattern is doughnut shaped and the blade tips are traveling at about 5000 ft/min in a medium viscosity (1500 to 5000 centipoises). Lower tip speed may be acceptable at higher viscosities, and higher tip speeds may be acceptable at lower viscosities to get to the same shear rate and stress. In other words, shear is a function of blade tip speed and product rheology.

45.11 How Do I Operate My Disperser for Optimum Performance?

The following is a summary of the detailed aspects outlined in the above paragraphs. Optimum performance requires the following criteria:

1. Start with a clean tank
2. Correct blade-to-tank ratio
3. Proper formulation
4. Suitable blade in good condition
5. Highest appropriate blade tip speed
6. Correct tank geometry (length compared to width)
7. Sufficient horsepower
8. Proper technique of adding raw materials
9. Proper rheology

45.12 What Safety Measures Must I Follow and Why?

1. Read the operation and safety instructions supplied by the manufacturer. If they are not available, call the manufacturer and request additional copies.
2. Be certain that all operators are properly trained on the use and drilled on the potential dangers involved with the disperser.
3. Do not operate the machine unless all the appropriate safety features are in place and are functioning properly. On hoist mounted units that raise and lower the blade, these features include but are not limited to mixing shaft guard, tank holder with limit switch, and limit switch on lift to prevent machine from operating with blade or shaft within reach of the operator.

The disperser is a very fast and powerful machine. Serious and fatal accidents can occur in a split second of carelessness. Human reflex is no match for the instantaneous danger of operating a disperser unsafely. Never sacrifice safety for convenience.

III

Materials

46

Acrylic Polymers

46.1	Introduction	46-1
46.2	Chemistry and Manufacture	46-1
	Monomers • Polymerization Methods	
46.3	Versatility of Acrylics	46-2
	Glass Transition Temperature • Emulsion Acrylics	
46.4	Application Areas	46-4
	Coatings • Adhesives • Inks	
46.5	Coating Techniques	46-8
	Gravure Coaters • Flexographic Coaters • Wire-Wound Rod Coaters • Knife over Roll Coaters • Reverse Roll Coaters	

Ronald A. Lombardi

ICI Resins US

James D. Gasper

ICI Resins US

46.1 Introduction

Since their introduction decades ago, acrylic polymers have gained a strong foothold in the coatings and allied industries as a result of their improved flexibility and adhesion compared to polyvinyl acetate emulsions, phenolics, and styrene-butadiene latex combined with their moderate cost. In addition, their significantly improved outdoor durability, including resistance to ultraviolet degradation, has mandated their use in several applications. In many respects, the name “acrylic” has become synonymous with a high performance level in a polymer system.

Presently, acrylics are available in three physical forms: solid beads, solution polymers, and emulsions. The emulsion form is by far the dominant form in use today. This is due generally to the ease of tailoring properties, and the lower hazards and manufacturing costs compared to the solid and solution polymers.

46.2 Chemistry and Manufacture

46.2.1 Monomers

Acrylic monomers are esters of acrylic and methacrylic acid. Some common esters are methyl, ethyl, isobutyl, *n*-butyl, 2-ethylhexyl, octyl, lauryl, and stearyl. The esters can contain functional groups such as hydroxyl groups (e.g., hydroxyethyl methacrylate), amino groups (e.g., dimethylaminoethyl methacrylate), amide groups (acrylamide), and so on, in addition to the carboxylic acid functionality of the unesterified monomer. Acrylic monomers can be multifunctional (e.g., trimethylolpropane triacrylate, or butylenes glycol diacrylate, to mention two). The polymer chemist has a wide range of monomers to select from when designing a specialty polymer system.

Typically, mixtures of comonomers are chosen for the properties they impart to the polymer. Adhesive strength, for example, is increased by using monomers with low glass transition temperatures such as butyl acrylate or 2-ethyl hexylacrylate. Members of the carboxylic acid group of acrylic and methacrylic acids also tend to increase the adhesive properties of polymers. Cohesive strength is usually imparted by the harder acrylic monomers such as methyl methacrylate and methyl acrylate. Molecular weight is also a significant contributing factor, and these two parameters must be carefully balanced by the polymer chemist.

When functional groups are needed for postreaction, monomers such as hydroxyethyl methacrylate or *N*-methylolacrylamide are incorporated. Hydroxyl groups can be used in combination with melamine and epoxy curing agents to achieve cross-linking. Similarly, other functional groups (acid groups, amines, amides, etc.) can be incorporated.

46.2.2 Polymerization Methods

46.2.2.1 Bulk Polymerization

As the name implies, bulk polymerization is accomplished by initiating acrylic monomers in the absence of solvents other than the monomers. Typically, peroxide or azo initiators are used. The major problem, of course, is the viscosity increase realized after approximately 30% conversion. Generally, heavy-duty mixers and temperatures exceeding 150°C are used to control viscosity. The well-known Tromsdorf gel effect is often observed at high conversion, leading to rapid exotherms, high molecular weight fractions, and increased polydispersity. Processes for the bulk polymerization of acrylic copolymers are described in the patent literature.¹⁻³

46.2.2.2 Solution Polymerization

Adding a solvent to a bulk polymerization recipe allows much easier control of viscosity at high conversions. Again, peroxide (e.g., benzoyl peroxide, lauryl peroxide) or azo (azobisisobutyronitrile) initiators are used. Mercaptans and halogenated hydrocarbons are used to regulate molecular weight. Most solvents also act as chain transfer agents to some extent. Generally, acrylic polymers prepared by solution polymerization are less than 100,000 molecular weight units.

46.2.2.3 Suspension Polymerization

The process of suspension polymerization, as the name implies, involves the use of a dispersing agent to stabilize monomer droplets in a continuous phase, usually water. With continued agitation, the suspended droplets are polymerized using oil-soluble initiators, again, peroxides and azo compounds. In fact, the polymerizing droplets exhibit bulk polymerization kinetics, as each droplet is actually a small bulk reactor with the continuous aqueous phase acting as a heat sink. Typical suspending agents include polyvinyl alcohol, polyacrylic acid, and hydroxyethylcellulose. As might be expected, suspension polymerization is usually limited to monomer compositions with glass transition temperature T_g that is near to or greater than ambient temperature; otherwise, gelation or blocking easily results in the dry bead. Following polymerization, the suspension polymer particles, or beads, are dewatered, washed to remove impurities such as suspending agents and electrolytes, and dried.

46.2.2.4 Emulsion Polymerization

Perhaps the most complex of the polymerization processes, emulsion polymerization has been well studied and described. As the name implies, the acrylic monomers are emulsified using a surfactant and are suspended in a continuous phase, water. Water-soluble initiators are used to initiate polymerization. Some common examples are ammonium or potassium persulfate, hydrogen peroxide, and redox pairs such as *t*-butyl hydroperoxide-sodium formaldehyde sulfoxylate.

Polymerization is generally thought to initiate in the water phase. A growing radical precipitates to a micelle containing monomers and continues to polymerize. The growing micelle is resupplied with fresh monomer by diffusion from monomer droplets. For a thorough discussion of the emulsion polymerization process, see [Reference 4](#).

46.3 Versatility of Acrylics

46.3.1 Glass Transition Temperature

By selecting proper monomers, the glass transition temperature of the polymer and, therefore, the likely application area, can be varied. The glass transition temperature of a polymer is the simple average

TABLE 46.1 Glass Transition Temperature

Homopolymer	T_g (°C)
Acrylic acid	112
Methyl methacrylate	106
Methyl acrylate	8
Isopropyl acrylate	-8
Ethyl acrylate	-24
<i>N</i> -Butyl acrylate	-56
2-Ethyl hexylacrylate	-65

Source: From Rohm and Haas Company, Bulletin SP197, Special Products Department.

TABLE 46.2 Glass Transition Temperature versus Application Area

T_g (°C)	Suggested Application Area
80–100	High heat-resistant coatings
50–65	Floor care coatings
35–50	General industrial coatings
10–40	Decorative paints
25–35	Binders for inks
-60–25	Adhesives

value in degrees Celsius representing a range of temperatures through which the polymer changes from a hard and often brittle material into one with soft, rubberlike properties. Although these average T_g values sometimes vary with the test method used, they are reproducible within certain limits and represent specific polymer characteristics. The glass transition temperature is useful as a guideline for softness of hand, low temperature flexibility, and room temperature hardness and softening point. The glass transition temperature should be used to compare hardness and softness of latex only within a simple polymer group.⁵

Table 46.1 illustrates the wide range in T_g resulting from different monomer compositions.

46.3.2 Emulsion Acrylics

Emulsions have become the dominant technology in acrylic polymers, and we therefore focus much of our discussion on this category. Table 46.2⁶ correlates T_g ranges of emulsion acrylics with specific application areas. There is obviously overlap to be expected among the ranges. By varying the monomer compositions, we have a clear indication of the versatility of acrylics.

The wide range for adhesives encompasses pressure-sensitive polymers and heat-activating polymers, which dry to a tack-free state.

46.3.2.1 Physical Properties

On a physical basis, emulsions can be characterized in the following fundamental areas: solids content, viscosity, pH, particle size, minimum film forming temperature (MFT), and particle charge.

Solids content is determined by drying latex to constant weight, viscosity is determined by use of the Brookfield Viscometer, and pH is determined by pH meter. Particle size usually ranges from about 0.05 to 0.5 μm , depending on the type and amount of surfactant employed; measurement is usually made by laser light-scattering technique, electron microscopy, or ultracentrifuge.

Particle charge is discussed in the paragraphs that follow.

As mentioned previously, surfactants stabilize liquid monomer droplets formed by agitation. Polymerization takes place in monomer micelles to form the solid dispersed particles of polymer in water. Surfactants are classified into three types: anionic, nonionic, and cationic.⁷

The most common type, anionics, ionize in water to leave a negative charge on the latex particle. Nonionics do not ionize but stabilize by a combination of hydrophobic and hydrophilic regions on the molecule. Cationics, which are not commonly used, ionize to give the particle a positive charge.⁸

Surfactants help to improve mechanical and chemical stability of the emulsions but also tend to increase the water sensitivity of the dried film.

46.3.2.2 Minimum Film Forming Temperature

Unlike solution polymers, which have one homogeneous phase, emulsions are polymer particles dispersed in water, the continuous phase. Upon drying, the particles must combine or coalesce to form a continuous film. If the process is carried out at room temperature (25°C) with a polymer with a T_g value above 25°C, film formation will not occur. In this case, the polymer must be heated to above its T_g or a coalescing agent must be added to the latex to soften or plasticize the particles so that they will combine to form a continuous film. Coalescents often used are high boiling liquids that have a solvating effect on the polymer but later evaporate so that the full physical properties of the polymer alone are achieved. Generically, many of these coalescents are classified as glycol ethers. Their relative toxicology has recently been studied.⁹

46.4 Application Areas

46.4.1 Coatings

The use of acrylic polymers for both emulsion and solution coatings is very diverse. Before discussing the areas in which acrylics might be used in coatings, let us first identify the fundamental reason for considering the use of a coating, namely, to protect the substrate being coated from the environment. There are additional reasons, depending on the end-use area.

Once the need for a coating has been decided, a further requirement is apparent; namely, the coating must adhere to the surface that has been coated because to decorate or protect any surface, the coating must remain in position. This phenomenon is known as adhesion. The reader is directed to an excellent review of the methods to determine satisfactory adhesion of a coating.¹⁰ An additional point to consider is the air dry nature of properly formulated waterborne acrylics. Their full properties are developed not through extensive heat cure cycles but by room temperature drying through the use of coalescing agents, as discussed earlier. Where heat is available, increased solvent and heat resistance can be attained by the addition of cross-linking agents.

Each end-use product requires certain specific property characteristics to achieve the feature needed for the application; the type of substrate to be coated, as well as the manner in which the part is used, determine the property requirements. It is clear that plastics do not require a corrosion-resistant coating; therefore, a coating designed for plastics has property requirements different from a coating designed for metals. At the same time, adhesion of the coating, which is important for any substrate, becomes a key characteristic.

However, achieving adhesion to any specific substrate may require a totally different product requirement. Materials that adhere to metal may fail to bond to plastic. Therefore, coatings for metals may have to differ significantly from coatings for plastics or wood to achieve the desired performance. Each substrate area, therefore, requires the design of a specific coating to meet its individual end-use requirement for the intended application.

Returning to application of acrylics in coatings, we will center our discussion on five major areas:

- Automotive
- General metal
- Maintenance
- Wood
- Business machines

46.4.1.1 Automotive

With the increased use of plastics in automotive applications has come a surge in the use of coatings. Plastics are coated to improve resistance to chemicals, solvents, ultraviolet light, and abrasion, as well as exterior durability.¹¹ Other applications for coatings include the engine enamels area, underbodies, and auto refinishing work. Performance properties required include grease resistance, durability, and adhesion to oily metals.

46.4.1.2 Coatings for Metal

Coatings are needed for metal casings and transformers. The requirements for such coatings include chemical resistance, hardness, and corrosion and humidity resistance. Because steel is still commonly used, the ability to protect this metal from corrosion remains an important requirement.¹²

46.4.1.3 Maintenance Coatings

Coatings are required for bridges and storage tanks, where again, properties of corrosion and humidity resistance are required.

46.4.1.4 Wood Coatings

Coatings for boards destined to be used in furniture and kitchen cabinets require blocking and detergent resistance, sandability, and resistance to grain raising.

46.4.1.5 Business Machines

Coatings for calculators, typewriters, copy machines, and analytical instrumentation are common examples in the business machine category. Performance required includes chemical and solvent resistance and adhesion to plastics [e.g., polycarbonate, polyphenylene oxide, acrylonitrile–butadiene–styrene (ABS)].

46.4.2 Adhesives

Both solvent and emulsion acrylic adhesives are extensively used in the industry, but before discussing adhesives, we need to address the fundamental difference between a coating and an adhesive. A coating must adhere to only one substrate; an adhesive must adhere to one substrate and then to a second substrate. A coating, once applied, is exposed to the elements and must withstand abrasion, marring, solvents, water, and heat. It may require high gloss and other special properties, as well.

An adhesive is protected to a certain degree by being sandwiched between two substrates. It, therefore, does not have to have some of the performance properties that must be built into a coating. It must ideally have a bond strength high enough to fracture or tear at least one of the substrates. In many cases, the bond strength should not be materially affected by heat, solvents, or water. Therefore, an adhesive must not only have good anchorage to both substrates (adhesive strength), it must also have high enough cohesive strength to fracture or tear one of the substrates upon delamination. Thus, an adhesive must balance adhesive strength with cohesive strength.

Another basic difference between emulsions (coatings and adhesives) is in their film formation properties. To have hard, tack-free, and heat-resistant coatings, the glass transition temperature of the polymer is intentionally designed to be higher than room temperature. The coating then requires a coalescing agent to form a clear continuous film. Adhesives form films at room temperature without the need for coalescing aids. A soft flexible polymer film is desired for an adhesive, and this film should be thermoplastic (i.e., able to soften and flow repeatedly upon the application of heat). The film can subsequently be cross-linked through functional groups if heat and solvent resistance are desired.

Acrylic-based adhesives are normally employed where improved specific adhesion and/or resistance to yellowing from exposure to ultraviolet rays is required. Acrylics are used in three main areas: heat-sealable adhesives, laminating adhesives, and pressure-sensitive adhesives. These are discussed separately.

46.4.2.1 Heat-Sealable Adhesives

Heat sealing is used for bonding two substrates where one or both are impervious to water. Typically, the more heat- and solvent-resistant substrate is coated first, and the solvent or water is driven off in an oven. At this point, the web can be wound up on itself (if the dried adhesive is tack free or nonblocking) and heat sealed to the secondary substrate at a later date. Alternatively, the adhesive-coated substrate can be laminated simultaneously to the second substrate to form the finished product. The latter case is the laminating adhesive technique, discussed later. When heat is applied to activate or soften the adhesive, two conditions must be met for adequate bonding:

1. The adhesive must have sufficient flow at the activation temperature to properly wet out the secondary substrate.
2. The adhesive must have a chemical affinity or specific adhesion to the particular substrate. This comprises the secondary chemical bonding forces, which give rise to what we call adhesive bonding.

Many applications involving food packaging fall into this category. Examples include lidding-type adhesives for coffee creamers and jams and the blister packaging of pharmaceuticals.

46.4.2.2 Laminating Adhesives

Laminating adhesives function much the same as heat-seal adhesives except that the temperature necessary to activate the adhesive is much lower. Where heat-seal adhesives may require an activation temperature of 120°C (250°F), laminating adhesives can be designed to function anywhere between room temperature and 90°C (200°F). Recently, new low temperature curing types of adhesive have, to some degree, replaced two-component solvent-polyurethane adhesives in the flexible packaging area.¹³ Designing a room temperature curing mechanism into an acrylate system further enhances opportunities to replace solvent systems.¹⁴ Considerable progress has also been made using low temperature curing acrylics in the industrial area.¹⁵

Typical applications include vinyl-to-wood laminating and bonding vinyl to ABS for automotive interiors.

46.4.2.3 Pressure-Sensitive Adhesives

The pressure-sensitive method of bonding is often called the “one-way” bonding method. The adhesive is coated onto the substrate either directly or by transfer coating. The adhesive is protected by a release liner until it is ready to be used. When application is desired, the liner is removed and the adhesive-coated substrate is bonded to the other substrate using pressure alone. Pressure actually activates the adhesive, hence the name of this method. Upon firm pressure, the tacky adhesive mass actually flows and bonds itself both mechanically and chemically to the other surface.

However, to be functional, a pressure-sensitive adhesive must be more than just very tacky. Flypaper has a very high degree of tack but lacks internal strength or cohesiveness. A functional pressure-sensitive material will have high tack or adhesive strength combined with high cohesive strength, the basis requirement for any adhesive.

Pressure-sensitive adhesives are used in many tape areas such as packaging, masking, electrical mending, medical, and mounting. The graphic arts area includes vinyl decals and special decorative films such as clear and metallized polyester films. These areas generally require an outstanding balance of properties that must be retained under severe outdoor exposure and temperature extremes. Such properties as outstanding resistance to ultraviolet light degradation and plasticizer migration are required. Adhesives for this area must produce clear and colorless films, dictating the use of acrylics exclusively.¹⁶

Solvent-based polystyrene acrylics (PSAs) have been traditionally used in these areas. More recently, they have been replaced in varying degrees with their emulsion counterparts.¹⁷ However, there still exist technical areas in which the solvent systems prevail.¹⁸ These include applications requiring high levels of heat, water, and solvent resistance.

TABLE 46.3 Property Comparison of Alkali-Soluble Acidic Resins

Property	Resins				
	Acrylic Polymers	Maleic Rosinates	Shellac	Protein	Styrenated Maleic Copolymers
Dispersibility	Fair–good	Fair	Fair	Fair	Good
Wet rub	Fair–good	Poor	Fair	Poor	Poor
Dry rub	Good	Fair	Good	Good	Fair
Heat resistance	Fair–good	Poor	Poor	Good	Good
Foam	Fair–good	Poor	Fair	Fair	Poor
Print quality	Fair–good	Fair	Fair	Poor	Good
Gloss	Fair–good	Poor	Good	Poor	Good
Drying rate	Fair	Poor	Poor	Poor	Good
Shelf life	Good	Fair	Fair	Fair	Fair
Resolubility	Fair	Fair	Good	Good	Good

Source: From Sen, G., *Am. Ink Maker*, 65, 12 (1987).¹⁹

46.4.3 Inks

The use of acrylic polymers to formulate waterborne inks has grown steadily in the past 10 years. The major cause for this growth has been government regulations imposing limits on solvent emissions by printers. The same reason, of course, sponsored the growth of waterborne coatings and adhesives. The choices left to the printers are as follows:

- Install solvent recovery–incineration systems.
- Develop compliant high solids solvent inks.
- Develop adequately performing waterborne inks.

Because many printing companies have selected the third option, our discussion will focus on it.

In addition to the pigment, waterborne acrylic inks are usually composed of two types of acrylic polymer, an emulsion-polymerized acrylic and an alkali-soluble solid acrylic type of resin. The emulsion acrylic contributes to finished ink properties such as film formation, adhesion to plastic films, and scuff, heat, and alkali resistance. However, emulsion polymers are very poor pigment wetters. In addition, they have poor flow characteristics compared to their solvent-borne counterparts. The alkali-soluble resins are good pigment wetters, display good rheology, and prevent drying of the ink in the cylinders when the line is stopped during printing runs.¹⁹ Many different types of alkali-soluble resin can be used in combination with the emulsion acrylics.

Table 46.3 compares the properties of acrylic polymers to four other generic classes: maleic rosinates, shellac, protein, and styrenated maleic copolymers.

By combining the best properties of emulsion-polymerized and alkali-soluble acrylics, reasonably performing waterborne inks are gradually replacing the traditional solvent types. These waterborne inks are being used in such diverse applications as stamps, cigarette cartons, beer cans, milk cartons, food packaging, wallpaper, grocery bags, newspapers, and corrugated boxes.¹⁹

Despite these successes, there still exist drawbacks and technical problems with the waterborne inks.²⁰ Among these are the following:

- *Drying problems.* To maintain solvent line speeds, more efficient drying ovens are required.
- *Foaming.* Use of suitable antifoam agents has considerably minimized this problem.
- *Freeze–thaw stability.* Depending on formulation, the printer must also consider storage conditions during winter months.
- *Resolubility.* Sometimes referred to as drying out on the press, this requires a careful balance between the alkali-soluble resin and the emulsion polymer.

With increased research and development efforts, the outlook for improved performance and growth of waterborne acrylic-based inks is quite optimistic.

46.5 Coating Techniques

A variety of coating techniques are used for applying adhesives, coatings, and inks. The specific method chosen depends on certain criteria, including the following:

- Viscosity/rheology
- Film thickness desired
- Shape of substrate
- Cost
- Versatility of use
- Thickness tolerances

Table 46.4 illustrates the coating techniques that have been used successfully in three applications areas: adhesives, coatings, and inks. (The list is not exhaustive.)

The following methods are widely used and will be discussed in greater detail:

- Gravure
- Flexographic
- Wire-wound rod
- Knife over roll
- Reverse roll

46.5.1 Gravure Coaters

Gravure coaters are used typically when coating weights under 0.2 mil are desired. The gravure coater is used in the ink industry when a precise, reproducible amount of ink has to be applied to a substrate. Gravure cylinders are engraved with various fine patterns called cells. The patterns are designated by the number of cells per inch, followed by the cell name, which represents the shape of the cell (e.g., quadrangular, helical, pyramidal). After application, the applied ink pattern will flow together on the substrate to form a continuous film.

TABLE 46.4 Commercial Coating Techniques

Technique	Usefulness with		
	Adhesives	Coatings	Inks
Gravure	+	+	+
Flexographic	-	-	+
Letterpress	-	-	+
Lithographic offset	-	-	+
Screen	-	-	+
Wire-wound rod	+	+	+
Knife over roll	+	+	-
Reverse roll	+	+	-
Direct roll	+	+	-
Floating knife	+	+	-
Curtain coating	+	+	-
Air spray	+	+	-
Airless spray	+	+	-
Electrostatic spray	+	+	-
Brush	+	+	-
Dip coating	-	+	-

The major advantage of gravure coaters is that coating weight is independent of web tension and line speed. However, once running, the coating weight can be varied only by changing the percent solids of the ink (or adhesive). This method, therefore, is costly because of the need to maintain many cylinders to accommodate varying coating weights.

Laminating adhesives for the flexible packaging industry use gravure coaters. Typical coatings weights for these applications are about 0.2 mil. These are applied primarily using a quadrangular cell pattern.

46.5.2 Flexographic Coaters

In flexographic printing, a cylinder similar to a gravure cylinder picks up ink from the fountain and, through a series of rolls, deposits a film of wet ink on a raised printing surface. This raised printing surface then applies ink to the substrate. The process is ideal for dimensionally unstable substrates such as thin polyolefin films, because the printing plate will deform slightly when it comes in contact with the film and not cause deformation of the film. Application viscosity of flexographic inks is between 35 and 200 cp. Typical dry film thickness applied is 0.1 to 0.3 mil.²⁰

46.5.3 Wire-Wound Rod Coaters

Wire-wound rods are used when relatively low coating weights (0.2 to 0.8 mil) are required. Adhesive or coating viscosities of 200 to 1000 cp would be typical. Simplicity of operation, low maintenance, and inherent low shear characteristics make this technique a popular choice. Rod coaters apply an excess of coating to the substrate and then utilize a wire-wound rod for metering to the desired coating weight. The final amount of coating remaining on the substrate is a function of the area of the cavity between the tightly wrapped wires on the rod. The number given to the rod indicates the thickness of the wire wound on it. For example, a #16 rod would have 0.016 in. diameter wire wound on it. As the number increases, so does the thickness of the wire and volume of the cavity between adjacent wires; thus, higher numbers deposit greater amounts of adhesive. Additional factors that affect coating weight deposition for a given rod are web tension and uniformity, adhesive solids, viscosity, and rheology. When applying low coating weights, wire-wound rods are second only to gravure coaters in depositing accurate and uniform coating thicknesses. Ease of changeover and low cost give wire-wound rods an advantage over gravure coaters.

46.5.4 Knife over Roll Coaters

Knife over roll coaters have long been used to apply adhesives for high viscosity, high coating weight, pressure-sensitive products, such as masking tapes. A knife over roll coater consists of a rubber or steel backing roll, a knife, and a coating hopper. Because the substrate passes between knife and backing roll, any variation in backing thickness will cause a variation in adhesive applied. This is the major drawback to the knife over roll method. If backing thickness increases, the amount of adhesive deposited in that area decreases. Therefore, the uniformity of the adhesive laydown is only as good as the profile or caliper of the backing material being coated.

Typically, viscosities of 10,000 to 100,000 cp can be applied by this method, which gives it some attractiveness. Depending on adhesive solids and viscosities, coating weights of 0.5 to 2.0 dry mils can be applied.

46.5.5 Reverse Roll Coaters

Reverse roll coaters have been the primary method for the production of high quality, pressure-sensitive decals for the graphic arts industry. The reverse roll coater consists of a rotating steel applicator roll, a stationary steel metering roll, and a rotating rubber backup roll. The applicator roll moves in the opposite direction of the web, which indicates the derivation of the name. Coating weight is controlled by the speed of the applicator roller relative to the speed of the backup roller. Speeding up the applicator roll

increases coating weight, whereas slowing the applicator roll decreases coating weight. The primary reason for using a reverse roll coater is that a precise, uniform coating weight across the web can be attained. Dried film tolerances of ~ 0.0001 in. are possible. The other desirable feature is that coating weight thickness is independent of the backing weight variation. This is exactly opposite to the relationship on a knife over roll coater. Coating thickness in a reverse roll coater is generally a function of the following:

- Gap between applicator and metering roll
- Applicator roll speed
- Adhesive solids, viscosity, and rheology

Two primary coating supply systems are used when applying adhesives or coatings by reverse roll. For higher viscosities (10,000 to 20,000 cp), a nip-fed arrangement is utilized. For lower viscosities (3000 to 10,000 cp), a pan-fed system is preferred.

The principal drawback to the reverse roll coater is the expense, as high precision rolls and bearings are required. However, the initial investment is usually outweighed by the improvement in quality of the finished product.

References

1. J. A. Brand and L. W. Morgan, U.S. Patent 4,546,160; S. C. Johnson & Son, Inc.
2. K. W. Free, U.S. Patent 3,821,330; E. I. Dupont de Nemours and Co.
3. K. Shimada et al., U.S. Patent 3,968,059; Mitsubishi Raon Co. Ltd.
4. H. F. Mark, *Encyclopedia of Polymer Science and Technology*, Vol. 5. New York: Wiley, 2003, pp. 801–859.
5. B.F. Goodrich Chemical Company, Latex Product Date, Bulletin L–12, p. 14.
6. Rohm and Haas Company, Bulletin SP197, Special Products Department.
7. B.F. Goodrich Chemical Company, Latex Bulletin L–10, p. 4.
8. B.F. Goodrich Chemical Company, Latex Bulletin L–19, p. 12.
9. R. A. Heckman, *J. Prot. Coat. Linings*, 3, 10 (1986).
10. J. E. Fitzwater, Jr., *J. Water-Borne Coat.*, 8, 3 (1985).
11. J. E. Fitzwater, Jr., *J. Water-Borne Coat.*, 7, 3 (1984).
12. G. Pollano and A. Lurier, *J. Water-Borne Coat.*, 9, 1 (1986).
13. P. Foreman, *Paper Film and Foil Converter*, November 1982.
14. R. A. Lombardi, *Adhes. Age*, February 1987.
15. A. H. Bealieu and F. P. Hoenisch, *J. Water-Borne Coat.*, 10, 1 (1987).
16. D. Satas, *Handbook of Pressure Sensitive Adhesive Technology*, 2nd ed. New York: Van Nostrand Reinhold, 1989.
17. R. A. Lombardi, *Higher Performance Water-Borne Pressure Sensitive Adhesives*. Pressure Sensitive Tape Council Seminar, Itasca, IL, 1987.
18. F. T. Koehler and J. A. Fries, *Acrylic Emulsion PSAs: Performance vs. Acrylic Solutions*. Spring Seminar, Adhesive and Sealant Council, Atlanta, 1985.
19. G. Sen, *Am. Ink Maker*, 65, 12 (1987).
20. M. T. Nowak, *Am. Ink Maker*, 62, 10 (1984).

Vinyl Ether Polymers

47.1	General.....	47-1
47.2	Monomers.....	47-1
47.3	Production of Polymers.....	47-1
47.4	Products on the Market.....	47-2
47.5	Properties.....	47-2
47.6	Applications.....	47-3
	Bibliography.....	47-3

Helmut W. J. Müller
BASF AG, Ludwigshafen/Rhein

47.1 General

The general formula for vinyl ether polymers used in the production of adhesives and coatings is as follows.

The consistency of these polymers depends on their molar mass and ranges from viscous oils to rubbery solids.

Vinyl ether was first converted into a resinous polymer more than a century ago. Between 1920 and 1930, it became readily accessible by the techniques of Reppe chemistry and thus attracted industrial interest. Means were then investigated for polymerizing it. In 1938 the large-scale production of vinyl ether polymers commenced in the Ludwigshafen works of the former IG-Farbenproduktion (now the main production site of BASF AG). GAF Corporation started production after 1940, followed by Union Carbide Corporation, which relinquished the field in 1976.

47.2 Monomers

The Reppe reaction between acetylene and an alcohol gives rise to vinyl ether:

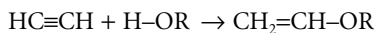

It is still the only method of producing vinyl ethers that has acquired industrial significance. The properties of the constituent monomers are listed in [Table 47.1](#).

47.3 Production of Polymers

Vinyl ethers can be easily polymerized in bulk or in solution, by batch or continuous techniques. Owing to the considerable heat of reaction, careful control and elaborate equipment are essential. The monomers and the initiator are metered continuously into the reactor, and the polymerization reaction sets in within a few minutes. After the reactor has been completely charged, it is closed, and polymerization proceeds further under pressure. The boiling point of the monomer or the solvent governs the rate at which the

TABLE 47.1 Monomers Used for Producing Vinyl Ether Polymers

Product	Structure	Molecular Weight	Density at 20°C (g/cm ³)	Flash Point (°C)	Melt Point (°C)	Boiling Point (°C)
Vinyl methyl ether	CH ₂ =CH-O-CH ₃	58.1	0.747	-60	-122	~6
Vinyl ethyl ether	CH ₂ =CH-O-CH ₂ -CH ₃	72.1	0.754	-45	-115	~36
Vinyl isobutyl ether	CH ₂ =CH-O-CH ₂ -CH(CH ₃)-CH ₃	100.2	0.769	-15	-112	~83

TABLE 47.2 Conventional Vinyl Ether Polymers

Polymer Based on	Commercial Name	Manufacturer	K Value	Nature of Polymer	Glass Transition Temperature
Vinyl methyl ether	Lutonal M 40	BASF	~50	Soft resin	~-25
	Gantrez M	GAF	~50	Soft resin	~-25
Vinyl ethyl ether	Lutonal A 25	BASF	~12	Viscous oil	~-45
	Lutonal A 50	BASF	~60	Soft resin	~-30
	Lutonal A 100	BASF	~105	Tacky rubber	~-25
Vinyl isobutyl ether	Lutonal I 30	BASF	~25	Viscous oil	~-25
	Lutonal I 60	BASF	~60	Soft resin	~-25
	Lutonal I 60 D	BASF	~60	Soft resin	~-20
	Lutonal I 65 D	BASF	~60	Soft resin	~-15

temperature rises during the reaction. The heat of reaction is removed by means of a reflux condenser and/or the reactor cooling system.

47.4 Products on the Market

Table 47.2 lists vinyl ether polymers on the market. As suggested in the table, it is common practice to describe the degree of polymerization by the K value, which is a measure for the average molar mass.

The form in which the polymers are offered depends on the production method and the demands imposed in application. Thus, they can be supplied in the solvent-free form or, to facilitate handling, as solutions in common solvents. Lutonal I 60 D and I 65 D are highly viscous 55% secondary aqueous dispersions and are produced from an 80% solution of Lutonal I 60 in mineral spirit (bp 60 to 140°C) with different protective colloids.

47.5 Properties

The degree of polymerization governs the physical form of polyvinyl ethers (i.e., whether they are viscous oils, tacky plasticizing resins, or rubbery substances). The products on the market are normally colorless. They may occasionally display a slight yellow to brown discoloration, due to side reactions of the initiator system, but this seldom affects their performance in any way. The polymers offer good resistance to hydrolysis. Products with a low to medium molecular mass (i.e., K 65) may have a slight odor that emanates from residual monomers or oligomers.

The solubility of vinyl ether polymers is shown in Table 47.3. It depends on the alkyl group. The fact that polyvinyl methyl ether is listed as a water-soluble polymer can be explained by the hydrogen bond between the liquid medium, water, and the oxygen atom in the ether group. Thus, the polymer, which is itself insoluble, is solvated by water to form a soluble associate. On the application of energy, the hydrogen bonds are again loosened — that is, the polyvinyl methyl ether loses its hydrate envelope and is thus precipitated. This occurs, for instance, in Lutonal M 40 solutions at about 28°C. The precipitation point is influenced by the concentration of the aqueous solution and the presence of any solvents.

TABLE 47.3 Solubility of Vinyl Ether Polymers

Polymer	Solvents ^a								
	Al H	Ar H	Chl H	LA	HA	E	Lk	Hk	Water
Polyvinyl methyl ether	–	+	+	+	+	+	+	+	+
Polyvinyl ethyl ether	+	+	+	+	+	+	+	+	–
Polyvinyl isobutyl ether	+	+	+	–	+	+	–	+	–

^a Al H = aliphatic hydrocarbons, Ar H = aromatic hydrocarbons, Chl H = chlorinated hydrocarbons, LA = lower alcohols, HA = higher alcohols, E = esters, Lk = lower ketones, Hk = higher ketones.

47.6 Applications

Vinyl ether polymers constitute a classical group of starting materials for the production of adhesives and coatings. They are primarily used in combination with other raw materials or — in one case in the pressure-sensitive adhesive sector — with polymers of the same type but different molecular mass.

Blending with vinyl ether polymers improves a number of the properties of the unblended products, including anchorage, adhesion or tack on difficult substrates, resistance to plasticizers, and resistance to aging.

The main applications in the adhesives sector are blends of polyvinyl methyl ether with starch or dextrin for label adhesives or blends of medium molecular weight polyvinyl ethyl ether with resin solutions for bonding carpets. Secondary dispersions of medium molecular weight polyvinyl isobutyl ether lag somewhat behind in terms of volume but not in importance. They are blended with acrylic dispersions in the production of pressure-sensitive adhesives. Blends of vinyl ethyl ether polymers of various molecular weights are used as pressure-sensitive adhesives in the medicinal sector.

In the field of surface coatings, polyvinyl methyl ether and medium molecular weight polyvinyl ethyl ether are formulated together with cellulose nitrate, chlorinated binders, and styrene copolymers for coating metal foil, plastics, film, paper, and other flexible substrates, and for antifouling paints.

Bibliography

Müller, H. W. J., Vinyl ether polymers, in *Handbook of Pressure Sensitive Adhesive Technology*, 2nd ed., D. Satas, Ed. New York: Van Nostrand Reinhold, 1989.

Poly(Styrene-Butadiene)

48.1 Introduction	48-1
48.2 Emulsion Polymerization	48-1
48.3 Characteristics of Styrene-Butadiene Latex	48-3
48.4 Uses	48-3
Bibliography	48-4

Randall W. Zempel
Dow Chemical Company

48.1 Introduction

Styrene-butadiene (SB) polymers are used in coatings formulations primarily to improve coating strength, printability, gloss, pigment and fiber binding, and substrate bond strength. The styrene-butadiene polymers are produced primarily by emulsion polymerization to form a latex. A latex is a dispersion of finely divided spherical particles of polymer in water. The monomer ratios of styrene and butadiene can be adjusted to give the desired amount of flexibility or stiffness. Polystyrene latex contains hard polymer particles that will not form a continuous film upon drying at room temperature. Polybutadiene latex contains very soft, gummy polymer particles that will produce a weak, sticky film when dried. By copolymerization of styrene and butadiene monomers and adjustment of the monomer ratios, it is possible to obtain a copolymer with a wide range of intermediate properties. Thus, a copolymer latex with a high styrene content will produce a very tough, durable film but will not have the flexibility and adhesive performance of a latex with a high butadiene content.

The temperature at which the copolymer changes from a brittle to a rubbery state is known as the glass transition temperature (T_g). Figure 48.1 illustrates the effect of the concentration of styrene on the T_g of SB copolymers. As the concentration of styrene in the copolymer increases, the T_g also increases. This property is important in coatings for determining durability of the dried film and optimizing curing conditions.

A typical latex will contain 45 to 55% polymer, with the balance being water.

Table 48.1 illustrates the typical properties of a styrene-butadiene latex. The particle size, composition, cross-linking, and molecular weight can all be controlled, and this is accomplished through free radical emulsion polymerization.

48.2 Emulsion Polymerization

Emulsion polymerizations require an emulsifier or surfactant composed of a hydrophobic and a hydrophilic portion to give the latex colloidal stability. As low levels of surfactant are added into the aqueous solution in a reactor vessel, the surfactant will saturate the water phase, and as the concentration is increased, the surfactant molecules will aggregate to form micelles. This concentration is known as the critical micelle concentration. As the styrene and butadiene monomers are added, they will diffuse through the water phase and into the micelles until an equilibrium is obtained. The majority of polymerization occurs within these monomer-swollen micelles. Figure 48.2 is a representation of the process.

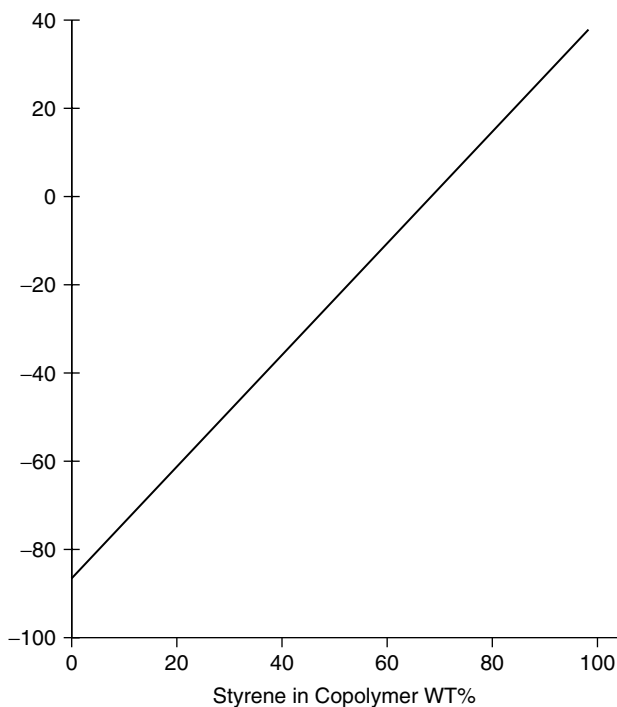

FIGURE 48.1 The effect of copolymer styrene content on glass transition temperature.

TABLE 48.1 Typical Properties of an SB Latex

Property	Value
Color	Milky white
Solids	50% wt.
pH	7 to 9
Brookfield viscosity	<500 cp at 25°C
Average particle diameter	20,000
Surface tension	45 dynes/cm
Specific gravity (at 25°C)	1.01
Styrene/butadiene ratio	50:50
Film properties	
Tensile strength (at break)	550 psi
Elongation	520%

Polymerization begins when water-soluble free radical initiators are added. Initiators, such as persulfate salts, are used for reactions above 50°C, and redox systems are used for reactions at lower temperatures. The initial reactions occur in the water phase to form a free radical. The free radical will react first with monomer double bonds in the water phase, and chain growth will begin. As the molecular weight increases, the chain becomes more hydrophobic and migrates to the swollen micelles, where the majority of polymerization occurs. The polymerization occurs in random fashion, and residual double bonds have the capability of further chain growth. This gives the SB latex the ability to form a three-dimensional polymer matrix. This cross-linking or branching can have a strong influence on the polymer's mechanical properties.

Chain transfer agents are added to control the molecular weight. They will lower the molecular weight of the polymer through chain termination and will result in improved wetting and binding characteristics.

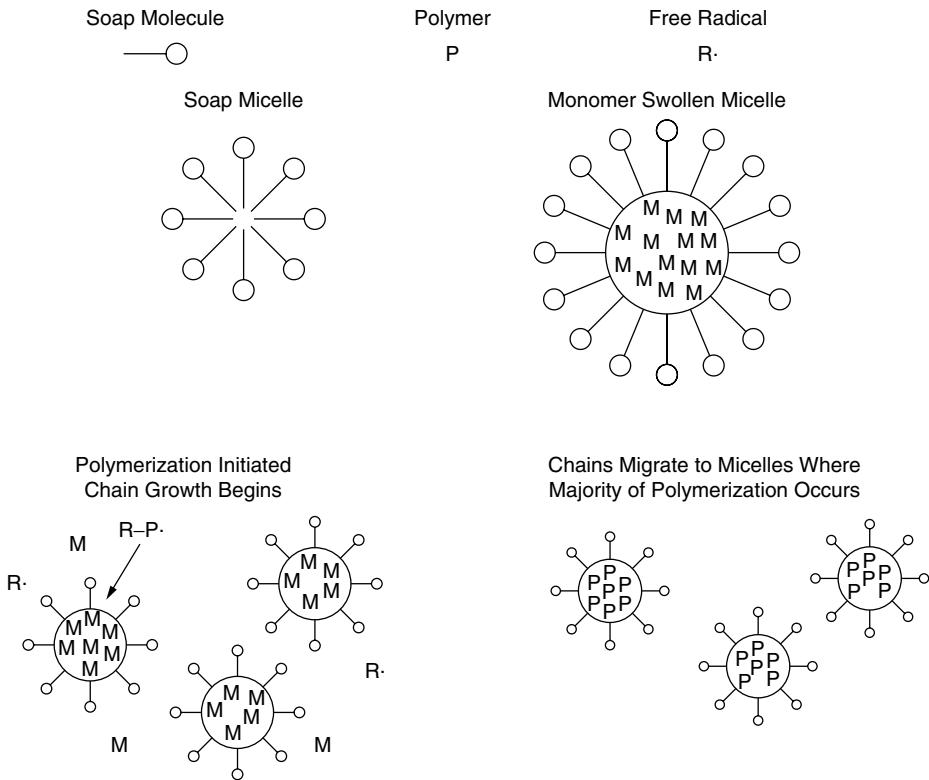

FIGURE 48.2 Free radical emulsion polymerization.

The surface of the latex particle can also be modified by functional modifiers such as amides, amines, and carboxylic acids, which provide improved colloidal stability and increased adhesion properties.

48.3 Characteristics of Styrene-Butadiene Latex

In coatings applications, several physical properties are key to determining performance of the latex polymer. These include glass transition temperature, particle size, minimum film formation temperature, rheology, and surface energy.

The S/B ratio and glass transition temperatures are useful as a basis for comparing performances characteristics of different SB latexes. End-use properties can be plotted against the S/B ratio and T_g to help determine the range of applicable polymers. Latex particle size and distribution affect high and low shear viscosity, gloss, and pick strength. Minimum film formation temperature (i.e., the minimum temperature at which a continuous film will form) is essential for determining process drying conditions. The minimum film formation temperature of a typical SB latex is slightly higher than its T_g . The reactions of the latex to increased shear stress and shear rate are important rheological properties, because they will affect machine runnability. As the shear stress is increased, shear thinning, shear thickening, or Newtonian flow can occur. The surface tension or surface energy of a latex will affect wettability and adhesion of the coating to substrates.

48.4 Uses

Styrene-butadiene latex is used in paper and paperboard coatings, textile coatings, as binders and coatings for flooring felts, as carpet backing, and in many other coatings applications. The material can be

produced with a wide variety of properties and can be tailored to specific end uses. Advantages of SB latex in paper coatings are excellent mechanical stability, pigment hiding power, improved gloss and ink holdout, and better printability. In textiles and carpets, SB latex provides excellent fiber adhesion, high filler loading, and a degree of dimensional stability and flexibility. Many other coatings applications use these basic features of SB latexes to improve end-use performance.

Bibliography

- Blackley, P. C., *Emulsion Polymerization, Theory and Practice*. London: Applied Science Publishers, 1975.
- Klun, R. T., "Fundamentals of latex technology," presented at 1986 TAPPI Coatings Conference, Washington, DC.
- Miller, F. A., in *Treatise on Coatings, Film Forming Compositions*, chap. 1. R. R. Meyers and J. S. Long, Eds. New York: Dekker, 1968, pp. 1–54.

49

Liquid Polymers for Coatings

49.1	Introduction	49-1
49.2	Fluid Properties	49-1
49.3	Commercial Liquid Polymers.....	49-1
	Polymers with Random Functionality • Telechelic Polymers • Curing	
49.4	Applications	49-3
49.5	Conclusions	49-5
	References	49-5

Robert D. Athey, Jr.
Athey Technologies

49.1 Introduction

High solids coatings are an alternative to solvent-borne coatings because of the coating industry's concerns for energy costs and the environmental impact associated with solvents. The use of 100% solids coatings, wherein a polymer binder precursor has functional groups, was accepted by the industry.

Synthesis techniques and monomers used control the binder properties through the influence on type and concentration of functional groups, chain configuration, and synthesis by-products. The impact on functionality is emphasized in several reviews.¹⁻³ The effect on fluid properties is also discussed. One paper on current commercial polymers includes recommended cure and uses.²

49.2 Fluid Properties

Liquid polymers, to be useful, must be capable of blending with additives, such as pigments, curatives, and stabilizers. Berry and Morrell discuss some of these variables in connection with liquid rubber.⁴ The factors that control this intermixing capability contribute to the viscosity of the coating system. These factors include the following:

- Interchain entanglement — a function of molecular weight
- The glass transition temperature of the polymer
- Inter- or intrachain interactions (e.g., hydrogen bonding)

Hydrogen bonding is important in many aspects of the flow and mixing of telechelic (end group functional) polymers and has been discussed by many authors.⁵⁻¹¹

49.3 Commercial Liquid Polymers

The commercial liquid addition polymers fall into several categories. Some of these products are listed in [Table 49.1](#). Among the materials shown are some oligomers for incorporation into ultraviolet or electron beam (EB) coating systems.

TABLE 49.1 Commercial Liquid Polymers

Type of Material	Manufacturer Brand Name
Polyether toluene diisocyanate (TDI) capped polymer	Upjohn Polymer Chemicals/Castethane DuPont/Adiprene series
Polyester TDI capped	Spencer Kellog/Many Thiokol/Solithane Spencer Kellog/Many
Alkyd-urethane	Spencer Kellog/Spenkel series
Aliphatic oil-urethane	Spencer Kellog/Spenlite series
Dimercapto liquid polymer	Philips Chemical Co./PM Polymer
Dimercapto liquid polysulfides	Thiokol/LP-2, LP-3
Telechelic polybutadiene	Arco Chemical Co./Poly BD, also have BD/St and BD/AN
Saturated polymer	Witco Chemical/Formerz series
Diols	Inolex Chemical/Lukorez series Hooker Chemical/Rucoflex
Bishydroxyethyl dimerate	Emery Industries/Emery 9360-A
Hydroxyl telechelic block poly(ethylene oxide-copropylene oxide)	BASF Wyandotte/Pluronic series (have triols and quadrols)
UV-cured epoxy resins	Union Carbide/Cyacure series
Acrylic end-capped urethanes	Freeman Chemical/Chempol Morton Thiokol, Inc./Uvithane Polymer Systems Corp./Purelast
Acrylic end-capped polybutylene glycol	Alcolac Chemical/DV-1402
Acrylic end-capped epoxy resins	Interaz/Celrad series and others
Epoxy end-capped polyisobutylene	Amoco/Actipol series
Polyisoprene, natural and synthetic	Hardman Inc./Kalene and Isolene series

49.3.1 Polymers with Random Functionality

Polymers having random functionality are available, but have limited usage. Cured poly(1,2-butadiene) was used for an experimental can coating (Firestone Tire & Rubber Co.). A solvent-based solution composed primarily of a polymer of trans-1,4-butadiene, which is thermally cured, is a commercial can coating (E. I. Du Pont de Nemours & Co.). Thermal cure depends on oxidative cross-linking in air, although additives, such as phenolic resins, are occasionally used. Because curing consumes considerable energy and produces gaseous by-products, alternative methods are desirable. Synthetic nonfunctional butadiene-acrylonitrile copolymer (Hycar 1312) is used with sulfur cure as a castable elastomer and as a plasticizer for polyvinyl chloride (PVC) or nitrile rubber compounding.

Nonfunctional liquid polymers based on natural products have been used commercially as plasticizers and castable elastomers for many years. They are based on natural rubber that has been depolymerized by oxidative degradation.¹²

Liquid polymers without functional groups are also used as tackifiers in adhesive applications. These include polymers mentioned in the preceding paragraphs and also liquid polybutene (Chevron Chemical Co.). This product has also been used as a stir-in additive for roof coating latexes.

A liquid polymer having random carboxyl functionality is recommended as an epoxy resin modifier to toughen cast plastic moldings. Its structure suggests that it is an emulsion copolymer of butadiene-acrylonitrile-acrylic acid in ratios 83:13:4, 78:17:5, and 62:32:6. Its application is similar to that of the liquid randomly epoxidized polybutadiene polymers (FMC Corp.).

49.3.2 Telechelic Polymers

Polymers having end group functionality are termed telechelic, and a recent review has been published.⁷⁶ The commercial telechelic polymers have a variety of available functionalities.

Amine-terminated butadiene-acrylonitrile is promoted as a flexibilizing agent for epoxy resins (B. F. Goodrich Chemical Co.). Liquid resins with hydroxyl end groups in free radical polymerized polybutadiene, styrene, or acrylonitrile are available (Arco Chemical Co.). Vinyl-terminated butadiene homopolymers with acrylonitrile are used as UV- or EB-cured coating modifiers (Goodrich). A polymer with mercaptan functional terminal groups is used in sealant applications (Phillips Chemical Co.). A bromine-terminated liquid polymer is also being developed (Polysar Ltd.).

Carboxyl-terminated butadienes have been available from several sources (Goodrich, Phillips, Thiokol Chemical Corp.). These products have been recommended as epoxy resin modifiers and rocket propellant binders. Carboxyl-terminated poly(butadiene-acrylonitrile) copolymers with 10, 18, and 28% acrylonitrile are available (Goodrich), as well as development hydroxyl-terminated copolymers, claimed to be diols (Scientific Polymer Products).

49.3.3 Curing

Curing of liquid rubbers for such applications as caulks, sealants, and O-rings, has been practiced for many years. These cures depend on the reaction of the rubber double bond. Yanko¹³ showed that a standard rubber vulcanization recipe does not cause curing of a liquid poly(styrene-butadiene). It has been shown that the formulation of hard rubber required 10 to 40 times the normal amount of sulfur to cure the liquid polyacrylobutadiene. Hardman and Lang¹⁴ developed a lead peroxide quinone dioxime cure system for liquid depolymerized natural rubber. The American Synthetic Rubber Corporation¹⁵ claims a sulfur for their liquid poly(styrene-butadiene) rubber in road tar and bitumen modification applications. Argabright and Kuntz¹⁶ used polythiols with UV light or peroxide to cure a liquid poly(styrene-butadiene). Friedmann and Brossas¹⁷ used bis-silyl coupling agents to react with the double bonds of a liquid polybutadiene. With the exception of hard rubber, these systems are normally low in tensile strength and elongation, as the cure sites are located at random along the polymer chain — the cross-linking density is low and the resultant gel is somewhat cheesy.

The main problem with the random cure on the liquid polymer chain is the distance between cross-links. The development of strength requires such a high degree of cross-linking that little capability for molecular motion is retained and a hard plastic product results. However, most applications require flexibility of elastomers. The solution is to use the liquid polymer's telechelic functions in a combined chain extension and cross-linking, retaining the segmental mobility, while still attaining the desired strength.

Examples of the types of cure for telechelic polymers of varying functionality are shown in [Table 49.2](#). Just about any chemical reaction may be used for curing or chain extension.

French¹⁸ has shown how to assess cross-link density in telechelic polymers by evaluation of gel content. Determinations of thermo-oxidative effects¹⁹ and variation in swelling of a society of poly(butadiene urethanes)²⁰ have been used to evaluate the cross-link density.²¹

Britain reported observations on catalyst effects on the urethane end-capped diols, which sometimes gel upon storage depending on the catalyst used. Reaction conditions for telechelic urethane polymer cures were modified by van Glulick and coworkers by including salts that coordinated to the amine curative.²² Comparison of random cure versus telechelic cure in carboxylated polybutadienes is discussed by Mastrolia and Klager.²³ Telechelically cured polymers showed improved mechanical behavior and storability. Molecular weight relation to tensile strength, tear strength, and hardness were discussed by Ono and coworkers.²⁴ A thermal cure based on styryl end groups requiring no added chemicals was demonstrated by Garcia.²⁵

49.4 Applications

The utility of liquid, especially telechelic, polymers was widely investigated.

The perfluoroalkyl iodide modified liquid polybutadiene may be used as a furniture polish or as an oil- and water-repellent textile coating.^{26,27} MgO-carboxylated telechelic polybutadiene combinations are useful when a thixotropic plastic coating is called for.²⁸

TABLE 49.2 Telechelic Polymer Cure Systems

Curative	Telechelic Species	Ref.
Peroxide	Polybutadiene diol–urethane end-capped reacted with unsaturated glycidyl ester	55
Polymerizable oligomer	Carboxylated telechelic rubber	56
Polyisocyanates	Polyisoprene, polybutadiene, polystyrene diols	57
Tetramethyldiamine	Halogenated telechelic polybutadiene	58
Diisocyanates	Hydroxylated telechelic polybutadiene	59, 60
Hexachloro <i>p</i> -xylylene	Carboxylated telechelic polybutadiene	61
Epoxy + <i>tert</i> -amine	Carboxylated telechelic polybutadiene of poly(acrylonitrile–co-butadiene)	62
Rubber	Peroxy-terminal liquid rubbers	63
4, 4'-Diaminodiphenylmethane	Isocyanate-terminated liquid polymer	22
Epoxy + <i>tert</i> -amine	Carboxylated telechelic polyisobutylene	64
Diamines	Brominated telechelic polybutadienes	65
Rubber + diisocyanates	Hydroxylated telechelic polybutadienes or poly(propylene oxide)	66
Chlorinated elastomer	Amineated telechelic polystyrene	67
<i>tert</i> -Polyamines	Halogenated telechelic polybutadiene	68
Iron	Carboxylated telechelic polybutadiene	69
Urethane	Isocyanate end-capped diols	70
<i>tert</i> -Amines	Mercapto ester capped liquid polymer	71
Mercaptan-terminated polymer	Liquid polymer with terminal unsaturation	72
Metal oxides	Carboxylated telechelic polychloroprene	73
Amine + iron	Mercaptan-terminated butadiene copolymer	74
Organotin and organotitanate	Hydroxy-terminated polysiloxane	75

Not all the liquid polymer coatings are based on telechelic functionality. Gray²⁹ described a randomly functional hydroxyacrylic oligomer synthesis for use in melamine resin cured coatings. Hamann and coworkers³⁰ devised a coating composed from a phenolic adduct to a liquid polybutadiene. The liquid poly(1,2-butadienes) used in metal coating have already been noted. However, these liquid polymers are not capable of chain extension.

Vaughn³¹ devised metal or textile coating polymers having terminal carboxyl groups. There are thermosetting acrylic powder coatings containing telechelic functionality.³² The Ford Motor Company³³ devised a powder coating based on carboxylated telechelic polymer and an epoxy curative.

The acrylic–methacrylic end-capped oligomers are viscous liquids used in the radiation-cured higher solids formulations. The lower portion of Table 49.1 shows some commercial varieties of such products. Morris³⁴ compared several acrylated oligomers in wood finishing applications, testing for adhesion and abrasion resistance to choose the optimum oligomers. Christmas³⁵ compared monomer-diluted, radiation-curable oligomers on a variety of metal substrates to obtain formulations optimized for impact resistance, adhesion, and flexibility in a “T” bend test.

Siebert et al.³⁶ used carboxylated telechelic polybutadienes to toughen epoxy coatings. Jones and coworkers³⁷ devised an epoxy coating cured by a mercaptan-terminated polymer. McPherson and Gillham³⁸ characterized epoxy resin coatings cured by carboxylated telechelic polybutadiene by torsional pendulum analysis, noting effects of molecular weight and compatibility of the components. Drake et al.³⁹ reviewed elastomer-modifier, epoxy-based coatings.

A steel coating was devised from a hydroxy telechelic poly(styrene–butadiene) and polyisocyanate curative.⁴⁰ A solventless coating capable of air curing was composed of an acryloyl-terminal polymer, a product of an acryloyl chloride esterification of a hydroxylated telechelic polymer.⁴¹

Acetylene-terminated polyphenylenes were reported as coatings by French.⁴² McDonald⁴³ used a methacrylate-terminated epoxy resin in a radiation-cured coating. Pechiney St. Gobain⁴⁴ devised a coating based on styrene (or other monomers) and a maleic-terminated unsaturated polyester. Vranken and Dufour⁴⁵ increased the number of electron beam cross-linking sites in low molecular weight polymers by converting mercaptoethanol chain transfer termini to acryloyl esters on acrylic polymers.

Ko et al. used oligomer glycols converted to the acryloyl or methacryloyl esters in a catalyzed peroxide cure steel coating.⁴⁶ Moisson-Frankhauser et al.⁴⁷ compared the use of maleinized polybutadiene to a carboxylated telechelic polybutadiene in alkyd coatings. A peroxide-cured unsaturated terminal polybutadiene gave better impact strength than poly-1,2-butadiene.⁴⁸

An aqueous nail varnish consisting of a polythiol, an olefin-terminal liquid polymer and hardening agent, was claimed.⁴⁹ A concrete coating was made from a mercaptan telechelic polychloroprene with ZnO, MgO, and an inorganic peroxide and an amine.⁵⁰

Moisson-Frankhausen et al.⁵¹ used carboxylated telechelic polybutadiene to produce aqueous electrophoretic coatings. Maleic or phthalic half-esters of hydroxylated telechelic polybutadienes were also used for electrophoretic coatings.⁵² Anderson and Dowbenko⁵³ used a mercaptan-terminal polymer as a chain transfer agent in the synthesis of a block copolymer intended for coatings. A nonsolvent coating was made from a block copolymer having an end group functional polymer as a precursor.⁵⁴

49.5 Conclusions

The variety of coating compositions described shows the interest of the coating industry in liquid and especially in telechelic polymers. Problems related to rheology, cure rates, and curing chemistry remain. The factors governing rheology, compatibility with pigments and additives, cure type and extent, and the final coating properties lie in the composition and the polymerization conditions of telechelic polymer synthesis.

References

1. D. M. French, *Rubber Chem. Technol.*, **42**, 71 (1969).
2. R. D. Athey, *Prog. Org. Coat.*, **7**(3), 289 (1979).
3. R. D. Athey, *J. Coat. Technol.*, **54**(690), 47 (1982).
4. J. P. Berry and S. H. Morrell, *Polymer*, **15**, 521 (1971).
5. H. Onuma et al., *Bull. Inst. Chem. Res. Kyoto Univ.*, **44**, 123 (1966).
6. O. A. Olkhonikov et al., *Vysokomol. Soed. A*, **15**(11), 2512 (1973).
7. L. P. Semenova et al., *Vysokomol. Soed. A*, **17**(2), 318 (1975).
8. N. Okui et al., *Kobunshi Robunshu, Engl. Ed.*, **3**(8), 1671 (1974).
9. A. A. Berlin et al., *Vysokomol. Soed. B*, **17**(7), S43 (1975).
10. A. N. Dunlop and H. L. Williams, *J. Appl. Polym. Sci.*, **17**, 2945 (1973).
11. *Specialty Polymers*. A multiclient study. Livingston, NJ: Skeist Laboratories, Inc., 1975.
12. P. Thiron, *Polym. Age*, **264**, October (1974).
13. J. A. Yanko, *J. Polym. Sci.*, **3**, 576 (1984).
14. K. V. Hardman and A. J. Lang, *Rubber Age*, **39**(12), 431 (1961).
15. American Synthetic Rubber Corp., Flosbrene 25 (technical brochure).
16. P. A. Argabright and J. Kuntz, U.S. Patent 3,030,344.
17. G. Friedmann and J. Brossas, *ACS Polym. Div. Prepr.* **26**(1), 268 (April 1985).
18. D. M. French, *J. Macromol. Sci., Chem.*, **A11**(3), 643 (1972).
19. I. M. Erlikh and E. L. Rubinshtein, *Kauchuk Rezina*, **(4)**, 33 (1976).
20. V. B. Zabrodin et al. *Vysokomol. Soed. B*, **17**(8), 590 (1975).
21. J. W. Britain, *ACS Org. Coat. Plast. Chem. Div. Prepr.*, **22**(1), 290 (1962).
22. N. M. Van Glulick et al., *Rubber Chem. Technol.*, **49**(2), 320 (1976).
23. E. J. Mastrolia and K. Klager, *Propellants Manufacture, Hazards and Treating*, Advances in Chemistry Series No. 88, 122. Washington, DC: American Chemical Society, 1969.
24. K. Ono et al. *J. Appl. Polym. Sci.*, **21**, 3223 (1977).
25. D. Garcia, *ACS Polym. Div. Prepr.*, **26**(1), 268 (1985).
26. Thiokol Chemical Corp., British Patent 1,403,649.

27. Thiokol Chemical Corp., British Patent 2,325,561.
28. C. H. Sheppard and R. J. Jones, U.S. Patent 3,931,354.
29. R. A. Gray, *J. Coat. Technol.*, 57(728), 83 (September 1985).
30. K. Hamann et al., U.S. Patent 3,770,688.
31. W. L. Vaughn, U.S. Patent 3,803,087.
32. Union Chimique Belgique, British Patent 1,441,814.
33. Ford Motor Co., British Patent 1,424,968.
34. W. J. Morris, *J. Coat. Technol.*, 56(715), 49 (August 1984).
35. B. K. Christmas, *Mod. Paint Coat.*, 152 (October 1984).
36. A. R. Siebert et al. *ACS Org. Coat. Plast. Chem. Div. Prepr.* 34(91), 759 (1974).
37. F. B. Jones et al., U.S. Patent 3,803,089.
38. C. A. McPherson and J. K. Gillham, *ACS Org. Coat. Plast. Chem. Div. Prepr.*, 38(1), 229 (1978).
39. R. S. Drake et al., *Epoxy Resin Chemistry II*. ACS Symposium Series No. 221, 1. Washington, DC: American Chemical Society, 1983.
40. DeSoto Inc., U.S. Patent 3,933,760.
41. Mitsubishi Gas Chem. Ind., German Patent 2,533,846.
42. J. E. French, *ACS Org. Coat. Plast. Chem. Div. Prepr.*, 35(2), 72(1975).
43. W. H. McDonald, U.S. Patent 4,091,050.
44. Pechiney St. Gobain. German Patent 2,052,961.
45. A. Vranken and P. Dufour, German Patent 2,450,621.
46. K. Ko et al., German Patent 2,533,846.
47. J. M. Moisson-Frankhauser et al., British Patent 1,361,547.
48. Nippon Zeon Co. Ltd., Japanese Patent 49,052,851.
49. Bristol-Myers Co., Belgian Patent 49,052,851.
50. Electrochem. Ind. Co. Ltd. Japanese Patent 74,037,410.
51. J. M. Moisson-Frankhauser et al., German Patent 2,305,912.
52. Atlantic Richfield Co., British Patent 1,358,234.
53. C. C. Anderson and R. Dowbenko, U.S. Patent 4,016,332.
54. Union Chimique Belgique, German Patent 2,450,621.
55. Matsushita Electrical Works, U.S. Patent 3,957,903.
56. E. V. Khabarova et al., *Kauchuk Rezina*, (3), 45 (1976).
57. C. Pinazzi et al., *Makromol. Chem.*, 1Z5, 705 (1974).
58. D. C. Edwards, *ACS Polym. Div. Prepr.*, 15(2), 56 (1974).
59. G. L. Staton et al., *ACS Polym. Div. Prepr.*, 15(2), 52 (1974).
60. L. M. Sergeev et al., *Polym. Sci. USSR*, 12, 2339 (1970).
61. Z. N. Nudelman et al., *Int. Polym. Sci. Technol.*, 1(4), T/27 (1974).
62. A. E. Kalas et al., *Int. Polym. Sci. Technol.*, 2(2), T/60 (1975).
63. N. M. Kuzmina and L. S. Chuko, *Int. Polym. Sci. Technol.*, 1(10), A/12 (1974).
64. V. F. Antipova et al., *Kauchuk Rezina*, (1), 20 (1975).
65. Z. P. Chirukova et al., *Kauchuk Rezina*, (12), 5 (1975).
66. L. M. Tunkel et al., *Kauchuk Rezina*, (3), 8 (1974).
67. H. Okamoto et al., *Nippon Gomu Kyokaishi*, 49(6), 520 (1976).
68. B. N. Pronin et al., *Vysokomol. Soed. A*, 19(3)5, 455 (1977).
69. M. Roux-Michollet et al., *ACS Polym. Div. Prepr.*, 19(2), 369 (1978).
70. A. H. Frazer and E. J. Goldberg, U.S. Patent 2,888,440.
71. Phillips Petroleum Co., U.S. Patent 3,860,566.
72. Product Research Chemical Corp., Belgian Patent 821,959.
73. K. Marabushi, U.S. Patent 4,205,150.
74. R. W. Ireland and D. E. Skillicom, U.S. Patent 3,607,845.
75. P. A. E. Guinet and R. P. Puthet, U.S. Patent 3,409,573.
76. E. J. Goethals, Ed., *Telechelic Polymers: Synthesis and Applications*. Boca Raton, FL: CRC Press, 1988.

50

Polyesters

50.1	Introduction and Scope	50-1
50.2	Classification of Saturated Polyesters	50-2
50.3	Manufacturing Processes	50-3
	Reaction Components • Technical Manufacturing Processes	
50.4	Properties of Polyesters.....	50-4
	Morphology • Solubility • Molecular Weight Distribution • Functionality and Reactivity • Transition Temperatures • Compatibility of Polyesters • Chemical Properties	
50.5	Analytical Procedures.....	50-7
50.6	Preparation of Polyester Coatings.....	50-7
	Solvent-Borne Polyester Coating • High Solids Paints • Waterborne Paints • Solvent-Free Coatings	
50.7	Properties and Applications of Polyester Coatings.....	50-9
	Sheet and Coil Coatings • Can Coating • Automotive Paints • Industrial Paints • Two-Component Paints • Powder Coating • Radiation-Curable Coatings • Adhesives	
	References.....	50-12

H. F. Huber

Hüls Troisdorf AG

D. Stoye

Hüls Troisdorf AG

50.1 Introduction and Scope

Polyesters are polymers containing the recurring ester unit $\sim \text{COO} \sim$. They are formed by a condensation reaction between carboxyl- and hydroxyl-containing compounds. Historically, the first polyesters were condensation products of glycerol and phthalic anhydride. Those resins were used in the paint industry as early as 1910, but they were of low molecular weight and brittle. Later on, that is by 1925, they were modified by the inclusion of monofunctional fatty acids, which compensated the third functional group of the glycerol and elastified the resins. If unsaturated fatty acids were used, they rendered the resulting resins cross-linked by air oxidation. All these resins are now generally referred to as “alkyd resins”; they are treated in Chapter 51.

During the second half of this century, a large number of di- and trifunctional acids and glycols became commercially available, thus creating new possibilities for the synthesis of polyesters. It was the commercialization of terephthalic acid — or rather the dimethyl ester — that spurred the development of polyethylene terephthalate, which today plays an important role for the manufacture of fibers and films, and as an engineering plastic. In contrast to this polymer, however, which is made up of one pair of reactants only and is, therefore, frequently referred to as homopolyester, it is the combination of more than two reactants that yields copolyesters. For the manufacture of copolyesters, the chemist can today draw from a large selection of monomers. This makes copolyesters a class of polymers that can be varied over a very wide range:

- Low or high molecular weight
- Saturated or unsaturated

- Linear or branched
- Liquid or solid
- Amorphous or crystalline
- Soft/elastic or hard
- Tough or brittle

The glass transition temperature of copolyesters can be varied over a broad span. They can be modified in the main chain by other polymeric blocks (e.g., polyester units), and they can be prepared with varying terminal groups: hydroxyl, carboxyl, epoxy, acrylic functions, and others. Consequently, they can undergo further chemical reactions, especially cross-linking, to render a coating duroplastic.

The versatility of this class of polymers, combined with good stability toward light, heat, oxygen, and many chemicals, has contributed to an impressive and continuing gain in importance over the past 30 years.

Unsaturated polyesters also should be mentioned. They contain maleic, fumaric, or other unsaturated acids and, thus, have double bonds in the main chain. They are used as coatings — generally dissolved in monomeric styrene — in the furniture industry. Without styrene, they may be used in conjunction with other base polymers to enhance and broaden adhesion properties. This chapter deals with saturated copolyesters only.

50.2 Classification of Saturated Polyesters

Saturated polyesters for use as binders in paints and coatings may be classified according to their molecular weight and their functionality. High molecular weight polyesters are predominantly linear, thermoplastic polymers with molecular weights from 10,000 to 30,000. Generally, they are copolyesters containing terephthalic and/or isophthalic acid and aliphatic diacids and a blend of diols. In contrast to terephthalic acid homopolyesters, they exhibit better solubility in solvents.¹ In coatings, they impart a high degree of flexibility paired with excellent surface hardness and stability. High molecular weight linear polyesters may be used as physically drying binder components in paints, although the majority of uses are in baking enamels for highly flexible coatings, such as coil and can coatings in combination with amino resins or other suitable hydroxyl-reactive cross-linkers.² Certain special grades of high molecular weight polyesters are ground and used as thermoplastic powder coatings.

Low molecular weight polyesters range from 500 to 7000 g/mol and are, in general, not suitable as physically drying binders.³ Because of their low degree of polymerization, they carry a great many functional terminal groups.⁴ Low molecular weight polyesters may be linear or branched; by variation of the manufacturing process, it is possible to incorporate mostly either hydroxyl or carboxyl end groups, or both kinds.

By themselves, low molecular weight polyesters are not satisfactory film formers. They require a reaction partner capable of reacting with the end groups of the polyester and causing the formation of a cross-linked, duroplastic film.⁵ Amino resins⁶ and polyisocyanates⁷ are suitable as such cross-linking agents for hydroxyl polyesters, whereas epoxy resins and polyoxazolins may be used for carboxyl polyesters. By proper selection of the reactants, the formulator can design products ranging from two-component or one-pack solvent-borne enamels with amino resins or blocked polyisocyanates to powder coatings or, via the salt formation of carboxyl polyesters, water-soluble stoving paints.

By reacting the native terminal groups of polyesters (i.e., hydroxyls or carboxyls) with at least bifunctional monomers or oligomers, saturated polyesters may be further modified in many ways. Aminoplasts may be employed to prepare thermosetting precondensates with hydroxyl polyesters. Partially blocked polyisocyanates, when blended and reacted with excess amounts of hydroxyl polyesters, will yield thermosetting binders. Similarly, one can obtain silicone-, epoxy-, or acrylic-modified polyesters.⁸⁻¹¹ For the purpose of further modification, polyesters with molecular weights between 1000 and 5000 are best suited, given their higher content of functional hydroxyl or carboxyl groups and their better reactivity as compared to higher molecular weight counterparts. In that respect, it is frequently desirable not to

TABLE 50.1 Types of Polyester, Cross-linkers and Applications

Type of Polyester	Cross-linker	Field of Application
Linear high molecular weight polyesters	Melamine resins, benzoguanamine	Coil- and can-coating paints, primers, coatings for collapsible tubes
Linear low molecular weight hydroxyl polyesters	Melamine resins, benzoguanamine resin, polyisocyanates	Industrial stoving paints, two-component paints
Branched low molecular weight polyesters	Melamine resins, benzoguanamine resins, urea resins, polyisocyanates	Industrial stoving paints, two-component powder coatings
Carboxylated polyesters	Melamine resins, epoxy resins, triglycidylisocyanurate, polyoxazolin cross-linker	Waterborne coatings, powder coatings
Silicone-modified polyesters	Siloxane melamine resins	Coil-coating paints, heat-resistant paints
Isocyanate-modified polyesters	Isocyanates, blocked polyisocyanates	Coil-coating paints, industrial paints
Epoxy-modified polyesters	Polyanhydrides, carboxylated polyesters	Primers, industrial paints
Acrylated polyesters	Melamine resins, radiation cure	Industrial paints, adhesives, printing inks

convert all end groups, in order to leave residual cross-linkable functions for a coating or merely to improve the adhesion of the coating to certain substrates.

Table 50.1 lists the various ways to cross-link high or low molecular weights of various modifications. Still the most important groups of cross-linking agents are amino resins, especially melamine–formaldehyde condensation resins.^{12–15} Other cross-linkers are gaining in importance, however. With the rapid growth of the market for powder coatings, polyester–epoxy hybrids and blocked isocyanate curing agents are becoming increasingly popular.¹⁶ Polyester–isocyanate-based binder systems are increasingly used in solvent-borne paints, such as coil and can coatings, where a high degree of elasticity and resistance to weather or other attacks is required. Silicone-modified polyesters are known for excellent weather resistance and — with sufficiently high silicone content — good heat and chemical stability.¹⁷ Epoxy-modified polyesters are suitable for cross-linking with acidic resins or acid anhydrides and offer, thus, a formaldehyde-free and less toxic way to cross-link polyesters. Finally, acrylated polyesters serve as binders for radiation-cured coatings for varnishes, painting inks, and adhesives.

50.3 Manufacturing Processes

50.3.1 Reaction Components

Aromatic and aliphatic polycarboxylic acids and various polyols may be used for the penetration of linear or branched polyesters of varying molecular weight. The nature of the monomers and their relative amounts determine the properties of the resulting copolyester. The most important raw materials for the preparation of copolyesters are listed in Table 50.2.^{18–20} Whereas for the manufacture of linear polyesters, strictly bifunctional acids and alcohols must be used, for branched polyesters a certain amount of tri- or higher functional monomers is required. To warrant manufacture in commercial quantities on a consistently high quality level, a high degree of purity is required for the raw materials and, where applicable, a constant ratio of isomers. The polycondensation reaction is very sensitive to impurities, and even small amounts of foreign matter will affect discoloration, a change in molecular weight distribution, or even gelling.

50.3.2 Technical Manufacturing Processes

Saturated polyesters are made by esterification and transesterification. Both are reversible equilibrium reactions that yield the desired product by continuing removal of condensation water. Under the condi-

TABLE 50.2 Monomers for Producing Saturated Polyesters

<i>o</i> -Phthalic Anhydride	Ethylene Glycol
Isophthalic acid	Propanediol 1-, 2
Terephthalic acid	Diethylene glycol
Adipic acid	Butanediol 1-, 3
Sebacic acid	Butanediol 1-, 4
Trimellitic anhydride	Hexanediol 1-, 6
Pyromellitic anhydride	Neopentyl glycol (NPG)
Trimesic acid	Trimethyl pentanediol (TMPD)
Hexahydrophthalic anhydride	Cyclohexane dimethanol (CHDM)
Hexahydrophthalic acid	Tricyclodecane dimethanol
5- <i>t</i> -Butyl isophthalic acid	Hydropivalic acid-NPG-ester
Dodecanoic acid	Bisphenol A bishydroxyethyl ether
Dimerized fatty acids	Trimethylol propane (TMP)
	Pentaerythritol

tions of the esterification reaction, transesterification occurs at the same time. Consequently, when more than two diols or decarboxylic acids are being used, a statistical distribution of the monomers must be expected. The rate of reaching equilibrium is catalytically accelerated by acids, bases, or transition metal compounds. Commonly, small amounts of titanium, tin, or antimony compounds are used as catalysts.

Low molecular weight linear or branched polyesters are generally prepared by a one-step process. This involves blending all monomers and reacting them at temperatures from 125 to 240°C. The condensation products are removed either by the application of vacuum (vacuum-melt process) or by passing through a stream of inert gas such as nitrogen or carbon dioxide (driving gas-melt process) or by the addition and subsequent azeotropic distillation of a solvent (azeotrope process).

Higher molecular weight copolyesters are made in two steps. The first step involves the preparation of a polyester precondensate either by transesterification or by esterification of the acids with excess diols. The second step, referred to as the polycondensation, consists of further removal of diols from the molten precondensate in vacuum at temperatures above 250°C.

Other manufacturing processes for polyesters are known, but these are not normally used for commercial purposes.¹

50.4 Properties of Polyesters

50.4.1 Morphology

Depending on the choice of components used to build up the polyester, the morphology of the polymer may be varied continuously over a wide range from completely amorphous to highly crystalline. Monomers imparting regularity — for instance, by a sequence of methylene groups or by symmetrical substituents on a ring — will lead to crystallinity in the polymer. Accordingly, polybutylene terephthalate or a copolyester consisting of terephthalic and adipic acids and butanediol will exhibit a high degree of crystallinity. Less regular molecules, such as isophthalic or orthophthalic acid or neopentyl glycol will yield only weakly crystalline or, more likely, completely amorphous polymers.

As a rule, for use in coatings, amorphous polyesters will prevail; however, there may well be instances in which crystallinity can be used to advantage — for instance, in thermolastic powder coatings,²¹ where crystallinity helps to reduce the permeability of the coating.²²

50.4.2 Solubility

Naturally, chemical composition will be the dominant factor in determining the solubility of a polyester; however, this dominance may be exhibited either directly or indirectly (by affecting the morphology). The solubility of polyesters decreases rapidly with increasing crystallinity.²³ Highly crystalline copolyesters

are insoluble in many common solvents. They can be dissolved only in blends of phenol and *o*-dichlorobenzene at higher temperatures. Polyesters of medium crystallinity are soluble in methylene chloride; weakly crystalline polyesters will also dissolve in aromatic hydrocarbons, such as toluene. Amorphous polyesters will dissolve in a variety of polar solvents, such as esters, etheresters, ketones, and aromatic and chlorinated hydrocarbons.

Within the amorphous polyesters, chemical composition will have a direct effect on solubility. Thus, shifting the glycol ratio in a polyester from ethylene glycol toward neopentyl glycol will enhance the solubility of the resulting polyester. Detailed information on the solubility of a variety of polyesters may be found in vendors' literature.^{24,25}

Polyesters are essentially insoluble in water, unless special measures are taken to impart hydrophilic sites. This may be achieved in one or more of the following ways: Incorporation of polyethylene oxide segments or anionic groups, using either carboxyls (e.g., by means of trimellitic anhydride²⁶) or salts of sulfoisophthalic acid.²⁷ Detailed treatments on water-borne polyesters may be found elsewhere.^{28,29} True solubility of the polymers is attained only rarely. Rather, a gradual increase in water dispersibility is observed until, by way of forming polyelectrolyte salts, a colloidal solution is obtained. Frequently, auxiliary solvents such as butyl glycol ethers are also employed.

50.4.3 Molecular Weight Distribution

Polyesters are prepared by polycondensation, a fully reversible reaction. The desired degree of polymerization is obtained by shifting the reaction equilibrium in that excess glycol is removed. A concise treatment concerning low molecular weight linear polyesters is available in German.⁴ Essentially, assuming comparable reactivity of end groups, the molecular weight distribution is a purely statistical one. For higher molecular weight linear polyesters, it tends to drop off fairly rapidly toward higher molecular weights and to tail off toward lower ones. For a typical polyester, the following data were found: $M_w = 22,200$; $M_n = 8300$; and dispersity = 2.7.

By gel permeation chromatographic analysis, a content of 3% (by area) of low molecular weight (>1000) species was measured. One complication is the possible formation of cyclic oligomers — for instance, the one consisting of 2 moles of terephthalic acid and 2 moles of ethylene glycol or several others. Most of these oligomers are crystalline and tend to cause turbidity in resin solutions and, occasionally, in paint films. Much work has been devoted to the elimination of these oligomers, resulting in ways and means to avoid this interference factor.³⁰

Much more complicated is the situation when trifunctional monomers are used and branched polymers are obtained.²⁸ As Carothers³¹ and Flory³² have shown, the molecular weight distribution broadens rapidly with increasing degree of polymerization and soon a critical conversion point is reached, beyond which gelation of the polymerization batch occurs. This can be avoided by a two-step process that introduces additional functional groups in a controlled manner. A typical example for this technology is the preparation of a branched hydroxyl polyester in a first step, followed by reaction with trimellitic anhydride as a second step.^{26,28,30}

50.4.4 Functionality and Reactivity

In contrast to other polymerization processes (e.g., radical polymerization), polycondensation does not tend to cause imperfections due to branching or chain termination. Therefore, a polyester consisting of bifunctional components only will be just about perfectly linear. Only the incorporation of trifunctional monomers such as trimethylol propane or trimellitic acid causes a controlled increase in functionality above 2. As the polycondensation is generally carried out with an excess of glycol, the acid number declines more rapidly with increasing degree of polymerization than the hydroxyl number; thus, except for low molecular weight polyesters, the reactivity of the polyester is primarily linked to its terminal hydroxyl groups. Because secondary hydroxyls are less reactive than primary ones, a terminal primary hydroxyl group generally remains. This, in turn, reduces the reactivity of a polyester primarily to a

function of its molecular weight, in accordance with the decreasing concentration of end groups with increasing size of the polymer molecule.

50.4.5 Transition Temperatures

These transition temperatures are of interest in conjunction with polyesters. In order of importance for coatings, there are the following:

- Glass transition temperature, T_g
- Softening point, T_f
- Crystalline melting point, T_m

The theory of the relationship between thermodynamic equilibrium melting points and copolymer compositions was developed by P. J. Flory.³³ On the basis of the free volume theory, Flory and Fox³⁴ proposed a general theory on glass transition theory, which led to the formula suggested by Fox,³⁵ which permits the calculation of the glass transition temperature from the contributions of the individual monomers. Polyesters obey the formula quite well. Thus, from knowledge of the glass transition temperatures of the homopolyesters, copolyesters may be calculated with good accuracy. For the purpose of this chapter, however, a few basic guidelines may be helpful.

Purely aliphatic polyesters will — with increasing ratio of methylene to ester groups — asymptotically approach the glass transition temperature of polyethylene (N 160 K). Accordingly, a polyester of azelaic acid and hexamethylene diol has a glass transition temperature of about 190 K, whereas one made of terephthalic acid and bisphenol A has a glass transition temperature of 480 K. More detailed data on glass transition temperatures of homopolyesters may be found in the literature.^{36,37}

For amorphous polyesters, the softening point — usually determined by the ring and ball method — is generally approximately 50 to 90°C above the glass transition temperature. As one would expect, this difference increases with increasing molecular weight.

Crystalline melting points depend largely on the chemical nature of the crystalline species. Thus, a highly aliphatic, crystalline polyester will melt at approximately 340 K, whereas more aromatic crystalline species will melt at considerably higher temperatures (e.g., polyethylene terephthalate, 540 K). More information on melting points of polyesters is available.³⁸

50.4.6 Compatibility of Polyesters

The compatibility of polyesters with other resins and polymers depends on many parameters, which also are partly interrelated, including molecular weight, glass transition temperature, morphology, and chemical composition of the polyester. Among the most prominent examples for the use of polyesters in combination with other polymers are blends of low molecular weight polyesters with cellulose acetobutyrate in base coats of two-coat metallic automotive finishes. High molecular weight polyesters are used as coresins for nitrocellulose lacquers and for vinyl copolymers.^{24,25}

50.4.7 Chemical Properties

Generally speaking, polyesters have excellent stability toward light, oxygen, water, and many chemicals. The weakest spot in the polymer chain is the ester group, with its potential sensitivity to hydrolysis. Accordingly, degradation may occur, provided there is an environment that combines moisture with acids or alkali or other catalytically active materials, plus the possibility for the moisture to permeate into the polyester. The latter is largely suppressed in the case of crystalline polyesters or for cross-linked polyester paint films. Degradation of polyethylene terephthalate was investigated by Buxbaum.³⁹ Because this author was using low molecular weight model compounds, this study may, to some extent, be applicable to other polyesters as well.

50.5 Analytical Procedures

In the characterization and quality control of saturated polyesters, the end groups are analyzed according to procedures of the International Standards Organization (ISO) and the American Society for Testing and Materials (ASTM): for hydroxyl number, ISO 4629; for acid number, ISO 3682 or ASTM D 2455. For each type of polyester, there will be narrow limits in those two parameters. Further test methods for polyester solutions are the nonvolatile matter content (ISO 3251, ASTM D1259), color number (Gardener Scale, ISO 4630, ASTM D 1544), flow time (Ford cup, ISO 2431, ASTM D 1200), viscosity (ISO 3219, ASTM D 1725), and flash point (ISO 1523, ASTM D 1310). For solid polyesters, the ring and ball method is used to determine the softening point.

Molecular weight is frequently determined indirectly as inherent or reduced viscosity. The respective formulas are as follows:

$$\eta_{\text{inh}} = \frac{t/t_o}{c} \quad \eta_{\text{red}} = \frac{t/t_o - 1}{c}$$

where t = elution time of solution, t_o = elution time of solvent, and c = concentration.

Frequently, the control of the foregoing analytical data is not sufficient to ensure consistent quality for the intended use. In such cases, application technical tests must be carried out to learn more about polyester reactivity, the mechanical properties of the coating, gloss, compatibility, and adhesion, and resistance to water, chemicals, weather, etc.

50.6 Preparation of Polyester Coatings²⁰

For the preparation of paints based on saturated hydroxyl polyesters, amino resins are the most commonly chosen cross-linkers. Melakine–formaldehyde condensates are preferred over urea–formaldehyde resins in view of the superior properties of the former in weathering stability as well as the balance of surface hardness and elasticity. For further improvement of adhesion, gloss, and water resistance, benzoguanamine resins are used. Selection among the many commercially available melamine resins is primarily determined by the compatibility of the melamine resin with the type of polyester it is to be combined with. Monomolecular, etherified condensation products such as hexamethoxymethyl melamine or only partially etherified products exhibit a very broad range of compatibility. Higher molecular weight resins containing several melamine units in the molecule are less compatible and can be used with selected polyesters only.

To meet the commonly established stoving conditions of 120 to 270°C with acceptably brief reaction times, the cross-linking reaction between hydroxyl polyesters and amino acid resins — especially the etherified variety — requires the use of acidic catalysts. A common choice is *p*-toluolsulfonic acid or its salts with volatile amines, such as morpholine, or nonionically blocked acidic compounds. Hetero- or homopolar-blocked acids are latent catalysts, which become effective only during the baking cycle.^{40,41} Thus, a premature reaction between polyester and melamine resin at room temperature in the liquid paint is effectively suppressed and the shelf life of the paint appreciably extended.

The properties of polyester coatings are essentially influenced by the molecular weight and the composition of the polyester as well as by the nature and the amount of the melamine resin. With increasing amounts of amino resin, baked coatings will become harder and less elastic, whereas resistance to solvents and chemicals increases. In general, good results are obtained with 10 to 35 wt% of total binder content. In coil and highly elastic can coating paints, the amino resin content may be reduced to as little as 5%.

Of less commercial importance than melamine resin cross-linked polyesters are those with other cross-linking agents such as isocyanate or epoxy cross-linked or siloxane- or radiation-cured systems. Naturally, to avoid side reactions and insufficient shelf life when designing a paint formulation, solvents, catalysts, pigments, additives, and fillers must be chosen with due regard for the chemistry involved.

50.6.1 Solvent-Borne Polyester Coating²⁰

For the preparation of solvent-borne polyester paints, all the binder components are first dissolved; then the pigments, fillers, and additives are added, thoroughly dispersed, and milled. For reasons of economy and to alleviate the milling procedure, it is advantageous to conduct the milling step in a fraction of the total binder. To avoid difficulties in pigment wetting when using binders of different polarity, the fraction used for milling should contain all the binder components in the proper proportion. Upon completion of the milling step, the retained binder portion is added together with leveling or flow agents or other additives and the required amounts of solvents. Paints based on saturated copolymers can be applied with all common techniques. Those most widely practiced are roller coating for can and coil coating, followed by various spray applications (air assisted, airless, or electrostatic spray) with, for instance, rotating discs or belts.

50.6.2 High Solids Paints

High solids paints formulated with saturated copolyesters have total solid contents between 65 and 80 wt%. They require low viscosity — that is, low molecular weight polyesters and monomolecular melamine — formaldehyde resins.^{42–49} Due to the low molecular weight of the polyesters, the elasticity of paint films thus obtained is inferior to that of conventional solvent-borne polyester paints. Therefore, high solids polyesters paints are primarily used as spray-applied or dip paints. When formulating such paints, one should take into account the high polarity of the binder and use wetting agents for better pigment wetting, as well as effective flow agents and preferably nonionically blocked catalysts for improved electrostatic spray applicability.

Polyester–urethane two-component paints allow the manufacture of products with higher solid content and lower emission as compared to polyester–melamine combinations.

50.6.3 Waterborne Paints

Waterborne polyester–melamine paints are made from saturated polyesters containing an increased amount of carboxyl groups,^{5,28,50–52} having acid numbers between 45 and 55 mg KOH/g and molecular weights of approximately 2000 g/mol. The polyesters are usually combined with water-soluble melamine–formaldehyde resins such as hexamethoxymethyl melamine in a ratio of 70:30 to 85:15. The use of a catalyst is not necessary, as the carboxyl groups accelerate the reaction to a sufficient degree. Before blending these polyesters with the melamine resin, the carboxyls of the polyester must be neutralized with amine, usually dimethylethanolamine. Auxiliary solvents such as butyl glycol ether may be used to reduce viscosity, improve pigment wetting, enhance shelf life, and improve the thinning characteristics of the paint. Depending on the nature of the binder, the application viscosity and the stoving cycle, 5 to 15wt% solvent based on total paint formula is used.

Lately, it has been possible to develop polyesters with acid numbers of only about 20 mg KOH/g and molecular weights of 4000 g/mol, which upon neutralization are thinnable with water. The higher molecular weight allows a further reduction in emission when curing with melamine resins. Paints thus formulated may be applied by roller; they display a high degree of flexibility and impact resistance in the cured film.

50.6.4 Solvent-Free Coatings

Saturated polyesters play an important role for the formulation of thermosetting powder coatings. They can be combined as carboxyl polyesters with epoxy resins or triglycidyl isocyanurate (TGIC),^{7,16} or as hydroxyl polyesters with blocked solid isocyanates, predominately isophorone diisocyanate (IPDI). Thermoplastic powders are used mainly to cover welding seams in cans. The preparation of powder coatings involves blending of the binder resins with pigments, additives, and catalysts, homogenizing in a kneader–extruder, then grinding and screening. Electrostatic spray is the prevailing application method.

For adhesive coatings, special, low viscosity polyesters were developed.⁵³ The low viscosity in spite of comparatively high molecular weight is attributed to the special structure of these polyesters, consisting of an essentially linear main chain with a large number of alkyl side chains attached to it. By reacting the terminal groups further, the polyesters may be functionalized to carry terminal acrylic bonds, which render them reactive to high energy radiation such as ultraviolet light or accelerated electrons. Products thus formulated are solvent-free. They must be applied warm by roller or slot die coating and be radiation cured.

50.7 Properties and Applications of Polyester Coatings

Polyester coatings, especially cross-linked ones, exhibit excellent flexibility or even elasticity, and they show very good impact, scratch, and stain resistance. Their good adhesion properties, especially to metals, combined with good corrosion protection and weather resistance, have made them indispensable in a number of fields.

50.7.1 Sheet and Coil Coatings

Precoated sheet and coil have enjoyed remarkable growth over the past two decades, and polyesters have played an ever-increasing role in this industry. Polyesters are being used for primers and top coats with equal success.

Polyester-based coil coating primers have been discussed concisely by Schmitthenner⁵⁴ and by Robertson.⁵⁵ The tough requirements that coated coil stock is expected to meet — for instance, for use as façade sheeting — necessitate the use of primers, which have three main functions:

- Promotion of adhesion to pretreated metal
- Corrosion protection
- Elastification of the two-coat system consisting of primer and top coat

The two-coat system permits the optimization of adhesion of the primer to the pretreated metal and, at the same time, intercoat adhesion. High molecular weight polyesters with relatively high glass transition temperatures and in films approximately 5 μm thick have yielded excellent results on all counts. Corrosion-protective action is enhanced by the use of anticorrosive pigments. For the formulation of top coats, the end use will influence the choice of polymers. Paints with outstanding weather resistance can be formulated from medium molecular weight polyesters.⁵⁶ The ultraviolet (UV) absorption of polyesters used for this purpose ends at wavelengths below those at which the UV irradiation of sunlight begins. Schmitthenner has given another example of high molecular weight, highly elastified polyesters, that can be used to formulate correspondingly elastic enamels for end uses such as home appliances.

50.7.2 Can Coating

The term “can coating” embraces paints for use on a vast variety of decorated metals for packaging purposes. This includes cans of all kinds, including food cans and aerosol cans, collapsible tubes, and caps and closures of many kinds. Generally, the paint is applied to flat sheet stock, followed by printing, stacking up for storage, then stamping and forming. Especially difficult are the requirements for drawing and redrawing cans and closures, where the degree of forming is too high to be achieved in a single draw. The most common substrates are tin-plated steel, aluminum, and to a smaller extent, directly chromated steel (tin-free steel, TFS).

Accordingly, the requirements for can coatings are extreme in many ways. They include printability and block and scratch resistance, yet sufficient elasticity to permit forming and drawing without damage to the paint. On the finished article, the paint must be stable with respect to its contents, it must be stain resistant, sometimes heat sealable, and for food preservation, able to withstand sterilization, nontoxic, and neutral in taste and odor. The composition of can coatings for use in conjunction with foodstuffs

is regulated in many countries individually, however, the U.S. Food and Drug Administration (FDA) is recognized internationally. The FDA provides a list of components⁵⁷ that may be used to prepare polyesters intended for use as coatings in direct contact with food.

In conclusion, polyesters offer an excellent combination of physical properties especially concerning the balance of elasticity and surface hardness, paired with excellent adhesion, resistance to yellowing, and stability against the majority of materials now packaged in cans and tubes.

50.7.3 Automotive Paints

In the area of automotive paints, polyesters compete with a variety of other polymers. Acrylics, epoxy esters, and even alkyds have their share of the market. As automotive paints are spray applied and low molecular weight and frequently branched polyesters tend to be used predominantly, two areas have developed as special grounds for polyesters. These are base coats for two-layered metallics and chip-resistant fillers.

For the former, low molecular weight, branched polyesters are used in conjunction with cellulose acetobutyrate and polymeric melamine resins. This combination permits optimum alignment of the metallic flake pigments immediately after application. The use of polyesters for chip-resistant fillers makes use of the excellent elasticity. Special polyester fillers made of upgraded polyurethane resin are used on areas of the car body where stone chipping occurs most frequently (e.g., rocker panels).

50.7.4 Industrial Paints

Polyesters paints are gaining importance for the formulation of industrial baking enamels as a result of their weathering resistance, good abrasion and chemical stability, well-balanced elasticity, and surface hardness. This applies especially to high solids products and for waterborne sprayable and dip paints. Texturized paints are used for metal covers and housings for appliances, machinery, and data-processing equipment primarily because of their good abrasion resistance and favorable hardness-elasticity properties. Automotive uses include metal parts in the engine compartment and fixtures for rearview mirrors and windshield wipers. Polyester paints are attractive here because of their corrosion protection and resistance to oil, fuel, and cleaning agents. Office furniture, such as steel desks and filing cabinets require high impact resistance, which is well met by polyester paints. Similarly, household appliances — if not made from precoated sheet — are also frequently coated with polyester-based paints.

50.7.5 Two-Component Paints

Saturated polyesters play an important role as hydroxyl-functional binder components in the formulation of two-component polyurethane paints. Compared to other hydroxyl-functional materials, polyesters permit complete adjustment of the elasticity of the coating of substrate, and coating is required to avoid crack formation upon temperature fluctuations. In addition, polyesters are used in isocyanate-cured, two-component automotive repair paints because of their weathering and chip resistance.

50.7.6 Powder Coating

Polyesters are finding use in thermosetting and thermoplastic powders. The latter are a specialty application only. The overwhelming majority are thermosetting powders. They may be either hydroxyl polyesters cured with blocked isocyanates or carboxyl polyesters cured with di- or triepoxides.

The most important advantage of *thermoplastic powders* is the speed of film formation, which is accomplished merely by melting and does not require reaction time for a chemical cure. For this purpose, high molecular weight, partially crystalline, polyesters are best suited.²¹ The use is predominantly for coating the welding seams of three-piece cans.²²

Polyesters for use in *thermosetting powders* are generally amorphous, with molecular weights between 2000 and 6000, glass transition temperatures above 55°C, and softening points between 100 and 120°C.

They must have good pigment compatibility. In general, they have a functionality higher than 2, which means branching in either the main chain or terminal components of higher functionality, as achieved by capping with trimellitic anhydride.^{58,59}

Hydroxyl polyesters are generally cured with blocked isocyanates, such as isophorone diisocyanate blocked with *e*-caprolactam^{7,60} or uretdiones.⁶¹

Carboxyl polyesters may either be cured with epoxy resins (polyethylene sulfide–epoxy hybrids) or with TGIC. Polyester–epoxy hybrids enjoy the largest volume. They are very versatile and are, thus, finding use in many and diverse applications. Their advantage over hydroxyl polyesters–blocked isocyanate materials is the absence of blocking agents, which have to be driven off during the curing cycle. In turn, they require catalysts, such as quarternary ammonium compounds,⁶² to achieve satisfactory short curing times at acceptable cure temperatures. Due to the relatively high content of epoxy resins (60 to 100 parts per 100 parts polyester) they have a tendency to chalking and, hence, are limited with respect to weather resistance. The latter can be essentially improved by using TGIC at a level of approximately 10 parts per 100 parts polyester.⁶³ Weather resistance of TGIC-cured carboxyl polyesters is excellent; however, powder coatings formulated on this basis have a tendency to display orange peel upon longer storage of the powder.⁶⁴

50.7.7 Radiation-Curable Coatings

Saturated polyesters, of course, are not reactive to UV light or accelerated electrons such as used generally for radiation cure. There are basically two ways to render them reactive:

- Incorporation into the polymer backbone of unsaturated acids, such as maleic or fumaric acid
- Capping with reactive, preferably acrylic or methacrylic, vinyl double bonds

The former method includes the unsaturated polyesters, such as those used as fiberglass-reinforced polymers in vehicle construction with or without the use of monomeric styrene as a reactive diluent. In the field of coatings, this material combination has found only very limited acceptance for a variety of reasons. The only type of use worth mentioning is for furniture finishes.

Vinyl-terminated polyesters, or more specifically acrylated polyesters, may be prepared by direct esterification of hydroxyl polyesters with acrylic acid or by reaction of carboxyl polyesters with glycidyl methacrylate.⁶⁵

The most widely practiced method of attaching acrylic double bonds to polyesters is via the reaction of hydroxyl polyesters, diisocyanates, and hydroxyalkyl acrylates leading to acrylated polyester urethanes. Such materials are finding growing acceptance either by themselves or in combination with reactive diluents for a variety of uses. The reactive diluents are predominantly di- and triacrylates. The uses are diversified; overprint varnishes in the graphics and packaging sectors are presumably the largest group.

50.7.8 Adhesives

Adhesives should be mentioned for the sake of completeness, especially the kinds that are predominantly used in the form of continuous coatings. These include the following:

- Heat-seal lacquers and hot melt coatings
- Laminating adhesives
- Pressure-sensitive adhesives

For heat-seal lacquers and hot melt coatings, saturated, high molecular weight polyesters can be very useful. They offer good blocking resistance and swift bonding combined with attractive physiological properties (e.g., FDA conformity).⁶⁶

For laminating adhesives, high molecular weight polyesters may be used in conjunction with isocyanates to effect high bond strength, good temperature stability, and even sterilization resistance.⁶⁷

Pressure-sensitive adhesives, a totally new field for polyesters, may well gain considerable importance in the near future.^{68,69}

References

1. J. Rütter, K. König, and K. H. Seemann, *Ullmanns Encyclopädie*, Technische Chemie Vol. 19. Weinheim: Verlag Chemie, 1980, pp. 61–88.
2. D. Stoye, *Materialprüfung*, 15, 410 (1973).
3. E. –C. Schütze, *Oberfläche-Surface*, 11, 203 (1970).
4. J. Dörffel, J. Rüter, W. Holtrup, and R. Feinauer, *Farbe und Lack*, 82, 796 (1976).
5. J. Dörffel and U. Biethan, *Farbe und Lack*, 82, 1017 (1976).
6. W. L. Hensley, *Paint Varn. Prod.*, 68 (1966).
7. R. Gras and H. Riemer, U.S. Patent 4,528,355 (1985); Hüls.
8. R. Capanni et al., *Farbe und Lack*, 78, 831 (1972).
9. V. Mirgel and K. Nachtkamp, *Farbe und Lack*, 89, 928 (1983).
10. K. Schmitt, J. Disteldorf, and F. Schmitt, U.S. Patent 4,151,152 (1975); Hüls.
11. D. Berger, U.S. Patents 4,097,465 and 4,097,466 (1975); Hüls.
12. K. H. Homung and U. Biethan, *Farbe und Lack*, 76, 461 (1970).
13. U. Biethan, K. H. Homung, and G. Peitscher, *Chem. Ztg.*, 96, 208 (1972).
14. U. Biethan and K. H. Homung, in *Tenth FATIPEC Congress Book*, 1970, p. 277.
15. U. Biethan, J. Dörffel, and D. Stoye, *Farbe und Lack*, 77, 988 (1971).
16. A. Schott, R. Gras, and E. Wolf, U.S. Patent 4,258,186 (1977); Hüls.
17. F. O. Stark, in *Organic Coatings, Science and Technology*, Vol. 6. New York: Dekker, 1984, pp. 87–100.
18. D. L. Edwards et al., *Paint Varn. Prod.*, 44 (1966).
19. M. F. Koistra, *J. Oil Color. Chem. Assoc.*, 62, 432 (1979).
20. U. Biethan et al., *Ullmanns Encyclopädie Technische Chemie*, Vol. 15. Weinheim: Verlag Chemie, 1978, pp. 625–628.
21. K. Brüning and K. G. Sturn, U.S. Patent 4,054,681 (1977); Dynamit Nobel.
22. H. J. Hölscher, *neue Verpack.*, 1, 46 (1984).
23. *Dynapol Copolyesters for Coatings and Adhesives* (product information leaflet), Hüls AG, Marl, West Germany.
24. *Dynapol Coatings* (product information ringbook), Hüls AG, Marl, West Germany.
25. *Vesturit — Saturated Polyester Resins for Stoving Enamels* (brochure), Hüls AG, Marl, West Germany.
26. Technical Service Report GTSR 22 and GTSR 36, Amoco Chemicals Co., Naperville, IL.
27. G. Schade, U.S. Patent 4,104,262 (1978); Dyamit Nobel.
28. J. Dörffel, *Farbe und Lack*, 81, 10 (1975).
29. J. Dörffel and W. Auf der Heide, *Farbe und Lack*, 86, 109 (1980).
30. D. W. Sartorelli and R. R. Smith, EP Patent 0105016 (1983); Goodyear.
31. W. H. Carothers, *Trans. Faraday Soc.*, 32, 39 (1936).
32. P. J. Flory, *J. Am. Chem. Soc.*, 63, 3083 (1941).
33. P. J. Flory, *Principles of Polymer Chemistry*. Ithaca, NY: Cornell University Press, 1953, pp. 568–576.
34. T. G. Fox and P. J. Flory, *J. Appl. Phys.*, 21, 581 (1950).
35. T. G. Fox, *Bull. Am. Phys. Soc.*, 1, 123 (1956).
36. D. W. van Krevelen, *Properties of Polymers*. New York: Elsevier, 1972.
37. W. A. Lee and R. A. Rutherford, *Polymer Handbook*, Vol. III. New York: Wiley, 1975, p. 139.
38. R. Hill, *Fibres from Synthetic Polymers*. London: Elsevier, 1953.
39. L. Buxbaum, *Angew. Chem.*, 80, 225 (1968).
40. W. Andrejewski and D. Stoye, British Patent. 1 481 182 (1973); Hüls.
41. W. J. Mijs, W. J. Muizebelt, and J. B. Reesink, *J. Coat. Technol.*, 55, 45 (1983).
42. D. Stoye, W. Andrejewski, and J. Dörffel, *Thirteenth FATIPEC Congressbook*, 1976, p. 605.
43. D. Stoye and J. Dörffel, *Adv. Org. Coat. Sci. Technol.*, 2, 183 (1980).
44. D. Stoye and J. Dörffel, *Pigment Resin Technol.*, 9(7), 4; 9(8), 8 (1980).
45. L. Gott, *J. Coat. Technol.*, 48, 52 (1976).
46. R. Buter, *Farbe und Lack*, 86, 307 (1980).

47. D. Stoye and J. Dörffel, in *Organic Coatings, Science and Technology*, Vol. 6. New York: Dekker, 1984, pp. 257–275.
48. L. W. Hill and K. Kozlowski, *J. Coat. Technol.*, 59, 63 (1987).
49. F. N. Jones and D. D. -L. Lu, *J. Coat. Technol.*, 59, 73 (1987).
50. K. H. Albers, A. W. McCollum, and A. E. Blood, *J. Paint Technol.*, 47, 71 (1975).
51. M. R. Olson, J. M. Larson, and F. N. Jones, *J. Coat. Technol.*, 55, 45 (1983).
52. K. L. Payne, F. N. Jones, and L. W. Brandenburger, *J. Coat. Technol.*, 57, 35 (1985).
53. H. Müller et al., U.S. Patent 4,668,763 (1987); Dynamit Nobel.
54. M. Schmitthenner, paper presented at the ECCA Annual Congress, Brussels, 1983.
55. R. R. Robertson, paper presented at the 1982 Fall Technical Meeting, NCCA.
56. M. Schmitthenner, paper presented at the Fourteenth International Conference on Organic Coatings Science and Technology, Athens, 1988.
57. *Federal Register*, Vol. 21, Section 175.300 [Food and Drug Administration].
58. S. Harris, *Polym. Paint Color J.*, 174 (4114), 162–164 (1984).
59. E. Bodnar and P. Taylor, *Pigment Resin Technol.*, 15(2), 10–15 (1986).
60. R. Gras, F. Schmitt, and W. Wolf, U.S. Patent 4,246,380 (1981); Hüls.
61. R. Gras et al., U.S. Patent 4,413,079 and 4,483,798 (1984); Hüls.
62. P. L. Heater Jr., EP Patent 0 056 356 (1985); Goodyear.
63. Ciba-Geigy Bulletin, Araldit PT 810. Ciba-Geigy, Basel, Switzerland.
64. W. Marquardt and H. Germeller, *Farbe und Lack*, 86, 696–698 (1980).
65. J. W. Saracsan, EP Patent 0,089,913 (1983); Goodyear.
66. *Dynapol Coatings Bulletin L-650* (product information), Hüls AG, Marl, West Germany.
67. *Polyester Resins, Adhesives and Coatings* (brochure), Dayton Chemical Division of Whittaker Corp., West Alexandria, OH.
68. H. F. Huber and H. Müller, *Conf. Proc. Radcure*, 86, 12–23 (1986).
69. H. F. Huber and H. Müller, *Conf. Proc. Radcure*, 87, 8–35 (1987).

51

Alkyd Resins

51.1	Classification.....	51-1
	Oil Length and Type of Oil • Percentage of Phthalic Anhydride • Acid Value and Hydroxyl Number	
51.2	Principle of Alkyd Synthesis.....	51-2
51.3	Functionality and Prediction for Gel Point	51-4
	Actual Functionality • Gel Point • Alkyd Calculations	
51.4	Raw Materials	51-6
	Polybasic Acids • Polyols • Fatty Acids and Oils	
51.5	Manufacturing Process	51-7
	Fusion Method versus Solvent Method • Monoglyceride versus Fatty Acid Process	
51.6	Alkyds for Reduced Solvent Emission	51-9
	High Solids Coatings • Emulsion-Based Coatings • Powder Coatings	
51.7	Modified Alkyds	51-10
	Polyamide Modification • Vinyl Modification • Other Modifications	
51.8	Uses	51-11
	References.....	51-11

Krister Holmberg

Chalmers University of Technology

Alkyd resins represent a class of polymers that are used in surface coating formulations because of their low cost and versatility. The term “alkyd” was coined by Kienle and Ferguson¹ and is derived from “al” of alcohol and “cid” of acid; “cid” was later changed to “kyd.”

Alkyd resins in a broad sense refer to polymers. By convention, however, polyesters with unsaturation in the backbone are not referred to as alkyds but are termed “unsaturated polyesters.”

The specific definition of alkyds that has gained wide acceptance is that alkyds are polyesters modified with fatty acids. The nonmodified resins are then called saturated polyesters. Terms like “oil-free alkyd” and “oil-modified polyester” can also be found in the literature.

51.1 Classification

Alkyds are synthesized from three basic components: polybasic acids, polyols, and (except for oil-free alkyds) fatty acids. The nature and proportions of these components control the properties of the resin. The amount of combinations is enormous, and specification of an alkyd resin must involve several parameters. The most important ways of classifying are given below.

51.1.1 Oil Length and Type of Oil

Depending on the weight percentage of fatty acid in the resin, alkyds are referred to as short oil (<45%), medium oil (45 to 55%), or long oil (>55%). However, some confusion exists regarding the terminology.

Sometimes oil length refers to percentage of triglyceride, in which case fatty acid content has to be recalculated into triglyceride. The second approach can be converted into the first by division by 1.045.

The type of fatty acid used also governs the properties of the alkyds. The resins are classified as drying, semidrying, and nondrying, depending on the degree of unsaturation in the fatty acid residues (iodine number of >140, 125 to 140, and <125, respectively).

Oxidative drying of alkyds, which involves air oxidation of polyene structures in fatty acid residues, is at maximum around 50% oil length. After drying, film hardness is inversely proportional to the degree of fatty acid modification.

Short oil alkyds generally give films of high quality with regard to color and gloss retention but with low flexibility and with poor adhesion. Long oil alkyds are usually superior in terms of pigment dispersion, rheological properties, and storage stability.

Examples of properties of alkyd resins related to oil length and type of oil are shown in [Table 51.1](#).²

51.1.2 Percentage of Phthalic Anhydride

Phthalic anhydride is the most commonly used raw material in alkyd compositions, and the weight percentages are usually stated. There is an inverse relationship between percentage of phthalic anhydride and degree of fatty acid modification, short oil alkyds having above 35%, medium oil alkyds between 20 and 35%, and long oil alkyds below 20% phthalic anhydride.

51.1.3 Acid Value and Hydroxyl Number

The acid value is defined as milligrams of potassium hydroxide required to neutralize 1 g of resin. For alkyd resins, 0.1 M KOH in ethanol is normally employed.

The hydroxyl number (sometimes called hydroxyl value) is the milligram of potassium hydroxide equivalent to the amount of acyl groups reacted in the acylation of 1 g of resin. A known amount of acylating reagent (often acetic anhydride or phthalic anhydride in pyridine) is added to the resin sample, and the hydroxyl number is obtained by backtitration with alkali.

Usually, the hydroxyl number is considerably higher than the acid value. Baking alkyds require a certain concentration of hydroxyl groups to react with the amino acids, and for air drying alkyds, the concentration of hydroxyl groups determines pigment wetting properties. The concentration of carboxyl groups is of particular interest in alkyds for water-borne coatings. To achieve water solubility without excessive use of cosolvents, these resins are processed to a high acid value, and the carboxyl groups are subsequently neutralized with ammonia or an amine (see [Section 51.6.2](#)).

51.2 Principle of Alkyd Synthesis

Polyesters may be prepared either by direct condensation of at least difunctional acids and at least difunctional alcohols, or by employing reactive derivatives of the acid or the alcohol component. The first type of reaction is reversible, and to shift the equilibrium toward the product side, the water formed must be removed from the reaction zone. In practice, such removal may be carried out in various ways, such as azeotropic distillation using an organic solvent, sweeping the vapor away by means of a stream of inert gas, or applying a vacuum.

Reactions with reactive derivatives may be regarded as irreversible. Anhydrides and epoxides are the most common types of reactive derivatives of acids and alcohols, respectively.

Polyesterification is one of the prime examples of step-growth polymerization. This is a type of reaction in which each polymer chain grows at a relatively slow rate over a much longer period of time than in an addition polymerization reaction, and in which the initiation, propagation, and termination reactions are approximately identical in both mechanism and rate.³

The equilibrium constants of polyesterification are normally equal to that of the analogous model reaction between monofunctional compounds. This has been explained by the proposition that the

TABLE 51.1 Effect of Oil Length and Type of Oil on the Properties and Uses of Alkyds

Oil Type	Oil Length (%)	Typical Oil	Properties
Oxidizing	≥60	Linseed, safflower, soybean, tall oil fatty acids; wood oil in blends with other oils; dehydrated castor oil	Soluble in aliphatic solvents; compatible with oils and medium oil length alkyds; good drying characteristics; films are flexible, with reasonable gloss and durability
Oxidizing	45–55	Linseed, safflower, soybean, tall oil fatty acids; wood oil in blends with other oils	Soluble in aliphatic or aliphatic–aromatic solvent mixtures; good drying characteristics, durability, and gloss
Oxidizing	≤45	Linseed, safflower, soybean, tall fatty acids; wood oil in blends with other oils; dehydrated castor oil	Soluble in aromatic hydrocarbons; low tolerance for aliphatic solvents; usually cured at elevated temperatures either by heating with manganese driers or with urea or melamine formaldehyde resins
Nonoxidizing	40–60	Coconut oil, castor oil, hydrogenated castor oil	Soluble in aliphatic–aromatic solvent blends; usually used as a plasticizer for thermoplastic polymers such as nitrocellulose
Nonoxidizing	≤40	Coconut oil, castor oil, hydrogenated castor oil	Soluble in aromatic solvents; used as a reactive plasticizer that chemically combines with other resin entities (e.g. melamine–formaldehyde resin)

Source: From Solomon, D. H., *The Chemistry of Organic Film Formers*. New York: Krieger, 1977, p. 91.

reactivity of the functional groups in the growing polyester chain is independent of the degree of polymerization. In other words, at all stages of polymerization, the reactivity of every functional group is the same. This principle of equal reactivity of functional groups, first demonstrated by Flory,^{4,5} is important for alkyd synthesis because it permits the application of statistical considerations to the problem of distribution of the bonds formed during polymerization.

Polyesterification carried out in the absence of an added catalyst has been found to follow third-order kinetics.^{5,6} The carboxyl groups act as catalyst, and the mechanism involved is the following:

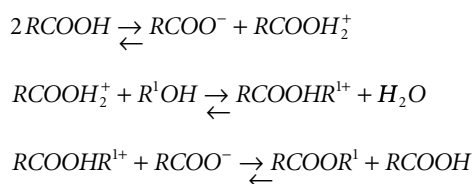

The second step is believed to be rate determining.⁷ In reaction media of low dielectric constant, such as esters and polyesters, the ions are probably associated as ion pairs. The decrease in concentration of carboxyl groups can be expressed as follows:

$$-\frac{d[\text{COOH}]}{dt} = k[\text{COOH}]^2 \cdot [\text{OH}]$$

If the polyesterification is performed in the presence of an acid catalyst, the reaction becomes second order.^{6,7} At high degrees of conversion, however, the reactions become sluggish. This has been ascribed to depletion of the catalyst; at low concentration of remaining carboxyl groups, a catalyst, such as *p*-toluenesulfonic acid, may compete favorably in reacting with hydroxyl groups, thus acting as a chain-terminating additive.^{8,9}

51.3 Functionality and Prediction for Gel Point

In the condensation of bifunctional reactants, the functionality of the reaction product is always 2, regardless of the extent of reaction. In the reaction between a triol and a dibasic acid, using equivalent amounts of hydroxyl and carboxyl groups, on the other hand, the functionality of the molecules formed increases as the reaction proceeds. This is illustrated below for the reaction between glycerol and adipic acid; the tetraester produced has a functionality of 4.

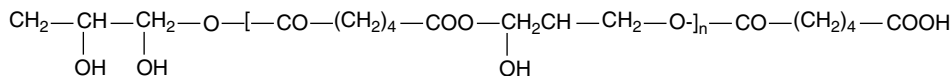

51.3.1 Actual Functionality

In the example above, the actual functionality equals the maximum functionality of both the triol and the dibasic acid; a highly cross-linked structure will form, and gelation will eventually occur.

If the glycerol and the adipic acid are instead used in equimolecular amounts, a linear polymer will be obtained. The actual functionality of the triol is now 2, instead of 3, because on average, only two hydroxyl groups from each glycerol molecule will react.

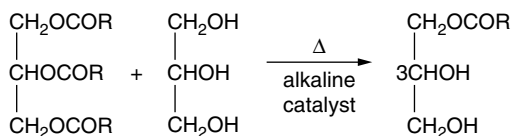

In the alkyd syntheses, an excess of hydroxyl over carboxyl groups is used. The actual functionality of the acid component is then equal to its maximum functionality. The actual functionality of the polyol, on the other hand, is lower than the maximum functionality and can be calculated¹⁰ from the following formula:

$$F_{\text{actual}} = \frac{F_{\text{maximum}}}{1+n}$$

where n is the fraction of the hydroxyl groups present in excess of carboxyl groups.

For example, in the case above, where glycerol and adipic acid are used in equimolecular amounts, hydroxyl groups are present in 50% excess. Hence, the actual functionality will be as follows:

$$F_{\text{glycerol}} = \frac{3}{1+0.5} = 2$$

The overall maximum functionality of an alkyd composition, including both acid and alcohol components, is expressed as

$$F_{\text{overall, max}} = \frac{\text{Total equivalents}}{\text{Total moles}}$$

A more useful expression is obtained if the excess of one component (usually excess polyol) is disregarded:

TABLE 51.2 Alkyd Formation

Raw Materials	Moles	Maximum Functionality	Equivalents
Diethylene glycol	0.5	2	1.0
Glycerol	1.5	3	4.5
Fatty acid	0.8	1	0.8
Adipic acid	1.8	2	3.6

$$F_{\text{overall, max}} = \frac{\text{Total equivalents} - \text{excess equivalents}}{\text{Total moles}}$$

The following example illustrates the procedure. The alkyd is prepared according to the formulation of Table 51.2.

$$\begin{aligned} \text{Total equivalent polyols:} & 1.0 + 4.5 = 5.5 \\ \text{Total equivalent acids:} & 0.8 + 3.6 = 4.4 \\ \text{Excess equivalent polyol:} & 5.5 - 4.4 = 1.1 \end{aligned}$$

$$F_{\text{overall, act}} = \frac{(5.5 + 4.4) - 1.1}{4.6} = 1.91$$

51.3.2 Gel Point

The overall actual functionality can be used as a measure of whether an alkyd composition will gel. In doing this, Carothers's definition of gel point (i.e., that gelation corresponds to an infinite number average molecular weight) is normally used.¹¹⁻¹³

It can be shown that the extent of reaction at the gel point, P_{gel} , can be written as follows:

$$P_{\text{gel}} = \frac{2}{1.91} = 1.05$$

Now, if P_{gel} is less than 1, the composition will gel before reaction has gone to completion. A value of P_{gel} exceeding 1 indicates that the reaction will not gel (assuming ideal conditions).

Using the value F_{overall} , as obtained from the values of Table 51.2, gives

$$P_{\text{gel}} = \frac{2}{1.91} = 1.05$$

This indicates that 105% conversion is needed to give gelation. Consequently, the composition will not gel.

51.3.3 Alkyd Calculations

The foregoing theory has been the basis for computerized calculations on alkyd formulations. It is well known that alkyds should be processed close to the gel point; gelation during cooking is a disaster, however, a proposed method of saving such runs notwithstanding.¹⁴ In the calculation, the relative amounts of the ingredients can be varied to arrive at a gel point at a certain acid value. Furthermore, the formulation can be modified by incorporating other acids and alcohols into the recipe, as well as by

excluding original ones. The only demand made on a new raw material is that its molecular weight and maximum functionality be known.

The calculations give not only the relative amounts of the starting materials to arrive at gel point at a certain acid value, but also the molecular weight of the alkyd at a given value, higher than the acid value corresponding to gelation.¹⁵

There is usually a discrepancy between theoretical and experimental P_{gel} . The reason for this is that the polyesterification is not an ideal process but is subject to a number of side reactions. Furthermore, the true functionality of the starting materials may not always correspond to the theoretical values.

The most important correction factors to be taken into account in alkyd synthesis calculations are as follows¹⁶:

1. Intramolecular reactions, particularly esterifications, are known to take place in most alkyd syntheses. The true functionality will be reduced.
2. The reactivity of one of the functional groups of a multifunctional reactant is reduced because of steric and/or electric effects. One example of this is glycerol, the secondary hydroxyl group of which reacts slower than the two primary groups.
3. The true functionality of a component is higher than the theoretical value. This applies to polyols in general because etherification invariably occurs parallel to the esterification reactions. Etherification of a polyol having n hydroxyl groups leads to a new polyol with a functionality of $2n$ minus 2. Unsaturated fatty acids also have a true functionality higher than the theoretical value because cross-linking between the chains often occurs during alkyd processing.¹⁷

51.4 Raw Materials

51.4.1 Polybasic Acids

Due to ease of handling, good balance of properties, and economy, orthophthalic acid is the most important polybasic acid for alkyds. It is almost exclusively used in its anhydride form. Isophthalic acid is used as a replacement for phthalic anhydride when a tougher, faster drying, and more chemical- and heat-resistant coating is required. The meta position of its carboxyl groups makes the formation of intramolecular cyclic esters more unlikely with isophthalic acid, leading to higher molecular weights and high viscosities of the alkyds.

Maleic anhydride is sometimes used in limited amounts in alkyd formulations. The olefinic bond of this compound enables it to form Diels-Alder adducts with unsaturated acids in drying oils.^{18,19} As a consequence, the total functionality of the system will increase, leading to high viscosity and risk of gelation. The incorporation of maleic anhydride into alkyd formulations generally improves color and water resistance.

Longer aliphatic dibasic acids, in particular adipic and azelaic acid, may be used as minor ingredients to impart flexibility in the alkyd structure. Tri- and tetrafunctional acids or anhydrides, such as trimellitic and pyromellitic anhydride, are incorporated to produce alkyds of high acid value. Chlorinated and brominated compounds (e.g., tetrachloro- and tetrabromophthalic anhydride) are used to impart fire-retardant properties to the resin.

51.4.2 Polyols

Usually, a mixture of polyols having a functionality of 2 to 4 are used in an alkyd formulation. Ethylene glycol, diethylene glycol, propylene glycol, and neopentyl glycol are the most important diols; glycerol and trimethylol propane are commonly used triols; and pentaerythritol is the tetraol of choice. The choice of polyol components is mainly responsible for the degree of branching of the alkyd. The flexibility of the resin is also influenced by the distance between the hydroxyl groups — diethylene glycol, for instance,

gives a more flexible product than ethylene glycol. Neopentyl glycol, because of its branched structure, gives heat- and hydrolysis-resistant films.

51.4.3 Fatty Acids and Oils

The vast majority of the nonbasic acids used in alkyd compositions are derived from vegetable oils. Fish oil also is used to a small degree. Rosin, which is a mixture of resinous monobasic acids having a molecular weight of about 330, is sometimes incorporated to improve hardness, initial drying, and water resistance. Synthetic aromatic acids, such as benzoic acid, can provide greater hardness and improve gloss retention.

The degree of unsaturation in the fatty acid governs the drying properties of alkyds. In general, the higher the iodine number of the oil or the fatty acid, the faster the drying (see Section 51.1.1). The position of the double bonds is also of importance, with conjugated bonds being much more reactive in autoxidation than nonconjugated.²⁰

Soybean oil is the workhorse among the vegetable oils. Linseed oil is used for fast-drying alkyds. Tall oil, sunflower oil, and safflower oil are also common as raw materials for drying alkyds. Coconut oil and castor oil are extensively used in nondrying alkyds. The fatty acid composition of the most important vegetable oils is given in Table 51.3.

51.5 Manufacturing Process

Alkyds are prepared by polycondensation of the acid and alcohol components until a predetermined acid value–viscosity relationship has been achieved. The reaction is normally performed under inert gas or solvent vapor to minimize oxidation of unsaturated components. In the initial phases of the reaction, the drop in acid value is rapid, and the increase in viscosity is slow. Toward the latter stages of the reaction, the drop in acid value is slow. Preparation may be performed by a solvent-free process, by the fusion method, or by using a small amount of solvent that forms an azeotrope with water (i.e., the solvent method). Furthermore, in the preparation of fatty acid modified polyesters, either the triglyceride or the fatty acid derived from it may be employed as starting material. These two procedures are referred to as the monoglyceride and the fatty acid process, respectively.

51.5.1 Fusion Method versus Solvent Method

The *fusion method* is the older process but is still widely used, especially for alkyds of an oil length of 60% or more. The reaction is carried out at a temperature of 220 to 250°C, and the inert gas sparge, which is used for dewatering, also causes some loss of volatile polyols and of phthalic anhydride.

In the *solvent method*, the esterification is performed in the presence of a small quantity of water-immiscible solvent, usually xylene. The process is carried out under continuous azeotropic distillation of the solvent. The xylene–water vapor mixture is condensed, the water is separated, and the organic distillate is returned to the reactor. The reaction temperature is governed by the refluxing temperature that, in turn, depends on the amount of xylene used, 5% being a normal value. In general, the solvent method offers better control of the resin composition, as there is virtually no loss of raw materials by volatilization or sublimation.²¹

51.5.2 Monoglyceride versus Fatty Acid Process

When a triglyceride oil is heated together with polyols and polybasic acids, the polyols react preferentially with the acids, and a heterogeneous mixture of triglyceride and unmodified polyester is obtained. The way to overcome this problem is to perform a controlled transesterification of the fatty acids prior to the condensation step. This is usually done by reacting 1 mole of triglyceride with 2 moles of glycerol (or another polyol) at a temperature of 220 to 250°C until the *monoglyceride stage* is obtained. The preferred catalysts are PbO, Ca(OH)₂, and Ca-soaps.²²

TABLE 51.3 Typical Fatty Acid Composition (%) of Vegetable Oils

Fatty Acid	Vegetable Oils											
	Castor	Coconut	Linseed	Olive	Palm	Palm Kernel	Peanut	Safflower	Soybean	Sunflower	Tall	Tung
C8 Caprylic		6				3						
C10 Capric		6				4						
C12 Lauric		44				51						
C14 Myristic		18			1	17						
C16 Palmitic	2	11	6	16	48	8	6	8	11	11	5	4
C18 Stearic	1	6	4	2	4	2	5	3	4	6	3	1
C18 Oleic	7	7	22	64	38	13	61	13	25	29	46	8
C18 Linoleic	87	2	16	16	9	2	22	75	51	52	41	4
C18 Linolenic	3		52	2				1	9	2	3	3
C18 Eleostearic												80
C18 Ricinoleic												
C20 Arachidic							2				2	

Source: From Holmberg, K., *High Solids Alkyd Resins*. New York: Dekker, 1987.

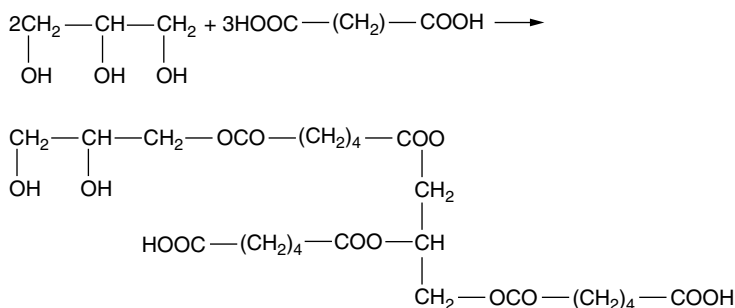

After formation of monoglycerides, the polybasic acids and the rest of the polyols are added, and the condensation is carried out until the desired viscosity–acid value relationship is reached.

The *fatty acid process* uses not the triglyceride but the fatty acid itself. Apart from giving a greater freedom in the choice of polyol components, this process is more reproducible and gives better control over molecular weight and molecular weight distribution of the resin.¹² In addition, this process enables the condensation to be carried on to lower acid values, which is advantageous for the drying properties.

The choice of manufacturing process is not only a matter of finding the most suitable synthesis procedure. There exist distinct differences in film properties between alkyds of the same composition but prepared by different processes.^{23,24}

51.6 Alkyds for Reduced Solvent Emission

During the past decades, a number of new technologies, all derived from the demand to reduce or eliminate the organic solvent from the coating system, have been developed.

51.6.1 High Solids Coatings

By synthesizing alkyds of narrow molecular weight distribution and by reducing the mean molecular weight of the resin, coatings with considerably higher solids content can be attained.²⁵ Strictly speaking, the term “high solids” refers to coatings with more than 80% nonvolatiles by volume. In practice, paints with 70% and even 60% are often included in the high solids category.

51.6.2 Emulsion-Based Coatings

Alkyd emulsions are gaining in importance as a consequence of environmental demands. Paints based on emulsions of alkyd resin in water offer an alternative both to white-spirit-based alkyd formulations and to thermoplastic dispersions of the latex type. From health and environmental points of view, alkyd emulsion coatings are superior to the two other paint types because only water is used as solvent, and because volatile coalescing agents normally need not be added.^{26,27}

The main interest in alkyd emulsions has been for use in air-drying paints and lacquers, mainly for do-it-yourself use. This means that the vast majority of resins used so far have been long oil alkyds. Such resins are suitable for emulsification, as their viscosities are relatively low. There is also an emerging interest in emulsification of medium and short oil alkyds for industrial use. The emulsification procedure is more complicated for such polymers, however, because the process will probably have to be carried out above 100°C in a pressurized autoclave in order to bring down the viscosity of the dispersed phase to a suitable level.

A limited colloidal stability is a potential problem of all technical emulsions. A prerequisite of good emulsion stability is that small droplets and a narrow droplet size distribution are obtained in the emulsification process. If these requirements are attained, the stability will depend on the ability of the emulsifier to prevent coalescence and flocculation of the droplets. Two main types of stabilization

mechanisms operate: steric stabilization, provided by nonionic surfactants or polymers, and electrostatic stabilization, attained by the use of ionic surfactants. A combination of the two may also be employed.

Compared with white-spirit-based alkyd formulations, the emulsions generally give slower drying and exhibit somewhat impaired film properties. The dried film is usually softer and more water sensitive than a film obtained from the same resin formulated in an organic solvent. The impairment of film properties may, at least partly, be due to the surfactant, which acts as an external plasticizer in the film, imparting softness and flexibility. This could have been taken advantage of, if the plasticizer had been evenly distributed in the coating. However, due to its surface activity, the surfactant will migrate out of the bulk phase and concentrate at the interfaces. It has been shown by electron spectroscopy by chemical analysis (ESCA) that the surface of a dried lacquer film applied on glass may consist of 50% surfactant, even if the total surfactant concentration in the formulation is as low as 1%.

One way to reduce the problems associated with the presence of surfactant in the dried film is to use an emulsifier, which is capable of participating in the autoxidative drying process. Polymerizable surfactants exist that are suitable for the purpose.

The relatively slow rate of drying of alkyd emulsions may partly be caused by the presence of nonpolymerizable surfactants in the film and may partly be due to the metal salt driers being less efficient catalysts in the emulsion systems than in white-spirit-based formulations. It has been suggested that the ability of cobalt to act as a redox-type catalyst is impaired in the presence of ammonia and amines (which are used as neutralizing agents in most water-borne alkyd formulations), due to the formation of a stable, nonoxidizable cobalt(II)hexamine complex. Cobalt may also form catalytically less active complexes with water.

Another possible cause of poor performance of the driers in alkyd emulsions is unfavorable distribution between the phases. In principle, the drier molecules may be located in the water phase, in the alkyd phase, or at the oil–water interface together with the emulsifier. It may be assumed that partitioning in the aqueous phase is unfavorable.²⁶

51.6.3 Powder Coatings

Powder coatings may be regarded as the ultimate solution to the problem of solvent emission. Oil-free alkyds (saturated polyester) are being used in thermosetting powder coatings in combination with epoxy or isocyanate cross-linkers.²⁸

51.7 Modified Alkyds

51.7.1 Polyamide Modification

Thixotropic alkyd resins are made by combining alkyds with polyamide resins and heating the mixture so that amide and ester interchange reactions occur. The thixotropic behavior of these resins is attributed to hydrogen bonding between ester carbonyl and amide groups distributed along the polymer chain.²⁹

51.7.2 Vinyl Modification

A vinyl monomer, usually styrene or vinyl toluene, can be polymerized onto an alkyd containing unsaturated groups. The products obtained are a mixture of graft copolymers and polymer blends.³⁰ Vinyl-modified alkyds are characterized by very fast drying and by hard, water-resistant films.

51.7.3 Other Modifications

Alkyds may be modified with *silicones* to give copolymers with excellent durability and heat resistance. *Alkyl methacrylate* modified alkyds are fast curing and have good gloss retention and durability. Modification with *epoxy resins* yields products that have excellent adhesion properties and improved water and chemical resistance.

51.8 Uses

Alkyd resins as a group are characterized by good adhesion and drying properties. The films produced have good flexibility and durability. By various modifications, specific properties can be improved. A weak point of alkyds is the susceptibility to alkaline hydrolysis. Following are descriptions of alkyd resins:

Long oil alkyds are soluble in aliphatic solvents. Normally applied by brush, they are used in exterior trim paints and wall paints, as well as in marine and metal maintenance paints. They are also widely used in clear lacquers.

Medium oil alkyds are soluble in aliphatic–aromatic solvent blends. The air-drying type is used as the standard vehicle for industrial applications, such as primers and undercoatings, maintenance paints, and metal finishes. The nonoxidizing type is often used as external plasticizer in nitrocellulose lacquers.

Short oil alkyds are soluble in aromatic but not aliphatic solvents. The air-drying type is used in baking primers and enamels, either as the sole binder or together with other resins, such as urea or melamine resins. The nondrying type is mainly used as plasticizing resin in nitrocellulose lacquers and in combination with urea or melamine resins in stoving and acid curing finishes.

Oil-free alkyds are widely used together with melamine resins in high-performance stoving coatings.

References

1. R. H. Kienle and C. S. Ferguson, *Ind. Eng. Chem.*, **21**, 349 (1929).
2. D. H. Solomon, *The Chemistry of Organic Film Formers*. New York: Krieger, 1977, p. 91.
3. R. W. Lenz, *Organic Chemistry of Synthetic High Polymers*. New York: Wiley Interscience, 1967, p. 6.
4. P. J. Flory, *J. Am. Chem. Soc.*, **64**, 2205 (1942).
5. P. J. Flory, *Principles of Polymer Chemistry*. Ithica, NY: Cornell University Press, 1953.
6. S. D. Hamann, D. H. Solomon, and J. D. Swift, *J. Macromol. Sci. Chem.*, **A2**, 153 (1968).
7. J. H. Saunders and F. Dobinson, *Comprehensive Chemical Kinetics*, Vol. 15: in the series *Non–Radical Polymerization*. C. H. Bamford and C. F. H. Tipper, Eds. Amsterdam: Elsevier, 1976, pp. 505, 507.
8. P. J. Flory, *Chem. Rev.*, **39**, 137 (1946).
9. C. E. H. Bawn and M. B. Huglin, *Polymer*, **3**, 257 (1962).
10. W. C. Spitzer, *Off. Dig.*, **36**, 16 (1964).
11. W. H. Carothers, *Trans. Faraday Soc.*, **32**, 39 (1936).
12. D. H. Solomon, *The Chemistry of Organic Film Formers*. New York: Kreiger, 1977, pp. 65, 82, 88, 108.
13. C. W. Johnson, *Off Dig.*, **32**, 1327 (1960).
14. A. Gal and A. Hardof, *Org. Coat. Sci. Technol.*, **8**, 55 (1986).
15. L. A. Tysall, *Calculation Techniques in the Formulation of Alkyds and Related Resins*. Teddington, United Kingdom: Oaint Research Association, 1986.
16. D. H. Solomon, *The Chemistry of Organic Film Formers*. New York: Kreiger, 1977, pp. 84–86.
17. D. Firestone, *J. Am. Oil Chem. Soc.*, **40**, 247 (1963).
18. A. E. Rheineck and T. H. Khoe, *Fette Seifen Anstrichm.*, **71**, 644 (1969).
19. K. Holmberg and J. -A. Johansson, *Acta Chem. Scand.*, **B36**, 481 (1982).
20. D. H. Solomon, *The Chemistry of Organic Film Formers*. New York: Kreiger, 1977, pp. 38–74.
21. E. G. Bobalek, E. R. Moore, S. S. Levy, and C. C. Lee, *J. Appl. Polym. Sci.*, **8**, 625 (1964).
22. R. A. Brett, *J. Oil Colour Chem. Assoc.*, **41**, 428 (1958).
23. J. R. Fletcher, L. Polgar, and D. H. Soloon, *J. Appl. Polym. Sci.*, **8**, 659 (1964).
24. D. H. Solomon and J. J. Hopwood, *J. Appl. Polym. Sci.*, **10**, 993 (1966).
25. K. Holmberg, *High Solids Alkyd Resins*. New York: Dekker, 1987.
26. G. Östberg, M. Huldén, B. Bergenstähl, and K. Holmberg, *Prog. Org. Coatings*, **24**, 281 (1994).
27. K. Holmberg, “Surface chemistry in paints,” in *Handbook of Applied Surface and Colloid Chemistry*, K. Holmberg, Ed. Chichester: Wiley, 2002.

28. S. Paul, *Surface Coatings: Science and Technology*, 2nd ed. New York: Wiley, 1996.
29. A. G. North, *J. Oil Colour Chem. Assoc.*, 39, 695 (1956).
30. E. F. Redknap, *J. Oil Colour Chem., Assoc.*, 43, 260 (1960).

52

The Polyurea Revolution: Protective Coatings for the 21st Century

52.1	History	52-1
52.2	Polyureas versus Polyurethanes/Chemistry	52-1
52.3	Application Characteristics.....	52-2
52.4	General Performance	52-2
52.5	Weathering Characteristics	52-2
52.6	Chemical, Water, and Corrosion Resistance.....	52-2
52.7	Safety	52-3
52.8	Conclusion	52-4

Bruce R. Baxter
Specialty Products, Inc.

Welcome to the new world of polyureas. In the time it is taking you to read this sentence, a polyurea elastomeric coating, mixed and sprayed onto a surface, will have reached its initial set.

52.1 History

Polyureas were first developed in the 1970s, but the development of any practical application was impeded by their extremely short set times of 1 to 3 sec. In the early 1980s, sophisticated, plural-component heated equipment was able to mix quickly and dispense the polyureas into a usable form. Throughout the 1980s and 1990s, improvements in polyurea chemistry led to products with set times that ranged from 3 sec to 25 min. This led to a wide variety of practical applications.

52.2 Polyureas versus Polyurethanes/Chemistry

Polyureas, as the name suggests, are closely related to polyurethanes. Both polyureas and polyurethanes are based on a two-component system, with one component being an isocyanate material. Polyureas' second component is a polyether polyamine, whereas polyurethanes' second component is a polyether polyol. Polyurethanes require a catalyst to speed up the reaction time of the components, whereas polyureas do not. The polyurethane reaction is sensitive to low temperatures and moisture due to the addition of catalysts. Low temperatures inhibit the reaction time. Moisture interferes with the reaction by creating carbon dioxide, which causes blistering in the polyurethanes. Polyureas, on the other hand, require no catalyst, so they are able to cure at any temperature and in the presence of moisture. The fast curing ability of polyureas is inherent in their chemistry, which gives them several unique advantages.

In substitution of the polyols used in the urethanes, polyoxyalkylene diamines, triamines, and amine chain extenders are used with the isocyanate to form the linkage for the ureas. The amine reaction with the isocyanate, even without any catalyst, is much quicker than with the hydroxyl of the polyol or water. Because of the speed of the reaction times, polyurea systems can be sprayed on damp or wet surfaces with no detrimental reactions on performance.

52.3 Application Characteristics

Polyurea coatings are sprayed through standard 1:1 ratio heated plural-component equipment. This equipment, depending upon model type, creates between 1000 to 3000 lb (7 to 20 Mpa) of pressure. Because the gel time is near instantaneous, polyureas can be built to any thickness in one coat with no microcellular development in one pass. This is of particular importance on vertical and overhead surfaces to be coated. The polyurea surface can be walked on in 30 sec or less for inspection. If recoating of thin spots or holidays is required, this can be done immediately or within hours with no additional preparation. Curing of polyureas is attained even when the product is applied to damp or cold surfaces. The polyurea elastomers can be sprayed directly on water or ice and at temperatures lower than -40°F with minimal effects on tack-free times. Polyureas require no catalysts to cure, which imparts greater shelf life to the components. This also eliminates wasteful premixing of excess materials at the job site.

52.4 General Performance

The main area of performance is its resistance to physical rupture, water, chemicals, and weather. The tear strength of unsupported (free film) polyurea elastomer is around 3 Mpa (450 Pli) and will exceed 4 Mpa (600 Pli) when backed with a geotextile fabric. Abrasion resistance, which is important in heavy traffic areas, has also tested well. On a Tabor Abrasion test (1 Kg H-18 wheel), only 110 mg were lost after 1000 revolutions. Polyurea coatings also adhere well to different substrates. The combination of film toughness and adhesion qualities helps to maintain good seals even where different materials make contact. Due to the lack of catalysts in polyurea systems, moisture and ambient temperature concerns are eliminated.

In one study, samples of steel, concrete, and asphalt were coated with polyurea elastomer. They were then sprayed for 30 sec with a stream of liquid nitrogen (-196°C) 30.5 cm from the surface. There was no damage. The concrete sample was dropped 1.8 m. The concrete shattered, but the polyurea elastomeric coating was undamaged and held the concrete shards together.

52.5 Weathering Characteristics

Installed polyurea elastomeric systems have held up well in exposed applications for several years. A number of these sites are located in areas where extreme weather conditions exist. Roofing and secondary containment in both Arizona ($100^{\circ}\text{F}+$) and Alaska (-55°F) have proven to work well using polyurea systems. Polyurea systems are aromatic and sensitive to ultraviolet (UV) radiation. Discoloration, loss of gloss, and some chalking are to be expected if the system is exposed. This exposure, however, does not affect the performance or quality of the system. If aesthetics are a concern, an aliphatic urethane or other color stable material is suggested for a topcoat.

52.6 Chemical, Water, and Corrosion Resistance

Polyurea systems are resistant to water- and petroleum-based chemicals such as acetone, gasoline, MTBE, and motor oil. They are also resistant to sulfuric acid, acetic acid, and to caustics at low concentrations (5%). At higher concentrations (50%) some discoloration will occur. These results are from watch glass

TABLE 52.1 Chemical Resistance Testing for Polyurea Spray Elastomers

Chemical Resistance ASTM D 3912	
Chemical	12-Month Exposure
Methanol	S, swelling, <48 h
Gasoline	Slight surface change, no hardness loss
Diesel fuel	No visible damage
Toluene	S, swelling, <24 h
MTBE	Slight surface change
5% MTBE/gasoline	Slight surface change
Motor oil	Slight surface change, no hardness loss
Hydraulic fluid	Slight surface change, no hardness loss
2-Methylbutane	No visible damage
Water	
Room temperature	No visible damage
82°C, 14 days	No visible damage
10% NaCl/water	
Room temperature	No visible damage
50°C, 14 days	No visible damage
10% Sugar/water	No visible damage
Sulfuric acid	
5%	No visible damage
10%	No visible damage
3%, 50°C, 14 days	No visible damage
Hydrochloric acid	
5%	No visible damage
10%	No visible damage
Phosphoric acid	
10%	No visible damage
Ammonium hydroxide	
10%	No visible damage
20%	No visible damage
Sodium hydroxide	
10%	No visible damage
20%	No visible damage
50%	Slight surface discolor, no hardness loss
1%, 50°C, 14 days	Slight surface discolor, no hardness loss
Potassium hydroxide	
10%	No visible damage
20%	Slight surface discolor, no hardness loss
Acetic acid	
10%	No visible damage

Source: From Technical Bulletin 0197, March 1996, Specialty Products, Inc., Lakewood, WA.

testing according to the ASTM D 1308 test method. Using polyurea systems in areas exposed to strong acids and oxidizing agents is not recommended (Table 52.1).

On-site testing on metal structures verifies test results that predict outstanding corrosion protection. After exposure to salt spray for 1000 h, no blistering occurred in a 25 mil polyurea system spray applied to 2 mil blast profile steel panels. The corrosion was 4 mm from the scribe (Table 52.2).

52.7 Safety

Polyurea elastomeric coating systems contain 100% solids and thereby do not release any solvent vapors (0 VOC). Fumes from the hardener (B component), however, can cause irritation to the respiratory tract and are also a mild skin irritant. When working with any polyurea system, provide adequate ventilation

TABLE 52.2 Aromatic Polyurea Spray Weatherability Characteristics^a

Test Method	Percent Retention
QUV 3800 hours	
Shore D	100%
Tear	100%
Elongation	80%
Tensile	97%
QUV 1000 hours	
Shore D	100%
Tear	100%
Elongation	87%
Tensile	100%
Xe arc 1000 hours	
Shore D	90%
Tear	100%
Elongation	85%
Tensile	100%

^a Elastomer physical properties: Tensile strength, psi — 2265; Elongation, % — 190; Tear strength, pli — 460; Shore D Hardness — 52.

Source: Technical Bulletin 0197, March 1996, Specialty Products, Inc., Lakewood, WA.

of the area and wear chemically impervious gloves and eye protection at all times. If the polyurea system being used is the spray type, a respiratory mask should be worn at all times.

52.8 Conclusion

Polyurea elastomeric coating systems are becoming the coating of choice, because they are easily applied in one coat and set rapidly, thus providing minimal down time and extraordinary sealing characteristics. A wide variety of imaginative uses are developing as people gain experience with polyurea elastomeric systems.

53

Phenolic Resins

53.1 Rigid Packaging	53-2
53.2 Maintenance Primers	53-3
53.3 Printing Inks	53-3
53.4 Epoxy Hardeners	53-4
53.5 Summary	53-4
References	53-5

Kenneth Bourlier
Union Carbide Corporation

Synthetic phenolic resins were developed and commercialized in the early 1900s by Leo Baekland.¹ The reaction of phenol and formaldehyde produces a product that forms a highly cross-linked three-dimensional polymer when cured. The resins have found use in various applications in the coatings industry because of their excellent heat resistance, chemical resistance, and electrical properties. They also offer good adhesion to many substrates and have good compatibility with other polymers.

Phenolic resins have two basic classifications: resoles and novolaks. Resoles, or heat-reactive resins, are made using an excess of formaldehyde and a base catalyst. The polymer that is produced has reactive methylol groups that form a thermoset structure when heat is applied.

Novolaks are made using an excess of phenol and an acid catalyst. Reaction occurs by the protonation of the formaldehyde,² and the intermediate is characterized by methylene linkages rather than methylol groups. These products are not heat reactive, and they require additional cross-linking agents such as hexamethylenetetramine to become thermosetting. These reactions can be thought of as nucleophilic attack of phenoxide ion on the formaldehyde, or electrophilic substitution by protonated formaldehyde on the aromatic ring.³

Both polymerization reactions evolve water during cure. This condensation reaction serves to limit film thickness to approximately 3 mils, because the volatiles will cause blistering while curing takes place. Baking temperatures are generally 300 to 400°F with a bake time of 10 to 30 min.

Phenolic resin polymers have been used in the coatings industry for many years because of their excellent performance properties and their relatively low cost. Some of the major applications are in rigid packaging, maintenance primers, printing inks, and epoxy hardeners. A brief discussion of these applications follows.

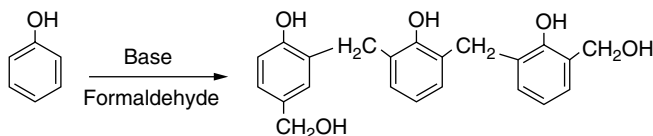

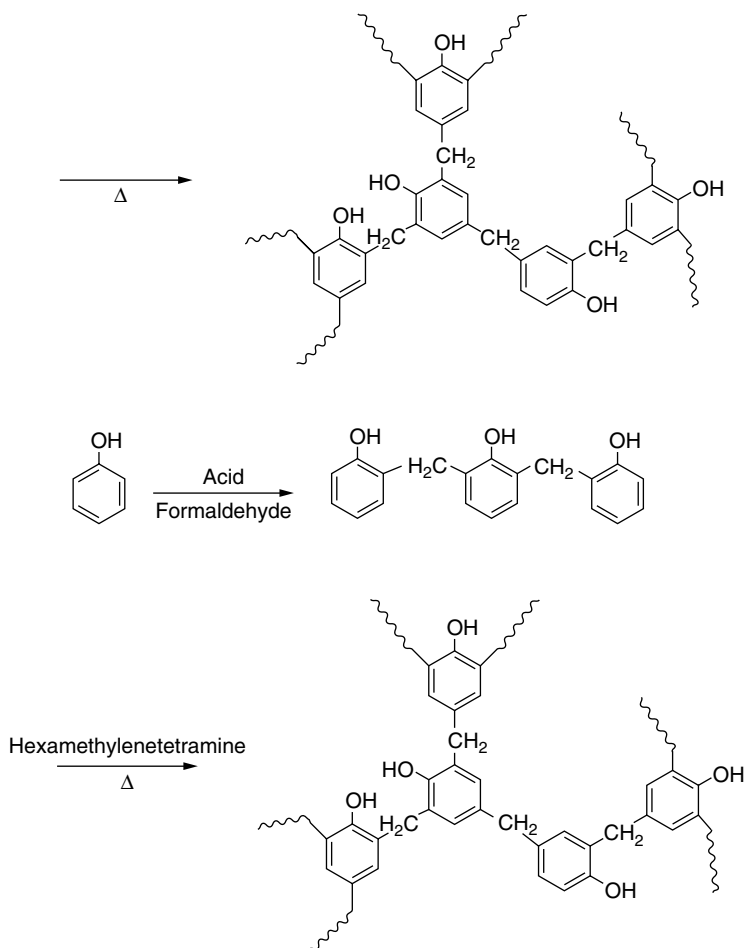

53.1 Rigid Packaging

Phenolic resins have found use in metal containers because they offer outstanding corrosion protection and excellent adhesion, along with chemical and solvent resistance. Typical end-use applications are food container coatings, drum and pail lining, pipe coatings, tank linings, and coil coating primers, or certain polyester resins.

Unmodified phenolics are often used in drum, pail, and pipe coatings. Since the substrate is usually rigid, the brittleness associated with these phenolic formulations does not present a problem. The excellent solvent resistance of phenolic resins makes them ideal for this application. A film thickness of 0.2 to 0.3 mils often provides sufficient protection. Thicker films can also be used if coatings are applied in several layers to prevent blistering during cure.³ Bake schedules generally range from 300 to 400°F with times varying from 10 min to several hours. The coatings may be clear or pigmented with iron oxide. A typical formulation is listed in [Table 53.1](#). Formulations may be applied by spray, brush, or roller coating.

The requirements of food can linings are quite different from those of drum coatings. Food can coatings must have sufficient flexibility to survive any impact that could fracture the coating and thus expose the metal surface to the contents of the can.⁴ The phenolic resins are based on blends of phenol and cresols that offer varying degrees of flexibility and chemical resistance. Resins based on bisphenol A are used in critical taste applications. High molecular weight epoxies are used as modifiers to further enhance the flexibility of the cured films.

Another consideration for food can formulations is sulfur staining. Foods high in protein such as meats and fish contain sulfur, which may permeate to the substrate and cause discoloration.⁵ Phenolics,

TABLE 53.1 Drum and Pail Lining

Ingredients	Parts by Weight
Phenolic resin ^a	73.30
Acetone ^b	7.00
Methyl ethyl ketone	9.00
Ethanol	55.00
Propyl Propasol solvent	14.00
Cyclohexanone	15.00
Leveling agent	0.05

^a BKS-2600, Union Carbide Corp.

^b Silwet L-7602, Union carbide Corp.

Source: Union Carbide Corp., Formulation Suggestions — Durable Phenolic Baking Coatings for Rigid Metal Substrates (F-60675), 1988.

TABLE 53.2 Food Container Formulation

Ingredients	Parts by Weight
Phenolic resin ^a	22.90
Epoxy resin ^b	34.00
<i>n</i> -Butanol	11.30
Methyl Propasol acetate	11.30
85% Phosphoric acid	0.25
Leveling agent ^c	1.00

^a Ucar BKS-7570, Union Carbide Corp.

^b Epon 1007, Shell Chemical Co.

^c Silicon resin SR 882M, General Electric.

Source: From Morrison, R. T., and R. N. Boyd, *Organic Chemistry*. 3rd ed. Boston: Allyn and Bacon, 1973, p. 1147.

because of their high degree of cross-linking, offer outstanding resistance to sulfur-containing foods. A food container formulation is listed in Table 53.2.⁶

53.2 Maintenance Primers

Non-heat-reactive phenolics are used in combination with drying oils or alkyds to produce air drying maintenance coatings. The phenolic resins supply solvent and moisture resistance, while the oils or alkyds impart flexibility and good filming characteristics.⁷ In the past, parasubstituted phenolic novolak resins were actually cooked with unsaturated oils such as linseed or castor oil.⁸ The mixtures were boiled at 400 to 500°F until a thick resinous solution was produced. The reaction mechanism is not completely understood, but it is believed that quinone methylene structures in the phenolic resins react with the double bond in the oil through a Diels-Alder type of reaction.⁹ The resin solution is then let down in mineral spirits or aromatic solvents along with metal driers such as cobalt or manganese. Usually a combination of driers gives the best overall performance.¹⁰ The result is an air dry finish that has excellent weathering resistance. Today, it is increasingly popular to simply cold-blend phenolic resins¹¹ based on *p*-*tert*-butyl phenol along with solvents, driers, and highly reactive oils such as tung oil. Coating properties are excellent, and the procedure takes less energy and time.

53.3 Printing Inks

Phenolic resins are used in numerous printing ink formulations. Lithographic, letterpress, and gravure inks are oleoresinous and have phenolic resins added to the ink systems to improve film hardness and

gloss.¹² Parasubstituted phenolic novolak resins that have been modified with rosin make excellent ink additives. Rosin modification of the phenolic resin raises the melting point and gives the phenolic excellent oil solubility. The formulations consist of a phenolic resin, oils, pigments or dyes, driers, and lubricants or plasticizers.¹³ The proper balance of ingredients gives the desired combination of hardness, viscosity, penetration, and drying rate.

53.4 Epoxy Hardeners

Phenolic resins may be combined with epoxy resins for use in protective coatings. Phenolic-epoxy products are also used in laminates, prepreg manufacturing, molding materials, and electrical insulation coatings. The phenolic resin is used as a coreactant to produce thermoset systems with improved heat and chemical resistance. Non-heat-reactive (novolak) resins are used to cross-link the epoxies. The epoxy resins are typically epoxy-phenolics or bisphenol A-based resins.¹⁴ The reaction mechanism is different from the resole-epoxy reactions. The coating is heat-activated and uses a base catalyst such as an amine, dicyandiamide, or an imidazole.¹⁵ The phenolic hydroxyl group reacts with the epoxy group to form a polyether structure, which has an advantage, because no volatiles are released during cure. This allows for thick films to be produced with low shrinkage and no voids from volatile emission. The phenolic-epoxy reaction using a base catalyst can be demonstrated as follows:

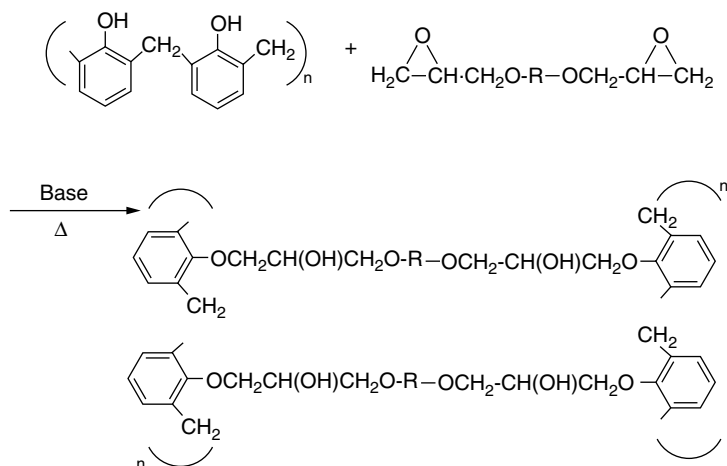

For critical electrical applications, “high purity” resins are used. These products are made according to stringent specifications limiting the amount of water, ions, and free monomers present in the resin.

53.5 Summary

Phenolic resins were one of the first synthetic polymers to have widespread commercial importance. Their outstanding performance properties have given them a permanent role in the coatings industry. They are used in applications ranging from railroad tank cars to carbonless copy paper. Phenolic resins are also used on a wide variety of substrates including metal, wood, paper, and ceramics. There are so many types of phenolic resin available to the marketplace that a particular resin can be selected for virtually any application.

Phenolic resins should not be overlooked when choosing a high performance polymer. Phenolics currently do not receive the same attention as some of the more recently developed polymers, but for many applications, there is simply no substitute for phenolic resins. Phenolics will continue to have an important role in the coating industry because of their versatility, coatings properties, and reasonable price.

References

1. J. S. Fry, C. N. Merriam, and W. H. Boyd, *Chemistry and Technology of Phenolic Resins and Coatings*, in ACS Symposium Series. *Applied Polymer Science*. Washington, DC: American Chemical Society, 1985, p. 1147.
2. R. T. Morrison, and R. N. Boyd, *Organic Chemistry*, 3rd ed. Boston: Allyn and Bacon, 1973, p. 1147.
3. J. S. Fry, C. S. Merriam, and W. H. Boyd, *Chemistry and Technology of Phenolic Resins and Coatings*, ACS Symposium Series, *Applied Polymer Science*. Washington, DC: American Chemical Society, 1985, p. 1149.
4. Union Carbide Corp., *Formulation Suggestions — Durable Phenolic Baking Coatings for Rigid Metal Substrates* (F-60675), 1988.
5. A. Knop, and L. Pilato, *Phenolic Resins*. Berlin: Springer-Verlag, 1985, p. 247.
6. Union Carbide Corp., *Ucar Phenolic Resin BKS-7570* (F-60689), 1988.
7. R. W. Martin, *The Chemistry of Phenolic Resins*. New York: Wiley, 1956, p. 203.
8. R. R. Myers and J. S. Long, *Film Forming Compositions*. New York: Dekker, 1972, p. 155.
9. R. W. Martin, *The Chemistry of Phenolic Resins*. New York: Wiley, 1956, p. 205.
10. R. G. Middlemiss, *J. Water Borne Coat.*, November (1985).
11. S. H. Richardson, *Paint Varnish Prod.*, August (1955).
12. A. Knop, and W. Scheib, *Chemistry and Application of Phenolic Resins*. Berlin: Springer-Verlag, 1979, p. 192.
13. National Association of Printing Ink Manufacturers, *Pattern Printing Ink Formulae*. NAPIM, 1974.
14. J. S. Fry, *Ucar Phenolic Resins for Epoxy Hardeners*. Union Carbide Corp. (P-)-3(57).
15. U. S. Patent 3,493,630, Union Carbide Corp.

Coal Tar and Asphalt Coatings

Henry R. Stoner
Henry R. Stoner Associates

54.1 Coal Tar Types.....	54-1
54.2 Asphaltic Types.....	54-3
Bibliography	54-4

Coal tar coatings have been used for many centuries because of their resistance to water and biological organisms. Coatings based on asphalt have been developed for over a century. This is a brief review of the materials.

54.1 Coal Tar Types

Bituminous coal, a very complex chemical mixture, decomposes into simpler components when heated in retorts without air above 700°C (1292°F). Gas, aqueous vapor, and coal tar are driven off, leaving coke as residue. The coal tar is dehydrated and heated in stills to yield oil and coal tar pitch. Depending on the source of the coal tar and the amount of heat applied, pitches of different characteristics are obtained. When used as bases for superior coatings, coal tar pitches are reprocessed, and any corrosion-accelerating substances are removed. Various types of coal tar pitches are then blended together.

The outstanding quality of coal tar paints is their extremely low permeability, their high electrolytic resistance, and their remarkable resistance to the disintegrating action of water. There are hardly any materials, old or new, that are as water resistant as properly compounded coal tar coatings. They will not be affected by mineral oil but may be dissolved by vegetable and animal oil, grease, and detergents, if they are in direct contact with them. Their resistance to weak mineral acids, alkalis, salts, brine solutions, and other aggressive chemicals is good. Furthermore, coal tar paints give more value per dollar than any other protective coating. This fact should not be overlooked when selecting paint for a certain job.

Coal tar paints are made by dissolving the processed pitch or blend of pitches in suitable solvents. Skill and experience are essential in compounding coal tar paints because similar physical characteristics of raw materials do not necessarily mean similar behavior of the finished product under exposure. The raw materials selected for the blending, the degree of refining, and the addition of other modifiers, often in small quantities, decide the final merit of the coating.

There are five main types of coal tar coatings:

1. Thin coal tar pitch solutions without any filler
2. Heavy coal tar pitch solutions with inert fillers added
3. Very heavy coal tar pitch coatings containing inert fillers possessing a thixotropic gel structure but only medium inherent viscosity
4. Heavy coal tar emulsions containing inert fillers and having low inherent viscosity
5. Hot applied coal tar coatings

The first three types are solutions and have about the same chemical and water resistance. They vary mainly in the thickness of the film that can be laid down in a single coat. The fourth type, coal tar emulsions, consists of dispersions of coal tar pitch in water and are inferior in corrosion resistance to the solution type. This is not a fault of the pitch itself but is caused by the higher permeability of the applied film. Pitch particles dispersed in water are relatively large and do not coalesce as completely after drying as the much smaller dissolved pitch particles do. But coal tar emulsions have other very good features that will be mentioned later.

The fifth type, coal tar pitch reinforced with inert filler and applied in a molten state over a primer, is called in the trade, coal tar enamel. These enamels have all the good qualities of coal tar paints, but in a higher degree, because the coating is very thick and does not depend on the evaporation of solvent to set.

Type 1 is a thin coal tar solution of low viscosity with a solids content of 60 to 70% and a spreading rate of 300 to 400 square feet per gallon, and it gives an approximate thickness of 1 to 2 mils per coat. This thickness cannot be increased because the thin solution cannot be applied at a lower rate without sagging. Type 2 is designed to achieve a heavier coat; a filler coal tar solution must be used, which, in addition to its higher solids content, can be applied at approximately 180 square feet per gallon without sagging. This produces an approximate dry film thickness of 6 mils. To apply even heavier coatings by brush, a gel must be selected that can be applied at the low rate of 75 square feet per gallon without sagging. This will produce a dry film thickness of approximately 16 mils in one coat. Coal tar emulsions will not sag at a coverage of 75 square feet per gallon and will give approximately a 12 mil dry film thickness in one coat.

Coal tar paints afford protection by the mechanical exclusion of moisture and air. If they are applied as a continuous film without holidays, they give almost perfect protection. As it is impossible to avoid pinholes and flaws in a one-coat application, more than one coat will be necessary. They dry by solvent evaporation only.

Concrete, as a rule, can be protected with thin coal tar solutions, but steel requires heavier coatings that will form an almost impervious barrier against severe corrosive influences.

All coal tar paints "alligator," more or less, in the sun. The paint will look like an alligator skin, and hence, the name alligatoring. This alligatoring is a surface defect. It is brought about by the hardening of the upper layer of the film, stimulated by the sun's rays. This causes the upper layer to contract, crack, and slip over the lower stratum which is still soft. If not enough coats are applied, these alligator marks can go right down to metal, opening the path for atmospheric corrosion. Alligatoring does not (or only to a limited degree) occur under water, where the coating is protected from the rays of the sun. Coal tar emulsions do not produce this phenomenon, probably because the pitch particles are not fused as tightly as in solution types; therefore, coal tar emulsions can be used as topcoats over badly alligatoring heavy coal tar paints. Bear in mind that these emulsions have less protection capabilities in immersion service and are not recommended for such use.

There are several popular methods to prevent alligatoring of heavy coal tar coatings, which are temporarily exposed to sun and air before submersion. The older method uses a whitewash. Add slowly and simultaneously 150 lb of processed quicklime and 1 gal of boiled linseed oil to 50 gal of water, containing 10 lb of salt dissolved therein. While being mixed and for 15 min thereafter, the mixture shall be stirred continuously and allowed to cool. It shall be free from lumps and foreign matter. The whitewash shall be aged for at least 3 days before application (NAVDOCKS Specification 34 Yc).

A more current approach is to use an acrylic latex paint, or a similar emulsion paint applied to the surface of the coal tar coating. However, note that discoloration of this paint's film by the oils in the coal tar coating is not deemed as a cause for failure.

The solvents used in coal tar pitches are strong in odor, and adequate ventilation is necessary during applications and drying. Coal tar emulsions, which use water as a volatile thinner, are in this respect superior and should be used where proper ventilation is not possible.

Coal tar paints give excellent protection at low cost in dam and flood control installations, penstocks, piers, marine work, etc.

Type 5 coatings, coal tar enamels, are used extensively for the exterior protection of steel pipelines with or without a reinforcing wrapper. They are applied by machine or hand daubing. For the interior lining of steel or concrete pipes, coal tar enamels are applied by centrifugal spinning. This process furnishes an extremely smooth surface and cuts down friction between pipe surface and moving liquid.

Coal tar enamel is furnished in different types depending on service conditions such as extremes in high and low temperatures or variations in soil stresses. These stresses are caused by certain types of soil encountered in laying underground pipelines. The modifications consist mainly of different degrees of plasticization and the amount of filler added to the coal tar enamel.

It is possible to protect numerous other surfaces with coal tar enamels, but generally, cold applied heavy coal tar coatings are preferred because they are easier to apply, stand change in temperature better than coal tar enamels, do not require a specially trained working crew, and have less overall cost.

54.2 Asphaltic Types

Asphalt is a term applied to certain bituminous substances that either occur in a natural state or are obtained as residue from the distillation of asphaltic petroleum.

The best known type of natural asphalt is gilsonite, which occurs in a number of parallel vertical veins in Utah and Colorado and is mined in a rather crude way much the same as coal. The best grade, gilsonite select, is a dark-colored, comparatively hard bitumen that has excellent chemical resistance and good weather resistance. It is one of the most valuable grades of asphaltic coatings.

Asphalts obtained from the distillation of asphaltic petroleum vary in their chemical and physical characteristics according to the nature of the crude petroleum, the length of the distillation process, the temperature at which they are subjected, and whether dry steam or air is introduced during the distillation. Steam distilled asphalt is asphalt obtained when dry steam is introduced into the bottom of the still during distillation (which minimizes thermal decomposition of the residue). It has high stretching power but is lacking in toughness and is very susceptible to temperature changes. Air blown asphalt is asphalt obtained when air is introduced into the bottom of the still during distillation (which polymerizes the residue, forming more complex molecules). It has low stretching power but is tough and rubber-like and much more resistant to temperature changes.

By taking advantage of the different characteristics of gilsonite, steam distilled asphalts, and blown asphalts, numerous asphalts can be produced by dissolving these asphalts alone or in blends of different proportions. As a rule, the higher the proportion of gilsonite, the better the coating will be.

These asphaltic paints dry by evaporation only. They are more weather resistant than corresponding coal tar paints because they do not alligator, but they are inferior in water resistance. Since the solvents used in their manufacture are mild, they do not give taste to water coming in contact with them. Consequently, asphaltic paints are frequently used in painting steel tanks and concrete reservoirs storing drinking water. These paints may be reinforced with inert fillers to make very thick, durable coatings giving protection at low cost against severe corrosive conditions. They are, at the same time, very weather resistant, because the fillers minimize the degradation of the asphaltic components against the rays of the sun. If the inert fillers consist mainly of finely divided cork, a heavy coating that has insulating properties can be applied to cold service substrates, such as refrigeration tubing, and this will prevent condensation and sweating.

Asphaltic varnishes are made from such natural asphalts as gilsonite, with or without the addition of resin, by cooking with drying oils. The resultant varnishes are durable. Their lasting qualities depend on their oil length, that is, the more oil incorporated (up to a certain limit), the more lasting the varnish will be. Their use, of course, is limited by their black color.

Bituminous colored paints are made out of asphalt varnishes by pigmentation with strong dry colors. Since the varnish to start with is deep brown, only comparatively dark colored paints can be manufactured. But their extreme durability and low price make them very valuable coatings. They exhibit excellent resistance to industrial fumes, condensation, and the destructive action of sunlight. One drawback is the

loss of gloss caused by chalking, which occurs quite soon when exposed outdoors. This, however, in no way detracts from their inherent weather resistance.

Hot asphaltic coatings reinforced with inert fillers are often used for protecting steel and concrete. If care is taken to obtain a coating free from pinholes and blisters, excellent protection for long periods can be achieved.

Bituminous coatings of all types can be applied over oil, hardened oil, and oleoresinous paints, but they themselves cannot be painted over with any coatings containing linseed or other drying oils. Oil paints and oleoresinous paints dry to an elastic but eventually very hard film. Applied over a thermoplastic bituminous coating, they cannot follow the contraction and expansion of this underlying thermoplastic material, and will crack and eventually peel off. Furthermore, bituminous substances under the heat of the sun will diffuse through a dried film of oil paint and will sooner or later stain the light colored topcoat. However, bleeding can often be stopped by separating the bituminous coating from the colored topcoat with a special sealer.

Bibliography

- Alexander, Stephen H., "Asphalt and asphalt coatings," in *Film Forming Compositions*, Vol. 1, Part 1. Raymond R. Myers and J. S. Long, Eds. New York: Marcel Dekker, 1967.
- American Water Works Association, ANSI/AWWA Standard C203-91, *Coal tar protective coatings and linings for steel water pipelines — enamel and tape hot applied*. Denver, CO: AWWA.
- ASTM, Volumes 04.04; 06.01 and 06.02. Conshohocken, PA: ASTRA.
- Fisher, J., and A. Pistor, *Principal Types of Coatings*. Pittsburg, PA: Koppers Company Literature.
- Hare, Clive H., "Anatomy of paint: Bituminous vehicles," *J. Protective Coat. and Linings*, November, 105–110 (1993).
- Seymour, Raymond B., *Hot Organic Coatings*. New York: Reinhold, 1959.
- Stoner, Henry R., *Coal Tar Mastics and Epoxies*. Liberty Bell Corrosion Course, Philadelphia, PA, September 14, 1977.

55

Vulcanizate Thermoplastic Elastomers

55.1	Introduction	55-1
55.2	Properties	55-1
55.3	Processing	55-2
55.4	Uses of TPV	55-2

Charles P. Rader

Advanced Elastomer Systems, L.P.

55.1 Introduction

A thermoplastic elastomer (TPE) is a material that is processed in the same manner as a conventional thermoplastic but gives a finished article with properties and performance similar to those of a thermoset rubber. Thermoplastic vulcanizates (TPVs, referred to as elastomeric alloys in some earlier literature) are a generic class of TPEs with a chemically cross-linked rubber phase in a continuous matrix of thermoplastic. TPVs thus have properties significantly better than those of the same rubber/thermoplastic composition with little or no cross-linking of the rubber phase (i.e., and olefinic blend).

Figure 55.1 compares the generic classes of TPEs by performance and cost. The TPVs are medium performance, moderate cost TPEs. They have performance and cost higher than those of the styrenic and olefinic blend TPEs and lower than those of the polyurethanes, copolyesters, and polyamides.

55.2 Properties

The cross-linking of a TPV rubber phase gives improvement to a number of properties of a specific rubber/thermoplastic composition, such as EPDM rubber/polypropylene (PP). These property improvements include tensile strength, tensile and compression set resistance, stress relaxation, fluid resistance, and retention of properties at elevated temperature. These improvements qualify TPVs for many uses where a simple rubber/polyolefin blend would be inadequate.

Key parameters for the premium performance of a TPV are (1) the degree of cross-linking of the rubber phase, (2) the degree of dispersion of the rubber phase in the thermoplastic phase, and (3) the thermodynamic compatibility of the polymers present. TPV performance is known to be improved by greater cross-linking, dispersion, and polymer compatibility. TPVs with high polymer compatibility have no need for a compatibilizer; those with low compatibility (e.g., NBR rubber/PP) will need one to stabilize the intermingling of the rubber and thermoplastic chains. The mutual compatibility of the rubber and thermoplastic polymers will increase as the difference in their solubility parameters (i.e., cohesive energy density) decreases.

The hardness of TPVs ranges from 35 Shore A up to 50 Shore D. EPDM/PP TPVs are generally suitable for use in air from -60°C to 135°C , and those from nitrile rubber/PP have a range in air from -40°C to

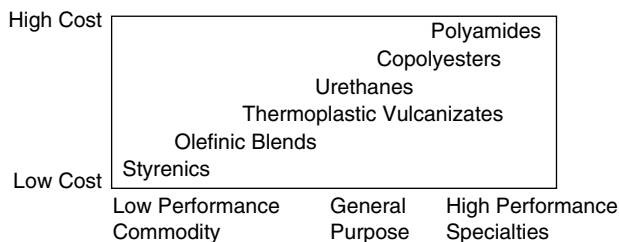

FIGURE 55.1 Comparison of performance and cost of the generic classes of thermoplastic elastomers.

125°C. The specific gravity of these materials is in the 0.9 to 1.0 range, which is 15 to 40% lower than that of most thermoset rubber stocks. Though of little consequence in most service requirements, the ultimate tensile strength of a TPV is generally lower than that of a thermoset rubber of the same hardness. Very few rubber articles are used at an elongation anywhere close to their ultimate limit.

In compression and tension set performance, TPVs are competitive with thermoset rubbers, being the closest approach of a TPE to true rubber performance. Further, their fatigue resistance is truly outstanding. It is highly unusual for a specific rubber composition to give good performance in both compression set and fatigue.

EPDM-based TPVs have good resistance to a broad spectrum of fluid media. They are highly resistant to water, aqueous solutions (including acids and bases), and polar organic fluids. In nonpolar fluids, they retain their physical properties well but can swell significantly. The NBR/PP TPVs have lower swell in nonpolar, hydrocarbon media and merit consideration for service in such environments. These TPVs, however, should not be used in media that are highly acidic or basic.

55.3 Processing

TPVs enable one to exploit the many processing advantages of a TPE. TPVs are fully compounded and simple to process, with short molding cycles. Their processing consumes little energy and permits ready recycling of scrap. Quality control is both improved and more economical than with thermoset rubber. TPVs can be fabricated by processing methods (i.e., blow molding, heat welding, and thermoforming) not suitable for thermoset rubber.

Thermoplastic fabricating equipment should be used in TPV processing. Thermoset rubber fabricating equipment is generally unsuitable for TPVs and other TPEs as well. Before processing, most TPVs should be dried. Molten TPVs should be processed in the 180 to 220°C range under conditions of high shear, since their flow properties are highly non-Newtonian and thus shear sensitive. Injection molding, the most common method of TPV fabrication, is far and away superior to compression molding, which, though possible, is almost never used in commercial practice.

Extrusion of a TPV should be with a thermoplastics extruder (L/D greater than 20:1) and a melt temperature of up to 220°C. Extruders such as those commonly used for PP or polyethylene work well with TPVs. In contrast to thermoset rubber extrusion, the extrudate requires no subsequent vulcanization and simply needs to be cooled from the melt.

Blow molding, commonly used for fabricating hollow articles from thermoplastics, has been exploited widely in TPV processing. It has been found highly useful for molding hollow TPV articles, such as convoluted bellows. Thermoforming and heat welding have also been found useful in TPV fabrication.

55.4 Uses of TPV

Introduced commercially in 1981, TPVs had spectacular growth during the 1980s and 1990s. A 1987 prediction, when worldwide TPV usage was slightly above 10,000 metric tons (MT) per year, projected a 1995 usage of 50,000 MTs. This projection was significantly exceeded, and a TPV consumption level

of 100,000 MT should have been reached between 2000 and 2003. Why has this growth been so great? Perhaps the principal reasons are (1) TPVs are the closest approach of any TPE to the properties and performance of a conventional thermoset rubber, and (2) TPVs permit close-to-optimum exploitation of the economic advantages inherent in the processing of a TPE.

Today's applications of TPVs number well into the thousands, penetrating virtually all major uses of rubber — but with one massive exception, that of pneumatic tires, which consume slightly more than one-half of the rubber produced in the world. In other rubber application areas, TPVs have been eminently successful. A leader in this success has been the automotive segment, where these materials enjoy uses in convoluted protective boots, seals, jacketing, hose, grommets, weather stripping, and numerous other specific parts. TPVs function well in under-the-hood uses where other TPEs are inadequate for the service temperature, which continues to progress upward.

Architectural uses also provide a ready market for TPEs. Hundreds of large buildings around the world now employ window glazing and/or chemical expansion joints extruded from an EPDM/PP TPV. Mechanical rubber goods embrace those uses in which a molded or extruded rubber article is a component part of a useful assembly. Major TPV uses in this area include household appliances, office equipment, toys, and other items requiring the use of boots, bushings, seals, tubing, and other rubber articles.

EPDM/PP TPVs have excellent electrical insulating properties — dielectric constant, resistivity, dielectric strength, power factor — that render them quite suitable for use as primary insulators or as jacketing materials. Electrically conducting wire can readily be coated by crosshead extrusion of a TPV for use in automotive, construction, industrial, appliance, and many other applications.

EPDM/PP TPVs have unusually low toxicity for a rubber. This explains their broad utility for direct contact with foods and potable water. TPVs have also found use in health care applications in hospitals and physician's offices and in pharmaceutical applications involving direct contact with preparations to be taken orally or injected into the bloodstream.

56

Olefinic Thermoplastic Elastomers

56.1	Introduction	56-1
56.2	Properties	56-2
	Limitations of TPOE Compounds	
56.3	Usage	56-2
	Coating Applications • Primer Systems	

Jesse Edenbaum
Consultant

56.1 Introduction

Olefinic elastomers based upon ethylene-propylene and/or ethylene-propylene-diene monomer rubbers (EPR or EPDM) are thermoplastic by virtue of their alloying with isotactic crystalline polypropylene and/or high-density polyethylene (HDPE). These products are produced by high intensity mixing in Banburies continuous mixers, and extruders.

The olefin plastics are either pellets or reactor beads, while the rubber can be in bale form for mixing in a Banbury. For mixing in an extruder or continuous mixer, the rubber must be converted to a pellet or granular particle. The high intensity mixing results in a simultaneous comminution of the polymers, with the olefin as the continuous phase and the rubber the dispersed phase. Thus the blend is thermoplastic: the blend viscosity is largely controlled by the choice of polyolefin, and the elasticity is controlled by the rubber segment of the blend.

Thermoplastic olefinic elastomers (TPOEs) can be manufactured by blending alone, which limits the elevated temperature properties of the mix, or by blending and cross-linking *in situ* during the compounding operation. When the compounds are cross-linked, the elevated temperature properties are enhanced. The processing “nerve” of the blend is reduced, and thinner, more complex extruded products are possible.

The polymer compound is made broadly versatile by the inclusion of a great variety of additives. In addition to the initial choice of polymers, the ratio of plastic to rubber (hard to soft segment) controls the hardness of the compound to some degree. The use of high permanence petroleum oils that function as permanent plasticizers assists in the control of hardness. Flexural modulus or toughness is more readily controlled by the rubber polymer. The combined use of these ingredients results in a wide variety of physical properties.

Fillers, such as fine particle calcium carbonates, clays, talc, and silicas are all usable. TPOE compounds cannot be made to be clear; but very pale, pastel colors are possible. Translucent colors are possible in thin sections. For outdoor use, protection against ultraviolet radiation is needed. The general-purpose compounds are not flame retardant inherently and require a package of halogen donor additives to pass any necessary specifications.

56.2 Properties

TPOE compounds are inherently of high elongation. They retain their elongation over a wide range of hardness, while the tensile properties vary with hardness; that is, the higher the hardness, the higher the tensile strength. Low temperature properties are excellent over a wide range of hardness. Brittle point is well under -60°C . Permanent set tends to be fair, that is, it varies with temperature and increases at elevated temperature, which limits its usefulness under those environments. The cross-linked compounds, which have superior permanent set, form an exception. These compounds generally have excellent ozone resistance, are superb in electrical properties, and have no processibility problems. TPOE compounds, like their derivative compounds, are inherently heat stable and for general-purpose use require a small dose of antioxidant to protect the polymers during processing. When complex products are specified, the protective package is custom designed into the finished compound.

56.2.1 Limitations of TPOE Compounds

Chemical and oil resistance of TPOE compounds is poor. The blended versions are low in compression set at elevated temperatures. Highly cross-linked versions are hygroscopic and must be dried before processing. Because of their high olefinic contents, these polymer blends are not readily decorated. Finishes of any kind require special surface preparation.

56.3 Usage

TPOE compounds are widely used for the injection molding of automotive underchassis parts. Air dams, stone deflectors, and sight shields are some of the parts that are used throughout the world. These parts are colored by pigmentation. The inertness of the compounds allows the use of low cost pigments. Surface coating on an exposed product like sight shields requires priming or the use of a conductive compound before electrostatic paint can be applied.

Wire and cable compounds are typical of a broad use segment of extruded products. The low specific gravity, high dielectric properties, ease of processing, excellent low temperature properties, and good high temperature ratings (90°CUL) allow use for battery booster cables, appliance wire, mining cable, and other primary wire and cable jacketing applications.

High moisture resistance and generally good outdoor use properties and temperature range recommend the use of these compounds for sporting goods such as swim fins, goggles, snorkeling tubes, and bike and other sports grips, as well as various industrial and automotive flaps, knobs, and handles, and many miscellaneous molded product applications.

Other parts that can be extruded include weather strip, flashing, tubing, and a variety of edge finishing. The inertness of these polymers allows contact with many other materials without bleed or transfer, but evaluation before use must always be performed.

56.3.1 Coating Applications

TPOEs do not lend themselves to coating use. These polymer compounds are, like most polyolefins, insoluble in most solvents, and therefore cannot be solution coated onto substrates. They can be coextruded, hardcore backbone, with a flexible edge type of application. They can be hot melt applied as a coating where the properties described are desired. They will stick to most if not all other polyolefins. Thin films can be extruded and then laminated to other olefin plastics or onto paper, board, or cloth.

56.3.2 Primer Systems

For adhesion to TPOE products, flash primer systems such as Seibert Oxidermo or DuPont are recommended. Printing systems also are available from PPG and from many of the industrial paint producers. TPOE products can also be primed by activation of the surface using a benzophenone treatment followed by exposure to ultraviolet light. It is always necessary to evaluate each compound individually. Compounds vary widely, and caution must be used before a finish is accepted.

57

Ethylene Vinyl Alcohol Copolymer (EVOH) Resins

57.1	Polymer	57-1
57.2	Barrier Properties	57-1
57.3	Regulatory Approval	57-4
57.4	Fabrication Methods	57-4

R. H. Foster
Eval Company of America

57.1 Polymer

Ethylene vinyl alcohol (EVOH) resins are hydrolyzed copolymers of vinyl acetate and ethylene. The vinyl alcohol base has exceptionally high gas barrier properties, but it is water soluble and difficult to process. By copolymerizing ethylene with vinyl alcohol, the high gas barrier properties are retained and significant improvements are achieved in moisture resistance and processibility.

A typical reaction for producing EVOH resins is shown on page 57-3. Under proper conditions, this reaction yields a copolymer that is more than 99% hydrolyzed.

[Table 57.1](#) lists the range of EVOH resins presently available.

57.2 Barrier Properties

EVOH copolymers are highly crystalline, and their properties are highly dependent on the relative concentration of the comonomers. Generally speaking, as the ethylene content increases, the gas barrier properties decrease, the moisture barrier properties improve, and the resins are processed more easily (see [Table 57.2](#)).

The presence of a hydroxyl group in the molecular chain renders the gas barrier properties of the EVOH resins sensitive to moisture. As the moisture content of the resin increases, the gas barrier properties decrease. However, by proper use of companion materials in a multilayer structure, this effect can be minimized.

[Table 57.3](#) shows how the combination of different materials can be used to minimize the moisture content of the EVOH and maintain superior gas barrier properties. In this article, any aqueous-based food is considered to be 100% relative humidity; the storage environment is shown at relative humidities of 65 and 85%.

TABLE 57.1 Properties of Ethylene Vinyl Alcohol Resins

Property	Range
Melt index	0.7–15.0 g/10 min
Density	1.12–1.21 g/cm ³
Melting point	156–191°C
Crystalline temperature	134–167°C
Ethylene content	27–48 mol%

TABLE 57.2 Barrier Properties

EVOH (mol% Ethylene)	Gases ^a				Moisture ^b
	O ₂	CO ₂	N ₂	He	
27	0.01	0.04		7.7	6.8
32	0.02	0.05	0.002	15.5	3.8
38	0.03	0.10	0.003	25.5	2.1
44	0.07	0.20	0.005	40.0	1.4
48	0.11	.032	0.007	52.0	1.4

^a In cubic centimeter-mils per 100 in.² 24 hours per atm at 20°C and 65% relative humidity.

^b In gram-mils per 100 in.² 24 hours per atm 40°C and 90% relative humidities.

TABLE 57.3 Oxygen Transmission (O₂TR) Rate versus Barrier Layer Relative Humidity

Film Structure ^a			Temperature (°C)	Inside Package			
				Outside (65%RH)		Outside (85%RH)	
Outside: 0.8 mil	Barrier: 0.6 mil	Inside: 2 mils		RH of Barrier (%)	O ₂ TR ^b (Barrier %)	RH of Barrier (%)	O ₂ TR ^b (Barrier %)
PP	27 mol% EVOH	LLDPE	5		0.03		0.05
			20	79		88	0.10
PP	27 mol% EVOH	PP	5		0.02		0.04
			20	75		86	0.07
PET	27 mol% EVOH	PP	5		0.02		0.04
			20	72		84	0.07
Nylon	32 mol% EVOH	LDPE	5		0.01		0.02
			20	67		81	0.05
PP	32 mol% EVOH	LDPE	5		0.05		0.05
			20	79		88	0.12
PS	44 mol% EVOH	LDPE	5		0.05		0.05
			20	70		83	0.27

^a PP, polypropylene; PET, polyethylene terephthalate; PS, polystyrene.

^b In cm³ per 100 in² per 24 hours per atm.

TABLE 57.4 Flavor Barrier Data (Citrus and Tropical Flavors)^a

Film ^b	Thickness (μm)	Duration					
		1 h	2 h	15 h	1 Day	4 Days	35 Days
EVOH-32	15	A	A	A	A	A	A
EVOH-44	15	A	A	A	A	A	A
BO EVHO	15	A	A	A	A	A	A
BO Nylon	15	A	A	B	B	B	B
OPP	20	B	B	C	C	C	C
PVDC	25	A	A	B	B	B	B
LDPE	50	D	D	D	D	D	D

^a Key: A, no detection; B, faint flavor; C, partial flavor; D, flavor clearly distinguished.

^b BO EVOH, biaxially oriented EVOH; BO Nylon, biaxially oriented nylon; OPP, oriented polypropylene; PVDC, polyvinylidene chloride; LDPE, low density polyethylene.

TABLE 57.5 Flavor, Aroma, and Solvent Barrier Properties^a

Resin ^b	Allyl Sulfide: Garlic-Food Type (Croutons, Snacks, Salad Dressings)	Acetic Acid Vinegar-Food Type (Cheddar Cheese, Snacks, Condiments)	Ethylene Acetate: Laminating Adhesive Solvent Residual	Toluene: Printing Ink Solvent Residual	Methyl Ethyl Ketone Printing Ink Solvent Residual
HDPE-Nylon-EVa	0.00008	0.92	0.03	0.02	0.005
HDPE-EVOH-EVA	0.00075	0.035	0.0043	0.007	0.035
PVDC-PP-PVDC	0.0068	1.98	0.34	0.22	3.09
OPP-HDPE-EVOH-EVA	0.00076	1.40	0.15	0.00003	0.09
EVA-Glassine-PVDC	0.50	4.18	6.47	3.15	15.1

^a g/24 h, m², 100 pm at 70°F.

^b HDPE, high-density polyethylene; EVA, ethylene vinyl acetate; PVDC, polyvinylidene chloride; OPP, oriented polypropylene.

In addition to being outstanding as barrier properties, EVOH resins offer excellent barriers to a variety of flavors, aromas, and solvents (see Table 57.4 and Table 57.5).

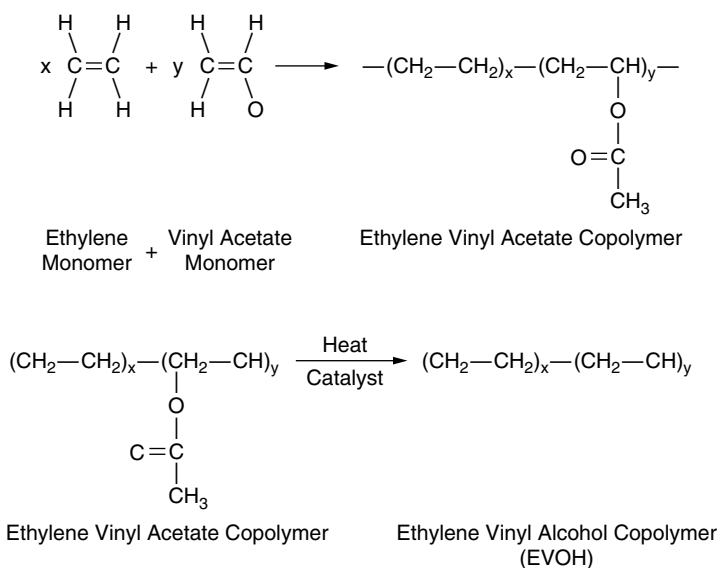

TABLE 57.6 Properties of Three Commercial Resins

Property	Eval EVOH Resin Grade		
	F101	H101	E105
Maximum service temperature °C	240	240	250
Melting point °C	181	175	164
Glass transition temperature °C	69	62	55
Tensile strength, psi	11,220	9,400	8,520
Tensile yield strength, psi	10,365	8,300	7,385
Elongation at break, %	230	280	280
Young's modulus, psi	385,000	345,000	298,000
Ethylene content, mol%	32	38	44

TABLE 57.7 Barrier Applications

Fabrication Process	Application	Structure ^a
Lamination or extrusion coating	Food kits, pouches, dry mixes, snacks	BOB/barrier/LLDPE Nylon/PET/barrier/LDPE OPP/barrier/LDPE Paper/HDPE/barrier/EVA
Coextrusion coating	Aseptic packaging Juices and other drink products	LDPE/Paper/barrier/PP/Surlyn LDPE/Paper/LDPE/BARRIER LDPE/Paper/LDPE/barrier LDPE/Barrier

^a BON, biaxially oriented nylon; LLDPE, linear low-density polyethylene; PET, polyethylene terephthalate; LDPE, low-density polyethylene; OPP, oriented polyethylene; HDPE, high-density polypropylene; EVA, ethylene vinyl acetate; PP, polypropylene.

It is these exceptional barrier properties that permit the use of extremely thin layers of EVOH resins in coextrusion-coated structures for gable top drink cartons, single-serve drink cartons, dry mixes, etc.

In addition to excellent barrier properties, EVOH resins have very good mechanical and thermal properties (see Table 57.6).

57.3 Regulatory Approval

EVOH resins meet U.S. Food and Drug Administration requirements for direct food contact as specified in The Code of Federal Regulations (21 CFR, Section 177.1360), issued September 21, 1982, for all temperatures through 100°C. The use of EVOH resins as an indirect food contact layer also meets the FDA requirement for high temperature retort applications.

Table 57.7 lists packaging structures produced using various fabrication methods.

When using EVOH resins in multilayer structures, it is necessary to use an adhesive to gain adequate bonding strength to the other polymers or substrates. Commercially available adhesive resins such as Plexar, Admer, Modic, or Bynel are suitable for use with EVOH resins. EVOH resins are produced domestically by EVAL Company of America (EVAL resins) and E. I. DuPont (Selar OH resins).

57.4 Fabrication Methods

There are three basic methods of using EVOH to provide the barrier layer in multilayered structures. These are as follows:

- Using them for coextruded structures in which EVOH resins are combined with polyolefins or polyamides to form the structure

- Using EVOH films that are laminated to other substrates or coated with other materials
- Coating various substrates or monolayer containers with EVOH resins

Generally speaking, coextrusion or lamination is used for structures in which the EVOH layer must be protected from the effects of moisture. When packaging aqueous-based products (tomato ketchup, barbeque sauce, etc.), various combinations of less costly polyolefins are used to provide structural strength and to prevent excess moisture from reaching the EVOH barrier layer and lowering gas barrier properties.

Coating techniques can also be used to produce multilayered structures by the use of either multiple coatings or coextrusion coating. The resulting structure will be very similar to a coextruded structure.

Spray, dip, and/or roller coating of EVOH resins are used to produce containers for carbonated beverages or to establish a barrier to solvents, aromas, or odor. Manufacturers of such products include Kuraray Company Ltd. (Eval resins) and Nippon Gohsei (Soarnol resins) in Japan and Solvay (Clarene resins) in Europe.

58

Elastomeric Alloy Thermoplastic Elastomers

Charles P. Rader

Advanced Elastomer Systems, L.P.

58.1 Properties.....	58-1
58.2 Processing.....	58-2
58.3 Uses of Elastomeric Alloys.....	58-2

A thermoplastic elastomer (TPE) is a material with the functional performance of a thermoset rubber but the processibility of a conventional thermoplastic. Elastomeric alloys (EAs) are a generic class of TPEs composed of two or more polymer systems between which a synergistic interaction has arisen, giving rise to properties significantly better than those expected from a single blend of these polymer systems. EAs are medium performance, moderate cost TPEs.

Figure 58.1 compares the generic classes of TPEs by performance and by cost. Thus, EAs have higher performance and cost than either the styrenic or olefinic blend TPEs, whereas thermoplastic polyurethanes, copolyesters, and polyamides cost more and give higher performance than EAs.

58.1 Properties

Elastomeric alloys may have either two phases or a single phase. A two-phase EA is an alloy of vulcanized rubber with a thermoplastic polyolefin. The alloying of these two polymeric phases gives rise to higher ultimate tensile strength, improved retention of physical properties at elevated temperature, improved resistance to hydrocarbon fluids, lower compression set, and lower tension set. These properties thus qualify EAs for applications for which a simple rubber-polyolefin blend would be inadequate.

The need for a compatibilizer to stabilize intermingling of the rubber and polyolefin phases of a two-phase EA will be determined by their relative solubility parameters. Having essentially equal solubility parameters for the two phases eliminates the need for a compatibilizer, whereas a significant difference between the solubility parameters requires a compatibilizer.

Single-phase EAs are said to consist of an ethylene vinyl acetate-acrylate ester-polyolefin blend with significant plasticizer content. They may or may not contain carbon black.

Two-phase EAs range in hardness from 55 Shore A to 50 Shore D. EAs derived from ethylene propylene diene monomer (EPDM) rubber and polypropylene have a service temperature range from -60°C to 135°C in air. Two-phase EAs from nitrile rubber and polypropylene have a service temperature ranging from 40°C to 125°C in air. The specific gravity of single-phase EAs ranges from 1.2 to 1.3, and that of two-phase EAs from 0.9 to 1.0. Although the properties of an EA are quite competitive with those of a thermoset rubber, the ultimate tensile strength is generally significantly lower relative to a thermoset

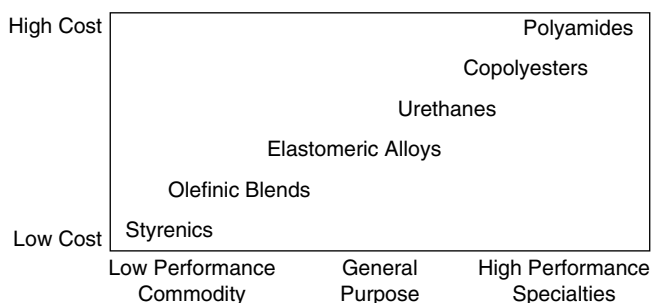

FIGURE 58.1 Comparison of performance and cost of the generic classes of thermoplastic elastomers.

rubber of the same hardness. This difference is generally of little consequence in actual service, as very few rubber articles are used at an elongation anywhere close to the ultimate limit.

The fatigue resistance of two-phase EAs is truly outstanding, and the compression and tension set are competitive with those of thermoset rubber stocks specially compounded for these properties. This is an unusual combination of properties for a specific rubber composition.

Fluid resistance of EPDM rubber based two-phase EAs is quite broad. These materials are extremely resistant to water, aqueous solutions (including acids and bases), and a variety of polar organic fluids. In nonpolar, hydrocarbon fluids, these materials retain their physical properties quite well; however, they do experience significant swell. If low swell is a criterion for adequate service with an EA, the use of one based on nitrile rubber and polyolefin is recommended. These alloys give much lower swell in hydrocarbon fluids than those based on EPDM rubber.

58.2 Processing

EAs capitalize on the numerous processing advantages of a TPE. For example, in addition to being fully compounded, EAs are simpler to process, have shorter processing times, permit recycling of scrap, have lower energy consumption, allow tighter, more economical quality control, and make possible the use of processing methods not available for thermoset rubber fabrication.

EAs require drying before processing, in contrast to thermoset rubbers. The equipment and methods used for fabricating thermoplastic are commonly used with EAs, whereas thermoset rubber fabricating equipment is generally unsuitable. These materials are highly non-Newtonian in flow properties, being extremely sensitive to shear. Two-phase EAs are normally processed with a melt temperature in the 180 to 220°C range, and MPRs in the 160 to 190°C range.

Extrusion of an EA requires a thermoplastics extruder ($L/D > 20 = 1$) with the capability of achieving melt temperatures up to 220°C. These materials can readily be injection molded with the same equipment used for polyethylene and polypropylene, with cycle times in seconds, rather than the minutes required for a rubber vulcanization.

Blow molding, a method commonly used for molding hollow articles from thermoplastics, is unsuitable for molding thermoset rubbers. It is highly useful for molding a variety of hollow articles (e.g., convoluted bellows) from EAs. Thermoforming and heat welding are other fabrication methods, unsuitable for use with thermoset rubber, which have been found to be extremely useful for fabricating articles from EAs.

58.3 Uses of Elastomeric Alloys

Introduced commercially in 1980, EAs have experienced spectacular growth during the 1980s. In 1987, their use exceeded 10,000 metric tons worldwide.

These materials have been especially well received by the automotive industry, with typical uses being hoses, jacketing, grommets, seals, convoluted boots, and weather-stripping. They are prime candidates for under-the-hood uses, where the temperatures are progressively increasing.

EAs function nicely as a material for window glazing and expansion joints in architectural applications. More than 50 major North American buildings have utilized the unique properties of EAs. Mechanical rubber goods include those featuring a rubber article as a component part of a useful assembly. Typical commercial uses of EAs in this area include household appliances, office equipment, toys and other articles requiring the use of seals, boots, tubing, and bushings, and other rubber articles produced by extrusion, injection molding, or blow molding.

EAs from EPDM rubber and polypropylene have excellent electrical properties — dielectric strength resistivity, power factor, dielectric constant — that render them highly suitable for use as a primary electrical insulator, as well as a jacketing material. Electrically conducting wire can be coated by crosshead extrusion of an EA and can be used in automotive, appliance, construction, and many other applications.

The low toxicity of two-phase EAs recommends them highly for applications involving direct contact with foods and potable water. These materials also offer much promise for medical applications embracing direct contact with pharmaceutical preparations to be taken orally or injected into the bloodstream.

59

Polyvinyl Chloride and Its Copolymers in Plastisol Coatings

59.1	Introduction	59-1
59.2	Formulation	59-1
	Resins • Plasticizers • Solvents • Other Additives	
59.3	Plastisol Manufacturing Procedures	59-4
	Equipment • Quality Control • Coating Application • Continuous Thin Film Applications	

Jesse Edenbaum
Consultant

59.1 Introduction

PVC plastisols are liquid dispersion systems of polyvinyl chloride and/or PVC copolymer resins in compatible plasticizers. The liquids vary in viscosity from thin milklike fluids to heavy pastes that have the consistency of molasses.

The lowest viscosity products are generally used for spray coatings and some paper and fabric coatings, while the higher viscosity products are often utilized in dipping, slush molding, rotocasting, and other ore specialized procedures.

59.2 Formulation

Viscosity of plastisol is controlled by formulation techniques, and it is often kept low by the addition of inactive diluents such as odorless mineral spirits. If more than minor amounts of diluents are used, the product is often referred to as an organosol.

These products share a common compounding technology. The primary components are the dispersion-grade resin, plasticizers, PVC stabilizers (which are common to all PVC), and assorted fillers, pigments, and a wide variety of additives to control properties of the product in storage, during processing, and in the finished state. A typical plastisol formulation is shown in [Table 59.1](#).

59.2.1 Resins

PVC dispersion resins are very fine particle size products made by emulsion polymerization and finished by the spray drying technique. These paste resins are characterized by their molecular weight, particle size, and shape. They are predominantly homopolymers, but there are also a wide variety of copolymers made with polyvinyl acetate as the comonomer. The comonomer content will normally vary from 3 to 10%. Other comonomers are sometimes used.

TABLE 59.1 Formulation for a Typical Plastisol

Component	Phr Level Range ^a
PVC primary dispersion resin	60–100
PVC blending resin	0–40
Plasticizers	
Primary, secondary, stabilizing	30–120
Fillers	0–100
Pigments (color)	0.1–5
Stabilizers	0.5–5
Others	As needed

^a Phr (parts per hundred resin) is the normal manner of expressing PVC formulations.

High molecular weight resins give products with high physical properties and good viscosity stability, depending on the plasticizer used. The particle size of the resin is generally between 0.5 and 2.0 μm . Particle size and shape control the surface area, and a highly irregular surface area allows for faster absorption and more rapid viscosity increase. Copolymer resins speed fusion and assist adhesion. The molecular weight of the resins rates directly to the speed of fusion and physical property development. The higher the molecular weight, the slower the fusion and the longer the time and/or the higher the temperature needed for maximum physical properties.

Blending resins are made by the emulsion process, by modified emulsion, and by standard suspension procedures, some are made by the mass polymerization method. Blending resins are characterized by larger particle size and very low plasticizer absorption. They are used to reduce cost, decrease plastisol viscosity, and aid in the release of air. They help control the finish and are used where a matte surface is desirable. They are usually lower in molecular weight than the primary resins, and one disadvantage is their tendency to settle out if the plastisol viscosity is too low.

59.2.2 Plasticizers

Plasticizers are liquids that provide mobility to the plastisol system. They are of primary significance, and they are selected first when formulating. Plasticizers differ in the permanence characteristics they impart to the finished product. The blend of plasticizers also will assist in the control of viscosity and its stability, and in the fusion characteristics of the finished plastisol. The plasticizers are the same as used in dry (pellet or dry blend) compounding. The finished compounds are the same with regard to permanence, weathering, and chemical and electrical properties.

Plasticizers are high boiling, chemically stable, organic esters. They are derivatives of phthalic anhydride and adipic, sebacic, trimellitic, or phosphoric acids. They are esters prepared in condensation reactions with alcohols of chain lengths from hexyl through tridecyl and mixtures thereof.

Initially, the viscosity of the plasticizer strongly correlates with the viscosity of the plastisol. Upon aging, however, the viscosity increases depending on the resins chosen and the activity or solvency of the plasticizer. The higher the plasticizer/resin ratio, the lower is the rate of viscosity rise.

These ester plasticizers can be rated according to their activity in the following manner. Phthalate esters are the fastest fusing and solvating. The lower the alcohol chain, the more rapid is the fusion and the poorer the viscosity stability. Straight chain or Alfol alcohol esters have greater viscosity stability at the same carbon chain length. Thus, normal octyl phthalate will provide greater viscosity stability than dioctyl phthalate (DOP), the di-2-ethylhexyl phthalate. Fusion time and temperature comparisons are much closer and virtually indistinguishable.

Adipic acid esters follow the same alcohol chain length rules as do all other plasticizers. Aromaticity plays a significant role in fusion and viscosity stability. Comparing butylbenzyl phthalate (BBP) to DOP and diisodioctyl phthalate (DIDP) results in the following order: BBP fuses faster than DOP, which is faster than DIDP. The higher the aromaticity, the poorer is the viscosity stability.

Polymeric plasticizers based on linear dibasic acids such as adipic, sebacic or azelaic acids and esterified with dihydric glycols, such as propylene and butylene, of varying molecular weight, serve to supply high performance and oil and solvent resistance to plastisols. Care must be taken in formulation because these plasticizers are normally of medium to very high viscosity.

The epoxy types of plasticizer such as epoxidized soybean oil (EPO), and butyl epoxy tallate are widely used for stabilizer boosters. The tallate provides better viscosity control than the EPO. The EPO, however, is nontoxic.

Secondary plasticizers of petroleum oil derivation and other origins are utilized to control viscosity and viscosity stability, and to provide special effects such as harder exposed surfaces by allowing for fugitive plasticizers in top coats. Such volatility can also be provided by solvents. These pastes are those referred to as organosols.

59.2.3 Solvents

Solvents and diluents can be the aliphatic mineral spirits previously mentioned. They lower viscosity and extend shelf life by retarding the viscosity increase due to the solvation of the resin, but sometimes these agents may reduce viscosity to a point at which settling can occur. Blends of diluents and secondary plasticizers are advantageous for control of those conditions.

59.2.4 Other Additives

Stabilizers must always be liquids or pastes when used in plastisols. They are barium, cadmium, or zinc containing products. For nontoxic products, calcium zinc soap pastes are used. Leads are rarely used, and octyl tins are used for some special applications.

Fillers are non-oil-absorbing inert minerals such as calcium carbonate, talc, and some clays. Fillers are used to lower cost by extension of the total formulation. They are usually very fine particle products. They also can add dullness to the surface finish, impart a dry hand, reduce tackiness, and be used to control the viscosity. Fillers must be capable of being readily deagglomerated by the shear exerted in the plastisol preparation process.

Pigments are used to color plastisols and organosols, and any pigment suitable for general PVC use is usually satisfactory for paste technology. However, pigments must also be added as dispersion. They must be dispersed in plasticizer carriers on three-roll mills, sand mills, or at least, using a high speed disperser such as a Cowles dissolver, where the high shear at the blade tip will deagglomerate and disperse the pigment.

Other compounding ingredients used in plastisols are of lower volume usage but serve to expand the versatility of the products. Surfactants are often added to control the viscosity and to help the release of air bubbles during coating procedures. They also assist in fabric penetration, where this is required. They are mostly nontoxic surfactants derived from polyethylene glycol.

Thixotropic agents control strike-through and fabric penetration, as well as viscosity in various processes. They alter the flow for spray applications and dipping by increasing low shear viscosity and allowing high flow under high shear. Lubricants are added to function as release agents during casting on paper and slush molding. They also control surface tack of cast films.

Blowing agents are added (as pastes) in upholstery and flooring applications. The blowing agents are catalyzed by the use of some of the stabilizers that contain zinc. The most widely used blowing agent is azodicarbonamide. This is produced in various particle sizes, which help control the blowing temperature. Density of the finished product is controlled by using combinations of blowing agent level, varying the particle size of the blowing agent and then blowing agent catalyst, and compound gelation control by careful selection of the plasticizers and resins. This procedure results in closed-cell foams. Open-cell foams are produced when the blowing occurs at the gelation temperature.

In addition, ultraviolet and weathering protection agents, flame retardants, and fungicides are all useful where required.

59.3 Plastisol Manufacturing Procedures

The basic mixing procedure for plastisols can be performed in various forms of equipment. The procedures are generally alike regardless of the size or type of equipment used. In the typical process procedure that follows, all nonliquid ingredients must be added as paste dispersions except for the bulk fillers and resins. Care must be exercised to rinse containers with some of the weighed, withheld plasticizer:

1. Add three-quarters of the total liquids to the mixer.
2. Start the agitator.
3. Add the solids in the following order:
 - Fillers
 - Blending resins
 - Dispersion resins and other dry ingredientsThe dry powders should be added slowly onto the surface, allowing them to be pulled into the vortex.
4. The temperature of the mixture should not be allowed to rise above 90°F.
5. The mixture must go through a high shear stage to deagglomerate all clumps. When a smooth creamy state has been reached, the balance of the paste materials is added and, lastly, the balance of the liquids. Some additional mixing may be necessary.
6. Deaeration is usually required, except for some foam applications. Total time consumed depends on formula, volume, and equipment.

59.3.1 Equipment

Simple mixers, from a 55 gal drum, high speed mixer with an intensive mixing blade, to 1000 gal tank mixing equipment with multiple variable speed mixers with built-in deaeration systems are used for plastisol preparation.

59.3.2 Quality Control

Quality control tests have to be performed on the liquid systems as well as the fused products. Tests on the paste are unique to liquid systems, but controls of the fluxed PVC product are the same as those performed on other solid polymers.

Tests are performed as necessary to control the manufacturing processes as well as the product. Finished product specifications are agreed upon between the producer and the customer. Physical properties of the finished films or coatings can be tensile strength, elongation, hardness, low temperature flexibility, high temperature performance, coating and/or processing speed, yield, color, finish, and many more. These liquid systems are complex due to their conversion from a liquid state to a solid during the manufacturing process.

59.3.3 Coating Application

Plastisols and organosols are widely used as coatings. They can be applied by many procedures. Heavy-walled products, such as dip-coated tool handles, dishwasher racks, plating racks, and decorative or protective coatings for work and garden gloves, can be produced by hot and cold dipping. In the hot dip process, a permanent coating is made by priming the metal to be coated and then preheating the product before dipping it into the plastisol. Viscosity control and pseudoplasticity of the dipping plastisol allow the application of a single heavy coat, which is then oven fluxed, resulting in a permanent coated product. Dishwasher racks and plating racks are made this way.

Gloves are cold dipped and the weight of the coating and penetration are controlled by formulation and viscosity. Thixotropic plastisols control the weight of the coatings. Gelation and fluxing times and temperatures are controlled by the resins and plasticizers selected.

Specialty products such as certain catheters and odd-shaped tubular products can be hot dipped into plastisol by preheating a dipping form, dipping repeatedly as needed, and then fluxing, cooling in water, stripping the product from the dipping form, and repeating the process, reusing the form.

In slush molding, conveyORIZED molds are heated and filled with plastisol. After a controlled time span, the plastisol is poured from the molds into a recirculating supply tank. The molds have a gelled coating on the inside walls. They go through an oven to complete the fluxing or fusion and are water cooled; then the product (a rain boot typically) is stripped from the mold, trimmed, inspected, and packed. The mold is cleaned and the cycle repeated.

Encapsulation coating is done on small electrical parts, metal products, and other applicable items. Thin to heavy coatings are available. Products can be primed if good adhesion is required. Products are cold dipped, and the fluxing is performed according to the coating thickness.

Spray coating is used for products of irregular shape. Automobile kick panels are plastisol spray coated. Again, priming is performed when needed. The product can be preheated or not. Spray plastisols are often diluted with solvent. Viscosity controls age during spraying and gelation. Other applications are metal outdoor furniture, appliances, and many protective coating applications.

59.3.4 Continuous Thin Film Applications

The largest use of plastisols and organosols in coatings is for fabric and other porous substrate coatings and impregnation. There are myriad applications for clothing, such as raincoats, pocketbooks, shoe fabrics, and gloves. Coated fabrics serve as leather replacements for luggage and upholstery for automobiles and homes, and for wall covering with and without textile backing. Industrial protective coverings such as awnings are made from PVC paste coated fabrics in many different weights.

There are many applicable procedures for coating these materials onto a flexible substrate. In knife coating, for example, a liquid is dispensed onto a moving material web, and the clearance between the knife edge and the web controls the application thickness. Knife coating equipment has many variations that contribute to the versatility of the process.

Direct roll coating, three-roll, nip-fed reverse roll coaters, and variations on these are also used. The web can be embossed and also laminated in-line. Plastisols perform as lamination adhesives using these procedures. Plastisols can also be used to totally impregnate heavy webs by the dip saturation procedure.

Almost all the products described can be in-line embossed, or further decorated by printing, flocking, and laminating. Most of the products described are fused or fluxed to their final physical properties in-line except those that are to be laminated or assembled into a multilayered product.

There are many film products made by spread coating of these pastes. Adhesive-coated films for decorative uses, decals, wall covering, mat casting, and floor coverings can be manufactured this way. Again, these products can be printed, embossed, decorated further, or laminated.

In every instance, the properties of the finished product are controlled by the plasticizer system used. The application technique is further controlled by the viscosity characteristics which are, in turn, controlled by the resins selected, and the balance of the formulation enhances the manufacturing process efficiency.

Polyvinyl Acetal Resins

60.1	Chemistry and Manufacture	60-1
60.2	Availability, Economics	60-1
60.3	Properties	60-2
	Reactivity and Compatibility • Physical and Chemical Properties • Solution Viscosity • Plasticizers • Toxicology 4	
60.4	Surface Coating Applications	60-9
	Polyvinyl Butyral • Polyvinyl Butyral Dispersions • Polyvinyl Formal	
	References	60-11

Thomas P. Blomstrom
Monsanto Chemical Company

60.1 Chemistry and Manufacture

The polyvinyl acetals are a family of high molecular weight polymers prepared by the mineral acid catalyzed acetalization of polyvinyl alcohol. The chemistry of preparation is outlined in Equation 60.1, where R can be H or any of a wide variety of organic radicals.

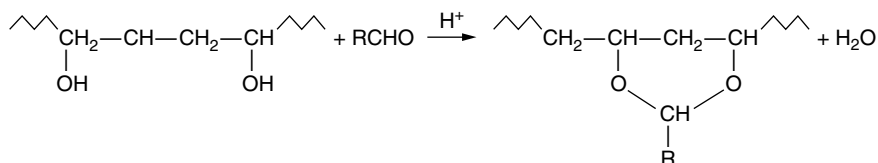

While many polyvinyl acetals have been prepared,^{1,2} the only commercially important polymers are the formal (R = H) and the butyral (R = *n* - C³H⁷), derived from the acetalization of polyvinyl alcohols with formaldehyde and *n*-butyraldehyde, respectively. The generalized structure of the polyvinyl acetal molecule is shown in Figure 60.1. Molecular weights, weight average molecular weight (M_w), range from about 25,000 to 150,000 for the formal and from 40,000 to 250,000 K for the butyral, depending on grade. The three chemical moieties are randomly distributed along the polymer chain. While simple in concept, the actual commercial preparation of these polymers is quite complex, requiring many processing steps. For the formal and the majority of the butyral resins currently of importance in the coating industry, these steps include extensive solvent and by-product purification and recovery operations. A schematic process flow diagram for the manufacture of a typical polyvinyl acetal, polyvinyl butyral (PVB), is shown in Figure 60.2.

60.2 Availability, Economics

Monsanto is the only U.S. producer of polyvinyl formal, under the brand name of Formvar. The resins are available in the United States as white to pale buff-colored, free-flowing powders, in fiber drums at

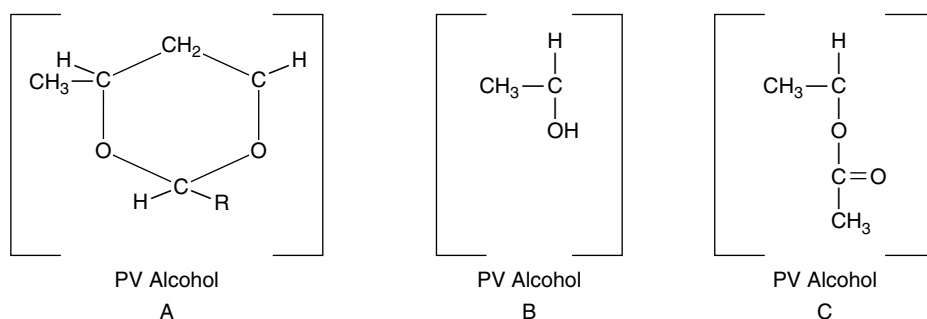

FIGURE 60.1 Generalized structure of the polyvinyl acetyl molecule.

about 150 lb net, costing \$5.60 to \$6.80 per kilogram (10 April 88) depending on grade and quantity. Outside the United States, polyvinyl formal is supplied by Shin Nippon Chisso in Japan as Vinilex F, by Wacker Chemie in Germany as Pioloform F, and by Siva in Italy.

Monsanto, which produces a full line of PVBs has production facilities both in the United States and in Europe. In addition to the grade used exclusively for Monsanto's safety glass interlayer sheet, Saflex, a wide range of specialty grades known as Butvars are available for a variety of coatings applications. Also in the United States, Union Carbide supplies a limited range of coatings grade polyvinyl butyral known as vinyl Butyral Resins XYHL and XYSG. DuPont produces the resin for captive use in its safety glass interlayer sheet, Butacite. In Europe, PVB is available from Monsanto, Hoechst, Wacker Chemie, Dynamit Nobel, and Rhône Poulenc. In Japan, a range of grades is produced by Sekisui Chemical Company, while Chang Chun produces the resin in Taiwan. In the United States, PVB resins are available as white, free-flowing powders at 135 to 155 lb net in fiber drums at about \$6.60 to \$9.00 per kilogram, depending on grade and quantity.

Monsanto also produces an aqueous dispersion of a plasticized high molecular weight polyvinyl butyral known as Butvar dispersion BR. This material air dries to a tough, transparent film exhibiting low to moderate adhesion to most surfaces; thus, it is useful for, among other applications, removable protective coatings and textile sizing. This material is available in steel drums at about \$4.45 to 4.70 per kilogram (wet), 50 to 52% solids basis.

Worldwide production of polyvinyl formal resin is estimated at 3500 to 4500 metric tons annually. Approximately, 45,000 to 50,000 metric tons of polyvinyl butyral resin is produced in the free world each year, the majority going into the production of safety glass interlayer. Production figures for polyvinyl butyral dispersion are not available.

60.3 Properties

60.3.1 Reactivity and Compatibility

In general, the polyvinyl acetals are characterized by toughness and excellent adhesion to a wide variety of surfaces. They are resistant to most nonpolar solvents and to attack by both acids and bases, although they are slowly attacked by strong aqueous acids. Their resistance to hydrocarbons and mineral oils is outstanding. Because of the residual hydroxyl groups in the polymers (Figure 60.2), they are readily cross-linked with a variety of widely available cross-linking reagents that react with hydroxyl. Examples of the more common cross-linking reagents are dialdehydes and phenolic, amino, isocyanate, and epoxy functional resins. The butyral shows limited compatibility with other resins (e.g., alkyd, polyvinyl chloride, silicones, urea- and melamine-formaldehyde, cellulose acetate butyrate, and ethyl cellulose) and excellent compatibility with nitrocellulose, epoxy, phenol-formaldehyde, isocyanate, and some rosin ester derivatives. The formal, being more polar than the butyral, shows more limited compatibility with other resins. It is fully compatible with most common isocyanate and epoxy resins, and shows limited compatibility with alkyd, phenolic, melamine- and urea-formaldehyde resins, and silicones.

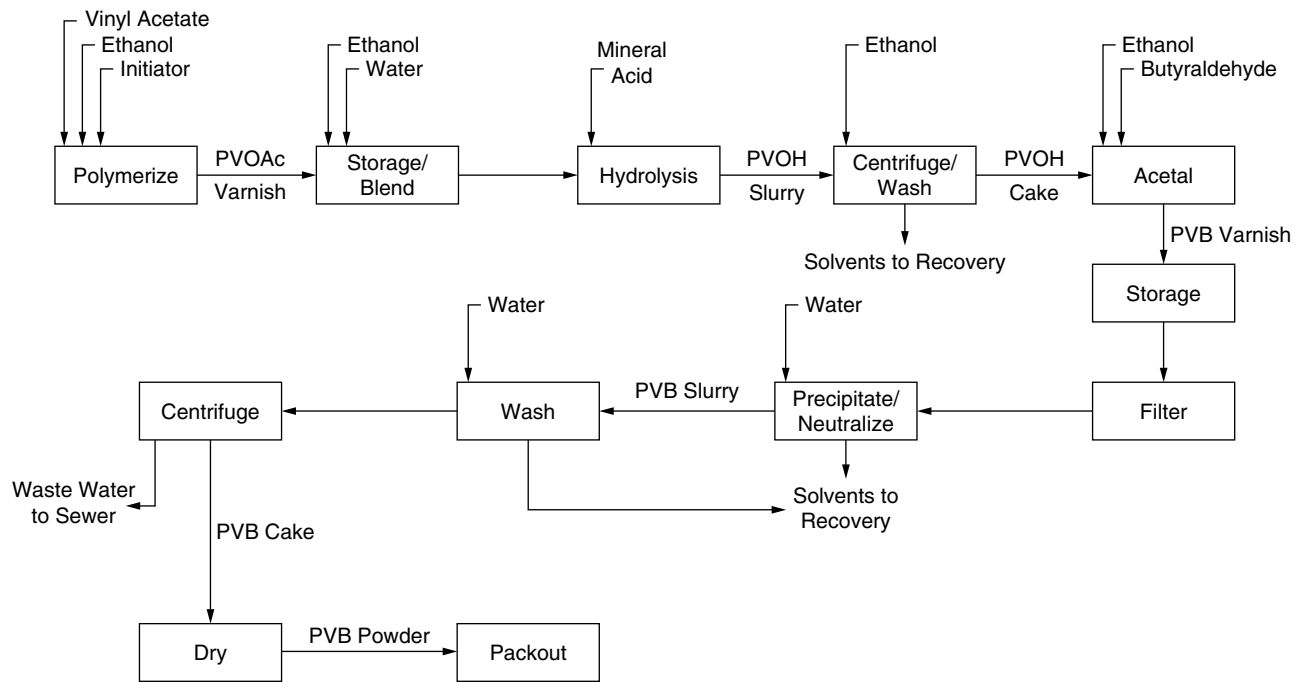

FIGURE 60.2 Process flow diagram of a typical polyvinyl acetyl, polyvinyl butyral molecule.

TABLE 60.1 Typical Physical and Chemical Properties of Butvar Polyvinyl Butyral Resin

Properties	ASTM Method ^a	Butvar Resins						
		White, Free-Flowing Powder						
		B-72	B-74	B-73	B-73	B-79	B-90	B-98
Physical Form								
Volatiles, maximum as packed, %		3.0	3.0	3.0	5.0	5.0	5.0	5.0
Molecular weight (weight average $\times 10^{-3}$)	(1)	170–250	120–150	90–120	90–120	50–80	70–100	40–70
Solution viscosity 15% by wt, mPa.s	(2)	7000–14,000	3000–7000	1000–4000	500–1000	100–400	600–1200	200–400
10% by wt, mPa.s	(2)	1600–2500	800–1300	400–1000	200–450	75–200	200–400	75–200
Specific gravity 23°/23° (± 0.002)	D792–50	1.100	1.100	1.100	1.083	1.083	1.100	1.100
Burning rate, cm/min	D635–56T	2.5	2.5	2.5	2.5	2.3	0.9	2.0
Refractive index (± 0.0005)	D542-50	1.490	1.490	1.490	1.485	1.485	1.490	1.490
Water absorption (24 h), %	D570–59aT	0.5	0.5	0.5	0.3	0.3	0.5	0.5
Hydroxyl content, as % polyvinyl alcohol	D1396–58	17.5–20.0	17.5–20.0	17.5–20.0	11.0–13.0	10.5–13.0	18.0–20.0	18.0–20.0
Acetate content, as % polyvinyl acetate	D1396–58	0–2.5	0–2.5	0–2.5	0–1.5	0–1.5	0–1.5	0–2.5
Butyral content, as % polyvinyl butyral, approx	80	80	80	80	80	80	80	
Chemical ^b								
Resistance to								
Weak acids	D543–56T	E	E	E	E	E	E	E
Strong acids	D543–56T	E	E	E	E	E	E	E
Weak bases	D543–56T	E	E	E	E	E	E	E
Strong bases	D543–56T	E	E	E	E	E	E	E
Organic solvents								
Alcohols	D543–56T	P	P	P	P	P	P	P
Chlorinated	D543–56T	G	G	G	F	F	G	G
Aliphatic	D543–56T	E	E	E	F	F	G	G
Aromatic	D543–56T	F	F	F	P	P	F	F
Esters	D543–56T	F	F	F	P	P	F	F
Ketones	D543–56T	F	F	F	P	P	F	F

^a All properties were determined by ASTM methods except: (1) Molecular weight was determined via SEC/LALLS in tetrahydrofuran. (2) Solution viscosity was determined in 15% solutions in 60:40 toluene/ethanol at 25°C, using a Brookfield viscometer. Also in 10% solution in 95% ethanol at 25°C, using an Ostwald viscometer.

^b Key: E, excellent; G, good; F, fair; P, poor

Source: *Butvar/Formvar Brochure*, publication No 6.70E, Monsanto Chemical Company, Plastics and Resins Division, St. Louis, MO.

60.3.2 Physical and Chemical Properties

The physical and chemical properties of Butvar resins are shown in Table 60.1, and the mechanical, thermal, and electrical properties are given in Table 60.2. Table 60.3 gives solubility data for the Butvar resins in a variety of solvents. The physical and chemical properties of the Formvar resins are shown in Table 60.4;

TABLE 60.2 Typical Mechanical, Thermal, and Electrical Properties of Butvar Polyvinyl Butyral Resin

Properties	ASTM Method ^a	Butvar Resins						
		B-72	B-74	B-73	B-76	B-79	B-90	B-98
Mechanical ^a								
Tensile strength, MPa								
Yield	D638-58T	47-54	47-54	45-52	40-47	40-47	43-50	43-50
Break	D638-58T	48-55	48-55	41-48	32-39	32-39	49-46	39-46
Elongation, %								
Yield	D638-58T	8	8	8	8	8	8	8
Break	D638-58T	70	75	80	110	110	100	110
Modulus of elasticity (apparent) GPa	D638-58T	2.3-2.4	2.3-2.4	2.2-2.3	1.9-2.0	1.9-2.0	2.1-2.2	2.1-2.2
Flexural strength, yield, MPa	D790-59T	83-90	83-90	79-86	72-79	72-79	76-86	76-83
Hardness, Rockwell								
M	D785-51	115	115	115	100	100	115	110
E	D785-51	20	20	20	5	5	20	20
Notched Izod Impact strength (1.25 cm × 1.25 cm), J/m)	D256-56	59	59	55	43	43	48	37
Thermal (°C)								
Flow temperature	D569-59	145-155	135-145	125-130	110-115	110-115	125-130	105-110
Glass temperature ^a		78-78	72-78	72-78	62-72	62-72	72-78	72-78
Heat distortion temperature	D648-56	56-60	56-60	55-59	50-54	50-54	52-56	45-55
Heat-sealing temperature ^b		105	105	99	93	93	205	200
Electrical								
Dielectric constant								
50Hz	D150-59T	3.2	3.2	3.0	2.7	2.7	3.2	3.3
1 kHz	D150-59T	3.0	3.0	2.7	2.6	2.6	3.0	3.0
1 MHz	D150-59T	2.8	2.8	2.6	2.6	2.6	2.8	2.8
10 MHz	D150-59T	2.7	2.7	2.5	2.5	2.5	2.7	2.8
Dissipation factor × 10 ³								
50 Hz	D150-59T	6.4	6.4	5.8	5.0	5.0	6.6	6.4
1 kHz	D150-59T	6.2	6.2	5.5	3.9	3.9	5.9	6.1
1 MHz	D150-59T	27	27	22	13	13	22	23
10 MHz	D150-59T	31	31	22	15	15	23	24
Dielectric strength, V/m (3.2 mm thickness)								
Short time	D149-59	17	17	19	19	19	18	16
Step by step	D149-59	16	16	16	15	15	15	15

^a Glass temperature (T_g) was determined by differential scanning calorimeter.

^b Heat-sealing temperature was determined on a 25 m dried film on paper, cast from a 10% solution in 60:40 toluene/ethanol. A dwell time of 1.5 sec at 414 kPa (60psi) line pressure was used on the heat sealer.

Source: *Butvar/Formvar Brochure*, publication no. 6.70E, Monsanto Chemical Company, Plastics and Resins Division, St. Louis, MO.

the mechanical, thermal, and electrical properties are listed in [Table 60.5](#). Solubility data for the Formvar resins are given in [Table 60.6](#).³ Properties of Butvar dispersion BR are shown in [Table 60.7](#).⁴ The data given in [Table 60.1](#) through [Table 60.7](#) are typical properties, not the manufacturer's specifications. For actual product specifications, the manufacturer should be consulted. The polyvinyl formal grades are all chemically identical; they differ only in molecular weight. The polyvinyl butyrals fall into two chemical groups, high (17.5 to 21 wt%) residual polyvinyl alcohol, and low (10.5 to 3 wt%) polyvinyl alcohol. Within each of these groups, molecular weight is also varied. In general, as the percentage of polyvinyl alcohol increases, toughness, modulus, and adhesion to polar surfaces will increase, while the range of useful solvents decreases (conversely, solvent resistance increases). As the percentage of polyvinyl alcohol decreases, the resins become more broadly soluble, softer, and lower in glass transition temperature.

TABLE 60.3 Solubility of Butvar Resins^a

Solvent	Butvar Solutions Agitated at Room Temperature for 24 h		
	5% Solid Solution	10% Solids Solution	
	B-72, B-73, B-74	B-76, B-79,	B-90, B-98
Acetic acid (glacial)	S	S	S
Aceton	I	S	SW
Butyl acetate	I	S	PS
<i>n</i> -Butyl alcohol	S	S	S
Butyl cellulose	S	S	S
Cyclohexanone	S	S	S
Diacetone alcohol	PS	S	S
Diisobutyl ketone	I	SW	I
<i>N,N</i> -Dimethylacetamide	S	S	S
<i>N,N</i> -Dimethylformamide	S	S	S
Dimethyl sulfoxide	S	S	S
Ethyl acetate, 99%	I	S	PS
Ethyl acetate, 85%	S	S	S
Ethyl alcohol, 95%, or anhydrous	S	S	S
Ethylene dichloride	SW	S	SW
Ethylene glycol	I	I	I
Isophorone	PS	S	S
Isopropyl alcohol, 95%, or anhydrous	S	S	S
Isopropyl acetate	I	S	I
Methyl acetate	I	S	PS
Methyl alcohol	S	SW	S
Methyl ethyl ketone	SW	S	PS
Methylene chloride	PS	S	S
Methyl isobutyl ketone	I	S	I
Naphtha (light solvent)	I	SW	I
<i>N</i> -Methyl-2-pyrrolidone	S	S	S
Propylene dichloride	SW	S	SW
Tetrachlorethylene	SW	SW	SW
Tetrahydrofuran	S	S	S
Toluene	I	PS	SW
Toluene/ethyl alcohol (95%) (60:40 by weight)	S	S	S
1, 1, 1-Trichloroethane	SW	S	SW
Xylene	I	PS	SW

^a Key: S, Completely soluble; PS, partially soluble; I, insoluble; SW, swells (hazy, turbid).

Source: *Butvar/Formvar Brochure*, publication no. 6.70E, Monsanto Chemical Company, Plastics and Resins Division, St. Louis, MO.

Within a given chemical group, increasing molecular weight results in a modest increase in tensile strength and modulus, increased solution viscosity, and a modest increase in solvent and chemical resistance. In general, even the lowest molecular weight grades of these resins are high enough in molecular weight to be well within the chain entanglement region of the E' spectrum such that physical properties do not change drastically as molecular weight increases. Molecular weight variations can be used effectively to control the rheology/viscosity of coatings formulations more than the properties of the final coating.

60.3.3 Solution Viscosity

Solution viscosity is a function of chemical composition, molecular weight, and solvent composition. Within a given chemical class, solution viscosity in a given solvent will increase with molecular weight. The effect of solvent composition on solution viscosity is more complex and not within the scope of this discussion. Solvent systems are often chosen for a variety of reasons other than viscosity: drying rate, toxicity and other environmental concerns, utility with other resins needed in a formulation, etc. Usually

TABLE 60.4 Typical Physical and Chemical Properties of Formvar Polyvinyl Formal Resin

Properties	ASTM Method ^a	Formvar Resins			
		5/95E	6/95E	7/95E	15/95E
Physical					
Form		White, free-flowing powder			
Volatiles, maximum, %		2.2	2.2	2.2	2.2
Molecular weight $\times 10^{-3}$ (weight average)	(1)	25–35	35–45	40–60	70–150
Solution viscosity 15% by wt, MPa + 8	(2)	140–280	250–500	325–675	1800–3500
Resin viscosity	(2)	8–12	12–15	15–20	37–53
Specific gravity, 23°/23° (± 0.002)	D792–50	1.227	1.227	1.227	1.227
Burning rate, cm/min	D635–56T	2.0	2.3	2.3	2.5
Refractive index (± 0.0005)	D542–50	1.502	1.502	1.502	1.502
Water absorption (24hs), %	D570–59aT	1.2	1.2	1.2	1.2
Hydroxyl content, as % polyvinyl alcohol	D1396–58	5.0–6.5	5.0–6.5	5.0–6.5	5.0–6.5
Acetate content, as % polyvinyl acetate	D1396–58	9.5–13.0	9.5–13.0	9.5–13.0	9.5–13.0
Formal content, as % polyvinyl formal, approx		82	82	82	82
Chemical ^b					
Resistance to					
Weak acids	D543–56T	E	E	E	E
Strong acids	D543–56T	E	E	E	E
Weak bases	D543–56T	E	E	E	E
Wrong bases	D543–56T	E	E	E	E
Organic solvents					
Alcohols	D543–56T	G	G	G	G
Chlorinated	D543–56T	P	P	P	P
Aliphatic	D543–56T	E	E	E	E
Aromatic	D543–56T	G	G	G	G
Esters	D543–56T	G	G	G	G
Ketones	D543–56T	G	G	G	G

^a The ASTM method noted for hydroxyl content and acetate content refers specifically to polyvinyl butyral resins. However, the same method is applicable to the polyvinyl formal resins. All other properties were determined by ASTM methods except: (1) molecular weight was determined by SEC/LALLS in hexafluoroisopropanol; (2) solution viscosity was determined in 15% by weight solutions in 6:40 toluene/ethanol at 25°C, using a Brookfield viscometer. Resin viscosity — 5 g resin made to 100 ml with ethylene dichloride — measured at 20°C using an Ostwald viscometer.

^b Key: E, excellent; G, good; F, fair; P, poor.

Source: *Butvar/Formvar Brochure*, publication no. 6.70E, Monsanto Chemical Company, Plastics and Resins Division, St. Louis, MO.

by judicious experimentation, a compromise solvent system can be found that will give a reasonable mix of the required properties.

60.3.4 Plasticizers

Plasticizers are often used to soften the films prepared from the polyvinyl acetals. Among the suggested plasticizers for polyvinyl butyral are butyl benzyl phthalate, 2-ethylhexyl diphenyl phosphate, dihexyl adipate, and a variety of other phosphate, phthalate, adipate, sebacate, and ricinoleate esters. Rosin-based polyester, and blown linseed oil plasticizers are also used.

Diethyldiphenyl and dicyclohexyl phthalates, butyl benzyl phthalate and phosphate ester including 2-ethylhexyl diphenyl phosphate polyester, chlorinated naphthalenic, and adipate diesters are useful for polyvinyl formal. By proper choice of plasticizer type and level, the physical-mechanical, chemical, and adhesion properties of these resins can be tailored for a wide variety of applications. Fitzhugh and Crozier⁵ have studied the effect of a number of plasticizers on the mechanical properties of polyvinyl acetal resins.

TABLE 60.5 Typical Mechanical, Thermal, and Electrical Properties of Formvar Polyvinyl Formal Resin

Properties ^a	ASTM Method	Formvar Resins			
		5/95E	6/95E	7/95E	15/95E
Mechanical					
Tensile strength, MPa					
Yield	D638-58T	59-66	59-66	59-66	59-66
Break	D638-58T	52-59	52-59	52-59	52-59
Elongation, %					
Yield	D638-58T	7	7	7	7
Break	D638-58T	50	50	50	50
Modulus of elasticity (apparent), GPa	D638-58T	2.7-3.1	2.7-3.1	2.7-3.1	2.7-3.1
Flexural strength, yield, MPa	D790-59T	117-124	117-124	117-124	117-124
Hardness, Rockwell					
M	D785-51	150	150	150	150
E	D785-51	65	65	65	65
Notched Izod impact strength (1.25 cm × 1.25 cm), J/m	D256-59	70	70	70	70
Thermal (°C)					
Flow temperature, 6.9 MPa	D569-59	140-150	140-150	140-150	160-170
Glass temperature	^b	103-113	103-113	103-113	103-113
Heat distortion temperature	D648-56	83-87	85-90	85-90	87-93
Heat-sealing temperature	^c	96	96	99	107
Electrical					
Dielectric constant					
50 Hz	D150-59T	3.2	3.2	3.2	3.4
1 kHz	D150-59T	3.3	3.3	3.3	3.0
1 MHz	D150-59T	3.1	3.1	3.1	2.8
10 MHz	D150-59T	3.0	3.0	3.0	2.8
Dissipation factor × 10 ³					
50 Hz	D150-59T	8.1	8.1	8.1	8.7
1 kHz	D150-59T	10	10	10	10
1 MHz	D150-59T	21	21	21	21
10 MHz	D150-59T	19	19	19	18
Dielectric strength (3.2 mm thickness), V/m					
Short time	D149-59	24	13	13	12
Step by step	D149-59	12	12	12	13

^a Conversion factors: MPa × 145 = psi; GPa × 145 × 10³ = psi; J/m × 53.38 lb-ft/in.

^b Glass temperature (T_g) was determined by differential scanning calorimeter.

^c Heat-sealing temperature was determined on a 25 m dried film on paper, cast from a 10% solution in 60:40 toluene/ethanol. A dwell time of 1.5 sec at 414 kPa (60 psi) line pressure was used on the heat sealer.

Source: *Butvar/Formvar Brochure*, publication no. 6.70E, Monsanto Chemical Company, Plastics and Resins Division, St. Louis, MO.

60.3.5 Toxicology

Butvar resins are regulated by the U.S. Food and Drug Administration under the Code of Federal Regulations, as indirect food additives. Butvar resins have also been subjected to acute toxicity studies on laboratory animals. Subject to the appropriate regulations, they are useful in a number of packaging applications for both fatty and aqueous foods.

Both Butvar and Formvar resins have flash points in excess of 370°C. The lower explosive limit (LEL) for Butvar dust in air is 20 g/m³. Although these materials are considered to be nontoxic in ordinary everyday handling, good industrial hygienic practices should be observed when using them.

TABLE 60.6 Solubility of Formvar Resins^a

Solvent	Formvar Resins
	15/95E, 7/95E, 6/95E, 5/95E
Acetic acid (glacial)	S
Acetone	I
Aniline	S
Benzene	I
Butyl alcohols	I
Butyl acetate	I
Carbon disulfide	I
Cresylic acid	S
Cyclohexanone	I
Diacetone alcohol	I
Diisobutyl ketone	I
Dimethyl sulfoxide	S
<i>N,N</i> -Dimethylacetamide	S
<i>N,N</i> -Dimethylformamide	S
Ethyl acetate, 99%	I
Ethyl acetate, 85%	I
Ethyl alcohol, 95%, or anhydrous	I
Furfural	S
Hexane	I
Isopropyl alcohol, 95%, or anhydrous	I
Methyl acetate	I
Methyl alcohol	I
Methyl benzoate	S
Methyl butynol	S
Methyl cellosolve acetate	I
Methyl ethyl ketone	I
Methyl isobutyl ketone	I
Methyl pentynol	S
<i>N</i> -Methyl-2-pyrrolidone	S
Nitropropane	I
Pentoxol	I
Propyl alcohols	I
Phenol	S
Propylene dichloride	I
Tetrachlorethane	S
Tetrahydrofuran	S
Toluene/ethyl alcohol (95%) (60:40 by weight)	S
Toluene	I
VM&P Naphtha	I
Xylene	I
Xylene- <i>n</i> -butyl alcohol (60:40 by weight)	I

^a Key: S, Completely soluble; I, insoluble or not completely soluble.

Source: *Butvar/Formvar Brochure*, publication no. 6.70E, Monsanto Chemical Company, Plastics and Resins Division, St. Louis, MO.

60.4 Surface Coating Applications

60.4.1 Polyvinyl Butyral^{2,8}

The inherent properties of adhesion to a wide variety of surfaces, film toughness and chemical/solvent resistance, and film clarity of the polyvinyl butyral resins makes them the vehicle of choice in a wide variety of specialty coating applications. They adhere tenaciously to most polar surfaces: wood, glass, metals, ceramics, pigments, etc. Their high binding efficiency allows them to be used at very high pigment loadings. Ceramic films are typically cast in thicknesses from fractions of a mil to several millimeters,

TABLE 60.7 Properties of Butvar Dispersion BR

Property	Description/Value
Form	Milk-white aqueous dispersion of plasticized polyvinyl butyral
Total solids	50.0–52%
Viscosity	500–1500 mPa ^a
pH	8.0–10.5
Particle size	Most particles between 0.25 and 1.5 μ
Particle charge	Anionic
Plasticizer content	40 parts per 100 parts of resin (28.6% of solids)
Pounds per gallon at 25°C	8.4
Grams per liter	1008

^a Determined on a Brookfield viscometer, LVF, no. 3 Spindle, 30 rpm, 25°C.

TABLE 60.8 Western Pine Association Knot Sealer, WP578: Brush Application

Material	% by weight
Butvar B-90 (Monsanto Chemical Co.)	3.3
Durite P-97 (Borden Chemical Co.)	40.0
SDA 35A, 95% ethanol	56.7
	100.0

Source: *Butvar/Formvar Brochure*, publication no. 6.70E, Monsanto Chemical Company, Plastics and Resins Division, St. Louis, MO.

using 4 to 5% Butvar B-76 as the sole binder⁶; most permanent coatings applications will require considerably higher binder levels than this for adequate film strength. Polyvinyl butyral resins have been used as the binder of choice in thermographic and photographic coatings,⁷ in photoconductive coatings, in electrophotographic coatings, and as a coating on optical recording disks, all of which depend on film toughness, binder efficiency, and optical clarity. Their toughness, chemical and heat resistance, and binding efficiency render them useful in powder coatings and photothermographic coating applications.

Polyvinyl butyrals are used extensively as wood coatings, where their resistance to natural wood oils makes them a primary choice for sealers and wash coats. An example of an application on the Western Pine Association Knot Sealer number WP578 is given in Table 60.8. A well-known application of polyvinyl butyrals is in the manufacture of wash primers for the priming of metal surfaces to be used in hostile environments (e.g., the hulls of naval vessels). There are a number of formulations available, both single- and two-package systems. Another example of a metal coating based on polyvinyl butyral is Metal Coating 2009, described in Table 60.9.

Other coating applications of the polyvinyl butyrals include solder masks for printed circuit board manufacture, heat-fusible wire coatings, and zinc oxide-based photosensitive paper coatings; they also serve as the binder/vehicle for iron oxide in the production of magnetic recording tapes. They are widely used as toughness/flexibility/adhesion promoters in the production of inks for letterpress, flexographic, and gravure printing, and as a component in toners for reprography.

60.4.2 Polyvinyl Butyral Dispersions

The dispersion of plasticized polyvinyl butyral in water, marked, by Monsanto as Butvar dispersion BR,⁴ is widely used as a permanent surface size in critical textile applications, e.g., seat belt and parachute webbing, where the toughness of the butyral film lends outstanding abrasion resistance to the fabric. The relatively high surfactant levels used in the manufacture of this dispersion reduce the inherent adhesion of the resin to most highly polar surfaces such as metals and glass. This property is used to advantage in the preparation of removable coating for temporary protection of sensitive surfaces. This dispersion

TABLE 60.9 Metal Coating 2009: Spray or Roller Application

Material	% by weight
Diacetone alcohol	17.4
<i>n</i> -Butanol	17.4
SDA-35A, 95% ethanol	7.7
Xylene	34.7
Methylon 75-108 (Bakelite Thermosets, Ltd.)	5.1
Epon 1007 (Shell Chemical Corp.)	13.0
Butvar B-90 (Monsanto Chemical Co.)	2.0
10% Phosphoric acid (diluted with a portion of the given solvent mixture)	2.7
	100.0

Cure cycle: 15 minute air dry + 30 minutes at 190°F and 20 minutes at 400°F

Source: *Butvar/Formvar Brochure*, publication no. 6.70E, Monsanto Chemical Company, Plastics and Resins Division, St. Louis, MO.

is typically formulated with other dispersions/latex as extenders to reduce cost. Pigments and plasticizers can be incorporated, as can small amounts of solvents to enhance adhesion properties.

60.4.3 Polyvinyl Formal^{2,8}

Polyvinyl formal, available in several viscosity grades from Monsanto as Formvar, is widely used as an oil-resistant insulating coating for magnetic wire. For this application, it is normally cross-linked by formulating with phenolic, epoxy, or urethane resins to enhance properties. These coatings are tough, strongly adhering, abrasion resistant, and totally impervious to hydrocarbon oils and lubricants. Polyvinyl formal serves as the base vehicle for coatings for printed circuit boards, both permanent and fugitive (e.g., solder masking), for the surface treatment of glass fibers and boron filaments (abrasion resistance), and as an antifog coating on glass. It finds application in photothermographic and electrographic coatings. It is used as a binder in magnetic tape coatings, particularly for the high performance chromium oxide coated tapes. It finds use as an ink binder and as a lacquer to protect the surface of lithographic plates.

In general, polyvinyl formal is higher in modulus and less susceptible to solvent attack than is polyvinyl butyral. Conversely, solvent choices are more limited for the formal. Films are somewhat yellow, reducing their utility in applications calling for a colorless film.

References

1. K. Toyoshima, in *Polyvinyl Alcohol*. C. A. Finch, Ed. New York: Wiley, 1973, pp. 381-411.
2. T. P. Blomstrom, in *Encyclopedia of Polymer Science and Engineering*, 2nd ed., Vol. 16. J. I. Kroschwitz, Ed. New York: Wiley-Interscience, 1989.
3. *Butvar/Formvar Brochure*, publication no. 6.70E, Monsanto Chemical Company, Plastics and Resins Division, St. Louis, MO.
4. *Butvar Dispersions BR Data Sheet*, Monsanto Chemical Company, Plastics and Resins Division, St. Louis, MO.
5. A. F. Fitzhugh and R. N. Crozler, *J. Polym. Sci.*, 8, 225 (1952); 9, 96 (1952).
6. K. Hoshi, S. Tasaka, and T. Yoshimi, *Jpn. Kokai*, 62/46, 953 (1987); Taiyo Yuden Co. Ltd., [*Chem. Abstr.*, 106(22), 181, 481h.]
7. T. T. Boersma, *J. Imaging Technol.*, 13(2), 75 (1987).
8. E. Lavin and J. A. Snelgrove, "Polyvinyl acetals," in *Encyclopedia of Chemical Technology*, 3rd ed., Vol. 23. New York: Wiley-Interscience, 1983, pp. 798-816.

61

Polyimides

B. H. Lee

Ciba-Geigy Corporation

61.1 Chemistry and Properties.....	61-1
61.2 Uses	61-2
61.3 Commercial Information.....	61-2
Bibliography	61-2

Polyimides are condensation polymers that contain the imide structure $-\text{CO}-\text{N}-\text{CO}-$ as a linear or heterocyclic unit along the polymer main chain. They exhibit exceptional thermal, thermooxidative, and chemical resistance, and good radiation resistance and dimensional stability, while maintaining an excellent balance of mechanical and electrical properties.

61.1 Chemistry and Properties

Aromatic polyimides are generally produced by a two-step polycondensation reaction of aromatic dianhydride with either aromatic diamine or aromatic diisocyanate in a suitable reaction medium. They have the following general structure:

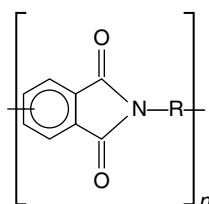

The direct production of high molecular weight aromatic polyimides in a one-step polymerization could not be accomplished because the polyimides are usually insoluble and intractable. The polymer chains precipitate from the reaction media (whether solution or melt) before high molecular weights are obtained. Therefore, processing of the aromatic polyimides can be accomplished only with the first step intermediate amic acid varnish, while it is still soluble and fusible. Were it not for the processing difficulties associated with known polymers, polyimides would be enjoying success in many more new application areas. This processing problem was partially overcome by the development of copolymers. The two major commercial polyimide copolymers are an amide-imide known as Torlon, a product of Amoco, and an ether-imide produced by General Electric under the trade name Ultem. Another approach to this processing problem was dealt with by incorporating a soft aromatic segment and/or aliphatic moiety in the polymer main chain. Among the various efforts to overcome the processing difficulties, one commercial success was achieved by incorporating a totally asymmetric diamionophenylindane isomeric mixture into the polyimide backbone; it is marketed as Matrimid 5218 from Ciba-Geigy. This material is soluble in

relatively nonpolar solvents and is characterized also by exceptionally high glass transition temperature and high thermoxidative stability.

Key properties of aromatic polyimides are their outstanding high-temperature resistance, toughness, good dielectric properties, low flammability, and high resistance to radiation and structural deformation under load at elevated temperatures.

61.2 Uses

Polyimides are primarily used in the aerospace, automotive, and electronic industries, where a need exists for materials with long-term high-temperature capabilities. Molded polyimides are now widely used in load-bearing applications such as struts, chassis, and brackets in automotive and aircraft structures because of their high flexural modulus and compressive strength. Their excellent high-temperature dimensional stability, chemical resistance, and natural lubricity make them ideal bearing materials in such applications as jet engines, appliances, and office equipment. Polyimide films are used as insulation for electric motors, aircraft parts, missile wire cable, magnetic wire, and flat flexible cable.

The electrical properties of polyimides make them ideally suitable for applications in the electrical and electronic markets. They are being used in place of glass and ceramics for high heat connectors, switches, housings, and controls. They are also used in the fabrication of injection-molded printed circuit boards. Polyimide coatings are increasingly being used in microelectronic applications. Major applications are in the following areas:

Interlayer dielectrics on silicon and gallium arsenide integrated circuits for multilevel devices

Passivation, thermal-mechanical buffer, and α -particle protection coatings on integrated circuits and other circuitry

Masking for multilayered resist processing; for negative-profile liftoff processing; for harsh processing such as ion implantation or dry etching

The principal features that make polyimides suitable for microelectronic applications are as follows:

- Polyamic acid varnishes and/or polyimide solutions can be easily spun on planarized layers, exposed, and etched with existing equipment.
- Polyimides have good dielectric properties.
- Polyimide coatings are tough and resilient, and have good thermal and chemical stability. They also have good radiation resistance.

61.3 Commercial Information

Several commercially available aromatic polyimides, such as Kapton (DuPont), IP-2080 (Dow), Matrimid 5218 (Ciba-Geigy), Ultem (General Electric), and LARC-TPI (Mitsui-Toatsu chemicals), are used in the form of films, moldings, adhesives, and composite matrices. Numerous lacquers or varnishes based on similar chemistries are also available from the basic resin suppliers. Several polyimide coating solutions also have been introduced commercially.

Bibliography

1. K. L. Mittal, Ed., *Polyimides*, Vols. I and II. New York: Plenum Press, 1984.
2. J. W. Verbicky, Jr., in *Encyclopedia of Polymer Science and Engineering*, 2nd ed., Vol. 12. New York: Wiley, 1988, p. 364.
3. J. J. King and B. H. Lee, in *High Performance Polymers: Their Origin and Development*. R. B. Seymour and G. S. Kirshenbaum, Eds. New York: Elsevier, 1986, p. 317.
4. Y. K. Lee and J. D. Craig, in *Polymer Materials for Electronic Applications*. E. D. Feit and C. W. Wilkins, Jr., Eds. Washington D.C.: American Chemical Society, 1982, p. 107.

62

Parylene Coating

William F. Beach
Consultant

62.1 Process.....	62-1
62.2 Properties.....	62-2
62.3 Applications.....	62-3
References.....	62-3

62.1 Process

The parylene process^{1,2} is a means of applying a pinhole-free coating with exceptional conformality and control of thickness. The coatings so produced have excellent dielectric as well as barrier properties. The parylene coating, composed solely of poly (*p*-xylylene) (PPX), a family of linear, high molecular weight organic polymers, is grown directly on a substrate by vapor deposition polymerization (VDP). The gaseous *p*-xylylene monomer (PX) is transformed into a solid polymer coating without passing through an intermediate liquid stage. Since surface forces have no opportunity to alter the cross-sectional profile, the result is a coating of extraordinary uniformity of thickness and continuity. No postdeposition cure is necessary to complete the coating chemistry. The parylene process affords exceptional control of coating thickness. While typically used in thicknesses of 1 to 10 μm , continuous parylene films have been demonstrated at thicknesses under 500 (0.05 μm). In principle, there is no upper limit to the thickness to which a parylene film might be grown, but practical constraints of time and cost place an upper bound in the vicinity of 100 μm .

The parylene process is further distinguished by the fact that it is conducted at room temperature. Parylene growth rates actually decrease at high temperatures. There is an advantage in operating the process at subambient temperatures, if such operation is feasible. Another distinguishing feature of the parylene process is that it proceeds without the assistance of a catalyst. Thus, the coating is of remarkable chemical purity with respect to catalyst residues, which in other coating systems can be ionic or ionogenic, or leachable.

The monomer is exceptionally reactive. It cannot be stored. It can be handled only as a rarefied, low pressure gas. It is therefore necessary to generate monomer as it is required by the coating process. Monomer is conveniently generated by the pyrolytic cleavage of its dimer, di-*p*-xylylene (DPX), a [2.2] paracyclophane. Monomer generation from dimer proceeds in quantitative yield with no by-products. Because the temperatures for monomer generation and consumption are so different, monomer transport from one site to the other during deposition is a practical necessity. Such transport is done most efficiently when all other gases are absent. For this reason, the commercial process is conducted within a vacuum system.

The composition of the coating can be modified to some extent by attaching substituents to the ring carbons of the DPX molecule. Although many versions of parylene process feedstock DPX are known, those that are commercially available at this time include DPXN, the base hydrocarbon; DPXC, with an average of one chlorine atom per aromatic ring; and DPXD, averaging two chlorine atoms per aromatic ring. The coatings prepared starting with these dimers are called Parylene N, Parylene C, and Parylene

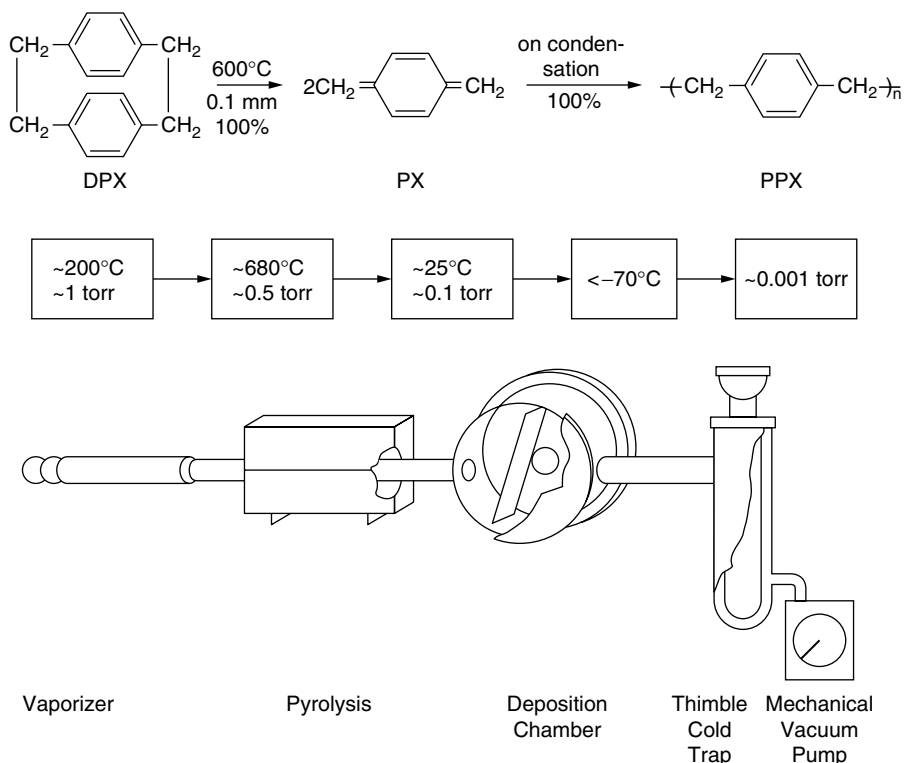

FIGURE 62.1 Schematic of parylene deposition apparatus.

D, respectively. Substituents reduce the volatility of the monomer, causing the processing characteristics of the modified versions to be somewhat different.

The discovery of the base member of the family, poly(*p*-xylylene), was first reported in 1947. However, it was not until 1965, when the Gorham process starting with DPX was announced,³ that the polymer family became industrially viable. Figure 62.1 is a schematic of the parylene equipment, with typical operating conditions indicated.

62.2 Properties

The glass transition temperatures of the parylenes are in the vicinity of room temperature. However, the parylenes are crystalline polymers, and as such retain substantial physical strength and solvent resistance at temperatures approaching their crystalline melting points (for Parylenes N, C, and D: 420, 290, and 380°C, respectively). Long-term contact with solvents results in a mere few percent swelling. Equilibrium moisture absorption is very low. Significantly, no mode of moisture-induced degradation is chemically feasible. The dielectric constants and loss factors of the parylenes are low and invariant over a wide range of frequencies. Although permeable, the parylenes at a given thickness are superior as barriers to other organic polymers that can conveniently be prepared as coatings.

The parylenes are vulnerable to attack by oxygen, particularly at elevated temperatures and in the presence of ultraviolet radiation. In air, 10-year use temperatures for Parylenes N, C, and D are projected to be 60, 80, and 110°C, respectively. In oxygen-free environments, the thermal endurance of each is substantially better.

While it is tempting to categorize the parylene vapor deposition polymerization process with the superficially similar processes of evaporation, sputtering, or chemical vapor deposition of metals or inorganics, there are important distinctions to be made. In the latter processes, the growth action is

confined to the outer substrate surfaces, while the parylene polymerization chemistry actually occurs under the surface of the growing coating. As a result, the parylenes deposit in a condition of compressive stress and adhere to organic substrates, which are permeable to monomer by an interpenetration mechanism. Adhesion to impermeable metallic or inorganic substrates such as aluminum or silica can be achieved by pretreatment with an organosilane primer such as γ -methacryloxypropyl trimethoxysilane (A-174).

62.3 Applications

The parylenes first found use in electronics construction. Because of its exceptionally low and frequency-independent dielectric constant, Parylene N continues to be used as the functional dielectric in high quality miniature film capacitors. Very early on, the parylenes were qualified under MIL-I-46058, the specification for coating printed circuit assemblies. Parylene C continues to enjoy a reputation as a high performance coating for military circuitry, particularly in avionics. Parylene C is also an Underwriters Laboratories (UL) approved conformal coating. The use of the parylenes as circuit coatings has extended to hybrids. The exceptional conformality of the parylenes has served them well in these applications, but so far has impeded their use in multilevel interconnection schemes, where a planarizing dielectric is sought. In the manufacture of miniature electric motors, such as those used in wristwatches, parylene is used as an insulating coating on the armature. Parylene's exceptional thickness control permits the winding of a maximum number of turns, and therefore superior motor performance. Furthermore, a parylene process variation in which the parts are tumbled during deposition permits economies through the coating of thousands of parts at a time.

Parylene's use today has broadened to such diverse missions as the immobilization of loose particles that otherwise would result in early device failure (Winchester drives and hybrids), the modification of surface abrasiveness on ferrite toroids, and the reinforcement and preservation of embrittled paper in old books and museum artifacts.

References

1. W. F. Beach, C. Lee, D. R. Bassett, T. M. Austin, and R. Olson, "Xylylene polymers," in *Encyclopedia of Polymer Science and Engineering*, 2nd ed. New York: Wiley-Interscience, 1988.
2. (a) S. M. Lee, in *Kirk-Othmer Encyclopedia of Chemical Technology*, 3rd ed., Vol. 24. New York: Wiley-Interscience, 1983, pp. 744–771. (b) M. Szwarc, *Polym. Eng. SCE.*, 16(7), 473–479 (1976). (c) W. F. Gorham and W. D. Niegisch, in *Encyclopedia of Polymer Science and Technology*, Vol. 15, 1971, pp. 98–124. (d) L. A. Errede and M. Szwarc *Q. Rev.* 12, 301–320 (1958).
3. W. F. Gorham, U. S. Patent 3,342,754 (September 19, 1967); Union Carbide Corp.

63

Nitrocellulose

63.1	Preparation	63-1
	Degree of Substitution • Degree of Polymerization • Types and Grades	
63.2	Solubility	63-2
	Solvents and Diluents • Viscosity Effects • Blushing • Solution Preparation	
63.3	Film Properties	63-3
	Plasticizers • Resins • Cross-Linkable Coating Systems • Safety Considerations	
	Appendix: Typical Properties of RS Nitrocellulose	63-5

Daniel M. Zavisza
Hercules Incorporated

When most people think of nitrocellulose, they think of guncotton, a material that was developed for explosives or gum propellant. But they are only partially correct. Nitrocellulose is one of the oldest and most widely used film formers adaptable to a number of uses. It is derived from cellulose, a material from plants, and therefore a renewable source. Soluble nitrocellulose possesses a unique combination of properties such as toughness, durability, solubility, gloss, and rapid solvent release. As the film former in lacquer systems, it affords protective and decorative coatings for wood and metal. In addition, it finds use in flexible coatings for paper, foil and plastic film, printing inks, and adhesives. This chapter briefly covers the properties, uses, and handling procedures for nitrocellulose and the formulations made from it.

63.1 Preparation

Nitrocellulose is the common name for the nitration product of cellulose. Other names include cellulose (tri)nitrate and guncotton. The commercial product is made by reacting cellulose with nitric acid. Cellulose is composed of a large number of β -anhydroglucose units, which are jointed together into a chain. The anhydroglucose units are six-membered rings having three hydroxyl ($-OH$) groups attached to them. The number of anhydroglucose units in the typical cellulose chain ranges from 500 to 2500 in chemically purified cellulose.

63.1.1 Degree of Substitution

Nitric acid can react with these three hydroxyl groups of the anhydroglucose units to form the nitrate ester. Fully nitrated cellulose would then be a trinitrate — that is, a nitrate having a degree of substitution of 3. The calculated nitrogen content of such a fully nitrated cellulose is 14.14%.

In practice, however, the maximum nitrogen level that can be achieved is 13.8%. This corresponds to a degree of substitution of 2.9. At this level, nitrocellulose does not process properties that are useful for coatings use. Film forming properties are better at degrees of substitution between 1.8 and 2.3.

63.1.2 Degree of Polymerization

The degree of polymerization of nitrocellulose is the number of anhydroglucose units that are linked together to form one molecule. The more units are linked, the higher the viscosity of the nitrocellulose in solution at a given concentration. Commercial nitrocellulose is categorized into grade by the viscosity of a 12.2% solids solution at 25°C in terms of centipoise or the time it takes, in seconds, for a metal ball of a specified size to fall a measured distance through the solution. The solvent system used is usually 55 parts by weight toluene, 25 parts denatured ethanol, and 20 parts ethyl acetate.

63.1.3 Types and Grades

Nitrocellulose is divided into types according to the nitrogen content of the product, which reflects higher or lower degrees of substitution. The lowest commercially useful nitrogen content is 11% (10.0 to 11.2%). This corresponds to a degree of substitution of 1.8 to 2.1. This type is further classified into viscosity grades ranging from 30 to 35 cp* to 40 to 60 sec. These grades are useful in lacquers for paper and foil, low odor lacquers, sealers, fillers, printing inks, and plastics. At this level of nitrogen, nitrocellulose is more tolerant of alcohol than higher nitrogen types.

A second type has an average nitrogen content of 11.5% (11.3 to 11.7%). Viscosity grades of 0.5 and 5 to 6 sec are available for use in lacquers for coating cellophane, paper, and textiles.

The next type contains an average of 12% nitrogen (11.8 to 12.2%) and is available in a large number of viscosity grades, from 18 to 25 cp to 2000 sec. This type is more tolerant of aromatic hydrocarbon solvents, such as toluene, and less tolerant of aliphatic hydrocarbons. This grade is compatible with many resins and has many uses. It is used in coatings for wood, metal, paper, textiles, and foil; for lacquer emulsions for wood and metal; and for architectural finishes, adhesives, cements, and inks. Higher nitrogen levels (>13%) find use in the manufacture of gun propellants and explosives.

Solubility and viscosity in solution and compatibility of nitrocellulose with a variety of modifiers, such as plasticizers, resins, and pigments, determine its usefulness in preparing lacquers and coatings. The chapter appendix is a table of the typical properties of nitrocellulose containing 12% nitrogen, the type most commonly used for lacquers and coatings.

63.2 Solubility

63.2.1 Solvents and Diluents

The generally used method of formulating nitrocellulose coating systems features volatile solvents that dissolve the nitrocellulose and its modifiers to form a homogeneous system (with the exception of pigments and fillers).

The resulting formulation can then be applied to the substrate by one of a number of methods such as brushing, spraying, or curtain coating. The solvent evaporates to leave a solid film on the substrate.

True solvents are liquids that will dissolve nitrocellulose completely. For 12% nitrogen nitrocellulose, these are ketones, esters, amides, and nitroparaffins. Some solvents, such as ethyl or isopropyl alcohol, will not dissolve nitrocellulose on their own. They may be added to true solvents without precipitating the nitrocellulose. These are termed "cosolvents." Aliphatic and aromatic hydrocarbons are nonsolvents. Termed "diluents," they may be added to nitrocellulose solutions in limited amounts without precipitation to lower cost and improve solubility of resin modifiers. Aromatics may usually be added to a greater extent than aliphatics. At the lower nitrogen level of 11%, more hydrocarbon can be added to the nitrocellulose solution without precipitation.

*The viscosity of very low molecular weight nitrocellulose is measured and described in centipoise. The falling ball method is used for times of a quarter-second and higher. This results in a change of units used to describe the viscosity grades.

Dilution ratio is the ratio of the volume of diluent that can be added to a given volume of nitrocellulose solution in a true solvent before separation of the nitrocellulose takes place. For example, starting with 8 g of nitrocellulose in 100 m of solvent, butyl acetate, the dilution ratio for toluene is 2.75 compared with 1.5 for MV&P naphtha (an aliphatic hydrocarbon mixture). Different solvent–diluent combinations will have different dilution ratios and must be measured separately. When ethanol, a cosolvent, is combined with a true solvent, the dilution ratio for a given diluent is higher than with the true solvent alone. Raising the temperature will usually lower the dilution ratio for a diluent–solvent mixture.

63.2.2 Viscosity Effects

The viscosity of a polymer solution will normally increase with the solvating power of the solvent at a given concentration, because this allows the polymer to stretch out further and to become entangled with other polymer molecules more easily. A poorer solvent forces the polymer to become more compact and to occupy a smaller volume, resulting in a lower solution viscosity.

Toluene is a poorer solvent for nitrocellulose than esters or ketones. Up to a point, however, it may be added to solutions of nitrocellulose in true solvents, such as esters or ketones, without precipitating the nitrocellulose. The effect is that the viscosity of the resulting solution is lower for solutions containing toluene than without it at the same solids level. This technique allows a formulator to maximize the solids level for a given application viscosity. The most common diluents used in this way are toluene and xylene.

Solutions prepared of nitrocellulose exhibit a viscosity drop on standing. A solution of half-second grade at 20 wt% solids in an ethanol–toluene–ethyl acetate solvent blend exhibits, for example, a viscosity of 3.8 sec by a falling ball method 1 h after addition of the solvent but 3.5 sec after 24 h. This viscosity loss will stop after a finite time.

63.2.3 Blushing

Formulating lacquers that contain too great a percentage of rapidly evaporating solvents may result in a white chalky appearance upon drying. The cause of this is cooling of the film surface below the atmospheric dew point by the evaporating solvent, condensing water onto the film. If sufficient moisture is condensed, the nitrocellulose can precipitate. This blushing problem is worsened during humid weather.

The remedy for blushing is to add a slowly evaporating solvent to the solvent blend. This has the effect of retarding the evaporation rate and lowering the cooling effect. Examples of such solvents are diisobutyl ketone, methyl amyl acetate, amyl acetate, methyl amyl ketone, and 2-butoxyethanol.

Blushing or haze formation can also occur when a poor solvent, which has a slow evaporation rate, is used with a fast, good solvent. The good solvent will evaporate first, causing precipitation of the nitrocellulose by the poor solvent. Too much high boiling hydrocarbon diluent will do this.

63.2.4 Solution Preparation

The type of mixing apparatus is usually the preparer's choice. A vertical tank with propeller or disc agitators works well. Laboratory samples are easily dissolved by tumbling or rolling jars containing the nitrocellulose and solvent. If a solvent blend is to be used, it is best to disperse or wet the nitrocellulose with the cosolvent or diluent first, then add the active solvent portion. This procedure will reduce the time required to effect solution. Solvent blends containing higher ratios of diluent to active solvent will take longer to dissolve the nitrocellulose than those with lower diluent ratios.

63.3 Film Properties

Film properties of nitrocellulose are affected by the solvents used, the casting technique, the drying conditions, as well as other parameters. Different types of modifier are also used to alter nitrocellulose dry film properties. Nitrocellulose is only one ingredient in lacquers and coatings. The following description of modifiers is intended to give a flavor of how nitrocellulose systems may be modified.

63.3.1 Plasticizers

Plasticizers are nonvolatile materials added to control flexibility and elongation of a film. Plasticizers should be nonvolatile, colorless, odorless, and tasteless. They should be nontoxic and should provide maximum flexibility with minimum loss in film strength and toughness. They should not destabilize the film chemically.

Plasticizers fall into two types: solvent and nonsolvent. Solvent-type plasticizers are those that exhibit complete miscibility with nitrocellulose in all proportions. Examples are dibutyl phthalate and diisononyl phthalate.

Nonsolvent-type plasticizers neither dissolve nor cause formation of colloidal nitrocellulose at room temperature. However, they are compatible with nitrocellulose in solution and in the dry film. Examples of nonsolvent-type plasticizers are castor oil and polymeric or polyester-type plasticizers. The polymeric plasticizers improve flexibility and have very low volatility, are nonmigrating and nonspewing, and do not leave the film at elevated temperatures.

63.3.2 Resins

Resins are used in nitrocellulose coating compositions to improve the degree of film build by increasing the solids content at a given viscosity (i.e., spray viscosity). Depth, gloss, and adhesion can also be promoted by added resin.

Natural resins, such as shellac, dammar, elemi, and mastic, were some of the first resins used to modify nitrocellulose. Most of these resins are not film formers in themselves and do not improve tensile strength, flexibility, or elasticity. The use of natural resins is limited.

Some synthetic resins now available are designed to have specific properties that make them generally more adaptable for use in lacquers than natural resins. Alkyd resins are widely used. They are prepared by reacting a polyhydric alcohol, such as pentaerythritol, with a polybasic acid, such as phthalic acid. Alkyd resins modified with drying oils or unsaturated fatty acids are good film formers. Addition of nitrocellulose to these resins accelerates the drying time and often eliminates the need for baking.

Phenol-formaldehyde resins have excellent resistance to alcohols, acids, and alkalis. When used with nitrocellulose, however, there may be compatibility problems and poorer color stability. Other useful resins are acrylic resins, vinyl resins such as polyvinyl butyral and polyvinyl acetate, certain polyamides, epoxies, and low molecular weight polyester.

Pigments are added for producing opaque, colored finishes. Because nitrocellulose tends to be degraded in sunlight, some pigments extend the service life of films exposed to sunlight. Certain pigments should be avoided because they show alkaline reactions, which cause nitrocellulose degradation.

63.3.3 Cross-Linkable Coating Systems

Soluble nitrocellulose contains residual hydroxyl groups that may be utilized to prepare coatings that are cross-linked to other vehicle materials through these hydroxyls. Some groups that react with these hydroxyls are methylolamino and alkylated methylolamino groups, isocyanates, and epoxides.

Catalyzed nitrocellulose-alkyd-aminoplast systems that will cure by acid catalysis. The nitrocellulose and the alkyd provide the hydroxyl groups. The aminoplast can be an alkylated urea- or melamine-formaldehyde resin. These systems are catalyzed to cross-link with a strong acid, such as *p*-toluenesulfonic acid or phenyl acid phosphate. The coatings produced are tough and solvent resistant and find application on kitchen cabinets. Once catalyzed, the system must be used promptly because the solution will gel with time.

Nitrocellulose-urethane systems are prepared from the reaction of a polyisocyanate with nitrocellulose. The coatings may be toughened by the addition of a polyol such as a polyester, acrylic, vinyl, or alkyd polyol. Each of these polyols will give different properties. Conventional urethane catalysts, such as zinc octoate, may be used to speed up the cross-linking.

Epoxy-containing resins may be used; but since the available hydroxyls in nitrocellulose are less reactive than the usual polyols in epoxy systems, they are not used extensively for coatings systems.

63.3.4 Safety Considerations

Some basic safety precautions must be observed because nitrocellulose is a very flammable material. It is sold wetted with some material such as ethanol or isopropanol, which lowers its flammability. It should never be allowed to dry, because then it is extremely flammable. No spark-producing sources, flames, or heat or static electricity sources should come into proximity of nitrocellulose. Nitrocellulose containers should be kept tightly closed. Smoking must be prohibited when handling nitrocellulose or its solvents, diluents, or solutions. Safety procedures are contained in National Fire Protection Association (NFPA) Standard 35, Manufacturing Chemists Association Chemical Safety Data Sheet SD-96, the Hazardous Materials Regulations of the U.S. Department of Transportation (009) and the U.S. Occupational Safety and Health Standards, Part 1910.

Appendix: Typical Properties of RS Nitrocellulose

General Properties

Odor of material	None
Taste of material	None
Color of film	Water-white
Clarity of film	Excellent

Physical Properties of Solid or Film

Bulking value in solution	0.0704 gal/lb
Specific volume in solution	16.26 in. ³ /lb
Specific gravity of cast film	1.58–1.65
Refractive index, principal	1.51
Light transmission, lower limit of substantially complete	3130

Electrical Properties of Unplasticized Film

Dielectric constant at 25–30°C	
60 Hz	7–7.5
1 kHz	7
1 MHz	6
Power factor at 25–30°C	
60 Hz	3–5%
1 kHz	3–6%
Electric charge on rubbing with silk	Negative

Mechanical Properties of Unplasticized Film

Tensile strength at 23°C, 50% relative humidity	9000–16,000 psi
Elongation at 23°C and 50% relative humidity	13–14
Flexibility of 3- to 4-mil film, MIT double folds under 200-g tension	30–500
Hardness, Sward, of glass	90%
Softening point range (Parr)	155–200°C

Solubility and Compatibility Characteristics

Solvents, principal types	Ester, ketones, ether-alcohol
Resins, compatible types	Almost all
Plasticizers, compatible types	Almost all including many vegetable oils
Waxes and tars, compatible types	None
Compatible cellulose derivatives	Ethyl cellulose, cellulose acetate, ethylhydroxyethyl cellulose

Chemical and Physical Properties of Unplasticized Clear Film

Moisture absorption at 21°C in 24 h in 80% relative humidity	1.0%
Water vapor permeability at 21°C	2.8 g/cm ² /cm/h × 10 ⁶
Sunlight effect on discoloration	Moderate
Sunlight effect on embrittlement	Moderate
Aging	Slight
Effect of cold water	Nil
Effect of hot water	Nil
General resistance:	
Acids, weak	Fair
Acids, strong	Poor
Alkalies, weak	Poor
Alkalies, strong	Poor
Alcohols	Partly soluble
Ketones	Soluble
Esters	Soluble
Hydrocarbons	
Aromatic	Good
Aliphatic	Excellent
Oils	
Mineral	Excellent
Animal	Good
Vegetable	Fair to good

Source: *Nitrocellulose* (technical brochure), Hercules Incorporated, Wilmington, DE.

64

Soybean, Blood, and Casein Glues

64.1 Soybean Glues	64-1
Preparation • Wood Glues • Blends	
64.2 Blood Glues	64-4
Preparation • Formulation	
64.3 Casein Glues	64-7
Preparation • Formulation	
References	64-10

Alan Lambuth

Boise Cascade

64.1 Soybean Glues¹⁻⁸

64.1.1 Preparation

Of all the available agricultural “seed meals,” only soybean meal has ever developed any significant use as a raw material for wood glues. The principal reason is that its protein content, the active constituent for adhesives, is the highest available among commercial seeds and legumes. The protein assay of oil-free soybean meal ranges from about 35 to 55% on a dry basis and averages 44 to 50% in commercially blended soybean meals and flours. The remaining dry meal content consists of about 30% carbohydrates, 3% fiber, and 6% ash.

In addition to protein, soybeans contain a very high percentage of triglyceride oil, which is useful in many ways. As a result of this unusually high content of both edible protein and unsaturated oil, soybeans have been a very important agricultural crop to mankind for about 5000 years. In view of this long history as a foodstuff, the use of soybeans in adhesives for wood is a very recent development, dating only from about 1920.

In practice, the oil is removed from coarse-ground soybean meal by high pressure extrusion or solvent extraction. The two products are then sold separately into their respective markets. The extracted soybeans, as meal or flour, are widely used for human nutrition around the world. For these food applications, soybean meal is deliberately heated or “toasted” during processing at temperatures above 160°F to enhance the digestibility of its proteins and carbohydrates. When soybean meal is intended for adhesive uses, the processing temperature is carefully maintained below 160°F, to preserve the alkaline solubility of its protein content. To further prepare it for adhesive applications, oil-free soybean meal is ground to an extremely fine flour, mostly through a 325-mesh screen. At this fineness, measurements for process control must be made by a standard test of fine powders for specific surface, calibrated in square centimeters per gram. The normal range of specific surface for “adhesive grade” soybean flour is 3000 to 6000 cm²/g.

TABLE 64.1 Typical High Alkali Formulation for Soybean Glue

Component	Parts by Weight
Water at 60–70°F	175
Adhesive-grade soybean flour	97
Pine oil or diesel oil defoamer	3 ^a
Mix 3 min or until smooth	
Water at 60–70°F	145
Mix 2 min or until smooth	
Fresh hydrated lime (as a slurry in)	12
Water at 60–70°F	24
Mix 1 min	
50% sodium hydroxide solution	14
Mix 1 min	
Sodium silicate solution	25 ^b
Mix 1 min	
Orthophenyl phenol	5
Mix 10 min	

^aNormally blended with the soybean flour for dust control.

^b8.90% Na₂O, 28.7% SiO₂, 41° Baumé.

64.1.2 Wood Glues

To become an adhesive for wood or paper, soybean flour must first be wetted with plain water and then reacted with a strong alkali such as sodium hydroxide or trisodium phosphate. (The alkali should not be present during initial wetting, or permanent lumps of dry flour will form.) The chemical action of the alkali on wetted soybean flour particles is to unfold or “disperse” their complex protein structure, making all functional sites available for reaction with wood functional groups. The carbohydrate content of soybean flour becomes similarly dispersed. While this alkaline dispersion step is essential for converting soybean proteins into useful adhesives, it also starts a slow process by which the same proteins gradually lose viscosity and adhesive efficiency through hydrolytic destruction. As a result, soybean glues have a definite working life, usually 6 to 8 h at inside temperatures. Fortunately, the acids in wood neutralize most of the dispersing alkali shortly after glue application, so the dry adhesive bonds of soybean glues to wood surfaces are preserved indefinitely.

As the strong alkali in soybean glue reacts with wood, it causes a distinctive brown discoloration called alkali stain. This prominent glue line discoloration has limited the use of soybean adhesives in fine furniture and paper products, for example. As a result, soybean adhesives have found their widest application in structural and paint-grade wood products such as plywood, millwork, flush doors, and prefabricated assemblies. It is possible to prepare nonstaining soybean glues for wood and paper by using much milder alkaline dispersing agents such as calcium or ammonium hydroxide. However, the full adhesive potential of soybean protein is not developed by these moderate alkaline treatments. The resulting glues yield significantly lower bond strengths, adequate for paper and chipboard but not really satisfactory for structural wood joints.

Typical high and low alkali adhesive formulations are given in Table 64.1 and Table 64.2. The high alkali glue mix was used successfully from about 1930 to 1960 to bond interior-grade soft-wood structural plywood.

The addition of hydrated lime and sodium silicate in the high alkali formulation accomplishes two purposes: it helps maintain a level glue viscosity for a longer working life, and it improves the water resistance of the cured adhesive bond by forming water-soluble proteinates. Orthophenyl phenol imparts long-term mold and bacteria resistance to soybean adhesive bonds when glued wood products are intended for use in highly humid locations. It is currently approved by the U.S. government for this purpose.

Since the alkaline pH of calcium hydroxide is so moderate, lime and soybean flour can also be blended into a single dry package, requiring only the addition of water (in two steps) to prepare the adhesive.

TABLE 64.2 Typical Low Alkali Formulation for Soybean Glue

Component	Parts by Weight
Water at 60–70°F	225
Adhesive-grade soybean flour	97
Pine oil or diesel oil defoamer	3 ^a
Mix until smooth	
Water at 60–70°F	150
Mix until smooth	
Fresh hydrated lime (as a slurry in)	30
Water at 60–70°F	50
Mix 5 min	

^a Normally blended with the soybean flour for dust control.

This formulation has been used extensively as a briquetting binder for charcoal and other powdered materials and for paper laminating to wood.

One of the big advantages of soybean glues over many synthetic resin adhesives is their capability to be cured either hot or cold. Hot curing is accomplished in a conventional steam or oil-heat press at temperatures between 230 and about 270°F. For plywood, a pressure of 175 psi is generally employed. Curing time is about 1.5 min per quarter inch of panel thickness, the higher press temperatures being used for the thicker panels. On dry wood, the cold curing of soybean glues is accomplished in an unheated press at about 150 to 175 psi in 15 min. During this clamping cycle, the soybean glue film develops a sufficient gel strength by dehydration into dry wood to hold the plies tightly in contact when pressure is removed. Complete adhesive cure develops at room temperature over the next several days, but machining can begin in about 6 h. This widely used and patented procedure was called the Noclamp Process. It is unique to soybean-based adhesives and certain low soluble blood glues.

64.1.3 Blends

Another unique feature of soybean proteins as adhesives is their compatibility with other protein adhesive materials to yield “blend glues” of enhanced performance properties. The two most widely used combinations have been with dried soluble animal blood and with milk casein. In each case, the somewhat granular dispersed consistency of the soybean glue adds useful working and curing properties to those of the two animal-derived proteins. The normal combining limits are between about 20:80 and 80:20 soybean to animal protein, depending on the performance properties desired. Examples of these blended protein adhesives may be found in Sections 64.2 and 64.3.

For applications requiring extremely smooth and fluid soybean glues, more in the nature of size coatings, soybean proteins are available as extracted and dried powders at somewhat higher cost. Typical uses would be as paper overlay adhesives, boxboard adhesives, water-based paint binders, and paper sizes. For structural wood bonding, they are not as cost effective as soybean flour adhesives and they also tend to flow excessively in wood joints under pressure. Table 64.3 describes a typical paper overlay glue.

This glue is extremely smooth and stable. Its formulation illustrates the use of a formaldehyde donor, in this case, hexamethylenetetramine, to partially cross-link the dispersed protein for longer working life and improved water resistance. Other formaldehyde sources and additional compounds have been widely used with soybean glues for these purposes. The additions are always small, about 1%, and are usually made at the end of the mix.

For sizes and coatings, other moderately alkaline salts are frequently used to disperse fine soybean flour or extracted soybean protein. These include the sodium or potassium carbonates, phosphates, and borates, as well as ammonium hydroxide. The borates offer some advantage with soybean flour, as they also complex the carbohydrate constituents to yield increased viscosity and improved tack. None of these compositions can be considered to be adhesives in the structural wood bonding sense, however.

TABLE 64.3 Extracted Soybean Protein Formulation

Component	Parts by Weight
Water at 65–75°F	385
Extracted soybean protein	100 ^a
China clay	100 ^a
Powdered sodium sulfite	1 ^a
Pine oil or diesel oil defoamer	1 ^a
Mix 15 min	
50% sodium hydroxide solution	6
Mix 15 min	
Hexamethylenetetramine in	6
Water at 65–75°F	6
Mix 5 min	

^a Optionally blended together.

64.2 Blood Glues^{4,6,9–13}

64.2.1 Preparation

Animal blood has a very long history of use as an adhesive in lime mortars, cements, and wood glues. From the Far East to the Baltic to the early Americas, there have been legends and reports of independently discovered adhesives applications from blood. In all cases, the raw material was fresh whole blood, which was subject to rapid spoilage. This undoubtedly limited broader historical uses for blood protein glues.

Blood adhesive technology as we know it today began in about 1900 with the development of a commercial method for drying fresh whole blood without causing it to lose water solubility. Once this had been accomplished, blood proteins could be dried and stored indefinitely for use on demand. The only preparatory step needed was the removal from freshly collected animal blood of the clotting substance fibrin, to make the blood stable for processing.

The most commonly available dried animal bloods are beef and hog, with a lesser quantity from sheep. On a worldwide basis, their primary uses at this time are as protein-rich feed supplements and edible binders for domestic animal and pet foods. In certain cultures these bloods are used extensively for human nutrition. Poultry blood, which has a very high lysine content (and too low an intrinsic viscosity for adhesives), is used exclusively as a feed supplement.

For most food applications, whole blood is quickly coagulated to total insolubility with dry heat or steam. For adhesive applications, it is very carefully dried in vacuum pan ovens or spray dryers to yield controllable levels of cold water solubility. Dried bloods in the range of 80 to about 93% solubility (marketed as high soluble bloods) dissolve almost completely in cold tap water. On the addition of alkali to the water, they become extremely smooth, livery gels. Dried blood particles in the range of 25 to 40% solubility (low soluble bloods) are really wetted only in cold water. They require the addition of a fairly strong alkali to the water to become completely dissolved and dispersed into useful adhesive form. Their dispersed consistency is always quite grainy, a characteristic that is particularly useful for certain types of adhesive, described later. Dried bloods in the 40 to 70% solubility range have intermediate dispersed consistencies, tending toward smoothness as the solubility level rises.

64.2.2 Formulation

The adhesive constituents of dried animal blood include serum albumin and globulin and also red cell hemoglobin. Collectively, they provide nearly 100% adhesive-functional proteins in dried blood solids. Due to differences in composition and proportions of these proteins in the blood from various animals, there is wide variation in alkaline dispersed viscosity levels among soluble bloods, hog yielding the lowest

TABLE 64.4 Typical Commercial Formulation for Blood Glue

Component	Parts by Weight
90% soluble dried animal blood	100
Water at 60–70°F	80
Mix 3 min or until smooth	
Water at 60–70°F	60–120 ^a
Mix until smooth	
Ammonium hydroxide, specific gravity 0.90	6
Mix 3 min	
Powdered paraformaldehyde (sift in slowly while mixing)	15
Allow to stand 30 min	
Mix briefly until glue is fluid and smooth	

^a Variable for viscosity control.

and beef the highest. There are also significant viscosity variations within blood samples from a single species due to differences in age, activity, and nutrition. As a result, commercial lots of dried blood for adhesive uses are always blended in large quantities to help maintain uniformity of glue performance.

In formulating adhesives from soluble animal bloods, the dry powder must be initially wetted and redissolved in plain water. The wetted blood is then subjected to one or more alkaline dispersing steps to unfold the protein molecules and render them fully adhesive. (If the initial water is alkaline, permanent lumps will form.) Unlike the vegetable proteins in legumes such as soybeans, high soluble bloods can be adequately dispersed with moderately alkaline compounds including hydrated lime and ammonia to become useful wood adhesives. Simple dispersions of this kind represented the earliest class of blood-based adhesives discovered and used around the world. Much later it was learned that the addition to simple blood dispersions of chemical cross-linkers such as aldehydes greatly increased their water resistance. Glues of this type were successfully used during and after World War I to bond aircraft propeller laminations and other structural components. In this form, blood glues represented the most water-resistant wood bonding adhesives available until the advent of phenol-formaldehyde resins about 1932. Table 64.4 gives a commercial example.

Ammonium hydroxide yields sufficient dispersion at moderate alkalinity to expose most of the adhesive-functional polar groups on the protein structure. The paraformaldehyde actually gels the blood protein briefly, but it thins out again to yield a workable adhesive viscosity. The useful life is about 8 h. This glue delivers adequate bonds when cold pressed, but it provides the most water-resistant bonds if hot pressed to a minimum attained temperature of 160°F.

During World War II and for 20 years thereafter, blood protein glues were used extensively in the manufacture of interior and intermediate grades of structural plywood (water-resistant but not water-proof). By this time it was found that the highly alkaline multistep dispersion techniques employed with soybean glues yielded excellent consistency and adhesion when applied to dried animal bloods in the lower range of solubility. The resulting glues were used in large quantities to bond structural plywood until about 1960. (See Table 64.5.)

Since prior heat treatment of the blood itself has already reacted or “denatured” a significant portion of its protein content toward insolubility, glues of this type bond strongly and develop significant water resistance when cured without heat. In addition, the lime and silicate dispersion steps yield protein derivatives, which further insolubilize these blood glues upon cold curing. For optimum bond strength and weather resistance, however, hot pressing to a minimum glue line temperature of 160°F is still recommended. Whether cured hot or cold, blood glues of this type normally meet the published mold resistance requirements for plywood without the addition of preservatives.

Another form of blood glue employed extensively from World War II until about 1960 (and again during the petrochemical shortage of the 1970s) involves blends of high soluble blood with “adhesive-grade” soybean flour. In this combination, blood protein provides the water-resistant bonds and rapid hot cure, while the soybean flour provides the desired granular consistency for machine application and

TABLE 64.5 Typical Commercial Formulation for High Alkaline Blood Glues

Component	Parts by Weight
Water at 60–70°F	300
20% Soluble dried animal blood	75
200-Mesh wood flour	22 ^a
Diesel oil (defoamer)	3 ^a
Mix 3 min or until smooth	
Water at 60–70°F	330
Mix 2 min or until smooth	
Fresh hydrated lime (as a slurry in)	10
Water at 60–70°F	20
Mix 1 min	
50% Sodium hydroxide solution	16
Mix 10 min	
Sodium silicate solution	35
Mix 5 min	

^a Normally dry blended with the dried blood for easier handling and dust control.

^b 8.90% Na₂O, 28.70% SiO₂, 41° Baumé.

TABLE 64.6 Typical Commercial Formulation of a Blood–Soybean “Blend Glue”

Component	Parts by Weight
Water at 60–70°F	180
Adhesive-grade soybean flour	62
93% Soluble dried animal blood	25
200-Mesh wood flour	10 ^a
Pine oil or diesel oil defoamer	3 ^a
Mix 3 min or until smooth	
Water at 60–70°F	260
Mix 2 min or until smooth	
Fresh hydrated lime (as a slurry in)	8
Water at 60–70°F	16
Mix 1 min	
Sodium silicate solution ^b	40
Mix 1 min	
50% sodium hydroxide solution	10
Mix 5 min	
Orthophenyl phenol	5
Mix 5 min	

^a Normally blended with the soybean flour and dried blood for dust control.

^b 8.9% Na₂O, 28.70% SiO₂, 41° Baumé.

assembly time tolerance and, in addition, reduced cost. A commercial example of these so-called blend glues is given in Table 64.6.

Unlike straight, low soluble blood adhesives, soybean–blood blend glues must be hot pressed to ensure adequate water resistance and must also contain a preservative. As an alternative to orthophenyl phenol, final additions of alkaline phenol-formaldehyde liquid resins (resoles) have proved effective for imparting mold resistance to these blend glues. About 15 lb of a 43% solids phenolic plywood adhesive resin would serve well in the formulation of Table 64.6.

Up to this point, the adhesives discussed have relied on alkaline dispersed animal or vegetable proteins as the active ingredients. Another type of protein-containing wood glue is commercially significant, namely, alkaline phenol-formaldehyde (PF) resin adhesives fortified with soluble dried blood. In this

TABLE 64.7 Typical Commercial Formulation of PF Resin Adhesive Fortified with Dried Blood

Component	Parts by Weight
Water at 70–80°F	291
200-Mesh nutshell flour, or equivalent cellulosic extender	100
Industrial wheat flour	30
Dried 90% soluble animal blood	30
Mix 2 min or until smooth	
50% sodium hydroxide solution	30
Mix 20 min	
Diesel oil (defoamer)	6
41% solids alkaline phenol formaldehyde plywood adhesive resin, added slowly	1500
Mix 5 min or until smooth	

case, the PF resin solids are the principal adhesive constituents, yielding completely waterproof bonds. The blood proteins are also fully durable when cured in a matrix of phenolic solids. In addition, however, they provide the benefit of considerably shorter hot press curing times compared with straight resin adhesives. The blood proteins in this mix, fully dispersed by resin alkalinity, quickly develop a very adequate initial heat-cured bond. The phenolic resin polymers cure more slowly but completely by means of latent heating as the bonded product (plywood) is not stacked after a relatively short pressing cycle. For an example of this combined adhesive, see Table 64.7.

The presence of blood protein in this alkaline adhesive mix allows the normal phenolic resin hot press curing times to be reduced about 30%. The blood solids are considered to be additive to the phenolic resin solids in terms of contributing to exterior durability.

Currently, a blood–phenolic resin glue similar to this one is being used as a foamable adhesive that permits glue application by extrusion onto dry veneer. After veneer assembly, plywood is produced by hot pressing in the normal manner. The only formulation change needed is a substitution of surfactant for defoamer to promote air entrainment by the dispersed blood protein. (A special intensive mixing device is employed.) This “air extension” of the phenolic adhesive permits a 25% reduction in glue application weights with no apparent loss of adhesion or durability.

A few additional observations may assist in understanding the proper applications for blood protein adhesives.

Virtually all blood glues are dark reddish-brown. As a result, they are generally excluded from applications in which low color glue lines are a requirement (e.g., furniture, fine millwork, paper bonding).

Alkaline-dispersed blood glues are unusually sensitive to curing with heat. Thus, their use is well worth considering when rapid hot pressing is essential.

When cured cold, alkaline low soluble blood glues perform as well as soybean glues in utilizing a patented short clamping cycle of 15 to 20 min for plywood and flush doors. The gel strength developed in this length of time is adequate to maintain the bond between the plies after pressure is released while full cure is still developing (U.S. Patent 2,402,492).

The working life of alkaline blood glues is about 8 h at room temperature. By this time, the dispersing alkali itself has begun to degrade the adhesive protein structure through hydrolysis. The addition of complexing chemicals such as formaldehyde donors helps to control this reaction and lengthen useful adhesive life.

Blood proteins have some use in paper bonding if the colored hemoglobin is removed from the remaining serum constituents. The resulting protein mixture is similar to casein in most ways and in performance and is utilized in much the same way.

64.3 Casein Glues^{9,14-19}

64.3.1 Preparation

According to archaeological evidence, the adhesive qualities of casein curd from milk were recognized by civilizations as early as that of the Egyptians. The record of the actual use of casein as a glue is more

detailed from medieval European history, however. By that time, aqueous mixtures of casein with lime or other alkaline materials were being used for furniture gluing, paint pigment binding, and canvas sizing, to name just a few applications. In the area of furniture and musical instrument assembly, casein glues competed with gelatin glues extracted from animal bones and hides. The gelatin glues were applied hot and yielded quick bonds on cooling. However, they remained permanently sensitive to heat and moisture. Alkaline casein glues stayed fluid and sticky at room temperature for a considerable length of time, permitting the complex assembly of parts, but they did require clamping until cured. The hardened casein glue bonds had a substantial degree of heat and moisture resistance. It is these attributes of casein glue that have characterized its performance from early history down to the present; namely, long working or assembly time tolerance, cold-clamping until cured, and significant heat and moisture resistance.

Casein protein is recovered from skim milk by acid precipitation at a pH of about 4.5. Mineral acids can be used to promote precipitation, or the milk can be cultured with a *Lactobacillus* that converts milk sugar to lactic acid, which in turn precipitates the casein. In either case, the precipitated casein curd is washed free of acid, dried, and ground. Casein is frequently identified for sale by the method of its precipitation (i.e., “lactic acid casein”).

Because of the widespread use of milk and its by-products as foods, the price of industrial casein tends to rise and fall with the balance of production versus demand for dairy foods on world markets. Currently, the price is \$2.50 per pound for edible-grade ground casein, which causes casein-based glues to be fairly expensive adhesive systems. At other times the price per pound may be a dollar or less. Regardless of current price, the unique properties of casein glues will generally justify their continued use.

In preparing casein for use as a wood glue, the ground product is screened to provide a particle size range of about 30 to 60 mesh. Coarse particles are recycled. Finer particles become the raw material for a variety of paper sizes and adhesives, ranging in application from foils to labels to cigarette paper gluing and bookbinding. The reason for the limited particle size range in casein woodworking glues is related to their formulation and storage as one-package dry compositions requiring only the addition of water to yield working adhesives. These dry compositions contain a substantial proportion of ground casein plus one or more alkaline salts in granular form that provide dispersing alkalinity as soon as water is added. The entire dry composition is oiled with a petroleum product, typically diesel oil, to prevent the absorption of atmospheric humidity during storage and to slow the rate of solubility of all constituents when water is added. This permits all the casein particles to become uniformly wetted in essentially neutral water. Since some alkalinity is present in the mixing water almost immediately, any finely ground casein particles present in the dry composition will quickly form permanent encapsulated lumps. Thus, casein fines simply cannot be present.

64.3.2 Formulation

In commercial practice, at least two alkaline agents are used in the formulation of modern casein woodworking glues. A carefully controlled proportion of hydrated lime is present to promote a gradual reaction with the dispersed casein protein to form calcium caseinate, which contributes significantly to water resistance. Strongly active alkali metal salts such as trisodium phosphate, sodium carbonate, and sodium fluoride (which forms sodium hydroxide by double decomposition with lime) are also included to accomplish complete protein dispersion. Together, they convert the casein granules into a slick, viscous consistency, which is an excellent cold or hot press-curing adhesive for wood. Some cellulosic filler may also be included to provide glue application control and gap-filling properties. Table 64.8 gives a typical casein lumber laminating composition. The dry ingredients are intensively blended in an appropriate mixer while defoamer is sprayed in slowly to provide uniform distribution. The dimethylol urea, a very effective protein cross-linker and denaturant, is added in small variable amounts for glue viscosity control. The casein materials described in Table 64.8 would be mixed as follows: 200 lb of water at 60 to 70°F and 100 lb of dry glue (as in Table 64.8) for the following steps:

1. Mix 2 min or until smooth and thickening begins.

TABLE 64.8 Typical Casein Lumber Laminating Composition

Dry Glue Composition	Parts by Weight
30–60-Mesh lactic acid casein	30
30–60-Mesh sulfuric acid casein	30
200-Mesh wood flour	10
Fresh hydrated lime	13
Granular trisodium phosphate	8
Granular sodium fluoride	4
Powdered dimethylol urea	0.1
Diesel oil (defoamer)	2.9
Sodium orthophenylphenate	2
	100

TABLE 64.9 Single-Package Casein Glue for Use in Fire Doors

Dry Glue Composition	Parts by Weight
“Adhesive-grade” soybean flour	58
60-Mesh lactic acid casein	19
Fresh hydrated lime	7
200-Mesh wood flour	5
Granular sodium carbonate	5
Granular sodium fluoride	2
Granular trisodium phosphate	1
Diesel oil (defoamer)	3
	100

2. Let stand 15 min or until thinning has occurred.
3. Mix 2 min or until smooth.

The early thickened stage through which these adhesives pass requires strong agitation, preferably with counterrotating paddles and a sidewall scraper blade.

Casein adhesives of this type were widely used for lumber laminating, specialty gluing, and millwork assembly from 1930 to 1970, more or less, before being supplanted by the newer synthetic resin adhesives. Their long assembly time tolerance and cold cure made the casein adhesives ideal for manufacturing very large curved laminated beams, for example. Similarly, their gap-filling properties, moisture resistance, and deep adhesion to almost any wood surface contributed to their reputation as one of the finest general-purpose wood adhesives ever developed from a natural source.

One current application for casein glues that has not yet been preempted by synthetic resin adhesives is its use in panel and flush door assembly. For this application, casein is used in combination with adhesive-grade soybean flour to yield alkaline-dispersed protein glues of composite performance. Casein contributes deep bonds, tacky consistency, and heat resistance (particularly important for fire doors), while soybean flour contribute the granular consistency that permits quick water loss and a short clamping cycle cold cure. The fire door application (Table 64.9) is essentially unique among protein glues. As before, this is a single-package adhesive that requires only the addition of water.

The dry ingredients are intensively blended in an appropriate mixer while the defoamer is sprayed in slowly to provide uniform distribution. From the standpoint of glue consistency, the proportion of casein shown is about the maximum at which short cycle clamping of doors and millwork is still possible. Mixing directions are as follows: 200 lb of water at 60 to 70°F and 100 lb of dry glue (as in Table 64.9) for the following steps:

1. Mix 2 min or until smooth and thickening begins.
2. Let stand 15 min or until thinning has occurred.
3. Mix 2 min or until smooth.
4. Add 50 lb of water at 60 to 79°F, and mix 2 min or until smooth and fluid.

The second water addition may be varied to obtain the desired final viscosity. In general, casein glues perform best on wood in a viscosity range of about 4000 to 8000 cp at room temperature. The application rate to wood surfaces is about 70 to 90 lb per 1000 square feet of joint area.

Casein-containing adhesives for all forms of paper gluing are distinctly different in chemistry. For example, calcium and magnesium salts should *not* be present. Since these glues must be only mildly alkaline to avoid staining paper surfaces, a different approach to protein dispersion is employed. Typically, this involves preparing a stable casein solution containing 15 to 20% casein solids by using a mild alkali such as ammonium hydroxide or borax and then heating the solution to about 170°F for 10 to 15 min to complete the dispersion. Rapid cooling should follow to prevent degradation. Small amounts of preservatives, protein cross-linkers, and defoamers are frequently added to yield a storable product of the desired viscosity and running properties.

Casein solutions can be used alone, usually with further cross-linking and thickening, as label pastes, bag adhesives, and cigarette paper seam glues, and for a wide variety of other precision paper bonding applications. For these purposes, the same performance characteristics important to wood bonding recommend their use, namely, a sticky, wipe-resistant consistency, strong bonds to cellulose fibers, and significant water resistance.

Casein solutions are often combined with synthetic latex such as neoprene acrylic or styrene-butadiene to yield strongly adhering yet resilient paper coatings and adhesives. These combinations are specifically used for laminating metal foil to paper. The casein “glue” imparts a degree of rigidity for paper handling that the latex themselves tend to lack.

References

1. G. H. Brother, A. K. Smith, and S. J. Aricle, “Soybean protein.” Washington, D.C., U.S. Department of Agriculture, Bureau of Agricultural Chemistry, 1940.
2. R. S. Burnett, *Soybeans and Soybean Products*. New York, Wiley-Interscience, 1951.
3. A. L. Lambuth, “Soybean adhesives,” in *Handbook of Adhesives*. New York, Reinhold, 1962.
4. T. D. Perry, *Modern Wood Adhesives*. New York, Pitman, 1944.
5. Douglas Fir Plywood Association [now American Plywood Association], *Mold Resistance of Plywood Made with Protein Adhesives*, technical report, Tacoma, WA, DFPA, 1952.
6. U.S. Department of Agriculture Forest Products Laboratory, “Bonding wood and wood products,” in *Wood Handbook: Wood as an Engineering Material*. Agriculture Handbook 72. Madison, WI: USDA Forest Products, 1987.
7. J. Bjorksten, “Cross linkages in protein chemistry,” in *Advances in Protein Chemistry*, Vol. 6. New York, Academic Press, 1951.
8. Technical Association of the Pulp and Paper Industry, “Protein and synthetic adhesives for paper coating,” Monograph No. 9. Atlanta: TAPPI, 1952.
9. R. H. Bogue, *The Chemistry and Technology of Gelatin and Glue*. New York, McGraw-Hill, 1922.
10. U.S. Department of Agriculture Forest Products Laboratory, “Blood albumin glues: Their manufacture, preparation and application,” Laboratory Report No. 281–282. Madison, WI: USDA Forest Products Laboratory, 1938 (rev. 1955).
11. A. L. Lambuth, “Blood glues,” in *Handbook of Adhesives*. New York, Reinhold, 1962.
12. L. B. Lane and J. J. Frendries, “How blood adhesives are used.” *Adhes. Age*, May (1961).
13. Technical Association of the Pulp and Paper Industry, “Protein and synthetic adhesives for paper coating,” Monograph No. 22. Atlanta: TAPPI, 1961.
14. E. Sutermeister and F. L. Browne, *Casein and Its Industrial Application*. New York, Reinhold, 1939.

15. U.S. Department of Agriculture Forest Products Laboratory, "Casein glues: Their manufacture, preparation and application," Research Note FPL-0158. Madison, WI: USDA Forest Products Laboratory, 1967.
16. U. S. General Services Administration, "Adhesives, casein-type, water and mold resistant," Federal Spec. MMM A-125. Washington, D.C.: GSA, 1955.
17. D. M. Weggemans, "Adhesives application charts," *Adhes. Age*, October 16 (1973).
18. H. K. Salzberg, "Casein glues and adhesives," in *Handbook of Adhesives*. New York, Reinhold, 1962.
19. Technical Association of the Pulp and Paper Industry, "Protein and synthetic adhesives for paper coating," Monograph No. 9. Atlanta: TAPPI, 1952.

65

Fish Gelatin and Fish Glue

65.1	Introduction	65-1
65.2	Properties	65-1
65.3	Applications	65-2
	Remoistenable Coatings: Gummed Tape • Photoresists for Photochemical Machining • Dyed Patterns on Glass • Ceramic Stencils • Electrical Insulators • Temporary Protective Coatings • Plating Release Agents • Fish Gelatin in Photographic Coatings • Gelatin Capsules	
65.4	Conclusion	65-4
	References	65-4

Robert E. Norland
Norland Products, Inc.

65.1 Introduction

Fish gelatin, or fish glue, is a proteinaceous material extracted from the skins of deep cold-water fish such as cod, haddock, and pollock. The skin and bone of all animals and fish contain collagen, which can be hydrolyzed in hot water and dilute acid to form soluble gelatin.¹⁻³

The difference between gelatin and glue is in the extent of processing. A gelatin processed for photographic use would be exceptionally pure, of high molecular weight, and devoid of specific chemical impurities. An edible gelatin would be free of heavy metals, microorganisms, and any impurity that would make it unsuitable for human consumption. Inedible gelating or glue does not require as much refining and is suitable for industrial or adhesive applications, where less stringent requirements are found. Fish gelatin coatings are used in all these applications.

65.2 Properties

Fish gelatin is a long chain protein molecule containing 20 different amino acids. It is amphoteric; that is, it can react as a base or acid. End groups include hydroxy, carboxy, and amino. Reactivity of each group will depend on the pH of the gelatin solution. For example, the reaction of phthalic anhydride with gelatin on the alkaline side will produce a gelatin that will precipitate at pH 4.

Fish gelatin is insolubilized by the addition of salts of polyvalent cations such as ferric sulfate or chrome alum.⁴ This principle finds use in the light sensitivity of fish gelatin coatings containing bichromates. The action of ultraviolet light on the bichromated gelatin results in the formation of polyvalent chromium ions that insolubilize the light-struck area, leaving the unexposed areas water soluble.

Aldehydes such as formaldehyde, glutaraldehyde, and glyoxal will insolubilize gelatin. The aldehydes react with the amino end groups, and this occurs more quickly on the alkaline side.

Fish gelatin solutions are liquid at room temperature and, hence, make good coating vehicles. Many of the reactions above can be tailored so that water solutions can be coated and dried, and the dried coating then becomes insoluble.

Dried fish gelatin films are insoluble in organic solvents, but a water solution will tolerate water-miscible solvents. The following are tolerance levels of various solvents in 100 parts of 45% fish gelatin⁵:

- Acetone, 25 parts
- Ethyl alcohol, 50 parts
- Methyl cellulosolve, 95 parts
- Dimethylformamide, 110 parts

Dried fish gelatin coating will not soften at elevated temperatures and can withstand temperatures up to 260°C. Baking at high temperatures ($\leq 275^\circ\text{C}$) will insolubilize gelatin coatings, but they can be stripped with dilute caustic and by proteinaceous enzymes.

The following are typical properties of fish gelatin and glue⁵:

- Color — clear, light amber
- Solids — 45% in water
- Viscosity at 20°C — 6000 to 8000 cp
- Average molecular weight — 60,000 d
- Gel point — 5 to 10°C
- Ash — 0.1%
- pH — 4.6 to 5.4

65.3 Applications

65.3.1 Remoistenable Coatings: Gummed Tape

Fish glue coatings are excellent for gummed tape, labels, and tags. The dried coating wets very easily and develops a tackiness that allows it to be bounded quickly to another surface. It is compatible with animal glue and can be added to increase the latter's tackiness.

The addition of a humectant will reduce curl of the coated paper. Glycerine, sorbitol, or glycols are suitable. Use 5 to 10% based on dry weight.

65.3.2 Photoresists for Photochemical Machining

Photochemical machining involves the manufacture of thin metal parts using a photoresist to image an acid-resistant stencil on the metal sheet.^{6,7} Photoengraving glue, a clarified fish gelatin, is used as the base for a water-soluble photoresist.⁸ The advantage over using a solvent-type organic photoresist is the ease of processing, as no organic solvents are required. Water solutions are used in the entire process. One suggested formula consists of 100 parts by weight, photoengraving glue (45%) 10 parts by weight ammonium bichromate, and 125 to 200 parts by weight water.

The amount of water to be added can be varied to give a specific coating viscosity. A coating thickness of 0.15 to 0.25 mil (4 to 6 μm) is sufficient for etching cold rolled steel, stainless steel, and copper up to 10 mil thickness. This coating is sensitive to ultraviolet light (300 to 400 nm) and will have a shelf life of 2 to 5 days, depending on solids and storage temperatures.⁹

Care must be taken in the use of ammonium bichromate. It is listed as a hazardous chemical, and users must conform to environmental laws. Untreated wastewater containing bichromate should not be discharged into the sanitary sewer or any other water supply.

65.3.3 Dyed Patterns on Glass

Bichromated photoengraving glue images also have good adhesion to glass. These images can be dyed using anionic water-soluble dyes. The same formulation given above can be used, but viscosities must

be reduced to obtain a thickness of 0.10 mil (2.5 μm). Images of 10 μm wide or less are possible, and these can be reproduced very accurately.

For very fine reticles on glass, silver wash-off emulsions can be made using fish gelatin. Silver chloride is precipitated in diluted fish gelatin by the dropwise addition of silver nitrate and sodium chloride. Upon completion, the emulsion is precipitated by the addition of 10% polystyrene sulfonate based on dry gelatin weight and adjustment to a pH 4. This precipitates the emulsion, and the remaining liquid containing dissolved salts is poured off. The emulsion is redissolved by neutralizing and sensitized by the addition of ammonium bichromate or an organic sensitizer such as 4,4'-diazidostilbene-2,2'-disulfonic acid. Spin coating on glass will result in a 0.1 mil (2.5 μm) coating. After exposure to ultraviolet light through a negative and washing, an image will appear on the glass. This image can be made black by using a photographic developer such as Eastman Kodak Dectol.

65.3.4 Ceramic Stencils

Colored pigments can be ball milled into fish glue. These inks can be stamped or stenciled onto ceramic parts and the resultant image fired to fix the pigment to the ceramic part.

65.3.5 Electrical Insulators

Fish gelatin, purified to have low ash, can be coated and then baked to reduce the water sensitivity. The coating will have electrical insulating properties.

65.3.6 Temporary Protective Coatings

Because of their water solubility, fish gelatin coatings can be used as temporary protective coating on metal parts during mechanical processing and handling. When complete, the parts are washed with a dilute alkaline cleaner to provide a chemically clean and sterile surface.

65.3.7 Plating Release Agents

Fish gelatin is a liquid protein solution of high molecular weight that has a good attraction to clean metal surfaces. When a clean metal plating master is dipped into a dilute solution, a monomolecular layer attaches itself to the metal surface, which acts as a releasing agent after plating. After plating on the master, the negative can be separated easily by starting at one edge and peeling the two pieces apart. The master is then recleaned, dipped into the dilute gelatin solution, and replated.

65.3.8 Fish Gelatin in Photographic Coatings

Fish gelatin can be used in the silver halide emulsion system. Because fish gelatin solutions are liquid at room temperature (down to 10°C), silver halides can be precipitated at temperatures less than required for animal gelatin. The resultant emulsion can be washed of soluble salts by using any of the common precipitating agents such as polystyrene sulfonate.³

Photographic film usually requires a sublayer between the emulsion and the film to increase the adhesion of the emulsion to the film. Photographic film also requires a back coating of gelatin to balance the curling stresses of the emulsion coating. Fish gelatin can be used in both these applications.

65.3.9 Gelatin Capsules

Fish gelatin added to animal gelatin will reduce the softening point of animal gelatin capsules, and the resultant capsules will dissolve more readily. [Table 65.1](#) gives an example of the effect on gelling temperature of the addition of fish gelatin to animal gelatin.

TABLE 65.1 Effect on Gelling Temperature of Varying Amounts of Animal and Fish Gel

Animal Gel (%)	Fish Gel (%)	Gelling Temperature (°C)
100		32
75	25	30
50	50	26
25	75	24
15	75	20
10	90	19
5	95	17
	100	8

65.4 Conclusion

Fish gelatin and fish glue have the following features:

- Supplied as a pourable liquid
- Completely water soluble
- Excellent adhesion to metal, rubber, glass, leather, cork, wood, and paper
- Act as protective colloids to suspend small particles or monomers in solution
- Coatings can be made water resistant and insoluble in water
- Insoluble coatings will accept water-soluble dyes
- Insoluble in organic solvents
- Dry to a hard, smooth finish

References

1. R. A. Berg, "Fish gelatin in coating applications," in *Image Technology 1985* (38th Annual SPSE Conference), Atlantic City, NJ, pp. 106–109.
2. K. H. Gustavson, *The Chemistry and Reactivity of Collagen*. New York: Academic Press, 1956.
3. R. E. Norland, "Fish gelatin, technical aspects and applications," in *Proceedings of the Fifth Royal Photographic Society Symposium on Gelatin*, Wadham College, Oxford, 1985, pp. 266–271.
4. *Technical Data Photoengraving Glue Bulletin I*, Norland Products Inc., New Brunswick, NJ, 08902.
5. *Technical Data HiPure Liquid Gelatin*, Norland Products Inc., New Brunswick, NJ, 08902.
6. "Chemically milling precision parts," *Am. Mach.*, February 8 (1971).
7. J. F. Holhan, *Electronic World*, December (1965).
8. J. Kosar, *Light-Sensitive Systems*. New York, Wiley, 1965.
9. M. Sasaki and K. Honda, *Photosensitivity of Gelatin Films Containing Hexavalent Chromium Oxy-salts*. Graphic Arts of Japan, 1972, pp. 25–33.

66

Waxes

66.1	Introduction	66-1
66.2	Definition.....	66-1
66.3	Types	66-2
	Animal Waxes • Vegetable Sources • Mineral Waxes • Synthetic Waxes	
66.4	Coating Applications.....	66-4
	Mechanism • Property Enhancement • Incorporation Methods	
	References.....	66-6

J. David Bower

Hoechst Celanese Corporation

66.1 Introduction

A discussion on the use of waxes for coatings must begin with an explanation of what constitutes a wax. Because of the diverse nature of products included in the class of waxes, this is not a simple objective.

There are few references that discuss waxes and their applications. In 1956 A.H. Warth published a book that covered the types and applications of waxes available.¹ More recent general references on wax are a two-volume work entitled *Industrial Waxes* by H. Bennett² and *Wax: An Introduction* by R. Sayers.³ The Chemical Specialties Manufacturers Association (CSMA) has also published a booklet entitled *Technology of Waxes*, which contains several articles dealing with the chemistry and physical properties of waxes of various types.⁴

These are the major sources for information on waxes. Numerous articles are available, which may discuss one specific type of wax or cover an application area, often only casually mentioning wax usage.

66.2 Definition

In the medieval days (and earlier) the definition of waxes was very simple. Wax was the substance produced by bees that prevented the honey from running out the bottom of the hive. Beeswax was the only wax known. In 1848 Justus Liebig characterized beeswax as consisting predominantly of long chain fatty acids, esters, and alcohols. Several other natural waxlike products from plant and animal sources had a similar chemical makeup. The definition of a wax was still fairly vague. If the chain length of a substance was longer than the C₁₆ to C₁₈ associated with fatty acids, in a chemical sense, it was a wax.

In the 20th century, a large number of new products were introduced. Some of these were waxlike but did not conform to the chemical definition. People wanting wax defined by physical properties won out over those supporting a chemical definition. Therefore, products that have waxlike properties but are not based on long chain esters (e.g., paraffins and low molecular weight polyethylenes) are referred to today as waxes.

In 1954 the Deutsche Gesellschaft für Fettwissenschaft (DGF) established a wax definition based on physical properties and abandoned the efforts to maintain the chemical definition. A revised version was published in “DGF—Einheitsmethoden Abteilung M—Wachse” in 1975 (Table 66.1). The failure to put

TABLE 66.1 Definition of Wax^a from a German Technical Society

1. 20°C (68°F) kneadable solid to brittle hard
2. Macro to microcrystalline, translucent to opaque but not glasslike
3. Melting above 40°C (104°F) without decomposition
4. Relatively low viscosity slightly above the melting point
5. Consistency and solubility are strongly dependent on temperature
6. Capable of being polished (i.e., buffable) under slight pressure

^a The term “wax” is a collective name for a number of natural or synthetic substances. If, in borderline cases, more than one of these properties cannot be met by a substance, it does not represent a wax in the actual meaning of this definition.

Source: Einheitsmethoden, Abteilung M—Wachse, proposed in 1954 and revised in 1975 by the Deutsche Gesellschaft für Fettwissenschaft.

specific limits on most of the listed properties (e.g., no upper limit on melting property and no specific viscosity range) demonstrates the diverse properties of waxes. Only five of the six DGF properties must be met for a product to fall under the definition of wax.

66.3 Types

One generally attempts to classify waxes into one of the three basic categories of animal, vegetable, or mineral, but even this approach encounters difficulties. Mineral waxes are in reality primordial vegetation deposits subjected to pressure and millions of years of aging to form oil and coal (i.e., aged vegetable wax). A fourth classification is also needed for the numerous synthetic waxes that are derived from the three main sources. The question also arises as to how much refining and alteration of a wax can be made before it is no longer considered a natural wax but a synthetic wax.

66.3.1 Animal Waxes

Animal waxes are derived from two separate sources. One source is by-products produced by the animal (beeswax). The second source is from the animal itself (fatty acid derivatives).

Lesser known waxes include Chinese and shellac waxes obtained from secretions of various insects and wool wax refined from lanolin (extracted from sheep’s wool). Commercially, they are found only in a few specialized areas.

66.3.1.1 Fatty Acids

Fatty acids and their derivatives come from processing tallow and lard. These products are produced in very large volume. The production is often considered to be an industry in and of itself, and these materials are not always thought of as wax products. Chemically they consist of C₁₆ and C₁₈ esters of glycerine. Typical products are stearic acid, glycerol tristearates, and glycerol monostearates.

66.3.1.2 Beeswax

Beeswax is the oldest known wax. It consists of long chain fatty acids and long chain monovalent alcohols. The exact composition of beeswax is extremely complex, and even today an exact duplicate based on synthetic materials has not been accomplished.

66.3.2 Vegetable Sources

Vegetable waxes are obtained from the leaves, stems, or berries of plants. These waxes consist mainly of alkyl esters. Chain length and type vary considerably depending on the surface.

66.3.2.1 Leaf Waxes

Leaf waxes are obtained by extracting wax from the leaves. They are also referred to as palm waxes.

The leaf wax of greatest commercial significance, carnauba wax consists mainly of esters of alkyl alcohols (C_{24} to C_{34}) and alkyl acids (C_{18} to C_{30}). There are also substantial amounts of diesters and hydroxy esters. These hydroxy esters are believed to provide some of the unique paste forming properties and the ability to form microemulsions associated with carnauba wax.

Carnauba wax is extracted from the leaves of the carnauba palm (*Copernicia cerifera*), which grows in the north and northeast regions of Brazil. The tree is also grown in other regions (Sri Lanka, West Central Africa), but only in Brazil are weather conditions suitable (torrential rains followed by a hot, dry windy period) to form significant wax deposits on the leaves.

66.3.2.2 Stem Waxes

Stem waxes include flax wax, sugarcane wax, and bark wax (Douglas fir). Efforts to develop these waxes commercially have met with limited success.

66.3.2.3 Berry or Fruit Waxes

A large number of waxlike products are derived from the fruit of various plants. Some waxes exist in the natural state as an outer coating on the fruit (bayberry and Japan waxes). Another source is refined and modified vegetable oils (i.e., hydrogenation). The cocoa fatty acid groups (C_{12} to C_{14}) represent the largest segment, but these are marginally included in the category of waxes because most derivatives are soft and low melting.

Castor wax is derived from castor oil, which is obtained from the seeds of *Ricinus communis*, a plant that grows in most tropical regions. Castor oil is predominantly (90%) the triglyceride of 12-hydroxystearic acid, with a double bond in the 9–10 position. Hydrogenation of the double bond forms the castor wax.

66.3.3 Mineral Waxes

Mineral waxes are obtained from oil and coal deposits. The name “mineral wax” has nothing to do with the composition but derives from the source (which is beneath the earth’s surface). They are sometimes referred to as “earth waxes.”

66.3.3.1 Paraffins

Paraffins are extracted from oil. The amount and type of wax present depends on the source of the oil. The paraffin is normally separated from the oil, distilled into several fractions, and sold as commodity items by the oil refineries.

66.3.3.2 Microcrystalline Waxes

Microcrystalline waxes are normally the higher molecular weight fractions from the paraffin extractions. They vary in hardness and melt properties depending on molecular weight distribution and branching. The name “microcrystalline” evolved from the discovery that these higher melting paraffins were not amorphous but consisted, to a high degree, of microcrystalline structures.

66.3.3.3 Montan Waxes

Montan waxes are extracted from soft coal deposits located predominantly in Germany, where the wax content in certain coal deposits is 10 to 15%. The coal is crushed and extracted with solvents to yield a dark brown to black crude montan wax with a wax content of 50 to 60%.

66.3.4 Synthetic Waxes

66.3.4.1 Polyethylene and Polypropylene Waxes

Polyethylene waxes are made by polymerization of ethylene to form ethylene chains similar to polyethylene resin but much lower in molecular weight (2000 to 10,000). The waxes can be oxidized by a variety of methods to produce waxes that are emulsifiable.

Polypropylene waxes are formed by controlled polymerization of propylene.

66.3.4.2 Modified Montan Waxes

Modified montan waxes are derived from coal. The crude montan waxes are subjected to a series of solvent extractions and oxidized with chromium trioxide (CrO_3) generically referred to as the Gersthofen process. The CrO_3 selectively attacks tertiary carbon structures, leaving behind only the linear montanic esters and acids. After oxidation has been completed, a light-colored product consisting mainly of montanic acid is formed. The montanic acids can be reesterified with various alcohols and polyols and partially saponified to give a series of montan ester wax products having various properties.

66.3.4.3 Miscellaneous Synthetic Waxes

Fischer-Tropsch waxes are made by reacting carbon monoxide (from the coal gasification process) with hydrogen gas to form a hydrocarbon wax.

Polyglycol waxes are high molecular weight chains of ethylene oxide that form a wax-like product.

Oxidized hydrocarbons (paraffins, microcrystalline, and polyethylene waxes) are formed by oxidation (generally air blown) of hydrocarbon waxes to form a large variety of emulsifiable waxes.

66.4 Coating Applications

Various waxes are used in different application areas for coatings to enhance certain physical properties.

66.4.1 Mechanism

Waxes generally function by one of two basic mechanisms:

The “ball bearing” mechanism is a dispersion of discrete wax particles throughout the coating matrix.

The particles that protrude above the film surface prevent the abrading media from contacting the coating surface. Instead, the other surface glides over the protruding wax particles, causing little damage to the surface.

The “migration” mechanism involves migration of the wax to the film surface, where it aids in formation of a smooth glossy film. In some applications, the plastic nature of the wax aids in filling voids formed as the solvent evaporates or the specific volume changes during curing of the resinous components.

66.4.2 Property Enhancement

The major properties affected by waxes are surface related.

66.4.2.1 Gloss

A high gloss is obtained from waxes predominantly by the migration mechanism. The waxes tend to fill the microvoids formed as the coating dries to provide a smooth continuous film. Often only small amounts of waxes are needed (0.5 to 2% of solids) to obtain a gloss improvement. In fact, too much wax can lead to formation of wax solid on the surface, resulting in a dull haze. A high gloss can be obtained by buffing the surface (property 6 in [Table 66.1](#)), but this is not practical in most situations. If the excess wax were to continue to migrate, the haze could return after several days (or weeks).

66.4.2.2 Matting

A matte (flat) surface is the opposite of high gloss, but both effects can be obtained using waxes. To obtain a matting effect, the type of wax and method of incorporation must be chosen to maximize the “ball bearing” mechanism. The wax particles that protrude above the surface diffuse the light to reduce glare. Particle size is very critical in obtaining a smooth, silky matte finish that does not feel rough or look dull or hazy. Dispersibility in the paint or varnish vehicle is important to obtain a uniform surface.

Silicas are often used as matting agents, but their high density can lead to problems with settling out. Combinations of waxes and silica can lead to optimum effects. Using agents with differences in refractive indexes can further enhance matting effects without forming a haze.

66.4.2.3 Slip

Waxes can reduce the coefficient of friction by aiding in the formation of a smooth surface, as discussed in Section 66.4.2.1, or by reducing the number of contact points by gliding over the wax particles (ball bearing mechanism) discussed in Section 66.4.1.

Soft oily-type agents (soft, microcrystalline waxes or silicones) can also be used to form a slippery lubricating film on the surface. Mar resistance and blocking generally are very poor with this approach.

66.4.2.4 Abrasion Resistance

The ability of waxes to improve abrasion resistance is generally related to their ability to increase slip.

66.4.2.5 Antiblocking

Blocking can be reduced by incorporating hard wax particles (ball bearing mechanism) to reduce surface contact. A compromise in gloss must often be accepted. Some hard waxes can reduce blocking by absorbing oils and reducing the migration to the surface of other soft tacky components present in the coating formulation.

66.4.2.6 Antisettling/Antisagging Agents

When dissolved and cooled in solvent-based systems, many waxes form a thixotropic dispersion. The formation of a gel, which will liquify when stirred, will reduce the tendency of denser materials (pigments, fillers, etc.) to settle out.

66.4.3 Incorporation Methods

How a wax is incorporated into a coating formulation can affect the end performance. Particle size and uniformity of dispersion are critical factors. The best method depends on the type of wax and the desired end effect. Four basic methods are used.

66.4.3.1 Wax Compounds

Solvent-dispersed pastes are formed by heating the wax in a suitable solvent (ideally the same as the vehicle used in the coating formulation) and quickly cooling to room temperature under high shear conditions. The rapid cooling and high shear rates are required to prevent the formation of large seed crystals, which would appear as blemishes in the coating when applied.

Minor variations in the production of wax compounds can cause changes in the particle size distribution. Because of the sensitivity related to production conditions of wax compounds, most users rely on wax compound producers instead of preparing such waxes in-house.

66.4.3.2 Micronized Powders

Air milling and classifying the wax powder gives the optimum control of particle size. Micronized powders are based mainly on very hard, high melting waxes such as polyethylene waxes, amides, and polytetrafluoroethylene (PTFE). According to the wax definition, PTFE is not a wax, but because it is used in the same area associated with waxes, it is often included in discussions on wax applications. Attempts to prepare these waxes in a compound form is difficult. Their crystallinity invariably leads to formation of larger particles if the procedure is not properly done.

The dry powder reduces the handling of flammable and hazardous solvents often associated with waxy compounds. Both solvent- and water-dispersible grades are available. On the negative side, improper handling can lead to dusty conditions and explosion hazards. Micronized powders are also more expensive on a per-pound basis (however, greater efficiency can lead to lower use levels).

66.4.3.3 Milling

The wax can be obtained as a coarse powder and milled in the same manner as pigments, or along with the pigments. This approach provides the end user with wax at the lowest cost. However, the time involved and the cost of the equipment rarely justify the savings in raw materials. Those who currently use this approach do so because they already have the equipment, which would be idle otherwise.

66.4.3.4 Emulsification

This approach is limited to water-based systems. The emulsion can be prepared in-house, provided the equipment is available, or it can be supplied by outside producers. The wax must be an emulsifiable type. Most commonly used for emulsification are oxidized polyethylene waxes and the refined montan waxes.

References

1. A. H. Warth, *Chemistry and Technology of Waxes*, 2nd ed. New York: Reinhold, 1956.
2. H. Bennett, *Industrial Waxes: Vol. I, Natural and Synthetic Waxes; Vol. II, Compounded Waxes and Technology*. New York: Chemical Publishing Co., 1975.
3. R. Sayers, *Wax: An Introduction*. London: European Wax Federation and Gentry Books Limited, 1983.
4. "Wax technology," extracted from *Proc. Chem. Spec. Manuf. Assoc. 61st Mid-year*, pp. 86–111 (1975).

67

Carboxymethylcellulose

Richey M. Davis
Hercules Incorporated

67.1 Introduction	67-1
67.2 Coating Application	67-1
67.3 Coating Formulation	67-2
References	67-4

67.1 Introduction

Carboxymethylcellulose (CMC) is a charged, water-soluble polysaccharide derived from cellulose found in plants. It is used extensively in aqueous paper coatings for controlling coating viscosity. Aqueous paper coatings are colloidal suspensions consisting primarily of pigment, such as kaolin clay, and binders such as starch or latex. The solid concentrations typically range from 55 to 70%. The properties of a coating are determined by colloidal forces acting between particles and by the properties of the suspending aqueous phase. CMC affects the colloidal forces by adsorbing on clay pigment and by increasing the viscosity of the aqueous phase. These effects will be discussed after a brief description of the coating process.

67.2 Coating Application

For the best performance in a paper blade coating machine, a coating should have a shear thinning viscosity that decreases as the shear rate increases. Typical viscosities range from about 3000 mPa·s at shear rates below 1000 sec⁻¹ when the coating is mixed and pumped to less than 100 mPa·s at shear rates above 1,000,000 sec⁻¹ when the coating is applied to the paper. The linear velocity of paper in a coating machine can vary from less than 450 m/min to greater than 1400 m/min.

Once the fluid coating has been applied to the moving paper web, the paper passes through a section of the machine in which the excess coating is removed, often by a doctor blade. As the coating passes under the doctor blade, the paper adsorbs water from the coating. The paper then goes to a dryer section, where most of the water is removed to form a solid coating layer on the paper. If the coating's water phase viscosity is too low or if the coating particles form large aggregates with a porous structure, too much water is lost prematurely from the coating under the blade. Solid aggregates form under the blade and scratch the coated paper. Excessive water loss also raises the coating solids until the coating becomes shear thickening (the viscosity increases with the shear rate). This causes undesirable streaking on the paper. Shear thickening occurs as a result of increased collisions between the colloidal particles in the coating. These collisions form aggregates that raise the viscosity. For good coating performance, it is important to control the viscosity of the water phase and to suppress the tendency of the solid particles to aggregate upon collision. The viscosity of the water phase increases as the concentration of CMC increases.¹ Particle aggregation is a direct consequence of the colloidal forces acting between the particles. These forces and the role of CMC in affecting them are discussed next.

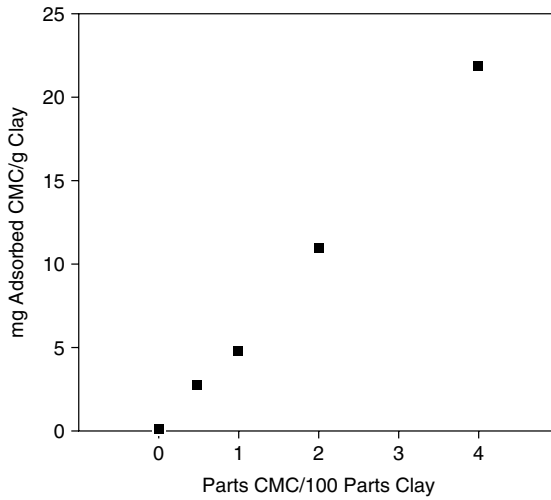

FIGURE 67.1 Adsorption isotherm for kaolin clay and CMC at pH = 7 and 25°C. [Adapted from R. M. Davis, *TAPPI J.*, 70(5), 99 (May 1987), with permission.]

67.3 Coating Formulation

The colloidal chemistry of paper coatings is governed by the attractive and repulsive forces between the clay, binder, and polymer. Kaolin clay comes in the form of the thin platelets that have negative charges on the edges and faces at pH values exceeding 7.² Paper coatings are used typically at a pH of 8 to 9. Clay particles are attracted to each other by van der Waals forces, which are particularly strong when platelets approach to within 1 nm of each other.³ Most clays are treated with an anionic dispersant such as a low molecular weight polyacrylate, which adsorbs on the clay surface. This increases the net negative charge on the platelets and causes them to repel their neighbors, thus reducing the tendency for particle aggregation. A polymeric dispersant also imparts stability through steric stabilization, in which adsorbed polymer chains on one clay platelet repel polymer chains on neighboring platelets as a result of osmotic pressure.³

Negatively charged CMC adsorbs onto kaolin clay and acts as a stabilizer. Figure 67.1 shows the adsorption isotherm for CMC with molecular weight of 110 kg/mol onto clay.⁴ The amount of adsorbed polymer per mass of clay increases as the added polymer concentration increases. This polymer adsorption increases the amount of negative charge and hence the zeta potential on the clay, as shown in Figure 67.2. The zeta potential, which is the electrostatic potential near the surface of a clay aggregate, ranged from 20 to 30 mV, which is typical for suspensions that are moderately stabilized by electrostatic repulsion.

The effect of CMC on coating viscosity at high shear rates is illustrated by the first curve in Figure 67.3, where a concentration kaolin clay suspension without CMC begins to shear thicken at a shear rate of 18,000 sec⁻¹.⁴ Adding 0.10 part of CMC per 100 parts clay increases the viscosity and also slightly reduces the shear thickening tendency. As the CMC concentration increases to 0.21 part, the suspension becomes shear thinning. The adsorbed CMC increases the degree of electrostatic and steric stabilization, thus inhibiting collision-induced flocculation.

There are no quantitative models that predict accurately the onset of shear thickening viscosity in paper coatings at very high shear rates. There are, however, numerous theories for the viscosity of concentrated suspensions at low shear rates. These were reviewed by Metzner.⁵ A useful, general model was developed by Krieger.⁶ The suspension viscosity η is correlated with the water phase viscosity η_s and the solid volume fraction Φ as

$$\eta = \eta_s \left[\frac{1 - \Phi}{\Phi_m} \right]^{-B\Phi_m} \quad (67.1)$$

where Φ is the ratio of the solids volume and the total volume; Φ_m and B are dimensionless parameters determined by fitting viscosity data to Equation 67.1.

An analysis of viscosity data using Equation 67.1 suggests that paper coatings, like other concentrated suspensions, flow in ordered layers along streamlines rather like cards in a deck sliding over each other.⁴ At low shear rates, this ordered structure results in a low viscosity. Above a critical shear rate, this ordered structure breaks down and the particles in the suspension collide far more frequently, resulting in flow-induced agglomeration and the resulting shear thickening viscosity is suppressed by treating the coating with CMC.

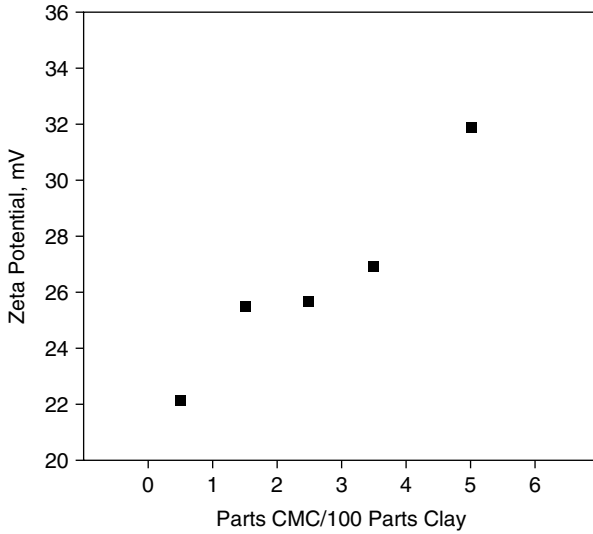

FIGURE 67.2 Zeta potential of kaolin clay with adsorbed CMC at pH = 7 and 25°C. [Adapted from R. M. Davis, *TAPPI J.*, 70(5), 99 (May 1987), with permission.]

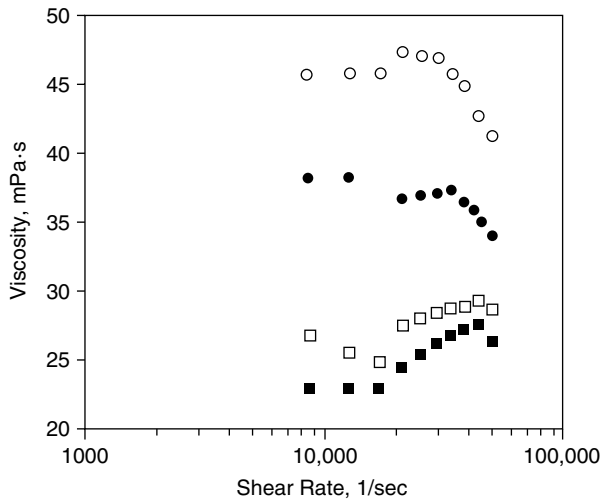

FIGURE 67.3 High shear viscosity for kaolin clay and CMC; < clay volume fraction = 0.39. distilled water control: 0.10 part CMC/100 parts clay; \bullet 0.21 part CMC/100 parts clay; \circ 0.31 part CMC/100 parts clay. [Adapted from R. M. Davis, *TAPPI J.*, 70(5), 99 (May 1987), with permission.]

References

1. Aqualon Cellulose Gum (Sodium Carboxymethylcellulose), (product bulletin), Aqualon Company, Wilmington, DE 19850-5417.
2. A. E. James, and D. J. A. William, *Adv. Colloid Interface Sci.*, 17, 219 (1982).
3. H. Van Olphen, *An Introduction to Clay Colloid Chemistry*, 2nd ed. New York: Wiley-Interscience, 1977, p. 48.
4. R. M. Davis, *TAPPI J.*, 70(5), 99 (May 1987).
5. A. B. Metzner, *J. Rheol.*, 29, 739 (1985).
6. J. W. Goodwin, in *Science and Technology of Polymer Colloids*. G. W. Poehlein, Ed. Dordrecht: Kluwer, 1982, p. 552.

Hydroxyethylcellulose

68.1	Introduction	68-1
68.2	Chemical Composition of Hydroxyethylcellulose	68-2
68.3	Types and Grades of Hydroxyethylcellulose.....	68-2
68.4	Chemical and Physical Properties of Hydroxyethylcellulose	68-3
68.5	Incorporating Hydroxyethylcellulose into Latex Paints.....	68-3
68.6	Application Properties of Latex Paints Thickened with Hydroxyethylcellulose.....	68-4
	Leveling and Sag Resistance • Film Build • Spatter Resistance	
	Reference	68-5

Lisa A. Burmeister
Aqualon Company

68.1 Introduction

Hydroxyethylcellulose (HEC) is a nonionic, water-soluble polymer derived from cellulose. It is used in water-borne paints for its action as a thickener, stabilizer, and/or suspending agent. HEC not only imparts mechanical and chemical stability to the paint system, it plays a significant role in controlling the rheology of the paint during manufacture, storage, and application. HEC is the most commonly used thickener in latex paints. In fact, it is often referred to as the industry standard for thickening.

Physically, hydroxyethylcellulose is a white, free-flowing powder that dissolves readily in hot or cold water. Available in a variety of types and grades, it can be used to produce aqueous solutions with a wide range of viscosities and a pseudoplastic nature. Upon drying, solutions of HEC form clear, gel-free films.

The nonionic nature of HEC is an advantage in latex paints. Nonionics can be used over a wide pH range and, unlike polyelectrolytes, are compatible with salts and charged species such as surfactants, latex particles, and colorants.

More recently, a hydrophobically modified hydroxyethylcellulose (HMHEC) was introduced to the latex paint industry.¹ HMHEC is an associative cellulosic polymer designed specifically for use in latex paints. It is a nonionic water-soluble polymer that contains both hydroxyethyl and long chain alkyl groups. This unique dual substitution differentiates the new-generation rheological modifier from traditional HEC. Like HEC, hydrophobically modified hydroxyethylcellulose thickens the aqueous phase of the paint, but substantial viscosity is built through association of the polymer's hydroprobes with the paint components. HMHEC combines the desirable properties of HEC with the enhanced rheology control (particularly with respect to spatter resistance and film build) required for today's coatings. A detailed discussion of HMHEC's chemical composition and rheological performance in latex paints is provided by Shaw and Leipold.

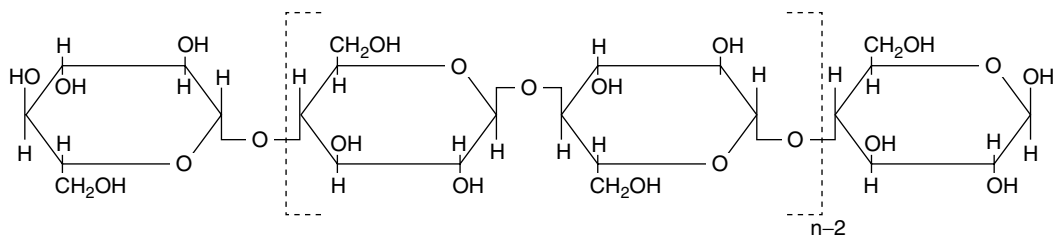

FIGURE 68.1 Structure of cellulose.

68.2 Chemical Composition of Hydroxyethylcellulose

The cellulose molecule is a polymeric chain composed of repeating anhydroglucose units (Figure 68.1). There is considerable intrachain and interchain hydrogen bonding, which results in a highly ordered, highly crystalline structure. It is for this reason that cellulose is not soluble in water.

The reactions used to make derivations of cellulose are straightforward. Cellulose is reacted with alkali, such as sodium hydroxide, to form alkali cellulose. The alkali treatment is necessary to disrupt the cellulose crystallinity. The swollen chain is then ready for the addition of appropriate substituents. Substitution on the cellulose chain causes disorder and forces the chains apart so that water may enter and solvate the chain. Each anhydroglucose unit in the cellulose molecule has three reactive hydroxyl groups. The number of hydroxyl groups substituted in any reaction is known as the degree of substitution (DS). Technically, all three hydroxyls can be substituted. The product from such a reaction would have a DS of 3.

Hydroxyethyl groups can be introduced into the cellulose molecule in two ways. First, ethylene oxide reacts with the hydroxyls in the cellulose chain. Second, ethylene oxide, reacting with previously substituted hydroxyls, can polymerize to form a side chain.

The average number of moles of ethylene oxide that attach to each anhydroglucose unit in cellulose in the two ways described is called “moles of substituent combine,” or (MS).

Solubility in water is achieved as the degree of substitution is increased. By selecting appropriate reaction conditions and moles of substituent, complete and quick solubility in water is obtained. HEC with an MS of 2.5 is most frequently used in latex paints because of its optimal water solubility. An idealized structure of HEC is shown in Figure 68.2.

68.3 Types and Grades of Hydroxyethylcellulose

By controlling the chain length of the cellulose backbone, HEC can be produced in a wide range of viscosity types. However, economics indicate that medium [2% Brookfield viscosity = 4500 to 6500 cPs (mPa·s at 25°C)] or higher viscosity grades are used to prevent sagging, and they can improve stability of some latex paint formulations. Most paints require 0.1 to 1% by weight of HEC to be thickened to the desired viscosity.

Hydroxyethylcellulose is also produced in a grade having superior biostability. Water is the continuous phase in latex paints. In addition, many of the components of a latex paint are manufactured in an aqueous environment. Whenever water is present, microbial growth may occur. The growth of these microorganisms is accompanied by the production of enzymes, including the cellulolytic types. Cellulase enzymes break the bonds between adjacent unsubstituted anhydroglucose units in the cellulose backbone. This degradation reduces the molecular weight of the polymer, causing it to no longer be an effective thickening agent.

The process by which biostable HEC is manufactured results in a product in which the hydroxyethyl groups are distributed more uniformly along the cellulose backbone, as opposed to forming longer side chains. The more uniform distribution protects significantly more bonds from enzyme attack.

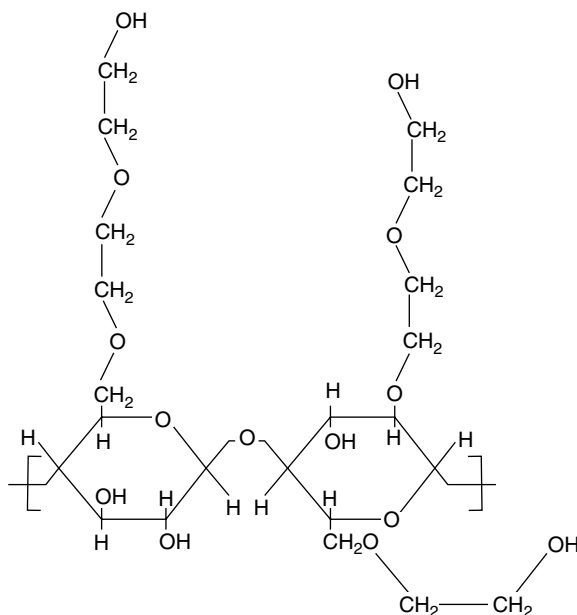

FIGURE 68.2 Idealized structure of hydroxyethylcellulose.

68.4 Chemical and Physical Properties of Hydroxyethylcellulose

Most water-soluble polymers have a tendency to lump or agglomerate during the dissolving process. When the polymer is added to water, the outer layer of the agglomerate swells to a gel very quickly, making it difficult to hydrate the inner portions. The time required for the polymer to dissolve completely is governed by the degree to which it agglomerates. To avoid agglomeration, HEC particles are surface treated with a substance, typically glyoxal, which cross-links the surface and produces a product that is temporarily insoluble in water. This temporary insolubility permits thorough dispersion of discrete particles of HEC. Once the glyoxal cross-links have been hydrolyzed by the water, the HEC will begin to dissolve without agglomerating.

Hydrolysis of the glyoxal cross-links is influenced both by temperature and pH. Figure 68.3 shows that increasing the temperature and increasing the pH both shorten the hydration time. (Hydration time is defined as the time between addition of HEC to water and the time when viscosity starts to develop.) In fact, by raising the water pH to levels of 8 and above, the hydration time is decreased so much that the surface treatment is no longer an effective means of improving dispersion.

68.5 Incorporating Hydroxyethylcellulose into Latex Paints

An important benefit of hydroxyethylcellulose for latex paint manufacturers is that it can be added to the batch at several different points. This gives the formulator process flexibility. Most often, at least some of the HEC required to thicken a batch of paint is added to the pigment grind. This increases the viscosity of the grind and makes it a more efficient dispersing medium. However, some manufacturers find it possible to achieve a good pigment dispersion in a low viscosity grind, and then add HEC later. HEC can be used in the powder form (as is), dissolved in water, or slurried in a nonsolvent before addition to ensure that a gel-free paint is manufactured.

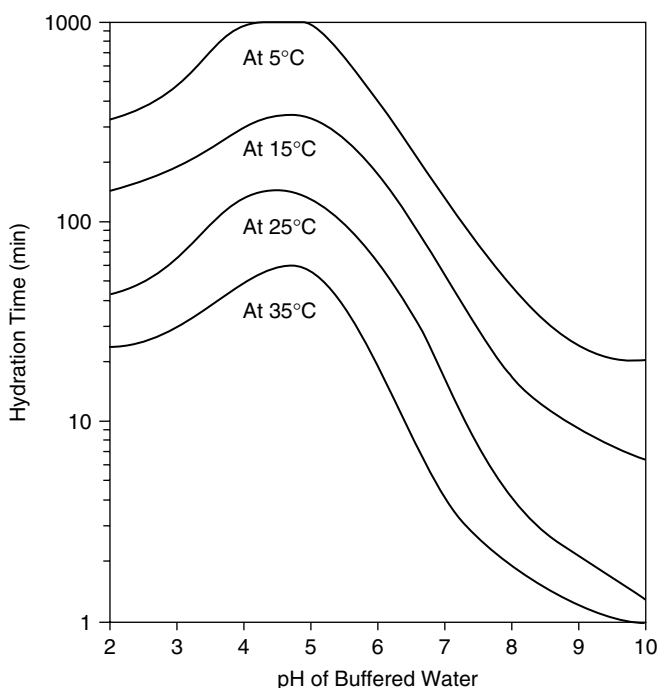

FIGURE 68.3 Effect of pH and temperature on the hydration time of HEC.

68.6 Application Properties of Latex Paints Thickened with Hydroxyethylcellulose

The primary purpose of a thickener in a latex paint system is to control rheology, or flow properties. Hydroxyethylcellulose thickeners influence the rheology primarily by thickening the aqueous phase. Fairly strong hydrogen bonds are formed between the polymer chain and water molecules. The resulting chain association forms a concentrated network. Because HEC thickens the water only, its efficiency is independent of the latex, surfactant, or dispersant type. Formulation insensitivity is the greatest benefit of HEC. Also, very little viscosity change or phase separation seen in shelf stability, heat stability, or freeze-thaw stability testing is attributable to the aqueous phase thickening mechanism. Sections 68.6.1 through 68.6.3 describe the effect of molecular weight or viscosity type of HEC on the important properties of leveling, sag resistance, film build, and spatter resistance.

68.6.1 Leveling and Sag Resistance

Very low shear rates are present in the paint during the leveling process (disappearance or reduction of brush marks in the paint immediately after application). In general, high molecular weight grades of HEC should be used if improved leveling is desired. Paint viscosity curves (Figure 68.4) show that paints with higher molecular weight thickeners have the lowest viscosities in the low shear rate region. Low shear rate viscosity data have been found to be good predictors of leveling when the only variable in a series of paints is the molecular weight of the HEC thickener. When comparing one formula with another, it is important to examine also the rate of viscosity recovery after shearing, to be able to predict leveling.

A second cause of poor leveling is wicking. When the water is adsorbed quickly into the substrate, the brush marks are frozen. To alleviate this condition, a greater amount (lower molecular weight) of HEC should be used.

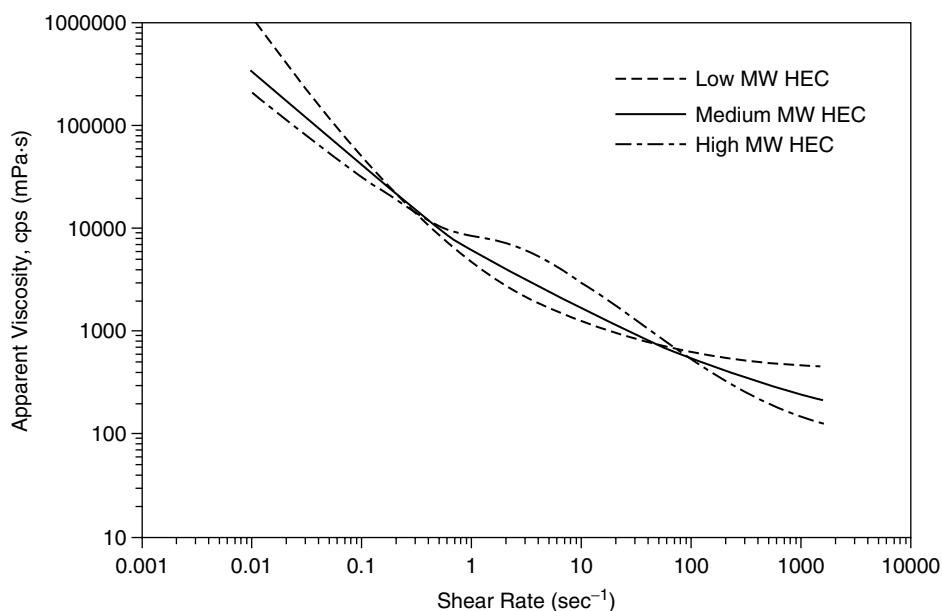

FIGURE 68.4 Influence on paint viscosities of molecular weight of HEC and shear rate.

68.6.2 Film Build

Good film build, a prerequisite for one-coat hiding, has been shown to be directly related to viscosity during the high shear processes of brush and roller application. This viscosity is controlled by thickener concentration. Therefore, to increase the film build of a formula while maintaining the Stormer viscosity, a greater amount of a low molecular weight HEC should be used.

68.6.3 Spatter Resistance

Spatter resistance, also a high shear application property, does not depend on thickener viscosity, but on the elasticity of the aqueous phase. Like film build, spatter resistance can be predicted from the polymer solution rheology. Higher molecular weight thickeners are more elastic, and consequently impart elasticity to the paint. Paint made from lower molecular weight grades of HEC is more resistant to spatter during roller application.

During roller application, threads of paint are pulled off the nip of the roller. When the thickener has some degree of elasticity, these threads are stabilized and can be stretched farther before breaking. More spatter is created when these threads are stabilized and stretched than if they break close to the nip of the roller.

Reference

1. K. G. Shaw and D. P. Leipold, *J. Coat. Technol.*, 57(727), 63–72 (1990).

69

Antistatic and Conductive Additives

B. Davis

ABM Chemicals Limited

69.1 Conductivity Additives for Spray Paints	69-1
69.2 Antistatic Additives for Plastic Materials.....	69-1
References.....	69-3

69.1 Conductivity Additives for Spray Paints

In the electrostatic spray technique, the atomized paint particles receive a high voltage in the “gun.” Subsequently, the paint particles are attracted to the grounded workpiece, resulting in highly efficient paint utilization with good coverage of any awkward areas (Figure 69.1).

Paints formulated largely from nonpolar solvents have an electrical resistance that is far too high for satisfactory application in this way. It is necessary to reduce the paint resistance below 1 M Ω , so very large proportions of polar solvent would be necessary; therefore, a search for a more efficient chemical additive revealed that some quaternary ammonium compounds (Figure 69.2) are particularly effective alternatives.

Choosing the best quaternary ammonium compound involved the investigation of various chemical structures, molecular weights, and anions. Using commercially available blends of raw materials and avoiding potentially corrosive ions, it has been possible to develop a particularly effective product, namely Catafor CA. Bearing in mind the customer preference for pourable liquids, an 80% solution in butanol is normally used to give very low resistivities with small additions, as illustrated with xylene in Figure 69.3.

When using Catafor CA in paints, it is advantageous to add a modest amount of polar solvent, because a synergistic effect is usually observed (Table 69.1).

The advantages of using quaternary ammonium salts as a conductivity additive can be summarized as follows:

1. Catafor CA, containing quaternary ammonium salts, is compatible with most types of paint, thus avoiding reformulation.
2. The fluid 80% solution is quickly and easily dissolved.
3. Only low dosage is needed to produce a large drop in resistivity (0.5 to 3% in practice).
4. The same low dosage will reduce surface tension to a suitably low value.
5. Yellowing effects are not usually observed, even in sensitive white paints.
6. Effects on the paint film properties (evenness, general appearance, hardness, corrosion resistance, etc.) are minimal.

69.2 Antistatic Additives for Plastic Materials

The many adverse effects of static electricity on insulating plastic materials are well recorded.^{1,2} These include textile processing difficulties, poor sound reproduction from records, excessive dust and dirt

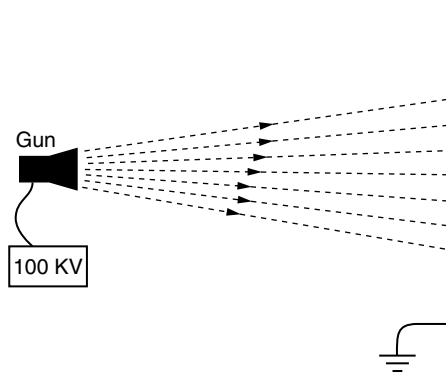

FIGURE 69.1 Schematic diagram of an electrostatically charged spray.

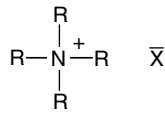

FIGURE 69.2 Structure of quaternary ammonium compounds.

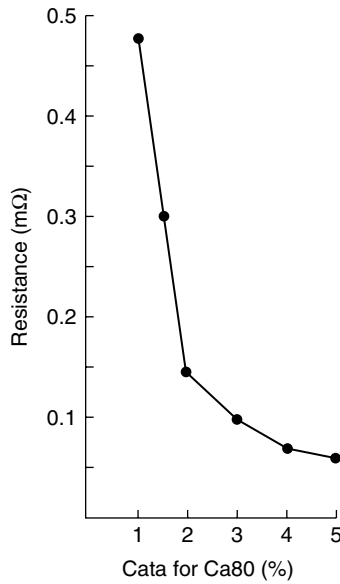

FIGURE 69.3 Effect of quaternary ammonium salt on electrical resistance in paint.

TABLE 69.1 Effect of Catafor CA in a Long Oil Alkyd Paint

Paint-Solvent Combination	Resistance (MΩ)
Paint + hydrocarbon solvent	20
Paint + hydrocarbon solvent + 1% Catafor CA80	1.8
Paint + hydrocarbon solvent + 10% methyl ethyl ketone + 1% Catafor CA80	0.29

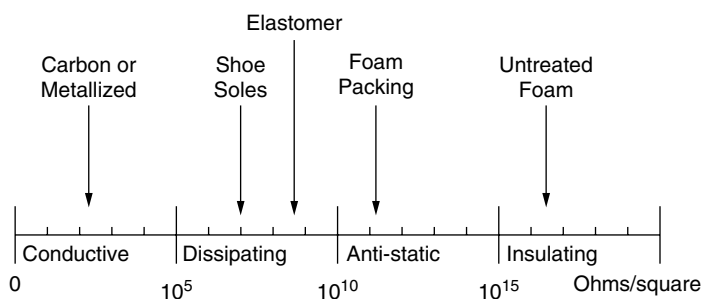

FIGURE 69.4 Surface resistivity spectrum.

collection on surfaces, and dust or solvent explosion hazards. One of the most important hazards associated with modern technology is electrostatic discharge, which can cause critical damage to micro-chip circuits, so essential in electronics.

Various types of antistatic agent are reviewed in the literature,¹ and it appears that surfactant molecules are particularly effective. Nonionic, anionic, cationic, and even ampholytic types have been used as internal antistatic agents, depending on the type of polymer. For example, nonionics are recommended for polyolefins, but cationics are particularly effective in the more polar polymers,² such as polyvinyl chloride, polystyrenes, and polyurethanes.

The large influence of relative humidity on the effectiveness of antistatic agents suggests that a film of water is held on the plastic surface by the presence of the ionized or polar groups of the surfactant molecules projecting from the surface, with the hydrophobic tail anchored in the polymer. Generally recognized levels of surface resistivity³ for various types of polyurethane are shown in Figure 69.4.

Very conductive plastics are usually made by filling with large quantities (10 to 30%) of carbon or powdered metal to produce a continuous conductive path through the polymer bulk, and it is unlikely that organic additives, relying on moisture adsorption, can ever produce such low resistivities. However, quaternary ammonium compounds have proved to be very effective at producing a useful increase in conductivity, and the active ingredient is sold in a variety of solvents (e.g., butanediol, butyl oxitol, ethylene glycol, trichloropropyl phosphate) to suit various needs.

The use of quaternary ammonium antistatic agents can be restricted by the high temperatures reached in making or molding plastic materials. However, when high temperatures exist for short periods only, Catafor CA can be used in plastics (polyurethane, PVC, polystyrene, rubber, etc.). External application is also useful, when the effect is more temporary. It can be used on fibers and in the cleaning of surfaces, when it is sufficiently substantive to give some antistatic effect.

References

1. Kirk-Othmer *Encyclopedia of Chemical Technology*, Vol. 3, 3rd ed. New York: Wiley-Interscience, 1983, p. 149.
2. R. Gachter and H. Muller, in *Plastics Additives Handbook*, 2nd ed. Munich: Hanser, 1984, Chapter 12, p. 565.
3. A. Lerner, "A new additive for electrostatic discharge control in foams and elastomers," *Proceedings of the Society of the Plastics Industry*, Texas, 1984, pp. 331-334.
4. B. Davis, "Industrial applications of surfactants," Royal Society of Chemistry special Publication 59, 1987, pp. 307, 317.

70

Silane Adhesion Promoters

Edwin P. Plueddemann

Dow Corning Corporation

References.....70-3

Silane adhesion promoters are organofunctional silicon compounds that promote adhesion of coatings to substrates, especially improving their resistance to debonding under humid conditions. It must be emphasized that these silanes are not related to polydimethylsiloxane fluids, which cause cratering and poor repaintability in coatings. Silane adhesion promoters may help overcome such problems of poor wetting and intercoat adhesion in coatings.

Silane adhesion promoters are generally formulated into primers or added at relatively low levels to coatings, in contrast to silicone resins, which are typically used at about 30% level in silicone-alkyd or silicone-acrylic formulations. These silanes are ambifunctional compounds of the general structure $(\text{CH}_3\text{O})_3\text{Si-R-X}$, where X is an organofunctional group chosen for compatibility with the organic coating and the alkoxy silane portion provides bonding to mineral substrates.¹

The alkoxy silane may be prehydrolyzed to silanols that are reactive with hydrate metal oxide surfaces and contribute siloxane cross-links. Methoxysilanes also react directly with metal hydroxides and then cross-link in the presence of atmospheric moisture.

Silane adhesion promoters are often effective in improving the adhesion of coatings to plastic surfaces or to oily metal surfaces. As additives in paints, they may be useful in improving intercoat adhesion.

A recent trend is to formulate adhesion promoters by mixing silane monomers, partially prehydrolyzing the silanes, or by mixing silanes with polymer precursors such as epoxies and melamines. Silane adhesion promoters are offered by silane manufacturers Dow Corning Corporation, Union Carbide Corporation, Petrarch Chemicals Division of Dynamit Nobel, and Peninsular Chemical Research, as well as by proprietary formulators such as Hughson Chemical Division of Lord Corporation. Adhesion promoters supplied by Dow Corning and recommended for coatings are described in [Table 70.1](#).

Walker² reviewed a study of silane primers and additives for adhesion of a two-part epoxy paint with polyamide cure, and a two-part aliphatic isocyanate adduct cured polyester paint on mild steel, aluminum, cadmium, copper, and zinc surfaces. Silanes were tested as primers (essentially monolayer coverage on metal), and as 0.1 to 0.4% additive based on total paint. Results, summarized in [Table 70.2](#) for iron and aluminum, indicate that the diamine-functional silane gave uniformly improved retention of adhesion under wet conditions and gave greater recovery of adhesion when the panels were dried. Methacrylate-, epoxy-, and mercaptofunctional silanes were also useful as adhesion promoters. Results were similar on cadmium, copper, and zinc. Paints with some silane additives showed little deterioration in performance during 9 months of storage.

Some general recommendations on use of silane adhesion promoters of [Table 70.1](#) for coating on glass, aluminum, and steel are summarized in [Table 70.3](#).³

TABLE 70.1 Dow Corning Adhesion Promoters for Coatings

Product	Type
21 Additive	Amino (50% in butanol)
25 Additive	Formulated silane-melamine
Z6030	Methacrylate
Z6032	Vinyl benzylamine
Z6040	Epoxy
X1-6100	Mixed silanes
1200 Primer	Silicate
1205 Primer	Formulated silane-epoxy

TABLE 70.2 Wet^a and Recovered^b Adhesion of Paints on Metals (Modified with Diamine-Functional Silane)

Paint	Metal Treatment	Milk Steel				Aluminum			
		Wet		Recovered		Wet		Recovered	
		MPa	%	MPa	%	MPa	%	MPa	%
Polyurethane	Degreased	5.6	100	6.8	100	3.8	100	9.9	100
	Degreased, primed	7.4	90	12.5	90	11.8	30	22.8	30
	Degreased, 0.2% additive	9.8	60	20.2	100	9.5	100	14.5	100
	Sandblasted	11.8	95	20.8	60	8.5	100	13.6	80
	Sandblasted primed	22.7	30	29.14	0	14.9	20	22.0	30
Epoxy	Sandblasted, 0.4% additive	21.3	20	29.8	0	15.6	70	25.2	30
	Degreased	7.2	100	10.9	100	5.6	100	11.2	100
	Degreased, primed	28.7	100	29.2	10	11.4	30	20.5	40
	Degreased, 0.2% additive	17.7	10	26.6	20	25.3	0	26.9	0
	Sandblasted	9.2	100	20.9	100	8.5	100	13.7	80
	Sandblasted, primed	26.3	50	27.8	40	12.9	40	24.9	30
	Sandblasted, 0.2% additive	23.8	0	25.3	20	28.2	0	28.7	0

^a After 1500 h of immersion in water.

^b Dried in air for 48 h.

Source: Adapted from P. Walker, *J. Coat. Technol.*, 52(668), 33 (1980).

TABLE 70.3 Recommendations for Adhesion of Coating to Metals

Coating	Primer	Additive
Acrylic solutions		
Thermoplastic	1200P, X1-6100, Z6040	21A, Z6032
Thermosetting	1200P, 25A, Z6040	25A, Z6040, Z1-6100
Acrylic emulsion		
Thermoplastic	21A, Z6040, Z1-6100	25A, Z6032, Z6040, Z1-6100
Thermosetting	21A, 25A, Z6040	25A, Z6030, Z6040, Z1-6100
Alkyd	1200P	None
Polyester	1200P, 25A, Z6040	21A, Z6032, Z6040, X1-6100
Two-package urethane		
Polyester	1200P, 25A, Z6032, Z6040	21A, 25A, Z6030, Z6040
Acrylic	1200P, 1205P, 25A, Z6040	21A, 25A, Z6032, X1-6100
Epoxy		
Baking	1205P, 21A, 25A, Z6040	21A, 25A, Z6032, X1-6100
Air dry	1200P, 1205P, 25A, Z6040	21A, 25A, Z6032, Z6040
PVC plastisols	21A, Z6032	— ^a

^a A partially hydrolyzed 21A devolatilized in higher alcohols has been offered as Q1-6012.

Source: Dow Corning Corporation.

Silane adhesion promoters are also effective in bonding coatings to plastic surfaces.⁴ Primers 1200, 1205, and 25A are generally useful on engineering thermoplastics and thermosetting resin surfaces, while 1205P and Z6032 are most useful on polyolefins and vulcanized rubber surfaces.

References

1. E. P. Plueddemann, *Silane Coupling Agents*. New York, Plenum Press, 1982.
2. P. Walker, *J. Coat. Technol.*, 52(668), 33 (1980).
3. P. G. Pape and W. A. Finzel, Dow Corning Corp., private communication.
4. E. P. Plueddemann, in *Adhesion Aspects of Polymeric Coatings*. K. L. Mittal, Ed. New York: Plenum Press, 1983, p. 363.

71

Chromium Complexes

71.1	Introduction	71-1
71.2	Manufacture.....	71-1
71.3	Methacrylic Acid Types.....	71-1
71.4	End Uses	71-2
	Release • Water Resistance • Grease Resistance	
71.5	Application Methods.....	71-3
71.6	Governmental and Other Regulations.....	71-4

J. Rufford Harrison
E. I. du Pont de Nemours & Company

71.1 Introduction

Chromium complexes are widely used for changing the characteristics of paper, glass, and other hydroxylic surfaces, and the surfaces of materials such as polyethylene, which can be made functional by corona discharge and similar methods. These binuclear compounds have the approximate formula shown in [Figure 71.1](#). The chromium end of the molecule attaches itself to the substrate, whose –OH groups are in effect converted to –R groups. The radical R is of two general types: long chain saturated hydrocarbon, incorporated by the use of a fatty acid, and unsaturated hydrocarbon, incorporated as methacrylic acid. The fatty acids are used to change the physical properties of the surface, whereas the function of the methacrylic acid is to change its chemical properties.

The chromium in these complexes is exclusively trivalent. As is discussed below, the health hazard associated with hexavalent chromium compound is not present in these products, which have the approval of the U.S. Food and Drug Administration (FDA).

71.2 Manufacture

The starting point for these materials is a solution of a basic chromium chloride, which is converted to the complex by reaction with the appropriate acid. The products are green solutions, with such depth of color that they appear black. In addition to being classed as flammable liquids, they are corrosive, since some of the chlorine (see [Figure 71.1](#)) is hydrolyzed and therefore exists in the form of HCl. In use, both hazards are removed by dilution and neutralization.

71.3 Methacrylic Acid Types

The du Pont Company makes methacrylatochromium complexes under the name Volan bonding agent. Although the methacrylic acid types are used to coat substrates, the coating is always reacted further before the end use is reached. They are therefore not normally considered to be coatings per se, and are discussed only briefly.

A methacrylate group can polymerize with any other molecule undergoing vinyl polymerization. If Volan-treated glass fiber, for instance, is impregnated with an unsaturated polyester, then when the latter

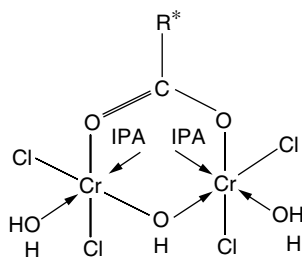

* The only difference between grades

FIGURE 71.1 Typical chromium complex (IPA = isopropyl alcohol).

is polymerized, the chrome complex polymerizes with it, thereby forming a strong, hydrolysis-resistance bond between the resin and the glass. The methacrylatochromium complex will bond almost any inclusion to an unsaturated polyester, or to any other thermosetting vinyl resin such as a styrenic or an acrylic; fillers, reinforcing agents, pigments, or other solid additives can all be treated in this manner.

A property of particular interest in these methacrylatochromium coatings is that they disperse static electricity, so that treated powders, for instance, remain free flowing; some bonding agents give rise to so much static that treated products become very difficult to use.

71.4 End Uses

Almost any carboxy group will form a complex with chromium, provided the molecule does not include a group that complexes more strongly. The common fatty acids all form these complexes, but until the number of carbon atoms reaches about 14, the products have no properties of interest. In the range from C_{14} to C_{18} the acids form complexes that give rise to properties like those of wax, namely, water resistance and release. du Pont markets these materials under the name Quilon. They do not contribute per se grease resistance, but they do make excellent cross-linking agents for polyvinyl alcohol (PVA), which has very good resistance, a disadvantage that is eliminated by cross-linking with a chromium complex.

Like the methacrylato complex, those based on fatty acids also act as antistatic agents.

71.4.1 Release

The main use for these complexes is in the manufacture of release paper. Using the “Scotch tape test,” the strength of release on untreated paper may be about 1200 g/in., which falls to perhaps 40 g/in. if the paper is treated with silicone, the best-known and most-used release agent. With a chromium complex, the release is likely to be in the range of 500 to 600 g/in. What the user of chromium is seeking is a composite structure — the release paper and the material that is adhered to it — that has enough adhesive force to stay together under a range of conditions; yet the release must be clean, without fiber tear, when required.

The three main uses in this category are as follows.

71.4.1.1 Bakery Liners

As mentioned in Section 71.1, these complexes are not toxic, and they do have FDA approval. They are used in papers for baking a variety of products, and for packing a variety of products that are not baked. The substrate is usually, but not exclusively, glassine or parchment; more porous papers can be used if some provision is made to retain the treatment solution at the surface. Although release is usually needed on only one side, both sides are coated; bakery liners are often reused — often several times on each side — and the extra coating increases the lifetime of the paper.

71.4.1.2 Decorative Laminates

High pressure laminates are made by impregnating several layers of paper and other materials with a thermosetting resins, and heating the composite between steel cauls. Adhesion to the steel is prevented by an intermediate layer of release paper, coated sometimes on both sides, sometimes on only one. Since sheets of decorative laminate are made in pairs, back to back, another layer of release paper is used between them.

71.4.1.3 Vinyl Casting

Textured soft vinyl is often made by casting a vinyl plastisol onto a textured release paper. The latter is a quite heavy grade.

71.4.2 Water Resistance

Chromium-treated paper will transmit water vapor but is resistant to liquid water. Until paper succumbed to competition from polyethylene, chromium complexes were used in the manufacture of ice bags. Some chromium complex is still used for water resistance, but the use is now much smaller.

71.4.3 Grease Resistance

A layer of polyvinyl alcohol is often used on paper to provide grease resistance, but if liquid water or high humidity are major factors, PVA cannot be used without being cross-linked. Chromium complexes are often used for this purpose. The PVA is first dissolved in water, and the resulting solution is used to dilute the Quilon. The product has enough stability for use in a paper mill. Interleaving paper for bacon slices is an example of a use requiring this product.

71.5 Application Methods

As indicated above, the chromium complexes are provided as concentrated, acidic, alcoholic solutions. In use, they are diluted, often as much as 100-fold, with cold water (or with isopropanol, if the substrate is not readily wetted by water). They are then usually neutralized to a pH of about 3.5. The common alkalis such as caustic or ammonia cannot be used without specialized equipment; they may produce localized regions of high pH, and chromium compounds precipitate. Instead, a buffer solution (formate-urea) is used, or a material that produces ammonia upon hydrolysis — urea or hexamethylenetetramine (HMT). The best of these is HMT, but it does not have FDA approval. Manufacturers of bakery liners therefore use formulations based on urea. A typical formulation is as follows:

- 1 part chromium complex solution (commodity, as supplied)
- 50 parts water at 20 to 30°C (say 70 to 90°F)
- 0.02 to 0.03 part urea

On very porous papers it may be necessary to apply a base coat — alginates, ethylated starches, and polyvinyl alcohol are all used — to retain the chromium complex at the surface. If it is not feasible to apply this second coating, the efficiency of the chromium complex solution can be increased by incorporating PVA in it to reduce penetration.

Although the complexes as shipped are almost indefinitely stable, once neutralized they begin to hydrolyze, and will eventually form a sludge. They do, however, have stabilities of a few days, particularly if an effort is made to maintain the temperature lower than 30°C, and if they can be run readily in a paper or textile mill.

Another precaution is to avoid contaminating the treatment bath with components of the paper. The latter is often alkaline, and too much contamination can result in precipitation of chromium in the feed tank. Perhaps the easiest way to avoid this problem is to use a small recycle tank, fed on demand from the larger mix tank that is never contaminated by recycle.

TABLE 71.1 Some Typical Application Equipment

On-machine	Off-machine (Converting Plants)
Size press	Doctor roll or knife
Spray	Meyer rod
	Gravure
	Offset
	Corrugator

The treatment solution can be applied to the paper by almost any method that is logical for the available equipment; see Table 71.1. On a paper machine, for instance, it is often applied on a size press. But this may not be feasible if the machine has only one press that is used for applying a different coating, such as starch or PVA. In such a case, the chromium solution can be sprayed on to the paper. On converting equipment there are more options. The solution can be sprayed or rolled onto the paper, it can be offset, it can be doctored — almost any equipment capable of applying a liquid to paper can be used.

Coating weights range from 1 to 5 lb of the original complex commodity—the solution as shipped—per 10,000 square feet of surface. One cannot be more precise than this, since much depends on the paper itself, particularly on its porosity. The first-time user is advised to use the higher end of the range initially; he can then gradually reduce the add-on until he discovers his minimum.

71.6 Governmental and Other Regulations

Since none of the chromium is in the hexavalent state, these materials have FDA approval for use on paper in contact with dry, aqueous, and fatty foods. Corresponding approvals for use on films and foil have not been sought, but presumably could be obtained. Grades of these complexes based on the C_{14} acid, which is obtained from coconut oil, conform to Jewish dietary laws.

Regulations covering the disposal of chromium-containing materials are generally local and should be checked before use. The commodity itself can be fed slowly to a biotreatment pond; the chromium will precipitate and go out with the sludge, and the fatty acid will be biodegraded. Approval of the appropriate authority should be sought first, however, to ensure that the compound does not interact with something else that is being fed at the same time.

Alternatively, the commodity can be pyrolyzed (i.e., incinerated under nonoxidizing conditions). The residue will include trivalent chromium, which can usually be deposited in a landfill after consultation with the appropriate authority. Some HCl will be formed during pyrolysis and may be permitted to escape through the smokestack subject to local approval; alternatively, it may be scrubbed out. Since the HCl is corrosive, these materials should not be disposed of routinely in this way unless the incinerator is corrosion resistant.

Incineration under oxidizing conditions may be safe, depending on other products being handled at the same time. There is always the possibility that some of the chromium will oxidize, in which form it may appear in either the ash or the volatiles. This possibility should first be checked on a small scale; if any hexavalent chromium is produced, the method should not be selected, Pyrolysis would avoid this problem. Biotreatment may be used also for treatment of solutions.

Treated paper may be pyrolyzed or incinerated, with the same consideration as described above, or it may be deposited in a landfill. Alternatively it may be repulped, in which case, most of the chromium will go out with the broke.

Some landfilling operations place limits on heavy metals. The composition of any proposed waste should be discussed with the operators.

72

Nonmetallic Fatty Chemicals as Internal Mold Release Agents in Polymers

Kim S. Percell

Witco Corporation

Harry H. Tomlinson

Witco Corporation

Leonard E. Walp

Witco Corporation

72.1	Introduction	72-1
72.2	Test Procedure	72-2
72.3	Experimental.....	72-2
72.4	Results	72-3
	Results • Polyolefins	
72.5	Conclusions	72-7
	Acknowledgment	72-7

72.1 Introduction

A major problem in injection molding is removal of the part from the mold. If the part has a large surface area or a certain type of surface, it may be almost impossible to remove the piece without damage. The force of the ejector can be increased to some extent, but this increases the possibility of damage to the piece. The use of some type of mold treatment is well known in the industry. The most common treatment is spraying a silicon- or fluorocarbon-type mold release agent directly on the mold. This procedure makes it considerably easier to remove the piece from the mold, but unfortunately it causes other problems. The spray-on mold release is typically good for eight to 10 moldings and then must be resprayed. Continued respraying eventually causes a buildup on the mold, which must be removed. Both the respraying and the cleaning cause an increase in cycle time.

The use of an internal mold release agent can eliminate or lessen the problems of spray-on mold release. It would not be necessary to continually spray the mold, and there would not be as much buildup on the mold when internal mold release agents are used.

One theory about how mold release additives work is that the additive exudes to the surface in the time between injection and ejection and serves to lubricate the boundary area during ejection. The mold release agent may also serve to reduce electrostatic attraction during ejection in some cases. If these assumptions are true, then a number of things can affect the usefulness of an additive: solubility in the resin, rate of migration in the resin, lubricity of the additive, melting point of the additive, and ability of the additive to reduce electrostatic attraction, to name some. Since most of these interrelationships are not well known, it follows that a large part of mold release is done on a trial-and-error basis. Eventually what will and will not work can be predicted for a given resin, but these predictions are made only on the basis of how similar compounds behave.

In addition to the absence of a proven theory of how mold release agents work, there is no standard test for mold release effectiveness. It is necessary, of course, that there be tight adherence of the piece to the mold, but many mold configurations can accomplish that. The relative rankings of mold release agents should be the same, however. The method we have devised is an effective test procedure and does appear to produce useful information.

72.2 Test Procedure

The key element in our mold release testing is a quartz piezoelectric device attached to the ejector rod of the injection molding machine. It is known that a quartz crystal generates an electric current when compressed and, furthermore, the amount of current is proportional to the amount of compression. By amplifying and recording the current, the amount of force needed to eject a piece from the mold can be measured. If an additive improves mold release, a lower current is generated, and the difference can be measured.

The mold is designed to produce a cylindrical piece about 5 cm in diameter, 4.5 cm long, and 0.4 cm thick. The piece is designed such that there is a maximum of contact between the resin and the mold. As the injected resin cools, it contracts around the mold, making it adhere tightly to the inner mandrel of the mold. Because of this tight adherence, the effectiveness of mold release agents can easily be seen. After the mold opens, a steel plate begins to push the piece off the mandrel. The greatest amount of force is that which is needed to break the piece free from the mandrel and start it forward. Progressively less force is needed to push the piece as it goes further toward the end of the mandrel. The mold release force is that force needed to initially start the piece moving.

This force is sensed by the piezoelectric device, which sends a signal to an amplifier and subsequently to a recorder. The signal is recorded on a strip chart and the amount of force is calculated. At least 10 injections and measurements are made and averaged for each number reported.

Results are reported as a percent decrease of mold release force rather than as absolute numbers. There are two reasons for this. First, relative, rather than absolute, numbers are being measured. Resin with additive is being compared to resin without additive, instead of absolute numbers being measured. Second, the baseline drifts slightly from day to day. If results are reported as absolute numbers, a different control value would need to be reported for each additive, adding considerable confusion. When percent differences are calculated from the data, there is no day-to-day drift on repeated tests, indicating that both the baseline and the experimental values drift in the same direction, by the same amount. The reproducibility of test values is good, giving rise to an error value of ± 1.0 unit in the reported percentage numbers.

72.3 Experimental

All injection moldings are done on an Arburg 221E/150R injection molder. The molder has 25 ton clamp capacity and 1.5 ounce shot capacity and is equipped with a hydraulic ejector. The compression sensor is a 201A04 force ring transducer made by PCB Piezotronics, wired to a model 484 B line power unit (PCB Piezotronics). The power unit is coupled to a Gould 2200S recorder.

Additives are masterbatched into resins on a Brabender extruder. The additive is mixed with the resin (usually at a level of 1.0%) as thoroughly as possible. Extruder barrel temperatures and screw speed are determined by a combination of manufacturers' recommendations and in-house experimentation. The mixture of additive and resin is passed through the extruder into a water bath and then into a pelletizer. The pelletized resin is passed through the extruder two more times to ensure complete mixing. Resins that are sensitive to hydrolysis are dried in between extrudings.

Conditions for injection molding, also, are determined by a combination of manufacturers' recommendations and in-house experimentation. When the molder is at operating temperature, about 15 to 20 injections of resin without additive are made to allow it to stabilize. Another 10 injections of resin without additive are made, and measurements of mold release force are taken and averaged, to establish

TABLE 72.1 Effectiveness of Mold Release Agents in ABS

Release Agent	Level (ppm)	Reduction of Ejection Force (%)
Cetyl palmitate	10,000	11.2
Cetyl stearate	10,000	11.4
Cetyl palmitate–stearate	10,000	10.9
Cetyl myristate	10,000	7.6
Myristyl palmitate	10,000	8.7
Stearyl stearate	10,000	7.4
Benzenyl benzenate	10,000	6.9
<i>N,N</i> -Ethylene bisstearamide	10,000	2.3
Cetyl stearate	7000	10.5
Cetyl stearate	6000	8.9
Cetyl stearate	5000	3.5
Fluorocarbon spray-on	—	11.1

a baseline to compare to resin with additive. After the baseline has been established, molding using resin with additive (diluted to the desired level) is started. Six or seven injections are made before any measurements are made. Another series of 10 injections is made in which mold release forces are measured and averaged. Settings on the injection molder are not changed during testing, and the semiautomatic mode allows for reproducible molding. The mold temperature is held constant by a circulating water bath. The time between moldings is also kept constant.

72.4 Results

72.4.1 Results

72.4.1.1 Acrylobutyl Nitrite

In acrylobutyl nitrite (ABS) it was found that the materials that had the greatest ability to improve mold release were esters of long chain saturated fatty acids and long chain saturated fatty alcohols. Of such compounds, cetyl esters of palmitic or stearic acid make the best mold release agents (see Table 72.1). Similar esters of shorter or longer chain length, or esters made from unsaturated materials, are not quite as good. Esters of other types (methyl esters, ethylene glycol esters, etc.) are even less useful as mold release agents.

None of the nonester materials tested showed the effectiveness of the wax esters. Neither fatty acids nor fatty amines are good mold release agents. Fatty amides also are not good release agents. Ethylene bisstearamide is sometimes added to ABS, probably as a flow improver, but it does not significantly improve mold release.

The optimum level of ester additive has been determined to be 6000 to 8000 ppm. At levels above this amount, there is little increase in mold release effectiveness, and at levels below, there is not enough mold release enhancement.

Only slight changes are observed in tensile strength and Izod impact resistance when tested at room temperature at levels up to 10,000 ppm (see Table 72.2). The percent elongation at break also shows little change when tested at room temperature.

TABLE 72.2 Mechanical Properties of ABS with Cetyl Stearate Present

Property	Cetyl Stearate (ppm)		
	0	5000	10,000
Tensile strength at yield, psi	7172	6561	6221
Elongation at break, %	3.95	3.38	2.83
Izod impact, ft-lb/in.	3.99	4.14	4.47

TABLE 72.3 Effectiveness of Mold Release Agents in Acetal

Release Agent	Level (ppm)	Reduction of Ejection Force (%)
<i>N,N'</i> -Ethylene bisstearamide	7500	26.0
<i>N,N'</i> -Ethylene bisoleamide ^a	5000	25.1
<i>N,N'</i> -Ethylene bisstearamide	5000	23.3
Stearyl stearamide	5000	21.1
Stearamide	5000	20.4
Erucamide	5000	21.8
<i>N,N'</i> -Ethylene bisstearamide	2500	15.2
<i>N,N'</i> -Ethylene bisstearamide	1000	5.3
Fluorocarbon spray-on	—	22.1

^a Causes resin to darken during processing.

TABLE 72.4 Mechanical Properties of Acetal with *N,N'*-Ethylene Bisstearamide Present

Property	<i>N,N'</i> -Ethylene Bisstearamide (ppm)		
	0	2500	5000
Tensile strength at yield, psi	9965	9883	9818
Elongation at break, %	36	39	41
Izod impact, ft-lb/in.	1.30	1.32	1.35

72.4.1.2 Acetal

The most effective mold release agents in acetal are fatty amides in general and fatty bisamides amides in particular. Ethylene bisoleamide shows 25.1% reduction of mold release force at 5000 ppm but causes a visible darkening of the resin during processing. Ethylene bisstearamide, a saturated amide, is nearly as good, showing 23.3% reduction at a level of 5000 ppm; it does not cause any color problems. Other secondary amides, such as stearyl stearamide and stearyl erucamide, give mold release improvement nearly as good as the bisamides (see Table 72.3). Primary amides such as erucamide, oleamide, and stearamide also show good mold release enhancement in acetal.

None of the nonamide materials examined has the mold release effectiveness of the amides. The best ester mold release agent is cetyl palmitate, which exhibited a 16.5% reduction in mold release force at a 5000 ppm treatment level.

The optimum amount of ethylene bisstearamide is 5000 ppm. When used above that level, there is little increase in effectiveness; below that amount, the maximum effectiveness is not reached.

The use of fatty amides as mold release agents has negligible effect on mechanical properties (see Table 72.4).

72.4.1.3 Polybutylene Terephthalate

Fatty bisamides are the best mold release agents in polybutylene terephthalate (PBT). Both saturated and unsaturated bisamides show about 10% reduction of ejection force when used at a level of 5000 ppm. The bisoleamide, however, causes some darkening of the resin during processing (see Table 72.5).

TABLE 72.5 Effectiveness of Mold Release Agents in PBT

Release Agent	Level (ppm)	Reduction of Ejection Force (%)
<i>N,N'</i> -Ethylene bisoleamide	5000	9.8
<i>N,N'</i> -Ethylene bisstearamide	5000	9.4
Stearamide	5000	6.7
Erucamide	5000	6.2
<i>N,N'</i> -Ethylene bisstearamide	2500	7.7
<i>N,N'</i> -Ethylene bisstearamide	1000	2.7
Fluorocarbon spray-on	—	8.8

^a May cause resin to darken during processing.

TABLE 72.6 Mechanical Properties of PBT with *N,N'*-Ethylene Bisstearamide

Property	<i>N,N'</i> -Ethylene Bisstearamide (ppm)		
	0	2500	5000
Tensile strength at yield, psi	9640	8664	8840
Elongation at break, %	299	249	227
Izod impact, ft-lb/in.	1.00	1.05	1.030

TABLE 72.7 Effectiveness of Mold Release Agents in Polypropylene

Release Agent	Level (ppm)	Reduction of Ejection Force (%)
Glyceryl monostearate		
45% α -monoester	2500	23.9
60% α -monoester	2500	23.8
90% α -monoester	2500	22.4
Glyceryl distearate		
12% α -monoester	2500	15.9
Erucamide	5000	25.8
Fluorocarbon spray-on	—	23.1

Other mold release agents, such as fatty esters, amines, and acids, are not as effective as the amides.

The optimum amount of ethylene bisstearamide in PBT is between 2500 and 5000 ppm (see Table 72.5). Amounts less than 2500 ppm show a steep decline in effectiveness, while amounts above 5000 ppm do not show any more effectiveness than 5000 ppm.

The use of fatty amides as mold release agents in PBT has negligible effect on mechanical properties when tested at room temperature (see Table 72.6).

72.4.2 Polyolefins

72.4.2.1 Polypropylene

Glyceryl monostearate (GMS) has been found to be the best mold release agent in polypropylene. At a level of 2500 ppm, GMS shows about 24% reduction of mold release force. The reduction in mold release force is the same regardless of whether the GMS has 45, 60, or 90% α -monostearate (see Table 72.7). The remainder of the monostearate is β -monostearate, distearate, and small amounts of tristearate. When the amount of α -monostearate is less than 45%, there is a decrease in mold release enhancement.

Other glyceryl monoesters have also been tested, and only glyceryl monolaurate is as good a mold release agent as GMS. In addition to glycerol esters, ethylene glycol distearate and monostearate, cetyl palmitate, and methyl stearate have been examined. None is as good as GMS.

The results of these experiments indicate that the greater the amount of free hydroxyl in the ester, the more effective the mold release agent, up to a certain amount. Perhaps the hydroxyl groups make the additive less soluble in the resin, thus making it exude more to the surface. After a certain amount of hydroxyl has been reached, the migration to the surface reaches a maximum and further increases do not further enhance migration.

Fatty amides also show some utility as mold release agents in polypropylene. Erucamide shows 25.8% reduction of mold release force when used at a level of 5000 ppm. This amount of reduction is comparable to GMS, although the GMS is used at a lower level.

The use of glyceryl monostearate or erucamide as mold release agent in polypropylene has a negligible effect on the mechanical properties (see Table 72.8).

72.4.2.2 High-Density Polyethylene

The best mold release agent in high-density polyethylene (HDPE) is erucamide. At a level of 2500 ppm it shows a mold release force reduction of about 22%. Other primary amides are also fairly effective as

TABLE 72.8 Mechanical Properties of Polypropylene with and without Glyceryl Monostearate

Property	Glyceryl Monostearate, 45% α -ester (ppm)	
	0	2500
Tensile strength at yield, psi	4848	505
Elongation at break, %	295	60
Izod impact, ft-lb/in.	0.65	0.72

TABLE 72.9 Effectiveness of Mold Release Agents in HDPE

Release Agent	Level (ppm)	Reduction of Ejection Force (%)
Erucamide	5000	30.8
Erucamide	2500	20.2
Stearamide	5000	26.7
Ethoxylated oleyl amine	5000	18.9
Ethxylated tallow amine	5000	19.8
Glyceryl monostearate	5000	14.8
Fluorocarbon spray-on	—	20.7

TABLE 72.10 Mechanical Properties of HDPE with Various Additives

Property	Level (ppm)	Tensile Strength at Yield (psi)	Elongation at Break (%)
No additive	—	3810	551
Erucamide	2500	3825	410
Erucamide	5000	3840	513
Ethoxylated oleyl amine	5000	3813	402
Ethoxylated tallow amine	5000	3877	425

mold release agents, although not as good as erucamide (see Table 72.9). Secondary amides and bisamides are not as good mold release agents as the primary amides.

In addition to primary fatty amides, ethoxylated fatty amines are useful mold release agents in HDPE. At a level of 5000 ppm, ethoxylated oleyl amine and ethoxylated tallow amine show nearly a 20% decrease in mold release force (see Table 72.9). The use level is higher than the primary amide usage level, but the ethoxylated amines are also known as antistatic agents and therefore could solve two problems with one additive.

Fatty esters have also been tested for mold release, but with the exception of glyceryl monostearate, they do not have much usefulness as mold release agents. GMS, used at a level of 5000 ppm, shows a 14.8% reduction of ejection force, but this is not as good as the primary amides or the ethoxylated amines.

The use of primary amides or ethoxylated amines as mold release agents in HDPE has negligible effect on mechanical properties when tested at room temperature (see Table 72.10).

72.4.2.3 Linear Low-Density Polyethylene

The results of testing for mold release in linear low-density polyethylenes (LLDPEs) are quite similar to those in HDPE. Erucamide is the most effective mold release agent (see Table 72.11).

The primary amides can be used at lower concentrations, because they are more efficient in LLDPE. Erucamide shows 30.3% reduction of mold release force when used at a level of 1000 ppm, while in HDPE it must be used at a level of 5000 ppm to achieve the same effect.

The ethoxylated amines are also useful mold release agents and exhibit the same increased efficiency reported for the primary amides (see Table 72.11). As in HDPE, the ethoxylated amines are also useful as antistatic agents.

TABLE 72.11 Effectiveness of Mold Release Agents in LLDPE

Release Agent	Level (ppm)	Reduction of Ejection Force (%)
Erucamide	5000	49.8
Erucamide	2500	43.1
Erucamide	1000	30.2
Ethoxylated tallow amine	2000	30.9
Ethoxylated oleyl amine	2000	29.6
Glyceryl monostearate	2000	26.0
Fluorocarbon	—	11.1

72.5 Conclusions

It has been shown that it is possible to measure qualitatively the effectiveness of internal mold release agents in injection molding. Numerous fatty chemicals were tested in polyolefins and engineering resins. The chemical type that is the most effective mold release agent in a particular resin varies widely with resin type. The required mold release pressure can be reduced for each of these resins without a significant change in the mechanical properties of the resin. One or more preferred mold release agent has been suggested for each resin.

Acknowledgment

Some of the information in this chapter is covered under an existing patent and a pending patent.

73

Organic Peroxides

73.1	Introduction	73-1
73.2	Types and Properties.....	73-1
	Peroxide Selection • Radical Types	
73.3	Application in Coatings.....	73-4
73.4	Safety Factors and Producers	73-5
73.5	Future Trends.....	73-5
	References	73-5

Peter A. Callais
Pennwalt Corporation

73.1 Introduction

Organic peroxides are derivatives of hydrogen peroxide, HOOH, wherein one or both hydrogens are replaced by an organic group (i.e., ROOH or ROOR).¹⁻⁵ They are thermally sensitive and decompose by homolytic cleavage of the labile oxygen–oxygen bond to produce two free radicals:



The temperature activity of organic peroxides varies from below room temperature to above 100°C, depending on the nature of the R groups. In addition to thermal decomposition, certain organic peroxides can be decomposed by activators or promoters at temperatures well below the normal decomposition temperature.

A major application of these compounds is as free radical initiators in the polymerization of vinyl and diene monomers in the plastics and coatings industries. They are also used as cross-linking and modifying agents for polyolefins, as vulcanizing agents for elastomers, and as curing agents for polyester resins.

73.2 Types and Properties

Peroxide manufacturers now offer over 50 different organic peroxides in more than 100 formulations including dilutions in solvents, pastes, and filler-extended grades. In most cases, these formulations are designed for specific applications and to allow shipping and handling with a reasonable degree of safety.

The major classes of commercial organic peroxides are shown in [Table 73.1](#). Decomposition rates of peroxides are commonly reported in terms of half-life ($t_{1/2}$) temperature, that is, the time at which 50% of the peroxide has decomposed at a specified temperature. Table 73.1 lists the 10-hour $t_{1/2}$ temperature ranges for the major organic peroxide types. Peroxides of certain types, such as hydroperoxides and ketone peroxides, are primarily used in combination with promoters and are employed at temperatures much lower than their measured 10-hour $t_{1/2}$ temperature.

TABLE 73.1 Commercial Peroxide Classification

Peroxide Type	Structure	10-Hour $t_{1/2}$ Tange (°C)
Diacyl peroxides	$\begin{array}{c} \text{O} \quad \text{O} \\ \parallel \quad \parallel \\ \text{RCOOCR} \end{array}$	20–75
Acetyl alkylsulfonyl peroxides	$\begin{array}{c} \text{O} \quad \text{O} \\ \uparrow \quad \parallel \\ \text{RSOOCCH}_3 \\ \downarrow \\ \text{O} \end{array}$	32–42
Dialkyl peroxydicarbonates	$\begin{array}{c} \text{O} \quad \text{O} \\ \parallel \quad \parallel \\ \text{ROCOOCR} \end{array}$	49–51
<i>tert</i> -Alkyl peroxyesters	$\begin{array}{c} \text{O} \\ \parallel \\ \text{R}'\text{COOR} \end{array}$	49–107
<i>oo-tert</i> -Alkyl <i>o</i> -alkyl monoperoxydicarbonates	$\begin{array}{c} \text{O} \\ \parallel \\ \text{ROOCOR}' \end{array}$	90–100
Di- <i>tert</i> -alkyl peroxyketals	$\begin{array}{c} \text{ROO} \quad \text{R}' \\ \diagdown \quad \diagup \\ \text{C} \\ \diagup \quad \diagdown \\ \text{ROO} \quad \text{R}' \end{array}$	92–115
Di- <i>tert</i> -alkyl peroxides	ROOR'	117–133
<i>tert</i> -Alkyl hydroperoxides	ROOH	133–175
Ketone peroxides	$\begin{array}{c} \text{R} \quad \text{OOH} \\ \diagdown \quad \diagup \\ \text{C} \\ \diagup \quad \diagdown \\ \text{R}' \quad \text{OOH} \end{array}$	
	$\begin{array}{c} \text{R}' \quad \text{O} \quad \text{O} \quad \text{R}' \\ \diagdown \quad \diagup \quad \diagdown \quad \diagup \\ \text{C} \quad \text{O} \quad \text{O} \quad \text{C} \\ \diagup \quad \diagdown \quad \diagup \quad \diagdown \\ \text{HOO} \quad \text{R} \quad \text{R} \quad \text{OOH} \end{array}$	

73.2.1 Peroxide Selection

To a large extent, the half-life range at which an organic peroxide decomposes determines the application and controls overall process efficiency and product quality. In their product bulletins, organic peroxide producers often provide half-life data over a wide range of temperatures. For optimum efficiency, however, a peroxide is usually chosen so that the half-life under the reaction conditions is in the range of 10 to 20 min. This ensures the steady generation of radicals at such a rate that the heat of reaction can be safely contained and a high conversion of monomer to polymer results.

It is important to note, however, that peroxide half-life data are usually determined in select inert solvents and low peroxide concentration. Decomposition rates can be affected by solvent polarity, radical-induced decomposition, and peroxide concentration.⁵

The temperature activity is not the sole consideration in selecting an organic peroxide for a particular application. Other factors to be taken into account include cost, solubility, safety, efficiency and type of

TABLE 73.2 Bond Dissociation Energy of Typical Compounds

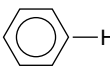
Bond in Parent Compound	Dissociation Energy [kcal/mol (kJ/mole)]
(R) ₃ C-H	91 (381)
(R) ₂ CH-H	95 (397)
RCH ₂ -H	98 (410)
CH ₃ -H	104 (435)
RO-H	105 (439)
	112 (469)
	112 (469)
-H	119 (498)
HO-H	119 (498)
ROO-H	90 (377)

radicals produced, necessity for refrigerated storage and shipment, compatibility with production equipment, effect on the final product, and the ability to be activated.

73.2.2 Radical Types

Although organic peroxides initially cleave at the oxygen–oxygen bond, other bond cleavages can and do occur, either simultaneously with or sequentially to the oxygen–oxygen bond dissociation. The relative stability of the R radical determines whether a peroxide undergoes single- or multiple-bond homolysis. The relative stability of the R radicals, in turn, can be correlated with the carbon–hydrogen or oxygen–hydrogen bond dissociation energies of the parent compound, as shown in Table 73.2.^{6–10}

The higher the bond dissociation energy, the less stable (more reactive) is the corresponding radical that is formed by removing the hydrogen atom. Thus, the phenyl radical is significantly more reactive than the alkyl radicals. The relative stability of alkyl radicals is in the order of *tert*-alkyl > *sec*-alkyl > *n*-alkyl > methyl. The methyl radical is about as reactive as an alkoxy radical.

One reaction that follows the peroxide linkage dissociation is the β -scission reaction:

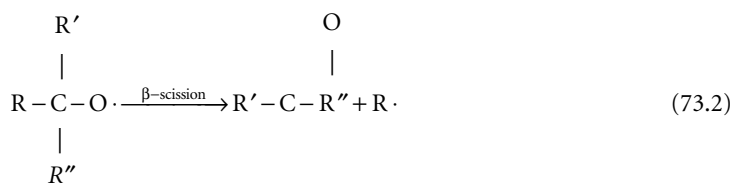

One of the R groups splits off to form a new alkyl radical and a ketone. The group that splits off forms the most stable radical. If the radical that splits off is more stable than the alkoxy radical, the β -scission reaction will be fast, and the predominant initiating species will be the alkyl radical rather than the alkoxy radical. The rate of β -scission also depends on temperature and pressure; that is, more scission occurs if the alkoxy radical is generated at higher temperatures and pressures.

For example, Figure 73.1 illustrates the β -scission reaction for two alkoxy radicals: one formed by the decomposition of a *t*-butylperoxy compound to the *t*-butoxy radical, the other by the decomposition of a *t*-amylperoxy compound to the *t*-amyloxy radical.¹¹ In this illustration, the initiating species for the *t*-butyl peroxide is either the *t*-butoxy radical or the methyl radical. The β -scission reaction is slow because both radicals are highly reactive based on the bond dissociation energies in Table 73.2. On the other

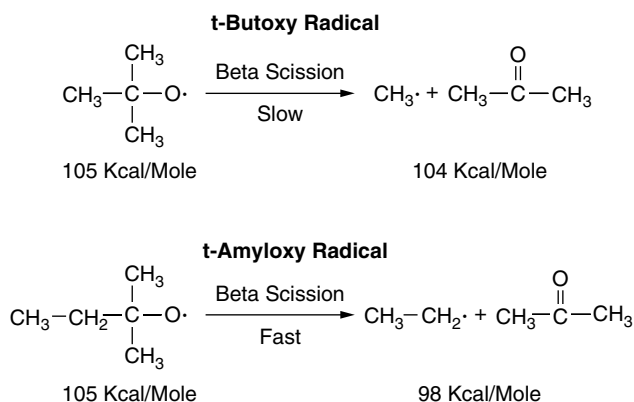

FIGURE 73.1 The β -scission reactions.

hand, the *t*-amyloxy radical undergoes β -scission predominantly to yield acetone and a lower energy ethyl radical.

The radical type can be either beneficial or detrimental, depending on the application. Phenyl, alkoxy-carbonyloxy, alkoxy, and methyl radicals are capable of hydrogen abstraction, which can lead to cross-linking, chain branching, and polymer degradation. *Tert*-Alkyl, *sec*-alkyl, *n*-alkyl, and *tert*-cumyl radicals are less energetic, more selective radicals. These radical types contribute to greater chain linearity and a narrower molecular weight distribution.

73.3 Application in Coatings

Organic peroxides are commonly used in the preparation of solution acrylic thermoplastic and thermosetting resins and the graft modification of alkyd resins. Some organic peroxides that are suitable as initiators for acrylic polymers and copolymers are listed in Table 73.3.¹²⁻¹⁵

Efforts in recent years have been directed toward the production of hydroxy-functional acrylic oligomers for use in high solids coatings applications.¹⁶⁻¹⁹ To achieve high solids coatings, acrylic polyol resins of low molecular weight and a narrow molecular weight distribution must be used to ensure an acceptable solution viscosity in the coatings formulation. In the synthesis of these resins, azonitrile and peroxide initiators, alone or in combination with high concentration of a chain transfer agent and high temperature, are employed.²⁰⁻²⁶ However, certain peroxide initiators that abstract hydrogens cause chain branching, a broadening of the molecular weight distribution, and a high solution viscosity. In addition, the

TABLE 73.3 Organic Peroxide Initiators for the Polymerization of Acrylics

Peroxide	Half-life Temperature (°C)		
	10 h	1 h	Ref.
Dibenzoyl peroxide	73	91	12
<i>t</i> -Butylperoxy-2-ethylhexanoate	77	95	13
<i>t</i> -Butylperoxybenzoate	102	120	13
Dicumyl peroxide	116	136	14
Di- <i>t</i> -butyl peroxide	126	149	14
<i>t</i> -Amylperoxy-2-ethylhexanoate	75	92	15
<i>t</i> -Amylperoxybenzoate	100	121	15
<i>t</i> -Amylperoxyacetate	100	120	15
1,1-Di-(<i>t</i> -amylperoxy)cyclohexane	93	112	15
2,2-Di-(<i>t</i> -amylperoxy)propane	108	128	15
Ethyl 3,3-di-(<i>t</i> -amylperoxy)butyrate	112	125	15

use of mercaptan chain transfer agents is known to produce objectionable odors, as well as color and light instability in the coating.²⁶

In a recent report, the use of *t*-amyl peroxides has been shown to produce acrylic oligomers with low molecular weight, narrow molecular weight distribution, low color, and low solution viscosity without an added chain transfer agent.^{27,28} The *t*-amyl peroxide initiated resins also gave better gloss and gloss retention in accelerated weathering.

In the graft modification of alkyd resins, the proportion of the graft copolymer formed has been shown to be dependent on the nature of the radical initiator used.^{29,30} *t*-Butyl peroxides have been shown to be preferable to azonitriles because of the formation of a more reactive radical favoring graft copolymer formation.

73.4 Safety Factors and Producers

Organic peroxides are useful initiators because of their thermal instability. Since peroxide initiators encompass a wide temperature activity range, a safe temperature for one peroxide may be unsafe for another. Manufacturers' recommendations should be carefully followed for handling, storage, and disposal. In addition, compounds such as transition metals, amines, strong acids and bases, and reducing agents can accelerate peroxide decomposition. Consequently, peroxides should be kept free of contamination. Only peroxides and peroxide formulations that can be shipped and utilized with a reasonable degree of safety are produced commercially.

73.5 Future Trends

The current trend in organic peroxide research is to commercialize new multifunctional initiators, that is, peroxides with functionality other than simply being free radical sources. For example, organic peroxides that contain a hydroxyl group have recently been introduced commercially.³¹

Polymeric peroxides that contain the peroxide linkage in the main chain of the polymer, on the end of a polymer, and pendent to the polymer chain have been investigated.³²⁻³⁷ Organic peroxides containing a ultraviolet light absorbing³⁸ or a hindered amine light stabilizer^{39,40} group have been used to synthesize polymers with the stabilizer group chemically bound to the polymer.

References

1. D. Swern, *Organic Peroxides*, Vol. 1. New York: Wiley-Interscience, 1970.
2. D. Swern, *Organic Peroxides*, Vol. 2. New York: Wiley-Interscience, 1971.
3. C. S. Sheppard and O. L. Mageli, in *Encyclopedia of Chemical Technology*, Vol. 17, 3rd ed. H. F. Mark, D. F. Othmer, C. G. Overberger, and G. T. Seaborg, Eds. New York: Wiley-Interscience, 1982, p. 27.
4. R. L. Pastorino and R. N. Lewis, in *Modern Plastics Encyclopedia*, Vol. 64, 10A, R. Juran, ed. New York: McGraw-Hill, 1988, p. 165.
5. C. S. Sheppard, in *Encyclopedia of Polymer Science and Technology*, Vol. 11, 2nd ed. H. F. Mark, N. H. Bikales, C. G. Overberger, and G. Menged, Eds. New York: Wiley-Interscience, 1988, p. 1.
6. D. M. Golden and S. W. Benson, *Chem. Rev.*, 69, 125 (1969).
7. P. Gray, A. A. Herod, and A. Jones, *Chem. Rev.*, 71, 289 (1971).
8. A. A. Zavitsas, *J. Am. Chem. Soc.*, 94, 2779, 2788 (1972).
9. R. T. Sanderson, *J. Am. Chem. Soc.*, 97, 1367 (1975).
10. R. S. Nangla and S. W. Benson, *J. Phys. Chem.*, 83, 1138 (1979).
11. R. J. Kirchgessner, V. R. Kamath, C. S. Sheppard, and S. E. Stromberg, *Mod. Plast.*, 61(11), 66 (1984).
12. *Diacyl Peroxides* (product bulletin), Lucidol Division, Pennwalt Corporation, Buffalo, NY, 1986.
13. *Peroxyesters* (product bulletin), Lucidol Division, Pennwalt Corporation, Buffalo, NY, 1986.
14. *Dialkyl Peroxides* (product bulletin), Lucidol Division, Pennwalt Corporation, Buffalo, NY, 1985.

15. *t*-Amyl Peroxides (product bulletin), Lucidol Division, Pennwalt Corporation, Buffalo, NY, 1985.
16. M. Takahashi, *Polym. Plast. Technol. Eng.*, 15, 1 (1980).
17. L. W. Hill and Z. W. Wicks, Jr., *Prog. Org. Coat.*, 10, 55 (1982).
18. R. H. Kuhn, N. Roman, and J. D. Whitman, *Mod. Paint Coat.*, 71(5), 50 (1981).
19. R. F. Storey, in *Surface Coatings*, A. L. Wilson, J. W. Nicholson, and H. J. Prosser, Eds. London: Elsevier Applied Science, 1987, p. 69.
20. C. J. Bouboulis, U.S. Patent 4,739,006 (1988).
21. D. Rhum and P. F. Aluotto, U.S. Patent 4,075,242 (1978).
22. Y. Eguchi and A. Yamada, U.S. Patent 4,687,882 (1987).
23. W. R. Berghoff, U.S. Patent 4,716,200 (1987).
24. R. A. Gray, *J. Technol.*, 57(728), 83 (1985).
25. R. Buter, *J. Technol.*, 59(749), 37 (1987).
26. D. Rhum and P. F. Aluotto, *J. Technol.*, 55(703), 75 (1983).
27. V. R. Kamath and J. D. Sargent, Jr., *J. Coat. Technol.*, 59(746), 51 (1987).
28. V. R. Kamath, U.S. Patent pending.
29. F. M. Merrett, *Trans. Faraday Soc.*, 50, 759 (1954).
30. D. H. Solomon, *J. Oil Colour. Chem. Assoc.*, 45, 88 (1962).
31. J. Sanchez, U.S. Patent 4,525,308 (1985).
32. A. J. D'Angelo and O. L. Mageli, U.S. Patents 4,304,882 (1981), 3,952,041 (1976), 3,991,109 (1976), 3,706,818 (1972), and 3,839,390 (1974).
33. A. J. D'Angelo, U.S. Patent 3,671,651 (1972).
34. R. A. Bafford, U.S. Patent 3,800,007 (1974).
35. R. A. Bafford, E. R. Kamens, and O. L. Mageli, U.S. Patent 3,763,112 (1973).
36. O. L. Mageli, R. E. Light, Jr., and R. B. Gallagher, U.S. Patent 3,536,676 (1970).
37. H. Ohmura and M. Nakayama, U.S. Patent 4,659,769 (1987).
38. C. S. Sheppard and R. E. MacLeay, U.S. Patents 4,042,773 (1977) and 4,045,427 (1977).
39. T. N. Myers, European Patent Appl., 223,476 (1987).
40. P. A. Callais, V. R. Kamath, and J. D. Sargent, *Proc. Water-Borne Higher Solids Coatings Symp.*, 15, 104 (1988).

74

Surfactants for Waterborne Coatings Applications

74.1	Introduction	74-1
74.2	Chemistry.....	74-1
74.3	Theory.....	74-2
74.4	Foam Control	74-3
74.5	Wetting.....	74-4
74.6	Conclusion	74-5

Samuel P. Morell
S. P. Morell and Company

74.1 Introduction

As governmental regulations become increasingly restrictive, waterborne coatings appear to be the logical choice for many paint manufacturers. However, the technological switch from solvent to waterborne systems requires an understanding of the challenges that lay ahead with respect to wetting, foam control, and coverage over difficult-to-wet substrates.

This chapter will help explain the important contribution of wetting agents and defoamers to the emerging technology of waterborne coatings. Topics will include the chemistry of several surfactants along with a thorough analysis and understanding of surface tension. Surface tension reduction and mechanisms relating to foam stabilization will be reviewed.

74.2 Chemistry

All surfactants fall into two classifications, nonionic and ionic. Within the ionic category, surfactants can be further subdivided into anionic, cationic, or amphoteric types. For coatings, most surfactants utilized are either nonionic or anionic. For wetting agents, the products we will compare include alkylphenol ethoxylates, sodium dioctyl sulfosuccinates, sodium laurel sulfates, block copolymers of ethylene and propylene oxides, alkyl benzene sulfonates, and, finally, a specialty class called acetylenic glycols. We start with this.

Acetylenic glycols are a chemically unique group of nonionic surface active agents that have been especially designed to provide multifunctional benefits to a wide array of waterborne coating products. Two key benefits include an unusual combination of wetting and foam control properties.

Characterized as an acetylenic *diol*, we have a 10-carbon backbone molecule with a triple bond, two adjacent hydroxyl groups, and four symmetrical methyl groups. Based on acetylene chemistry, this product is unlike any other surfactant molecule. The combination of the triple bond and the two hydroxyl groups creates a domain of high electron density, making this portion of the molecule polar and thus

hydrophilic. The highly branched methyl groups, along with the backbone, supply the hydrophobic property creating an excellent surface tension reducer. Additionally, this particular product was designed to be nonfoaming by careful engineering of the hydrophobe/hydrophile ratio.

Alkylphenol ethoxylates are commonly used in many applications. The hydrophile is the ethoxylated portion, which can be regulated by the amount of ethylene oxide (EO) employed. The hydrophobe is generally based on either octylphenol or nonylphenol.

Block copolymers are another class of nonionic surfactants. The geometrical configuration is similar to the acetylenic glycol except that it is reversed. The “outside” hydrophilic portions are EO links, and the central hydrophobe is based on propylene oxide (PO) links. Both of these can be manipulated to affect its overall molecular weight and HLB classification.

Sodium laurel sulfate, or SLS, is a popular anionic surfactant utilized in the emulsion polymerization of many vehicle binders. The sodium sulfate component is the hydrophilic part, while the lauryl portion is the hydrophobe.

Finally, sulfosuccinates are a class of interesting anionic surface active agents. The central hydrophile is the sodium salt of the sulfosuccinate, while the hydrophobe is generally dioctyl. This ionic surfactant is sometimes referred to as DOS (sodium dioctyl sulfosuccinate).

74.3 Theory

Now, before we discuss the practical formulating benefits of surfactants in greater detail, it may be helpful to review the theoretical differences between some of these products. This will particularly aid our understanding of how some can actually contribute to foam control properties besides wetting. But first, let us review some fundamental concepts.

A good place to start is with a definition. What is a surfactant? First, the name is an acronym formed by combining the words surface active agent. A surfactant can be defined as any substance that will significantly reduce the surface tension of a liquid at a very low concentration. Even within the context of this definition, there may be terms that are not fully understood. For example, what do we mean when we say “surface tension”? To define this concept, it is best first to review chemical bonds, both interatomic and intermolecular. These include covalent, ionic, and intermolecular.

When we think of covalent bonds, generally the first thing that comes to mind is a sharing of electrons. However, some atoms share more than others do. An equal distribution of shared electrons occurs with hydrogen gas. Each atom of this molecule has one electron in its valence shell and is seeking another with a similar condition (i.e., another hydrogen atom) to help complete its shell with two electrons. Since there is no need for the electrons to orbit more often over one compared to the other, this equitable distribution results in a nonpolar covalent association.

The water molecule is different. The oxygen atom has six electrons in its outer valence shell and desperately needs two more to complete the required eight. This “hunger” for electrons makes this particular atom more electronegative than hydrogen. Therefore, when it attracts two hydrogen atoms, it surrounds itself more often than not with a complete set. This disproportionate sharing results in a slight negative charge to the oxygen atom while at the same time it renders a slight positive charge to the other two hydrogens. This type of covalent bond is called polar because the molecule resembles the positive and negative poles of a magnet.

Naturally, polar molecules attract one another by aligning themselves via their opposing poles (positive to negative and negative to positive). In the case of water, this type of intermolecular attraction is known as hydrogen bonding. Therefore, when we examine a water molecule in the bulk, we find it pulled in all directions with equal force and, as a result, it is said to be in equilibrium. However, the molecules on the surface have no molecules above to attract to and, therefore, the net effect is a downward force into the bulk. This is surface tension.

The ability of a surfactant to reduce tension in water, for example, results from the combined hydrophilic and hydrophobic parts of its structure. As a result of the hydrophobic part, these molecules tend to collect at the water–air interface, for example, when added to an aqueous medium. The presence of

surfactant molecules at this interface results in a compressive force acting on the surface, a force that is known as surface pressure. A simple experiment demonstrates surface pressure. A limp loop of thread on water will snap into a circle when the water inside is touched by soap. It is this surface compressive force, or surface pressure, that reduces the surface energy or surface tension.

Sometimes it is difficult to relate to the concept of surface tension. It is much easier to think in terms of surface pressure. There is a relationship between the two terms: The surface pressure of a surfactant solution at a certain concentration is equal to the surface tension of the pure solvent minus the surface tension of the surfactant solution at the same concentration. Therefore, as the surfactant concentration is increased, there is a corresponding increase in surface pressure and, as a result, surface tension is reduced.

When the surface is completely saturated with surfactant molecules and the surface pressure approaches its greatest value, the incremental addition of most surfactants will result in the formation of micelles. This is known as the critical micelle concentration. These micelles can take on different forms including spherical or cylindrical shapes.

At high concentrations, most surfactants condense into a solid structured elastic film as a result of the molecular attraction between the chains of methylene groups in neighboring molecules. This solid structured film determines the surface property of the surfactant solution and helps explain how some surface active agents contribute to foam generation and stabilization.

74.4 Foam Control

In pure water, an air bubble rises attempting to achieve the same equilibrium state with the denser fluid on the bottom. It should be noted that sustained foam, that is, foam in which air or gas is firmly entrapped in a liquid for a considerable interval of time, only occurs in a complicated colloidal system. Therefore, it is not possible for foam to exist in a *pure* liquid.

The colloids in a foamy system are surfactants with varying degrees of hydrophilic/hydrophobic balance. Here, the hydrophobic hydrocarbon tails protrude from the water, both at the top surface and within the bubble, with the circular polar hydrophilic heads engaged into the water phase. As mentioned earlier, most surfactants that concentrate at this gas/liquid interface are capable of forming a solid structured elastic film. Therefore, gases that rise in these systems expand these elastic films without rupturing them. The result is that entrapped air gradually rises to the surface as froth or bubbles.

A closer view of the lamella (the foam bubble wall) would reveal the continuous motions caused by concentration gradients along the surface. Drainage of the bulk liquid, due to gravitational forces, results in surface pressure variations. This pressure differential is alleviated by the movement of surfactant molecules from concentrated high pressure areas to lower concentrated areas. Along with this movement is surface transport of water molecules. This counter drainage movement is known as the Plateau Marangoni Gibbs effect and is responsible for restoring the bubble wall and giving it its surface elasticity and stability.

A good example demonstrating surface transport occurs in cocktail glasses. A water–alcohol mixture swirled around in a glass leads to wine tears, drops that move up and down the side of the glass. Alcohol evaporation of the liquid film on the glass increases its surface tension and thus lowers its surface pressure. The surface is, therefore, continuously pulled from the bulk liquid up the side of the glass. Liquid pumped up in this fashion accumulates to form wine tears.

In an acetylenic diol solution, for example, drainage takes place, but the hydrophobic nature of these molecules allows them to migrate *rapidly* to the interface and help alleviate any pressure differential. At the final moment, these molecules slip away from each other, due to low intermolecular attraction, and the wall collapses. This explains why an acetylenic diol solution does not foam.

Acetylenic diols also help control foamy systems generated by other surfactants, since they interfere with the close packing of these foam-stabilizing species at the interface and thereby reduce surface monolayer rigidity. It is further theorized that due to the hydrophobic nature of defoamers they are likely to compete with the water–air interface by capturing the hydrophobic ends of surfactant molecules and therefore rendering the lamella unstable.

There appears to be some confusion with respect to foam control jargon, i.e., nonfoaming, antifoaming, defoaming, and de-air-entrainment. Let us try to clarify these points in order to discern the differences properly.

To illustrate *nonfoaming*, a 0.1% solution of an alkylphenol ethoxylate in water and an equal surfactant concentration of the acetylenic diol is prepared. After both cylinders are simply hand agitated, considerable foam is generated by the alkylphenol ethoxylate, yet no foam appears with the acetylene-based solution. The lack of foam generated by the acetylenic diol is what makes it nonfoaming.

When a 0.1% solution containing a 50/50 mixture of these two surfactants is prepared, the acetylenic diol will demonstrate its *antifoaming* property, that is, the prevention of foam normally generated by other substances.

Finally, acetylene-based surfactants help to *defoam* systems that already contain foam. Adding some to an existing foam will demonstrate that property as well.

To summarize, what is observed is that acetylenic diols are not only nonfoaming but also reduce the foam generated from substances such as alkylphenol ethoxylates.

Besides water solutions, acetylenic diols are also effective in binder systems. SBR latex, in particular, is recognized for its foamy tendency as a result of the surfactants used to stabilize that emulsion, sodium laurel sulfate. A quantity of 200 mils of an SBR latex is poured into a Hobart and blended for 5 min. Remeasuring the volume of blended latex reveals another class of foam that a coatings formulator must consider, *air entrainment*.

The addition of most surfactants, like sulfosuccinates, will only aggravate the problem. However, when the acetylenic diol is formulated into this latex, its de-air-entrainment properties can be easily seen, especially when compared to the other systems.

74.5 Wetting

One of the most important functions of a surfactant in a coating formulation is to facilitate the wetting of various substances including the substrate to be coated or the pigment particle to be dispersed. A coatings formulator should consider surfactants that are particularly effective wetting agents under *dynamic* conditions where new surfaces are continuously being formed. The property of dynamic wetting is a measure of the ability of a surfactant to wet instantaneously any newly created surfaces. During coating production and application, new surfaces are continuously generated.

The traditional methods of measuring surface tension using the DuNouy ring or the Wilhelmy plate presume that the surface is static or at equilibrium. Unfortunately, that does not simulate real-world conditions or operations. A better approach makes use of more sophisticated instrumentation such as the maximum bubble pressure tensiometer, which can measure surface tension under both equilibrium and dynamic conditions.

This apparatus has two Teflon tubes immersed in the sample liquid. The tubes are connected to a supply of gas and to a pressure-measuring transducer. When the gas flows through the tubes, measurements are recorded as bubbles begin to form in the liquid. The gas flow rate can be regulated to change the rate of bubble formation. Measurements at one bubble per second, for example, simulate equilibrium or static conditions, while six bubbles per second are certainly more dynamic. Therefore, the faster the bubble rate, the faster the rate of surface formation.

Let us examine a practical benefit of dynamic surface tension reduction with respect to coverage over difficult-to-wet substrates.

A very common problem with waterborne coatings is that they are particularly susceptible to surfaces that have not been properly cleaned or prepared. Surface contamination problems, which can result from oil, fingerprints, or dirt particles, can cause the final coating to exhibit poor coverage, edge pool, craters, pinholes, and even reduced adhesion. These problems can be effectively reduced with the addition of surfactants that allow extremely low dynamic surface tensions.

To illustrate this point, we start with two identical panels. To simulate problems that can occur in practice, we apply mineral oil on each panel. This is spread evenly over the face of the panels with a paper tissue.

In a recommended acrylic emulsion coil coating formulation, both the wetting agent *and* the defoamer were replaced with an acetylenic diol. When the acetylene-based formulation is drawn down, good coverage was noted even under the adverse conditions of an oil contaminated surface. The control formulation encountered significant problems with film retraction under the same conditions.

74.6 Conclusion

Additives play a very important role in the emerging technology of waterborne coatings. They affect all aspects of the coating process — production, storage, application, and performance. Hopefully, this chapter communicated a better understanding of how specifically wetting agents and defoamers work and the contributions they provide to the coatings industry.

75

Surfactants, Dispersants, and Defoamers for the Coatings, Inks, and Adhesives Industries

75.1	Introduction	75-1
75.2	Wetting and Dispersing Process	75-2
	The Wetting and Dispersing Process • Waterborne Systems • Solvent-Based Systems • Classification • Summary	
75.3	Silicones and Surface Flow Control Agents.....	75-6
	Background • Chemical Structure of “Silicones” • Surface Phenomena and the Elimination of Defects • Summary	
75.4	Defoaming Additives.....	75-9
	The Nature of Foam • Defoamers versus Air Release Agents • The Mechanisms of Defoaming and Air Release • Defoamers for Aqueous Systems • Defoamers for Solvent-Based Systems • Selection Criteria and Test Methods • Summary	
75.5	Conclusion	75-12
	References	75-12

John W Du
BYK-Chemie USA

75.1 Introduction

Over the history of coatings, inks, and adhesives, many evolutionary changes have occurred; not only have the ingredients used to make the formulations been changed, but also the physical characteristics of the formulations along with their application, cure, and performance parameters have changed.

Of course, each trend poses challenges to both raw material suppliers and formulators alike. Because additives are used to enable and enhance system performance, the evolution of resins, pigments, solvents, and application technologies pose special challenges for additive suppliers.

Resin and solvent combinations used in the good old days were typically quite low in surface tensions in comparison to modern formulations. Today's more environmentally friendly formulations with little or no solvents, or in the case of aqueous formulations, with little or no cosolvents, require increased use of interfacially active materials in order to provide adequate substrate wetting, surface flow, and the prevention of foaming and air entrapment.

Interfaces play an important role in the production and application of coating systems. For the coatings chemist, the following interfaces are of particular interest: solid/air, solid/liquid, liquid/air, and liquid/liquid.

During the pigment wetting and dispersion stage, air at the pigment surface is displaced by the resin/solvent solution; the solid/air (pigment/air) interface at the pigment surface is replaced by a solid/liquid (pigment/resin solution) interface. During manufacturing and application, additional interfaces become important: solid/liquid (substrate/liquid, others), liquid/liquid (oil contamination, wet-on-wet application, mixing, etc.), as well as liquid/air (foam, entrapped air, surface leveling, etc.). The selection of the proper additive chemistry and concentration provides the coatings formulator with the means to manipulate and control these interfaces.

As environmentally friendly coatings, inks, and adhesive systems have evolved, additives have also evolved in chemistry, structure, and effectiveness. This overview strives to present these new additive technologies in three areas: surfactants, dispersants, and defoamers. The chemical nature of these additives and subsequent performance in a variety of systems will be described.

While there is significant overlap of the three phenomena being discussed, this chapter will attempt to establish some clear delineation between the chemical structure of the additives and their performance as surfactants, defoamers, and dispersants.

This chapter will strive to develop a unified approach to describe the phenomena of the following:

1. Wetting and dispersing additives
2. Silicone and surface flow control agents
3. Defoaming additives

75.2 Wetting and Dispersing Process

Wetting and dispersing additives are designed to prevent defects such as flocculation, gloss reduction, flooding and floating, formation of Bénard cells, pigment setting, and rheology problems.

75.2.1 The Wetting and Dispersing Process

During the initial phase of the pigment wetting process, the air and adsorbed water at the pigment surface must be displaced by the binder solution. This means that the solid/gas interface (pigment/air) needs to make the transition to become a solid/liquid (pigment/binder) interface.

In order to successfully complete the wetting phase, the interfacial tension difference between the pigment and binder solution must be bridged over, so to speak. This bridging process can be enhanced by the use of appropriate wetting agents.

Homogeneous particle distribution enhances the transition process and is crucial to improved performance; interfacially active substances, which bridge the boundaries between solid and liquid media, are therefore essential. From a practical standpoint, proper distribution is necessary not only during manufacturing and application but also for storage.

The transition process is pictured in [Figure 75.1](#). As shown, the pigment agglomerates are dispersed by mechanical energy (impact/shear) so that their particle sizes are reduced. The technology of the equipment (in combination with properly adjusted millbase formulations and grinding media) is paramount to the success of the dispersion (grinding) process. Through the input of mechanical energy, the dispersed pigment particles are brought to a higher energy state than the starting agglomerates. These dispersed pigment particles continually strive to reach their lowest energy state, so they will try to flocculate or agglomerate unless a means for stabilization is introduced. Inadequately stabilized pigmented coating systems will exhibit sedimentation, a reduction of gloss, a change of color when rubbed, and possible flooding and floating. Dispersing or dispersion stabilizing additives prevent the dispersed pigment particles from flocculating or agglomerating by attaching themselves to the surface of the dispersed pigment particles. The stabilizing additive on the pigment surface spaces the pigment particles from each other, thus preventing flocculation or pigment-to-pigment contact.

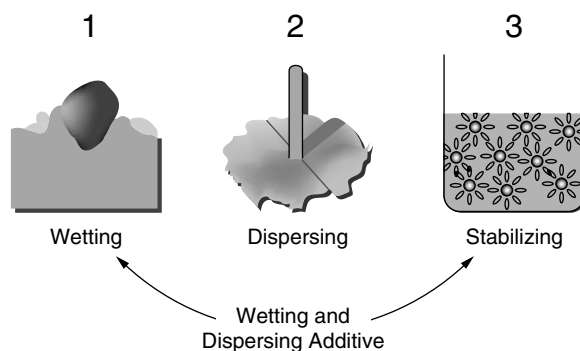

FIGURE 75.1 The wetting and dispersion stabilization process.

75.2.2 Waterborne Systems

75.2.2.1 Wetting Additives for Waterborne Systems

Wetting additives reduce interfacial tension and, as a result, increase the spreading pressure of the liquid continuous phase. Characteristic of such substances is their highly surface-active structure (polar, hydrophilic structural elements along with nonpolar, hydrophobic structural elements combined into a single molecule). Such substances migrate to the pigment/binder solution interface. In waterborne systems, there is often a specific additive used for the wetting process. In a solvent-based system, the additive is typically responsible for both wetting and dispersing (this will be discussed later).

Influential factors in this wetting process include the polarities of the pigment surface and binder solution, the viscosity of the liquid phase, as well as the geometry of the empty spaces (or pores) within the pigment agglomerate structures. Of utmost importance is the interfacial tension in the exact areas where the wetting additive performs — between the pigment surface and the resin solution.

75.2.2.2 Dispersing Additives for Waterborne Systems

There are two principle mechanisms for stabilizing dispersed pigments into a resin solution. These spacing techniques are electrostatic repulsion and steric hindrance.

In electrostatic repulsion, the pigment particles in the liquid carry electrical charges on their surfaces. With the use of special additives, it is possible to strengthen these charges and, furthermore, to make all of the pigment particles equally charged. Counterions concentrate around the pigment particles so that an electrical double-layer is formed; stabilization increases with layer thickness. This particular electrostatic repulsion stabilizing mechanism is especially useful in waterborne latex systems. Chemically speaking, the additives used for dispersion in such systems are polyelectrolytes — tailored higher molecular weight products with electrical charges in their side chains. In addition to polyphosphates, many polycarboxylics and derivatives are used as polyelectrolytes in the coatings industry. These adsorb onto pigment surfaces and consequently transfer their charge to pigment particles. Through electrostatic repulsion between equally charged pigment particles, the deflocculated state is stabilized. This is the primary mechanism of pigment stabilization in many waterborne systems.

Dispersion stabilizing additives that function by steric hindrance display two special structural features. First, these additives contain one or more so-called pigment-affinic groups (anchoring or adhesive groups), all of which provide strong adsorption onto pigment surfaces. Second, these additives contain resin-compatible chains (hydrocarbon entities), which following adsorption of the additive's pigment affinic groups onto the pigment, protrude as far as possible from the pigment surface into the surrounding resin solution. This layer of adsorbed additive molecules with protruding chains produces steric hindrance or “entropic stabilization.”

Newly developed specialized additive chemistries make use of the above stabilization mechanism. Furthermore, this mechanism is accentuated by the interaction of the polymeric segments of the additive

with the resin polymer in such a manner, that the envelope, so to speak, around the pigment particles is enlarged. Through specific structural elements composed of pigment-affinic groups (polar) and resin-compatible chains (nonpolar), these additives exhibit definitive surface activity. In other words, they not only stabilize the pigment dispersion but also function as wetting additives.

75.2.3 Solvent-Based Systems

“Wetting and dispersing,” as a term, should not be separated when discussing nonaqueous systems. The process first involves wetting, which is usually the removal or displacement of air or moisture from the pigment surface, and then subsequently, dispersion, which is the use of appropriate mechanical forces to produce primary pigment particles. Finally, stabilization of these particles is necessary to keep them from flocculating. If the deflocculated system is not adequately stabilized (as discussed previously), then the system reverts to a lower energy state, that being the flocculated state.

The primary mechanism of stabilization for solvent-based systems is steric hindrance, as discussed in the previous section.

Additionally, electrostatic repulsion plays an important role, especially when more than one pigment is present in a mixture. It has been demonstrated that certain high molecular weight species in the proper formulations are very beneficial in depositing a positive charge on various pigments (independent of initial pigment charge or type: even difficult-to-stabilize organic pigments can be controlled). Further details are discussed in later sections of this chapter.

75.2.4 Classification

Wetting and dispersing additives for solvent-based systems can be classified by their chemistry and how they function. Chemically, they may be classified as “anionic,” “cationic,” or “electro neutral.” Experience shows, however, that this classification does not necessarily permit conclusions concerning the effectiveness of any class of additive.

A more meaningful classification is to differentiate between deflocculating and controlled flocculating types, shown in Figure 75.2. (Keeping in mind that an unabridged description of the complexity of surfactant behavior would require several thousand pages, only a cursory examination of surfactant behavior is included in this overview chapter.)

Deflocculation means that pigments, to the greatest extent possible, are stabilized as single particles and are sterically separated from each other as described in an ideal dispersion. This causes a shift in rheological behavior toward Newtonian flow, and thus, providing excellent flow properties, high gloss, optimal hiding, millbase viscosity reduction, high transparency (of transparent pigments), and development of the proper coloristic features of the pigments.

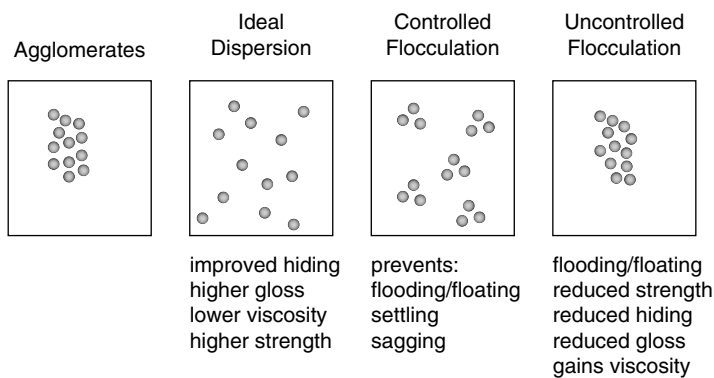

FIGURE 75.2 States of dispersion.

Controlled flocculation means that pigments and extenders are stabilized as defined and selectively interactive units or groups of multiple particles. Rheology will be modified to exhibit thixotropic behavior, resulting in improved resistance to settling and sagging. A coating system stabilized in this manner will also be more resistant to flooding or floating.

75.2.4.1 Deflocculating Additives

Depending on the actual ingredients of a given formulation, wetting and dispersing behavior can be tailored on a case-by-case basis. One of the more important parameters is the pigment's surface polarity. Highly polar pigment surfaces generally require the use of lower molecular weight polymeric additives, whereas nonpolar pigment surfaces require higher molecular weight species.

Deflocculating additives possess at least one pigment affinic group. Higher molecular weight deflocculating additives generally have multiple pigment affinic groups, arranged in such a manner that all of the groups are available for adsorption onto a pigment particle's surface.

Following additive adsorption, the binder-compatible molecular chains of the additive can then extend into the liquid binder. Enveloping the pigment particles with additive and preventing direct pigment-pigment contact, these binder-compatible chains of the deflocculating additive, in conjunction with the binder, are responsible for steric hindrance. In the case of incompatibility between the molecular chains of the deflocculating additive and the binder, the molecular chains cannot extend into the liquid phase but rather coil, thus failing to provide sufficient spacing and adequate steric hindrance.

Deflocculation generally leads to more efficient pigment utilization, which (especially in the case of some rather expensive organic pigments) is not, economically, unimportant. The degree of deflocculation or flocculation greatly impacts the developed shade or tint of a pigment. If, for example, a system tends to settle during storage, then color shifts may occur. In situations where this is especially critical (such as in the base components of a mixing system), the only acceptable method for producing coatings with a constant and defined color and shade is the complete deflocculation method as described below.

A new group of additives has been recently developed — high molecular weight polymeric wetting and dispersing additives. Such additives provide complete deflocculation and, consequently, differentiate themselves from their conventional low molecular weight analogs through molecular weights sufficiently high to allow these additives to have resin-like characteristics. Additionally, these new additives contain a considerably higher number of pigment-affinic groups per molecule. Because of these structural features, such additives can form durable adsorbed layers onto many organic pigments. Stabilization arises, in part, from steric hindrance (exactly as with the conventional products) in which well-solvated polymer chains are utilized; however, optimal stabilization is possible only when such polymer chains are properly uncoiled (fully extended) and highly compatible with the surrounding resin solution. If this compatibility is compromised (by resin or solvent composition changes), the polymer chains collapse. Consequently, particulate spacing, steric hindrance, and dispersion stabilization are lost.

75.2.4.2 Controlled Flocculation Additives

If the pigment affinic groups are not confined to a small region of the additive molecule but rather are distributed in a specific fashion over the entire molecule, then such an additive will be capable of simultaneously contacting two or more pigment particles in a bridge-like fashion, and controlled flocculation results. At this point, it is important to clarify the difference between the above condition of controlled flocculation and the normal flocculated state. Without additives, the pigment particles make direct contact with one another in uncontrolled flocculation. In contrast, no direct pigment-to-pigment contact occurs in controlled flocculation; additive molecules are always present between the pigment particles.

Ordinary flocculation without additive (resulting in direct pigment-to-pigment contact) is not controllable. Such a flocculated coating will exhibit batch-to-batch variation in properties such as color and shade or perhaps even shelf life; unpredictable nonrecoverable settling and sedimentation occurs during storage.

Controlled flocculation provides a means for particulates to associate with each other without actually coming in contact. This association allows large domains of controlled flocculates to move as a single unit while maintaining the individual particle-to-particle spacing that is required for stability. This type

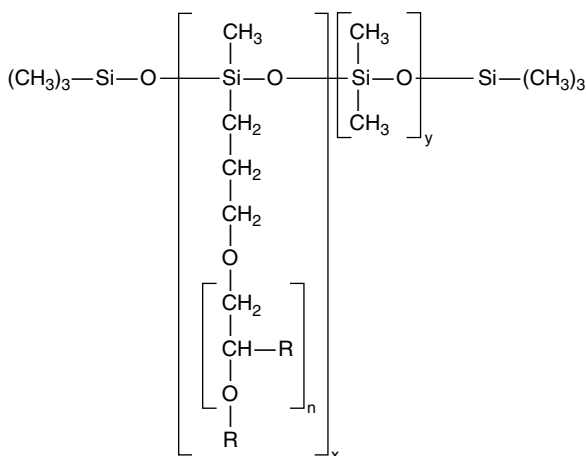

FIGURE 75.3 Polyether-modified dimethylpolysiloxane (hydrolytically stable).

of particulate association results in an apparent high viscosity at low shear conditions. As shear is increased, the controlled flocculate particles are separated from each other. The resulting loss of particulate association causes viscosity to decrease.

Due to the shear forces that occur during coating, rolling, or spraying, the controlled flocculate structures are destroyed. However, the controlled flocculate structure will recover immediately after shear ceases. Suitable processing properties with proper flow can result despite the rather high apparent viscosity of the formulation in the container.

75.2.5 Summary

The manipulation and control of both the solid/gas and the solid/liquid interfaces created when a pigment is incorporated into a system is the prime function of wetting and dispersing additives. Various chemistries and mechanisms are employed, but it is the selective control of the interfacial tensions that optimizes the final properties.^{1-6,16}

75.3 Silicones and Surface Flow Control Agents

75.3.1 Background

The appropriate use of silicone (polysiloxane) additives can help avoid a variety of surface defects — orange peel, crawling, craters, foam, fisheyes, and floating. These six phenomena may, at first glance, appear totally unrelated; however, a clear understanding of surface science and interfacial tension uncovers many commonalities.

One method of tailoring the properties of a dimethylpolysiloxane is by varying the molecular weight. According to the exact performance desired, molecules can be custom designed to function as flow agents, slip aids, defoamers, or even hammer-tone finish additives. As molecular weight increases, incompatibility increases. The key is to achieve a proper balance of peoperties. This balance is more optimally achieved by modifying the polysiloxane with organic chains in order to manipulate compatibility. A typical structure is shown in Figure 75.3.

75.3.2 Chemical Structure of “Silicones”

To further elaborate upon the example structure indicated above, several variations can be discussed. The variables of this molecule are “X”, “Y”, the polyether chain, and the organic modification. An essential point at the synthesis of such siloxanes is the ratio of X to Y. The polyether chain orients itself toward

the organophilic phase (in the resin), whereas the dimethyl group orients toward the hydrophobic phase. The dimethyl group can be oleophobic at the gas/air interface.

Proper molecular design allows control of such features as surface tension, interfacial tension, binder compatibility, recoatability, flow properties, flood/float, slip, and even defoaming. Recent chemical advances have, therefore, greatly expanded the role of silicone additives in coating systems.

75.3.3 Surface Phenomena and the Elimination of Defects

Whereas an exhaustive list of surface phenomena and defects (along with their solutions) would not be practical in this forum, an examination of selected phenomena will afford us a greater understanding of the characteristics and mechanisms of polysiloxane chemistry.

75.3.3.1 Craters

Craters in a surface coating are severe defects and may occur for many reasons. A typical example from the paint industry is cratering due to overspray. If, into a freshly applied and still wet paint film, fine droplets and a different coatings material (overspray) are deposited, then these particles can cause cratering, provided their surface tension is lower than the surface tension of the surrounding wet paint film.

The presence of a surface tension differential (even 1 to 2 mN/m is enough) initiates movement from the area of low surface tension (the droplet) toward the area of higher surface tension (the surrounding paint), and a crater forms. If the surface tension is the same for both paints, no migration will occur. (Please bear in mind that the abbreviated nature of this chapter requires an oversimplification of the phenomena described.) If the overspray has a higher surface tension, no craters will form. With silicones, the surface tension differences of different paint materials can be adjusted so that craters due to overspray can be avoided.

If a solid dust particle (instead of a droplet) with low surface tension falls into the drying system, this can also cause a crater. Lowering the surface tension of the coating with silicones cannot prevent dust particles but will reduce the risk of cratering.

Another cause for craters may be substrate contaminated with fingerprints, dirt, etc. If the contamination has low surface tension, then the coating that contacts it (that is, the paint applied over this contaminated substrate) will crater. This can be described as a special case of poor substrate wetting, where only a very small portion of the substrate (the contaminated spot) is not properly wetted. Reducing the coating's surface tension may be a solution.

In general, liquid materials with low surface tensions are less sensitive to substrate and environmental contamination.

75.3.3.2 Elimination of Bénard Cells

The solvents evaporating from a wet film transport low viscosity medium of lower density from the underlying zone to the surface. The medium spreads, the solvents evaporate, and the system becomes more viscous. Sections of higher density sink back into the bulk of the liquid that is richer in solvent than the surface. Pigments are carried along and whirl about in these continuous eddies. As the system continues to dry and become more viscous, the movements gradually cease. The resulting visible structures, on horizontal surfaces, are called *Bénard cells*. On vertical surfaces, however, gravitational flow and deformation of these cells produce *silking*.

Silicone additives orient to the most hydrophobic surface (in this case, the air/liquid interface). They form a macro layer that immobilizes the surface of the liquid film. Accordingly, there are no zones of differential surface tensions and, consequently, no formation of Bénard cells or defects caused by air-draft sensitivity. (Once again, the previous description is considerably abbreviated and oversimplified for the purposes of this overview chapter.)

75.3.3.3 Slip Improvement

In addition to controlling surface tension, the orientation of methyl (or alkyl) groups of the silicone additive also influences the surface slip of a cured coating. Slip is measured by monitoring the force

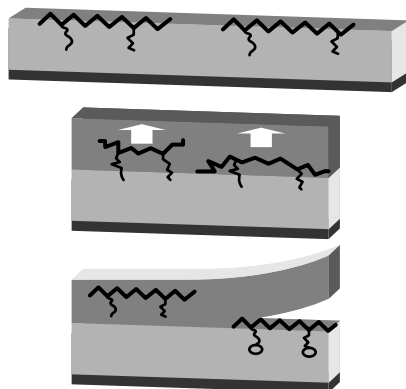

FIGURE 75.4 Mobility of silicones.

required to draw a defined mass across the coating's surface. Silicone additives generally reduce friction, i.e., they improve slip depending on their chemical structures and concentrations. Generally, the more dimethyl groups in the structure, the more slip is enhanced. Better slip may be the desired property, but oftentimes, slip is desirable for other reasons, because coatings with improved slip will simultaneously display better mar and scratch resistance, along with improved blocking resistance. An added benefit is nearly always improved resistance to soiling.

75.3.3.4 Mobility of Siloxanes/Intercoat Adhesion

Next, comparing reactive versus nonreactive modifications to the polydimethylsiloxane, cross-linking the siloxane via functional modifications, with resin binders, will inhibit recoat. This is shown at the bottom of Figure 75.4. At temperatures greater than 150°C/300°F, nonreactive polyether-modified siloxanes will decompose, forming reactive groups that function to preventing migration. Nonreactive silicones do not remain permanently at the surface of the first layer of cured paint; upon recoat, they migrate into the second coat and orient at its air interface. This migration of silicone from the first coat is what permits the second layer of paint to wet and adhere to the first coat. (This is shown in the upper two-thirds of Figure 75.4.) Through manipulation of the modifications to the basic polydimethylsiloxane molecule, intercoat adhesion can be controlled. Specially designed, thermally stable polysiloxanes have also been developed for recoatability in high-temperature (up to 220°C/430°F) baking systems.

75.3.3.5 Surface Tension Reduction for Substrate Wetting

Due to their surface activity, conventional silicones typically concentrate at the liquid/air interface. Characteristic of silicones is their ability to reduce surface tension.

In order for a formulation to wet a substrate, the liquid components of the formulation must have a lower composite surface tension than that of the substrate. In solvent-based systems, and some waterborne systems, this requirement can be met by the use of silicone additives of the structures previously discussed.

In waterborne systems, substrate wetting can be difficult, due to the high surface tension of water. Conventional silicone additives (as described above) often cannot correct wetting defects, as they do not sufficiently reduce the surface tension of the coating. The correct product to use for these situations are often "silicone surfactants." Such products are able to provide very low surface tension values in waterborne coatings, thereby avoiding wetting problems. They can often be used to replace fluoro surfactants. However, fluoro surfactants, in addition to reducing surface tension (and being more expensive), also exhibit a pronounced tendency to stabilize foam. It is important to note that silicone surfactants do not stabilize foam.

75.3.3.6 Controlled Incompatibility

The compatibility of any particular silicone with a binder solution depends on its chemical structures — the presence of modifying side chains and molecular weight. Highly incompatible silicones tend to cause surface defects (such as craters) and may actually be used to generate hammer-tone finish coatings.

Compatible silicones reduce surface tension and improve surface slip, as described above, without creating surface defects. Silicones that are just borderline between compatibility and incompatibility (“controlled incompatibility”) will typically function as defoamers.

Because compatibility also depends on the resins and solvents used in a formulation, there is not always a clear differentiation between silicone defoamers and other silicones; more information will be provided in Section 75.4.

75.3.4 Summary

It can be demonstrated that many defects are caused by differences in surface tension. The silicone molecule embodies a unique chemistry that can control the liquid/solid, liquid/liquid, and/or liquid/air interfaces. By understanding the proper application and use of these additives, formulations can be optimized.^{7-11,16}

75.4 Defoaming Additives

75.4.1 The Nature of Foam

Foam problems can arise from a variety of sources. Initially, foaming can occur in the production process, leading to nonoptimal fill and use of production vessels. Additionally, foaming can occur during handling or coatings application to cause defects. Of course, foam not only causes an optical disturbance but also compromises film formation and functional properties. With coating systems, protection may obviously be lost. With inks, coverage or appearance may be compromised; with adhesives, adhesion or cohesion may be reduced. Accordingly, a defoamer is an essential ingredient in nearly all systems.

In general, one can define foam as a fine dispersion of a gas (normally air) in liquid. All components of a formulation can exert an effect, positive or negative, on foam formation. The final system performance is partly contingent on the substrate and application method. It is well known, for example, that some formulations demonstrate no foam when roll coated but display copious foam when spray applied.

One definitive characteristic of foam is the existence of an extremely large interface between the gas and the liquid phase, which, in the form of a lamella, separates the gas bubbles from one another. All liquids, due to physical laws, attempt to maintain as small a surface area as possible. Therefore, the large surfaces present in foams are only possible because of the input of energy, and they can be maintained only by foam stabilization effects (which will be discussed later).

By carefully observing foam throughout its lifetime, it is possible to delineate the gradual changes in its structure. Shortly after formation, the foam has a relatively high liquid content; accordingly, this *wet foam* or *spherical foam* contains bubbles that have little or no influence on one another.

The liquid begins to drain, and the lamella becomes thinner as the bubbles are drawn closer together, gradually pressing against each other and forming polyhedral shapes. The resulting foam structures are called *dry foam* or *polyhedral foam*.

This drainage also destabilizes the foam, because it leads to thinner foam lamellae, which would simply rupture if there were no counteracting physical effects.

One such counteracting effect occurs because of *electrostatic repulsion*. In aqueous systems, the hydrophilic groups in the surfactant are of an ionic nature. The two interfaces of the lamella, which are covered with surfactants, come closer together because of the drainage effect. The equally charged ionic groups of the surfactant then repel each other, thus preventing any further drainage and rupture of the lamella.

A further stabilizing effect is provided by the *elasticity of the foam lamella*. If the lamella is stretched, eventually, at a certain length, a reduction in surfactant concentration at the interface can be observed, as seen in [Figure 75.5](#).

This is because the number of surfactant molecules in a given volume of liquid is finite and the enlarged surface area must therefore have a lower surfactant concentration. Therefore, surface tension increases, and the stretched film shrinks like an elastic skin. Since materials move from areas of low to high surface tension, liquid and surfactants from the unstretched regions of the lamella migrate to the stretched higher

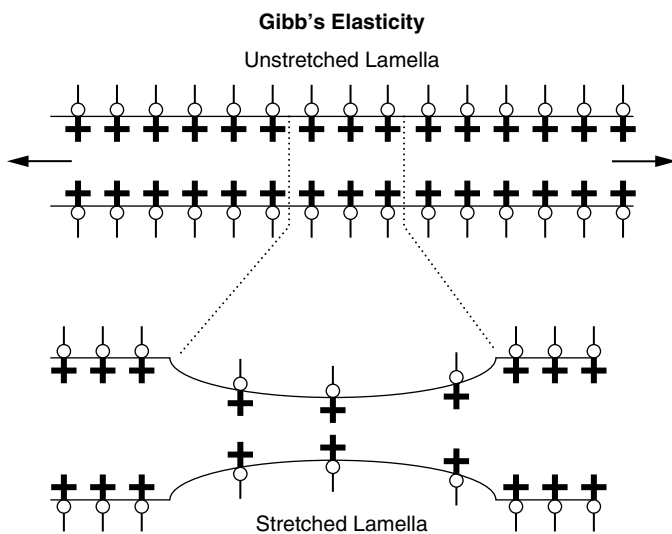

FIGURE 75.5 Decrease in surfactants in stretched lamella.

surface tension regions, thus restoring the surfactant concentration to a foam stabilizing level. The elasticity of thin liquid films is also known as *Gibbs elasticity*.

Although there are certain other effects that could theoretically affect foam stability, basically, liquids foam in the presence of surface-active chemicals that stabilize foam by electrostatic repulsion and Gibbs elasticity.

75.4.2 Defoamers versus Air Release Agents

Typically, the removal of either encapsulated or surface bubbles from a liquid paint or paint film is referred to as defoaming; however, distinctions among various types of foam and bubbles removal processes are sometimes made. To begin the defoaming process, the gas bubbles must somehow reach the surface. This process of bubbles reaching the surface is referred to as air release; the destruction of air bubbles on the surface represents actual defoaming. In practice, though, this strict differentiation is not always adhered to. It is not always possible to clearly define the working mechanism of a particular additive solely as either defoaming or air releasing. Consequently, our subsequent discussion will generally use the term “defoamer,” even in some isolated cases where the term “air release agent” might be more appropriate.

75.4.3 The Mechanisms of Defoaming and Air Release

Defoamers are low surface tension liquids that must demonstrate the following three properties: a controlled insolubility and/or incompatibility in the medium to be defoamed, a positive entering coefficient, and a positive spreading coefficient.

When the entering coefficient is positive, the defoamer can enter the foam lamella. Additionally, if the spreading coefficient is positive, then the defoamer can spread on the interface. Due to this spreading effect, foam stabilizing surfactants are displaced, and the previously elastic, disturbance-resistant lamella is replaced by one that is lower in cohesive forces. The defoaming mechanism of such defoaming liquids can be amplified (especially in aqueous systems) with the addition of finely dispersed hydrophobic particles. The liquid defoamer serves as a carrier medium to transport hydrophobic particles into the foam lamella. These hydrophobic particles act as “foreign” particulates with the lamella and destabilize foam by reducing the cohesive forces within the lamella. The surfaces of the hydrophobic particles also

adsorb or “capture” foam-stabilizing surfactant molecules to further destabilize the foam lamella. Eventually, the sufficiently weakened or destabilized lamella will collapse.

75.4.4 Defoamers for Aqueous Systems

The first group of important foam control additives is mineral oil based. A typical mineral oil defoamer consists of approximately 80% carrier oil and 15% hydrophobic particles. The remaining 5% is made up of emulsifiers and other agents. The carrier oils are normally aliphatic, because aromatic oils, in addition to yellowing, may be physiologically hazardous. The hydrophobic particles can be metal stearates, fatty acid derivatives, or hydrophobic silicas. Recent developments make use of aliphatic polyurea compounds that demonstrate added benefits for longer-term defoaming.

The second group of defoamers for aqueous systems is silicones. Due to their special capabilities, silicone additives are more costly than mineral oil defoamers and are, therefore, mostly used in premium or high-performance formulations. For the most part, emulsions or mixtures with strongly hydrophobic silicones are used.

Silicone defoamers can also be combined with hydrophobic particles (polyureas) to improve silicone oil dispersibility and defoaming characteristics. The primary advantage of silicone defoamers (as compared to mineral oil defoamers) is their increased effectiveness; they do not reduce gloss or alter color acceptance in pigment paint systems. The individual products vary not only according to the particular hydrophobic silicone oil used, but also according to mixture/emulsion type. Depending on which product is selected, differences in susceptibility to cratering and storage stability can be observed. However, in many cases, optimal incorporation of the defoamer — via higher shear forces — will result in completely crater-free coatings.

The third group of defoamers includes products that do not contain silicone or mineral oil. Products of this type may be used in some of the newer resin formulations (for example, waterborne, two-pack polyurethane systems).

75.4.5 Defoamers for Solvent-Based Systems

For systems containing organic solvents, the previously described mineral oil defoamers are not generally appropriate because the spreading capability of mineral oil products is insufficient. Defoaming compounds with lower surface tensions are required, and silicones (or, more properly, polysiloxanes) play a dominant role as defoamer-base substances.

In selecting a silicone, chemical structure is the decisive factor. For example, the relatively short-chain silicones (which quite often find numerous applications, as discussed previously) may demonstrate form-stabilizing rather than foam-destabilizing (defoaming) behavior. Whether a particular silicone functions as a foam stabilizer or as a defoamer depends on the product's compatibility and solubility in the liquid medium; only “selectively incompatible” and insoluble silicones function as defoamers. The controlling factor here is often the molecular weight or chain length of the silicone.

Lower molecular weight products function as foam stabilizers; higher molecular weight analogs, if sufficiently incompatible enough, will create craters; and finally, the highest molecular weight products are totally incompatible and are used to generate hammer-tone finishes. The selection of the proper defoamer can be characterized as a balancing act between compatibility and incompatibility.

The required balance and resulting “selective incompatibility” can be achieved through a variety of silicone chemistry techniques. By modifying the silicone backbone with various organic side chains, compatibility can be controlled.

Recent innovations include the offering of defoamers with perfluorinated organic modifications, the so-called fluorosilicone defoamers. These products distinguish themselves by their very low surface tensions and their strong defoaming behavior.

Another type of defoamer for solvent-borne systems includes special polymeric products (operating through “selective incompatibility”). In this case, in order to achieve the proper balance between com-

patibility and incompatibility, polymeric polarity along with molecular weight and distribution can be intentionally modified. These products often function as air release agents. In comparison to silicone defoamers, compatible polymeric products do not stabilize foam; their defoaming behavior is merely weak or even nonexistent.

75.4.6 Selection Criteria and Test Methods

Many test methods are available to determine the effectiveness of defoamers. A commonly used screening test is to incorporate air into the system (pure binder with defoamers) and to observe the rate of defoaming (how fast the bubbles disappear). However, this can only be used as an initial screen tool because other components in the formula — along with application methods — can influence foam generation and its stabilization. The substrate being coated also can affect or cause foam; especially if the substrate is highly porous. It is always good laboratory practice to test the total formulation under realistic application conditions on representative substrates using appropriate application methods and equipment.

Storage stability of the defoamer should additionally be evaluated to ensure there is no setting of the hydrophobic particles. The ease of defoamer incorporation is an additional test criterion.

75.4.7 Summary

Through the proper selection of tailored chemistries, foam problems can be overcome. Many products are available to control the liquid/air interface that is encountered in foam lamellae, but the formulator must find the proper balance in order to optimize the system.^{12–16}

75.5 Conclusion

As demonstrated in the cursory examination of additive technology, the control of various interfaces, whether they are liquid/solid, liquid/liquid, or liquid/air, is the key function of the additive categories discussed in this chapter. Any possible increase in raw material cost encountered in achieving this is more than offset by improved product performance, optimized quality control, and full customer satisfaction.

References

1. M. J. Rosen, *Surfactants and Interfacial Phenomena*. New York: John Wiley, 1978.
2. M. R. Hornby and R. D. Murley, "The measurement of pigment dispersion in paints and paint films," *Prog. Org. Coat.*, 3, 261–279 (1975).
3. R. F. Conley, "Design, functionality, and efficiency of pigment dispersant in water-based systems," *J. Paint Tech.*, 46, 594, 51 (1974).
4. H. J. W. Van den Haak, "Design of pigment dispersants: Methodology for selection of anchoring groups," *J. Coat. Technol.*, 69(873), 137–142 (1997).
5. S. Chibowski, "Effect of functional groups of polyacrylamide and polyacrylic acid on the adsorption onto TiO₂ surface," *J. Colloid Interface Sci.*, 140, 444 (1990).
6. J. F. Tassin, R. L. Siemens, W. T. Tang, G. Hadziioannou, J. D. Swalen, and B. A. Smith, "Kinetics of adsorption of block copolymers revealed by surface plasmons," *J. Phys. Chem.*, 93, 2106 (1989).
7. Z. W. Wicks, Jr., F. N. Jones, and S. P. Pappas, "Mechanical properties," in *Organic Performance*. New York: John Wiley, 1994, Chap. 24, pp. 105–131.
8. R. M. Evans, "Ultimate tensile properties," in *Treaties on Coatings*, Vol. 2, Part 1. R. R. Meyers and J. S. Long, Eds. New York: Marcel Dekker, 1975.
9. A. L. Andrady, M. A. Llorente, M. A. Sharef, R. R. Rahalkar, J. E. Mark, J. L. Sullivan, C. U. Yu, and J. R. Falender, "Model networks of end-linked polydimethylsiloxane chains. XII. Dependence of ultimate properties of dangling-chain irregularities," *J. Appl. Polym. Sci.*, 26, 1829–1836 (1981).

10. W. Heilin and S. Stuck, "Polysiloxane zur Erhöhung der Kratzfestigkeit von Beschichtungsflächen," *Farbe und Lack*, 101, 376 (1995).
11. L. H. Brown, "Silicone additives," in *Handbook of Coatings Additives*. L. J. Calbo, Ed. New York: Marcel Dekker, 1987.
12. S. Paul, "Methods used to reduce foaming," in *Surface Coatings*, 2nd ed. Chichester: John Wiley, 1985, pp. 622–625.
13. J. W. Simmons, R. M. Thorton, and R. J. Wachala, "Defoamers and antifoams," in *Handbook of Coatings Additives*. L. J. Calbo, Ed. New York: Marcel Dekker, 1987.
14. M. S. Gebhard and L. E. Scriven, "Formulation and dissipation of air bubbles in spray-applied coatings," in *Proceedings of the Twenty-first Waterborne, Higher Solids, and Powder Coatings Symposium*. R. F. Thames, Ed. University of Southern Mississippi, 1994.
15. H. Van Megan, "Defoamers in organic solvent and waterborne paint systems," *Färg Och Lack Scandinavia*, 142–146 (1989).
16. E. Orr and G. Mallalieu, in *Coatings Technology Handbook II*, Chap. 71. D. Satas and A. Tracton, Eds. New York: Marcel Dekker, 2000, pp. 595–608.

76

Pigment Dispersion

76.1	Introduction	76-1
76.2	A Brief Introduction to Pigments.....	76-2
	Pigment Definition • Pigment Particles	
76.3	The Dispersion Process.....	76-4
	Pigment Wetting • Particle Deaggregation and Deagglomeration • Dispersion Stabilization	
76.4	The Role of Surface Energy.....	76-6
	Surface Energy and Surface Area • Surface Energy and Pigment Wetting • Surface Energy and Destabilization of the Dispersion • Surface Energy and the Acid–Base Concept	
76.5	Mechanisms for the Stabilization of Dispersion.....	76-8
	Charge Stabilization • Steric or Entropic Stabilization	
76.6	Surface Treatment	76-9
	Surfactants • Polymeric Dispersants • Surface Modifying Agents	
76.7	Surface Treatment during Pigment Manufacture.....	76-10
76.8	Surface Treatment of Pigments: Application	76-11
	Organic Pigments • Inorganic Pigments	
76.9	The Characterization and Assessment of Dispersion.....	76-17
76.10	Conclusion.....	76-17
	References.....	76-18

Theodore G. Vernardakis

BCM Inks USA, Inc.

76.1 Introduction

The dispersion of pigments in fluid media is of great technological importance to the coatings manufacturers who deal with pigmented systems. The basic aim is to change the physical state of pigments to achieve desired effects in specific application systems. The dispersion process involves the breaking down and separation of the aggregated and agglomerated particles that are present in all pigments in their normal form after their manufacture. Dispersion is not considered to be a process of pulverization but rather a process of particle separation, homogeneous distribution of the particles in a medium, and stabilization of the resultant system to prevent reaggregation, reagglomeration, flocculation, and settling. The process of dispersion must be done efficiently and in the shortest time possible to draw out of the pigment its maximum color properties at the least cost.

The topic of pigment dispersion in fluid media has been covered extensively in the literature.¹⁻⁶ Theoretical aspects of pigment dispersion apply equally well to inorganic and organic pigments. In this chapter, the practical examples of surface treatments apply primarily to organic pigments, but similar treatments can be carried out on inorganic pigments as well.

76.2 A Brief Introduction to Pigments

76.2.1 Pigment Definition

Materials are colored by the use of pigments or dyes. Pigments are colored, black, white, or fluorescent particulate organic or inorganic solids; usually they are insoluble in, and essentially physically and chemically unaffected by, the vehicle or substrate in which they are incorporated. They alter appearance by selective adsorption and/or by scattering of light.⁷

Pigments usually are dispersed in vehicles or substrates for application (e.g., in inks, paints, plastics, or other polymeric material). Pigments retain a crystal or particulate structure throughout the coloration process.

As a result of the physical and chemical characteristics of pigments, pigments and dyes differ in their application: when a dye is applied, it penetrates the substrate in soluble form, after which it may or may not become insoluble. When a pigment is used to color or opacify a substrate, the finely divided, insoluble solid remains throughout the coloration process.

Organic pigments are highly colored, inert synthetic compounds that are usually brighter, purer, and richer in color than inorganic pigments. Generally, however, they are less resistant to sunlight (some fade badly on exposure to light), to chemicals (greater tendency to bleed in solvents), and to high processing temperatures (lower heat stability); quite often too, they are more expensive than inorganic pigments. Pigments are classified by the Colour Index according to specific pigment name and constitution number. For example, phthalocyanine blue is known by the C.I. name Pigment Blue 15, and its C.I. number is 74160, while titanium dioxide is C.I. Pigment White 6, C.I. 77891. The great number and variety of organic and inorganic pigments make it impossible to treat them all in this chapter. References should be consulted for information on pigment types, chemical and physical properties, methods of preparation, grades, specifications, and applications. See, for example, [References 8–11](#).

76.2.2 Pigment Particles

Pigments are normally produced in a wet presscake form, which upon drying and grinding or spray drying assumes the form of a fine dry powder. Presscakes, either at their normal pigment content (20 to 40%) or as “high solids” (50 to 60%), are used by the manufacturers of aqueous pigment dispersions for paint, textile, and ink applications, as well as by those who produce flushed colors for oil ink or coatings applications. Dry pigment powders are used in a host of other systems such as solvent inks, coatings, and plastics. Pigments in the presscake or dry powder form are composed of fine particles, normally in the submicrometer size range. Their color properties are generally influenced by particle size and particle size distribution; therefore, an assessment on the degree of dispersion must, above all, be considered in terms of these critical measurements.¹² In general, color properties, such as strength, transparency, gloss, rheology, and lightfastness of all pigmented systems, are affected to a greater or lesser extent by the size and distribution of the pigment particles in the dispersion. For example, phthalocyanine blue is first prepared commercially in a “crude” pigment form having a large particle size, up to 25 μm . As such, it has little color value and must therefore be reduced to smaller, finer particles to enhance its coloristic properties. After particle size reduction (down to 0.03 to 0.15 μm), an excellent pigment is obtained, which exhibits a high degree of tinctorial strength, transparency, and gloss. Typical electron micrographs of these two materials, showing particle size, are reproduced in [Figure 76.1](#).

Pigment particles normally exist in the form of primary particles, aggregates, agglomerates, and flocculates. Primary particles are individual crystals and associated crystals as they are formed during the manufacturing process ([Figure 76.2](#)). They may vary in size depending on the conditions of precipitation and growth, which are controlled by the pigment manufacturer. The scanning electron photomicrograph of [Figure 76.2](#) for micronized sodium chloride (although this is not a pigment) is used only to illustrate the individual and associated crystals that make up the primary particles of a compound.

Aggregates are collections of primary particles that are attached to each other at their surfaces or crystal faces and show a tightly packed structure. Agglomerates consist of primary particles and aggregates joined

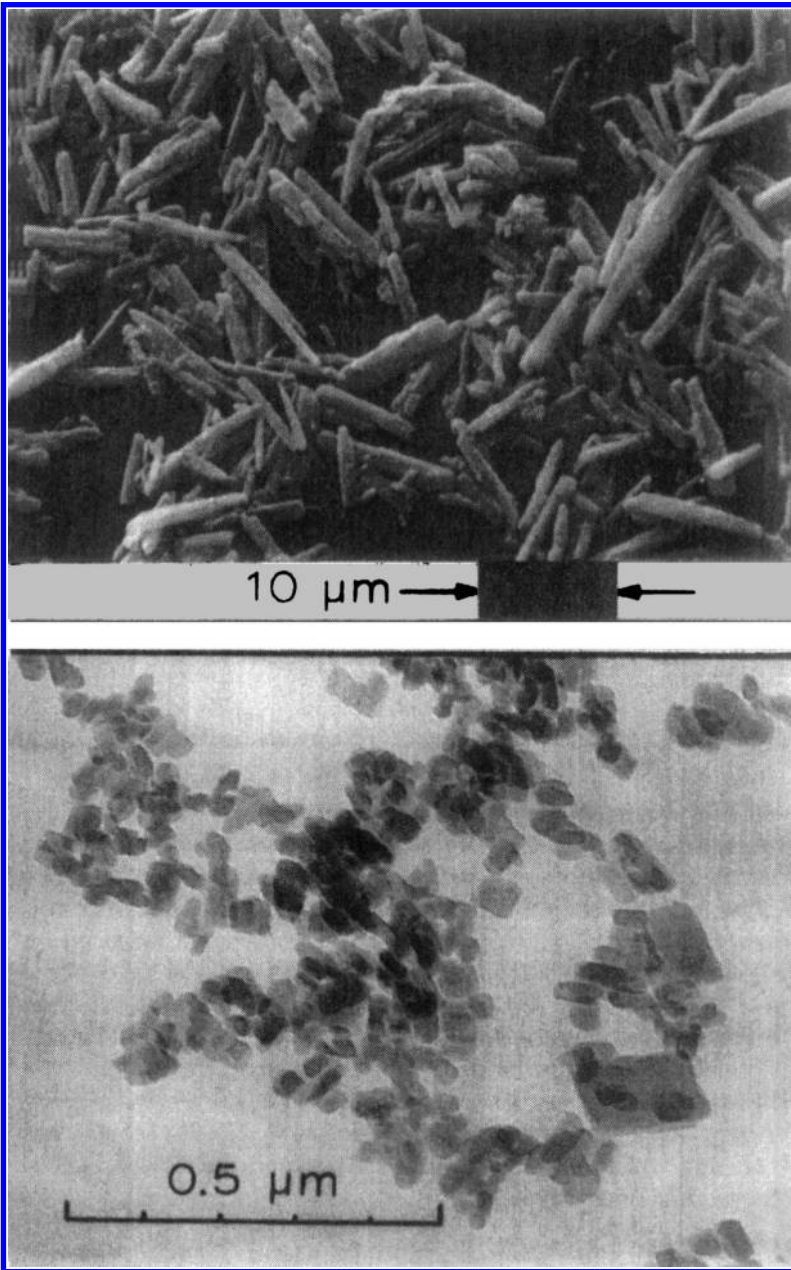

FIGURE 76.1 Scanning electron photomicrograph of copper phthalocyanine blue crude (top) and transmission electron photomicrograph of copper phthalocyanine blue pigment (bottom) showing particle size differences; Pigment Blue 15.

at the corners and edges in a looser type of arrangement. Aggregates are formed during the manufacturing process in the course of the ripening period of the precipitates. Agglomerates, most often, are formed during the drying of the presscakes and the subsequent dry milling of the pigment lumps. [Figure 76.3](#) shows typical arrangements of aggregated and agglomerated pigment particles.

Flocculates consist of primary particles, aggregates, and agglomerates, generally arranged in a fairly open structure, as shown in [Figure 76.4](#). Flocculates may be broken down easily under shear, but they will form again when such shear forces are removed and the dispersion is allowed to stand undisturbed.

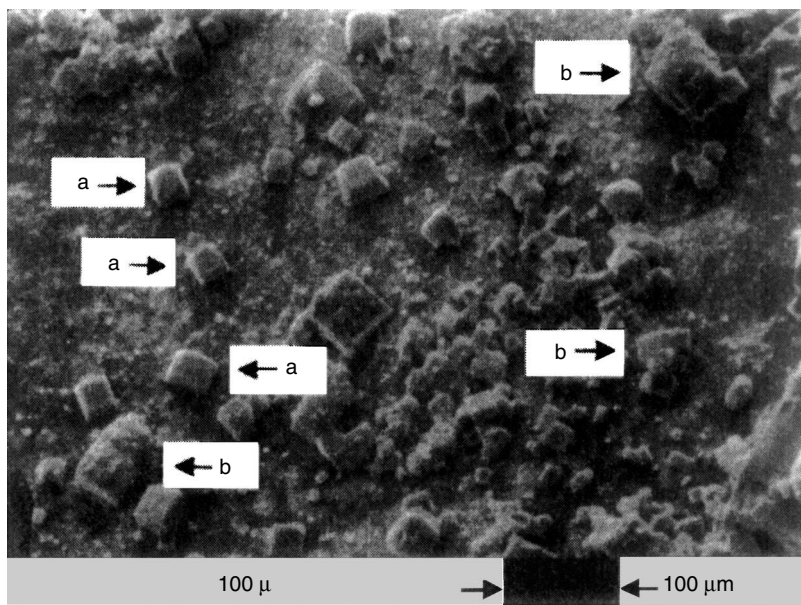

FIGURE 76.2 Scanning electron photomicrograph showing primary particles: (a) individual crystals and (b) associated crystals of micronized NaCl.

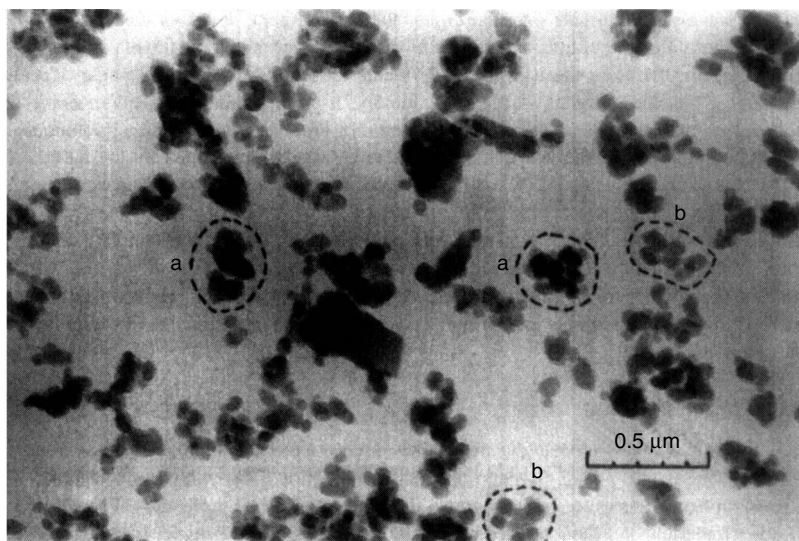

FIGURE 76.3 Transmission electron photomicrograph showing (a) aggregated and (b) agglomerated pigment particles. D&C Red No. 30, Vat Red 1.

76.3 The Dispersion Process

The primary purpose of dispersion is to break down pigment aggregates and agglomerates to their optimum pigmentary particulate size (down to individual single particles, if possible) and to distribute these pigment particles evenly throughout a medium (i.e., the carrier). Usually the carrier is a liquid or a solid polymeric material that is deformable at high temperatures during processing. To achieve the optimum benefits of a pigment, both visual and economic, it is necessary to obtain as full a reduction as possible to the primary particle size. After all, the color strength of a pigment depends on its exposed

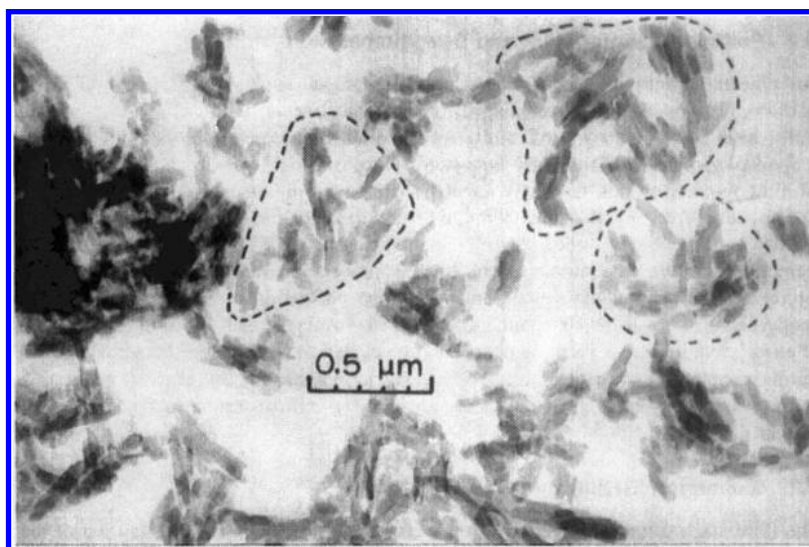

FIGURE 76.4 Transmission electron photomicrograph showing flocculated pigment particles. Dimethylquinacridone magenta, Pigment Red 122.

surface area: the smaller the particle size, the higher the surface area, and thus the stronger the color. Furthermore, the pigment is generally the most expensive constituent of any pigmented system; therefore, the user normally wants to obtain optimum performance with the smallest possible amount of pigment. Ideally, a good pigment dispersion consists chiefly of primary particles, with only a minimum of loose aggregates and agglomerates. In practice, reduction to the primary particle size is largely determined by the nature of the pigment (i.e., its dispersibility), by the dispersion system and processing equipment, and by the end-use requirements of the product.

Dispersion should not be confused with pulverization. The latter is simply a comminution process whereby large pigment lumps are broken down to smaller units, which constitute the powder form. Pulverization does not break down the aggregated, agglomerated, and flocculated particles into primary particles. Dispersion, however, accomplishes this effectively.

76.3.1 Pigment Wetting

It is generally recognized that the dispersion process consists of three distinct stages: wetting, deaggregation–deagglomeration, and stabilization. The wetting stage involves the removal from the surface of the pigment particles of adsorbed molecules of gas, liquid, and other materials and their replacement with molecules of the vehicle. In other words, the pigment–air interface in dry pigment powders or the pigment–water interface in presscakes is replaced by the pigment–vehicle interface. This is accomplished through preferential adsorption. The efficiency of wetting depends primarily on the comparative surface tension properties of the pigment and the vehicle, as well as the viscosity of the resultant mix.

76.3.2 Particle Deaggregation and Deagglomeration

After the initial wetting stage, it is necessary to deaggregate and deagglomerate the pigment particles. This is usually accomplished by mechanical action with devices such as ball mills, bead mills, and two-roll mills. As the pigment powder is broken down to the individual particles, higher surface areas become exposed to the vehicle and larger amounts of it are required to wet out newly formed surfaces. During this stage of deaggregation, the amount of free vehicle in the bulk diminishes; therefore, the viscosity of the dispersion increases. At higher viscosities, shear forces are greater and the breaking down and separation of particles become more efficient. It is this process of mechanical breakdown of the aggregates and agglomerates that demands a high energy input and can become quite costly. Some easily dispersible

pigments have been developed to aid in the reduction of energy requirements. Such pigments are produced by surface treatment of the pigment during manufacture, with the purpose of reducing or inhibiting agglomeration–aggregation formation. In many cases, such treatments are highly specific to a single ink, paint, coating, or plastic medium.

76.3.3 Dispersion Stabilization

The third stage of great importance in the dispersion process is the stabilization of the pigment dispersion. This ensures that complete wetting and separation of the particles has been reached, and also that the pigment particles are homogeneously distributed in the medium. If the dispersion has not been stabilized, flocculation may occur as a result of clumping together of the pigment particles. Flocculation is generally a reversible process. Flocculates typically break down when shear is applied and will form again when the shear is removed. Where a pigment dispersion is not stabilized by the action of resin molecules in the vehicle, the use of surfactants or polymeric dispersants can be considered. Such additives may be used directly during pigment manufacture, or they may be incorporated in the vehicle.

76.4 The Role of Surface Energy

It is well known that molecular forces at the surface of a liquid are in a state of imbalance. The same is true of the surface of a solid, where the molecules or ions on the surface are subject to unbalanced forces of attraction normal to the surface plane. Such atoms do not have all their forces satisfied by union with other atoms. As a result, there is a net force, which tends to pull the surface molecules into the bulk. The opposing force, which resists this inwardly pulling force, is known as the surface tension or surface energy. All liquids and solids have surface energies to a greater or lesser degree. To satisfy these surface forces, liquids and solids tend to attract and retain on their surfaces dissolved substances in the solution or gasses from the surrounding atmosphere. These forces are short-ranged attractive forces, known as van der Waals or London forces, and they play a very important role in particle aggregation, wetting, and dispersion stabilization.

76.4.1 Surface Energy and Surface Area

Pigments having a very small particle size exhibit high surface area and, consequently, high surface energies. As large pigment particles are broken down into several smaller particles, new surfaces are constantly created, contributing to a higher surface area and thus a higher surface energy.

Let us assume that a pigment powder has a surface area S of 60 m²/g and a density ρ of 1.0 g/cm³. Its basic particle diameter D from

$$D = \frac{6}{\rho S}$$

will be 0.1 μm . If these particles are cubic in structure, and if, for the sake of simplicity, we assume that a 1 cm³ of pigment is broken down into particles 0.1 μm in size, then 1×10^{15} particles will be produced. We assume also that the particles are in perfect cubic packing. To get an idea of the area created by the new surface, we need only compare the surface area of 6 cm² for the 1 cm cubic particle to the surface area of 600,000 cm² (60 m²) for the 1×10^{15} cubic particles that are 0.1 μm in size. The increase in surface area is 100,000-fold. The new surfaces produced are tremendously large. The surface energies associated with these new surfaces are also quite large. These van der Waals surface energies create the attraction between the submicrometer particles that come together to form the aggregates and agglomerates.

76.4.2 Surface Energy and Pigment Wetting

Surface energies play an important role in the wetting and stabilization of pigment dispersions. For wetting to be effective, the wetting energies of the pigment–vehicle interface must be greater than the

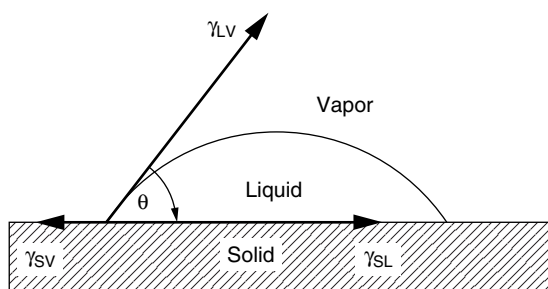

FIGURE 76.5 Partial wetting of a solid surface by a liquid in accordance with the Young-Dupré equation.

sum of the adsorption energy (this is because of substances absorbed on the pigment surface) and the attractive energy that holds the pigment particles together. Generally, lower energy (low surface tension) liquids, such as aliphatic and aromatic hydrocarbons, will spread over, or wet, higher energy surfaces. Quite often, it happens that a liquid does not spread over a pigment surface completely. This occurs when a high-energy liquid (high surface tension), such as water, will not entirely wet out a high-energy surface. In this case, the wetting energy is equal to or less than the sum of the adsorption and interparticle attraction energies, and wetting may be either partial or nonexistent. The liquid will not spread entirely over the surface, as shown in Figure 76.5. The relationship that describes such a system is given by the Young-Dupré equation as

$$\gamma_{sv} = \gamma_{sl} + \gamma_{lv} \cos \theta$$

where γ_{sv} , γ_{sl} , and γ_{lv} are the interfacial energies at the solid–vapor, solid–liquid, and liquid–vapor interfaces, respectively, and θ is the contact angle. For complete wetting, the contact angle is zero ($\cos \theta$ becomes unity), and the liquid spreads entirely over the solid surface. For $\theta > 0$, wetting either is incomplete or does not occur.

76.4.3 Surface Energy and Destabilization of the Dispersion

Surface energies play an important role in the destabilization of the dispersion. Particles dispersed in liquid media are in constant motion (thermal or Brownian movement). As they move through the medium, they collide with other pigment particles. The frequency of these collisions depends on the size of the particles and on the viscosity of the medium. During such collisions, the particles will attract and may join with other particles because of the powerful short-range London–van der Waals attractive forces, which, in effect, are surface energies. These forces are electrical and are due to the interaction of the dipoles that are present in the particles, as permanent dipoles (polar particles) or induced dipoles (nonpolar but polarized particles).

Once the particles have come together, they may reaggregate or form flocculates if their surface is not protected, and they will settle to the bottom of the container. This is an undesirable effect for the ink, paint, or coatings manufacturer. Therefore, to prevent reaggregation or flocculation, such dispersions must be stabilized.

76.4.4 Surface Energy and the Acid–Base Concept

The idea of surface energy in pigments has been closely related to the acid–base concept, advanced by Sorensen,¹³ who has used it to describe the interaction between pigments, binders, and solvents, to obtain optimally stable pigment dispersions having the best application properties in fluid ink systems. Such interrelation between the surface energies of these three components in a dispersion can be characterized by their acid–base properties. Pigments can be classified as acidic (electron acceptors), basic (electron donors), amphoteric (electron acceptors and donors), or neutral. Binders and solvents can be similarly characterized.

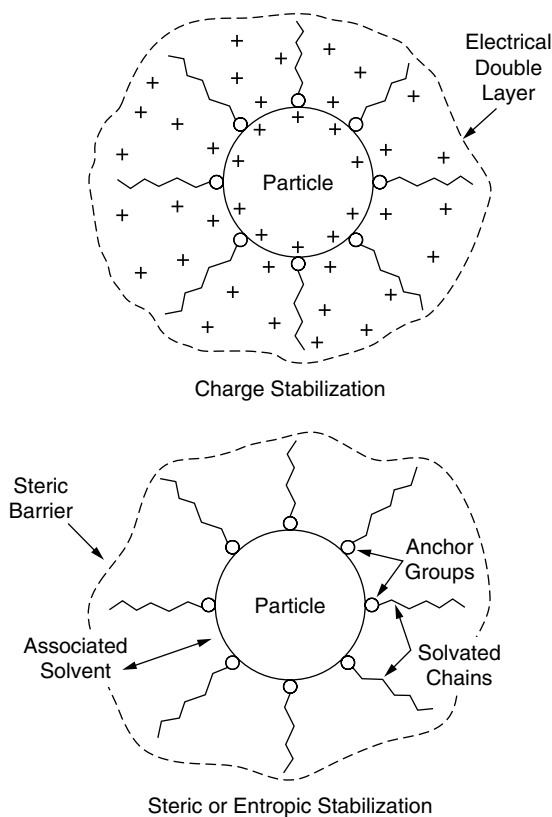

FIGURE 76.6 Charge and steric or entropic stabilizations.

Acidic pigments should be used with basic resins (polyamide, melamine, alkyd), while basic pigments should be used with acidic resins (vinyl, acrylic, maleic). Amphoteric pigments can be used with both resins. Neutral pigments should be surface treated to improve their dispersion characteristics. The solvent must have the same acid–base character as the pigment, whereby the interaction between the solvent and the pigment surface is minimized and at the same time the interaction between the resin binder and the pigment surface is maximized. In other words, there should be no competition between solvent and binder for the pigment surface; to obtain maximum dispersion and stability, only the binder should adsorb.

76.5 Mechanisms for the Stabilization of Dispersion

76.5.1 Charge Stabilization

Dispersions may become stable through two generally accepted mechanisms: charge stabilization and steric or entropic stabilization. Charge stabilization is due to electrical repulsion forces, which are the result of a charged electrical double layer surrounding the particles as shown in Figure 76.6. The charged electrical double layer developed around the particles extends well into the liquid medium, and since all the particles are surrounded by the same charge (positive or negative), they repel each other when they come into close proximity.

76.5.2 Steric or Entropic Stabilization

Steric stabilization is due to steric hindrance resulting from the adsorbed dispersing agent, the chains of which become solvated in the liquid medium, thus creating an effective steric barrier that prevents the

other particles from approaching too close. This phenomenon is also called entropic stabilization, because as the coated particles approach each other, the solvated chains of the adsorbed dispersant lose some of their degrees of freedom, resulting in a decrease in entropy. Such lowering in entropy gives rise to repulsive forces, which keep the particles away from each other. This type of steric or entropic stabilization is also represented in [Figure 76.6](#).

76.6 Surface Treatment

76.6.1 Surfactants

Surface active agents or, simply, surfactants are substances that are used to lower the interfacial tension between a liquid and a solid. Such is the case for pigments in fluid media, with the expressed purpose of improving pigment dispersibility by improving pigment wetting characteristics, preventing reaggregation, and increasing the stability of the dispersion. A surfactant molecule typically contains two groups of opposite polarity and solubility. The hydrophilic group is the polar, water-loving part, while the lipophilic group is the nonpolar, oil loving part of the molecule.

Surfactants are characterized by their HLB value (hydrophile–lipophile balance), which is a ratio of the hydrophilic to lipophilic groups on the molecule and gives an indication of their solubility in water or oil-solvent systems. High HLB values mean that the surfactant is soluble in water (an abundance of hydrophilic groups). Low HLB values, on the other hand, mean that the surfactant is soluble in oil or solvents (an abundance of lipophilic groups).

Surfactants attach themselves to the pigment particles via preferential adsorption, as shown in [Figure 76.7](#) for aqueous and nonaqueous systems. In aqueous systems, the lipophilic (or hydrophobic) groups are adsorbed on the particle surface, and the hydrophilic (or lipophobic) groups extend into the bulk of the aqueous phase to form an effective, protective barrier around the particle. In the case of nonaqueous solvent systems, the hydrophilic groups of the surfactant are attached to the particle surface, and the lipophilic groups (tails) extend into and are solubilized by the solvent.

Surface treatments are effective for pigments because their surfaces contain polar or polarized functional groups, which can serve as adsorption sites for the hydrophilic or lipophilic groups of the surfactants. For instance, organic pigments typically contain groups such as nitro ($-\text{NO}_2$), hydroxyl ($-\text{OH}$), carbonyl ($-\text{C}^{**}=\text{O}$), amide ($-\text{NH}-\text{C}^{**}=\text{O}$), methoxy ($-\text{O}-\text{CH}_3$), chlorine ($-\text{Cl}$), bromine ($-\text{Br}$), sulfonate ($-\text{SO}_3^-$), carboxylate ($-\text{COO}^-$), and metal ions such as Ba^{+2} , Ca^{+2} , Mn^{+2} , and Cu^{+2} , which can function as the anchoring sites for the hydrophilic or lipophilic groups of the surfactants.

It is well known, however, that classical surfactants do not always improve the dispersion characteristics of pigments especially when pigment surfaces are low in polarity or nonpolar and are dispersed in nonpolar vehicles. With such pigments and vehicles, dispersants and surface modifying agents of other types must be used to improve wetting and dispersibility and to prevent flocculation of pigment particles.

76.6.2 Polymeric Dispersants

Polymeric dispersants or “hyperdispersants”¹⁴ are claimed to be more effective dispersion stabilizers for nonaqueous systems. These substances have a two-part structure, one consisting of an anchoring functioning group (or groups) and the other consisting of a polymeric solvatable chain to which the functional group is attached. They are, in effect, polymeric surfactants or dispersants but were developed for use in specific nonaqueous systems, where classical surfactants have limitations. When they are used as dispersants for organic pigments, it is preferable that they have multiple anchoring groups on one polymeric chain, because organic particles are not as strongly polar as inorganic particles. Such dispersants may be of a fatty polyester type, containing a carboxy group at the end [e.g., poly(12-hydroxystearic acid)] with the carboxy group functioning as the anchor and the polyester group as the solvated chain. Others with multiple anchor groups are fatty polyureas and polyurethanes, which may even contain polymeric solvatable groups instead of the long fatty chains.

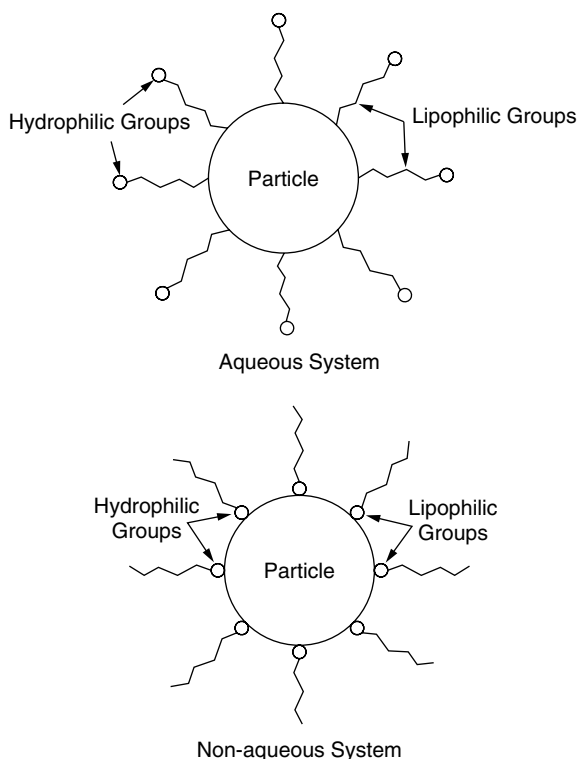

FIGURE 76.7 Surfactant attachment on pigment particles in aqueous and nonaqueous dispersions.

76.6.3 Surface Modifying Agents

Surface modifying agents are another group of additives that can be used to aid the dispersion of organic pigments in organic media. These agents are often pigment derivatives (e.g., large flat dye molecules), which provide improved resistance to flocculation and greater stability to the dispersion. The pigment derivative is adsorbed onto the pigment surface via the van der Waals attractive forces, which act over a large area, because such large planar dye molecules lie flat on the pigment surface. They may be used either alone or in conjunction with a polymeric dispersant. When used alone, they introduce or increase on the surface of nonpolar or low polarity pigments, the number of polar sites, which are necessary to interact with the resin in the vehicles, to stabilize the dispersion. When used together with the polymeric dispersant, they provide anchoring sites on which the anchor groups of the dispersant will become attached. In this context, they can be used synergistically with dispersing agents, at which time they are called colored synergists.

76.7 Surface Treatment during Pigment Manufacture

Generally, surface-treated pigments are more easily dispersible, produce more stable dispersions in fluid media with improved flow, and impart higher strength and gloss to the printed films, when compared with untreated pigments. Surface treatments can be carried out at different stages of pigment manufacture. Some pigments are prepared directly as finished products, while others are in the form of a crude pigment that must be conditioned into the pigmentary state.

Use of surfactants is typically made at the initial stage of pigment manufacture. During the precipitation of the intermediate (e.g., diazo in the preparation of azo pigments), surfactants are used to wet out and control the fineness of the precipitate, and they may also act as promoters to accelerate the azo coupling reaction. At the second stage, during the precipitation of the pigment (e.g., in the azo coupling reaction),

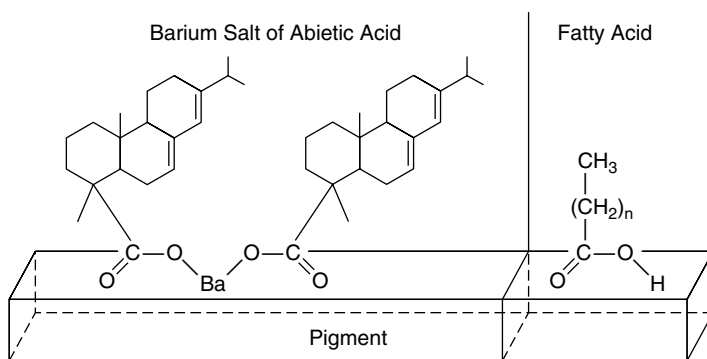

FIGURE 76.8 Treatment of pigment surfaces with rosins and fatty acids.

surfactants may be used in the dispersion of the pigment particles as they are being formed — for example, in azo yellows, which are precipitated in the pigmentary state, or in the dispersion of the precursor (dyestuff), as in the case of metallized azo reds (which are first formed as sodium salts), to control the salt formation (barium, calcium, etc.), and thus produce the final pigment. At the third stage, during the conditioning of the pigment, surface treatments are used for pigment particle dispersion, for coating the pigment surface to prevent aggregation, and for controlling the growth of crystal particles. If particles are too difficult to filter, use of a specific additive (flocculant) sometimes induces controlled flocculation and facilitates filtration. Complex formation with additives may also be carried out during this conditioning stage to stabilize the particles and increase dispersibility, as is the case with diarylide yellows, which may be surface treated with fatty amines to produce Schiff base stabilization and result in easily dispersible pigments.

76.8 Surface Treatment of Pigments: Application

76.8.1 Organic Pigments

The published literature dealing with surface treatments of organic pigments, patented or otherwise, is so extensive that no attempt is made to review it, although it may be referred to occasionally. Readers are urged however, to consult the review by Hayes,¹⁵ which covers the role of classical surfactants, polymeric dispersants, and pigment derivatives in surface treatments. Other reviews of interest are those by Topham,¹⁶ Merkle and Schafer,¹⁷ and Hampton and McMillan,¹⁴ the latter dealing specifically with polymeric dispersants. Further examples will be presented here.

It is well known to the pigment manufacturer that rosination is perhaps the oldest surface treatment known, especially for azo pigments, where rosin (abietic acid) is precipitated onto the pigment surface as the barium or calcium salt. It can also be used to treat other pigments, such as copper phthalocyanine blue,¹⁸ and for a host of similar applications, in a polymerized form. Along the same lines, long-chain carboxylic acids (fatty acids) have also been used to treat pigment surfaces.¹⁹ A likely arrangement of these molecules adsorbed on the surface is shown in Figure 76.8. The hydrophilic anchor groups are attached to the surface, with the lipophilic groups projecting outward. The use of rosin has been mentioned because of its historical significance and because it is still widely used today, as it is one of the least expensive surface treating agents.

In the course of a study by the author for the development of a diarylide yellow AAOT (Colour Index Pigment Yellow 14) for flexographic ink applications, it was found that a desirable product was one prepared in the presence of an amine type ethoxylated guanidine weakly cationic surfactant, in combination with a polar tetramethyl decynediol solvent.²⁰ It appears that these two surface active agents worked synergistically to produce a strong, transparent and nonflocculating pigment, as opposed to products in which the surfactant or the solvent or both were absent from the preparation. Transmission electron micrographs and particle size distributions for such pigments are shown in Figure 76.9 and Figure 76.10.

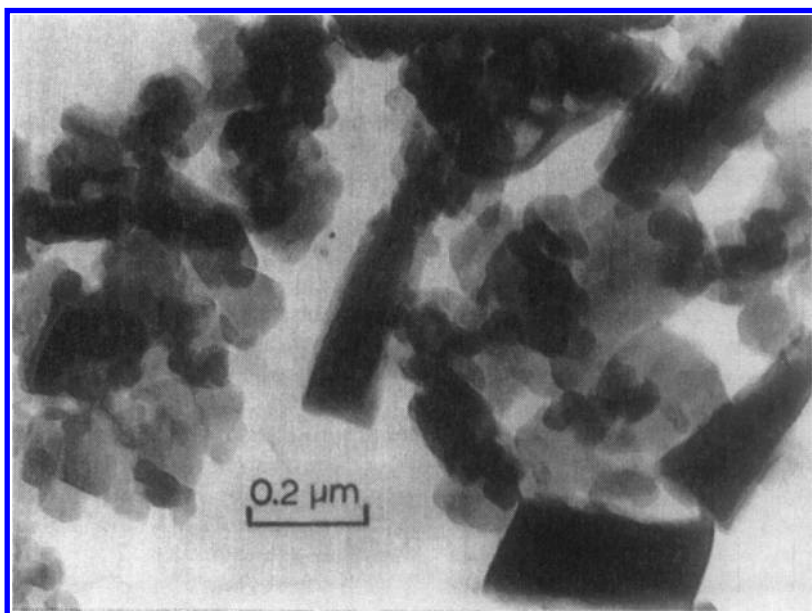
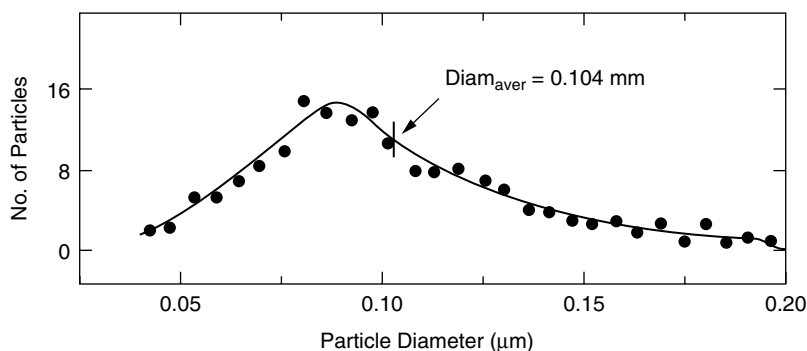

FIGURE 76.9 Transmission electron photomicrograph and particle size distribution of an untreated diarylide yellow AAOT, Pigment Yellow 14.

It is apparent that the particle size of the treated sample is smaller (average particle diameter = 0.073 μm) and much more uniform (narrow distribution) than that of the untreated sample (average particle diameter = 0.104 μm and wider distribution). To show pigment flocculation in flexographic inks, optical photomicrographs were obtained. [Figure 76.11](#), a micrograph of the liquid ink on a glass slide with cover for the untreated pigment, exhibits flocculation. [Figure 76.12](#), on the other hand, represents the liquid ink prepared with the surface-treated pigment and shows that this is a nonflocculating pigment.

Polymeric dispersants²¹ such as poly(12-hydroxystearic acid) are reportedly used both as free acid and as a salt with a variety of organic toners; these agents show more effectiveness when reacted with a primary amine (3-dimethylaminopropylamine, 3-octadecylaminopropylamine, etc.). The latter types can be used with pigment derivatives to produce a synergistic effect on the pigment surface for improved dispersion. An example is copper phthalocyanine sulfonic acid.²² The mechanism of synergism is illustrated in [Figure 76.13](#) for the surface treatment of copper phthalocyanine blue. A great number of other phthalocyanine derivatives have also been prepared and used as pigment stabilizers for phthalocyanine blue.²³

Phthalocyanine pigments may be conditioned from the crude state to the pigmentary form, for example, by milling the “crude” with a phthalocyanine derivative²⁴ such as a sulfonated phthalimidom-

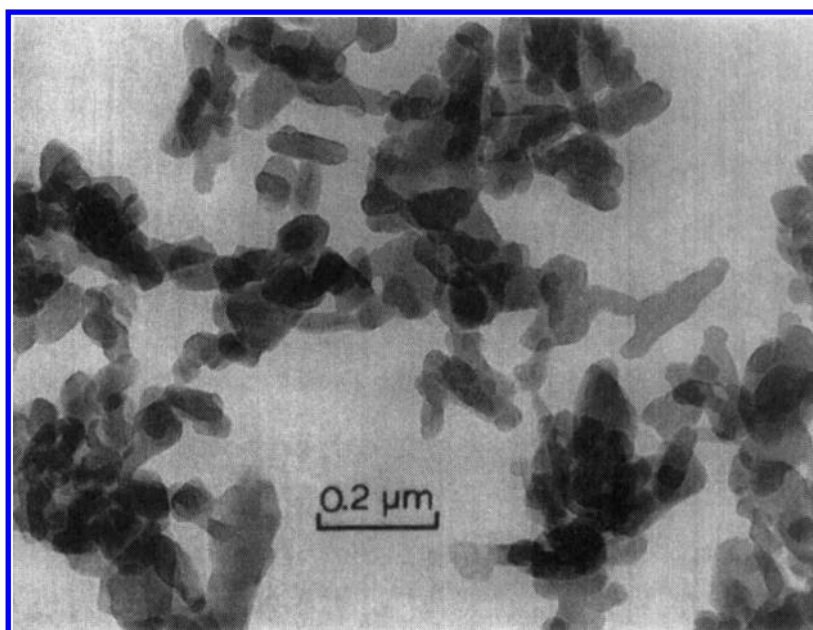
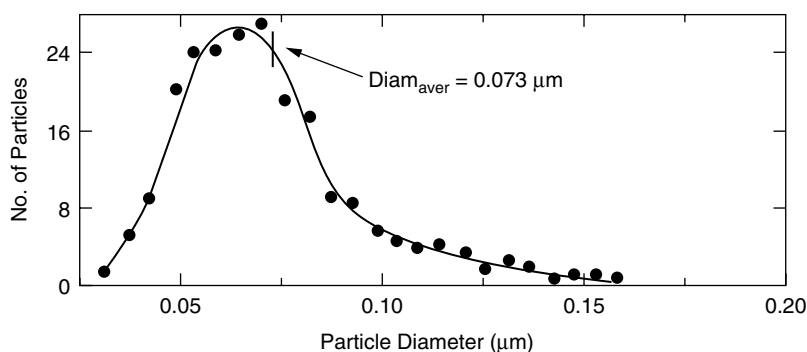

FIGURE 76.10 Transmission electron photomicrograph and particle size distribution of a surface-treated diarylide yellow AAOT, Pigment Yellow 14.

ethyl phthalocyanine²⁵ in the absence of any milling or grinding aid.²⁶ These large planar molecules appear to lie flat on the copper phthalocyanine surface, as shown in Figure 76.14, and they impart stability to the dispersions when used in printing inks, paints, and coatings, without any additional conditioning of the milled product.

Pigment derivatives are by no means limited to phthalocyanines. Quinacridone pigments have been surface treated with sulfonated quinacridone derivatives²⁷ either as the sulfonic acid form or as the metal sulfonate salt, with a wide range of metals possible. As in the preceding cases, the planar sulfonated quinacridone molecules appear to lie flat on the quinacridone pigment surface and thus improve considerably the dispersion properties of the pigment, especially when used in coating applications. Figure 76.15 represents the arrangement of sulfonated quinacridone derivative on the pigment surface.

Pigment derivatives of azo red,²⁸ oranges, and yellows²⁹ have also been used for surface treating the corresponding pigments. With azo yellows, treatments can be carried out in situ with fatty amines to produce easily dispersible products through a Schiff base reaction between the $\text{—C}^{*}\text{=O}$ (carbonyl) groups of the pigment and the —NH_2 groups of primary amines, to form $\text{—C}^{*}\text{=N—}$ Schiff bases.^{29–32} Derivatives of monoarylide and diarylide yellow pigments can also be prepared by reacting the pigment with a primary diamine and a glycidyl ether³³ to produce a Schiff base. The structure of one of these

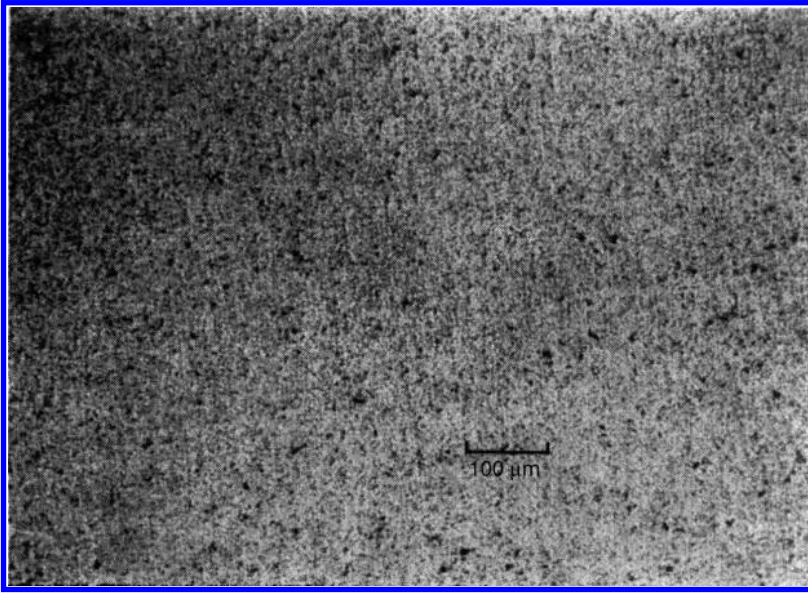

FIGURE 76.11 Optical photomicrograph of liquid ink prepared with untreated diarylide yellow AAOT. Shows flocculation of pigment particles. Same pigment as that of [Figure 76.9](#).

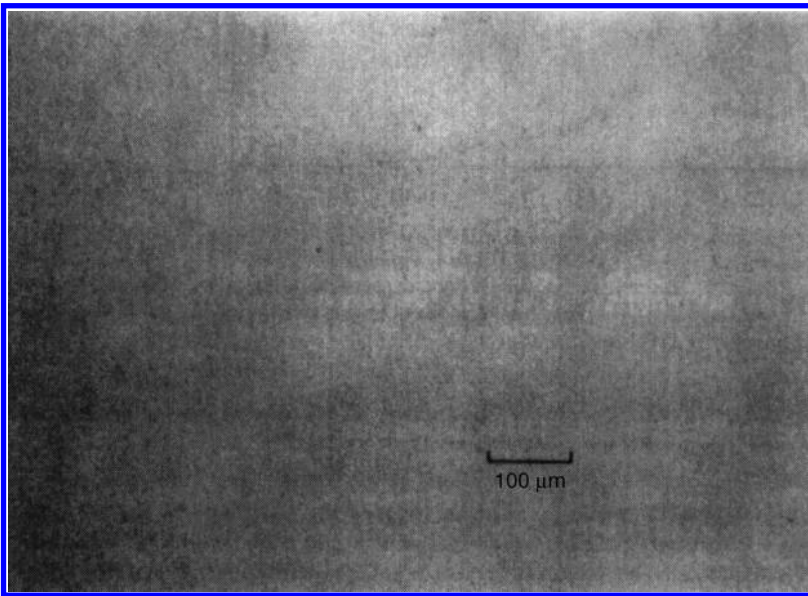
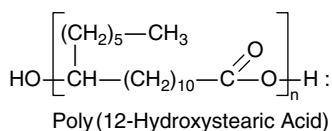

FIGURE 76.12 Optical photomicrograph of liquid prepared with surface-treated diarylide yellow AAOT. Does not show flocculation of pigment particles. Same pigment as that of [Figure 76.10](#).



CuPc—SO₃H : Copper Phthalocyanine Sulfonic Acid

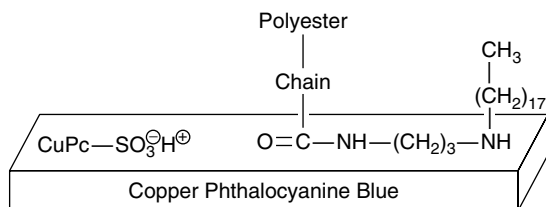
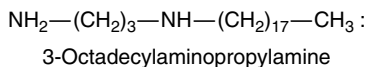

FIGURE 76.13 Surface treatment of copper phthalocyanine blue, Pigment Blue 15, showing the synergistic effect between sulfonated copper phthalocyanine and a polymeric dispersant on the pigment surface.

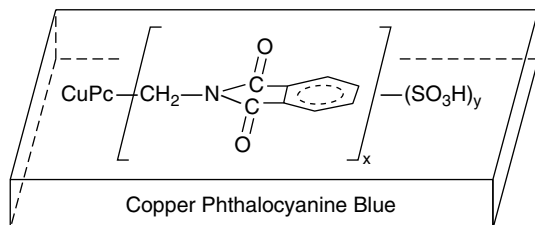
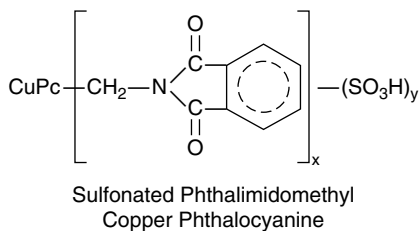
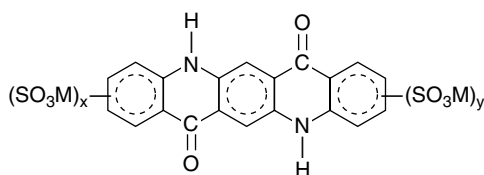

FIGURE 76.14 Surface treatment of copper phthalocyanine blue, Pigment Blue 15, with a sulfonated copper phthalocyanine additive, surface modifying agent.



Sulfonated Quinacridone Red
M = H, Al, Mg, Zn, Cu, Ni, Cd, Cr, Co, Mn

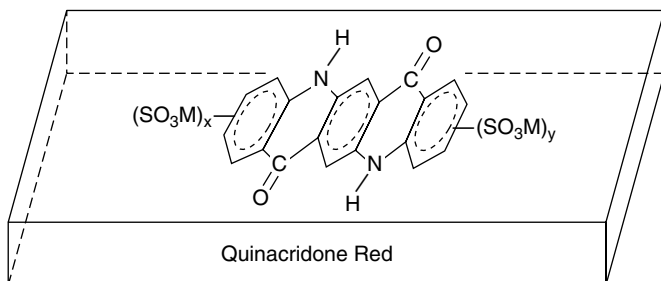

FIGURE 76.15 Surface treatment of quinacridone red, Pigment Violet 19, with a sulfonated quinacridone additive, surface modifying agent.

$\text{H}_2\text{N}-\text{R}-\text{NH}_2$: Primary Diamine

$\text{R}'\text{OCH}_2-\text{CH}(\text{O})-\text{CH}_2$: Glycidyl Ether

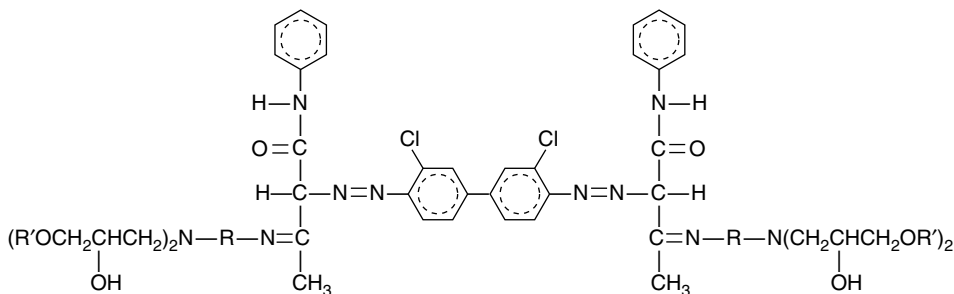

FIGURE 76.16 Diarylide yellow AAA, Pigment Yellow 12, derivative; Schiff base.

derivatives in shown in Figure 76.16 for Pigment Yellow 12, AAA yellow. Again, the planar pigment molecule appears to lie on the pigment surface, and the long chains project outward into the vehicle to produce stabilization of the dispersion.

76.8.2 Inorganic Pigments

Titanium dioxide, in the two naturally occurring crystal forms, anatase and rutile, is the most important white pigment, which provides maximum opacifying power. Normally, TiO_2 pigments are not used in their pure form because of their poor dispersibility in a variety of resins and solvents. Generally, they are surface coated with small amounts of alumina, silica, or both (up to 3% total, on TiO_2) to increase the functionality of the surface (active adsorption sites for the resin molecules) and to improve dispersibility and impart stability to the dispersion, especially in alkyd resin paint systems. For alumina-coated titanium dioxide,³⁴ the highly basic sites on the alumina surface, which are much more basic than the sites on the TiO_2 surface, cause specific adsorption of the acidic functional groups of the alkyd resin

molecules. The remaining parts of the resin molecules (long chains) extend away from the surface, creating a considerable amount of steric hindrance around each pigment particle, thus resulting in steric stabilization of the dispersion.

Alumina-coated titanium dioxide, iron oxide red, and other inorganic pigments and fillers can be surface treated with alkanolamines (aminoalkanols), having the general formulas

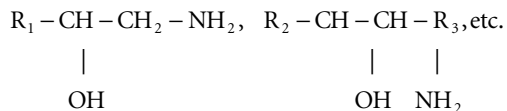

where R_1 , R_2 , and R_3 are alkyl groups containing from 1 to 22 carbon atoms in the chain.³⁵ The dispersibility of these pigments is increased considerably when used in paint formulations containing air drying resin vehicles. The stability of the dispersion is similarly improved because of the steric stabilization imparted to the pigment particles by the R_1 , R_2 , and R_3 long chain alkyl groups.

Organic isocyanate adducts³⁶ are used as effective dispersing agents for several classes of inorganic pigments, including zinc oxide, iron oxides, Prussian Blue, cadmium sulfide, ultramarine, vermilion, and chrome pigments (zinc, barium, and calcium chromates). These agents improve the dispersion characteristics and the flocculation resistance of the above-listed pigments when incorporated into conventional alkyd paint vehicles with organic solvents, where these systems also contain a substantial amount of titanium dioxide.

76.9 The Characterization and Assessment of Dispersion

The extent to which a pigment is dispersed in the medium or the degree of dispersion is normally assessed in terms of color strength, gloss, brightness, and transparency, and it also has an effect on the rheological properties of the system.³⁷⁻³⁹ Since all these properties are governed by the size and distribution of the pigment particles in the dispersion, one can, today, measure these properties using any of the latest particle size analyzers based on the light scattering principle of the dispersed particles.¹² With these instruments, a very dilute suspension is required, and it is necessary to know the refractive index and viscosity of the suspending medium. The average particle diameters and the particle size distributions obtained are those of individual particles, aggregates, agglomerates, and flocculates in the dispersion. The advantages of these instruments are that they are quite easy to operate, they give results rapidly, and they allow the dispersion process to be followed at different times and at different stages.

One such instrument is the Coulter model N4 Submicron Particle Analyzer. [Figure 76.17](#) represents the particle size results for a green-shade phthalocyanine blue, C.I. Pigment Blue 15:3, in an aqueous dispersion. The distribution is quite narrow, and the mean particle diameter is 0.117 μm . These results are very similar to those obtained from inspection of the transmission electron micrographs of [Figure 76.1](#) for the same phthalocyanine blue pigment in the dry powder form, showing that very little aggregation exists in the dispersion.

Such particle size analyzers, based on light scattering, can be used very effectively to study particle size changes that occur during the dispersion of pigments in fluid systems. Furthermore, time studies may be carried out on the flocculation of pigments by determining particle size immediately after dispersion and then later, after the dispersions have been allowed to stand for certain periods. This gives a measure of the stability of the dispersion.

76.10 Conclusion

There is no question as to the desirability and effectiveness of a fully dispersed and stabilized pigmented system. Such a dispersion brings out the optimum color properties of the pigment in terms of color strength, gloss, transparency, and rheology. When a pigment is completely dispersed, it contains a larger

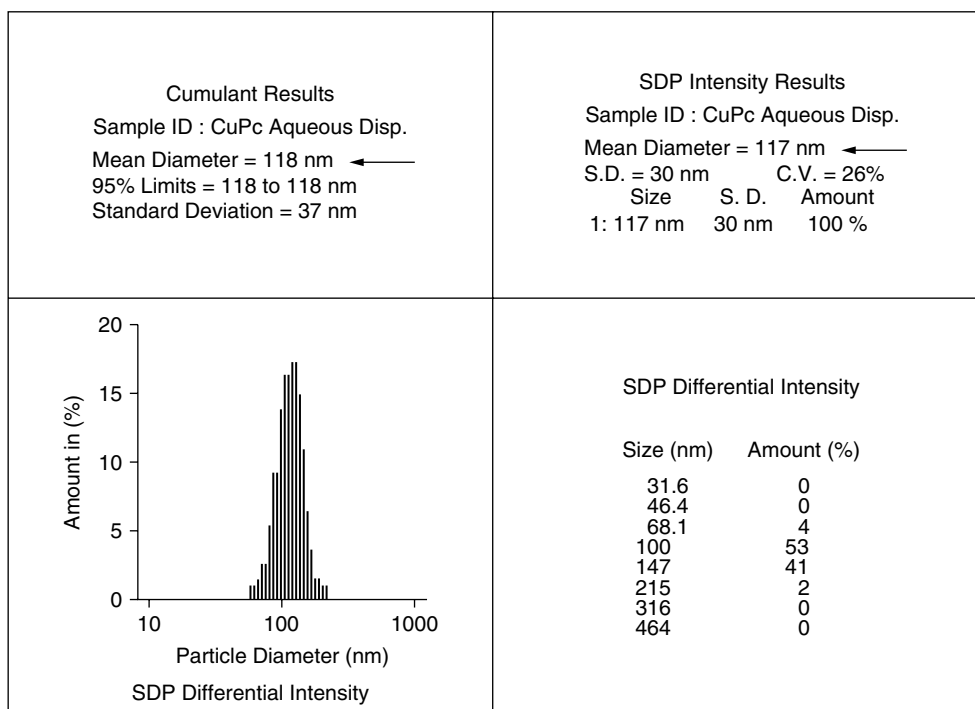

FIGURE 76.17 Particle size results of a copper phthalocyanine blue, Pigment Blue 15:3, aqueous dispersion by the Coulter Model N₄ Submicron Particle Size Analyzer, used to assess the degree of dispersion (SDP = Size Distribution Program).

number of primary particles; therefore, a smaller amount is required to produce the necessary coverage and color strength than would be necessary for a pigment that was not as well dispersed and contained a larger number of aggregates, agglomerates, and flocculates.

The trend today is toward production of more easily dispersible pigments, as counterparts to the easily dispersible azo yellows, which are already used widely in certain printing ink systems. Pigment manufacturers are always improving pigment dispersibility, through the use of surface treatments, in terms of surfactants, polymeric dispersants, and pigment derivatives. The end result is the achievement of complete dispersion easily and quickly. Since this is an energy-intensive process, in terms of the dispersion equipment utilized, less energy is required, which results in greater economic benefits for the pigment user.

References

1. G. D. Parfitt, Ed., *Dispersion of Powders in Liquids*, 2d ed. New York: John Wiley, 1973.
2. T. C. Patton, *Paint Flow and Pigment Dispersion*, 2d ed. New York: John Wiley, 1979.
3. V. T. Crowl, *J. Oil Colour Chem. Assoc.*, 55, 388 (1972).
4. O. Hafner, *J. Oil Colour Chem. Assoc.*, 57, 268 (1974).
5. W. Carr, *J. Oil Colour Chem. Assoc.*, 61, 397 (1978).
6. D. M. Varley and H. H. Bower, *J. Oil Colour Chem. Assoc.*, 62, 401 (1979).
7. H. M. Smith, *Polym. Paint Color J.*, 175, 660 (1985).
8. P. A. Lewis, Ed., *Pigment Handbook*, Vol. 1, 2d ed. New York: John Wiley, 1988.
9. G. D. Parfitt and K. S. W. Sing, Eds., *Characterization of Powder Surfaces*. London: Academic Press, 1976.
10. H. P. Preuss, *Pigments in Paint*. Park Ridge, NJ: Noyes, 1974.
11. W. M. Morgans, *Outlines of Paint Technology*, Vols. 1 and 2, 2d ed. London: Charles Griffin, 1982.

12. T. G. Vernardakis, *Am. Ink Maker*, 62(2), 24 (1984).
13. P. Sorensen, *J. Paint Technol.*, 47, 31 (1975).
14. J. S. Hamptom and J. F. MacMillan, *Am. Ink Maker*, 63(1), 16 (1985).
15. B. G. Hays, *Am. Ink Maker*, 62(6), 28 (1984).
16. A. Topham, *Prog. Org. Coat.*, 5, 237 (1977).
17. K. Merkle and H. Schafer, in *Pigment Handbook*, Vol. III. T.C. Patton, Ed. New York: John Wiley, 1973, pp. 157–167.
18. A. E. Ambler and R. W. Tomlinson, U.S. Patent 3,296,001 (January 3, 1967), ICI.
19. T. C. Rees and R. J. Flores, U.S. Patent 4,032,357 (June 28, 1977), Sherwin-Williams.
20. T. G. Vernardakis, *Dyes Pigments*, 2, 175 (1981).
21. J. F. Stansfield and A. Topham, U.S. Patent 3,996,059 (December 7, 1976), ICI.
22. P. K. Davies, L. R. Rogers, J. F. Stansfield, and A. Topham, U.S. Patent 4,057,436 (November 8, 1977), ICI.
23. Anon., British Patent 1,544,839 (April 25, 1979), BASF.
24. W. H. McKellin, H. T. Lacey, and V. A. Giambalvo, U.S. Patent 2,855,403 (October 7, 1958), American Cyanamid.
25. V. A. Giambalvo and W. Berry, U.S. Patent 3,589,924 (June 29, 1971), American Cyanamid.
26. S. L. Johnson, G. McLaren, and G. H. Robertson, U.S. Patent 4,448,607 (May 15, 1984), Sun Chemical.
27. E. E. Jaffe and W. J. Marshall, U.S. Patent 3,386,843 (June 4, 1968), DuPont.
28. J. Mitchell and A. Topham, U.S. Patent 3,446,641 (May 27, 1969), ICI.
29. J. Mitchell and A. Topham, British Patent 1,139,294 (January 8, 1969), ICI.
30. Anon., British Patent 1,080,115 (August 23, 1967), KVK.
31. F. Dawson, J. Mitchell, L. R. Rogers, W. Todd, and A. Topham, British Patent 1,096,362 (December 29, 1967), ICI.
32. G. H. Robertson, U.S. Patent 4,220,473 (September 2, 1980), Sun Chemical.
33. R. J. Schwartz and T. Sulzberg, U.S. Patent 4,468,255 (August 28, 1984), Sun Chemical.
34. M. J. B. Franklin, K. Goldsbrough, G. D. Parfitt, and J. Peacock, *J. Paint Technol.*, 42, 740 (1970).
35. H. Linden, H. Rutzen, and B. Wegemund, U.S. Patent 4,167,421 (September 11, 1979), Henkel.
36. F. Hauxwell, J. F. Stansfield, and A. Topham, U.S. Patent 4,042,413 (August 16, 1977), ICI.
37. W. Carr, *J. Oil Colour Chem. Assoc.*, 65, 373 (1982).
38. K. Tsutsui and S. Ikeda, *Prog. Org. Coat.*, 10, 235 (1982).
39. R. Polke, *Am. Ink Maker*, 61(6), 15 (1983).

77

Colored Inorganic Pigments

77.1	The Colour Index System.....	77-1
77.2	Pigment Selection.....	77-2
77.3	Inorganic Blues.....	77-2
	Iron Blue • Cobalt Blue • Ultramarine Blue • Cobalt Chromate	
77.4	Inorganic Browns.....	77-3
	Natural Iron Oxides • Iron Oxide Browns • Mixed Metal Oxide Browns	
77.5	Inorganic Greens.....	77-5
	Chrome Green • Chromium Oxide Green • Hydrated Chromium Oxide Green • Mixed Metal Oxide Greens	
77.6	Inorganic Oranges.....	77-6
	Cadmium Orange • Chrome Orange • Cadmium Mercury Orange	
77.7	Inorganic Reds.....	77-6
	Iron Oxide Reds • Molybdate Orange • Cadmium Red • Mercury Cadmium Red	
77.8	Inorganic Violets.....	77-8
	Ultramarine Violet • Manganese Violet • Mixed Metal Oxide Violets	
77.9	Inorganic Yellows.....	77-9
	Strontium Yellow • Primrose Chrome Yellow • Cadmium Zinc Yellow • Zinc Chromate • Cadmium Sulfide Yellow • Iron Oxide Yellows • Mixed Metal Oxide Yellows • Bismuth Vanadate/ Molybdate Yellow	

Peter A. Lewis

Sun Chemical Corporation

This chapter describes the chemistry, manufacture, and properties associated with the major classes of colored inorganic pigments as used in the coatings industry. Thus, pigmentary inorganic whites such as titanium dioxide are not covered.

77.1 The Colour Index System

The Colour Index System is a coding system developed under the joint sponsorship of the Society of Dyers and Colourists (SDC) in the United Kingdom and the Association of Textile Chemists and Colorists (AATCC) in the United States. The system is referred to as the “Colour Index.” In referring to pigments using the Colour Index System, we may describe, for example, Molybdate Orange as Pigment Red 104, Colour Index number 77605.

The Colour Index names for pigments are abbreviated as follows:

PB = Pigment Blue
 PBr = Pigment Brown
 PM = Pigment Metal
 PV = Pigment Violet
 PW = Pigment White
 PBk = Pigment Black
 PG = Pigment Green
 PO = Pigment Orange
 PR = Pigment Red
 PY = Pigment Yellow

77.2 Pigment Selection

Once a formulator has decided on the shade required for a particular application, the next most important criteria of any pigment are its fastness properties. It is pointless to formulate a coating with a pigment that will not withstand the exposure specifications of the coating's end use. Such specifications can extend to requiring as much as 5 years of outdoor exposure in states such as Florida and Arizona.

Due attention must be paid to the appropriate manufacturers' literature to ensure that a pigment has been chosen that will satisfy the end-use criteria for fastness to light, solvents, heat, and chemicals, as well as flocculation and crystallization. Once a pigment class has been selected that will perform adequately in the end-use application, the formulator can consider such other factors as economy.

The formulator should be aware, however, that the fastness properties of a pigment will be affected by the medium into which it is incorporated. Thus, even though intrinsically the pigment may feature the required properties, it is still necessary for the final pigmented coating to be tested in the end-use application. Use of "base coat–clear coat" formulations in the automotive and industrial marketplace in recent years has had a major effect on pigment choice in this area, since incorporation of UV absorbers in the clear coat has done much to extend the fastness properties of the pigments used in the base coat.

77.3 Inorganic Blues

77.3.1 Iron Blue

The most common and economical inorganic blue is iron blue, Pigment Blue 27, a complex ferriferrocyanide having the formula $\text{FeNH}_4\text{Fe}(\text{CN})_6 \times x\text{H}_2\text{O}$. Originally called Prussian Blue, the pigment was discovered by Diesbach in 1704 and was characterized as having a very jet masstone, a red tint, and a very hard texture. Development of a pigment that had a softer texture and improved dispersion by the French chemist Milori led to the introduction to the marketplace of a product chemically identical to Prussian blue but known as Milori Blue.



Iron blue is manufactured by reacting ferrous sulfate with sodium ferrocyanide in the presence of ammonium sulfite to yield a leukocoferricyanide known as Berlin White (Equation 77.1). This intermediate stage is then dissolved in sulfuric acid and oxidized with sodium chlorate to give iron blue (Equation 77.2). Various specialty grades of iron blue exist that differ in masstone, tint strength, dispersion, and oil absorption.

Chinese Blue is a fine grade that exhibits a green undertone as compared to the original Prussian Blue. Bronze blue is a variety that exhibits a surface bronze that depends on the angle at which the surface is viewed.

Iron blue exhibits good resistance to weak acids but very poor resistance to even mildly alkaline systems. Iron blues also show marked tendency to lose their blueness if stored in a paint system that contains oxidizable vehicles such as linseed oil. An extension of this phenomenon occurs when the paint is applied to a surface, since the color will return as the film dries and atmospheric oxygen reverses the reaction.

Although iron blues feature good lightfastness properties when used at masstone or deep tint levels, this feature rapidly becomes unacceptable if the pigment is used highly extended with white. Use of iron blues in the coatings industry has been greatly reduced because of the availability of the more economical and durable copper phthalocyanine blue.

77.3.2 Cobalt Blue

Cobalt blue is a mixed metal oxide or solid solution with a typical composition of CoAl_2O_4 that is a crystalline matrix of Al_2O_3 (65 to 70%) and CoO (30 to 35%). The pigment is Pigment Blue 28, and it is made by calcining cobalt oxide and aluminum oxide at temperatures approximating 2400°F. The calcined pigment is reduced to a fine powder using physical means such as hammers or air milling.

Cobalt blue is chemically inert, extremely heat stable, and lightfast; it is hard and abrasive and has a high hiding power due to its relatively high opacity. The material is not as strong or as clean as copper phthalocyanine blue and as such is relatively more expensive. The major markets the product serves are the coatings and plastics market, with a particular niche in the vinyl sidings industry.

77.3.3 Ultramarine Blue

Ultramarine blue is catalogued as Pigment Blue 29 and is also known under more common names such as Laundry Blue, Dolly Blue, and lapis lazuli. Chemically the pigment is a sodium aluminum sulfosilicate of inexact composition but closely related to the zeolites and having a suggested formula of $\text{Na}_6\text{Al}_6\text{Si}_6\text{O}_{24}\text{S}_4$. Two chemically distinct types of ultramarine blue, a green shade and a red shade, can be made by varying the calcinations process by which the product is manufactured. Although their basic characteristics are the same, the green shade contains more aluminum and less sulfur than does the red shade.

The major use for ultramarine blue, as one of its common names implies, is as a laundry aid in soap and detergents. Less than 5% of the production is used in the coatings industry. Its uses are in the area of interior gloss and emulsion paints that require excellent alkali resistance and lightfastness.

77.3.4 Cobalt Chromate

Cobalt chromate, also called Cerulean Blue, is related to cobalt blue in that it too is a mixed metal oxide. Cobalt chromate, however, contains chromium in the matrix in addition to cobalt and aluminum. The empirical formula is $\text{Co}(\text{Al,Cr})_2\text{O}_4$, and the compound is catalogued as Pigment Blue 36. The material is a crystalline matrix of cobalt oxide (30 to 35%), chromium oxide (30 to 60%), and aluminum oxide (10 to 40%). The pigment is made by calcining an appropriate mixture of these metal oxides at a temperature of 2400°F.

Cobalt chromate is used for premium coatings, where outstanding long-term durability and weatherefastness are a prerequisite of the desired end use.

77.4 Inorganic Browns

The major inorganic browns used in today's coatings applications are those based on oxides of iron; they are available as the naturally mined product or as the synthetically produced material. The coatings market is the largest consumer of iron oxides, irrespective of their hue. Until 1920 all the major iron oxide pigments were wholly from naturally occurring deposits with little changes other than that of physical separation from impurities found alongside the natural ores. Natural iron oxides suffer from the obvious disadvantage of nonuniformity because their properties, particularly particle size, vary with

their source. For this reason, natural oxides have traditionally carried names such as Raw Sienna, Burnt Sienna, Turkish Umber, and Burnt Umber.

Oxides produced synthetically offer the user a more uniform product, with minimal batch-to-batch variation and controlled physical properties.

77.4.1 Natural Iron Oxides

By definition, these iron oxides are obtained from naturally occurring deposits of ore. The source mines for these pigments can be classified as either “iron ore mines” or “pigment mines.” Mines of the former type operate primarily as suppliers of ore as feedstock for blast furnaces with only a small offtake for the pigment industry. Nevertheless, this relatively small output represents the major source of red oxides. The pigment mines are in existence solely to supply crude ore for pigments. The earth’s crust contains massive deposits of both hematite (red iron oxide) and magnetite, the mythical lodestone (black iron oxide). Deposits of the Yellow Ochres and Brown Siennas and Umbers are relatively sparse.

A typical mining operation may involve dumping crude ore on an incline followed by slurring this ore into an aqueous suspension using high pressure water jets. The slurry is next directed through a series of crude washing stages to remove coarse sand and rock particles. This removal of suspended impurities continues as the slurry passes into a separator tank and then through a Dorr bowl rake. The ore leaving the rake overflows to a separating tank, from which it is withdrawn under controlled conditions. The slurry is dried as a thin aqueous layer using a rotary drum drier.

For a particle to be described as pigmentary, it is generally accepted that the particle size should be smaller than 25 μm . For natural iron oxides to possess this physical property, the dried ore must be pulverized and classified to eliminate agglomerates. After classification, the particle size is defined by reference to the percentage of particles that will pass through a 325-mesh sieve — that is, a screen with a mesh size of 44 μm .

In the drying process, steam is used as the heat source, to permit the hydrated oxides to dry without loss of water of crystallization and consequent color shift. The process of calcining, where temperatures in excess of 1200°F are reached, involves the treatment of the hydrated oxides at temperatures that will result in the complete loss of water to form the corresponding Burnt Siennas and Burnt Umbers.

In today’s industry, fluid energy mills and micronizing or jet mills are used to grind and deaggregate the dried agglomerates. With many commercial pigmentary oxides, the final stage in processing involves the blending of batches showing variations outside the accepted standard specification to produce a standardized product.

77.4.2 Iron Oxide Browns

Pigment Brown 7 is an iron oxide brown that is available in shades ranging from light red to deep purple brown. The empirical formula is Fe_2O_3 and as a natural product it contains varying amounts of clay. Offered as Metallic Brown, made from calcined hematite (PR 102) and Burnt Sienna, made from calcined limonite (PY 43), the composition of the pigment varies depending on both the source of the ore and the conditions of calcinations. Major deposits are worked in Cyprus and in Italy; in the United States, there are deposits in Georgia and Virginia.

Pigment Brown 7:x is a ferrosferric oxide derived from ores containing 25% manganese dioxide having a very indistinct composition that may be described as $\text{Fe}_2\text{O}_3 \cdot x\text{MnO}$ with varying proportions of clay. Classical names include Raw Umber, Burnt Umber, and Turkish Umber. Principal producers of the “umbers” continue to be the United States, Cyprus, and Turkey.

Synthetic brown oxide is Pigment Brown 6. Also known as brown magnetic iron oxide, the pigment is produced by controlled oxidation of Pigment Black 11. Chemically the material is Fe_2O_3 with a proportion of FeO and $\text{Fe}_2\text{O}_3 \cdot \text{H}_2\text{O}$. Pigment Brown 11 is magnesium ferrite made by calcining a blend of ferric oxide and magnesium oxide. Chemically the pigment is $\text{MgO} \cdot \text{Fe}_2\text{O}_3$. The volume of brown iron oxides used in coatings is generally low, since most users achieve browns by formulating blends of yellow, red, and black pigments.

Brown iron oxides have good chemical resistance and high tint strength and are permanent pigments. They are ideal pigments for use in wood stains and furniture finishes.

77.4.3 Mixed Metal Oxide Browns

The other browns used in the coatings industry are Pigment Browns 24, 33, and 35. Each is a mixed metal oxide of variable composition.

Pigment Brown 24 is chrome antimony titanium buff rutile made by calcining oxides of titanium, chromium, and antimony. The pigment is a yellowish brown with excellent fastness to heat, light, and weather.

Pigment Brown 33 is zinc iron chromite brown formed by calcining a mixture of the oxides of zinc, chromium, and ferrous and ferric iron. The product is a dark brown with outstanding durability, chemical resistance, and baking fastness.

Pigment Brown 35 is iron chromite brown made by calcining chromium oxide with a mixture of ferric and ferrous oxides. Again, typical of this class of pigments, the fastness properties are excellent.

77.5 Inorganic Greens

77.5.1 Chrome Green

Chrome greens, Pigment Green 15, are blends or mixtures of a green-shade chrome yellow (PY 34) and iron blue (PB 27). Varying the ratio of these two substituents gives greens with a light yellow shade to a deep, dark shade. An empirical formula is $\text{PbCrO}_4 \times x\text{PbSO}_4 \times y\text{FeNH}_4\text{Fe}(\text{CN})_6$.

The pigments provide good hiding, high tint strength, and moderate chemical resistance at a relatively good price. Bake temperatures up to 300°F can be tolerated. Use of chrome greens is restricted to exterior and industrial coatings applications because of the lead content of the pigments.

77.5.2 Chromium Oxide Green

Chromium oxide green, Pigment Green 17, finds a special application in camouflage paints because of its ability to reflect infrared light. The pigment is pure, calcined chromium oxide, Cr_2O_3 , manufactured by reduction of sodium bichromate with sulfur or carbon.

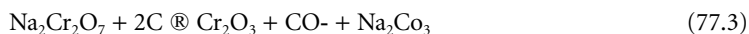

The pigment is used where its price can be justified by the resultant excellent light and chemical fastness properties the pigment gives to the coating.

77.5.3 Hydrated Chromium Oxide Green

Also known as viridian green or Guignet's green, this material is Pigment Green 18 and is chemically a hydrated chromic oxide of formula $\text{Cr}_2\text{O}_3 \times 2\text{H}_2\text{O}$ made by hydrolyzing the product of the calcining of sodium bichromate with boric acid. The pigment is a bright, blue-shade green with exceptional chroma and brilliance that has outstanding fastness properties in both masstone and deep tints.

77.5.4 Mixed Metal Oxide Greens

Cobalt chromite green, Pigment Green 26, is a mixed metal oxide of variable composition made by calcining cobalt and chromium oxide to give CoCr_2O_4 . The pigment is a blueshade green with excellent light, weather, and heat fastness.

Cobalt titanate green, Pigment Green 50, is another mixture made by calcining cobalt and titanium oxides to produce Co_2TiO_4 . The pigment offers high infrared reflectivity in camouflage paints and outstanding light, weather, chemical, and heat fastness.

77.6 Inorganic Oranges

77.6.1 Cadmium Orange

Also known as cadmium sulfoselenide orange, this pigment, Pigment Orange 20, is a solid solution produced by calcining cadmium sulfide with cadmium selenide at a temperature approximating 1000°C. Change in the stoichiometry of the cadmium sulfide–cadmium selenide mixture results in a range of pigmentary products with a shade range from bright yellow (PY 35) to a bright red (PR 108). Barium sulfate added or formed in the process extends the pigment and gives the lithopone version of the orange designated by a suffix as Pigment Orange 20:1.

Cadmium orange is used in the coatings industry in industrial color coding applications, where chemical and heat resistance are prime requisites of the applied coating.

77.6.2 Chrome Orange

Chrome orange, Pigment Orange 21, is a basic lead chromate formed under alkaline conditions to give a product of empirical formula $\text{PbCrO}_4 \times x\text{PbO}$. Shades from a yellow-shade to a red-shade orange can be produced, depending on the alkalinity of the reaction mass.

Because of the pigment's low cost and moderate lightfastness, the major coatings use of chrome orange is in the production of protective coatings. As with all lead-containing pigments, the color will rapidly darken on exposure to atmospheric sulfur. Restrictions on the use of lead-containing products have resulted in a marked reduction in consumption of chrome orange in recent years.

A variation of chrome orange is Pigment Orange 21:1, a basic lead silicochromate of formula $\text{PbSiO}_3 \cdot 3\text{PbO}$. This pigment's major outlet is in road traffic paints.

77.6.3 Cadmium Mercury Orange

Known by the Ciba-Geigy trade name of Mercadium Orange, Pigment Orange 23 is a solid solution of mercury sulfide in cadmium sulfide. Careful control of the formation of the mixed crystal enables a product of controlled hue to be produced. The pigment is manufactured by precipitation of the sulfides of mercury and cadmium from a solution containing their soluble salts followed by calcining this precipitate in an inert atmosphere.

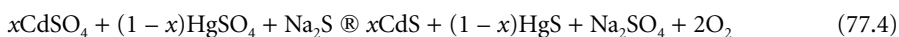

An extended or lithopone-type pigment, Pigment Orange 23:1, can be produced by using barium sulfate as the precipitant, thus producing insoluble barium sulfate as a by-product of the reaction sequence which is retained with the pigment.

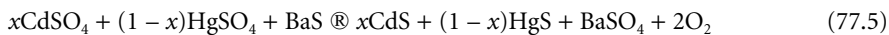

Cadmium mercury oranges are extremely heat stable, withstanding temperatures up to 700°F, and have excellent chemical resistance and outstanding weatherability and solvent fastness.

77.7 Inorganic Reds

77.7.1 Iron Oxide Reds

As with the iron oxide browns, we again see pigments that are available as both natural and synthetic products. Iron oxide red, Pigment Red 101, is available under such names as Hematite, Persian Gulf oxide, Mars red, Turkey red, Indian red, Ferrite red, and Rouge. The synthetic material is chemically Fe_2O_3 , whereas the naturally occurring product is Fe_2O_3 with varying amounts of FeO and clay.

Synthetic red iron oxides represent the largest class of synthetic iron oxides manufactured. Four principal manufacturing routes are employed:

1. Copper as red oxide is formed by calcining iron sulfates.

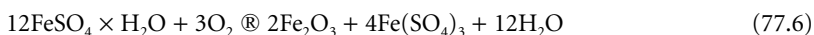

2. Synthetic red oxide is produced from synthetic black oxide by calcining the material in a controlled atmosphere containing oxygen.



3. Precipitated red oxide is prepared in an aqueous medium by growing seed nuclei in the presence of a ferrous salt and scrap steel. Control of the pigment particle size during the process results in control of the darkness/lightness of the oxide.
4. Synthetic red oxide may be produced by calcining synthetic yellow iron oxide ($\text{Fe}_2\text{O}_3 \times \text{H}_2\text{O}$) to give the dehydrated product, which is Fe_2O_3 . The wide range of shades available in the red oxide class, coupled with their acid and alkali resistance, heat stability, and the economics associated with using these pigments, accounts for the large tonnage of these pigments used annually in the coatings industry.

77.7.2 Molybdate Orange

Although given the common name classification of an orange, this pigment is in fact Pigment Red 104 with empirical formula $\text{PbCrO}_4 \times x\text{PbMoO}_4 \times y\text{PbSO}_4$. Other common names for this pigment include Chrome red, Molybdate red, and Chrome vermilion. The pigment is in fact a solid solution of lead chromate, lead molybdate, and lead sulfate. The material is produced by adding a solution of sodium chromate, sodium molybdate, and sodium sulfate under controlled conditions into a solution of lead nitrate at a temperature between zero and 40°C to precipitate the mixed crystal. Control of the particle size distribution and crystalline shape determines the actual hue of the manufactured pigment from red-shade yellow to red-shade orange.

Molybdate orange is an opaque pigment with high solvent fastness, moderate heat fastness, and good economy. The pigment has poor alkali and acid resistance, and the nontreated grades will exhibit considerable darkening on exposure to atmospheric pollutants, particularly in heavily industrialized areas. The pigment is also sensitive to overgrinding when, if care is not exercised, the crystal will disproportionate to give a yellower, weaker looking product.

The major outlet for Molybdate orange is in the coatings industry, with an estimated 60% of the pigment produced going into coatings. In decorative and industrial paints Molybdate orange is used as the basis for many red and orange formulations, particularly in combinations with organic pigments such as quinacridone, when used for original equipment manufacturers (OEM) finishes in the automotive industry, in countries that still allow lead to be used in OEM coatings formulations.

77.7.3 Cadmium Red

Pigment Red 108 is cadmium sulfoselenide red, a solid solution of cadmium sulfide and cadmium selenide produced by calcining a coprecipitate of cadmium sulfide and cadmium sulfoselenide. The amount of cadmium selenide incorporated into the solid solution dictates the final hue of the pigment as does also, to a lesser extent, the temperature of calcinations. The empirical formula is $\text{CdS} \times x\text{CdSe}$.

A lithopone version, $\text{CdS} \times x\text{CdSe} \times y\text{BaSO}_4$, Pigment Red 108:1, is also available as an extended product coprecipitated with barium sulfate.

The pigment exhibits excellent stability to heat, alkali, organic solvents, and light when used at masstone and high tint levels. It offers clean bright shades of high chroma. Lighter shades will show poorer resistance to light and moisture than will the more intense shades.

77.7.4 Mercury Cadmium Red

Another inorganic pigment, known by the Ciba-Geigy trade name of Mercadium Red, is Pigment Red 113. This calcined coprecipitate of mercuric sulfide with cadmium sulfide has the empirical formula $CdS \times xHgS$.

An extended lithopone type also exists, Pigment Orange 23:1, which can be produced by using barium sulfate as the precipitant, thus producing insoluble barium sulfate as a by-product of the reaction sequence, which is retained with the pigment.

Not as heat resistant as cadmium reds but offering economy, good hiding, good solvent resistance, and excellent brightness, mercury cadmium reds do show a marked sensitivity to acids, which precludes their use in coatings that are likely to come into contact with such substances.

77.8 Inorganic Violets

77.8.1 Ultramarine Violet

This violet is Pigment Violet 15, a sodium sulfosilicate prepared by oxidation of Pigment Blue 29, Ultramarine blue. The redness of hue of the violet is determined by controlling the degree of oxidation. Chemically the pigment is $Na_4H_2Al_6Si_6O_{24}S_2$.

The pigment possesses a brilliant hue and offers good lightfastness and heat stability. It will react with metals to form sulfides and finds use in cosmetic applications and in nontoxic acrylic poster paints and artists' colors.

77.8.2 Manganese Violet

First introduced at the turn of the century, this pigment, Pigment Violet 16, is manufactured by slurring together a mixture of manganese dioxide and diammonium phosphate in phosphoric acid at high temperatures. The mixture is dehydrated during the reaction sequence to produce the pigment as $MnNH_4P_2O_7$. The manufacture is unusual in that unlike many of the inorganic reactions described in this chapter, it does not proceed via a calcinations process.

The pigment does not have a bright hue; it has only moderate opacity and poor tint strength. It has excellent acid resistance and poor alkali resistance. On the positive side, the pigment has high bleed resistance and lightfastness. The major outlet for the pigment is in the cosmetics industry and as a toner in the plastics industry.

77.8.3 Mixed Metal Oxide Violets

For completeness, the mixed metal oxide violets can be listed as follows:

1. Cobalt violet phosphate, Pigment Violet 14, is a crystalline pigment produced by calcining a mixture of cobalt and phosphorus oxides. The pigment is a blue shade violet of formula $Co_3(PO_4)_2$. Used in artists' colors and plastics, this pigment has poor tint strength and a dirty undertone but outstanding chemical, weather, and lightfastness.
2. Cobalt lithium violet phosphate, Pigment Violet 47, is produced by calcining cobalt, lithium, and phosphorus oxide to give $CoLiPO_4$, a red-shade violet. Again this pigment has poor tint strength, lacks brightness, and has a dirty tint tone. Although the pigment has excellent chemical, light, weather, and heat stability, it finds little use in coatings and is primarily used in plastics.

3. Cobalt magnesium borate, Pigment Violet 48, is a crystalline borate manufactured by calcining a mixture of the oxides of cobalt, magnesium, and boron to give a pigment of formula $(\text{Co,Mg})_2\text{B}_2\text{O}_5$. Another red-shade violet, this pigment features the same properties as cobalt lithium violet phosphate and finds its major use in engineering resins.
4. Cobalt ammonium phosphate, Pigment Violet 49, is produced by a coprecipitation process to give a crystalline pigment of formula $\text{CoNH}_4\text{PO}_4 \times \text{H}_2\text{O}$. Used in artists' colors and as a toner in whites, this pigment exhibits excellent solvent and lightfastness. The pigment has poor acid and alkali resistance, poor bake stability, and poor tint strength.

77.9 Inorganic Yellows

77.9.1 Strontium Yellow

This yellow is Pigment Yellow 32 and is chemically strontium chromate, SrCrO_4 , prepared by precipitating a soluble chromate with a solution of an appropriate strontium salt. The pigment is used primarily in corrosion-inhibiting coatings. Its poor tint strength, low hiding power, and unsatisfactory acid and alkali resistance limit the pigment's use in the coatings industry.

77.9.2 Primrose Chrome Yellow

Primrose chrome yellow, Pigment Yellow 34, is a coprecipitate of lead chromate and lead sulfate of empirical formula $\text{PbCrO}_4 \times x\text{PbSO}_4$.

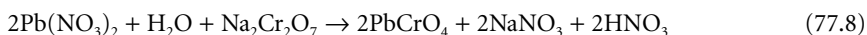

Primrose chrome is made by substitution of a soluble sulfate for part of the sodium bichromate in Equation 77.8; 23 to 30% lead sulfate is contained in typical solid solutions, which are sold as Primrose chrome.

Primrose chrome is stabilized by the use of proprietary additives during the formation of the pigment crystals, such that the orthorhombic crystal form is produced exclusively. The pigment must not be precipitated as the monoclinic form; otherwise instability will result.

Many different grades of lead chromate based pigments are available to offer such improved properties as better chemical resistance, decreased tendency to darken on exposure to the atmosphere, and silica encapsulation to minimize the solubility of the lead in the pigment.

Primrose chrome offers a green shade pigment of good lightfastness, high opacity, low rheology, and low cost. The coatings industry is the largest consumer of Primrose chrome yellow, followed closely by the printing ink and plastics industries.

77.9.3 Cadmium Zinc Yellow

This pigment is yet another coprecipitate or solid solution. For this pigment, Pigment Yellow 35, cadmium sulfide is coprecipitated with zinc sulfide followed by calcinations to give pure cadmium zinc yellow, $\text{CdS} \times x\text{ZnS}$. The hue of the pigment can be varied by altering the amount of zinc sulfide used in the solid solution. A primrose hue is achieved with levels of 14 to 21% of zinc sulfide, whereas 1 to 7% will give a redder shade or "golden" hue.

A lithopone version, Pigment Yellow 35:1, is available. As with all "lithopones," this pigment is merely manufactured in the presence of barium sulfate such that an intimate precipitate is produced containing barium sulfate as part of the solid solution with formula $\text{CdS} \times x\text{ZnS} \times y\text{BaSO}_4$.

The major outlet for cadmium zinc yellows is in the plastics industry. The pigments offer bright, clean, high hiding colors with outstanding resistance to heat, light, and solvents. The pigments, however, have poor fastness to mineral acids and will fade markedly when used at low tint levels or in the presence of moisture.

77.9.4 Zinc Chromate

Zinc chromate or zinc yellow is Pigment Yellow 36. A lithopone version, extended with barium sulfate, also exists as Pigment Yellow 36:1. The pigments are bright green-shade yellows made by precipitating hydrated zinc potassium chromate from the reaction of sodium bichromate with zinc oxide and potassium chloride.

Zinc chromate is used principally in corrosion-inhibiting coatings. It has poor tinting strength and poor resistance to mineral acids and alkalis, thus limiting its use within such systems.

77.9.5 Cadmium Sulfide Yellow

Simply calcinated calcium sulfide, CdS, this pigment, Pigment Yellow 37, can be produced in hues ranging from a green shade to a red shade by varying the conditions during calcinations. The pigment offers excellent stability to heat, light, mineral acids, and alkali. A major drawback is the tendency to fade in the presence of moisture.

The lithopone version, extended with barium sulfate, $\text{CdS} \times x\text{BaSO}_4$, is Pigment Yellow 37:1.

77.9.6 Iron Oxide Yellows

As with most of the iron oxides discussed, this pigment can be obtained as the natural oxide (Pigment Yellow 43) or the synthetic version (Pigment Yellow 42).

The natural yellow iron oxide is $\text{FeO} \times x\text{H}_2\text{O}$, containing various amounts of clay and other minor minerals. The pigment is also known as limonite and is mined in Africa (African ocher), India (Indian ocher), France (Ocher), and Italy (Sienna). The French material is reported to be of the highest quality.

The synthetic material can be produced in a variety of ways. A direct precipitation process uses an alkali such as ammonium hydroxide and ferrous sulfate. The Penniman–Zoph process uses scrap steel and a ferrous salt to grow seed particles, and the aniline process reacts nitrobenzene with metallic iron to produce iron oxide and aniline, a primary aromatic amine, as a by-product. Irrespective of the manufacturing process, the product has the empirical formula $\text{Fe}_2\text{O}_3 \times x\text{H}_2\text{O}$.

Iron oxide yellows are economical pigments with excellent lightfastness, durability, opacity, and rheology. On the negative side, they have a dull masstone, which results in dirty tints and only fair tinting strength and baking stability. Nevertheless, they find widespread use within the coatings industry because of their economics of use.

77.9.7 Mixed Metal Oxide Yellows

For completeness, the mixed metal oxide yellows can be listed as follows:

1. Nickel antimony yellow rutile, Pigment Yellow 53, is a product from the calcinations of the oxides of nickel, titanium, and antimony, $(\text{Ti, Ni, Sb})\text{O}_2$. A green-shade yellow with excellent lightfastness, chemical resistance, and heatfastness, this pigment offers only poor gloss and low tint strength.
2. Zinc ferrite brown spinel, Pigment Yellow 119, is made by calcining the oxides of zinc and ferrous and ferric iron, $(\text{Zn, Fe})\text{Fe}_2\text{O}_4$. A brown-shade yellow or buff with outstanding durability, chemical fastness, and heat stability, this pigment has moderate tinting ability compared to Pigment Yellow 53 but lacks brightness and has a dirty tint tone.
3. Nickel niobium titanium yellow rutile, Pigment Yellow 161, is a crystalline solid solution prepared by calcining the oxides of titanium, niobium, and nickel, $(\text{Ti, Ni, Nb})\text{O}_2$. This pigment is a green-shade yellow with low tint strength and dirty tint tones. Typical of the mixed metal oxides, the pigment offers high heat resistance and outstanding chemical stability and outdoor durability.
4. Chrome niobium titanium buff rutile, Pigment Yellow 162, is a solid solution obtained from the calcinations of titanium, chromium, and niobium oxides, $(\text{Ti, Cr, Nb})\text{O}_2$. It gives a red-shade yellow with outstanding chemical, heat, and lightfastness, coupled with excellent durability. Again its tinting strength is poor, and the pigment lacks brightness.

5. Manganese antimony titanium buff rutile, Pigment Yellow 164, is a pigment prepared by calcining the oxides of manganese, titanium, and antimony $(\text{Ti,Mn,Sb})\text{O}_2$. Typical oxides are manufactured by calcinations. Although it has low tint strength and lacks brightness and cleanliness, the pigment does offer excellent heatfastness and exterior durability, coupled with outstanding chemical resistance.

77.9.8 Bismuth Vanadate/Molybdate Yellow

The most novel inorganic yellow to appear in the pigment marketplace within the past decade is bismuth vanadate/molybdate, Pigment Yellow 184, which was introduced by BASF in 1985. The pigment is manufactured by dissolving bismuth nitrate, sodium vanadate, and sodium molybdate in nitric acid, precipitating a complex oxide of the metals, followed by calcining the complex coprecipitate to give the pigment as a polycrystalline product. The accepted formula is $4\text{BiVO}_4 \cdot 3\text{BiMoO}_6$.

The pigment is a green-shade yellow used primarily for brilliant solid shades in both automotive and industrial coatings. The pigment has excellent weatherfastness, high opacity, and good gloss retention.

78

Organic Pigments

78.1	Introduction	78-1
78.2	The Colour Index System	78-1
78.3	Pigment Selection.....	78-2
	Organic Blues • Organic Greens • Organic Oranges • Reds • Organic Yellows	

Peter A. Lewis

Sun Chemical Corporation

78.1 Introduction

A definition of a pigment, as distinct from a dyestuff, has been prepared by the Dry Color Manufacturers' Association (DCMA) in response to a request from the Toxic Substances Interagency Testing Committee. This definition should clarify the term "pigment" and "dyestuff," which are often erroneously used interchangeably:

Pigments are colored, black, white, or fluorescent particulate organic and inorganic solids which usually are insoluble in, and essentially physically and chemically unaffected by, the vehicle or substrate in which they are incorporated. They alter appearance by selective absorption and/or by scattering of light.

Pigments are usually dispersed in vehicles or substrates for application, as for instance in inks, paints, plastics, or other polymeric materials. Pigments retain a crystal or particulate structure throughout the coloration process.

As a result of the physical and chemical characteristics of pigments, pigments and dyes differ in their application; when a dye is applied, it penetrates the substrate in a soluble form after which it may or may not become insoluble. When a pigment is used to color or opacify a substrate, the finely divided, insoluble solid remains throughout the coloration process.

78.2 The Colour Index System

The Colour Index System is a coding system as developed under the joint sponsorship of the Society of Dyers and Colourists (SDC) in the United Kingdom and the Association of Textile Chemists and Colorists (AATCC) in the United States. The system is referred to as the "Colour Index." (This system is registered as a trade name and the use of the "u" in "Colour" must be retained.) By giving a compound a "Colour Index Name" and a "Colour Index Number," a colored compound can be readily placed into a classification according to its chemical constitution and color. This description is recognized by many government bodies as adequate information for inclusion in hazard data sheets or material safety data sheets to fully identify the pigment in question and to provide accurate reference when including a pigment in any inventory listing. Thus, for example, phthalocyanine blue has a Colour Index name Pigment Blue 15 and the Colour Index number 74160.

TABLE 78.1 Range of Colour Index Constitution Numbers

Chemical Class	Colour Index Constitution Number
Insoluble Azo	
1. Acetoacetyl	11640–11790
2. Heterocyclic hydroxy	12600–12825
3. Disazo	11640–11790
4. 2-Naphthol	20000–29999
5. 3-Hydroxy-2-naphthanilide	12300–12520
Precipitated Azo	
1. 2-Naphthol (sulfonic) acid	15500–16815
Precipitated Nonazo	
1. Xanthene	45000–45999
2. Triphenylmethane	42000–44999
Insoluble Nonazo	
1. Phthalocyanine	74000–74999
2. Anthraquinone	58000–72999
3. Quinacridone	73900–73999

The Colour Index names for pigments are abbreviated as follows:

- PB = Pigment Blue
- PBr = Pigment Brown
- PM = Pigment Metal
- PV = Pigment Violet
- PW = Pigment White
- PBk = Pigment Black
- PG = Pigment Green
- PO = Pigment Orange
- PR = Pigment Red
- PY = Pigment Yellow

Additionally, the Colour Index constitution number conveys information regarding the structure of the compound as shown in Table 78.1.

78.3 Pigment Selection

Once a formulator has decided upon the hue that is required for a particular coating, the next most important criteria of any pigment are its fastness properties. It is useless to formulate any coating with a pigment that will not withstand the exposure specifications of the coating's end use. Such specifications can extend to requiring as much as 5 years' outdoor exposure in states such as Florida and Arizona.

Due attention must be paid to the respective manufacturers' literature to ensure that a pigment has been chosen that will satisfy the end-use criteria for stability to flocculation and crystallization, as well as fastness to light, solvents, heat, and chemicals. Once a pigment class has been selected that will perform adequately in the end-use application, the formulator can consider such other factors as economy. The formulator should be aware, however, that the fastness properties of a pigment will be affected by the medium into which it is incorporated. Thus, even though intrinsically the pigment may feature the required properties, it is still necessary for the final pigmented coating to be tested in the end-use application.

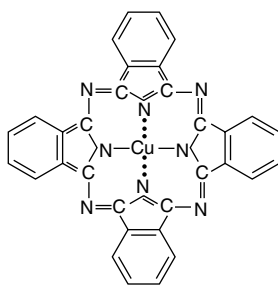

FIGURE 78.1 Structure of copper phthalocyanine blue (pigment blue 15).

78.3.1 Organic Blues

78.3.1.1 Copper Phthalocyanine Blue

The major blue used within the coatings industry is copper phthalocyanine blue (PB 15), with its usage far outweighing other blues such as Indathrone blue (PB 60).

Phthalocyanines are planar molecules with a tetrabenzotetraazoporphin structure as shown in Figure 78.1. Manufacture is comparatively easy despite the superficial complexity of the phthalocyanine molecule. Reaction of a phthalic acid derivative at temperatures approximating 190°C with a source of nitrogen such as urea and a metal or metal salt is usually all that is required to produce the appropriate metal phthalocyanine. Molybdate, vanadates, and certain compounds of titanium have been found to be useful catalysts for this condensation reaction.

Figure 78.2 illustrates the chemistry behind the production of copper phthalocyanine blue. This condensation reaction results in the formation of copper phthalocyanine in a crude, nonpigmentary form. The product has thus to be finished or conditioned to give the pigment grade of choice. Typically crude phthalocyanine blue is characterized by a crystal size of the order of 50 μm , a purity in excess of 92%, and a poor pigmentary strength.

Metal-free phthalocyanine blue (PB 16) is normally manufactured via the sodium salt of phthalonitrile. Acid pasting is used to condition the crude and give the pigment.

Copper phthalocyanine is commercially available in two crystal forms known as the α and β . The α form is described by the designations Pigment Blue 15, 15:1, and 15:2 and is a bright red-shade blue pigment. The β form is described as Pigment Blue 15:3 and 15:4 and is a bright green or peacock shade. The α form is meta-stable and requires special treatment to stabilize the crystal against its tendency to

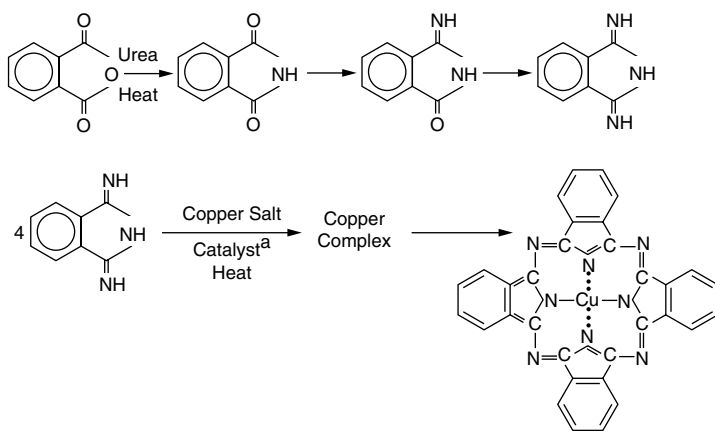

FIGURE 78.2 Chemistry of copper phthalocyanine. ^a Molybdate or vanadate.

revert to the more stable, green-shade β crystal. If either of the unstable α crystal forms (PB 15 or 15:1) is used with strong solvents, conversion to the β form will occur upon storage of the system. Conversion from the α to the β form is usually accompanied by an increase in crystal size with subsequent loss of strength and shift to a greener hue.

As stated earlier, copper phthalocyanine gives excellent service in most coatings applications, but there is considerable variation between both the chemical and crystal types available.

Pigment Blue 15 is an α crystal with the reddest shade of the types commonly available. It is the least stable of the family and as such is often referred to as crystallizing red-shade (CRS) blue. This crystal form cannot be used in any solvent containing systems.

Pigment Blue 15:1 is also an α crystal, but chemical modifications have been made to stabilize the structure against crystallization. Most commonly the molecule is chlorinated to the extent of introducing one chlorine molecule to give "monochlor" blue. Another technique involves the use of a substituted phthalocyanine, added to the pigment at levels approaching 10 to 15%, that confers crystal stability to the system. The monochlorinated grade is, as a consequence of the introduced chlorine atom, greener than the additive-stabilized crystal.

Pigment Blue 15:2, described as "noncrystallizing nonflocculating" red-shade blue, is widely used within the coatings industry. The product is an α crystal that is stabilized against both crystallization and flocculation using additive technology.

Pigment Blue 15:3 represents the green-shade, β crystal phthalocyanine blue and, as it exists in the stable crystal form, it is less susceptible to crystallization. Most commercial grades of Pigment Blue 15:3, however, contain from 4 to 8% of the α crystal, which will be adversely affected by strong solvent systems. A 100% β blue is too dull, opaque, and weak to be commercially attractive; hence, a proportion of the α crystal is left in the system, contributing considerably to the attractiveness of the system.

Pigment Blue 15:4 represents a β blue that has been modified with phthalocyanine-based additives to give a green-shade blue that is resistant to flocculation and can be used in strong solvent systems.

Copper phthalocyanine approximates the ideal pigment. It offers strength, brightness, economy, and all-around excellent fastness properties. Perhaps the pigment's only disadvantages are its tendencies to change to a coarse, crystalline, nonpigmentary form in strong solvents and to flocculate or separate from white pigments when used in paints and lacquers.

78.3.1.2 Miscellaneous Blues

Although the organic blues used in the coatings industry are primarily copper phthalocyanines, brief mention must be made of other blue pigments that find use in the coatings marketplace.

Indanthrone blue, Pigment Blue 60, belongs to the class of pigments described as "vat pigments." This pigment is expensive relative to copper phthalocyanine, and thus economic considerations are a limitation to its widespread use. Indanthrone blue is a very red-shade pigment with outstanding fastness properties.

Carbazole violet, Pigment Violet 23, is a complex polynuclear pigment that is a very valuable red-shade blue of high tinctorial strength. The pigment possesses excellent fastness properties, and only its relatively high cost and its hard nature limit its more widespread use. From an economic standpoint it costs approximately three times as much as phthalocyanine blue.

The pigment is used as a shading component in high performance coatings that call for particularly red-shade blue.

78.3.2 Organic Greens

78.3.2.1 Copper Phthalocyanine Green

The major green pigment used as a self shade in the coatings industry is based on halogenated copper phthalocyanine and, as such, is termed phthalocyanine green. The Colour Index names are Pigment Green 7 and Pigment Green 36.

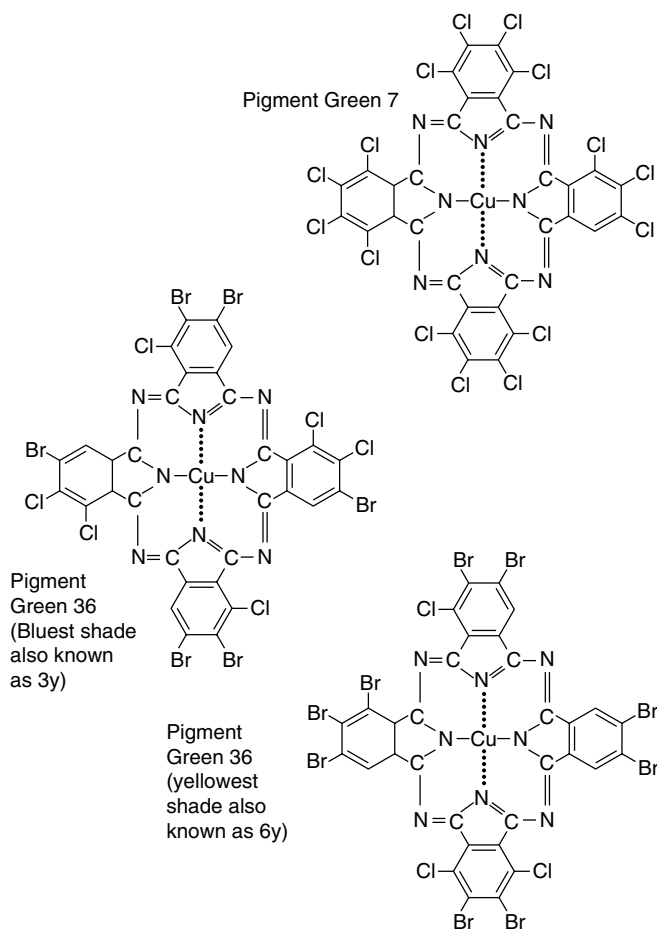

FIGURE 78.3 Structure of copper phthalocyanine greens.

Pigment Green 7, the blue-shade green, is based on chlorinated copper phthalocyanine with a chlorine content that varies from between 13 to 15 atoms per molecule.

Pigment Green 36, the yellower shade, is based on a structure that involves the progressive replacement of chlorine on the phthalocyanine structure with bromine. The composition of Pigment Green 36 varies with respect to the total halogen content, chlorine plus bromine, and in the ratio of bromine to chlorine. Figure 78.3 illustrates the proposed structures of the phthalocyanine greens. In practice, no single pigment consists of a specific-molecular species; rather, each pigment is a complex mixture of closely related isomeric compounds.

These pigments are ideal, since their tinctorial and fastness properties allow their use in the most severe application situations. They possess outstanding fastness to solvents, heat, light, and outdoor exposure. They can be used in masstone shades and tints down to the very palest of depths.

Phthalocyanine greens are manufactured by a three-step process: crude phthalocyanine blue is first manufactured, then halogenated to give a crude copper phthalocyanine green, and finally conditioned to give the pigmentary product.

78.3.2.2 Miscellaneous Greens

Table 78.2 gives a summary of the properties of some other commercially available organic greens that may find some minor application in the coatings industry.

TABLE 78.2 Summary of Miscellaneous Green Properties

Colour Index Name	Chemical Name	Comments
PG 1	Brilliant Green (Triphenylmethane PTMA)	Brilliant, blue shade; poor alkali and soap resistance, solvent bleed, and lightfastness; may be used in interior finishes.
PG 2	Permanent Green (Triphenylmethane PTMA)	Blend of Pigment Green 1 and Pigment Yellow 18; bright yellow shade; poor fastness overall
PG 4	Malachite Green (Triphenylmethane PTMA)	Bright, blue shade; poor fastness properties overall
PG 8	Pigment Green B (Nitroso)	Yellow shade; dull hue; poor fastness properties; may be used in interior emulsions
PG 10	Green Gold	Yellow shade; loses metal in strong acid or alkali; good lightfastness; moderate solvent fastness; used in automotive and exterior paints

TABLE 78.3 Organic Orange Pigments

Colour Index Name	Colour Index Number ^a	Chemical Type
PO 2	12060	Azo
PO 5	12075	Azo
PO 13	21110	Bisazo
PO 16	21160	Bisazo
PO 31	n/a	Bisazo condensation
PO 34	21115	Bisazo
PO 36	11780	Benzimidazolone (azo)
PO 38	12367	Azo
PO 43	71105	Perinone
PO 46	15602	Azo
PO 48	n/a	Quinacridone
PO 49	n/a	Quinacridone
PO 51	n/a	Pyranthrone
PO 52	n/a	Pyranthrone
PO 60	n/a	Benzimidazolone (azo)
PO 61	n/a	Tetrachloroisindolinone
PO 62	n/a	Benzimidazolone (azo)
PO 64	n/a	Heterocyclic hydroxy
PO 67	n/a	Pyrazoloquinazolone

^a n/a = Not assigned.

78.3.3 Organic Oranges

Table 78.3 lists the orange pigments that are available in today's marketplace. A broad subdivision can be made based on such chemical features of the molecule as azo based, benzimidazolone based, and miscellaneous oranges.

78.3.3.1 Azo-Based Oranges

The structure of the seven orange pigments that can be placed into the "azo" category are shown in [Figure 78.4](#) and are listed below:

Pigment Orange 2, Orthonitroaniline Orange, is prepared by the classical diazotization and coupling technique in which diazotized orthonitroaniline is coupled to β -naphthol. The pigment's major market is in the field of printing inks. Its use in coatings is not recommended because the pigment's solvent fastness is poor and its lightfastness inadequate.

Pigment Orange 5, Dinitroaniline Orange, is manufactured by a diazotization and coupling sequence in which diazotized dinitroaniline is coupled onto β -naphthol. This pigment offers good lightfastness in full tone and moderate solvent fastness. As such, the pigment finds widespread use in

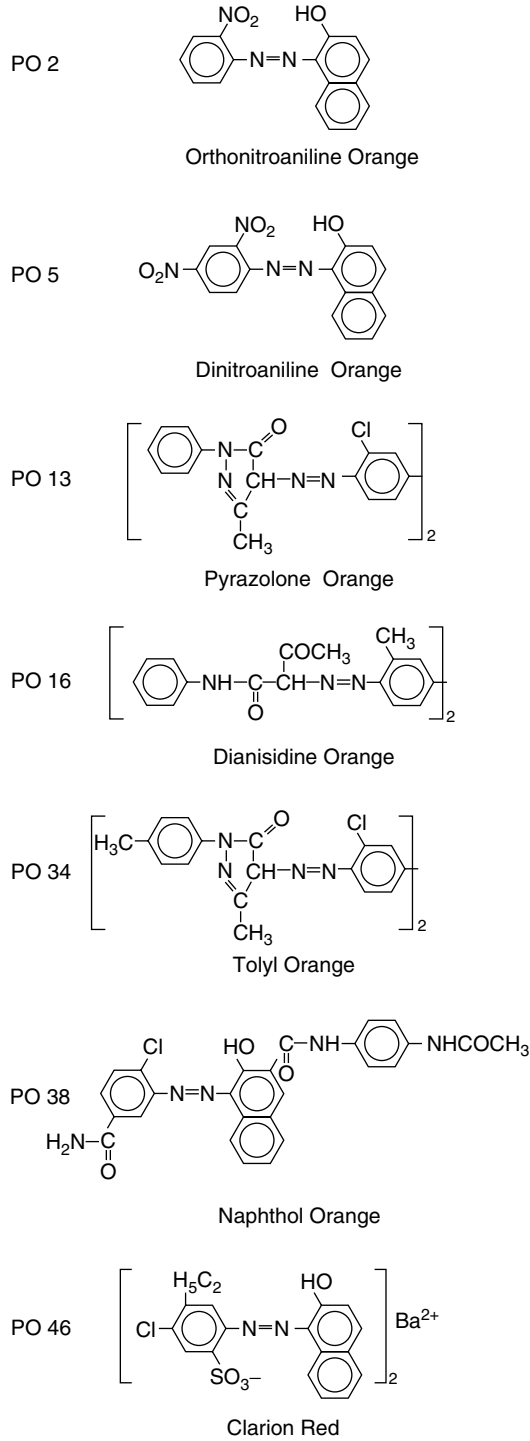

FIGURE 78.4 Structure of azo-based oranges.

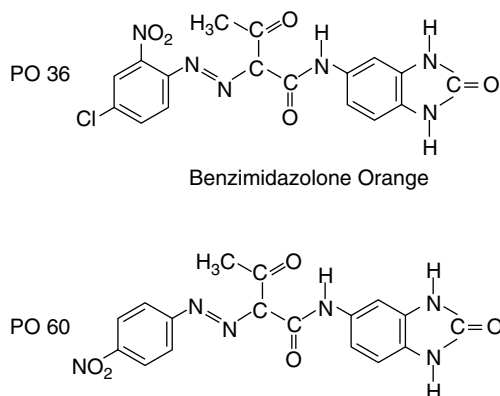

FIGURE 78.5 Structure of the benzimidazolone oranges.

latex-based paints and, with the exception of high bake enamels, in both architectural and industrial coatings.

Pigment Orange 13, Pyrazolone Orange, is synthesized by coupling tetrazotized 3,3-dichlorobenzidine onto 3-methyl-1-phenyl-pyrazol-5-one. The pigment is a bright, clean yellow-shade product that is tinctorially stronger than Pigment Orange 5. It may be recommended for interior coatings, particularly as a replacement for lead-based oranges.

Pigment Orange 16, Dianisidine Orange, is a diarylide orange that is prepared by coupling tetrazotized 3,3-dimethoxybenzidine onto acetacetanilide. The pigment finds use in baking enamels, since its heatfastness is superior to that of other orange pigments with similar economics. Usage in interior coatings at full tone levels is also recommended.

Pigment Orange 34, Toly Orange, is produced by coupling tetrazotized 3,3-dichlorobenzidine onto 3-methyl-1-(4-methyl-phenyl)-pyrazo-5-one. The pigment is a bright, reddish orange that offers moderate lightfastness and good alkali resistance, but poor solvent fastness. As such, the material is used in interior coatings applications, particularly where a lead-free formula is specified.

Pigment Orange 38, Naphthol Orange, is manufactured by coupling diazotized 3-amino-4-chlorobenzamide onto 4-acetamido-3-hydroxy-2-naphthanilide. The pigment is a bright reddish orange that exhibits excellent alkali and acid fastness, moderate solvent fastness, and acceptable lightfastness when used at full tint. As such, the pigment finds use in baking enamels, latex, and masonry paints.

Pigment Orange 46, Clarion Red, is a metallized azo pigment manufactured by coupling diazotized 2-amino-5-chloro-4-ethylbenzene-sulfonic acid onto β -naphthol and metallizing the product with barium to yield the pigment. The pigment has poor lightfastness, inferior alkali resistance, and inadequate solvent fastness, hence is not recommended for use in coatings.

78.3.3.2 Benzimidazolone-Derived Oranges

The three benzimidazolone-derived oranges contain the azo chromophore and are all based on the 5-acetoacetylaminobenzimidazolone as the coupling component.

Pigment Orange 36 is the product of coupling diazotized 4-chloro-2-nitroaniline to the benzimidazolone. Pigment Orange 60 is the product of the coupling of 4-nitroaniline to the benzimidazolone. Because of the proprietary nature of this product, the structure of Pigment Orange 62 has not been fully declared (Figure 78.5 illustrates two typical structures):

Pigment Orange 36 is a bright red-shade orange of very high tint strength. The opacified form of this pigment offers excellent fastness properties to both heat and solvents and a hue similar to the lead containing pigment, Molybdate Orange (PO 104). As such, Pigment Orange 36 finds major use in lead-free automotive and industrial high performance coatings.

TABLE 78.4 Summary of the Properties of the Miscellaneous Oranges

Colour Index Name	Common Name/Description	Properties
PO 43	Perinone	Red shade, strong, clean, vat pigment with excellent fastness properties; used in metallized finishes and high grade paints; shows slight solvent bleed
PO 48	Quinacridone Gold	Yellow shade; excellent lightfastness; lacks brightness in masstone; used in metallic finishes
PO 49	Quinacridone Deep Gold	Red shade; dull masstone; excellent durability; used in metallics
PO 51	Pyranthrone Orange	Medium shade; excellent fastness to solvent, light, and heat; dull in tin; exhibits slight solvent bleed; used in air dry and bake enamels
PO 52	Pyranthrone Orange, red shade	Vat pigment with excellent fastness to solvent, light, and heat; dull in tints; slight solvent bleed; used in air dry and bake enamels
PO 61	Tetrachloroisindolinone orange	Medium shade; exhibits some solvent bleed; used in metallic automotive finishes
PO 64	Bright shade red	Excellent solvent and lightfastness; used in industrial coatings
PO 67	Yellow shade	Excellent brilliance in full shade; good gloss retention; very good weather- and lightfastness in full shade; used in industrial and automotive coatings

Pigment 60 is a transparent, yellow-shade orange that also exhibits excellent heat and solvent fastness with an exterior durability that allows the pigment to be used in high quality industrial and automotive finishes.

Pigment Orange 62 is also a yellow-shade orange that shares the lightfastness properties of the other two oranges. Currently it is used in oil-based inks and artists' colors. Its use in the coatings industry has yet to be fully explored.

78.3.3.3 Miscellaneous Oranges

The structures of Pigment Orange 53, a pyranthrone, Pigment Orange 64, a heterocyclic hydroxy, and Pigment Orange 67, a pyrazoloquinazolone, have not been fully declared. Table 78.4 summarizes the properties of this class of pigments, which represents a series of oranges that are finding increased application in the coating industry.

78.3.4 Reds

78.3.4.1 Metallized Azo Reds

Many of the reds used in the coatings industry fall into the chemical category of azo pigments because the azo chromophore —N=N— is a feature of the molecule.

A further subdivision may be made into acid, monazo metallized pigments such as Manganese Red 2B (PR 48:4) and Calcium Lithol (PR 49:2) and nonmetallized azo reds such as the Naphthols (e.g. PR 17 and PR 23) and Toluidine Red (PR 3). Typically, each of the acid, monoazometallized pigments contains an anionic grouping such as a carboxylic (—COOH) or sulfonic acid ($\text{—SO}_3\text{H}$) group, which will ionize and react with a metal cation such as calcium or manganese to form an insoluble, metallized pigment.

Nonmetallized pigments do not contain an anionic group in their structure and, as such, will not complex with a metal cation.

All azo reds contain one or more azo groups and are produced by similar reaction sequences. The initial reaction sequence, described as diazotization, involves reacting an aromatic primary amine with nitrous acid, formed in situ by reacting sodium nitrite with hydrochloric acid at low temperatures to yield a diazonium salt. Invariably the diazonium salt that is formed by this process is unstable and should be kept cold to avoid any decomposition.

The diazonium salt is reacted quickly with the second half of the pigment, which is called the coupler. The coupling reaction takes place rapidly in the cold to yield the sodium salt of the pigment. This sodium salt is all but useless as a pigment for the coatings industry because of its marked tendency to bleed even

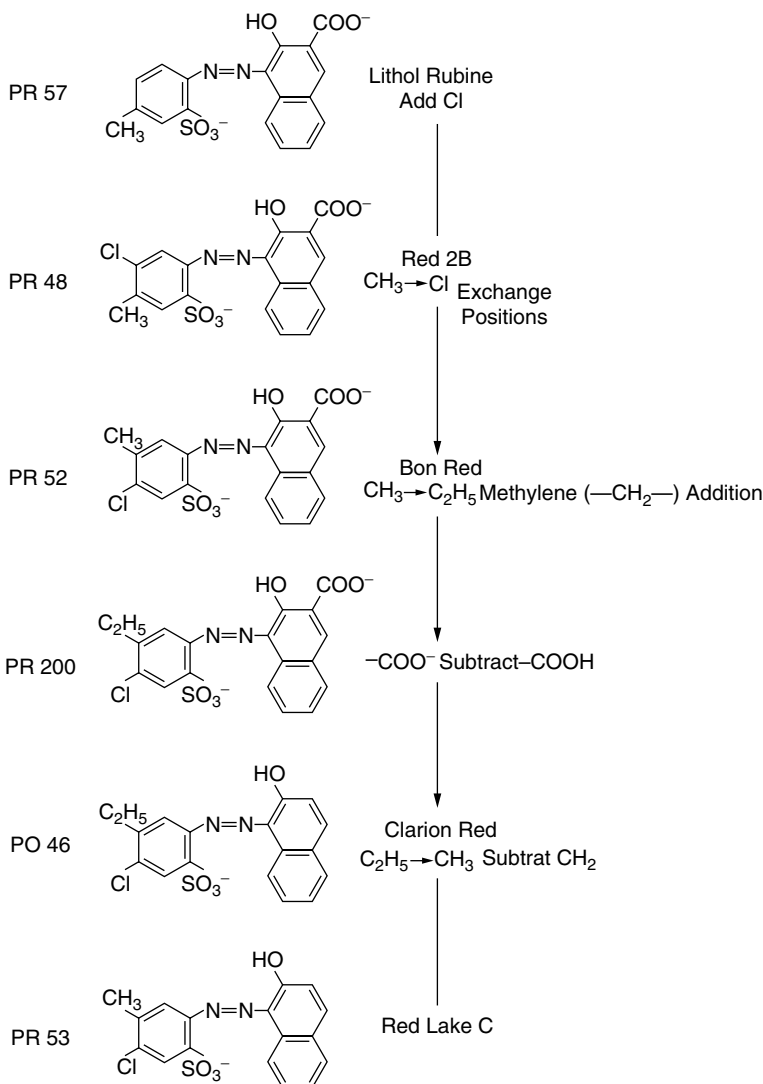

FIGURE 78.6 Metallized azo reds.

in the weakest of solvent systems. The pigment is, therefore, metallized to confer improved properties on the product. The pigment suspension is then filtered and washed to remove any residual inorganics derived from the reaction.

Figure 78.6 illustrates the structures of the different metallized azo reds that are readily available.

The *Lithol Reds* are primarily Barium Lithol (PR 49:1) and Calcium Lithol (PR 49:2). Although limited in their application in the coating industry, these pigments do find some use at masstone levels — that is, the pigment is not tinted with a white tint base — where their fastness properties are acceptable.

The pigments are bright reds with high tint strength and good dispersion characteristics. The barium salt is lighter and yellower in hue compared to the calcium salt.

Permanent Red 2B is the generic name that encompasses Barium Red 2B (PR 48:1), Calcium Red 2B (PR 48:2), and Manganese Red 2B (PR 48:4). The major use of the calcium and barium salts is in baked industrial enamels, which are not required to be fast to outdoor exposure. Use in alkaline systems is severely restricted because of the poor alkaline fastness of these salts.

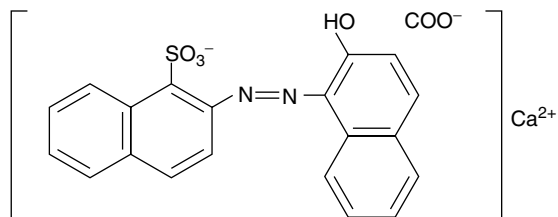

FIGURE 78.7 BON maroon.

The barium salt is characterized by a clean, yellow hue and, although slightly poorer than the bluer calcium salt in lightfastness and tinting strength, it does possess a slight advantage in bake stability.

Manganese Red 2B has a sufficiently improved lightfastness to be used in implement finishes. The manganese salt is slightly bluer, dirtier, and less intense when compared to the calcium salt.

Rubine Red also known as Calcium Lithol Rubine (PR 57:1) is a clean, blue-shade red pigment exhibiting the high tinting ability typical of the azo reds of this class. Its major use in coatings is in interior systems that call for an inexpensive red with good solvent and heat resistance. Again, to maintain maximum fastness properties, use of the pigment at near to masstone levels is recommended.

BON red, used as calcium BON Red (PR 52:1) or Manganese BON Red (PR 52:2), is characterized by outstanding cleanliness, brightness, and purity of color. The manganese salt offers a very blue-shade red with improved lightfastness compared to the calcium salt. As such, this salt is suitable for exterior coatings applications.

BON Maroon, (PR 63:1) is illustrated in Figure 78.7; the manganese salt of BON Maroon is of considerably more importance than either the calcium or barium salts. Its lightfastness is such that the pigment can be used at masstone levels for implement finishes.

78.3.4.2 Nonmetallized Azo Reds

As implied by their classification, the nonmetallized azo reds do not contain a precipitating metal cation and, as such, offer increased stability against hydrolysis in strongly acidic or alkaline environments.

Synthesis of this class of pigment follows the previously described classical method of diazotization of a primary aromatic amine followed by coupling of the resultant diazonium salt. No anionic groups capable of accepting a metal cation are present in the molecule; thus metallization is not a factor in their synthesis. Typical nonmetallized reds are Toluidine Red (PR 3) and the wide range of Naphthol Reds as represented by Pigment Reds 17, 22, and 23.

Toluidine Red is used in full shade in such coatings applications as farm implements, lawn and garden equipment, and bulletin paints, where a bright, economical red of adequate lightfastness is required. Because of the pigment's poor durability in tint shades, it is rarely used at any level other than a full shade.

The individual properties of the Naphthol Reds depend on the specific composition of the product as well as the conditioning steps used during pigment manufacture. As a class, they are a group of pigments that exhibit good tinctorial properties combined with moderate fastness to heat, light, and solvents.

Unlike the metallized azo reds, the Naphthol Reds are extremely resistant to acid, alkali, and soap. These properties lead to their use in latex emulsion systems and masonry paint.

In terms of performance and economic characteristics, the Naphthols form a link between the toluidine reds at the lower end of the scale and the perylene and quinacridone reds at the higher end.

78.3.4.3 High Performance Reds

Pigments for the exacting standards of today's automotive coatings are required to show satisfactory durability to outdoor exposure in such states as Arizona and Florida for 2 and possibly 5 years before being approved for use in automotive finishes. Similar requirements are placed on pigments chosen for use in automotive repair systems and marine coatings.

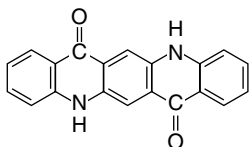

FIGURE 78.8 Structure of translinear quinacridone.

High performance reds fall into four basic classes: quinacridone reds and violets, reds based on vat dyestuffs known to include the perylene reds, reds derived from the benzimidazolone diazonium salts, and the disazo condensation reds.

78.3.4.3.1 Quinacridone Reds

Quinacridones may be described as heterocyclic pigments in that their structure comprises a fused ring structure in which the ring atoms are dissimilar. In the case of quinacridones, the ring atoms are carbon and nitrogen (Figure 78.8). Addition of differing auxochromic groups such as methyl ($-\text{CH}_3$) and chlorine ($-\text{Cl}$) gives Pigment Red 122 and Pigment Red 202, respectively.

The two most commercialized routes in the synthesis of quinacridone (PV 19) involve either the oxidation of dihydroquinacridone or the cyclization of 2,5-diarylamino-terephthalic acid as outlined in Figure 78.9. Subsequent conditioning leads to the desired crystal modification. Use of 2,5-diarylamino-

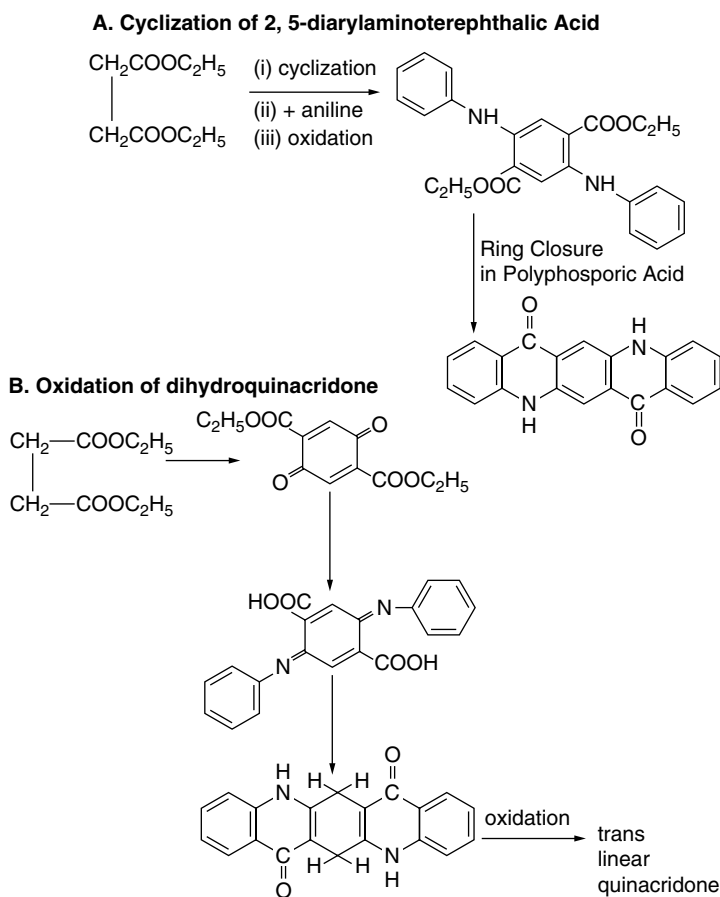

FIGURE 78.9 Routes to quinacridone.

TABLE 78.5 Types of Quinacridone

Colour Index Name	Hue	Comments
PO 48	Gold	Quinacridone quinone
PO 49	Deep Gold	Quinacridone quinone
PR 122	Magenta-yellow	2,9-Dimethyl quinacridone
PR 192	Red-yellow	Unsymmetrical monomethyl quinacridone
PR 202	Magenta-blue	2,9-Dichloroquinacridone
PR 206	Maroon	Mixed solid solution
PR 207	Scarlet	4,11-Dichloroquinacridone
PR 209	Yellow-shade red	3,10-Dichloroquinacridone
PV 19	Violet-blue	β -Quinacridone
	Red-yellow	γ -Quinacridone
PV 42	Maroon	Mixed solid solution

terephthalic acid at the cyclization stage yields the unsubstituted trans linear quinacridone. Use of 2,5-ditoluidinoterephthalic acid yields the 2,9-dimethyl quinacridone, Pigment Red 122.

As a group of high performance pigments, quinacridones find their primary uses in automotive finishes, both metallic and solid shades, industrial finishes, and exterior finishes.

The pigments combine excellent tinctorial properties with outstanding durability, solvent fastness, lightfastness, heatfastness, and chemical resistance. Table 78.5 lists the shades currently available.

78.3.4.3.2 Vat Reds

The red pigments, based on anthraquinone, include such structures as Anthraquinone Red (PR 177), Perinone Red (PR 194), Brominated Pyranthone Red (PR 216), and Pyranthone Red (PR 226), as illustrated in Figure 78.10.

These anthraquinone-derived pigments are manufactured via a series of complex reactions to include such processing as sulfonation, nitration, halogenation, condensation, and substitution.

78.3.4.3.3 Perylene Reds

Perylene reds provide pure, transparent shades and novel styling effects when used in metallic finishes. These pigments offer improved flow characteristics when used in highly pigmented coatings formulations such as those required for high solids base coat/clear coat systems, as well as high transparency and good bleed resistance.

The perylenes possess high color strength, good thermal stability, excellent light- and weatherfastness and, with the exception of Pigment Red 224, excellent chemical resistance.

Perylenes may also be described as vat pigments and in fact are the only class of vat pigments to be specifically developed as pigments rather than as dyestuffs. Almost all the perylene pigments have a structure as shown by the generic formula illustrated in Figure 78.11; that is, they are based on *N,N*-substituted perylene-3,4,9,10-tetracarboxylic diimide. A notable exception is Pigment Red 224 (Figure 78.12), which is actually derived from the perylene tetracarboxylic dianhydride.

Acenaphthene is oxidized to 1,8-naphthalic anhydride followed by ammoniation to yield the naphthalimide. The naphthalimide is condensed in a fused caustic medium to yield the perylene-3,4,9,10-tetracarboxylic acid diimide. The diimide can then be conditioned to convert the crude into pigment and achieve Pigment Violet 26, or methylated to give Pigment Red 179.

The diimide may be hydrolyzed to produce the dianhydride, Pigment Red 224, or condensed with various aromatic or aliphatic amines to give such pigments as those featured in Figure 78.13. As with many of the pigments already described, the perylenes have to be conditioned to obtain the compounds in a pigmentary form.

78.3.4.3.4 Thioindigo Reds

The thioindigoid chromophore serves as a nucleus for a wide range of red to violet pigments. The thioindigo reds include Pigment Reds 36, 87, 88, 181, and 198. These pigments are noted for their

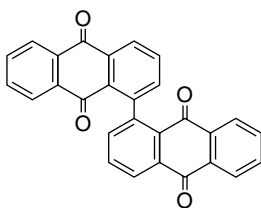

Anthraquinone Red (PR 177)

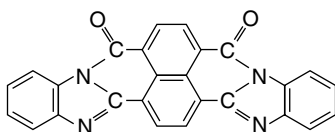

Perinone Red (PR 194)

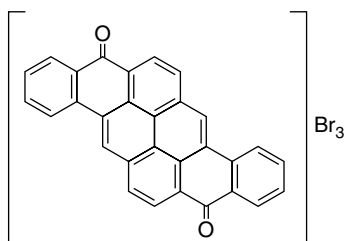

Brominated Pyranthrone Red (PR 216)

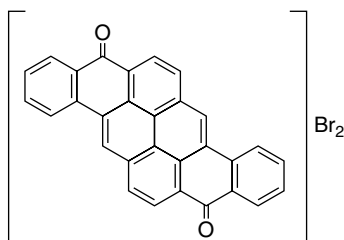

Pyranthrone Red (PR 226)

FIGURE 78.10 Structure of translinear quinacridone.

brightness of shade and all-around good fastness properties. These properties have resulted in the use of the thioindigoes in quality coatings; Pigment Red 88 is the prime pigment, followed by Pigment Red 198.

78.3.4.3.5 Benzimidazolone-Based

The benzimidazolone pigments feature Pigment Reds 171, 175, 176, 185, and 208. These pigments are azo-based compounds that contain the benzimidazolone structure as part of their coupling component.

Although used primarily for the coloring of plastics because of their outstanding thermal stability, this class of pigments does find application in the coatings industry. Benzimidazolones show excellent fastness to light, good weatherability, and excellent fastness to overspraying at elevated temperatures. The benzimidazolone pigments are prepared using the diazotization and coupling techniques described earlier.

Generally, after the coupling process, the pigment is treated to obtain a uniform, controlled crystal growth and particle size distribution.

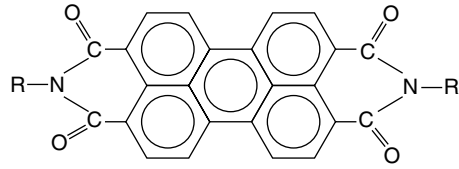

R = $-\text{C}_6\text{H}_3\text{OC}_2\text{H}_5$

R = $-\text{C}_6\text{H}_3(\text{CH}_3)_2$

R = $-\text{CH}_3$

R = $-\text{C}_6\text{H}_5\text{OCH}_3$

R = $-\text{H}$

R = $-\text{C}_6\text{H}_5\text{Cl}$

R =

PR 123 Vermillion

PR 149 Scarlet

PR 179 Maroon

PR 190 Red

PBr 26 Bordeaux

PR 189 Yellow Shade Red

PR 178 Red

FIGURE 78.11 Perylene structures.

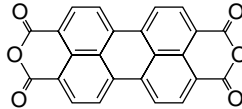

FIGURE 78.12 Pigment Red 224.

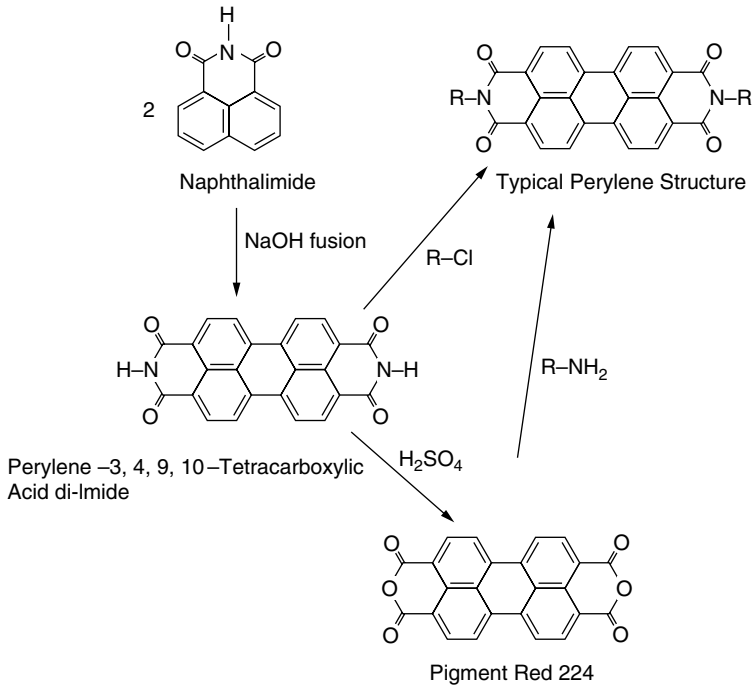

FIGURE 78.13 Perylene synthesis.

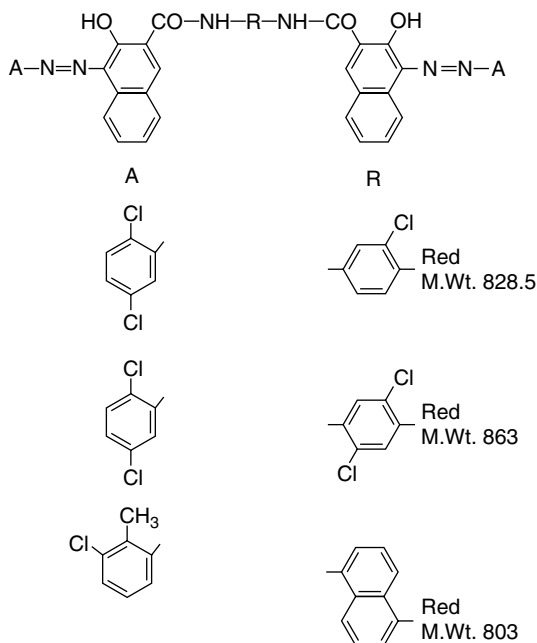

FIGURE 78.14 Structures of the disazo condensation reds.

78.3.4.3.6 Disazo Condensation Reds

These pigments feature such properties as high tinctorial strength and fastness to solvents and heat. Disazo condensation reds have found considerable use as replacement pigments for lead containing pigments. Their outstanding fastness properties have resulted in their use in high quality industrial finishes.

Figure 78.14 illustrates three typical structures of the disazo condensation reds. Colour Index names for these three pigments have not been assigned. The synthesis sequence generally is similar for each of the disazo condensation pigments. The azo components are initially coupled to yield monoazo dyestuff carboxylic acids, which are converted to acid chlorides before final conversion to the disazo by condensation with the arylide component to yield the pigment in question.

78.3.4.3.7 Miscellaneous High Performance Reds

In recent years a number of novel high performance reds have been commercialized by such companies as Sandoz and BASF. New from Sandoz are Pigment Reds 242, 214, and 257.

Pigment Red 242 is shown in Figure 78.15. The product is a yellow-shade red with a clean bright shade and very good all-around fastness properties. It is recommended for lead-free coatings formulations for the production of high quality finishes and bright red shades.

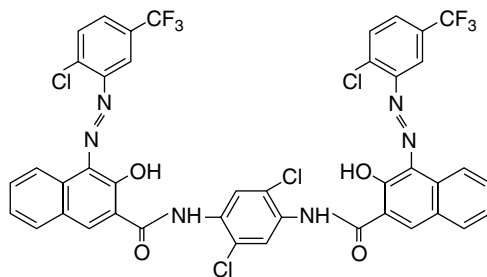

FIGURE 78.15 Structure of Pigment Red 242.

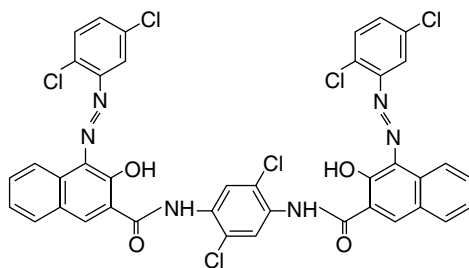

FIGURE 78.16 Structure of Pigment Red 214.

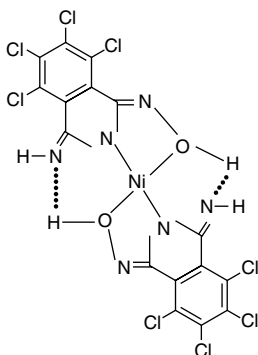

FIGURE 78.17 Structure of Pigment Red 257.

Pigment Red 214 (Figure 78.16) is a bluish red with properties similar to those of Pigment Red 242.

Pigment Red 257 (Figure 78.17) is a nickel complex pigment with a red violet masstone and a magenta undertone; its fastness properties are similar to those of the quinacridone pigments.

78.3.5 Organic Yellows

Yellow pigments can be subdivided into four broad classifications based on their chemical constitution. These classifications are comprised of monoarylide yellows, diarylide yellows, benzimidazolone yellows, and heterocyclic yellows.

78.3.5.1 Monoarylide Yellows

Monoarylide yellows are all azo pigments; their manufacture is based on the diazotization procedure, followed by coupling. The structures of the major monoarylide yellows are represented in Figure 78.18.

Pigment Yellow 1 is often referred to as Hansa Yellow G for historical reasons. This pigment is a bright yellow that finds outlets in trade sales, emulsion, and masonry paints. The pigment's major drawbacks are its poor bleed resistance, poor lightfastness in tint shades, and markedly inferior bake.

Pigment Yellow 3, referred to as Hansa Yellow 10G, is a pigment that is considerably greener and cleaner than Pigment Yellow 1. The pigment finds a market in trade sales, water-based emulsions, and masonry paints. The pigment suffers from the same deficiencies of poor bleed resistance and poor tint lightfastness exhibited by Pigment Yellow 1. Pigment Yellow 3 is, however, suitable for exterior use at high tint strength.

Pigment Yellow 65 is a monoarylide yellow that finds use in trade sales, latex, and masonry paints. The pigment offers a lightfastness in full shade of 7 and 6–7 in tint, a considerable improvement over Pigment Yellow 1.

Pigment Yellow 73 is a pigment close in shade to Pigment Yellow 1 which again finds use in trade sales, latex, and masonry paints. It is not, however, considered to be durable enough for exterior applications.

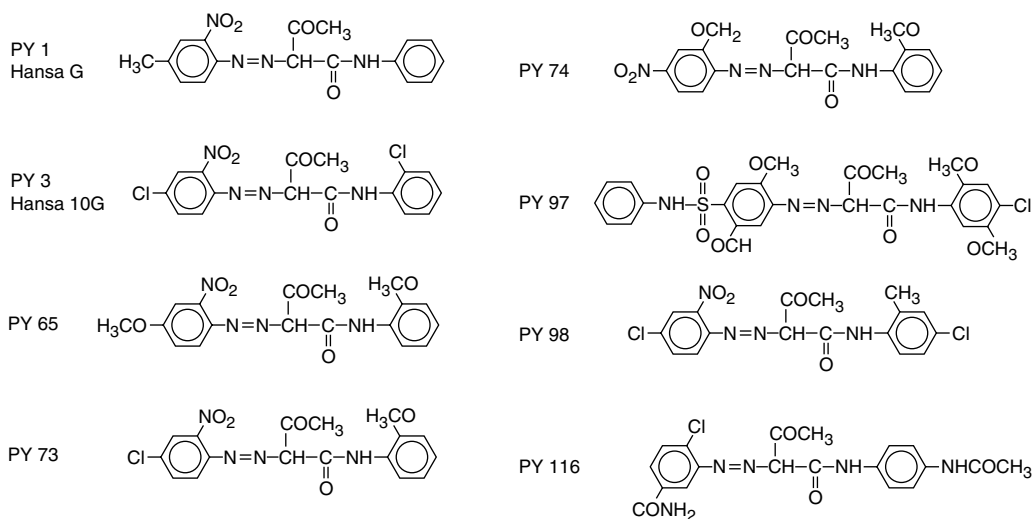

FIGURE 78.18 Monoarylide yellow structures.

Pigment Yellow 73 plays an important role in interior, intermix systems because of its stability against recrystallization in the presence of glycols and wetting agents as used in aqueous systems.

Pigment Yellow 74 offers the user a pigment that is suitable for outdoor applications and considerably stronger and somewhat greener than Pigment Yellow 1. Again usage in trade sales, latex, and masonry paints is widespread.

Pigment Yellow 97 is a newer pigment that shows the advantages associated with a smaller particle size, less agglomeration, and an improved particle size distribution when compared to the other monoarylide yellows. Pigment Yellow 97 gained significant use in trade sales applications primarily because it was available when demands for lead-free formulations were increasing. Additionally, the pigment finds use in high quality decorative paint.

Pigment Yellow 98 is a pigment that has met with only limited commercial success to date. The pigment is similar in shade to Pigment Yellow 3 but is considerably stronger and more heat stable; it finds use in trade sales, masonry, and latex-based paints.

Pigment Yellow 116 is a pigment similar in shade to light chrome yellow (PY34). Pigment Yellow 116 exhibits improved chemical resistance compared to the other monoarylide yellows, showing improved fastness to solvent, heat, and light. Its major area of use is currently in the formulation of lead-free coatings.

In summary, the monoarylide yellows constitute the most important class of organic yellows as consumed by the coatings industry. Because of the absence of any lake forming groups (e.g., —COOH or —SO₃H) in their structure, they possess excellent alkali fastness, which enables them to be used in all major aqueous paint formulations. Additionally, when compared to their inorganic lead containing counterparts, the chrome yellows, the monoarylides offer considerably higher tinting strength, bright yellow hue of high chrome, and less tendency to darken on exposure to atmospheric pollutants.

78.3.5.2 Diarylide Yellows

Figure 78.19 illustrates the structure of the diarylide yellows, and Table 78.6 presents a summary of the properties of this class of yellows.

Basically, an inspection of the structures indicates that this class of yellows has a backbone structure that hinges on 3,3-dichlorobenzidine with properties that differ depending on the nature of the coupling component. Properties that are common features of this group of yellows are low cost, reasonable heat stability, and moderate chemical resistance.

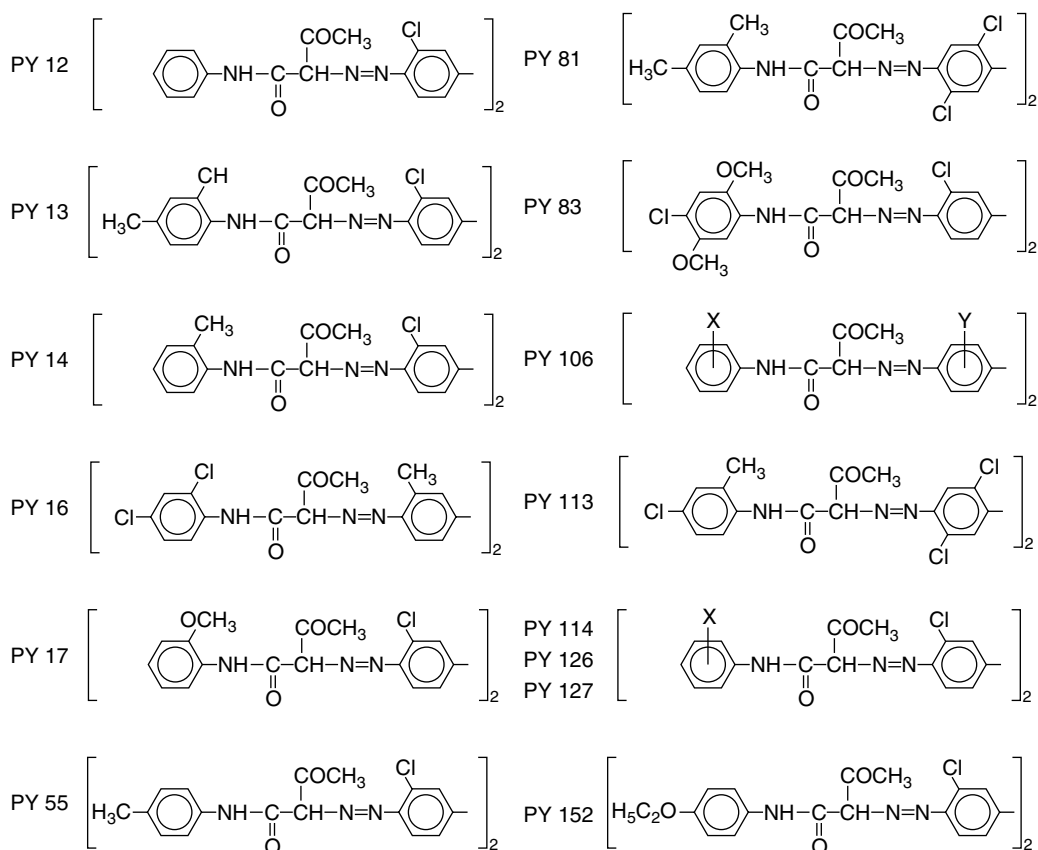

FIGURE 78.19 Diarylide yellow structures.

The major market for the diarylide yellows is the printing ink industry. The diarylide yellows are approximately twice as strong as the monoarylide yellows; additionally they offer improved bleed resistance and fastness to heat. However, none of the diarylide yellows has durability adequate for the pigment to be considered in exterior coatings applications; thus the diarylide yellows should not be used in any outdoor situations.

78.3.5.3 Benzimidazolone Yellows

Figure 78.20 illustrates the structure of the organic yellows that fall into the classification of benzimidazolone yellows because each is an azo pigment derived from 5-acetoacetyl-aminobenzimidazolone.

The exceptional fastness to heat and the excellent weatherfastness of this class of pigments are attributed to the structural presence of the benzimidazolone group.

Used initially for coloring plastics, these pigments are finding increased use in coatings systems, where their excellent weatherfastness, heat stability, and fastness to overstripping are required (e.g., when formulating high quality industrial finishes). Table 78.7 gives a summary of the properties of the benzimidazolone yellows.

78.3.5.4 Heterocyclic Yellows

This class of pigments contains an assortment of yellows that all contain a heterocyclic molecule in their structure as presented in Figure 78.21. In spite of the apparent degree of complexity in the synthesis of such structures, these new high performance pigments continue to be introduced into the marketplace

TABLE 78.6 Summary of Diarylide Yellow Properties

Colour Index Name	Common Name ^a	Comments
PY 12	AAA Yellow	Poor lightfastness; poor bleed resistance; major use in printing inks
PY 13	MX Yellow	Redder shade than PY 12; improved heat stability and solvent fastness; major use in printing inks
PY 14	OT Yellow (274–1744)	Green shade; some use in interior finishes; poor tint lightfastness
PY 16	Yellow NCG	Bright green shade; improved heat and solvent fastness; used in full shade for coatings
PY 17	OA yellow (275–0562)	Green shade; some use in interior finishes; poor lightfastness
PY 55	PT Yellow	Red shade; some use in interior finishes; poor lightfastness; isomer of PY 14
PY 81	Yellow H10G	Bright, green shade; same shade but much stronger than PY 3
PY 83	Yellow HR (275–0570) (275–0050)	Very red shade; improved transparency, heat stability, and lightfastness over PY 12; some use in interior finishes
PY 106	Yellow GGR	Green shade; poor tint lightfastness; major use in packaging inks
PY 113	Yellow H10G	Very green shade; more transparent than PY 12 and offering better heat and solvent fastness; some interior finish use
PY 114	Yellow G3R	Red shade; improved solvent and lightfastness over PY 12; major use in oil-based inks
PY 126	Yellow DGR	Similar shade to PY 12 but offering improved heat and solvent fastness; major use in printing inks
PY 127	Yellow GRL	Bright, red shade; poor lightfastness; major use in offset inks
PY 152	Yellow YR	Very red, opaque product; poor lightfastness; some use in interior finishes as a lead chrome replacement

^a Numbers in parentheses are codes used by Sun Chemical Corporation.

to fulfill the exacting demands of the consuming industries. Compounds such as Isoindoline Yellow (PY 139) and Quinophthalone Yellow (PY 138) are particular examples of such complex, novel pigments.

All these yellows offer the user additional high performance pigments that find applications in high quality coatings, where the end use can justify the economics of purchasing. [Table 78.8](#) summarizes the properties of these heterocyclic pigments.

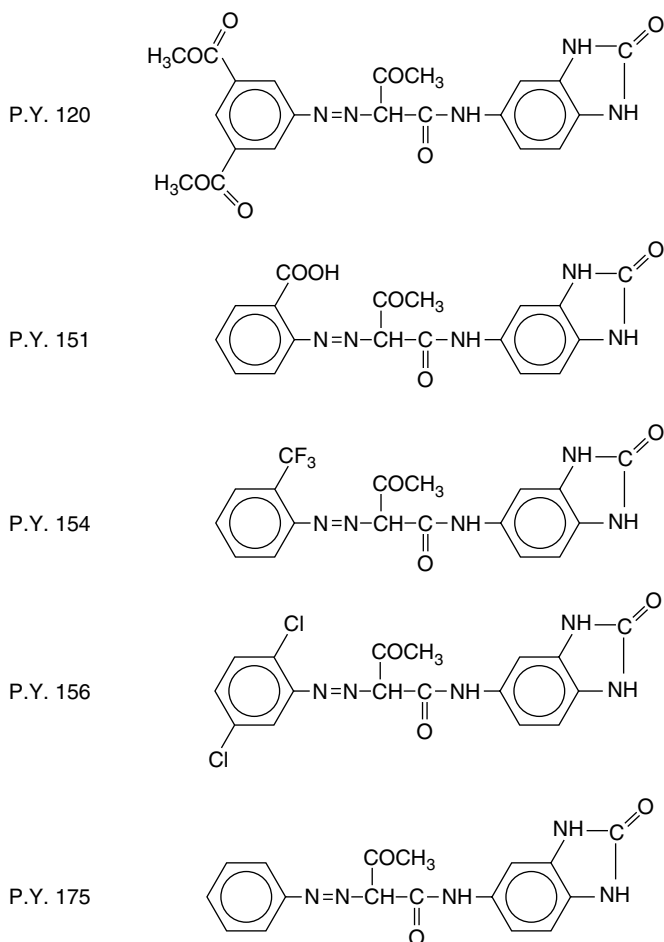

FIGURE 78.20 Benzimidazolone yellow structures.

TABLE 78.7 Summary of Benzimidazole Yellow Properties

Colour Index Name	Common Name	Comments
PY 120	Yellow H2G	Medium shade; good solvent fastness; excellent lightfastness; used in industrial finishes
PY 151	Yellow H4G	Greener shade; good solvent fastness; excellent lightfastness; industrial and refinish applications
PY 154	Yellow H3G	Green shade but redder than PY 151; good solvent fastness; excellent lightfastness; industrial and automotive refinish applications
PY 156	Yellow HLR	Redder shade; transparent; good exterior durability in full shade and tint; all exterior coatings and refinish applications
PY 175	Yellow H6G	Very green shade; good solvent fastness; excellent lightfastness; all exterior coatings and refinish applications

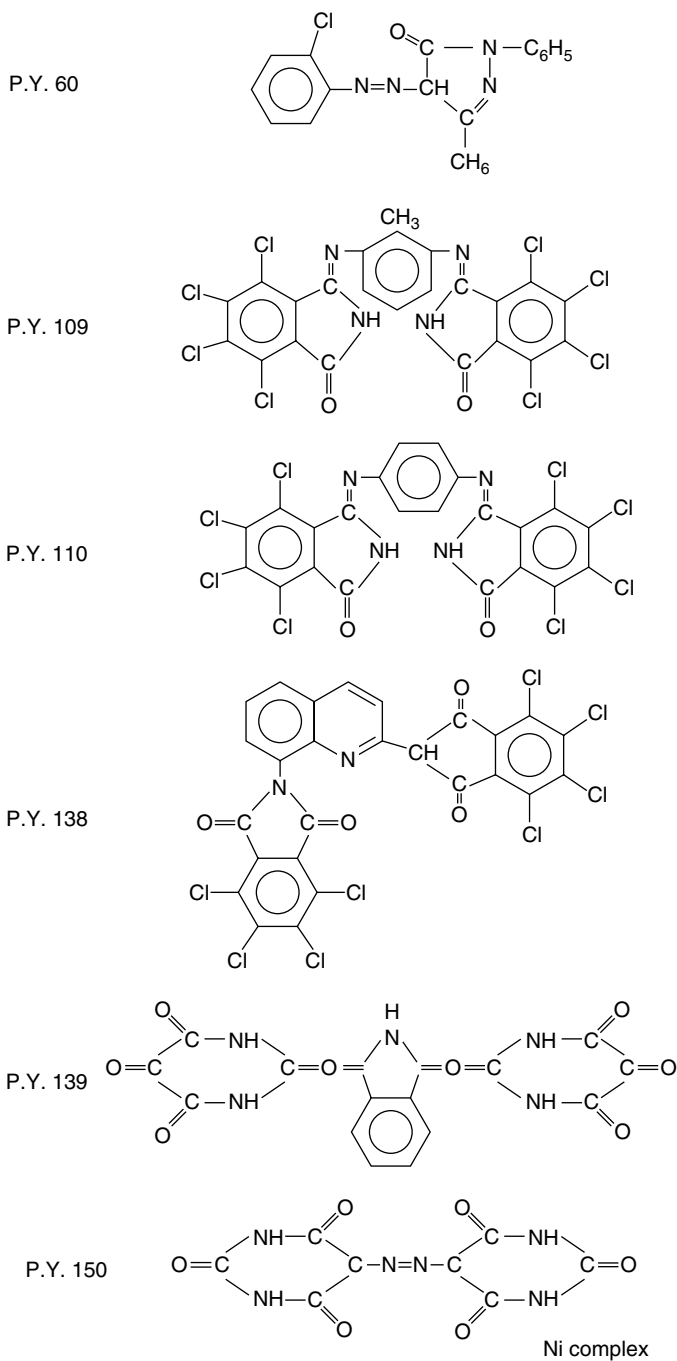

FIGURE 78.21 Structure of heterocyclic yellows.

TABLE 78.8 Summary of the Properties of the Heterocyclic Yellows

Colour Index Name	Common Name/Description	Comments
PY 60	Arylide Yellow	Very red shade; moderate light and solvent fastness; trade sales, latex and masonry paints; good acid and alkali fastness
PY 101	Methine Yellow	Bright yellow; highly transparent and exceptionally brilliant; industrial finishes and specialty coatings; only moderate bleed and alkali fastness
PY 109	Tetrachloroisindoline	Green shade; excellent brightness strength and durability; automotive finishes
PY 117	Greenish yellow complex of an azomethine	Excellent chemical, light, and heat fastness; specialty finishes
PY 129	Azomethine Yellow	Very green shade; excellent overall fastness; industrial and specialty coatings
PY 138	Green shade quinophthalone	Clean hue and excellent overall fastness properties; high quality industrial and automotive finishes
PY 139	Red-shade isoindoline	Similar in masstone to medium chrome (PY 34); excellent light and solvent fastness; industrial and automotive coatings
PY 150	Pyrimidine Yellow	Very green shade; good heat and lightfastness; industrial coatings
PY 153	Red-shade Nickel Dioxine	Excellent fastness properties; specialty coatings and baking enamels; poor acid resistance
PY 155	Azo Condensation Yellow	Green shade; excellent overall fastness properties in full shade; industrial and specialty coatings
PY 173	Isoindolone Yellow	Very green shade; excellent fastness properties; industrial and specialty finishes
PY 182	Triazinyl Yellow	Medium shade; excellent fastness properties at masstone levels; industrial finishes

79

Amino Resins

79.1	Introduction	79-1
	History	
79.2	Amino Resin Synthesis and Background.....	79-2
	Urea-Formaldehyde Resins • Melamine-Formaldehyde Resins	
79.3	Coatings	79-3
	Film Formation — Cross-Linking • Catalysts • Automotive Coatings — Clear Coats	
79.4	Other Amino Resins.....	79-6
79.5	Future Trends.....	79-6
	References	79-6

George D. Vaughn*
Surface Specialties Melamines

79.1 Introduction

Amino, or aminoplast, resins are an important class of cross-linkers for industrial coatings.¹⁻⁵ Amino resins are usually water-white, viscous materials that may contain added solvent to reduce viscosity for ease of handling. Most amino resins do not consist of a single chemical entity but are mixtures of monomeric and oligomeric molecules. Properties of the resin are dictated by the amount of each molecule type present in the mixture. These resins are used in thermoset and ambient cure systems. [Figure 79.1](#) shows various types of amino resin precursors. The amino resins are made by reacting these precursors with formaldehyde ($\text{CH}_2=\text{O}$) and then with primary alcohols (ROH). The resulting ether is $>\text{NCH}_2\text{OR}$. Of these, the melamine-formaldehyde (MF) and urea-formaldehyde (UF) resins are the most widely used commercially.

This chapter will focus on the chemistries of the melamine and urea molecules. A short summary of the other resin systems is included at the end of the chapter.

79.1.1 History

The first amino resins used in coatings were made from the reaction of urea or melamine with formaldehyde followed by butanol (either *n*- or iso-). They were essentially polymeric and therefore were offered at 50 to 60% solids in butanol/xylene mixtures. These have been commercially available for nearly 70 years.⁵

The higher solids (80 to 100%) amino resins have been available for about 40 years. These are made with either methanol only or mixtures of methanol and other primary alcohols. These higher solids resins are now more important industrially because of the many regulations put in place, by government mandates, to reduce the level of volatile organic compounds (VOCs)⁶ emitted by paints.

* Current affiliation: Cytec Surface Specialties.

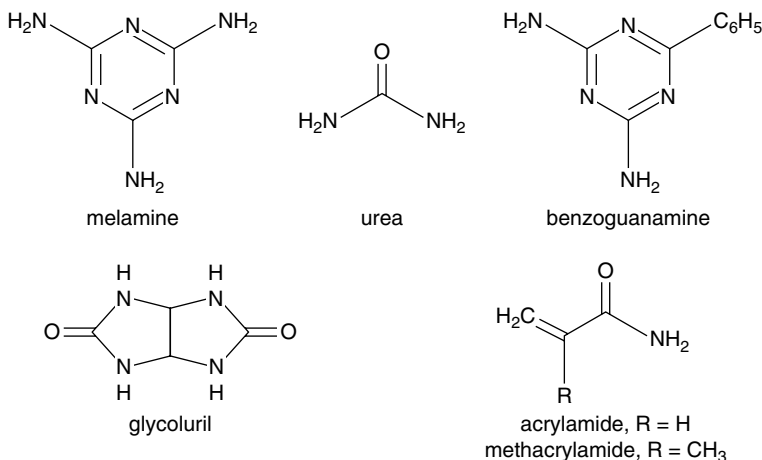

FIGURE 79.1 Amino resin precursors.

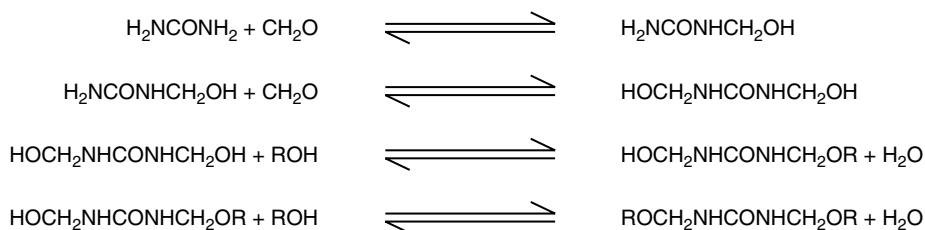

FIGURE 79.2 Urea-formaldehyde resin synthesis.

79.2 Amino Resin Synthesis and Background

79.2.1 Urea-Formaldehyde Resins

The equations shown in Figure 79.2 represent the stepwise synthesis of UF resins. All four reactions are equilibrium driven. The first two can be catalyzed by acid or base. The second two are acid catalyzed. The extent of reaction is dependent upon the raw material charges and catalyst ratios and, additionally, for the third and fourth reactions, the extent the water is removed from the reaction.

79.2.2 Melamine-Formaldehyde Resins

The reactions used to generate MF resins are analogous to those illustrated above. The notable exception is that only two of the four available hydrogens on the urea molecule are easily substituted, whereas all six hydrogens on the melamine molecule are available for substitution.

Figure 79.3 shows all the possible bonding combinations for a MF resin. Present are imino (>NH), methylol (>NCH₂OH), alkoxyethyl (>NCH₂OR), acetal (>NCH₂OCH₂OR), methylene bridge (>NCH₂-), and methylene ether bridge (>NCH₂-O-CH₂-) groups. The last two bonding modes contribute to oligomeric species. Conventional MF resins consist of monomers and oligomers of melamine with a mixture of the possible functional groups. The amount of oligomers formed depends on the reaction conditions.

79.2.2.1 Types of High-Solids Melamine-Formaldehyde Resins

This section will include resins with solids at ≥80%. One unique class of MF resins (partially acrylated) can participate in a dual-cure, ultraviolet (UV)/thermal process.⁷

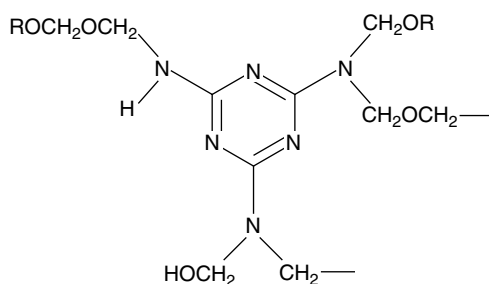

FIGURE 79.3 Functional groups in typical MF resins.

79.2.2.1.1 Highly Methylated MF Resins

Formulations made with these resins, composed of methoxy ether groups only, cure faster than either those composed of methoxy–alkoxy groups or other alkoxy groups only. They can cure at temperatures down to 60°C (140°F).⁸ Some wood coatings use ambient cure conditions. Specific acid catalysts are used for cure (see Section 79.3.2). These resins can be used in waterborne (WB) coatings and normally have a longer shelf-life than WB formulations made with high imino-containing resins.

79.2.2.1.2 Imino-Containing MF Resins⁴

These resins can be formulated to cure at temperatures of ~110°C (230°F) with no catalysts. When catalysts are required, general acid catalysts are chosen (see Section 79.3.2). A high level of self-condensation of the MF resin is responsible for the cure response. Because of the self-condensation, coatings made with these resins are harder and more brittle. These resins can be used in waterborne coatings.

79.2.2.1.3 Methoxy-Butoxy MF Resins⁴

Formulations made with these resins show improved flow and leveling properties, and the cured systems demonstrate enhanced adhesion characteristics, and telegraphing resistance. Specific acid catalysts are used for cure (see Section 79.3.2).

79.3 Coatings

Urea-formaldehyde resins are used in formulations for wood (board, kitchen cabinet), paper, and some coil and general industrial coatings. Most applications are for interior finishes, because UF coatings have sensitivity to hydrolysis and have poor exterior UV durability.

Melamine-formaldehyde resins are more widely used. Coatings made with MF resins have better chemical resistance and demonstrate better exterior durability. In addition to the coating applications listed for UF resins, MF resins can be used in container, automotive, and appliance coatings.

Even though MF resins provide better stain and water resistance in coatings versus UF resins, UF resins are used in wood coatings because they can be cured with little or no heat. They also are generally less expensive than MF resins.

79.3.1 Film Formation — Cross-Linking

Urea-formaldehyde and MF resins can undergo self-condensation. Figure 79.4 shows how MF resins can self-condense. In addition to water, alcohols may also be evolved. Industrial baking finishes must possess flexibility exceeding that of self-condensed amino resins alone.^{1–5} Therefore, the coreactant must introduce flexibility. The common resin types employed are acrylics, alkyds, and polyesters. These resins must possess functionality that will react with the amino resins. The principal functionalities are primary and secondary hydroxyl, carboxyl, carbamate,⁹ and amide. The reaction of the cross-linker with the coreactant is called cocondensation (Figure 79.5). Both self-condensation and cocondensation reactions are catalyzed by acid (see Section 79.3.2).

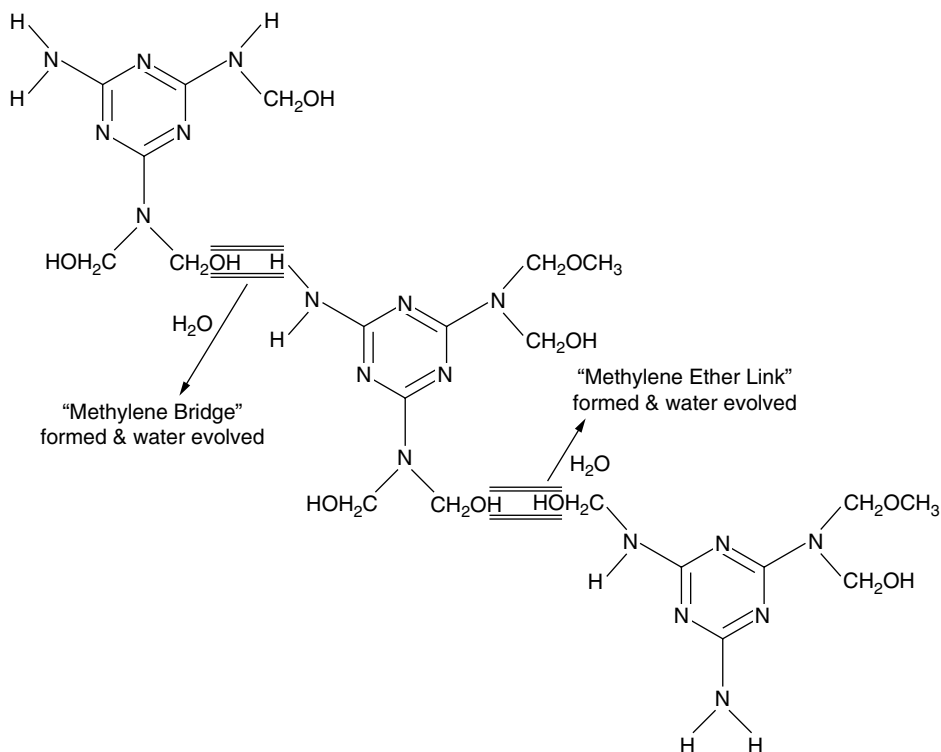

FIGURE 79.4 Self-condensation cure by MF resins.

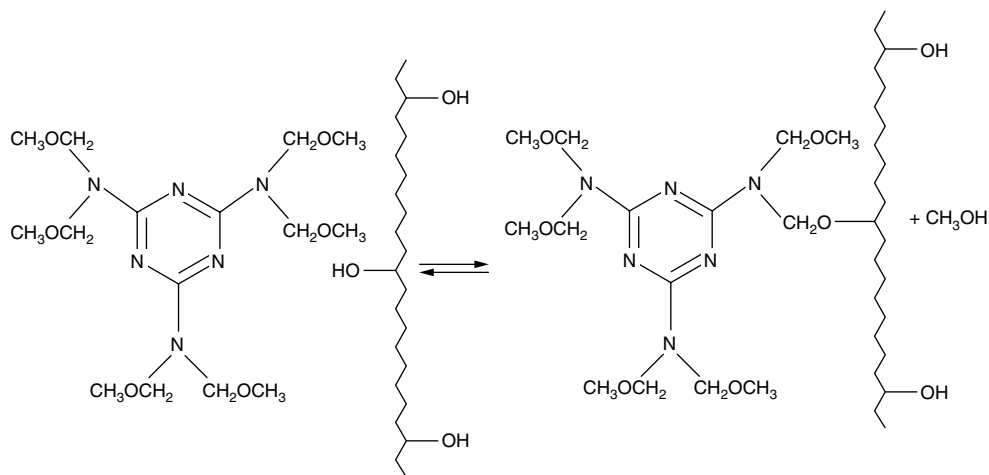

FIGURE 79.5 Cure by transesterification of a MF resin and a hydroxyl functional coreactant.

79.3.2 Catalysts

Many researchers have studied the role that the catalyst plays in coating performance.^{10,11} The type of catalysis has been divided into two categories: *general* and *specific*. Weak acids, such as carboxylic and phosphoric, can be used to initiate the cure, under certain conditions. When the conditions are met, this type of cure is called general acid catalyzed. When a strong acid, such as an organic sulfonic acid or hydrochloric acid, is used, the cure is designated specific acid catalyzed. The cure temperature also plays

a major role. For MF resin systems, low temperature [$<110^{\circ}\text{C}$ (230°F)] cures can only be achieved with specific acid catalysts. Examples will be given in later sections.

Besides cure, the catalyst also influences the coating's durability. Too much residual acid will accelerate the coating's degradation, especially when exterior durability is a key property. Therefore, an optimum level of acid, and its composition, must be determined experimentally in every case.

79.3.2.1 Sulfonic Acid Catalysts

Sulfonic acids are the most widely used catalyst type. There are aliphatic and aromatic sulfonic acids commercially available. Methanesulfonic acid should be a good choice for many applications, but early versions were likely high in sulfuric acid. This caused hydrolysis problems and yellowing of coatings in which it was tested. *p*-Toluenesulfonic acid (*p*-TSA) is by far the most used acid because of cost, and because it can be easily purified (white crystalline solid). However, in the most demanding coating applications where long-term exterior exposure must be achieved, other acids are preferred. Two worth mentioning are mixed isomers of dodecylbenzenesulfonic acid (DDBSA) or dinonylnaphthalenedisulfonic acid (DNNDSA).¹² Both are more hydrophobic than *p*-TSA, and thus, they contribute less to film failures caused by water absorption.

79.3.2.2 Paint Stability¹³

79.3.2.2.1 Blocked Catalysts

Blocked catalysts are used so that the catalyzed paint has a reasonable shelf life. Amines are used extensively as blocking agents. At room temperature, in the paint, the amine is protonated by the acid catalyst, thus reducing the acidity of the system. When the paint is applied, the amine will volatilize, because the blocking reaction is an equilibrium process. This allows the cross-linking to begin. Oven cures are normally used when blocked catalysts have been employed. The choice of the amine is critical to coating performance. Some amine/acid combinations are not usable because the amine/acid complex may not be soluble in the formulation. Depending on the cure temperature, certain amines may volatilize too quickly and can cause severe wrinkling in the coating. This effect is due to a differential cure throughout the thickness of the coating. The concentration of the amine is lowest at the surface, so it cures faster than the interior, thus leading to a wrinkled appearance.^{14,15} Other amines, such as 2-amino-2-methylpropanol (AMP) can cause auxiliary cross-linking.¹⁶

These amine-blocked catalysts are ionic (charged species) in character. Another type is covalently blocked.¹⁷ The advantage of this type is that it can be used in electrostatic spray equipment where the paint should have low conductivity. However, covalently blocked catalysts require a cure temperature 110°C (230°F) to deblock. Certain amine blocked systems deblock at 65°C (149°F).

79.3.2.2.2 Primary Alcohols

Note in [Figure 79.5](#), the by-product of the cross-linking is alcohol formation. A few percent of a primary alcohol in the formulated paint can prolong the stability of the system. The added alcohol effect can be explained by Le Châtelier's principle (when an equilibrium system is perturbed, the equilibrium will always be displaced in such a way as to oppose the applied change). Methanol would be the best choice because it would volatilize the fastest, however, it is also flammable. Most formulators choose butanol as the retarder. Added alcohol, along with a blocked catalyst, provides systems with the highest stability. It is worth noting that four times more *n*-butanol and more amine were required to stabilize a paint made with a 55% solids partially butylated MF resin than was required when a high-solids hexamethoxymethylmelamine (HMMM) was used.¹⁸

79.3.3 Automotive Coatings — Clear Coats

This topic could fill a book in itself. Melamine-formaldehyde resins impart characteristics such as superior distinctness-of-image (DOI), high gloss, and excellent mar resistance to automotive clear coats. There has been some partial replacement of MF resins with isocyanate cross-linkers, because coatings made with MF resins do not achieve the same level of acid-etch resistance.^{19,20} Vaughn et al. reviewed acid-etch

testing and described a straightforward accelerated test.²¹ This accelerated test is supposed to mimic a coating exposed to acid rain. However, when mar resistance is the issue, coatings made with MF resins substantially outperform isocyanate systems.^{22,23}

79.4 Other Amino Resins

Benzoguanamine resins impart flexibility and superior resistance to alkali and alkaline detergent resistance versus MF resins. They also produce flexible coatings. They cost more than MF resins and have poorer UV durability, so they are used only when the above properties dictate their use. Benzoguanamine has been used significantly in can coatings. Glycoluril resin formulations require higher cure temperatures or higher catalyst levels but have excellent corrosion and humidity resistance. High cost limits their use. The acrylamide-type amino resins have had very limited use. Some applications include coil coatings for exterior use²⁴ and self-cross-linkable coatings.²⁵

79.5 Future Trends

Amino resins will be with us for quite a while, because, as a class of cross-linker, they are very economical and give excellent performance. Government regulations have already forced amino resin producers to make high-solids resins. Now these resins can be supplied at lower free formaldehyde levels. A new low free formaldehyde MF resin⁸ was introduced that can cure at 82°C (180°F) with as little as 0.5% acid catalyst.

Some paint suppliers have developed new vehicle resins so that MF resins can continue to be used in high performance applications (again mainly cost driven). Carbamate^{9,26} and silane-containing²⁷ vehicle resins provide enhanced exterior durability benefits when cross-linked with MF resins. The desire to use amino resins in paint will keep formulators busy for years to come.

References

1. F. N. Jones and P. S. Ramachandran, *Polym. Mater. Sci. & Eng.*, 77, 389 (1997).
2. D. E. Erickson and T. P. Golden, *Paint & Coat. Ind.*, August, 50 (1995).
3. P. Swaraj, Ed., *Surface Coatings: Science and Technology*, 2d ed. Chichester: John Wiley, 1997, pp. 861–865.
4. G. D. Vaughn, *Paint & Coat. Ind.*, August, 58 (1998).
5. J. O. Santer, *Prog. in Org. Coat.*, 12, 309 (1984).
6. "Standard Test Method for Volatile Content of Coatings," ASTM D2369-04.
7. J. J. Gummeson, *J. Coat. Technol.*, June, 43 (1990).
8. G. D. Vaughn and J. D. Jacquin, Presented at the 77th Annual Meeting of the FSCT, Dallas, TX, October 20–22, 1999.
9. H. P. Higginbottom, G. R. Bowers, P. E. Ferrell, and L. H. Hill, *J. Coat. Technol.*, July, 49 (1999).
10. W. J. Blank, *J. Coat. Technol.*, April, 26 (1982).
11. A. Berge, B. Kvaeven, and J. Ugelstad, *Eur. Polym. J.*, 6, 981 (1970).
12. L. Calbo, *J. Coat. Technol.*, January, 75 (1980).
13. "Standard Test Method for Package Stability of Paint," ASTM D1849-95.
14. Z. W. Wicks, Jr. and G. -F. Chen, *J. Coat. Technol.*, March, 39 (1978).
15. L. W. Hill and Z. W. Wicks, Jr., *Prog. Org. Coat.*, 8, 161 (1980).
16. P. E. Ferrell, J. J. Gummeson, L. W. Hill, and L. J. Truesdell-Snyder, Presented at the 73rd Annual Meeting of the FSCT, St. Louis, MO, October 9–11, 1995.
17. W. J. Blank, U.S. Patent 5 102 961, 1992.
18. J. C. Brogan and N. Albrecht, *Proceedings of the Fourth International Paint Congress*, Sao Paulo, Brazil, 1995, p. 839.

19. J. W. Holubka, P. J. Schmitz, and L. -F. Xu, *J. Coat. Technol.*, February, 77 (2000).
20. P. J. Schmitz, J. W. Holubka, and L. -F. Xu, *J. Coat. Technol.*, May, 39 (2000).
21. G. D. Vaughn, J. B. Downie, and P. E. Ferrell, *Paint & Coat. Ind.*, August, 74 (2001).
22. B. Pourdeyhimi, X. Wang, and F. Lee, *Eur. Coat. J.*, 4, 100 (1999).
23. J. L. Courter and E. A. Kamenetzky, *Eur. Coat. J.*, 7–8, 24 (1999).
24. M. T. Keck, R. J. Lewarchik, and J. C. Allman, U.S. Patent 5 688 598, 1997.
25. S. Swarup and M. A. Mayo, U.S. Patent 5 618 586, 1997.
26. J. D. McGee and B. D. Bammel, Presented at the Eighth Annual ESD Advance Coatings Technology Conference, Detroit, MI, September 28–29, 1998.
27. I. Hazan, Presented at the Eighth Annual ESD Advance Coatings Technology Conference, Detroit, MI, September 28–29, 1998.

80

Driers

Milton Nowak

Troy Chemical

References 80-3

Driers are metallic soaps (metal salts of various organic acids) used primarily for the catalysis of the drying of oils, oleoresinous compositions, alkyd resins, and polyesters.

Metallic soaps have a long history prior to their use as driers. Evidence indicates that calcium greases in the form of combinations of lime and fats were used as axle greases as early as 1400 B.C. A combination of red lead with drying oil was patented in 1773 as a grease for reducing friction between iron or steel parts. As early as 1880, A. W. Pratt patented liquid paint driers based on lead and manganese linoleates dissolved in linseed oil, naphtha, and turpentine. Cobalt soaps appeared sometime around 1900.

The drying mechanism is complicated by various factors such as (a) the nature of the drying oil or resin, (b) the drier or drier combination that is used, and (c) the conditions under which drying is achieved.

Drying oils absorb oxygen from the atmosphere and evolve carbon dioxide and water during drying.^{1,2} The presence of driers causes somewhat less oxygen to be absorbed, although the amount of carbon dioxide evolved is the same.³ Many studies have been made to substantiate the various theories of oxidation and polymerization.^{4,5,6}

Drying involves a number of steps, the first of which is a period of induction. This interval, during which no drying occurs, is the result of the presence of natural inhibitors present in most drying oils. (When the inhibitors are overcome, the second stage of drying is initiated by the absorption of oxygen.) The presence of driers rapidly neutralizes the inhibitors and accelerates the absorption of oxygen. Absorption of oxygen at the unsaturated sites of the oil molecule results in the formation of peroxides, which often decompose to form free radicals. These act as catalysts to promote cross-linking of the oil or resin molecules at the unsaturated sites, resulting in a dried film.

The basic equations involved in the drying of paint films in the presence of a catalyst such as cobalt may be outlined as follows:

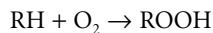

This represents the first reaction, involving the methylene groups adjacent to the double bonds of the drying oil and oxygen to form hydroperoxides.

Depending on the nature of the drying oil, resin, or alkyd, there is then a shift in double-bond positions to form conjugated molecular structures. There is a subsequent decomposition of hydroperoxides to form free radicals

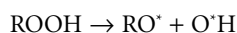

These propagate further reactions:

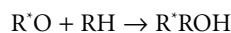

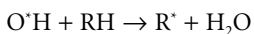

Free radicals terminate the process by interaction:

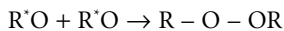
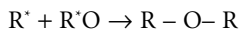
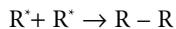

The products of these interactions then react with radicals to form products of greater molecular weight, the net result being the polymerization of the drying oil.

There have been many detailed studies of the drying mechanism.^{2,3,4}

As many as 24 metals have been demonstrated to have some activity as driers,⁷ but only the soaps of cobalt, manganese, lead, iron, vanadium, and cerium are considered as primarily “active,” although neodymium, aluminum, and lanthanum have also been added to this list. Soaps of zirconium, calcium, zinc, potassium, and lithium, are used as auxiliary driers. These metals exert a definite effect on drying on film formation when used in conjunction with the primary metals driers, although they are inert when present by themselves.

Driers may be prepared by various types of chemical reactions. In the early 1900s, so-called “Japan” driers were used. These consisted mainly of cobalt acetate fused with rosin or other high-bodied oils. Similar lead compounds were also used. The amount of cobalt or lead present was generally unknown or roughly indicated, and the solubility of the metal in the drying oil system was unknown.

Production of driers of standard metal content and adequate solubility was achieved through three types of reactions:

1. Fusion of metallic oxides with suitable organic acids — for example, lead oxide and 2-ethyl hexoic acid to yield lead 2-ethylhexoate
2. Double decomposition, as represented by the reaction of a solution of cobalt sulfate with sodium naphthenate in the presence of a solvent such as mineral spirits to yield a solvent solution of cobalt naphthenate (The aqueous solution of sodium sulfate that forms is separated from the solvent solution.)
3. Direct metal fusion,⁸ where, for example, cobalt metal is reacted with an organic acid in the presence of air and water, yielding cobalt soaps of high purity

Many organic acids have been used at one time or another for the preparation of metallic soaps. To produce oil-soluble soaps, which are most suitable for use as driers in oil-based paints, acids such as oleic acid, tall oil fatty acids, 2-ethylhexoic acid, iso octanoic acid, iso decanoic acid, nonanoic acid, and naphthenic acid have been utilized.

The solubility of the metal soap depends on the particular metal and acid. For example, metal soaps of naphthenic acid are quite soluble in mineral spirits. The cobalt soap of 2-ethylhexoic acid is also soluble, but the copper soap of 2-ethylhexoic acid is only slightly soluble in mineral spirits. The cobalt soap of oleic acid is moderately soluble in mineral spirits, but the zinc soap is not.

One cannot, therefore, generalize as to the solubility of metal soaps of various acids.

The most active and the most important “active” drier metal is cobalt, usually prepared as a mineral spirits solution of a cobalt soap containing 12% cobalt as metal.

Cobalt causes the surface of the film to dry rapidly, and it is used at very low levels — 0.02 to 0.04% based on the oil. Excessive amounts will cause wrinkling or cracking of the film. Cobalt is not a “through” drier; that is, it will cause the surface to dry but will leave a wet film underneath. When used in polyester resins, cobalt will cause polymerization when used together with an organic peroxide.

The phenomenon, “loss of dry,” affects many highly pigmented paints. This is primarily because of the adsorption of the cobalt drier on the pigment surface, thus removing it from solution. Use of

coordination compounds such as ortho phenanthroline or, di-pyridyl seems to reduce or eliminate such adsorption and prevent "loss of dry." This may also be accomplished by using highly basic cobalt compounds that slowly release cobalt into solution. By "basic," we mean that the metal soap contains more moles of metal than the equivalent moles of acid from which it is formed.

To accomplish complete drying of oil films, the cobalt drier is used with another that possesses the property of initiating complete dry. Lead soaps are the most effective in this regard, but their use has been limited because of toxicity.

Calcium and zirconium are the metals used to replace lead. They are considered auxiliary driers. Calcium soaps at one time consisted of the naphthenates, usually at 4% and 6% calcium concentration. These were highly acidic and quite viscous. They have largely been replaced by calcium octoate, a highly basic material, low in viscosity and odor and available in solvent solutions in various concentrations.

Zirconium 2-ethylhexanoate is also a basic soap, usually available in 12%, 18%, and 24% Zr concentrations. It seems to have a catalytic effect on cobalt and manganese driers, and is said to have a coordination potential of namely 8, and a low redox potential. When electron-donating groups develop, coordination polymerization occurs, assisting in the overall drying effect.

Barium 2-ethylhexanoate has also been used as a replacement for lead driers, but also has found limited use because of its toxicity. Manganese is the other "active" drier that is widely used in oil paints and in baking finishes. Although active as an oxidant, it seems to promote polymerization to a greater extent than cobalt. Solutions of manganese 2-ethylhexanoate rapidly oxidize to a dark brown color on exposure to air. The use of manganese in white paints presents discoloration problems that must be handled by careful formulation. Manganese is often used alone in baking finishes.

A number of other metals have been used as auxiliary driers. Neodymium, lanthanum, and aluminum are reported to be useful as "through" driers.⁹ Vanadium is also effective but causes severe discoloration. Bismuth soaps have been used as a replacement for lead soaps in drier systems.

Iron is a potent drier, similar to manganese in its effects. However, it is highly staining and is used in systems where color is of no importance. Cerium may also be considered an oxidative drier, but it is of low activity compared with cobalt or manganese.

Waterborne coatings present another problem for the formulator because the presence of large volumes of water changes the chemistry of coating resins.¹⁰ It was found that adequate drying required a larger percent of cobalt drier rather than various cobalt combinations utilizing the cobalt concentrations adequate for oil-based systems.

There is growing use of premixed blends of drier metal soaps according to the individual requirements of the paint manufacturer. Formulation of such combinations requires careful study to achieve stable blends, because the individual metal soaps may be normal, acid, or basic.

Antiskinning agents are antioxidants used to prevent formation of oxidized surface films on the paint while stored in containers. The type of antioxidant and the concentration in the paint have to be carefully considered. Phenolic compounds are most effective but will prolong the drying time of the film. The oximes can be used over a wider range of concentrations without seriously affecting drying time. The types most widely used are the oximes, such as acetone oxime, methyl ethylketoxime, butyraldoxime, and cyclohexanone oxime. It is believed that these compounds function by forming weak complexes with cobalt or manganese, thus inhibiting the oxidizing power of the metal. When the paint is exposed as a thin film, the oxime volatilizes fairly rapidly, leaving the metal in its active state.

Various phenolic compounds are also used as antioxidants. These function by contributing protons that interrupt the peroxide free radical oxidation chain and do not volatilize from the film. Compounds such as hydroquinone, ortho isopropylphenol, eugenol, and guaiacol are used in paints formulated with highly reactive vehicles such as tung oil, oiticica oil, and dehydrated castor oil.

References

1. S. Coffey, *J. Chem. Soc.*, 119, 1408–1415 (1921).
2. J. S. Long, A. E. Rheineck, and G. L. Ball, *Ind. Eng. Chem.*, 25, 1086–1091 (1933).

3. A. C. Elm, *Ind. Eng. Chem.*, 26, 386–388 (1934).
4. P. O. Powers, *Ind. Eng. Chem.*, 41, 304–309 (1949).
5. P. S. Hess and G. A. O'Hare, *Ind. Eng. Chem.*, 44, 2424–2428 (1952).
6. R. R. Myers and A. C. Zettlemoyer, *Ind. Eng. Chem.*, 46, 2223–2225 (1954).
7. W. J. Steward, *Offic. Dig. Federation Paint & Varnish Prod. Clubs*, 26, 413 (1954).
8. M. Nowak and A. Fischer, U.S. Patent 2584041 (January 29, 1952).
9. R. W. Hein, *J. Coat. Technol.*, 71, 898 (1999).
10. R. W. Hein, *J. Coat. Technol.*, 70, 886 (1998).

81

Biocides for the Coatings Industry

81.1 Introduction	81-1
81.2 In-Can Preservatives	81-1
81.3 Dry-Film Preservatives.....	81-2
References	81-3

K. Winkowski
ISP Corp.

81.1 Introduction

Microorganisms are ubiquitous in the environment. Many of them have simple requirements for growth that can be met by most waterborne coatings. Adding an in-can preservative will protect these coatings in the wet state during storage and transport. After a coating has been applied and dried, most waterborne and solvent-borne coatings are susceptible to colonization by fungi or algae. The addition of a dry-film preservative (fungicide or algicide) will ensure long-term performance of the coating.

81.2 In-Can Preservatives

Industrial water-based formulations usually require protection against microbial spoilage. Examples of such formulations include latexes, emulsions, paints, adhesives, caulks, and sealing mastics. Microbial contaminants can be introduced by water (process water, wash water), raw materials (latex, fillers, pigments, etc.), and poor plant hygiene. Bacteria are the most common spoilage organisms, but fungi and yeasts are sometimes responsible for product deterioration. Among the most common contaminants are *Aeromonas* sp., *Bacillus* sp., *Desulfovibrio* sp., *Escherchia* sp., *Enterobacter* sp., and *Pseudomonas* sp. Microbial growth is usually manifested as a loss in functionality and may include gas formation, pH changes, offensive odor, and changes in viscosity and color.¹ Spoilage of the water-based products, which can go unnoticed until the product reaches the consumer, can result in significant economic loss to the manufacturer. Good plant hygiene and manufacturing practices, when combined with the use of a compatible broad spectrum biocide, will minimize the risk of microbial spoilage of the coating.²

In selecting an in-can preservative, cost effectiveness, compatibility, stability, handling, and eco-toxicity are important factors to take into account. Intrinsic properties of the coating, such as pH, viscosity, redox potential, and the presence of certain ingredients may also affect the effectiveness of biocides. The best way to determine the efficacy of a biocide in a specific formulation is by performing an in-can challenge test. While there are several methodologies available to evaluate the efficacy of in-can preservatives,³ they all involve testing of preserved and unpreserved samples of the test coating when challenged with a battery of microorganisms and then monitoring the samples for the presence of viable microorganisms and changes in the coating properties. Typical use levels for in-can preservatives are in the range of 0.05 to 0.5 weight percent.

TABLE 81.1 Examples of In-Can Preservatives

Active Ingredient Type	Product Name
Adamante	Busan 1024, Dowcil 75
Aldehyde	Biocheck 80, Ucarcide 250, Nuosept 145, Nuosept 210
Amide	Biocheck 20
Amino acid adducts	Nuosept 44
Haloalkane	Tektamer 38 AD
Hydantoin derivative	Biocheck 240, Dantogard, Troysan 395
Isothiazolinone	Acticide RS, Busan 1174, Kathon LX, Mergal K14, Nuosept 495, Parmetol D22, Proxel GXL
Oxazolidine	Bioban CS 1135, Canguard 327, Nuosept 95, Troysan 192
Chlorinated phenol	Preventol CMK
Triazine	Bioban GK, Congard 454, Vancide TH
Blends of actives	Acticides, Proxels, Mergals, Nuosepts, Rocimas, etc.

A wide range of in-can preservatives are available. They are usually added as early as possible in the production process and include adamants, aldehydes, amides, amino acid adducts, halogenated alkanes, imidazolinones, isothiazolones, oxazolidines, phenolics, and triazines. Table 81.1 shows a list of typical products.

81.3 Dry-Film Preservatives

Both water-based and solvent-based coatings are susceptible to the colonization of fungi and algae upon drying. The type of microorganisms that can colonize the coating will depend on several factors, including the moisture content of the surface, the presence of nutrients, the substrate, and the type of coating.^{4,5,6} For example, the moisture content of the surface is affected by factors such as climatic conditions (amount of rainfall, dew, humidity, temperature, and time of the year) as well as local conditions (surfaces sheltered from winds and shaded areas will contain higher moisture content). The presence of nutrients may include constituents of the coating (such as polymers, thickener residues, etc.), biodegraded substances produced by other microorganisms (e.g., complex substrates may be attacked by a succession of microorganisms), or simply material deposited on the coating from the atmosphere, such as dirt. The substrate is also of importance. It provides, for example, a suitable pH environment. In this regard, fungi favor more acidic conditions, such as those provided by wood. Algae, on the other hand, favor more alkaline conditions, such as those provided by masonry. Last, the type and properties of the coating (water repellency, hardness, chalking, and roughness) will also play an important role in determining which type of microorganism could colonize the coating.

On exterior surfaces, *Aureobasidium pullulans* and *Alternaria* sp. are common fungal isolates. In general, fungi found on exterior surfaces are able to withstand high temperatures and dry conditions, are tolerant to UV exposure, and can adhere well to surfaces.⁷ On interior surfaces, the fungi *Aspergillus* sp. and *Penicillium* sp. are frequently isolated. Algae are mainly isolated from exterior surfaces. Green algae species (*Chlorella* sp. or *Stichococcus* sp.) are usually isolated in temperate regions. *Trentepohlia* sp. (which can be orange or green in color) is very common in tropical regions. Blue-green algae (*Gloeocapsa* sp., *Nostoc* sp.) have been isolated from various regions. Several blue-green algae (*Calothrix* sp., *Sytonema* sp.) are black in color and are, thus, easily mistaken for fungal discoloration.

The growth of microorganisms on coatings, also known as defacement, not only affects the appearance of the coating (discoloration), but it may also compromise its performance (biodegradation). Fungi can penetrate coatings, resulting in cracking, blistering, and hampering the coatings' adhesion properties, thus leading to decay or corrosion of the underlying substrate. Algae colonies, which seem to grow more rapidly on porous substrates such as stucco, cement, and bricks, may be able to hold water. The freezing and thawing of this entrapped water may induce cracking or may increase the permeation properties of

TABLE 81.2 Examples of Dry-Film Biocides

Active Ingredient	Product Name
Benzimidazole	Megal BCM, Preventol BCM, Metasol TK-100
Carbamic acid derivatives	Fungitrol 420, Polyphase P20T, Omacide IPBC 20
Chlorothalonil	Acticide C98, Busan 1192, Nuocide 960
Isothiazolinone	Acticide 45, Skane M8, Rozone 2000
Pyridine <i>N</i> -oxide derivatives	Zinc Omadine
Thiazole	Busan 1030, Preventol CR
Thiophthalimide	Fungitrol 11, Preventol A3, Vancide 89
S-Triazines (algaecides)	Irgarol 1071, Nuocide 1071
Blends of actives	Acticides, Mergals, Nuocides, Polyphases, etc.

the coating, leading to failure. Also, the presence of water may encourage colonization by other microorganisms, which, in turn, may cause biodeterioration.⁶

There are several dry-film fungicides and algaecides in the market. Dry-film fungicides should be UV stable and resistant to leaching. Typical use levels for dry-film biocides are in the range of 0.5 to 2.0 percent by weight. As with the in-can preservatives, performance and compatibility with a specific coating formulation should be tested. Accelerated laboratory tests are usually recommended to test outdoor coatings.^{8,9} These tests involve coating an inert surface that is then inoculated with various fungal or algae species. The surface is then rated periodically, and the percent of surface covered by microbial growth is rated. Long-term outdoor exposure studies on test fence can also be conducted.¹⁰ For interior coatings, the Environmental Chamber test¹¹ is recommended.

The most common fungicide active ingredients in the market include benzimidazoles, carbamic acid derivatives (e.g., IPBC), chlorothalonil, isothiazolones (e.g., OIT), pyridines-*N*-oxide derivatives, thiazoles, and thiophthalamides (e.g., fopet). The most common algaecides include S-triazines and urea-derivatives (e.g., Diuron). Table 81.2 shows a list of typical products including several available blends.

References

1. J. Gillatt, *JOCCA*, 10, 387–392 (1992).
2. K. Winkowski, *PCI*, 7, 60–66 (2002).
3. K. Winkowski, *ECJ*, 1–2, 85–91 (2001).
4. S. Bussjaeger, G. Daisey, R. Simmons, S. Spindel, S. Williams, *J. Coat. Technol.*, 71, 67–69 (1999).
5. J. A. Dupont, *Mod. Paint and Coat.*, 11, 38–48 (1978).
6. I. C. Wright, *Biodeterioration*, VI, 637–643 (1986).
7. R. A. Zabel and F. Terracina, *JCT*, 4, 42–46 (1978).
8. ASTM D5590-94, Annual Book of ASTM Standards, 06.01, pp. 608–611.
9. ASTM D5589-97, Annual Book of ASTM Standards, 06.01, pp. 604–607.
10. ASTM D3456-86, Annual Book of ASTM Standards, 06.01, pp. 362–364.
11. ASTM D3273-86, Annual Book of ASTM Standards, 06.01, pp. 474–476.

82

Clays

82.1 Kaolin	82-1
Manufacturing • Kaolin Categories • Benefits of Kaolin Use in Paints • Applications of Kaolin in Paints	
82.2 Attapulgite.....	82-3
Dispersion • Application in Paints	
82.3 Smectite.....	82-5
Organoclays	
References.....	82-6

Ashok Khokhani
Engelhard Corporation

Clay is a general term used to describe minerals consisting mostly of hydrous aluminum silicates. Early on, any particle that was submicron was considered clay. It was also thought that clay was a mixture of amorphous materials with no definite composition. As described by Grim,¹ it was determined later on that clay was properly defined by the clay mineral concept as being composed of extremely small crystalline particles consisting mainly of hydrous aluminum silicates with substitution of aluminum by magnesium, iron, alkalies, or alkaline earth elements.

Clays are used in many applications, such as in the manufacture of paper, ceramics, zeolites, catalysts, plastics, rubber, absorbants, and paints. However, this discussion will pertain to the use of clays in paints and inks. We will cover three main types of clays: kaolin, attapulgite, and smectite.

82.1 Kaolin

This type of clay consists mostly of hydrated alumino-silicate with a chemical formula $Al_2Si_2O_5(OH)_4$. The particles have a platy structure and belong to the phyllosilicate family. Under a microscope, it appears as stacks of hexagonal platelets. It is crystalline in nature and occurs in nature as very fine particles. It is formed by chemical modification of feldspar or mica. These minerals have some solubility in water, and under certain geothermal conditions, they decompose to form kaolin with the removal of alkali and alkaline earth and transition elements.²

Kaolin can be broadly classified as primary or secondary. Primary kaolin deposits that are formed by weathering consist of large amounts of impurities, mainly of quartz, feldspar, and mica. These deposits are mainly found in Cornwall, England, and Saxony, Germany.

The percentage of kaolin present in these deposits is usually 15 to 20%. Secondary kaolin deposits that have been transported by receding ocean water have relatively low amounts of impurities. These are mainly found in the Southeastern United States and in the Amazon region of Brazil. Secondary kaolin is usually less abrasive than primary kaolin.

Note: Mattex, Satintone, ASP, and Attagel are registered trademarks of Engelhard Corporation. Bentone is a registered trademark of Elementis. Claytone is a registered trademark of Southern Clay products. Tixogel is a registered trademark of Süd-Chemie.

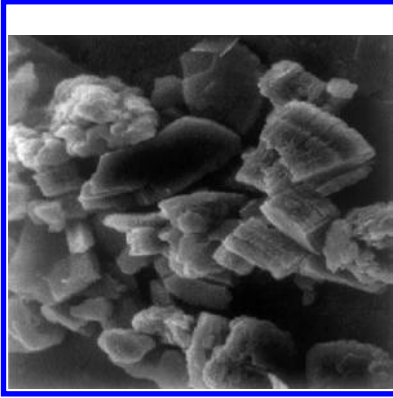

FIGURE 82.1 Hydrous kaolin. (From Engelhard Corp. technical literature.)

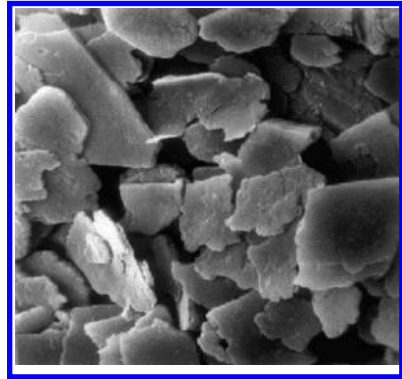

FIGURE 82.2 Delaminated kaolin. (From Engelhard Corp. technical literature.)

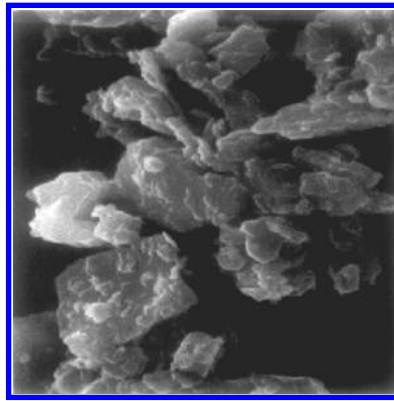

FIGURE 82.3 Calcined kaolin. (From Engelhard Corp. technical literature.)

82.1.1 Manufacturing

Another way to classify kaolin is by how it is manufactured: air-float versus water-washed. Air-float kaolin is mined from the ground, dried, pulverized, air classified, and packaged. Water-washed kaolin, on the other hand, is highly beneficiated to remove impurities, improve brightness, and provide overall consistency to the product. Some of the steps involved in the manufacture of water-washed kaolin are degritting, oxidative and reductive bleaching, high intensity magnetic separation, flotation, centrifugation, filtration, spray-drying, calcination, pulverizing, and packaging. Water-washed kaolins are mostly used in paint and ink applications.

82.1.2 Kaolin Categories

Kaolins are further divided into categories: hydrous, delaminated, calcined, and surface treated.

1. Hydrous kaolins, as shown in Figure 82.1 have a stacked platy structure. They have an aspect ratio between 4:1 to 6:1, and the median particle size ranges from 0.18 to 4.5 microns.
2. Delaminated kaolins, as shown in Figure 82.2, have a more platy structure than regular hydrous kaolin, with an aspect ratio as high as 10:1.
3. Calcined kaolins, as shown in Figure 82.3, have an amorphous structure with air voids trapped in between particles.
4. Surface-treated kaolins are either hydrous or calcined and have been treated with various surface-active agents, such as silanes, stearates, or polyacrylates, to provide hydrophobicity and ease of dispersion or to improve film properties.

TABLE 82.1 Typical Properties of Kaolin

Property	Hydrous Delaminated		Calcined
Median particle size, microns	0.18–4.8	0.4–1.0	0.8–2.0
Oil absorption, g/100g	31–46	38–46	50–95
Brightness, GE	85–92	86–92	86–96
Refractive index	1.56	1.56	1.62
Specific gravity	2.58	2.58	2.50–2.63
Free moisture (% max)	1.0	1.0	0.5
pH	3.5–8.0	6.0–8.0	5.0–6.0

TABLE 82.2 Some Commercial Kaolin Products and Their Usage in Paints

Type of Paint	Type of Kaolin	Commercial Product	Loading Level, % by wt.	Loading Level, lbs/100 gallons
Flat paint	Calcined	Mattex	10–20	100–200
Satin/eggshell	Calcined + hydrous	Satintone.W/ASP. NC	5–15	50–150
Semigloss	Hydrous	ASP 170	5–10	50–150
Gloss	Hydrous	ASP Ultrafine	Max. 5	50

Table 82.1 shows typical properties of some of these kaolins.

82.1.3 Benefits of Kaolin Use in Paints

Due to its fine particle size, kaolin has been extensively used as a TiO₂ spacer or extender. The fine particle size hydrous grades are most efficient to extend TiO₂. Kaolins also help in other paint properties, such as improved suspension, antisetling, gloss control, improved stain resistance, and improved brushability. Calcined kaolins provide opacity by increasing dry hiding in high PVC paints. They are among the more efficient extender pigments for paints formulated above CPVC.

82.1.4 Applications of Kaolin in Paints

Hydrous kaolins are suitable to be used in gloss, semigloss and some eggshell paints. They are used in both architectural and industrial paints. Typical loading levels in these paints are 3 to 7% by weight.

Delaminated kaolins are used in eggshell and satin paints. They provide excellent sheen to the paints and improve stain and mud-cracking resistance. Typically, they would be used at 5 to 10% by weight.

Calcined kaolins are mostly used in flat and eggshell paints. They provide high opacity, tint strength, and scrub resistance. Some newer grades have excellent balance of high opacity and low sheen, providing excellent touch-up properties. Loading levels would range from 5 to 25%, but more common are levels ranging from 10 to 20%.

Certain surface-treated grades are used in industrial coatings to provide improved film properties, ease of dispersion, and better compatibility with resins.

Table 82.2 shows some commercial products and their usage levels in paints.

82.2 Attapulgite

Attapulgite is a clay mineral with a chemical composition of hydrated magnesium aluminum silicate and with a formula of (Mg, Al)₅ Si₈O₂₂·4H₂O. It occurs in nature as bundles of acicular particles that are colloidal in nature.

The function of attapulgite mineral in paints is to provide thixotropy. The majority of the applications of this mineral is in waterborne paints, although it is also successfully being used in many solvent-borne applications.

TABLE 82.3 Features and Benefits of Attapulgite

Features	Benefits
Inorganic	Resistant to bacteria, enzymes
Inert	Stable over wide pH ranges
Colloidal particles	Forms a network to provide syneresis control, sag resistance, suspension, and spatter resistance
Powder	Ease of incorporation

Some of the key features and benefits of attapulgite are listed in Table 82.3.

82.2.1 Dispersion

Although attapulgite is very easy to disperse, it is important to understand how attapulgite thickens. Attapulgite works best when incorporated as a powder in the grind or the millbase. High shear is required to optimize its dispersion. The shear separates the particles from the bundles, and these particles, through hydrogen bonding and some van der Waals forces, form a lathlike structure that provides thixotropy. It is important not to use attapulgite in the let down in powder form, as the low shear will not disperse it. Figure 82.4 and Figure 82.5 show the photomicrographs of attapulgite particles and its network formation in an aqueous dispersion.

82.2.2 Application in Paints

Attapulgite is used in paints to provide syneresis or liquid separation control. Some other benefits of attapulgite are improved sag resistance, excellent suspension of pigment particles, and provision of creamy consistency to paints. It is recommended to use attapulgite as a cothickener along with cellulosic or associative or synthetic thickeners. Typical loading levels are 0.3 to 1.0% by weight for waterborne architectural paints.

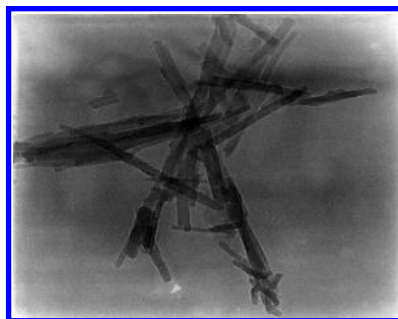

FIGURE 82.4 Attapulgite crystals. (From Engelhard Corp. literature.)

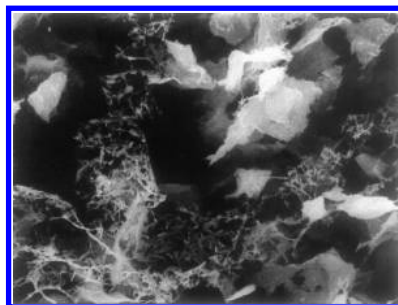

FIGURE 82.5 Network formation in paints. (From Engelhard Corp. literature.)

TABLE 82.4 Some Commercial Attapulgite Products and Their Usage in Paints

Type of Paint	Type of Attapulgite	Commercial Product	Loading Level, % by wt.	Loading Level, lbs/100 gallons
Flat paint	Gel grade	Attagel 40	0.5–1.0	5–10
Satin/eggshell	Gel grade	Attagel 40	0.5–1.0	5–10
Semigloss	Premium gel grade	Attagel 50	0.3–0.5	3–5
Gloss	Premium gel grade	Attagel 50	0.3–0.5	3–5

Some commercial products and their usage levels are listed in Table 82.4.

82.3 Smectite

Smectite is a group of clay minerals consisting mostly of sodium and calcium montmorillonites and hectorite. They have an octahedral and tetrahedral crystal structure like kaolin but differ in that they have high cation exchange capacity. Therefore, substitutions of cations such as sodium and calcium are very likely. It has a three-layered structure that is highly swellable and finds use in drilling mud, bleaching clay, kitty litter absorbents, and many other formulations. The exchangeable sodium ion allows this clay to be made into organoclays that are used extensively in solvent-borne paints.

Figure 82.6 and Figure 82.7 show the crystal size, aspect ratio, and surface charges present on smectite crystal.

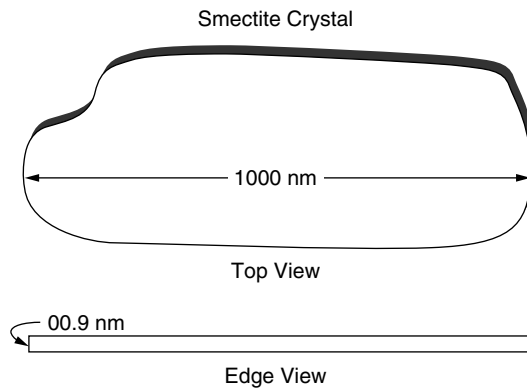

FIGURE 82.6 Smectite crystal structure. (From Southern Clay's Web site, www.claytone.net.)

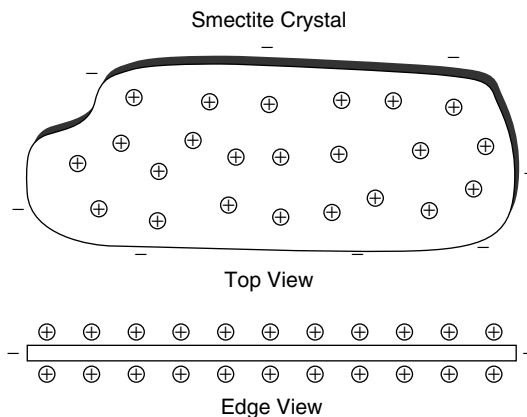
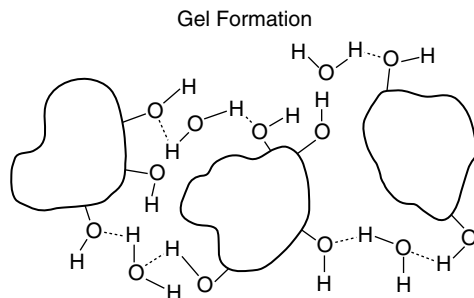

FIGURE 82.7 Smectite surface charges. (From Southern Clay's Web site, www.claytone.net.)

TABLE 82.5 Some Commercial Smectite Products and Their Usage in Paints

Type of Clay	Commercial Product	Loading Level, lbs/100 gallons
Montmorillonite	Bentone 34	2–9
Montmorillonite	Bentone SD-1	2–20
Montmorillonite	Claytone 40	2–20
Montmorillonite	Claytone AF	2–20
Smectite	Tixogel VP	2–10
Smectite	Tixogel MP100	2–10

**FIGURE 82.8** Gel formation in organoclays. (From Southern Clay's Web site, www.claytone.net.)

82.3.1 Organoclays

In organoclays, the sodium ion has been exchanged with organic alkyl amines to form organic-clad clays. The organic modification makes the clays hydrophobic and compatible with solvent-borne resins. They are used to thicken alkyds, polyesters, epoxies, hydrocarbon resins, mineral oils, and greases. The type of organic modification dictates compatibility with various resins. Organoclay manufacturers also have products recommended for waterborne paints. However, for use in waterborne systems, hydration time and adjustment of pH are usually required.

82.3.1.1 Dispersion

As with attapulgite, the organoclays have to be carefully and completely dispersed to obtain maximum benefits of gelation. The organoclays' stacks of platelets first have to be wetted out with solvent under shear. In many cases, a polar additive like methanol with small amounts of water is usually added to further completely delaminate the stacks of platelets. A proper amount of polar additive is essential to get complete delamination. As shown in Figure 82.8, thickening occurs due to affinity of quaternary functional groups for the solvent and the hydrogen bonding of the clay platelets.

82.3.1.2 Application in Paints

Organoclays are used mostly in solvent-borne paints to provide sag resistance, increase viscosity, provide pigment suspension, and control pigment flotation. Specific grades are available from various manufacturers depending on the polarity of the system and whether a polar activator is required.

Table 82.5 shows some commercial examples of organoclays and their usage in paints.

References

1. Ralph E. Grim, *Applied Clay Mineralogy*. New York: McGraw-Hill, 1962, pp. 1–5.
2. G. Millot, *Geology of Clays*. New York: Springer-Verlag, 1970, p. 429.

Fluorocarbon Resins for Coatings and Inks

83.1	General.....	83-1
83.2	Poly(Vinylidene Fluoride) (PVDF) Resins for Coatings	83-2
83.3	Fluorinated Ethylene Vinyl Ether (FEVE) Resins for Coatings	83-3
83.4	Fluorinated Acrylics	83-4
83.5	Other Fluorinated Resins for Coatings and Inks.....	83-4
	Bibliography	83-5

Kurt A. Wood
Arkema, Inc.

83.1 General

The commercially important fluorocarbon resins are based upon a handful of fluorinated monomers, as indicated in [Table 83.1](#). From these basic building blocks, a wide variety of polymer products can be produced, especially when copolymerization with other, nonfluorinated monomers is a possibility.

Besides polytetrafluoroethylene (PTFE) “coatings” — which are prepared by a high temperature sintering process and which are not considered in this chapter — the most widely used fluorocarbon coatings are based on poly(vinylidene fluoride) (PVDF) homopolymer. Typical PVDF coatings require a high temperature bake and are applied on primed metal substrates by a coil coating or spray technique. They are commonly used in high-end architectural applications such as skyscraper curtain walls and other wall panel systems, window profiles, and commercial and residential metal roofing. The first commercial grade of PVDF for coatings, KYNAR 500[®], was introduced in 1965 by the Pennsalt Company. This same resin grade continues to be sold today by Arkema, Inc., under a worldwide licensing program.

Another commercially important class of fluorocarbon resins, fluorinated ethylene vinyl ether (FEVE) polymers, was introduced in the early 1980s by Asahi Glass, under the Lumiflon[®] trademark. FEVE products continue to enjoy their greatest success in the Far East, especially for site-applied (air-dry) applications such as industrial maintenance topcoats. Both PVDF and FEVE coatings combine superior weatherability with excellent protective and barrier properties. They are, therefore, able to simultaneously function as decorative and functional finishes.

Among the other types of fluorocarbon resins used in coatings, fluorinated acrylics are also used in significant volumes and have a long history. They are chiefly used as surface treatment agents, for applications where low surface energy is sought, e.g., for water and oil repellency.

TABLE 83.1 Fluorinated Monomers Used in the Manufacture of Common Fluororesins Used in Coatings

Monomer Acronym	Common Monomer Name	Molecular Formula	Principal Use in Fluororesins for Coatings
TFE	Tetrafluoroethylene	$CF_2=CF_2$	Comonomer for FEVE resins and PVDF copolymers; also coating additives
VDF or VF ₂	Vinylidene fluoride	$CF_2=CH_2$	PVDF homopolymer and copolymers
CTFE	Chlorotrifluoroethylene	$CFCl=CF_2$	Comonomer for FEVE resins and PVDF copolymers
HFP	Hexafluoropropylene	$CF_3CF=CF_2$	Comonomer for PVDF copolymers
—	Fluorinated decyl acrylate	$n-C_8F_{17}CH_2CH_2O-COCH=CH_2$	Comonomer for fluorinated acrylics

83.2 Poly(Vinylidene Fluoride) (PVDF) Resins for Coatings

PVDF for coatings applications is produced by a high pressure emulsion polymerization process. Vinylidene fluoride monomer normally polymerizes in a head-to-tail fashion, so the idealized structure of PVDF resin has alternating $-CH_2-$ and $-CF_2-$ groups:

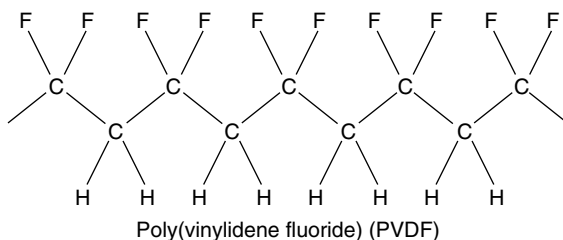

This highly regular structure, and high fluorine content (59 wt% fluorine), contributes to the excellent chemical and photochemical stability of the PVDF resin. At the same time, because there is substantial polarity along the PVDF backbone, the resin can undergo favorable thermodynamic interactions with a variety of solvents and with certain other polymers (chiefly those with high levels of carbonyl groups). This property is exploited by paint formulators, in the choice of co-resins and solvents that are used in PVDF formulations.

Compatible acrylic co-resins are widely used in PVDF paint formulations, to provide certain features such as pigment wetting and enhanced adhesion, which cannot be supplied by the relatively inert PVDF resin. Common acrylics used include poly(methyl methacrylate) (pMMA) grades and methyl methacrylate-ethyl acrylate copolymers. Acrylic levels of 20 to 30 wt% on total binder are generally used — these provide the desired performance enhancements, without too greatly compromising key PVDF properties such as weatherability, flexibility, and chemical resistance. While thermoplastic acrylics perform well in these systems, low levels of acrylic cross-linking are sometimes used by paint formulators to achieve specific performance enhancements, such as early MEK resistance for coil coatings.

Typical PVDF paint formulations generally contain one or more “latent solvents” that have good solvency for PVDF and the co-resin under high temperature bake conditions, and so promote an intimate resin alloy structure in the final coating film. Like pure PVDF homopolymer, PVDF-acrylic alloys at 70 to 80% PVDF are semicrystalline. The exact microscopic organization of the crystalline structures in these alloys depends on a variety of factors, including the cooling rate. However, in general, the crystallites act as labile cross-links, enhancing various coating properties, including chemical and solvent resistance, hardness, and barrier properties. To achieve the proper morphology, bake temperatures well above the PVDF 170°C melt temperature are used. This requirement limits the use of paints based on PVDF homopolymer to heat-insensitive substrates such as metals.

Most PVDF paints are formulated for application either by roll or spray coating. The substrates for spray coating are typically aluminum extrusions. Roll-coat application of PVDF paints is normally done on coil (precoated metal) lines, using a variety of metal substrates, including steel, galvanized steel, Galvalume®, and aluminum.

Historically, PVDF coatings have been used to meet the most demanding specifications for architectural products — such as the American Architectural Manufacturers Association (AAMA) specifications. For instance, the recent AAMA 2605 specification for spray-coated aluminum extrusions and panels calls for 10-year Florida gloss and color retention. To achieve this ambitious goal, paint formulators combine proven PVDF resin technology with carefully selected weatherable pigments, typically highly stable metal-oxide-type pigments.

While most PVDF coating applications continue to use solvent dispersions, a variety of technical alternatives have also been developed over the years, based on vinylidene fluoride resins. For baked applications, special PVDF homopolymer grades can be used to make PVDF powder coatings and waterborne baked coatings. When formulated at ratios like those of the standard solvent paints, the powder coating and waterborne approaches achieve performance, including weathering performance, equivalent to that of the solvent paints.

Neat PVDF resins in powdered form, and other neat fluoropolymers, are also used in limited quantities to make functional powder coatings, especially for the chemical process industry.

Copolymers of vinylidene fluoride with other fluorinated monomers have lower crystallinity and higher solubility in various solvents than PVDF homopolymer. These can be used to make solvent air-dry paints, suitable for use in building restoration, and for repair and touch up of PVDF paints. [These paints, however, have high volatile organic compound (VOC) levels.] Vinylidene fluoride copolymers are also used in niche ink and printing applications. More recently, PVDF copolymer grades have been used to make water-based latex dispersions. These can be used as the base resin for waterborne paints with very low VOC levels, for instance, for industrial maintenance coatings, or for architectural coatings for objects such as PVC window frames.

Another recent trend is the use of PVDF films as paint substitutes. PVDF paint films have compositions similar to traditional PVDF paints and are prepared by solvent casting or extrusion processes. They typically have a multiple layer structure and can be used with heat-sensitive substrates, for instance, in automotive and other transportation industry applications.

83.3 Fluorinated Ethylene Vinyl Ether (FEVE) Resins for Coatings

The idealized structure of an FEVE copolymer is an alternating copolymer of a highly fluorinated monomer and nonfluorinated vinyl ether monomers.

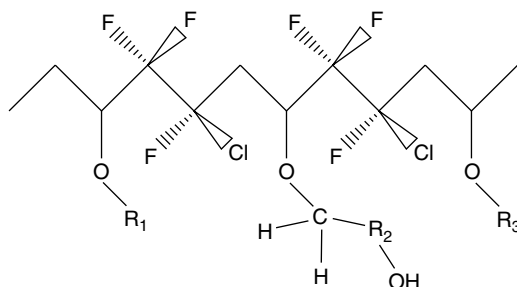

Commercial FEVE products are typically based on chlorotrifluoroethylene (CTFE), as shown in the above structure, or tetrafluoroethylene (TFE). Electronic induction effects from the fluorine atoms are

thought to confer photochemical stability to adjacent vinyl ether portions of the FEVE backbone, greatly enhancing weatherability compared to nonfluorinated ethers.

Some resin suppliers manufacture FEVE-type resins based on vinyl ester monomers rather than on vinyl ether monomers. However, the vinyl ester resins are generally understood to have inferior properties, including inferior weatherability.

Normally, a combination of vinyl ether monomers is used in order to attain a specific balance of properties. Besides using nonfunctional vinyl ether monomers such as vinyl cyclohexyl ether, vinyl ethers with functional groups on the side chain are used in measured proportions. These groups provide sites for cross-linking and can be advantageous to enhance pigment wetting, compatibility with cross-linkers, and adhesion. FEVE resins are amorphous, so unlike the case of PVDF coatings, cross-linking is normally needed for full coating property development. Most commonly, hydroxy functional monomers such as hydroxybutyl vinyl ether are used, giving resins that can be cross-linked with isocyanate or melamine cross-linkers. However, other functional groups such as acid or epoxy groups can be incorporated into the FEVE resin as well, alone or in combination.

FEVE resins can be manufactured by a number of routes (solution polymerization, emulsion polymerization, etc.). Commercial FEVE resins are most commonly supplied in a solvent, but powder and waterborne grades are also available.

Hydroxy functional FEVE solution polymers are used with aliphatic polyisocyanate cross-linkers [e.g., hexamethylene diisocyanate (HDI) isocyanurates] to make two-component air-dry coatings. The reaction of the hydroxyl groups on the FEVE resin with cross-linker isocyanate groups makes urethane linkages, under ambient conditions. This chemistry is ideal for site-applied applications such as bridges and causeways, storage tanks, and building refinishing.

For baked systems, blocked isocyanate cross-linkers such as caprolactam-blocked isophorone diisocyanate can be used (this chemistry is often used in powder coating systems). Aminoplast cross-linkers such as melamines can also be used.

83.4 Fluorinated Acrylics

Fluorinated acrylics are typically solution polymers, prepared by copolymerizing acrylic monomers having long, perfluorinated side chains, along with other, nonfluorinated acrylic monomers. By careful adjustment of the composition, fluorinated acrylics form films with $-CF_3$ groups from the side chains aligned on the surface, through side chain crystallization. The surface $-CF_3$ groups give coatings with an extremely low surface energy, down to 8 dyn/cm. Such surfaces are not only water repellent but are also oleophobic (oil-repellent). As such, they are useful for fabric treatments, as anti-graffiti coatings, and in kitchen and industrial workplace applications.

To maintain the favorable surface properties of fluorinated acrylic coatings, some kind of cross-linking chemistry is often incorporated into the resin backbone. Nevertheless, the durability of fluorinated acrylics is normally not equal to that of other common highly fluorinated coatings.

83.5 Other Fluorinated Resins for Coatings and Inks

As the various chapters in the bibliography reference works attest, there is a wide variety of fluoropolymers commercially available, each with a unique combination of chemical and physical properties. Besides the larger volume products described above, many other fluoropolymers have been considered for specialized niche applications. Among these are the following:

- Perfluorinated elastomeric resins (e.g., tetrafluoroethylene-hexafluoropropylene copolymers) for situations where excellent chemical resistance, including alkali resistance, is required.
- Low molecular weight, mobile perfluoroether resins for the protection of stone, concrete, and other porous substrates.
- High fluorine content resins of various types for optical fiber cladding and anti-fouling applications.

- Functional resins for powder and liquid coating applications, based on the copolymerization of fluorinated monomers and low levels of nonfluorinated monomers with cross-linkable functional groups.

Bibliography

- Ebnessajjad, S., *Fluoroplastics, Vol. 1: Non-melt Processable Fluoroplastics*. Norwich, NY: Plastics Design Library, William Andrew Publishing, 2000.
- Humphrey, J. S., and X. Drujon, "Polyvinylidene fluoride," in *Polymeric Materials Encyclopedia*, Vol. 11. J. C. Salamone, Ed. Boca Raton, FL: CRC Press, 1996, p. 8591.
- Perillon, J.-L., and E. J. Bartoszek, *Eur. Coat. J.*, April, 277–284 (1995).
- Philippart, J.-L., N. Siampiringue, A. Strassel, and J. Lemaire, *Makromol. Chem.*, 190, 413–418 (1989); Giannetti, E., *Polym. Int.*, 50, 10–26 (2001); Philippart, J.-L., F. Posada, and J.-L. Gardette, *Polym. Degradation and Stability*, 53, 33–37 (1996); Posada, F., and J.-L. Gardette, *Polym. Degradation and Stability*, 70, 17–29 (2000).
- Scheirs, J., Ed., *Modern Fluoropolymers*. New York: John Wiley & Sons, 1997.

84

High Temperature Pigments

84.1	Introduction	84-1
84.2	The Technology	84-2
	Color Mechanism • Chemical Structure • Production Methods	
84.3	Pigment Types	84-4
	Rutile Pigments • Spinel Pigments • Zircon Stains	
84.4	Pigment Properties.....	84-5
84.5	Typical Applications.....	84-6
	Surface Coatings • Ceramics • Building Materials • Glass • Plastics	
	Bibliography	84-8

Helen Hatcher

Rockwood Pigments

84.1 Introduction

High temperature pigments can be defined as chemical substances that impart color to a substrate or binder and retain their color and finish at elevated temperatures.

There are many everyday applications where consumers require aesthetically pleasing finishes, in the latest fashion colors, that last. There are many diverse, high performance applications that require careful pigment selection to ensure that the coloration is long-lasting; rarely will a consumer be aware of the technological considerations that apply when designing such products.

Chemically, high temperature pigments are inorganic compounds. Although many chemical classes potentially fall into this category, an important family of pigments is termed complex inorganic color pigments (CICPs), otherwise known as mixed metal oxides (MMOs) or complex inorganic pigments (CIPs). These pigments are heat stable to temperatures exceeding 1832°F (1000°C), suitable for the majority of applications. High performance pigments also include cadmium pigments, able to withstand temperatures of up to 752°F (400°C), and bismuth vanadate pigments, with heat stability of up to 392°F (200°C). These pigments exhibit excellent color properties but will not be covered in this review.

There are two distinct classes of CICPs, similar in chemistry but differentiated by end market and by particle size; pigment-grade for plastics, surface coatings, building materials, and glass applications, and ceramic-grade for ceramic applications.

It is interesting to note that some colors are more heat stable than others. For example, black is a strong absorber of infrared (IR) radiation and therefore retains heat. Hence, black pigments and dark colors require better heat stability than lighter colors or pastel shades.

Recent technology advances include pigments that provide color and functionality by building in the ability to reflect IR rays away from the substrate or binder, and hence, lowering the heat buildup and prolonging the lifetime of the product. These products are promoted by Energy Star for their benefit to the environment in terms of energy-saving initiatives.

1 H											5 B	6 C	7 N	8 O											
3 Li	4 Be											13 Al	14 Si	15 P	16 S										
11 Na	12 Mg											22 Ti	23 V	24 Cr	25 Mn	26 Fe	27 Co	28 Ni	29 Cu	30 Zn	31 Ga	32 Ge	33 As	34 Se	
19 K	20 Ca											40 Zr	41 Nb	42 Mo	43 Tc	44 Ru	45 Rh	46 Pd	47 Ag	48 Cd	49 In	50 Sn	51 Sb	52 Te	
37 Rb	38 Sr											72 Hf	73 Ta	74 W	75 Re	76 Os	77 Ir	78 Pt	79 Au	80 Hg	81 Tl	82 Pb	83 Bi	84 Po	
55 Cs	56 Ba											104 Rf	105 Db	106 Sg	107 Bh	108 Hs	109 Mt								
87 Fr	88 Ra																								

Dopants & Mineralizers

Coloring Metals

Oxide Host Lattices

Non-oxide Host Lattices

FIGURE 84.1 Periodic table.

84.2 The Technology

84.2.1 Color Mechanism

Complex inorganic color pigments are synthetic, highly crystalline metal oxides, differentiated from simple metal oxides, as they contain two or more metals. The color of the compound is determined by the combination and location of the transition metal ions in the oxidic host lattice, otherwise known as chromophores. The transition metals are responsible for generating electronic d–d transitions, which are energetically weak, and therefore, the colors produced are not as bright and intense as other pigment types, for example, organic pigments.

Transition metal ions can easily substitute for metal ions in the host lattice if they have equal electronic charge. Often, combining several metals with different valence states produces a charge-balanced pair, demonstrating the complexity of the formulations used. Although transition metals are the color-forming centers, the hue can be shifted with dopants, that is, noncolored ions that can either occupy interstitial sites in the lattice, distorting the lattice shape, or can substitute into sites the lattice, producing a charge imbalance. These structures may be inherently more unstable and may produce less durable pigments.

84.2.2 Chemical Structure

Complex inorganic color pigments are dominated by two crystal structures, rutile and spinel, although there are many others.

Rutile pigments are largely titania-based, doped with metals such as nickel, chromium, or antimony at low levels.

84.2.3 Production Methods

Complex inorganic color pigments are produced commercially by solid state reaction, by heating intimate mixtures of metal oxides, salts, or hydrates at high temperatures between 1112°F (600°C) to 2552°F

TABLE 84.1 Crystal Structure Types

Crystal Structure	Typical Formula	Typical Pigment Type	Coloring Metal	Color
Rutile	MO_2	$(\text{Ni,Sb,Ti})\text{O}_2$	Ni	Yellow
Spinel	M_3O_4	$(\text{Co,Zn})\text{Al}_2\text{O}_4$	Co	Blue
Zircon	M_2O_4	$(\text{V,Zr})\text{SiO}_4$	V	Turquoise
Hematite	M_2O_3	$(\text{Fe,Cr})_2\text{O}_3$	Fe/Cr	Black/Brown
Cassiterite	M_2O_3	$(\text{Co,Zn})\text{SiO}_3$	Co	Blue

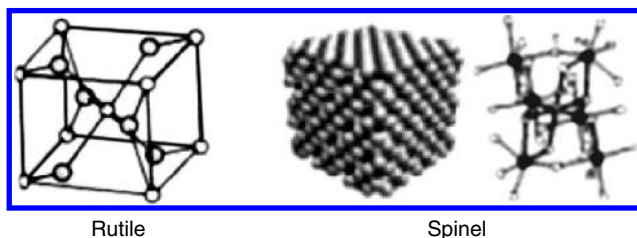
**FIGURE 84.2** Crystal structure types.

(1400°C). Intimate raw material mixtures are produced by wet milling techniques to ensure that all components are finely divided. The surfaces of grain boundaries are often coated to achieve the best reaction. Mineralizers can be used to aid the rate of reaction to ensure completion with minimum heat work; these are frequently used when producing zircon pigments.

The calcination process can be a batch process, loading the pigment manually into refractory saggars and firing in intermittent kilns, or it can be a continuous process using state-of-the-art rotary firing techniques.

The pigments have developed their full color during firing but are refined by milling to the required particle size, dependent on the application. Pigments for surface coatings, plastic, and glass applications are usually designed with a fine particle size and a narrow particle size distribution, for maximum tinting strength; conversely, pigments for ceramic applications tend to be coarser, with a wider size distribution, for maximum masstone color strength.

**FIGURE 84.3** Saggars firing.

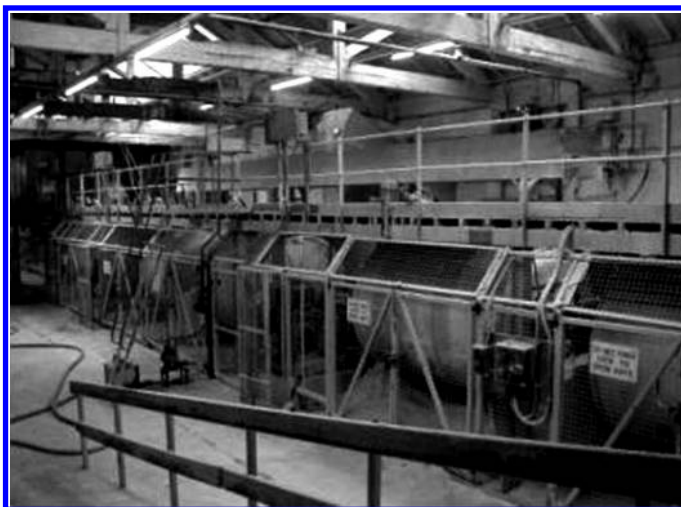

FIGURE 84.4 Milling.

TABLE 84.2 Common Rutile Pigments

Colour Index Reference No.	Typical Formula	Color	Main Commercially-Available Grades
Yellow 53	(Ni,Sb)TiO ₂	Yellow	BASF K1011 and Ferro PK9415
Yellow 216	(Sn,Zn)Ti ₂ O ₇	Yellow/Orange	Rockwood 34H1001, 34H1002, 34H1003
Brown 24	(Cr,Sb)TiO ₂	Buff	BASF K2011 and Ferro PK6070
Brown 164	(Mn,Sb)TiO ₂	Dark brown	BASF K2711

84.3 Pigment Types

84.3.1 Rutile Pigments

Rutile pigments consist primarily of titania, 70 to 90 wt%. They represent the largest class of pigments, with Brown 24 being the most significant, followed by Yellow 53. As with all CICPs, the coloring metal ions are trapped tightly within the host lattice and therefore are not extracted in use. The extractable metal content of all pigments is carefully controlled, making them suitable for food contact applications. The color shade can be altered by substituting antimony with niobium, tungsten, or barium; however, this increases the unit cost of the formulation, and therefore, these pigments are not regularly encountered.

Yellow 216 is the most recent innovation, introduced to the market in 2003. The range of yellow to orange colors is more intense than with the conventional titanates, with superior tinctorial strength. They contain a new Sn-Zn color center not reported in the industry before, surprisingly intense for two noncolored metal ions and probably caused by bandgap transitions, although this is still being investigated. This new chemistry comes at a time when increasing environmental concerns surround certain heavy metals; it offers an attractive alternative.

Manganese browns are gaining popularity, particularly in North America, as the best iron-free browns available for PVC claddings and vinyl sidings.

84.3.2 Spinel Pigments

Spinel pigments are largely aluminates or chromates. These formulations are modified by a number of dopant metals, each supplier striving to achieve unique shades. Generally speaking, titanates and aluminates offer brighter, cleaner shades than chromates.

Many ceramic-grade glaze stains and decorative colors are available from the main suppliers listed here.

TABLE 84.3 Common Spinel Pigments

Colour Index Reference No.	Typical Formula	Color	Main Commercially Available Grades
Green 50	(Co,Zn)Ti ₂ O ₄	Green	Ferro PK4045, Rockwood 34K48, Shepherd 223
Green 26	CoCr ₂ O ₄	Green	Rockwood 34K6, Ferro PK4047, Shepherd 179
Green 50	(Co,Zn,Cr)Ti ₂ O ₄	Turquoise	Ferro PK5500
Blue 28	CoAl ₂ O ₄	Blue	Rockwood 34L2000, Ferro PK5091, Shepherd 3
Blue 36	(Co,Cr)Al ₂ O ₄	Blue-green	Rockwood 34L2001, Ferro PK5095, Shepherd 9
Yellow 119	ZnFe ₂ O ₄	Tan	Rockwood Mapico 10A
Brown 29	Fe ₂ Cr ₂ O ₄	Brown	BASF K2975
Black 28	(Cu,Mn)Cr ₂ O ₄	Black	Rockwood 34E30, Ferro PK3085, Shepherd 1

TABLE 84.4 Common Zircon Pigments

Colour Index Reference No.	Typical Formula	Color	Main Commercially Available Grades
Yellow 159	(Pr,Zr)SiO ₄	Yellow	JM CS2300, JM CT1300
Blue 71	(V,Zr)SiO ₄	Turquoise	JM CS2500, JM CT1500
Red	(Fe,Zr)SiO ₄	Coral	JM 14M929, JM CT1100
Red	(Cd,Zr)SiO ₄	Red	JM CS2803, JM CT1805
Orange	(Cd,Zr)SiO ₂	Red	JM CS2202, JM CT1202

84.3.3 Zircon Stains

Zircon glaze stains can be divided into two groups: doped and encapsulated (or included) colors.

Praesodymium, vanadium, and iron dope the zircon lattice by substituting into zirconium sites, and form the basis of the triaxial colors, so called as they represent three corners of a cyan, magenta, yellow color set and therefore offer extremes of ceramic color. They are blended together to form a wide color palette for high temperature applications.

Cadmium zircon colors, however, are made by encapsulating discrete cadmium selenide pigment particles by zircon, producing a two-phase product. Encapsulation of the coloring compound is optimized by ensuring that the pigment phase is formed before the zircon phase, in a competitive reaction.

84.4 Pigment Properties

Complex inorganic color pigments are called high performance pigments because they are extremely durable in use. Further, these pigments show:

- Outstanding color retention after exterior exposure, in the presence of UV light, moisture, and heat
- Excellent heat stability
- Very good opacity to visual and ultraviolet (UV) light
- Good chemical resistance against attack from solvents, acids, and alkalis
- Chemically inert, combining well with other inorganic and organic pigment types
- Nonmigratory in polymers and plastics, showing no color bleed
- Highly refractive, with a tendency to abrade softer materials

Complex inorganic color pigments can actually enhance the overall lifetime of the coating or colored object. The pigment acts functionally by absorbing or reflecting UV radiation away from the binder. Most organic binders will degrade photocatalytically in such conditions, particularly in the presence of titania, which catalyses free-radical formation and accelerates the aging process.

These pigments are often used in conjunction with high color strength pigments to impart opacity and durability to a formulation, reducing the cost of the organic component of a formulation.

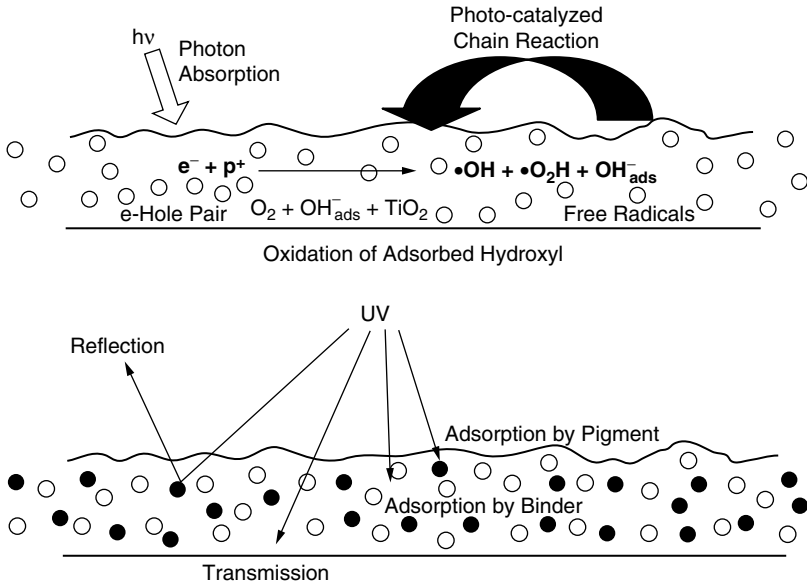

FIGURE 84.5 Mechanism of photocatalytic degradation.

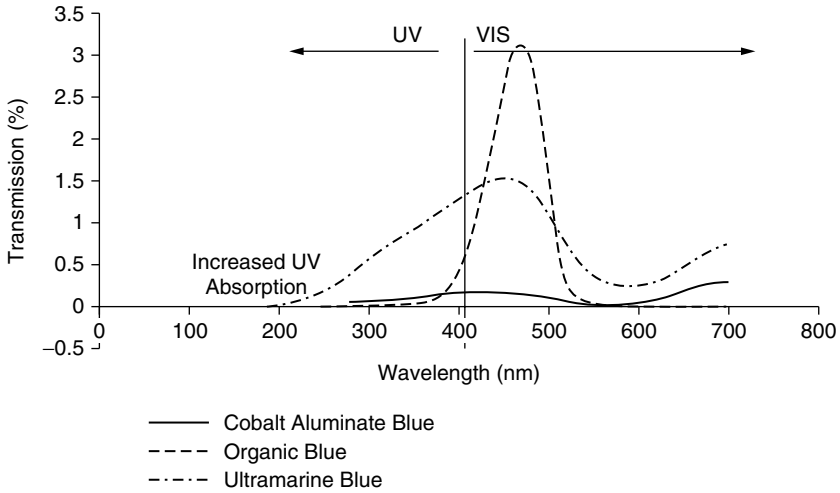

FIGURE 84.6 UV absorption of blue PVDF coil coatings.

84.5 Typical Applications

Complex inorganic color pigments are the pigments of choice where colored objects are subjected to high temperatures, UV light, or harsh chemical environments either during the manufacturing process or in use.

84.5.1 Surface Coatings

The highest performance surface coatings applications are usually for exterior applications such as coil coatings (used for building claddings), roofing, general construction parts, exterior paints (for example, masonry), and industrial and architectural paints.

Coil coatings usually adopt an acid catalyzed curing process that can be reactive to some pigment types. Coil-coated parts are bound by lengthy manufacturer guarantees of up to 25 years; hence, the highest performance pigments are required.

Exterior masonry paints can be based on permeable silicate paint technology to allow the underlying concrete or mortar to “breathe.” These paints are highly alkaline and are not compatible with organic or ultramarine pigments. With the increasing use of universal color tinters, formulated to be equally compatible with solvent-, water-, and silicate-based paints, CICPs are growing in popularity because of their wide compatibility.

Heat-resistant paints are used for barbeques, wood-burning stoves, car exhausts, and engine parts. These are largely silicone based, pigmented with copper chromite spinel black (CI Pigment Black 28).

84.5.2 Ceramics

A wide range of colors is available for applying to a range of tableware substrates, to suit all designs applied to elaborate dinner sets, hotelware, giftware, decorative ornaments, and collectables:

- Porcelain
- Bone and vitreous china
- Earthenware
- Stoneware

The same color palette is also used in the structural business to deliver high temperature fired color to sanitary-ware and floor and roof tiles.

Color is supplied as a glaze stain, where color pigment is supplied in powder form, or as a decorative color, supplied as a powder blend or liquid ink and containing a glass frit for glaze formation. It can also be applied as a predesigned decal transfer, ready for direct application.

84.5.2.1 Glaze Stains

The color palette typically consists of the following:

- Zircons (Praesodymium Yellow, Iron Coral, Vanadium Blue, Cadmium Red)
- Chrome Tin Pink
- Cobalt Aluminate or Silicate Blue
- Iron, Nickel, Chromium Browns and Blacks

Supplied as standard range color powders, they are blended to the desired custom colors and combined with transparent or opaque unleaded glazes for firing onto tableware and sanitary-ware.

84.5.2.2 Decorative Color

Decorative colors for tableware, giftware, and collectables are selected by firing technology:

- On-glaze color: twice-fired color applied and fired directly onto the substrate before the top glaze is applied and fired
- In-glaze and underglaze color: once-fired color applied onto or under the top glaze and fired simultaneously

TABLE 84.5 Traditional Glaze Compositions

Glaze Effect	Al ₂ O ₃ (%)	B ₂ O ₃ (%)	CaO (%)	K ₂ O (%)	Na ₂ O (%)	MgO (%)	SiO ₂ (%)	TiO ₂ (%)	ZrO ₂ (%)
Transparent	12.52	2.50	9.80	3.60	2.80	1.00	67.71	0.07	—
Opaque	11.35	2.26	8.86	3.22	2.50	0.92	64.70	0.09	6.10

Decorative colors are supplied as powder blends, custom powder blends color-matched to customized colors, or as liquid inks. They are available in 25 color sets or four-color CMYK sets for four-color printing techniques.

84.5.2.3 Decal Transfer Designs

CICPs are supplied as preprepared custom and standard color designs for tableware applications.

84.5.3 Building Materials

CICPs are widely used to color cement and concrete and mortar and grouting for outdoor pavings, swimming pools, and roof tiles. The alkalinity of the cementitious materials used demands inorganic pigments to ensure long-lasting coloration.

84.5.4 Glass

Glass enamel producers traditionally opt for CICPs largely in automotive and decorative applications. Heated rear windscreens contain black copper chromite, because a pleasing jet black appearance is retained after firing at elevated temperatures, without interference with the glass frit or the silver conductive track.

Decorative glass applications use a wide range of colored pigments, for example, the Pepsi red and blue trademark decorations for drinking bottles.

84.5.5 Plastics

Rigid PVC extruded or molded parts are used for window profiles, gutterings, and joints. These build up heat during the summer months and will readily degrade unless steps are taken to prevent it. Stabilizers are added to PVC to absorb UV light; careful selection of the pigment system used can also add value to the finished goods.

Silicone rubbers are frequently colored from compounded color concentrate, pigmented with CICPs. Copper chromite spinel black is a common colorant for production of nonconductive electronic housings and spark plug casings. The pigments used in such applications must be carefully controlled for extractable metals, because silicone polymers often contain residual monomers that can initiate premature polymerization.

Engineering polymers, used in automotive interiors and many domestic appliances, require high processing temperatures and, therefore, require CICPs for coloration.

Bibliography

Budnikov, P. P., and A. M. Ginstling, *Principles of Solid State Chemistry*, 1st ed. London: Maclaren & Sons Ltd., 1968.

Colour Index International, The Society of Dyers and Colourists, Bradford, England, 1997.

Cotton, F. A., and G. Wilkinson, *Advanced Inorganic Chemistry*, 5th ed. New York: John Wiley & Sons, 1988.

Johnson Matthey Ceramic Materials Division, Product Manual, Issue 1, May 1999.

Nassau, K., *The Physics and Chemistry of Color*, Advisory ed. New York: John Wiley & Sons, New York, 1983.

85

Polyurethane Associative Thickeners for Waterborne Coatings

Douglas N. Smith
*Waterborne Coatings–Global
Elementis GmbH*

Detlef van Peij
*Solventborne Coatings–Europe
Elementis GmbH*

85.1	Introduction	85-1
85.2	Chemical Structure and Thickening Mechanism	85-2
	Structure • Thickening Mechanism	
85.3	Flow Behavior and Related Properties Given by PEUPU Thickeners.....	85-3
85.4	Factors Affecting Thickener Efficiency	85-4
	Influence of Cosolvents • Influence of Surfactants and Emulsion Stabilizers • Influence of Latex Particle Size	
85.5	Delivery Form and Incorporation	85-6
85.6	Examples of Applications	85-6
85.7	Summary.....	85-7
	References.....	85-7

85.1 Introduction

Rheological additives are widely used in the coatings industry to provide ideal flow behavior. They control sag, leveling, penetration, and application properties along with many other fundamental coating characteristics. A large range of different rheological additives like cellulose ether derivatives, natural gums, alkali swellable emulsions, and clays is available. Newer polymeric materials — the polyether urea polyurethane thickeners (PEUPUs) — are very important for modern high-quality finishes. These are also known as urethane associative thickeners (UATs), polyether polyurethanes (PEPUs) or hydrophobically modified ethoxylated urethanes (HEURs).

PEUPUs are purely associative thickeners and behave totally differently from the more traditional products. They are used in both industrial and decorative systems and can be applied with a wide variety of techniques including spraying, rolling, and brushing. PEUPUs are used either alone or in combination with other rheological additives depending on the precise flow and other coating characteristics required. They are available as solids or suspensions of different concentrations. Although originally developed as leveling agents, they have been modified significantly, and the flow they impart varies from strongly shear-thinning to nearly Newtonian. These are the additives that give “solventborne” flow to “waterborne” paints.

The many benefits they bring to an application arise from their unique structuring mechanism. They offer a good balance of flow and leveling, excellent gloss characteristics, ease of handling, good brush-resistance and film-build and excellent roller-spatter resistance.^{1,2,3,4} As they are nonionic polymers, their function is also relatively pH independent.

However, the efficiency and performance of PEUPU thickeners is highly system dependent; also because of the associative structuring mechanism. Several factors influence this: in particular, the cosolvents used,

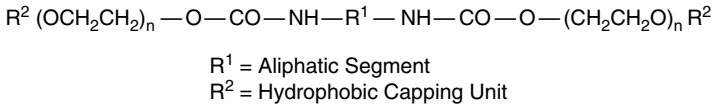

FIGURE 85.1 General chemical structure of PEUPU thickeners. [From H. N. Naé and R. H. Bank, *Rheology*, 91, 170–178 (1991).]

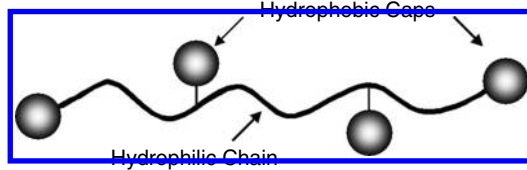

FIGURE 85.2 Diagrammatic representation of a PEUPU thickener.

system surfactants, and the particle size of the latex. To formulate effectively with these products, it is important to understand exactly how they function.

85.2 Chemical Structure and Thickening Mechanism

85.2.1 Structure

PEUPU thickeners are nonionic copolymers. They are normally produced by the reaction of a diisocyanate with a diol and a hydrophobic capping agent.^{2,3,5,6} Capping agents often contain hydroxy or amino groups and have chain lengths of C_{10} to C_{20} . The general chemical structure of a PEUPU thickener is shown in Figure 85.1.

This is given as a simplified diagrammatic representation in Figure 85.2. The products are similar to surfactants, having both hydrophilic and hydrophobic components. However, unlike a normal surfactant, the PEUPU molecule has a hydrophilic core chain with hydrophobic capping units.

85.2.2 Thickening Mechanism

The PEUPU rheological additives are purely associative thickeners. They develop intra- or intermolecular links as their hydrophobic groups associate with other hydrophobic ingredients in the formulation, notably the surface of the latex particles.^{2,3,4,5,7,8,9} This association depends on the number, size, and frequency of the hydrophobic capping units. The PEUPU develops micelles as would a normal surfactant. The micelles then link between the other ingredients by associating with their surfaces. This builds a three-dimensional network as depicted in Figure 85.3.

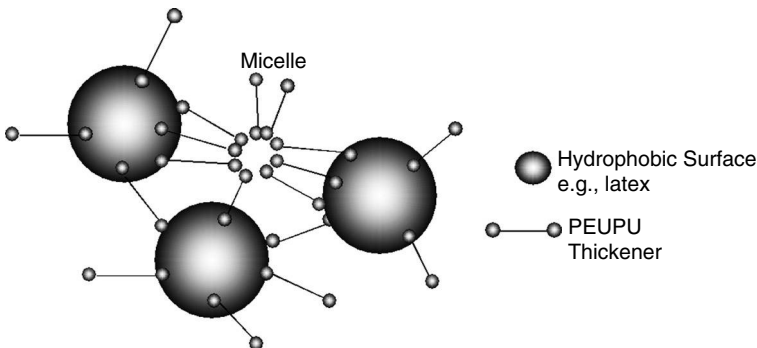

FIGURE 85.3 Thickening mechanism with PEUPU additives.

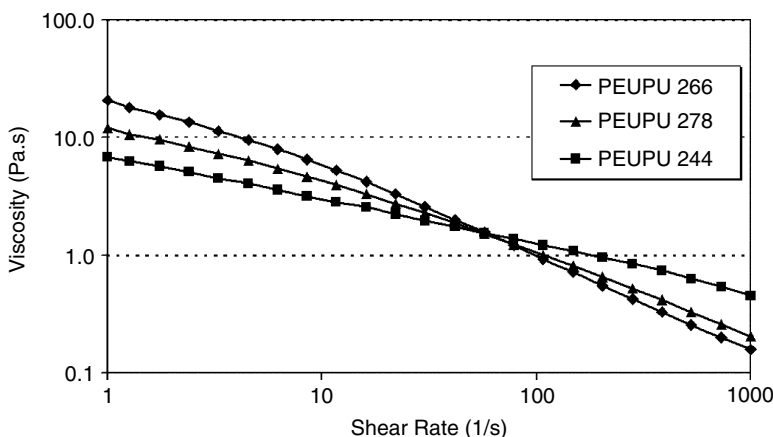

FIGURE 85.4 Flow behavior given by different PEUPU thickeners in a latex paint. (Adapted from *Rheology Handbook: A Practical Guide to Rheological Additives*, Hightstown, NJ: Elementis, Inc., 2000.)

The network is responsible for the structure and flow properties at low shear. It is in a state of dynamic equilibrium and as the shear increases, the associations break down and the viscosity decreases. However, the PEUPU molecules and their micelles can have large hydrodynamic volumes due to their shapes and the water they bind to their hydrophilic portions. They act like volume-filling particles even at very high shear rates, which probably explains the high residual viscosity found under such conditions.^{1,4,10} This property is fundamental to their use in coatings.

85.3 Flow Behavior and Related Properties Given by PEUPU Thickeners

The rheological behavior given by PEUPU thickeners can vary from strongly shear thinning to nearly Newtonian (Figure 85.4). This depends on the structure of the copolymer. A very hydrophilic PEUPU will give a flow that approaches Newtonian, whereas the more hydrophobic products give shear-thinning behavior.^{1,3,7,11} The immediate recovery of the micelle structure after shear is removed means that the viscosity is more pseudoplastic than thixotropic. For traditional systems, this would imply poor leveling. However, as the associations through the micelles are dynamic, the structure can relax after application, providing an excellent balance of sag control and leveling.

PEUPU 266 is more hydrophobic and PEUPU 244 more hydrophilic. The paints were all formulated to the same mid-shear or “can” viscosity (determined by Krebs Stormer). This would require a larger amount of a hydrophilic additive than of a hydrophobic one, as the association is weaker with the former. The higher quantity of additive used simply means it fills more volume and has more water tied to its micelle. The larger hydrodynamic volume generated is responsible for the viscosity found at high shear.^{1,4,11}

In practical terms, this viscosity gives more resistance during brush and roller application, which allows a thicker layer to be applied with each stroke. The PEUPU additives are therefore ideal for so-called one-coat formulations.^{7,12,13}

For systems that are to be spray applied, a low viscosity at high shear rates is preferred, as this allows controlled atomization for a fine uniform spray, and it prevents the nozzles from blocking. Earlier PEUPU thickeners, designed for Newtonian flow, were not suited for such applications. However, some more recent products are much more hydrophobic and shear thinning (e.g., PEUPU 266 in Figure 85.4). This means that the benefits offered by PEUPU technology can now also be enjoyed in spray-applied industrial formulations.⁷

Roller-spatter behavior is often related to the flow characteristics at high shear.^{3,4,7,14,15} The accepted wisdom in the coatings industry was that high viscosity at high shear rate meant good resistance to

spatter. However, the relationship is not so simple. Spattering occurs when the coating shows a high elongational viscosity or elasticity under shear. This is not the case with the PEUPU associative thickeners, as measurements of their elastic and viscous moduli have shown.^{1,4,8,11} Practice confirms that these products are ideal to overcome spatter problems.

85.4 Factors Affecting Thickener Efficiency

As the PEUPU thickeners are nonionic, they are relatively pH independent and can normally be used in the pH range from 2 to 12. This is seen as a significant advantage over other classes of additive. However, the association of a PEUPU with other ingredients in the formulation can be influenced by many other factors. The most important ones are as follows:

- Cosolvents
- Surfactants or emulsion stabilizers
- Particle size of the latex

Control of these is necessary to ensure optimum efficiency and stability. Formulation sensitivity is the main drawback of this class of thickeners. However, the problem can be overcome if the interactions involved are well understood. Several apparently negative aspects can even be used to the formulator's advantage. Useful guidance on the selection of the appropriate thickener and optimization of its performance is available in the literature.^{13,16,17} A summary of the influences of the most important variables is given below.

85.4.1 Influence of Cosolvents

The influence of cosolvents and coalescents on the viscosity developed by PEUPU thickeners is well documented.^{1,2,9} Examples are shown in Figure 85.5. Water-miscible solvents like butyl diglycol ether or propylene glycol can significantly reduce the efficiency of a PEUPU thickener at low to medium shear rates. This is most likely because the solvent changes the critical micelle concentration of the thickener and also because it makes the surface of the latex less attractive for association. Addition of a glycol-containing colorant or tinting agent to the base paint can also affect the flow for these reasons. This contributes to the so-called color-stability problem.

On the other hand, relatively water-immiscible cosolvents (low polarity) are sometimes able to increase the low-shear viscosity build. In this case, the cosolvent is absorbed into the latex particle, causing it to swell and present a much larger surface area for association.

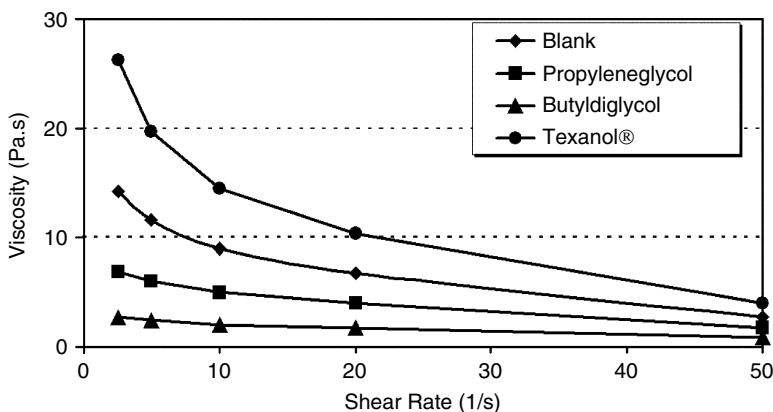

FIGURE 85.5 Influence of cosolvents and coalescents on the viscosity developed by a PEUPU thickener. In each case, 3% cosolvent was added to the pure acrylic latex.

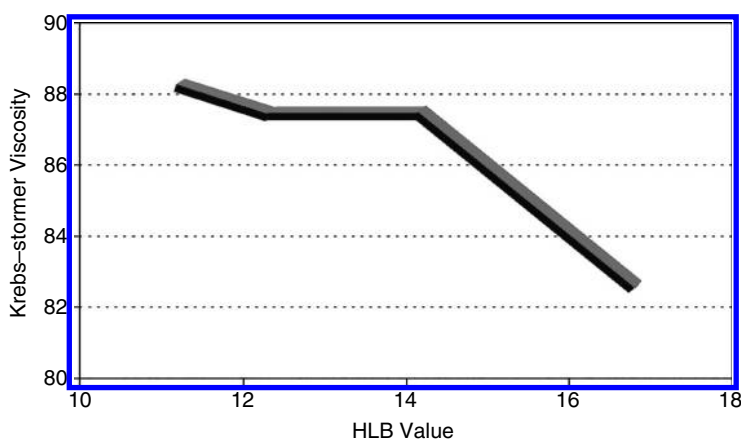

FIGURE 85.6 Influence of dispersant HLB value on the mid-shear viscosity developed by a PEUPU thickener in a standard latex paint. (After *Rheology Handbook: A Practical Guide to Rheological Additives*, Hightstown, NJ: Elementis, Inc., 2000.)

The cosolvent effect is observed to a much lesser extent at high shear rates, where the associative mechanism is no longer relevant.

The flow properties of a system can therefore be fine-tuned with the correct choice of solvent. However, care must be exercised when doing this, as the solvents also affect other coating properties profoundly.

85.4.2 Influence of Surfactants and Emulsion Stabilizers

Surfactants or emulsion stabilizers can also influence the low to medium shear rate viscosity developed by PEUPU thickeners.^{2,3,4,13,18} This is especially true for those with an HLB (hydrophilic lipophilic balance) value outside the range of 11 to 15 (Figure 85.6). Although no definite mechanism has been proved to explain this behavior, it seems likely that surfactants with a low HLB value link strongly with the hydrophobic capping units in the thickener and cause an increase in viscosity. This is normally at the cost of gloss and other film properties. Surfactants with an HLB above 15 can cause a loss in viscosity, probably because the HLB value of the thickener also lies in this range. The PEUPU molecule can leave its micelle and displace the surfactant on the latex or pigment surface. The micelle then shrinks and association weakens. This continues until an equilibrium is reached, which might take several months, and could explain the poor storage stability sometimes reported in such formulations.

When the latex is stabilized with very hydrophobic materials (e.g., cellulose or derivatives of PVA), the association with the hydrophobic caps in the PEUPU is weak. It is then necessary to add a large quantity of the thickener to get the required low-shear viscosity. It is usually more advisable to employ a mixed thickener package to avoid this problem, e.g., a cellulose or clay for low-shear viscosity and a Newtonian PEUPU for the high-shear performance.¹⁶

85.4.3 Influence of Latex Particle Size

The performance of a PEUPU thickener is also influenced by the particle size of the latex (Figure 85.7). As the association is with the latex surface, smaller particle size materials with their larger surface areas allow more efficient viscosity build.^{5,13} The effect can be significant, and care must be taken to ensure that latex supplies are consistent. If the particle size is large, working with a hydrophobic thickener will give the best results. If the latex has a very fine average size, then even a hydrophilic PEUPU can build viscosity at low shear rates.

If a range of different latex systems is used with different particle sizes and surface chemistries, the formulator should be prepared to use more than one thickener.

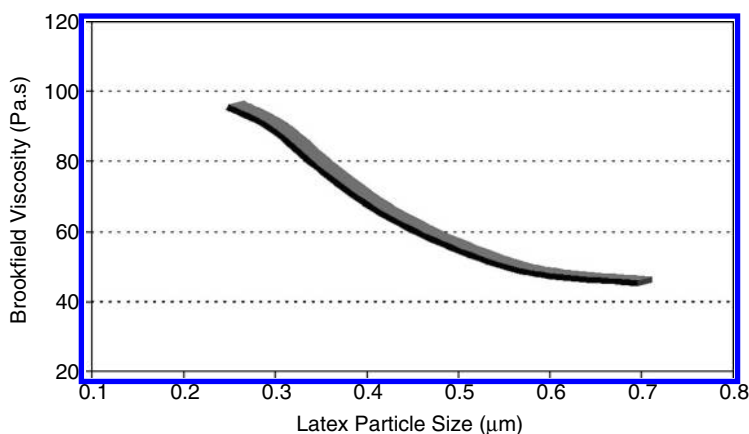

FIGURE 85.7 Influence of latex particle size on the mid-shear viscosity developed by a PEUPU thickener. (After *Rheology Handbook: A Practical Guide to Rheological Additives*, Hightstown, NJ: Elementis, Inc., 2000.)

85.5 Delivery Form and Incorporation

PEUPU thickeners are available in a variety of forms. They are supplied either as solids or as suspensions with active contents ranging from 15 to 50%. The suspensions normally contain a mixture of water with a cosolvent, which is necessary to make them flowable or at least pumpable. VOC (volatile organic component)-free suspensions are also available and are now becoming predominant. These normally contain a secondary surfactant, again to make them flowable. It is important to note that the efficiency of a liquid PEUPU thickener is not necessarily a function of its solid content, and it is dangerous to make simple cost comparisons on this basis. The form that is used depends on the plant restrictions and VOC requirements. The liquid forms are much preferred for ease of handling.

Liquid PEUPU thickeners can be added at nearly every stage of production and can often be simply stirred into a formulation. It is also possible to use them as post-thickening agents. However, order of addition can affect performance. If a PEUPU is added directly after the latex, for example, flocculation or gelation might occur. This is caused by high local concentrations of the two interacting ingredients and can be avoided by ensuring that the latex is well dispersed or by diluting the PEUPU additive with water before addition.¹⁶ It is important to establish the correct conditions for each formulation. Best results are usually obtained when the additive is incorporated at the end of a mill-base.

The solid versions of PEUPU thickeners have to be added early to the formulation as they need time for complete activation (approximately 20 min). They should normally be incorporated at the start of the mill-base. The presence of wetting agents and cosolvents significantly reduces the time for dispersion. The solid versions tend to have low T_g values and have to be stored properly to avoid agglomeration.

85.6 Examples of Applications

PEUPU thickeners are used for many different purposes depending on the requirements of the formulation. In one coating they could be used to improve roller-spatter behavior and hiding power, in another to improve leveling or storage stability. The desired objective will influence the precise choice of additive.¹⁷ No two PEUPU additives are identical in performance.

In traditional emulsion paints, cellulose ethers or modified clays are standard thickening agents. However, combination with a PEUPU additive giving a moderately shear-thinning flow offers a lot of advantages, such as better hiding power and less spattering during application. Leveling is also improved without influencing the sag resistance. This, together with a reduction in the quantity of cellulose ether or clay used, can give better gloss.

PEUPU thickeners are used extensively in high gloss industrial or decorative applications. Here they are typically used as single thickeners. The main criterion for selection is the precise flow required. Industrial spray-applied paints need strongly shear-thinning behavior with relatively low high-shear viscosity for good spray characteristics. Decorative paints, on the other hand, need more high-shear viscosity to give adequate film build. For paints that are to be applied with both brush and spray, a compromise is necessary.

The flow of a wood clear-coat is generally more difficult to control because of potential side effects caused by the additives. Small changes in gloss or haze can be detrimental to the visual impression of the surface. Special PEUPU grades have to be used for these applications. For spray-applied furniture coatings, the thickener should be hydrophobic for greatest efficiency at the lowest possible loading. This will minimize the risk of unwanted side effects. For parquet coatings, the thickener should give Newtonian flow to optimize leveling and retain high-shear viscosity for film build.

85.7 Summary

PEUPU thickeners are now available in many forms, offering a variety of rheological characteristics. Their thickening mechanism is purely associative, which leads to excellent flow and application properties.

The benefits of using these additives on the quality of the coating are tremendous. Properties such as leveling, spatter resistance, film build, transparency, and gloss can all be improved relative to those found with more traditional classes of thickeners. With careful selection, almost all flow problems can be solved.

Choice of the correct PEUPU depends on understanding not only the final flow requirements of the coating, but also the potential interactions with the other raw ingredients. Optimization of the flow can only be achieved if these interactions are well understood. Of greatest influence are the cosolvents used, the surfactant or emulsion stabilizer package, and the latex particle size. For effective formulation, close consultation with the additive supplier is recommended. This will ensure that the most appropriate thickener is chosen and potential problems are avoided.

References

1. T. Annable, R. A. Brown, J. C. Padget, and Avd Elshout, "Improvements in the rheological control of latex paints," prepared for Advances in Coatings Technology, 2nd International Conference, Katowice, 1996, Paper 17.
2. J. H. Bieleman, F. J. J. Riesthuis, and PMvd Velden, in D. R. Karsa, Ed. *Additives for Water-Based Coatings*. Cambridge: Royal Society of Chemistry, 1990, pp. 156–180.
3. P. Bissinger, H. -R. Seelig, in *Waessrige Siliconharz-Beschichtungssysteme fuer Fassaden*. W. Schultze, Ed. Renningen-Malmsheim: expert-Verlag, 1997, pp. 298–319.
4. P. A. Reynolds, *Prog. Org. Coat.*, 20, 393–409 (1992).
5. H. N. Naé and R. H. Bank, *Rheology*, 91, 170–178 (1991).
6. M. T. Tetenbaum and B. C. Crowley, U.S. Patent 4,499,233, February 12, 1985.
7. *Rheology Handbook: A Practical Guide to Rheological Additives*. Hightstown, NJ: Elementis, Inc., 2000, pp. 11–16.
8. R. D. Hester and D. R. Squire, Jr., *J. Coat. Technol.*, 69(864), 109–114 (1997).
9. U. Thies, in *Grundlagen zum Formulierung von Dispersions-Silikat-Systemen*. Ladenburg: BK Ladenburg, 1988, pp. 135–145.
10. A. Karunasena and J. E. Glass, *Prog. Org. Coat.*, 17, 301–320 (1989).
11. J. E. Glass, D. J. Lundberg, M. Zeying, A. Karunasena, and R. G. Brown, "Viscoelasticity and high shear rate viscosity in associative thickener formulations," in *Proceedings of the Water-Borne and Higher-Solids Symposium*, New Orleans, 1990, pp. 102–120.
12. F. Sauer and P. Manshausen, "Neue rheologie-additive fuer dispersionsfarben und industriellack-systeme," in *VILF Seminar, Neue Additive, Fuellstoffe und Pigmente fuer neue Lacksysteme*, Duesseldorf, 2000, pp. 62–73.

13. A. J. Whitton and R. E. Van Doren, "Formulating with rheological additives for latex paints," presented at the Advances in Coatings Technology 1st Conference, Singapore, 1991.
14. J. E. Glass, *J. Coat. Technol.*, 50(640), 53–60 (1978).
15. J. E. Glass, *J. Coat. Technol.*, 50(641), 56–71 (1978).
16. D. N. Smith and R. Klein, Optimising the Performance of Associative Thickeners in Waterborne Coatings. AddCoat 2001, Orlando, 2001, Paper 13.
17. D. N. Smith, Rheological Additives — Making the Choice. 23rd FATIPEC Congress, Brussels, 1996, pp. C151–182.
18. S. O. Williams, J. Neely, S. S. Kraus, and E. A. Johnson. Rheology Modifier and Dispersant Compatibility in Latex Paints. AddCoat 2001, Orlando, 2001, Paper 7.

IV

Surface Coatings

86

Flexographic Inks

86.1	Introduction	86-1
86.2	Process.....	86-1
86.3	Substrate.....	86-2
86.4	Vehicles.....	86-2
86.5	Colorants.....	86-3
86.6	Formulations	86-3

Sam Gilbert

Sun Chemical Corporation

86.1 Introduction

Flexography is a high speed printing process based on roll-to-roll mechanics where the inks are printed on a multitude of different substrates. In some cases, the substrate is sheet fed. The inks are based on colorants, resins, and solvents (organic or water), as well as various additives. The particular set of ingredients is determined by the substrate, product to be packaged, and application and process specifics.

The last few years have seen major changes and improvements in the finished, printed materials; therefore, the market share of this process in the packaging market has grown at a high rate. Some of the changes and improvements have included the inking system, the number of colors available on the presses, drying capacity of the equipment, press speeds, and changes in the inks.

86.2 Process

The materials printed using the flexographic process include much of the flexible packaging found in a supermarket, corrugated containers, folding cartons, and many printed consumer products as well (towels, tissues, diapers, cups, etc.). The upgrading of the process used to print these items has been dramatic in the last few years. Traditionally, the process was a three-roll system. Today, the predominant system uses enclosed doctor blades for the inking of the plates.

The three-roll system uses a rubber roll to pick up the ink in the fountain and transfer it to an anilox roll (an engraved metal roll or ceramic roll). The ink fills the engraved cells and is then transferred to plates (rubber or photopolymer). The image on the plate is raised from the surface background nonimage area. A final transfer then occurs of the ink to the substrate to be printed. The printed material then gets a final drying and is either rewound into a roll for future finishing or goes immediately to a lamination step.

The enclosed doctor blade system is the present inking system of choice. A doctoring blade (metal or plastic) is positioned so that it forms a trough for the ink. The ink is fed into this area that is against the anilox roll. The ink fills the engraved anilox cells, and excess ink is metered off by the blade. The metered ink is then transferred to the plate and continues on as in the three-roll system.

In both systems, the amount of color to be transferred to the substrate is determined by the amount of color in the ink, its viscosity, and the volume of cell engraving in the anilox as well as the number of cells present. What the system changes have brought about is the following:

- Better control of viscosity due to reduced solvent loss in an enclosed area
- The ability to use finer anilox cells, because the ink can be kept fluid
- The ability to make the resulting ink stronger
- Enhancement of the product made with the enclosed blade system, as it is then stronger, brighter, sharper, and cleaner than what was previously possible.

The above noted changes also should include the use of more process printing (four-, six-, or seven-color) Also, the printing plates have become finer. At one time, 85 line plates were typical. Today, we are seeing the use of 150 line plates. The plates are also changing. They were originally rubber and are now usually photopolymer and shaped to give much improved fidelity.

Another recent change is the movement to larger, more automated presses with more color decks (10), faster printing speeds, and better drying capabilities.

86.3 Substrate

The next consideration is the substrate to be printed. These include a much wider range of materials, such as paper, board, polyolefins, polyesters, nylons, foils, metallized films, coextruded films, etc. The attributes desirable in the finished package will usually determine the substrate or substrates to be used. Surface printing or lamination is also decided upon by considering the product needs. What is to be packaged? Is it solid or liquid? Is it fragile or flexible? Is the product perishable, corrosive, or moisture or light sensitive?

Obviously, there are too many variables to be listed here. They all affect the final package appearance and affect the decision as to what materials we will use in the inks.

86.4 Vehicles

Once we decide what substrate will be used and whether the package will be surface printed or laminated, we can determine what ink vehicle will be used. The vehicle contains resins for adhesion, solvents for flow and drying, and additives for various finished attributes.

The first decision is resin. What will give us adhesion to the substrate, provide resistance to the product, if necessary, and give high gloss if desired. The resin provides many crucial properties:

1. Adhesion to the substrate
2. Gloss
3. Product resistance
4. Lamination-bond strength
5. Viscosity
6. Solvent release

Most of the inherent needs of the package are first met with resin choice. The resin is the material that carries the pigment to the substrate and provides for flow and ease of application in the press. The new processing concerns have caused the ink maker to rethink what resins and solvents are necessary for good ink flow and printability.

If the resin suspends and supports the pigment (colorant), it is the solvent in the vehicle that carries the resin to the substrate. The ratio of solvent to resin provides viscosity and flow to the ink. The types of solvents used are determined by the resin choice. Some resins prefer specific solvents. Some of the solvents used in flexo are as follows:

1. Alcohols
2. Acetates
3. Hydrocarbons
4. Glycol ethers
5. Water

The key to solvent choice is solubility of the resin in that solvent. Also critical is the ability of the resin to release the solvent during printing so that solvent retention problems do not occur. Solvent retention can lead to odor or taste in the package and poor bonds in a lamination. Also, of course, plates and solvents must be compatible. Plates must not be attacked by the solvents and must release the inks easily to insure good transfer to the substrate. With the advent of the new low volume aniloxes and high lineage plates, inks are being made to run at higher strength and, actually, low viscosities, relatively. This means that solvent systems are made with slower evaporating solvents so that printing is clean. Resins must then release solvents better.

86.5 Colorants

The choice of colors and colorants completes the process of putting together an ink. The colorant is an organic or inorganic material that is insoluble in the solvents used in the vehicle. In prior years, dyes (soluble in the vehicle) were used. Dyes have pretty much disappeared due to bleed concerns into the substrate or the packaged product. The pigment-to-resin ratio in an ink depends on the color strength required and the viscosity of the application. The pigment is dispersed so that agglomerates are eliminated and all pigment surfaces are coated with resin and vehicle. This insures good flow, clean printing, and good adhesion to the substrate as well as good gloss.

To obtain the desired color strength on the substrate, the viscosity of the ink must be controlled. High viscosity gives strong color but often poor print quality. Low viscosity gives low color strength. Solvent decisions lead to the optimum viscosity. After printing, the solvent must be removed from the print. This is done by evaporation in an oven. Airflow in the oven should be negative to insure lowest retained solvents. More ink should be pulled out than pushed into the oven.

86.6 Formulations

Formulations can be based solely on organic solvents or can be water based. Solvent-based formulations are preferred for plastic substrates. However, there are exceptions to this. Water ink systems are preferred for paper and paperboard applications:

- Solvent Systems — Typical
 - Pigment: 15%
 - Resin: 25%
 - Waxes: 1%
 - Solvents: 59%
- Water Systems — Typical
 - Pigment: 15%
 - Resin emulsion: 55%
 - Resin solution: 4%
 - Caustic material: 4%
 - Wax: 1%
 - Antifoam: 0.5%
 - Water: 16%
 - Solvent: 4.5%

Solvent-based systems are available for paper as well as plastic. And likewise, water systems are available for almost all plastic surfaces as well as paper. The formulas above are typical and include myriad resins and different resin types. Also, of course, pigments may vary widely in appearance and application. Many different pigments are typically used. The formulations above show wax additives and antifoams, but many other materials are used in small quantities to achieve specific end-use attributes.

Multicolor Coatings

87.1	Introduction	87-1
87.2	Practice of the Art	87-1
	Continuous Phase • Dispersed Phase • Combining Dispersed and Continuous Phases	
	References	87-2

Robert D. Athey, Jr.
Athey Technologies

87.1 Introduction

A standard paint is a single shade attained by a mixture of many finely ground pigments so that one perceives a homogeneous shade. But natural products are seldom homogeneous in color. They are striped and spotted with dark and light regions of varying size. To reproduce this appearance in a painted surface, multicolor coatings are used that yield a multicolor appearance in one coat. Zola¹ discusses multicolor coatings of a natural appearance, with striations from brush application and mottling from roller or spray application. Multicolor paints are used as interior architectural coatings for public buildings and have been used in automotive trunk interiors.

87.2 Practice of the Art

Little is published on the practice of formulation or making the multicolor coating. Zola patents show multicolor formulations.²⁻⁸ The major sources of information are the patents and publications⁹⁻²³ and the commercial brochures describing the products used and specific formulation technology.

87.2.1 Continuous Phase

The continuous phase in a colloidal mixture is called the dispersion medium (e.g., water in milk, air supporting the droplets of water in a fog). The continuous phase must be a fluid that has a sufficiently low viscosity at high shear rates to allow easy application of the paint. If it is too stiff, the drag on the brush will tire the painter, or the fluid will not be properly atomized in a spraying application. However, at low shear rates, the viscosity must be sufficiently high to slow the settling out or the agglomeration and coalescence of particles.

Colloidal additives are used to protect such dispersions. Protective colloids are added to increase storage stability. Methyl cellulose, polyvinyl alcohol, and various nonionic surfactants are the most often used protective additives. These materials adsorb onto the surface of the suspended materials to form a jellylike layer that inhibits coagulation. Another approach is to induce an electrical charge on the globule surface, so that the globules will repel each other. Ionic surfactants, salts, or charged clay particles are commonly added to induce surface charges.

The stabilization of suspended globules is absolutely necessary to prevent the coalescence and mixing of different colors. This ability must extend during the coating drying as well: the individual spots must have distinct boundaries with the next spot of a different color. This requires that the paint dry quickly.

87.2.2 Dispersed Phase

The suspended materials should not coalesce within the globule. The viscosity of the paint globules must be sufficiently high to maintain the pigment dispersed and to inhibit coalescence of adjacent globules. The pigment dispersion medium and the polymeric binder used must be insoluble in the continuous-phase liquid. Pigment binder must be chosen to yield a sprayable system that does not cobweb during spraying. Usually, the formulation requires a slowly evaporating solvent or a low molecular weight binder, or both. The polymeric binder should be curable to yield the solvent resistance and scrubability needed in a wall coating.

87.2.3 Combining Dispersed and Continuous Phases

Formulations for dispersed and continuous phases are made separately. The phases should remain separate after combining, and that requires incompatibility between the components of separate phases. An ingredient in one phase should not be extracted by the other phase. Both phases should be of nearly equal density to minimize settling or creaming of the dispersed phase, which might encourage coalescence of the dispersed-phase globules.

References

1. J. C. Zola, *Mod. Paint Coat.*, August, 17 (1975).
2. S. Grasko and S. S. Kane, U.S. Patent 3,370,024.
3. J. C. Zola, U.S. Patent 3,458,328.
4. J. C. Zola, U.S. Patent 3,573,237.
5. J. C. Zola, U.S. Patent 3,811,904.
6. J. C. Zola, German Patent 1,261,974; *Chem. Abstr.* 68,88261y.
7. J. C. Zola, U.S. Patent 2,591,904.
8. J. C. Zola, U.S. Patent 3,725,089.
9. J. L. Petty, U.S. Patent 3,058,932.
10. R. L. Sears, U.S. Patent 3,138,568.
11. D. K. Lesser, U.S. Patent 3,809,119.
12. F. F. Gourion, French Addn. 88224; *Chem. Abstr.* 67,65475q.
13. C. H. Coney, U.S. Patent 3,356,312.
14. R. Rutkowski, German Patent 1,723,730; *Chem. Abstr.*, 80, 60081m.
15. Y. Shiota et al., Japanese Patent 79,87738; *Chem. Abstr.*, 92, 24442w.
16. Nippon Carbide Industrial Co., Ltd. Japanese Patent 7i6i, 2487; *Chem. Abstr.*, 85, 79787j.
17. D. A. Hilliard, U.S. Patent 3,038,869.
18. P. Talley, *Paint Ind.*, 74(5), 10 (May 1959).
19. D. A. Hilliard, *Off. Dig.*, June, 4 (1960).
20. E. W. Flick, *Solvent Based Paint Formulations*. Park Ridge, NJ: Noyes Data Corp., 1977, p. 415.
21. M. Schwefsky, U.S. Patent 2,658,002.
22. K. Nelson, U.S. Patent 3,024,124.
23. H. Hondo and Y. Nakamuro, U.S. Patent 3,360,487.

Paintings Conservation

Varnish

Christopher W.
McGlinchey
The Metropolitan Museum of Art

88.1 Introduction	88-1
88.2 Effect of Varnishes.....	88-1
88.3 Types of Varnishes.....	88-2
References.....	88-3

88.1 Introduction

To understand the properties of a varnish that satisfy the requisites of paintings conservation, it is necessary to introduce the rudiments of conservation and the artist's original reasons for varnishing. It is also important to mention that no varnish currently exists that satisfies all the needs of a paintings conservator, though great progress has recently been made.¹⁻³

88.2 Effect of Varnishes

Picture varnishes used for the restoration of paintings are intended to create the same optical effect on the painting that was achieved by the artist but subsequently lost as a result of chemical and physical changes of the original varnish layer. An artist, for instance, relies on varnish to create the perception of the third dimension and the saturation of colors as well as to achieve some degree of glossiness in the process. The deleterious ramifications of a visibly aged varnish are not confined to the obvious yellowing of the colors; in addition, the lightening of dark passages and the darkening of lighter areas may result in a reduction in the range of color one visualizes. How these changes affect the painting depend on the style and subject matter of the painting as well as the materials the artist used. It is, however, safe to say that in any circumstance, these changes divert the purpose of the picture.

It is most often changes in the varnish layer that can obscure or confuse an artist's original intentions. Unfortunately, badly aged varnish is not the only factor that can upset the balance of a painting: some pigments are fugitive and thus fade; binding media can yellow; and furthermore, the various components of the painting as a whole respond differently to climatic changes in the environment, causing more brittle areas to crack under stress. Fortunately, the sensitive, well-trained conservator, through scholarly and scientific assistance, best understands how these inevitable acts of time affect the balance of a painting and how the work was originally intended to read. With the greatest caution, using fully reversible materials and techniques, conservators can restore much of this balance, depending on the extent of change that has overcome the painting.

The effect of varnish on a painting cannot be ignored; in fact, there have been some movements in art history that preferred the matte appearance of an unvarnished picture, most notably the Impressionists and Cubists.⁴⁻⁶ (The responsible conservator will honor the artists's choice and refrain from ever varnishing such a picture.) On the other hand, an artist who chooses to varnish a painting has most certainly

decided to do so from the inception of the painting process; this is known, because varnish affects a painting so profoundly that when present, it enters the artist's thoughts as an integral component of the formulation for the desired effect.

Neglecting the optical effect of varnishes on paintings while attempting to use them for other reasons often produces calamitous results. For instance, conservators who apply varnish as "protective" coatings would cause drastic changes in tonal values that have been carefully achieved by the artist; consequently, these values become far removed from what the artist originally intended. In this circumstance, one would prefer an inert coating that does not affect the substrate optically: unfortunately, and for obvious reasons, no such coating exists. The protection of a painting is much more successfully managed through control of light levels, filtering out ultraviolet radiation, and minimizing large temperature and relative humidity fluctuations in the ambient climate.

88.3 Types of Varnishes

Briefly, artist's natural varnishes used for centuries have ranged from the very early use of egg whites as a surface coating to recipes of oil varnishes to the more recent use of natural resins that are soluble in mineral spirit. (For a more complete treatment of artists' varnish recipes, see [References 7 and 8](#).) The most common mineral spirit soluble natural resins are mastic and dammar, which are predominantly tetracyclic triterpenoids derived, respectively, from the tree families Dipterocarpaceae and Anacardiaceae.^{9,10} Damar has been well liked because of its ease of solvation and relative nonyellowing properties, which are attributed to its low acid value compared to other natural resins. Mastic has highly admired brushing and handling properties, which enable subtle optical effects, but it tends to yellow somewhat more than dammar. Both these resins are rather brittle, with poor mechanical strength compared to the durability of modern industrial coatings. However, there is little need for this relative inflexibility to be a serious concern, because the museum environment is mild compared to the rigors of outdoor tests that most industrial finishes must not fail.^{3,9}

Mineral spirit soluble resins in theory are acceptable as conservation varnishes because they dry only by solvent loss (i.e., by a lacquer-type drying process) and not any subsequent polymerization. This property permits these resins to be removed at a later date, without affecting the paint layer. Solubility happens to be a criterion of great importance to the paintings conservator, because any additions by the conservator's hand must be reversible and distinct from the original, though not necessarily in appearance. In practice, these mineral spirit soluble resins oxidize, thus requiring more polar solvents for their solvation, thereby introducing a greater threat to leaching some components of the painting's binding media.^{11,12} Even though chemical changes cause natural varnish resins to yellow, bloom, and embrittle, few synthetic resins can achieve the same optical qualities under many of the frequently encountered conservation circumstances; hence, these natural varnishes are still in use by conservators today. (Recently, de la Rie along with this author demonstrated that in a UV-free environment with the use of a hindered amine light stabilizer and a benzotriazole, stabilization of dammar is possible.)¹³

Thus far, the three most important criteria for conservation have been introduced. The criterion of utmost importance is respect for the artist's thoughts and achievements; second, any conservation must be reversible and not permanently bonded to the artist's original work; and finally, the material's stability must be considered. Stability is the single most distinguishing factor above the capabilities of an artist's varnish; whereas the artist is usually more concerned with optical effect than with stability, the conservator is accountable for both properties. With the scientific developments of polymeric materials of the 20th century, a variety of synthetic resins have come into use by artists as well as conservators. These materials possess remarkable stability or remarkable handling properties but, unfortunately, not both.

Synthetic varnish resins that dry only by solvent loss, not subsequent polymerization, range from low molecular weight oligomeric ketone resins to higher molecular weight polyvinyl acetates and copolymers of alkyl methacrylates. Though the high molecular weight synthetic resins possess remarkable stability and durability, their optical properties are seriously compromised when compared to the former low molecular weight resins. On the other hand, the synthetic low molecular weight (e.g., ketone) resins

often suffer from much of the same degradative problems as the natural resins do. Work has been carried out by de la Rie and Shedrinsky¹⁴ to reduce the carbonyl groups of ketone resins to an alcohol functionality to prevent the hemolytic bond cleavage associated with carbonyls (Norrish type I and II reactions) and furthermore to esterify a fraction of the —OH groups to reduce the brittleness of the resin.

It has been shown by de la Rie⁴ that films cast from high molecular weight varnish resins have a low distinctness of image value when applied over a rough surface. Lee¹⁵ has illustrated leveling properties of such coatings on rough substrates using cross-sectional photographic methods, achieving the same results. These experiments indicate that high molecular weight thermoplastic solution varnishes reproduce the contours of the substrate underneath and, if smooth, have the capability of being glossy; if rough, however, they will produce a matte effect as elucidated by the authors. Furthermore, de Witt¹⁶ has shown from visual tests involving a group of conservators that varnishes possessing both a high refractive index and a low viscosity grade create an ideal optical surface, taking into consideration that a resin possessing these qualities should be of low molecular weight and should have an oligocyclic structure (the latter contributing to the material's high refractive index).

Because conservators are faced with the problem of having to create a specific saturation and gloss on a painting with substrate that may not be entirely uniform, it is strongly desired to use a varnish that would appear optically consistent over a rough or smooth surface. As discussed earlier, this is best achieved with the use of a low molecular weight resin. Recently, de la Rie and this author recommended some new materials to conservators for their experimentation, to determine whether the handling properties of these resins permit the desired optical effect. Ultimately, the appropriate optical effect is one of the essential qualities for understanding and appreciating paintings.

References

1. E. R. de la Rie, "Stable varnishes for Old Master painting," Ph.D. dissertation thesis, University of Amsterdam, 1988.
2. R. L. Feller, N. Stolow, and E. H. Jones, *On Picture Varnishes and Their Solvents*. Washington D.C.: National Gallery of Art, 1985.
3. G. Thompson, "New picture varnishes," in *Recent Advances in Conservation*. G. Thomson, Ed. London: Butterworths, 1963.
4. E. R. de la Rie, "The influences of varnishes on the appearances of paintings," *Stud. Conserv.*, 32, 1–13 (1987).
5. John Richardson, "Crimes against the Cubists," *New York Review of Books*, June and October (1983).
6. R. Ruurs, "Matte or glossy? Varnish for oil paintings of the 17th century," *Intermuseum Conserv. Bull.*, 16, 1 (November 1985).
7. A. del Serra, "A conversation on painting technique," *Burlington Mag.*, 127(982), (January 1985).
8. R. Mayer, *The Artist's Handbook of Materials and Techniques*. New York: Viking, 1982.
9. C. Mantell, *The Technology of Natural Resins*. New York: Wiley, 1942.
10. J. Mills and R. White, "Natural resins: Their art and archaeology, their sources, chemistry and identification," *Stud. Conserv.*, 22, 12–31 (1977).
11. E. R. de la Rie, "Photochemical and thermal degradation of films of dammar resins," *Stud. Conserv.*, 33(2), 53–70 (1988).
12. N. Stolow, "Some investigations of the actions of solvents on drying oil films," *J. Oil Chem. Colour Assoc.*, 40, 337–402, 438–499 (1957).
13. E. R. de la Rie, and C. McGlinchey, in preparation; to be published in *Studies in Conservation*.
14. E. R. de la Rie, and A. Shedrinsky, "The chemistry of ketone resins and the synthesis of derivative with increased stability and flexibility," *Stud. Conserv.*, in press.
15. S. Lee, "An investigation into the contouring properties of some picture varnishes," Master thesis, Hamilton Kerr Institute, University of Cambridge.
16. E. de Witte et al., "Synthesis of an acrylic varnish with a high refractive index," Ottawa: ICOM Committee for Conservation, 16(4), 1–7 (1981).

89

Thermoset Powder Coatings

89.1	Introduction	89-1
	Powder Coatings Defined • The First Powder Coatings • Thermoset Beginnings • The Beginning of Growth • The World Discovers Powder Coatings	
89.2	Processing and Equipment	89-3
	Premixture • Extrusion • Grinding • Sifting and Classifying • Application Equipment	
89.3	Chemistry.....	89-6
	Epoxy Systems • Polyester Systems • Acrylic Systems	
89.4	Formulation.....	89-11
	Resin Systems • Pigments and Fillers • Additives	
89.5	End Uses	89-12
	References	89-12

Lawrence R. Waelde
Troy Corporation

89.1 Introduction

In recent years, awareness of environmental conservation and pollution prevention has risen steadily. Governmental regulation and true concern for the environment have motivated chemists to modify all types of coatings to reduce environmental impact. The concept of environmental “friendliness” has dramatically changed the way that coatings are formulated.

Powder coatings are arguably the most environmentally “friendly” coatings. They do not contain solvents to be released as hazardous air pollutants (HAPs). Powder coatings release very low amounts of volatile organic compounds (VOCs) during the baking cycle. They produce virtually no waste material. And, they contain very few hazardous chemicals. (Note: The few hazardous chemicals that have found their way into powder coatings are decreasing as they are replaced with safer materials.)

89.1.1 Powder Coatings Defined

Powder coatings can be described as “ground up dry paint.” They may also be referred to as pulverized plastics. They have properties in common with both materials. The polymeric resins that are used in producing powder coatings are similar in nature to those used in both paints and plastics. All three materials are composed of combinations of resin, pigment, filler, and various additive materials. They may be thermoplastic or thermosetting.

The primary difference between the three types of compounds is the molecular weight range of the polymers used as binders. Plastics use the highest molecular weight resins, paint the next highest, and powder coatings the lowest. Paint, of course, also contains various solvents to dissolve or dilute the coating for easy application.

89.1.2 The First Powder Coatings

Powder coatings are relatively new finishes. The first application of a “dry paint” occurred in the 1940s.¹ At that time, pulverized thermoplastic formulations were flame sprayed over metallic substrates. The plastics melted in the flame, flowed onto the substrate, and cooled there to form a protective coating. This was a poor way to apply a protective barrier, as it was very wasteful. Material decomposed in the flame and was lost. Furthermore, there was very little control of film uniformity or thickness that was built up on the substrate. It was not uncommon for films to exceed 100 mils (~2500 microns).

In 1950, a British patent was issued to Schori Metallizing Process, Ltd., for a “hot-dip” coating process.² By this process, a heated metal part was dipped or rolled in a thermoplastic powder. Loss through decomposition was minimized, but film build was still extremely high. It was also difficult to maintain clean plant conditions, as handling the parts throughout the coating process produced high dust conditions.

The next innovation in the application of thermoplastic powders occurred in 1953. A patent was applied for by Erwin Gemmer of Knapsack-Griesheim AG (later acquired by Hoechst) for a “fluidized bed” coating process.³ By this process, pulverized material is “floated” in a container by upward movement of airstreams that are forced to diffuse through a bed of porous material. The floating powder takes on properties of a fluid in that the particles “flow” in the airstreams much like molecules of boiling water bubbling in a saucepan. A German patent was issued for this process in 1955 and a U.S. patent in 1958.⁴

In fluidized bed application, the metal substrate is heated above the melting point of the powder and dipped into the fluidized material. Powder that touches the metal melts and adheres to the part. The part is then transported to the following stage of production by conveyor. The process is much cleaner than dipping or rolling, but film build is still very high.

89.1.3 Thermoset Beginnings

Up to this point, all powder coatings were thermoplastic in nature. Thermoset powder coatings were just beginning to be explored. The first trials were made with existing resins or slightly modified polymers. They had low glass transition points (T_g) and tended to sinter (cake) upon standing for any length of time.

In the early 1960s, two developments occurred almost simultaneously. The first development was the invention of storage stable thermoset powder coatings.⁵ They were epoxies based on diglycidyl ethers of Bisphenol A. The second invention was the electrostatic spray gun, which was capable of applying a powder coating under controlled conditions.⁶

Electrostatic application of powder coatings is performed by pumping a stream of coating particles in an airstream past a high voltage cascade generator. The powder acquires an electrostatic charge and flows through the generated electrical field to a grounded metal substrate. The substrate is then transported to an oven where the coating melts, flows out, and is cured.

89.1.4 The Beginning of Growth

The electrostatic spray gun is probably the single most important invention in the rapid growth of thermoset powder coatings. With this equipment, virtually all of a powder coating product can be used in application, as oversprayed material can be reclaimed and used. Film build can be reduced to less than 5 mils (~125 microns). In fact, film thickness similar to that possible with liquid coatings can now be achieved (<1.0 mil or ~25 microns).

It has been reported that the world production of thermoset powder coatings in 1962 was around 16,000 lb (ca. 7.3 metric tons). All of these coatings were epoxies. By 1966, the volume had grown to 100,000 lb (ca. 45.4 metric tons).

During 1969, the first polyester resins designed for thermoset electrostatically applied powder coatings were developed.⁷ They took a long time to cure and had caking problems. Nevertheless, powder coating production continued to increase.

By 1972, the world production of thermoset powder coatings had grown to 11.6 million pounds (ca. 5300 metric tons). That same year, the first carboxyl-terminated polyester resins were produced.⁷ They

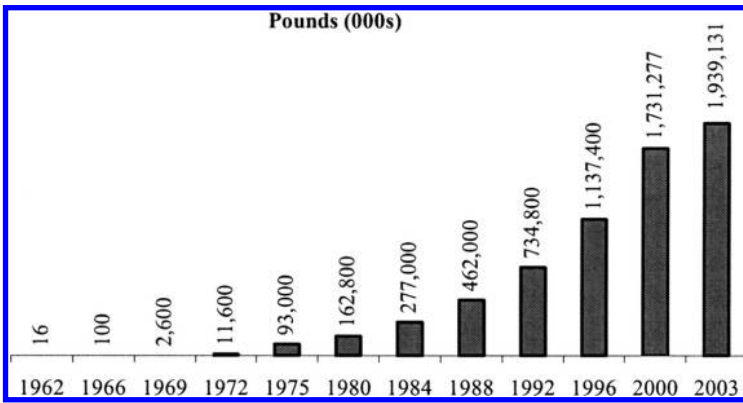

FIGURE 89.1 Worldwide growth of powder coating production for the years 1962 through 2003.

were the first polyester resins that eliminated the problem of outgassing due to reaction products forming bubbles and pinholes in the coating film.

Polyester resins with higher reactivity and, therefore, faster cure, were first introduced in 1974.⁷ They started to gain in popularity in the next couple of years, and by 1983, the first trimellitic anhydride-free (TMA) polyesters were produced.⁷ These were the earliest attempts to eliminate hazardous chemicals from powder coating formulae.

89.1.5 The World Discovers Powder Coatings

Powder production continued to grow at a fantastic rate. World production had grown from 162.8 million pounds (74,000 metric tons) in 1980 to 633 million pounds (ca. 290,000 metric tons) in 1990.⁸

About that time, it was discovered that TGIC (triglycidyl isocyanurate) could cause mutation in the chromosomes of lab mice. TGIC had been used as a cross-linker with certain carboxyl-terminated polyesters to produce extremely durable exterior coatings.

Immediately, chemists began to search for nonmutagenic alternatives. And, in 1990, the first non-TGIC cross-linkers for polyester resins were introduced.⁹ The first was a β -hydroxyalkyl polyamide. It was followed in 1991 by tetramethoxymethyl glycoluril.

Even with the concern over mutagenic materials, powder production has continued to grow rapidly. Worldwide production of thermoset powder coatings for 1996 exceeded 1.13 billion pounds (over 1/2 million metric tons). The projected growth for the year 2002 is more than 1.8 billion pounds (>827,000 metric tons) worldwide and for 2003, it was over 1.9 billion pounds (> 880,000 metric tons) (see Figure 89.1).

89.2 Processing and Equipment

The process of producing a powder coating is somewhat more complex than that for other types of coatings. The equipment needs are more numerous. The production time is also somewhat longer. This section will describe each of the necessary pieces of equipment in the order that they are used during the process of making a powder coating.

89.2.1 Premixture

The first step in the manufacture of a powder coating is the premix stage. This is the most crucial phase of production. The various sizes of resin flake, pigment powder, etc., must be transformed into a homogenous blend of similar particle size before they enter the following stage — extrusion.

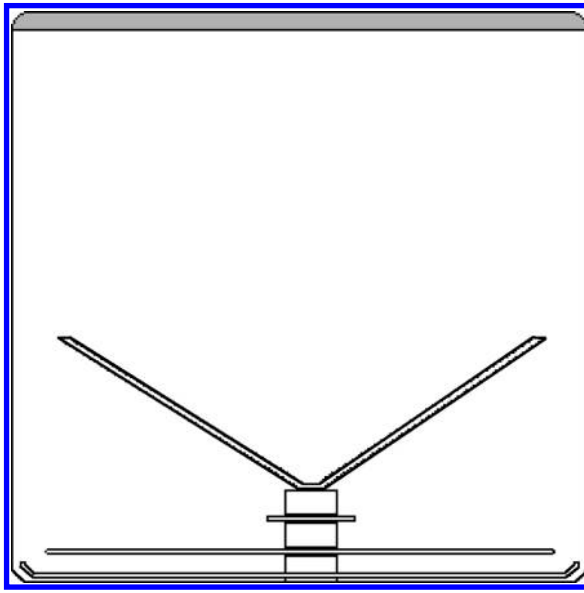

FIGURE 89.2 Generalized schematic of premix equipment.

Because the extruder is a simple melt mixer, and not a very efficient disperser, the premix stage must allow for the best possibility of good dispersion of all ingredients in the final product. Thus, premixture is performed in equipment with sufficient ability to break down the large resin flakes, thoroughly blend any liquid components, and disperse the smaller quantity constituents, such as additives.

89.2.1.1 Premixers

Most premix equipment consists of a mixing bowl with a locking cover. The equipment is usually fitted with a cooling jacket capable of being filled with running water or, in rare cases, cryogenic gasses. The mixing blades within the bowl may have various configurations. However, there are generally two or three blades placed at different heights and orientation to one another (Figure 89.2).

89.2.2 Extrusion

The second stage of powder coating manufacture is extrusion of the premix. The extruder is basically composed of a horizontally placed stainless steel tube or “barrel.” Within the barrel are one or two “screws” that are slightly smaller than the barrel in diameter. The screws turn and move the premix forward through heated “mixing zones.” The mixing zones have special attachments, called mixing paddles or blades. The paddles knead the melted premix and blend the various ingredients.

Contrary to what may be imagined, the extruder is not a very good disperser. The space between the screws and the barrel walls is relatively large and allows material to travel through without dispersing it thoroughly. Also, the coating mixture passes through the barrel fairly rapidly and does not have time to be dispersed efficiently.

89.2.2.1 Extruders

There are three basic types of extruder. The first type, the single screw extruder, is most often used in the plastics industry. It does not move material forward as rapidly as other types, and thermosetting coatings could react in the barrel and gel prematurely. Thermoplastic materials used in injection molding are commonly prepared in single screw extruders. However, there is one type of single screw extruder used in the thermosetting powder coatings industry. It has special attachments along the sides of the barrel that aid in the blending of the ingredients.

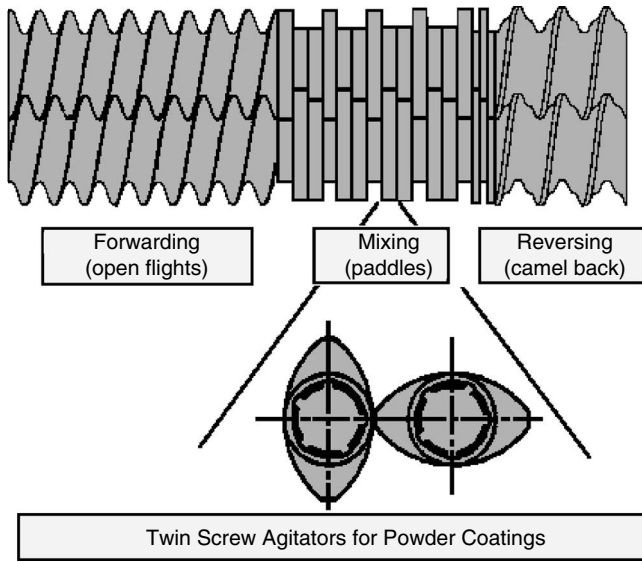

FIGURE 89.3 Typical configuration for twin screw corotating extruder.

The second type of extruder is the counter-rotating twin screw extruder. It is composed of two screws placed side-by-side and turning in opposite directions (i.e., one turns clockwise and the other counter-clockwise). This type is also usually used in the plastics industry.

The third kind of extruder, which is used in powder coating production, is the corotating twin screw extruder (see Figure 89.3). In this type of equipment, the two side-by-side screws turn in the same direction. This greatly increases throughput and decreases residence time. Reduced residence time is important in thermoset coatings, especially in the most reactive systems with short gel times.

89.2.3 Grinding

The grinding phase in the manufacture of a powder coating is important to its final performance. The average particle size and distribution are important in the application properties and final surface appearance of the coating.

Once a powder coating has been extruded, it passes through one or more stages to prepare it for grinding. The molten material is dropped onto chilled metal rollers, where it is pressed flat and cooled. The coating is then broken into flakes or granulated and fed to the grinder.

89.2.3.1 Grinders

There are three favored types of grinding equipment used in the powder coating industry. They are the impact or hammer mill, the air jet mill, and the air classifier mill.

The impact or hammer mill grinds the coating materials by throwing them or hitting them against a stationary screen or stator.¹⁰ The particles are broken down until they are small enough to fit through the screen. The particles are then passed to various sieves or cyclonic separators for final particle size distribution adjustments.

The air jet mill is an extremely efficient grinder. Powder coatings are fed into a high volume and high velocity airstream. The particles circle the cylindrical grinding chamber striking other particles and breaking them into very fine powders. The fine material rises out of the chamber with the escaping air, through conduits, to separation devices that structure the particle size distribution.

The air classifier has elements of both of the previous types. There is an impact chamber that is supplemented with airstreams that rapidly break down the coating materials. This provides excellent

control of particle size distribution, and the moving air tends to cool the powder, minimizing heat effects, such as impact fusion.

89.2.4 Sifting and Classifying

The final structuring of particle size distribution is accomplished by passing the ground materials through sieves or cyclonic separators. Sieves “scalp” the largest or smallest particles, which narrows the particle size distribution. By judicious use of sieves, the distribution and average particle size may be chosen for best application and surface properties.

Cyclonic separators or “classifiers” function by forcing powders in airstreams to circle conical chambers. The heaviest (largest) particles will fall to the bottom of the chamber and will be collected for use or dumping. The smallest particles will flow out through the top with escaping air, will flow through conduits, and will be saved or discarded as the need arises. By adjusting the volume and velocity of the airstream, a particle size distribution can be varied.

89.2.5 Application Equipment

There are three primary methods of applying powder coatings. The first uses a fluidized bed. As described earlier, the fluidized bed transmits a diffuse stream of air upward through the bottom of a container holding the coating to be applied. The airstream is kept at low enough pressure so that the powder rises into the air but is not expelled from the container. As air escapes past the floating particles, the surface of the powder mass appears to bubble or “percolate.” The term “fluidized” refers to this fluid-like motion. The metal part to be coated is heated above the melting point of the coating and is “dipped” into the fluidized bed. Powder touching the part melts and adheres to the metal. The part is then transported to a curing oven.

The second and third methods of application utilize electrostatic spray guns. There are two basic types of gun: corona-charged and “tribo”-charged. The corona-charged spray gun applies an electrostatic charge to the powder as the material flows through an electrical field generated at the gun tip of the gun. The tribo-charged gun has a polytetrafluoroethylene (PTFE) barrel, and powder flowing through it acquires an electrical charge from friction. The charged powders are sprayed onto grounded metal parts, where they adhere through electromagnetic attraction. The parts are then transported to the curing oven.

89.3 Chemistry

The chemistry of powder coatings is not very different from that of liquid coatings. The main resin types used in thermosetting powder coatings are all familiar to the liquid coatings chemist. The epoxy, polyester, and acrylic polymers are well known in liquid coatings. However, the molecular weight and curing agents are somewhat different. From these three resin types, a number of different cross-linked systems are possible. The most common will be discussed here. Note that each subsection describing a cross-linking pair includes a common industry “nickname” in parentheses.

89.3.1 Epoxy Systems

The most common epoxy resins in use today are diglycidyl ethers of Bisphenol A made from reaction of epichlorohydrin with Bisphenol A. Diglycidyl ethers of Novolac resins also have significant commercial impact.

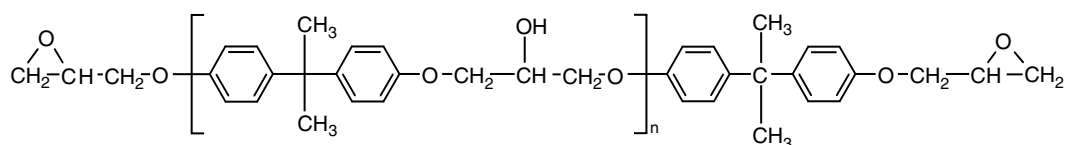

Diglycidyl Ether of Bisphenol A Resin

The epoxy groups terminating each molecule react with acidic or basic curing agents. The three most common are the phenols, dicyandiamides (DICY), and carboxylic acids, including carboxy-terminated polyesters. Various acids, anhydrides, amines, and imidazoles are also used as cross-linkers with epoxy resins.

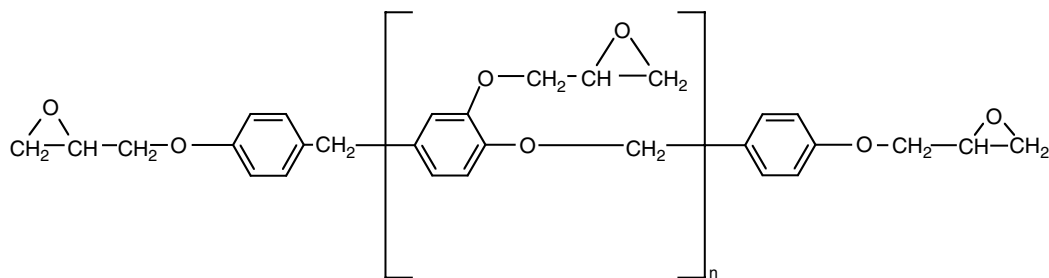

Diglycidyl Ether of Novolac Resin

89.3.1.1 Epoxy-Phenols (Phenolic)

The curing of epoxy resins with phenols results in the opening of the epoxide ring and the formation of a hydroxyl group, at either the primary or secondary position. The hydroxyl group is available for reaction in the cross-linking of the resin. The aromatic ring attaches to the unreacted carbon of the epoxide.

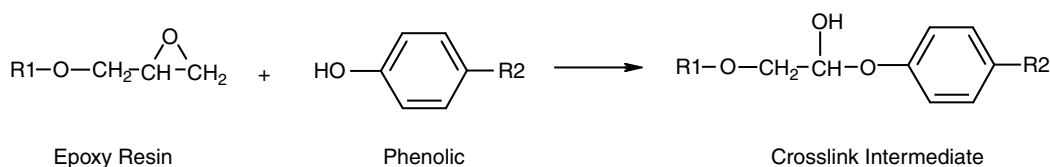

89.3.1.2 Epoxy-Dicyandiamide (DICY)

DICY cured epoxy coatings react in a similar manner to that of the previous type, where nitrogen-bearing groups replace the aromatic ring. All four functional groups will react with the epoxide, acting as a primary or secondary amine.

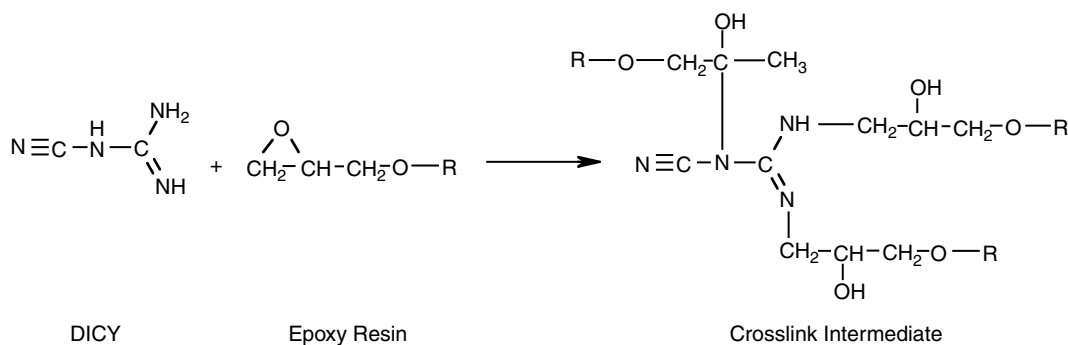

89.3.1.3 Epoxy-Polyester (Hybrid)

Epoxy resins react with carboxy-functional polyesters in the same way as carboxylic acids. The hydroxyl portion of the acid group reacts with the epoxide. The rest of the reaction follows as we have seen in the previous examples. Because both reactants are considered primary resins, the system is referred to as a "hybrid."

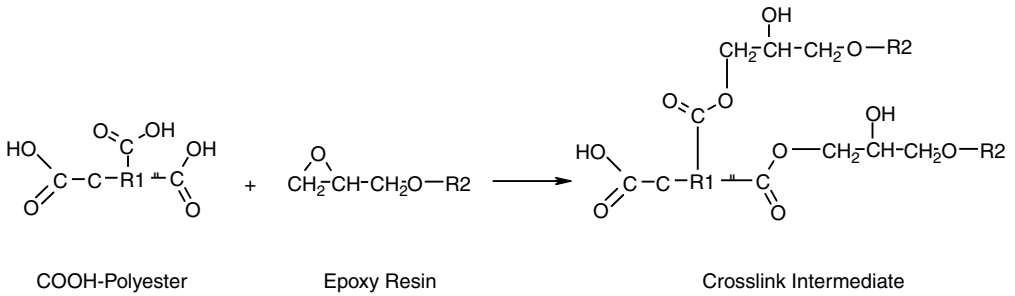

89.3.2 Polyester Systems

There are two types of polyester resins used in thermoset powder coatings. They are carboxy- and hydroxy-functional. There are several different curing agents used with each. We will examine the four most common systems.

89.3.2.1 Polyester-Triglycidyl Isocyanurate (TGIC or Polyester)

Triglycidylisocyanurate (TGIC) is a heterocyclic tri-epoxy curing agent. As such, it reacts with carboxy-functional polyester resins similar to those used in hybrid coating systems. The major difference is in the trifunctionality. One mole of TGIC will react with three moles of polyester resin. The cross-link network is also more complex because of the extra reactive sites available.

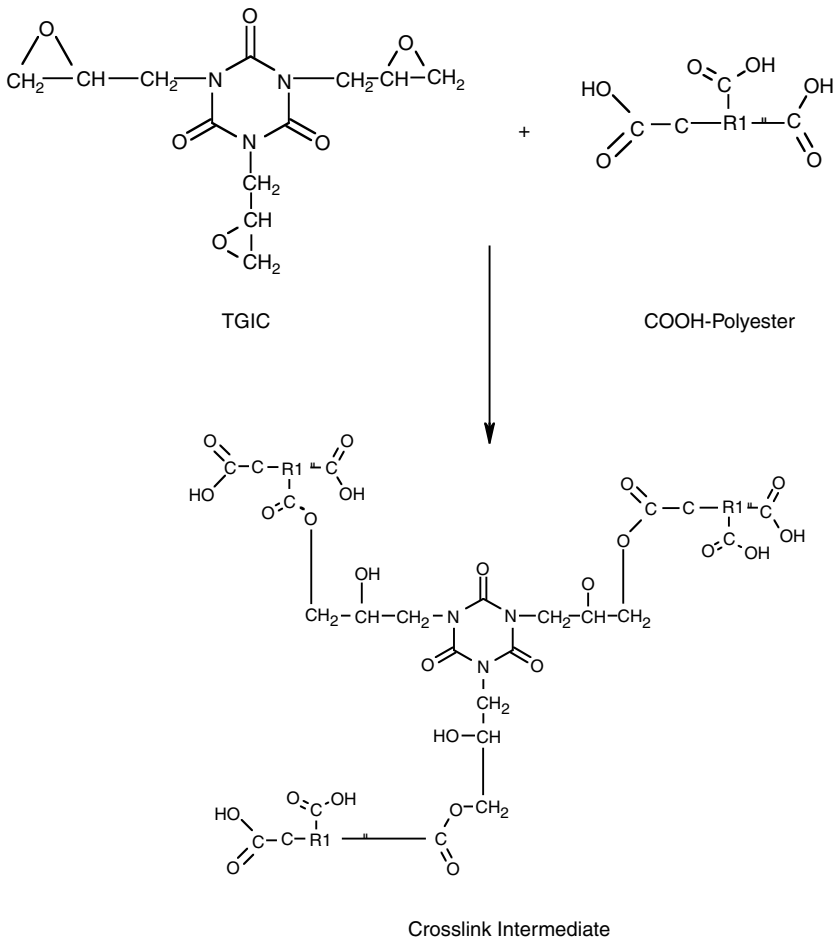

89.3.2.2 Polyester–Isocyanate (Polyurethane)

Polyester resins used to produce urethanes have hydroxyl functionality. They react at the carbon–nitrogen bonds in an isocyanate. The two isocyanates most used in powder coatings are isophorone diisocyanate (IPDI) and toluene diisocyanate (TDI). However, TDI melts at room temperature, and IPDI is a liquid. This would cause any powder coating in which they were used to have poor package stability. The coating would sinter (cake) into a solid very quickly. Furthermore, they would react with the polyester and gel during the heat of extrusion, again making them unusable.

Consequently, isocyanates are reacted with triol materials to give them higher melting points and better package stability when compounded in powder coatings. Then they are blocked, most commonly with (epsilon) ε-caprolactam, to prevent them from reacting with the polyester until they unblock naturally at curing temperatures in the oven.

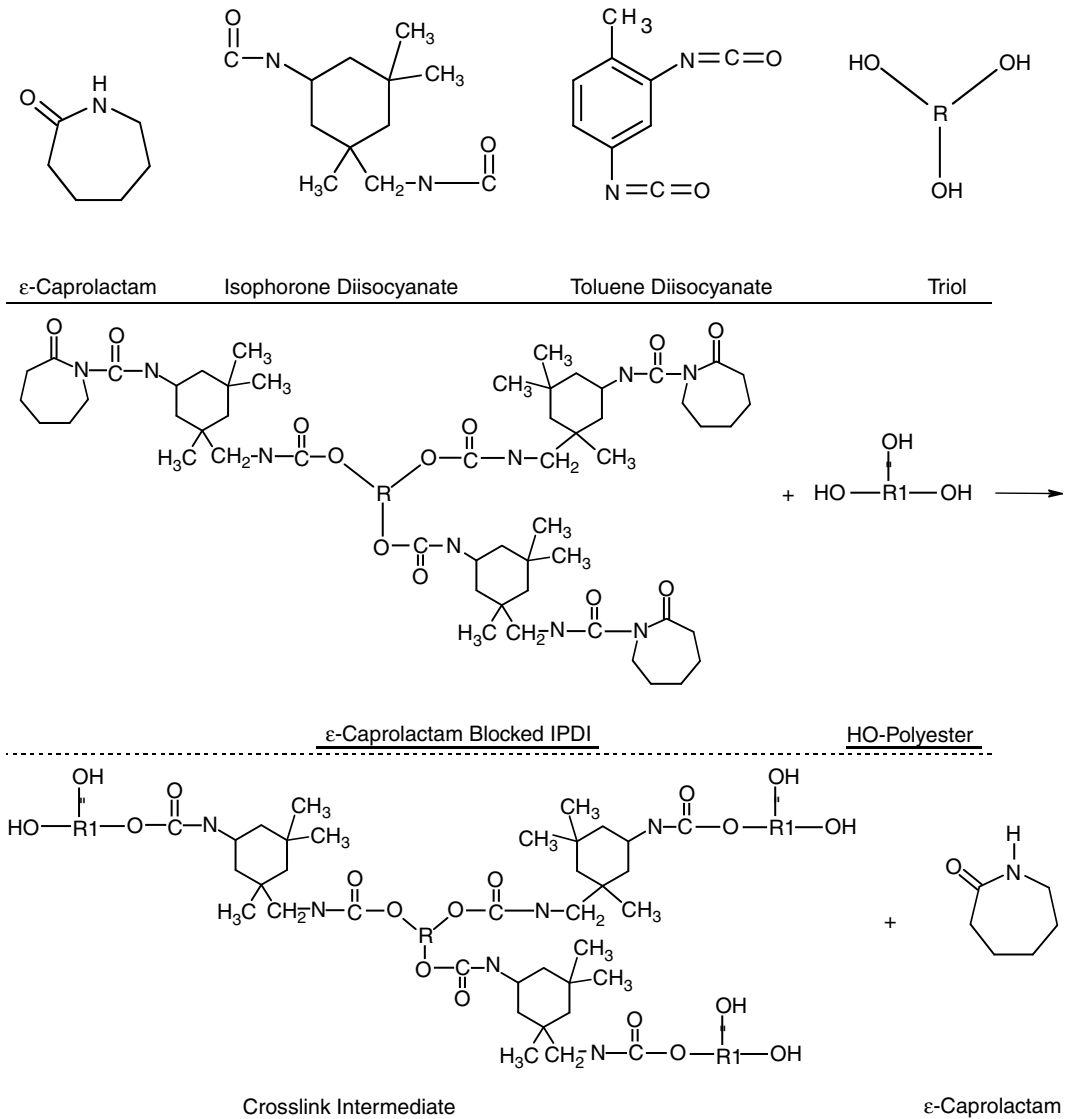

89.3.2.3 Polyester–Non-TGIC (β -Hydroxyalkylamide, Tetramethoxymethyl Glycoluril)

As we discussed earlier, TGIC was found to have mutagenic properties. While some controversy still remains as to its hazardous nature, many coatings companies and regulatory bodies have taken a conservative stance and limited its use. There have been regulations enacted that require warnings to be placed on labels of coatings that contain TGIC. Coatings companies have also turned to curing agents that do not have these types of hazards associated with them.

The two types that are used most often are the β -hydroxyalkylamides and tetramethoxymethyl glycoluril. The hydroxy-amides are tetrafunctional, which makes them highly reactive at curing temperatures. Their major drawback is that they release water from the reaction that must escape the curing film. This requires further formulation to insure defect-free films. The glycoluril is also tetrafunctional and releases a VOC, methanol, as part of the reaction process.

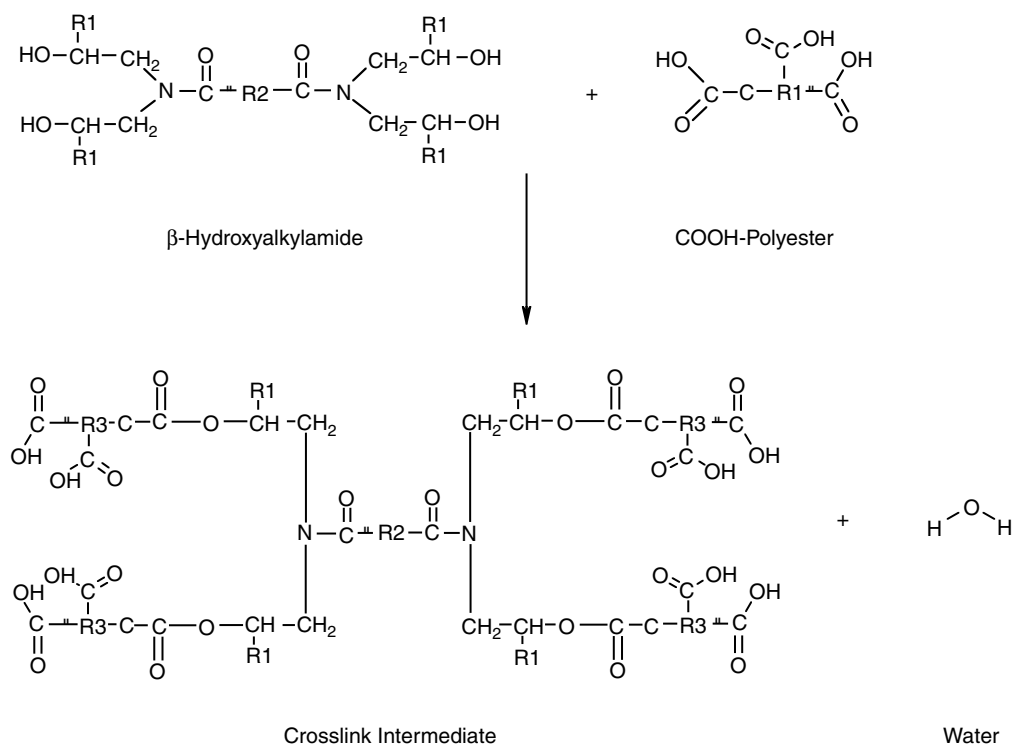

89.3.3 Acrylic Systems

There are two primary acrylic systems: those based on hydroxy-functional acrylic resins and those using epoxy- or glycidyl-functional polymers. Carboxy-functional materials have been produced. However, they have not made much progress into the industry.

89.3.3.1 Acrylic–Isocyanate (Acrylic–Urethane)

Acrylic–urethanes are formed in exactly the same way as their polyester counterparts. The acrylic resins are linear instead of aromatic. However, they use hydroxy-functionality and blocked-isocyanates to form the urethane bonds.

89.3.3.2 Acrylic–Diacid (Glycidyl–Acrylic)

Epoxy- (glycidyl-) functional acrylic resins can be compared to the hybrid systems discussed earlier. They are generally reacted with dicarboxylic acids or anhydrides. The most common cross-linker is 1,12-dodecanoic acid (1,12-dodecane dioic acid).

89.4 Formulation

89.4.1 Resin Systems

Formulation of thermoset powder coatings is much the same as that for liquid coatings used for similar purposes. A coating may be chosen for functional or decorative purposes. All of the coating types used in powder coatings can offer decorative options. Nonetheless, it is function that dictates system choice. The resin chemistry must be chosen to suit service needs. Various pigments, fillers, and additive materials are then included to enhance decorative or functional requirements.

There are two primary functions for any protective coating. They are chemical protection and exterior durability. As with many coating properties, these two tend to be in opposition. The best systems for chemical protection are usually the poorest for exterior durability.

Epoxy powder coating systems deliver the best chemical and corrosion resistance. However, they have the least effective exterior durability. The double bonds in the aromatic rings are easily broken by the ultraviolet (UV) light from the sun. Glossy finishes will go flat with as little as 6 months of exposure, with film degradation following soon thereafter.

Urethane systems are also very good for chemical resistance, and they have fairly good exterior durability, as well. Hybrids offer good chemical resistance, however, the polyester component makes them less effective. They are also poor in relation to exterior exposure due to the epoxy portion of the cross-link network.

Acrylic and TGIC powder coatings provide the best exterior durability. Some systems can survive for up to 20 years of exposure. They offer fair to good chemical resistance. Urethane systems seem to be the best compromise between chemical and exposure properties. As mentioned, they are very good in both areas.

89.4.2 Pigments and Fillers

Most pigments and fillers used in liquid coatings are suitable for use in powder coatings.¹¹ There are only a few special requirements for use. They must be sufficiently heat stable so they withstand the heat of extrusion and curing without degradation or color change. Normally, the heat of extrusion is 125°C or less for a minute or two. The heat of cure is usually 160 to 200°C for 10 to 20 min.

Second, they must be insoluble and nonreactive in the resin system. Blooming and color shift are the most common results from pigments that are partially soluble or reactive with the binder. Some epoxy system curing agents are especially susceptible to reaction with pigments.

89.4.3 Additives¹²

89.4.3.1 Flow and Leveling

Flow and leveling agents are designed to minimize surface defects such as craters, pinholes, and orange peel. The mechanism of their function alters the surface tension and rheology of the coating. The likelihood of a smooth defect-free film is improved by reducing one (or both) of these properties in a coating.

Most flow and leveling agents are liquids. Many are blended with inert inorganic materials to offer them in a conveniently solid form. The chemistries of these are usually polyacrylates or polysiloxanes. A few new flow agents are available, however, in solid organic form.

89.4.3.2 Debubbling (Degassing)

The most common debubbling agent is benzoin (2-hydroxy-1,2-diphenyl ethanone). It is used to keep the surface of a curing film open long enough to allow for entrained air and evolved gasses to escape. Trapped air and gas bubbles are cause for premature failure of coating films, because they make the coating brittle. The one drawback to the use of benzoin is its tendency to cause yellowing in lighter colors. A number of new advances have entered the market in an attempt to match the efficiency of benzoin without the challenge of yellowing.

89.4.3.3 UV Inhibitors

Various UV light inhibitors are available to aid coating resistance to degradation by the sun's rays. The most common are hindered amines, phosphites, sulfates, and phenolics. Most will have some positive effect on any coating's UV resistance. However, each system will require testing to determine the best combination of inhibitors. Some systems, like epoxies and hybrids, will not develop any substantial UV resistance due to their aromatic nature.

89.4.3.4 Catalysts

Catalysts or accelerators are used to reduce the reaction time or curing temperature of the resin and cross-linker. They allow for faster production time by shortening the gel or "set" time of the thermosetting coating. Energy can be conserved, because full cure may be attained at lower oven temperatures. The most common catalysts are thiazoles (used in polyesters), phosphines and ammonium halides (used in epoxies), and thiocarbamates (used in urethanes).

89.5 End Uses

The following table details some of the applications currently using the chemistries discussed in this chapter.

Type	Typical Applications
Epoxy	Shelving, transformer cases, primers, bathroom fixtures, refrigerator racks, sweepers, sewing machines, power tools, room air conditioners, office furniture, instrument cases, garden tools, kitchen furniture, fire extinguishers, toys, refrigerator liners, dryer drums, microwave ovens, mixers and blenders, fertilizers spreaders, screening, oil filters, automobile springs, hospital equipment, bus seat frames, business machines, glass bottles
Hybrids	Tool boxes, farm equipment, electrical control boxes, hot water heaters, hot water radiators, primer/surfacers, grain storage bins, transformer covers, 01.1 filters and air cleaners, air conditioner housings, fire extinguishers, toys, screening wire, power tools, shelving, office furniture
Urethane	Fluorescent light fixtures, steel and aluminum wheels, patio furniture, playground equipment, fence fittings, chrome wheels and trim, garden tractors, range side panels and broiler, ornamental iron, air conditioner cabinets, restaurant furniture supports, transformer cases
TGIC	Irrigation pipe and fixtures, outdoor furniture, air conditioning units, steel and aluminum, wheels, wire fencing, fence poles and fittings, farm equipment, aluminum extrusions, transformers
Acrylic	Range side panels, refrigerator cabinets and doors, washing machine parts, dishwasher exterior, aluminum extrusions, microwave ovens, garden tractors, automotive trim coating

References

1. Douglas S. Richart, "Powder coatings — A review of the technology," *Am. Paint & Coat. J.*, April 22 (1991).
2. P. G. Clements. Patent GB 643,691; 9/27/50, Schori Metallizing Process, Ltd.
3. E. Gemmer, Patent DE 933,019; 9/15/55, Knapsack-Griesheim AG.
4. E. Gemmer, Patent U.S. 2,844,489; 7/22/58, Knapsack-Griesheim AG.
5. Patent GB 915,575.
6. E. P. Miller, "Electrostatic finishing methods," paper presented at the Annual Meeting of the National Paint, Varnish, & Lacquer Association, Colorado Springs, CO, September 12, 1963.
7. D. A. Bates, *The Science of Powder Coatings*, Vol. 1. London: Scholium Intl., 1990.
8. Statistics from Powder Coatings Institute, Alexandria, VA.
9. Rohm and Haas Brochure 82F2, Primid XL-552 — A Novel Crosslinker for Powder Coatings, 1990.
10. Pulverizing Machinery (product brochure), Mikropul Corp., Summit, NJ.
11. R. Campbell and R. Kumar, "Organic pigments for powder coatings," *Am. Paint & Coat. J.*, April 22 (1991).
12. Josef H. Jilek, *Powder Coatings* (monograph). Blue Bell, PA: Federation of Societies for Coatings Technology, 1991.

90

Peelable Medical Coatings

Donald A. Reinke
Oliver Products Company (Retired)

90.1 Introduction	90-1
90.2 Cold-Seal Coatings.....	90-2
90.3 Heat-Seal Coatings.....	90-2

90.1 Introduction

Prepackaged sterile medical devices and supplies became necessary in the late 1960s with the growth in prepaid health insurance programs. Insurers required that health care providers itemize the cost of all the supplies used during a procedure. This led to the rapid growth in the development of disposable or single-use devices. These were packaged in paper/plastic pouches, trays, or containers and then sterilized. At the time of use, the package was torn open to expose the sterile device. When the package was torn, the device was showered with particulates and bacteria that caused a great deal of concern. At that time, the medical device industry was not regulated by the U.S. Food and Drug Administration (FDA).

In 1968, the E. I. DuPont Company introduced a polyethylene, paperlike material (Tyvek®) that had most of the properties needed for packaging medical devices. Tyvek is a unique material that meets almost all of the critical requirements for medical packaging. It is a good bacterial filter — very porous, water-resistant, and puncture- and tear-resistant. Being made from polyethylene, it is stable during both ethylene oxide gas and radiation sterilization. It does not stand up well during steam sterilization, so only a few adhesives have been developed for this purpose.

With an acceptable packaging material available, peelable coatings were developed to seal Tyvek to plastic films or thermoformed trays to form pouches and trays that could be peeled open at the point of use without compromising the sterility of the device.

There are five basic types of adhesives used to seal Tyvek to plastic surfaces to form sterile packages. These are cold seal, lacquer-based heat seal, water-based heat seal, hot-melt-based heat seal and low-density polyethylene. All of these adhesives are very difficult to formulate and apply so that they meet all of the requirements of the medical device manufacturers.

Some of the requirements these adhesives must meet are as follows:

- Must peel cleanly without generating particles
- Have a peel strength over 1 lb per inch of width and less than 3 lb per inch of width regardless of the peel angle
- Be very stable both before and after sterilization (shelf life requirements can be as long as 10 years)
- Meet the U.S. Pharmacopoeia requirements for medical device plastics

90.2 Cold-Seal Coatings

Cold-seal coatings, also known as cohesive coatings, are made from natural latex and are sealed by pressure alone. They will not seal to other surfaces, only to themselves. This type of coating has been used for self-sealing envelopes, candy wrappers, and in a variety of industrial packaging. Peelability with cohesive coatings is achieved by coating a release layer between the adhesive and the substrate. This allows the adhesive to peel away from the substrate without leaving a residue or tearing fibers. The main advantage of cold seal is that it can be sealed at very high-line speeds, because only pressure is required to form the seal. The biggest disadvantage is that it is unstable during the coating process and is sensitive to ultraviolet light after coating.

90.3 Heat-Seal Coatings

The second type of coating, heat-seal adhesives, is more complex in its requirements than the cold-seal adhesives. The latter generally are applied only in the seal area, and seal only to themselves. The heat-seal adhesives are normally coated over the entire surface of the web and have to seal to a wide range of plastics. Heat and pressure are required to form a seal.

Many different types of heat-seal coatings are used for medical packaging, but all must meet the same requirements. The most important requirement is that they be stable after sealing, so that a sterile package is assured for several years. Disposable devices are sterilized after packaging and must remain sterile until used. They must also have porosity of under 200 sec Gurley to prevent the buildup of excessive internal pressure in the package during a normal gas sterilization cycle. The coating must be nontoxic and must meet the same requirements listed in the U.S. Pharmacopoeia for the plastics used in the packaged device. Other desired attributes are good hot tack, clean color, enough strength to pass shipping tests, and good transfer of the adhesive onto the seal surface when the package is peeled open.

The coatings used on heat-sealable Tyvek and paper come in many forms. They can be solvent-type lacquers applied in a grid pattern to maintain porosity, water-based dispersions dried very carefully so that they do not melt, or hot-melt adhesives applied in small dots.

The lacquer-type adhesives are applied by the gravure process at a rate of 3 to 6 pounds per 3000 square feet. The adhesive is applied in lines that cross at an angle, leaving an uncoated area between them resulting in good porosity. Also, the lines break up the peel forces to give better peelability.

The water-based dispersions are based on ethylene-vinyl acetate copolymer dispersions blended with waxes and tackifiers to form a blend of particles. This blend is coated on the web by air knife coating or by gravure. The coating must be dried at a low temperature to keep the coating from melting and forming a film. The porosity is achieved by having large particles in the blend and by mud cracking of the coating as it dries. The dried coating weight is 5 to 8 pounds per 3000 square feet.

Hot-melt coatings are a blend of an ethylene-vinyl acetate copolymer, terpene resins, and wax. These are melted together and applied by a gravure roller engraved with 50 to 70 cells per inch. The small dots of adhesive that result from this have a small uncoated area between them that makes the coating porous. The coating is applied at a rate of 9 to 12 pounds per 3000 square feet.

The optimum amount of coating will vary for each type of adhesive. The controlling factor is the melt viscosity of the adhesive at the sealing temperature. If the viscosity is low, a portion of the adhesive will be pushed into the substrate, reducing the amount of adhesive available to absorb stresses and to transfer during peeling. Good adhesion to a smooth surface with coated paper or Tyvek can be achieved with 5 to 12 pounds of adhesive per 3000 square feet. An accepted rule of thumb in the coating industry is that 15 pounds per 3000 square feet is equal to 0.001 in. of thickness.

While there are no regulations in this country requiring nontearing packages, the medical device industry places a high priority on this feature. Another desirable feature of the coating, which goes along with peelability, is the ability of the coating to transfer to the plastic surface to which it is sealed. The transfer pattern must be unbroken when the package is opened. This is interpreted to mean that the seal

integrity has been maintained. A clear track through the seal area will cause the package to be rejected, because there is a path for bacteria to enter the package.

Formulating a coating that is nontoxic and strong, with good hot tack and good adhesion to a variety of plastic surfaces, and that is able to peel with a controlled peel strength, is a difficult task.

Several methods have been used to achieve peelability. The use of primer coats between the adhesive and the substrate is the one most often chosen; this creates a parting layer between the adhesive and the substrate. Release coating on the substrate surfaces are also used when paper is used instead of Tyvek.

Most people in the industry feel that the best method is to have an adhesive with a controlled cohesive strength. When the package is peeled open, the adhesive will split with a controlled force that is below the delamination strength of the substrate. By using this method, the surface fibers of the substrate are not raised or broken.

Cohesive failure of the adhesive can be achieved by formulating an adhesive that has two phases: one a strong adhesive to hold the package together and the other a weak friable material that breaks up the structure of the first phase. By varying the percentage of the two phases, the cohesive strength of the coating can be controlled within narrow limits.

The nature of peelable medical packaging materials is currently undergoing a change. There is a drive to reduce the cost of medical devices, causing a shift to paper and away from Tyvek. Also, environmental concerns are pressuring medical device companies to use some method other than ethylene oxide gas sterilization. The requirement for a peelable package, however, remains strong.

The medical device industry is now under the control of the FDA, which requires complete validation of processes and materials. Formulating and validating a new adhesive will generally take from 1 to 3 years. For this reason, packagers of medical devices are very reluctant to change suppliers. They do not have the engineering staff they had in the earlier years when the industry first started. To change an adhesive and develop the documentation required by the FDA is very expensive. Most companies have alternate suppliers they can use if they have problems.

Further information on medical device packaging can be found in the proceedings of the Technical Association of the Pulp and Paper Industry's Coatings and Laminations conferences during the years from 1980 through 1987.

Conductive Coatings

91.1	Introduction	91-1
91.2	Types of Conductive Coatings	91-2
	Metallic • Filled Polymeric • Polymeric • Organometallic	
91.3	Commercially Available Conductive Coatings	91-5
91.4	Applications	91-6
	Shielding from Electromagnetic Interference • The Stealth • Miscellaneous	
91.5	New Developments	91-7
	References	91-8

Raimond Liepins

Los Alamos National Laboratory

91.1 Introduction

In 1986, sales in the coatings industry exceeded \$10 billion, and production approached a billion gallons.¹ The breakdown of sales was \$4.1 billion for architectural coatings, \$3.5 billion for industrial coatings, and \$2.4 billion for specialty coatings. Conductive coatings — a minuscule part of these trade sales — have been used both as industrial coatings and as specialty coatings. Regulations of the Federal Communications Commission (FCC), in Docket No. 20780, which regulates electromagnetic emissions from computing devices, have provided a strong impetus for the commercial development of conductive polymeric materials (including coatings and paints). Since October 1, 1983, it has been necessary for any computing device that generated signals or pulses in excess of 10 kHz to comply with the emission standards set forth in the docket. Although conductive polymeric coatings have made inroads in areas where metallic coatings previously were used, progress has been slow.

A product related to conductive coatings is metallized plastic. The most important commercial processes for metallizing plastics are electroless plating, metal spraying, sputtering, and vacuum metallizing. The first commercial plating of plastics was recorded in 1905.² Metallizing of plastics occurred during World War II, and large-scale production started in the early 1960s. All these processes are now multi-million-dollar industries. Large quantities of plastics are metallized each year, with automotive items making up more than 60% of the market on a plated area basis.³

There are various reasons for metallizing plastics. In the automotive industry, metallized plastic combines the consumer appeal of metal with light weight. Electroless copper metallization is an indispensable part of the modern electronics industry. Printed circuit boards use electroless copper to coat nonconductive plastic surfaces to define the circuit patterns. Zinc arc and flame-spray techniques provide electromagnetic interference shielding on many plastics. The plastics that account for most of the substrates metallized are acrylonitrile-butadiene-styrene (ABS), polypropylene, polyphenylene oxide, epoxies, phenolics, polyimides, and polyesters. The commercial process for metallization of plastics merits separate discussion and is not further considered in this chapter.

Polymers (coatings) with conductivities greater than $1(\Omega\text{cm})^{-1}$ are defined as conductive polymers (also metallically conducting plastics, synmetals).⁴ Unfortunately, the literature is not clear-cut, and often, materials that are semiconductors with conductivities less than $1(\Omega\text{cm})^{-1}$ are also called “conducting.”

This chapter discusses only coatings (polymers) and their applications requiring a conductivity of at least $1(\Omega\text{cm})^{-1}$.

91.2 Types of Conductive Coatings

We discuss metallic, filled polymeric, polymeric, and organometallic conductive coatings.

91.2.1 Metallic

Substrates are coated with conductive coatings mainly for functional and rarely for decorative purposes. The most important commercial metallic coatings are nickel, copper, chromium, gold, palladium, platinum, silver, zinc, cadmium, iron, cobalt, tin, and lead.³ The important commercial processes for metallizing plastics have already been mentioned, and recent developments in this area are summarized in Section 91.5.

Some of the special techniques for metallizing plastics are summarized below.

Details of the electroless metallizing technique of composites and/or thermoplastics that allows the repairing of damaged areas in the field have been published.⁵

Surface metallization of molded liquid-crystal polymer parts has been accomplished.⁶

To increase the adhesion of a metal coating to an organic substrate, the substrate is heated to 0.6 to 0.8 T_{cure} of the substrate and held at that temperature while the metallic coating is deposited. This procedure provides for optimum intermixing between the metal atoms and the substrate, thus producing maximum adhesion.⁷

A simple technique for plating ABS plastics consists of mixing a mixed catalyst solution for simultaneous sensitization and activation of the surface.⁸

Adhesion between polyethylene and/or polypropylene and aluminum is improved if the plastic surface is pretreated with an oxygen ammonia, or sulfur dioxide low pressure plasma.^{9,10}

An electroless metal plating of plastics involves a plastic reducible by one metal salt followed by a redox reaction between the reduced plastic and the main group metal salt to produce the plated plastic.¹¹

A process for metallizing shaped articles of filled plastics with cuprous oxide has been described. The surface of the filled articles is subjected to a reducing agent such as a borohydride to convert the cuprous oxide to a conductive free-metal surface.^{12,13}

91.2.2 Filled Polymeric

Plastic coatings and paints can be made conductive by adding metallic fillers. Typical metal powders that have been used in coatings, paints, and lacquers are nickel, copper, gold, aluminum, iron, cobalt, palladium, zinc, and platinum, as well as various other alloys. A step beyond the use of powdered, more or less spherical, fillers is the incorporation of conductive fillers with high aspect ratio: length-to-diameter ratio of more than 100. This family of materials includes such fillers as metallized glass fibers, graphite fibers, metallized carbon fibers, quick-quenched aluminum flakes or fibrils, and fine diameter (6 to 8 μm) steel fibers. The most common metallic conductor, copper, is not used, because it oxidizes within the plastic and impairs its physical properties.

Depending on particle form (sphere, flake, fiber), size, and orientation, there is a certain critical concentration at which conductivity increases drastically (many orders of magnitude). To achieve significant conductivity with more or less spherical fillers (carbon black, metal powders), volume percent loadings above 40 are required. A striking difference in conductivity is observed when a high aspect ratio particle of the same material is used. Thus, with metal or metallized glass fibers of aspect ratio of 750 as fillers, metallic conductivities can be achieved at as low as 3 vol%.¹⁴

At critical concentration, the filler can form a continuous phase through the matrix in the form of microscopic conductive channels (percolation). The use of high aspect ratio conductive fillers, when they are properly oriented, will always produce a superior conductivity at a lower volume percent concentra-

tion than comparable spherical fillers. However, for these materials to have high efficiencies, they also must survive the preparation and application processes. For example, the initial high aspect ratio of a very brittle material may quickly reduce to powder in a high shear mixing environment, if proper techniques are not developed for incorporating such brittle materials.

Some specific examples of uses for filled polymeric coatings are summarized below.

Organic solvent-based coatings of acrylic or urethane resins containing nickel, silver, copper, or graphite powders are used in the electromagnetic and radio frequency interference applications. For cost reasons, the nickel-filled acrylic coatings are most often used. Lacquers based on silver give the highest conductivities and, therefore, the best screening attenuation, but they are the most expensive. Copper lacquers are cheaper, and the attenuation is similar to that of silver; the oxidation problem of copper lacquers has been solved. Lacquers containing graphite are the cheapest, but their performance is also the least effective.^{15,16}

An initiation layer for the electroless deposition of copper, nickel, Ni-P, Ni-B alloy coatings has been described. The layer was formed by applying a polyester or its polymerization material solution containing such metal powders as nickel, copper, silver, aluminum, cobalt, palladium, zinc, or platinum.¹⁷

Large differences in the specific conductivity of filled conductive plastics coatings were demonstrated between materials filled with 15 vol% aluminum alloy fiber, $\sigma = 0.25 (\Omega \cdot \text{cm})^{-1}$, and 15 vol% brass fiber, $\sigma = 170 (\Omega \cdot \text{cm})^{-1}$.¹⁸

Techniques have been developed for generating and incorporating in situ metallic filler in organic coatings or paints. For example, the use of AgNO_3 and erythorbic acid, formaldehyde, paraformaldehyde, or terephthalic aldehyde will result in the generation of metallic silver in a chosen organic coating or paint system.^{19,20}

91.2.3 Polymeric

Although the unfilled, molecularly conductive polymeric materials have attracted much attention recently, the successful developments in surface-metallized plastics make it unlikely that inherently conductive polymers will be a significant factor in the marketplace in the near future. Also, the commercially entrenched, filled conductive polymeric materials seem to become more efficient as time goes by.

One projection of worldwide markets for filled and inherently conductive polymers is as follows:²¹

	1982	1987	1992
Filled conductive, lb	1×10^6	1×10^7	1.5×10^7
Inherently conductive, lb	0	1×10^5	1.5×10^6

This projection, made in the mid-1900s, is clearly very optimistic about the prospects of inherently conductive polymers.

The major problems of molecularly conductive polymeric materials (coatings) are still their instability under environmental conditions and difficult or impossible processing from solution or melt. Consequently, they have to be synthesized and treated in their final form of application. In the undoped state, the basic polymers are either semiconductors or insulators. It is only after they are doped (oxidized or reduced) chemically or electrochemically that they become metallically conductive.⁴ Doping can be done by means of electron-accepting (oxidizing) agents, such as AsF_5 , iodine, bromine, SbF_5 , NOPF_6 , $\text{Al}(\text{ClO}_4)_3$, or HClO_4 ; or electron-donating (reducing) agents, such as lithium, sodium, potassium, or sodium naphthalide. Unfortunately, most of the doped materials generated are extremely reactive because of the carbonium ions and carbanions formed upon doping and thus are not stable under ambient conditions.

Recently, some progress has been made in this area. The first environmentally stable, conducting polymer was polypyrrole. Coatings or films of it were prepared electrochemically from aqueous solutions of sodium *n*-alkylsulfonates, and disodium 1,10-decane disulfonate or toluenesulfonic acid. The products possessed conductivities as high as $230 (\Omega \cdot \text{cm})^{-1}$. The films possessed good mechanical properties and environmental stability in excess of 5 years (thus far tested).^{22,23}

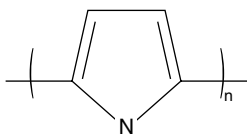

Another heterocyclic, conducting, environmentally stable polymer is polythiophene. Polythiophene and its derivatives can be synthesized and doped chemically or electrochemically to conductivities as high as $100 (\Omega\cdot\text{cm})^{-1}$.^{24,25}

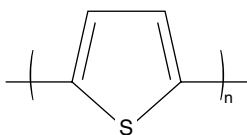

Environmentally stable polycarbazole was synthesized and I_2 doped to a conductivity of $5 (\Omega\cdot\text{cm})^{-1}$.²⁶

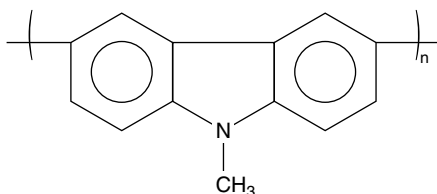

A polymer that is attracting more attention recently is polyaniline. It can be prepared both chemically and electrochemically, and when doped with various acids in aqueous solutions, it achieves conductivities as high as $10 (\Omega\cdot\text{cm})^{-1}$.²⁷⁻²⁹

A recent and exciting development is the preparation of aqueous polypyrrole and polyaniline latex.³⁰⁻³³ Spherical, submicrometer polypyrrole latexes have been prepared using poly(4-vinyl pyridine)-based steric stabilizer. The use of such a stabilizer allowed the polypyrrole particles to be controllably and reversibly aggregated or stabilized, depending on the pH of the dispersion medium. The solid state conductivity of films can be as high as $2 (\Omega\cdot\text{cm})^{-1}$.

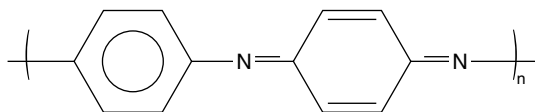

Except for the electrochemically prepared polypyrrole in a continuous sheet form, obtainable in developmental quantities from Badische Anilin- und Soda-Fabrik (BASF), Ludwigshafen, West Germany, none of the other materials have passed the research stage.

91.2.4 Organometallic

Although most of the current interest has been in unfilled molecularly conducting polymer systems, conductivity in metal containing polymers has also been a topic of interest. Almost all the molecularly conducting polymers are doped systems and, thus, may contain metals from the doping agent. Such systems, however, are air and moisture sensitive and are difficult to handle. In general, organometallic polymers do not have these instability problems, but their processibility is still a problem.

A new class of low-dimensional materials — for example, polymeric metallophthalocyanines with such metals as aluminum, chromium, tin, and gallium at the center of the ring — has been synthesized and made conducting [$\sim 1 (\Omega\text{-cm})^{-1}$] by halogen doping (partial oxidation).^{34,35}

Various transition metal ions have been coordinated with conjugated ligands to synthesize polymers with metal ions within the main chain.³⁶ Ligands such as tetrathiosquarate, tetrathionaphthalene, tetrathiofulvalene, and tetrathiooxalate have been used. The tetrathiooxalate complexed with nickel ions gave linear polynickel tetrathiooxalate oligomers with conductivities as high as $20 (\Omega\text{-cm})^{-1}$.

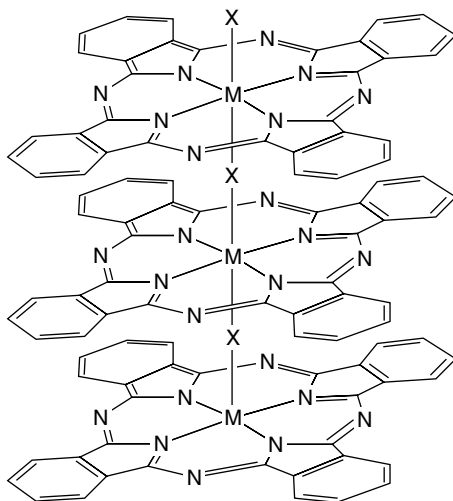

A completely different approach to depositing conducting organometallic coatings involves the use of a low-pressure plasma (LPP) environment. The LPP environment may be used to deposit a polymeric organometallic coating (or powder) from organometallic monomers,^{37–42} or it may be used to convert a deposited organometallic coating into a metallic one.^{20,43,44} The metals introduced in the organometallic coatings by LPP/organometallic monomers were iron, tin, mercury, tantalum, lead bismuth, and metal coatings by the LPP posttreatment were gold, platinum, palladium, silver, and lead. The generation of metal surface coatings from certain organometallic coatings can be also achieved by thermal means (controlled pyrolysis).²⁰ The advantage of the LPP process is that it permits a metallic coating to be formed on a heat-sensitive substrate without the use of elevated temperatures. The process also permits formation of adhering gold and platinum coatings otherwise difficult to deposit on plastic substrates.

None of the conducting organometallic coatings or their deposition processes have gone beyond the research stage. However, the conducting organometallic coatings effort is very new compared with the other types mentioned before.

91.3 Commercially Available Conductive Coatings

Whereas the metallized plastics effort is a multimillion-dollar industry, the commercial application of conductive polymer coatings as a paint, lacquer, ink, adhesive, or a solution of some kind forms a very small industry indeed. Below are summarized several typical products available commercially.

A proprietary aluminum containing paint, AG 9680, manufactured by A.I. Technology, Inc., Princeton, New Jersey, is claimed to approach the shielding effectiveness of 70 to 75 dB, an effectiveness similar to that of pure silver.

A silver-filled silica matrix elastomer, Aremco-Shield 615, has been developed by Aremco Products, Inc., Ossining, New York. This material has been formulated into a conductive paint that can be applied by either brush or spray; it cures at room temperature and bonds to metals, glass, and plastics.

A silver lacquer (Eccocoat CC-2) and an elastomeric, silver-filled, conductive coating (Eccocoat CC-40) have been developed by Emerson and Cuming, Canton, Massachusetts. The lacquers and the elastomer coatings may be applied by dipping, spraying, silk screening, roll coating, or brushing. In most cases, a simple spray coat is adequate to produce a highly conductive surface [up to $20 (\Omega\cdot\text{cm})^{-1}$] using the air-dry method. Oven curing will give improved conductivity.

A rather extensive series of conductive coatings under the trade name Evershield has been developed by the E/M Corp. of West Lafayette, Indiana. The series of products consists of a graphite-filled acrylic resin system, EC-G-102, intended mainly for applications for electrostatic charge dissipation; a high performance nonoxidizing copper-filled acrylic resin system, EC-C-301, is suitable for spray gun application. The coating has an attenuation performance of 50 to 70 dB at 10 to 1000 MHz. A popular nickel-filled acrylic resin system, EC-N-501, easily paintable and with superior adhesion characteristics for a wide variety of plastic substrates, is also available. It has an attenuation performance of 50 to 60 dB at 30 to 1000 MHz.

91.4 Applications

91.4.1 Shielding from Electromagnetic Interference

The advent of the FCC Docket 20780, which regulates electromagnetic emissions from computing and communication devices used in industrial and residential locations, has really provided a stimulus for the industry to come up with cost-effective methods for limiting the level of electromagnetic interference (EMI). To meet the set standards, the manufacturers have adopted a variety of methods for controlling EMI. These methods have ranged from redesigned basic circuitry to incorporation of conductive shielding materials in the devices. The incorporation of conductive shielding may take different routes:⁴⁵

- Use of metal enclosures
- Metallic foil tapes
- Metal coatings on plastic enclosures
- Conductive paints on plastic enclosures
- Conductive plastic enclosures
- Flexible laminates with metal foil

The shielding effectiveness of a homogeneous medium, such as a conductive coating, is related to the propagation of the electromagnetic field through the coating. The shielding effectiveness is directly related to the electronic and magnetic properties of the coating; therefore, for best shielding effectiveness, materials with both high relative magnetic permeability and high electrical conductivity are necessary. Thus, it has been found that the various metals and alloys form the following “series” in decreasing order of effectiveness:

Ag > Cu > Au > Al > Zn > brass > Ni > Sn > steel > stainless steel

Currently, the most cost-effective and the most problem-free materials for shielding are claimed to be nickel-filled acrylic or polyurethane conductive paints.⁴⁶

91.4.2 The Stealth

One of the more glamorous applications of conducting coatings has been in the “stealth” technology. Until the Pentagon revealed the top-secret Stealth (Figure 91.1) fighter on November 10, 1988, little could be said about its materials technology. The so-called stealth materials can provide a minimal radar profile for military aircraft and naval vessels. This profile is achieved primarily by a combination of geometric design and materials properties. The active components consist of several classes of materials: carbon fiber composites, radar-absorbing coating, ferrite layers, and interference layers in the form of certain pigment-filled polymer coatings.²¹ From other EMI work, it had been known for years that incorporating

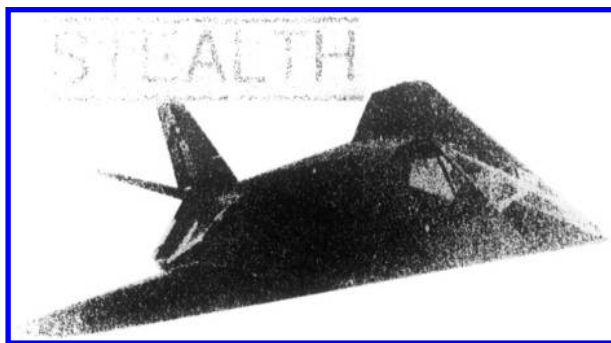

FIGURE 91.1 Stealth fighter.

short, electrically conducting fibers (e.g., stainless steel) into thermoplastics in as low as 0.5 vol% fraction gave sufficiently high levels of dc conductivity for electromagnetic shielding purposes.⁴⁷ One of the radar-absorbing coatings has been iron fibril-filled elastomeric epoxy.⁴⁸ Presumably, such coatings are most effective against short wavelength radars, and the longer the wavelength, the thicker the required coating.

91.4.3 Miscellaneous

A novel application of conducting coatings is to use them as ambient-responsive elements for remotely readable indicator devices.⁴⁹

Spacecraft charging problems have required efforts in the separation, shielding, and filtering to decouple discharges from susceptible circuits, and this decoupling involves the use of conductive surface coatings.⁵⁰

Conductive coatings are also used on waveguides, radio frequency reflectors, and radar dishes, and as radiofrequency shielding on capacitor plates.⁵¹

Electrochemically generated, conducting polyheterocycle coatings are good candidates for electrochromic displays.^{52,53}

Aluminum is being used on video disks and in large-area solar cells.⁵⁴

Conductive paints are used to enhance the electromagnetic field attenuation of equipment rooms or entire buildings.⁵⁵

Conducting coatings are used to coat rusty areas and bolts to suppress background noise in high frequency transmitters and receivers on ships and aircraft.¹⁹

Conductive coatings are candidates for passivating layers against photocorrosion of photoelectrodes and modifiers of electrodes for electrochemical reactions.⁵⁶

91.5 New Developments

The field of laser direct-write metallization of organometallic films has been expanding rapidly as the potential for accomplishing one-step pattern definition and metallization is realized.^{57,58}

Recently, ion implantation has been conducted on a variety of polymers with a variety of ion species. The result has been significant increase in electrical conductivity. Thus, for example, Kapton H film implanted with 1 MeV $^{15}\text{N}_2^+$ at several doses reached a conductivity of $1 (\Omega\cdot\text{cm})^{-1}$. It was suggested that the ion implantation led to graphite particle formation, probably along the penetrating ion tracks.⁵⁹

Conducting silver lines have also been generated by focusing a laser beam on a polyimide film containing dispersed silver nitrate.^{60,61}

A novel chemical method was used to generate an Ag–Hg alloy on the surface of a polyacrylamide film. The technique involved holding the polyacrylamide aqueous solution with AgNO_3 in a mercury-saturated atmosphere.⁶²

A recent symposium on laser and particle-beam chemical processing for microelectronics described laser direct writing of aluminum, copper, palladium, and carbon.^{63–67}

References

1. T. J. Miranda, in *Applications of Polymers*. R. B. Seymour and H. F. Mark, Eds. New York: Plenum Press, 1988.
2. H. Narcus, *Trans. Electrochem. Soc.*, 88, 371 (1945).
3. J. I. Kroschwitz, Ed.-in-Chief, *Encyclopedia of Polymer Science and Engineering*, Vol. 9. New York: Wiley, 1985.
4. C. C. Ku and R. Liepins, *Electrical Properties of Polymers, Chemical Principles*. New York: Hanser, 1987.
5. G. J. Shawham and B. R. Chuba, in "Materials — Pathway to the future," *SAMPE*, 33, 1617 (1988).
6. Y. Ikenaga, T. Kanoe, T. Okada, and Y. Suzuki, *Ausz. Eur. Patentanmeld. I*, 3(12), 485 (1987).
7. P. S. C. Ho, P. O. Hahn, H. Lefakis, and G. W. Rubloff, *Ausz. Eur. Patentanmeld. I*, 2(29), 1367 (1986).
8. S. John and N. V. Shanmugam, *Met. Finish.*, 84(3), 51 (1986).
9. R. Liepins, Camille Dreyfus Laboratory Annual Report, Research Triangle Institute, Research Triangle Park, NC, December 31, 1970, and unpublished results after 1970.
10. J. Fredrich, I. Loeschcke, and J. Gahde, *Acta Polym.*, 37(11–12), 687 (1986).
11. L. J. Krause, "Electroless metal plating of plastics," U.S. Patent 4,600,656 (July 15, 1986).
12. R. Cassat, "Metallizing electrically insulating plastic articles," U.S. Patent 4,590,115 (May 20, 1986).
13. R. Cassat and M. Alliot-Lugaz, "Metallization of electrically insulating flexible polymeric films," U.S. Patent 4,564,424 (January 14, 1986).
14. D. E. Davenport, in *Conductive Polymers*. R. B. Seymour, Ed. New York: Plenum Press, 1984, p. 39.
15. J. E. McCaskie, in *Modern Plastics Encyclopedia 1985–1986*, 62, No. 10A. J. Aranoff, Ed. New York: McGraw-Hill, 1985, p. 381.
16. V. Krause, *Kunsts. Plast. (Munich)*, 78(6), 17 (1988).
17. R. A. Baldwin, A. J. Gould, B. J. Green, and S. J. Wake, British Patent 2,169,925A (July 23, 1986).
18. A. Yanagisawa, H. Koyama, K. Suzuki, and T. Nakagawa, *Proceedings of the 31st International SAMPE Symposium*, April 7–10, 1986, p. 1583.
19. J. C. Cooper, Ru. Panayappan, and R. C. Steele, in *Proceedings of the 1984 IEEE National Symposium on Electromagnetic Compatibility*, April 24–26, 1984, San Antonio, TX, p. 233.
20. R. Liepins, B. Jorgensen, A. Nyitray, S. F. Wentworth, D. M. Sutherlin, S. E. Tunney, and J. K. Stille, *Synth. Met.*, 15, 249 (1986).
21. A. Wirsén, "Electroactive polymer materials." National Technical Information Service Publication PB86-185444, January 1986.
22. W. Werner, M. Monkenbusch, and G. Wegner, *Makromol. Chem., Rapid Commun.*, 5, 157 (1984).
23. H. Naarmann and N. Theophilous, *Synth. Met.*, 22, 1 (1987).
24. T. Yamamoto, K. Sanechika, and A. Yamamoto, *J. Polym. Sci., Polym. Lett. Ed.*, 18, 9 (1980).
25. S. Hotta, T. Hosaka, and W. Shimotsuma, *Synth. Met.*, 6, 317 (1983).
26. S. T. Wellinghoff, Z. Deng, J. Reed, and J. Racchini, *Polym. Prepr.*, 25(2), 238 (1984).
27. A. G. MacDiarmid, J. C. Chiang, M. Halpern, W. S. Huang, S. L. Mu, N. L. D. Somasiri, W. Wu, and S. I. Yaniger, *Mol. Cryst. Liquid Cryst.*, 121, 173 (1985).
28. J. C. Chiang and A. G. MacDiarmid, *Synth. Met.*, 13, 183 (1986).
29. W. S. Huang, A. G. MacDiarmid, and A. P. Epstein, *J. Chem. Soc. Chem. Commun.*, 1784 (1987).
30. R. B. Bjorklund and B. Liedberg, *J. Chem. Soc. Chem. Commun.*, 1293 (1986).
31. S. P. Armes and B. Vincent, *J. Chem. Soc. Chem. Commun.*, 289 (1987).
32. S. P. Armes, J. F. Miller, and B. Vincent, *J. Colloid Interface Sci.*, 118(2), 410 (1987).
33. S. P. Armes, M. Aldissi, and R. D. Taylor, "Non aqueous polypyrrole colloids," LA-UR-88-3855, submitted to *J. Chem. Soc. Chem. Commun.*
34. P. M. Kuznesof, R. S. Nohr, K. J. Wynne, and M. E. Kenney, *J. Macromol. Sci. Chem.*, A16(1), 299 (1981).
35. T. J. Marks, *Science*, 227, 881 (1985).
36. J. R. Reynolds, J. C. W. Chien, F. E. Karasz, and C. P. Lillya, *Polym. Prepr.*, 25(2), 242 (1984).

37. R. Liepins and K. Sakaoku, *J. Appl. Polym. Sci.*, **16**, 2633 (1972).
38. E. Kny, L. L. Levenson, W. J. James, and R. A. Auerbach, *J. Phys. Chem.*, **84**, 1635 (1980).
39. G. Smolinsky and J. H. Heiss, *Org. Coat. Plast. Chem.*, **28**, 537 (1968).
40. R. K. Sathir and W. J. James, in *Polymers in Electronics*. T. Davidson, Ed. ACS Symposium Series No. 242 Washington, DC: American Chemical Society, 1984.
41. R. Liepins, M. Campbell, J. S. Clements, J. Hammond, and R. J. Fries, *J. Vac. Sci. Technol.*, **18**(3), 1218 (1981).
42. E. Kny, L. L. Levenson, W. J. James, and R. A. Auerbach, *Thin Solid Films*, **85**, 23 (1981).
43. R. Liepins, "Method of forming graded polymeric coatings on films," U.S. Patent 4,390,567 (June 28, 1983).
44. R. Liepins, "Method of forming metallic coatings on polymer substrates," U.S. Patent 4,464,416 (August 7, 1984).
45. R. W. Simpson, Jr., in *Proceedings of the 1984 IEEE National Symposium on Electromagnetic Compatibility*, April 24–26, 1984, San Antonio, TX, 1984, p. 267.
46. D. Staggs, in *Proceedings of the 1984 IEEE National Symposium on Electromagnetic Compatibility*, April 24–26, 1984, San Antonio, TX, 1984, p. 43.
47. B. Bridge, M. J. Folkes, and H. Jahankhani, in *Inst. Phys. Conf. Ser. No. 89*, Session 8, p. 307, 1987.
48. T. A. Hoppenheimer, *High Technology*, December, 58 (1986).
49. R. H. Baughman, R. L. Elsenbaumer, Z. Igbal, G. G. Miller, and H. Eckhardt, in *Electronic Properties of Conjugated Polymers*. H. Kuzmany, M. Mehring, and S. Roth, Eds. New York: Springer-Verlag, 1987, p. 432.
50. K. J. DeGraffenreid, in *Proceedings of the 1985 IEEE International Symposium on Electromagnetic Compatibility*, April 24–26, 1984, San Antonio, TX, 1985, p. 273.
51. Emerson and Cuming, Technical Bulletin 4-2-14, Canton, MA.
52. M. Gazard, J. C. Dubois, M. Champagne, F. Garnier, and G. Tourillon, *J. Phys. Paris Colloq.*, **C3**, 537 (1983).
53. F. Garnier, G. Tourillon, M. Gazard, and J. C. Dubois, *J. Electroanal. Chem.*, **148**, 299 (1983).
54. W. J. Miller, in *Modern Plastics Encyclopedia 1985–1986*, **62**, No. 10A. J. Aranoff, Ed. New York: McGraw-Hill, 1985, p. 380.
55. H. E. Coonce and G. E. Macro, in *Proceedings of the 1985 IEEE International Symposium on Electromagnetic Compatibility*, April 24–26, 1984, San Antonio, TX, 1985, p. 257.
56. H. Munstedt, in *Electronic Properties of Polymers and Related Compounds*. H. Kuzmany, M. Mehring, and S. Roth, Eds. New York: Springer-Verlag, 1985, p. 8.
57. M. E. Gross, A. Appelbaum, and P. K. Gallagher, *J. Appl. Phys.*, **61**(4), 1628, (1987).
58. R. Liepins, B. S. Jorgensen, and L. Z. Liepins, "Process for introducing electrical conductivity into high-temperature polymeric materials" (submitted for patent).
59. T. Hioki, S. Noda, M. Kakeno, A. Itoh, K. Yamada, and J. Kawamoto, in *Proceedings of the International Ion Engineering Congress*, September 12–16, 1983. Kyoto, Japan, 1984, p. 1779.
60. A. Auerbach, *Appl. Phys. Lett.*, **47**(7), 669 (1985).
61. A. Auerbach, *J. Electrochem. Soc.*, **132**(6), 1437 (1985).
62. J. Y. Lee, H. Tanaka, H. Takezoe, A. Fukuda, and E. Kuze, *J. Appl. Polym. Sci.*, **29**, 795 (1984).
63. T. Cacouris, G. Scelsi, R. Scarmozzino, R. M. Osgood, Jr., and R. R. Krchnavek, *Mater. Res. Soc. Proc.*, **101**, 43 (1988).
64. J. E. Bouree and J. E. Flicstein, *Mater. Res. Soc. Proc.*, **101**, 55 (1988).
65. A. Gupta and R. Jagannathan, *Mater. Res. Soc. Proc.*, **101**, 95 (1988).
66. L. Baufay and M. E. Gross, *Mater. Res. Soc. Proc.*, **101**, 89 (1988).
67. A. M. Lyons, C. W. Wilkins, Jr., and F. T. Mendenhall, *Mater. Res. Soc. Proc.*, **101**, 67 (1988).

Silicone Release Coatings

Richard P. Eckberg
General Electric Company

92.1 Introduction	92-1
92.2 Thermal-Cured Silicone Release Agents.....	92-2
92.3 Radiation-Curable Silicone Release Agents.....	92-7
92.4 The Future	92-9
References	92-9

92.1 Introduction

Silicone release coatings are vitally important to the tag and label industry, which could not exist in its present form without reliable release agents. Silicones possess unique physical and chemical properties that make this class of substances ideal for the purpose of releasing pressure-sensitive adhesives. Silicone release agents worth \$130 to \$150 million were sold worldwide in 1988, contributing to products with a total value that exceeds \$3 billion.

The term “silicones” as commonly used refers to linear (two-dimensional) polydimethylsiloxanes, which may be structurally depicted as follows:

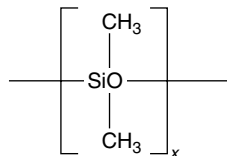

where x is an integer greater than 1. Silicon is tetrafunctional, so an infinite number of silicone polymers may be devised with different organic groups replacing methyl, or with three-dimensional resin structures wherein silicon atoms are incorporated in the polymer structure via three or four —Si—O— linkages. Since, however, the low surface tension, nonpolarity, chemical inertness, and low surface energy responsible for the outstanding release characteristics of silicone coatings all derive from the linear dimethylsilicone structure, this discussion focuses on linear polymers.

Silicone coatings that release pressure-sensitive adhesives have been in use for some 35 years. The chemistry and applications of silicone release coatings have undergone remarkable change during this time, with the pace of development accelerating in recent years. In the face of increasingly sophisticated and demanding requirements, silicones remain the only proven means of providing pressure-sensitive adhesive release for the tag and label industry.

The laminate structure normally used by the label industry is illustrated in [Figure 92.1](#).

The liner most often used is paper, usually a machine-calendered (i.e., supercalendered kraft), clay-coated, or glassine paper designed to minimize penetration during coating and curing of silicone. Good

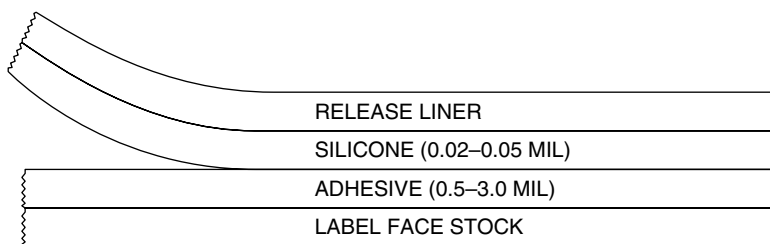

FIGURE 92.1 Pressure-sensitive label stock laminate (not drawn to scale).

holdout is essential for complete coverage at economically viable coat weights ($<1.2 \text{ g/m}^2$). Converters are also increasing their use of plastic films and film laminates to take advantage of plastics' dimensional stability and strength. Such substrates are often thermally sensitive, requiring suppliers to develop novel low temperature cure or radiation cure silicone systems to meet the new demands.

In use, the laminate construction herein depicted is split into two separate lamina: the release liner silicone lamina is peeled away from the label-adhesive lamina. Silicone coatings therefore function as a vehicle for the adhesive, permitting it to be applied far from where it is ultimately used. The low surface energy of a cross-linked polydimethylsiloxane surface (usually $\sim 22 \text{ dynes/cm}$) compared with the surface energy of organic pressure-sensitive adhesives (typically $>30 \text{ dynes/cm}$) prevents tight physical bonding of the adhesive to the silicone. That is, nonpolar silicone coatings are not compatible with highly polar adhesives, besides possessing minimal attractive forces toward other molecules. Chemically, the carbon-silicon and oxygen-silicon bonds of a dimethylsilicone molecule are unreactive, so that properly cured silicones are not prone to chemical interaction with pressure-sensitive adhesives with which they are in contact.

92.2 Thermal-Cured Silicone Release Agents

Silicone release coatings widely used today can be considered to be thermosets: they are applied in liquid form (100% silicone fluids or dispersed in solvent or water) to a release liner, then irreversibly converted to cross-linked films via thermally accelerated chemical reactions between reactive silicone polymers and silicone cross-linkers. "Thermal cure" is a somewhat misleading term, because the chemical reactions that effect cross-linking into a cured state take place at ambient conditions (25°C), as well as at oven temperature ($\sim 150^\circ\text{C}$). Upon conversion to absolute (Kelvin) temperature scale (room temperature = 300 K; oven temperature = 425 K), it is clear that an oven need furnish only half again as much energy to a reactive chemical system as is already present in the coating pan environment to bring about cross-linking. Mixing reactive silicone polymers, catalysts, and cross-linkers together therefore initiates the curing process; maintaining a complete coating mix at a coatable viscosity while still permitting rapid oven cure mandates the use of dispersing media, inhibitors, or other modifications, as described in this section.

Heat-accelerated silicone cross-linking (curing) reactions are of two types: condensation cure and addition cure. Condensation cure systems for paper release applications were the earliest development of this technology. Condensation cure utilizes silanol-chain-stopped dimethylsilicone polymers, polymethyl-hydrogensiloxane cross-linkers, and condensation catalysts. The polymers are illustrated below:

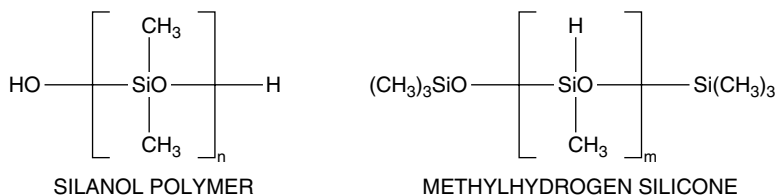

where n can vary from about 50 to more than 4000, while m is much less than n ; m normally is 10 to 50. SiH is a very reactive chemical species that readily condenses with silanol (SiOH) groups, forming extremely stable siloxane bonds and liberating hydrogen in the process:

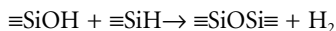

Many different catalysts accelerate or initiate this condensation reaction; metal soaps and driers such as dibutyltin acetate are the most efficient and economical, and are therefore in general use.

Condensation cure systems are applied as solutions in organic solvents (toluene or heptane, or mixtures thereof), or as oil-in-water emulsions, because in the absence of a dispersing medium, a catalyzed mixture of a silanol-stopped silicone plus polymethyl-hydrogen-siloxane cross-linker sets up to an insoluble cross-linked gel in a few minutes at room temperature. There is no known means of retarding the condensation reaction sufficiently at room temperature to permit solvent-free coating without rendering the composition uncurable at oven temperatures. Solvent (or water in the case of emulsions) therefore acts as a bath life extender through the dilution effect, while also permitting easy, convenient coating of the silicone material.

Although use of solvents or water mandates high oven temperature and solvent recovery, and entails fire or explosion risk, such materials are readily coated via simple techniques such as direct gravure, reverse roll, metering rod, and doctor blade. Coating out of a solvent vehicle also gives the silicone supplier wide latitude in silanol molecular weight; such dispersion products as General Electric SS-4191 consist of approximately 30 wt% solutions of high molecular weight silanol gums (MW in aromatic solvents). Even at 70% solvent, these products as furnished have viscosities exceeding 10,000 cps, requiring further dilution to about 5 wt% silicone solids with more solvent to render them coatable. The cross-linker is normally packaged in the silanol solution; catalyst is added to the fully diluted bath at time of use.

Controlling silanol molecular weight is a proven means of controlling the release characteristics of the cured condensation-cross-linked coating. Long chains of polydimethyl-siloxane between cross-linking sites provide a rubbery, elastomeric coating; shorted intercross-link intervals lead to higher cross-link density and a harder, more resin-like coating. The rubbery coatings provide tight (high) release, which displays a marked dependence on delamination speed in comparison to the low (easy) release independent of stripping speed obtained from highly cross-linked silicone films. Accordingly, silicone suppliers offer several different molecular weight silanol-based dispersion products, permitting the end user to obtain a desired range of release. The relationship between silanol chain length and nominal release level is graphically shown in [Figure 92.2](#).

Addition cure silicones resemble condensation cure silicones in some respects: both types of system rely on thermally accelerated cross-linking reactions between polymethyl-hydrogen siloxane cross-linker molecules and a separate reactive dimethylsiloxane polymer. Addition cure processes utilize catalyzed reaction of unsaturated organic groups attached to otherwise unreactive dimethylsilicones with SiH groups present on the cross-linker. Polymers in use are vinyl-functional silicones, the general structure of which may be represented as follows:

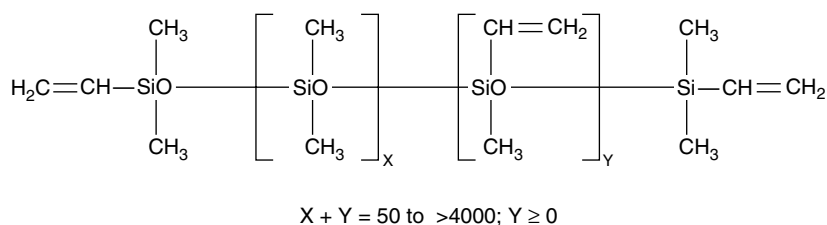

The curing reaction is an addition to the SiH group across the olefin double bond, also known as a hydrosilation process:

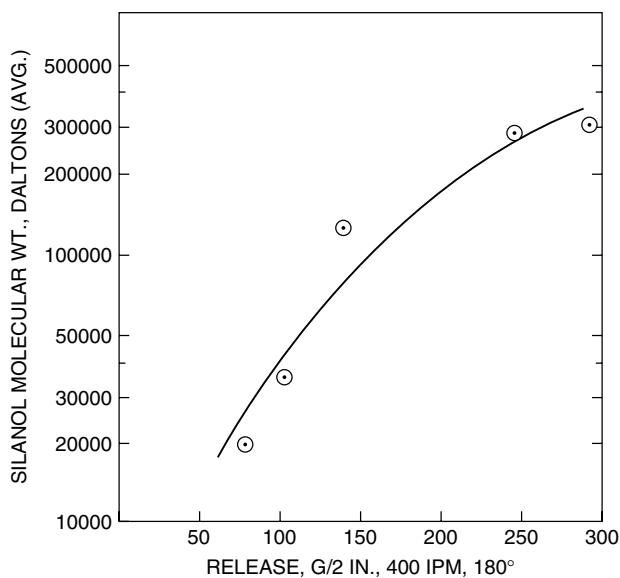

FIGURE 92.2 Release of an acrylic pressure-sensitive adhesive (Monsanto Gelva 263) as a function of silanol molecular weight.



With each polymer containing multiple reactive sites, it is clear that a very complex, highly cross-linked thermoset structure is obtained upon cure.

Hydrosilation can be triggered by heat, peroxides, azonitriles, and high energy ultraviolet or gamma radiation. These particular reactions are free radical in nature and are therefore not well suited for normal coating equipment, as radicals so generated are quenched by atmospheric oxygen. Hydrosilation catalyzed by silicone-soluble Group VIII precious metal compounds (certain complexes of platinum, rhodium, and the like) is the best means of curing solventless silicone coatings.¹⁻⁷ These catalysts effectively promote SiH + Si-vinyl cross-linking at concentrations in the part-per-million range, making their use economical despite their cost. The addition cure reaction is an example of homogeneous catalysis. The precise mechanism is not firmly established,^{8,9} but it is thought to be a concerted series of events in which the catalyst metal atom acts as a site to which reactive Si—H and olefin groups simultaneously bond in the proper proximity and stereochemical configuration for addition to occur.

This description of addition cure silicone chemistry is still incomplete. Whatever the system chosen, useful pot life of catalyzed mixtures of vinyl silicone and methylhydrogen silicone polymers seldom exceeds a few minutes at room temperature, like the condensation cure silicone system described previously. However, use of an important ingredient — the inhibitor — permits solvent-free coating of addition cure silicone release agents. Inhibitors function by tying up catalyst atoms at low temperature while still allowing rapid cure to occur at elevated temperature. An ideal 100% solids silicone coating composition combines instant cure at oven temperature with infinite pot life in the coating pan. Actual commercial systems depart from the ideal behavior, as shown in [Figure 92.3](#).

A clue to inhibitor function is provided by the hydrosilation mechanism. During the cross-linking process, SiH and Si-vinyl groups must at some time be coordinated to the platinum metal center. An inhibitor molecule that prevents access to catalyst atoms at low temperature must not block coordination sites at oven temperature. Inhibitors are therefore often selected on the basis of volatility, or because complexes formed with platinum are unstable and break down at high temperature. Many of these proprietary additives are described in the patent literature, ranging from classical complexing or chelating agents to electron-deactivated olefins and acetylenes.¹⁰⁻¹⁵

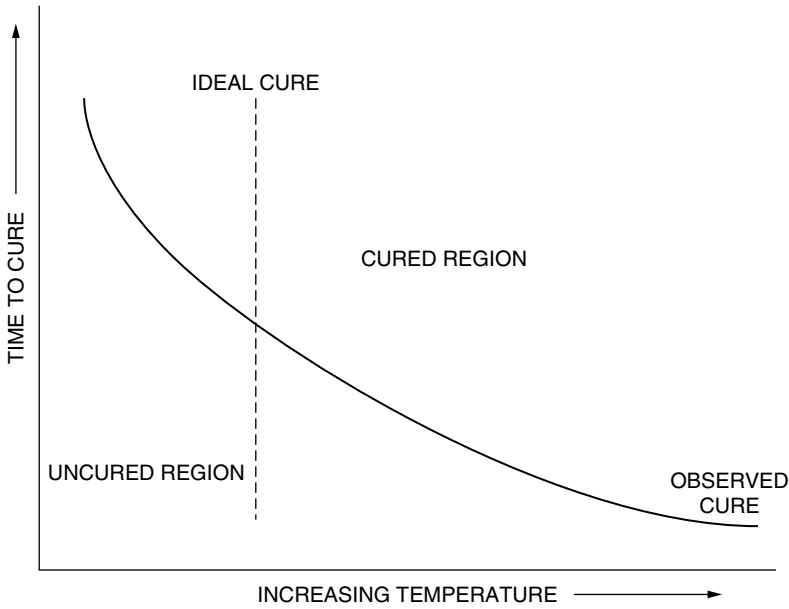
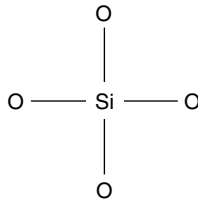

FIGURE 92.3 Cure time as a function of temperature.

Addition cure silicone release agents are available as solvent-free, low viscosity vinyl silicone fluids, as solvent-dispersed vinyl silicone gums (analogous to most silanol-based condensation cure products), and as emulsions. In each case, sufficient vinyl functionality is built into the linear silicone molecules to promote formation of highly cross-linked resinous cured coatings. These products therefore provide uniformly low (premium) release from most pressure-sensitive adhesives. Controlled release is not obtained by varying molecular weight of these vinyl silicone polymers (unlike the silanol case), and thus a different approach has been taken by silicone suppliers to combine the advantages of addition cure chemistry (particularly solventless packages) with a controllable range of release.

Studies of cured dimethylsilicone release coatings by electron spectroscopy for chemical analysis have confirmed that the surface is much more organic than would be predicted from the stoichiometry of the $(\text{CH}_3)_2\text{SiO}$ polymer unit.¹⁶ An adhesive in a laminate construction is therefore largely in contact with unreactive, bulky, freely rotating methyl groups; more polar —Si—O—Si— polymer backbones concentrate beneath the coating surface. A depiction of this postulated structure is offered in Figure 92.4.

Since the surface orientation of Si—CH_3 groups governs the release characteristics of highly cross-linked nonelastomeric silicone coatings, it follows that breaking up this nonpolar, featureless “methyl landscape” by inclusion of materials that alter the polarity of the silicone should alter the release of the coating. This is, in fact, accomplished by adding vinyl-functional silicone resins to the basic linear vinyl silicone polymers.¹⁷ “Resin” is here defined as nonlinear silicone structures bearing high concentrations of



functionally. Solventless high release additives are therefore mixtures of vinyl silicone resins with vinyl silicone fluids. Because these resins are normally friable solids when isolated, their blends with vinyl

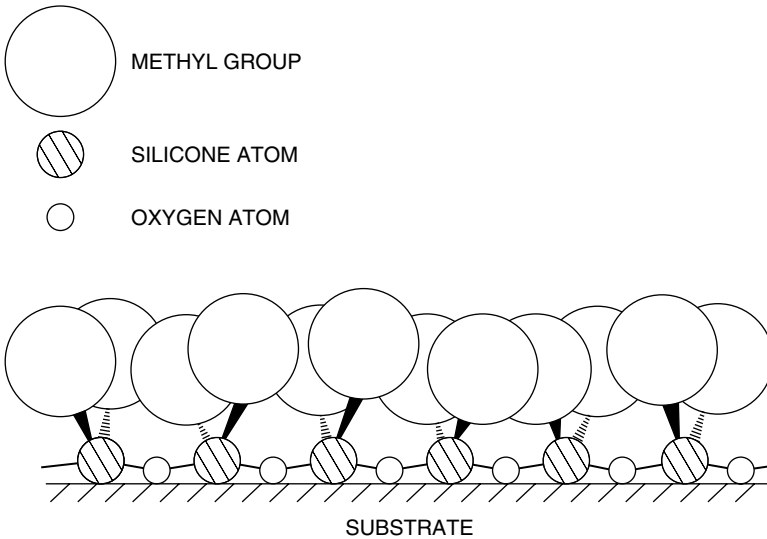

FIGURE 92.4 Representation of silicone release coating.

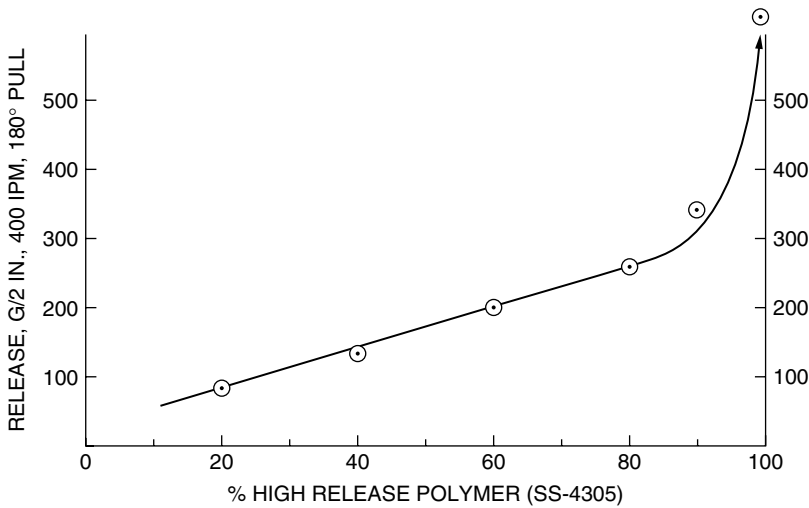

FIGURE 92.5 Solventless silicone (GE SS4300/SS4305 system) controlled release versus a pressure-sensitive adhesive based on styrene-butadiene rubber.

silicone fluids are much more viscous than the unblended fluids, which limits the amount of resin that can be present in solventless high release additives. Nonetheless, a wide range of controlled release can be obtained by use of suitable blends of high and low release solventless vinyl silicone products, as is illustrated in Figure 92.5.

Two solventless silicone product designs are available. The simplest system consists of three products:

- Low release polymer + catalyst + inhibitor
- High release polymer + catalyst + inhibitor
- Cross-linker

It has recently been discovered that more efficient use of expensive hydrosilation catalysts results from maintaining catalyst and inhibitor apart until time of use.¹⁸ Multicomponent systems taking advantage of this consist of the following:

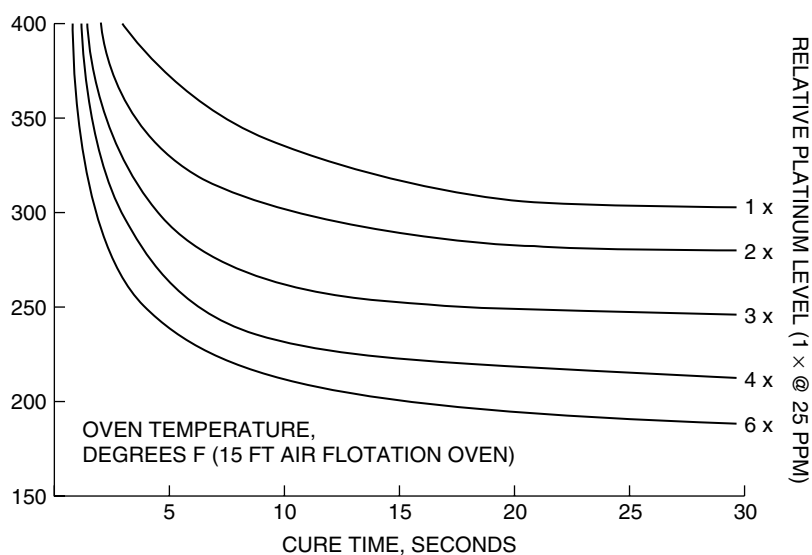

FIGURE 92.6 Cure as a function of catalyst concentration.

- Low release polymer
- Low release polymer + high catalyst concentration
- Inhibitor
- High release polymer
- Cross-linker

Separation of the solventless release package into its individual components permits converters to custom formulate their coating baths to optimize performance for any given application; determining the catalyst and inhibitor levels that provide best combinations of cure and bath life permits end users to derive the most benefit per silicone dollar. While in principle the hydrosilation reaction is zero order in catalyst, increasing the catalyst concentration speeds cure at a given temperature and lowers temperature required for cure at a given oven dwell time. This effect is illustrated in Figure 92.6.

Another approach to lowering siliconizing cost is the use of silicone-compatible olefin extenders. In principle, a nonvolatile unsaturated hydrocarbon miscible with addition-curable dimethylsilicone fluids should cure in the coating with little effect on release performance.¹⁹ In practice, replacement of silicone with less expensive organic olefins (or acetylenes) has not been firmly established as a means of reducing coating cost without performance penalty.

More than 30 domestic solventless silicone coating sites are currently in operation; new release coating capacity expected on stream in the near future will add to this number. These machines use offset gravure heads with multiple differential roll speeds to provide continuous coverage at low deposition. This coating technique works best with coating materials of less than 2000 cps viscosity. Silicone suppliers therefore furnish solventless silicones in viscosity ranges of 200 to 2000 cps (lower viscosity results in too much penetration of paper substrates), limiting polymer molecular weights to, roughly, 5000 to 20,000 daltons. Novel coating techniques have been reported that do not require gravure rolls and are claimed to work with higher viscosity materials.²⁰

92.3 Radiation-Curable Silicone Release Agents

Solventless silicone coating application extends to radiation-curable silicones, for there is no reason to furnish UV or electron beam (EB) processible materials in solvent carriers. Polydimethylsiloxanes are not cross-linked by UV or EB radiation at economically practical intensity or dose, respectively. Practical

radiation cure of silicones requires silicone polymers incorporating radiation-sensitive organofunctional groups, as illustrated below:

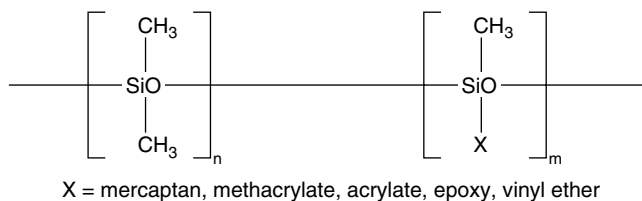

In addition, UV cure normally requires high concentrations of photosensitizers or photoinitiators, such as benzophenone, benzoin ethers, and cationic-type “onium” salts. The presence of polar organofunctional moieties plus photocatalysts in radiation-cured release agents causes significant performance differences between radiation-cured and conventional thermally cured silicones. Nonetheless, industry demands for low (or “zero”) temperature processing of silicone coatings to permit use of thermally sensitive films and to prevent demoisturization of papers have prompted considerable efforts by major silicone suppliers to develop, then improve, radiation-curable products. Radiation-curable silicones are now available from several sources.

Acrylated and methacrylated silicones were the focus of the earliest patented work in this area.²¹ Acrylated silicones specifically developed for release applications were introduced by Goldschmidt²² and are in commercial use at a small number of coating facilities equipped to perform EB cure. These materials have an important performance drawback inherent in free radical acrylate cross-linking chemistry: because cure is subject to severe inhibition by atmospheric oxygen, efficient inerting (<500 ppm O₂) of EB or UV cure chambers with nitrogen is essential for fast, complete cure to occur. While nitrogen blanketing is not impossible, inerting adds complexity and cost to the coating operation.

Cure chemistry pioneered by W. R. Grace & Company overcomes oxygen inhibition problems that interfere with radiation cure of acrylates. Mercapto-olefin addition is initiated by UV light in the presence of suitable photosensitizers, or by EB radiation. The reaction is analogous to hydrosilation:



The chemistry has been extended to release coatings by development of mercaptoalkyl-functional silicone polymers.^{23–26} While mercaptovinyl silicone systems can be UV cured in ambient atmosphere, market acceptance of products based on this technology has been slowed by their objectional odor (skunk fragrance is derived from mercaptans) and by the tendency of unreacted mercaptan residues in the cured coatings to chemically react and bond (via addition) to free acrylate usually present in cross-linkable acrylic pressure-sensitive adhesives. The same issues affect hybrid acrylic silicone-mercaptosilicone systems developed to take advantage of the oxygen insensitivity of mercapto-olefin addition.²⁷

Certain “onium” (sulfonium and iodonium) salts are known to be capable of initiating photopolymerization of epoxides²⁸ and vinyl ethers.²⁹ Epoxy-functional silicones are readily prepared,³⁰ so application of cationic UV cure to silicones was an obvious extension of the technology.^{31–33} A major performance advantage inherent in epoxy silicone-iodonium salt photocurable systems results from the non-free-radical nature of this cross-linking. This particular cure mechanism is not subject to oxygen inhibition, making UV-curable epoxy silicone based release agents particularly well suited to wide web converting operations, as nitrogen blanketing is not needed.

The epoxy silicone UV cure system has been shown to combine exceptionally fast UV cure response with premium, stable release versus cross-linkable acrylic, styrene-butadiene rubber, and hot-melt adhesives.¹⁶ As with other radiation-curable silicone release systems,³⁴ however, controlled release additives capable of providing a broad, predictable range of release for the UV epoxy silicone coatings have remained elusive. Another problem associated with these cationic cure silicone materials is substrate-dependent performance. Excellent cure, anchorage, and release are obtained when corona-treated films

and film laminates (such as polyethylene, polyethylene kraft, polypropylene, polystyrene, and certain polyesters) are coated, but slower cure, higher release, and inconsistent anchorage often occur when porous paper substrates are utilized. In many respects, this difficulty is analogous to problems encountered when solventless silicones were introduced and converters were first attempting to coat 100% solids silicones on paper release liners. More highly densified (or glassine) papers, perhaps treated with acidic coatings or sizing agents, ought to prove compatible with the UV-curable epoxy silicone release agents.

92.4 The Future

Solvent-dispersed thermal cure release coatings (condensation and addition cure) will be an important segment of the silicone coating market for years to come, particularly in Far East and Third World countries, where environmental and regulatory pressure to reduce the use of solvents is not a great factor. New coating capacity in North America and Europe will be predominantly solventless, with radiation cure capability built into new coating lines or retrofitted to existing 100% silicone solids equipment as acceptance of new silicone curing technology becomes widespread.

Silicone suppliers will accelerate development and commercialization of new and improved radiation cure and "zero temperature" cure products. An interesting area of research is room temperature cure silicones, consisting of one-part packages with cure that is triggered by moisture rapidly permeated through thin release coatings after they are applied.³⁵ Addition cure approaches to lower temperature cure 100% solids silicones have focused on more active catalysts and more volatile inhibitors; combining thermal and UV addition cure via UV-light-activated platinum hydrosilation catalysts³⁶ or UV-sensitive inhibitors³⁷ is another promising area of development. Few potential radiation cure silicone chemistry options have evaded development efforts, but vinyl ether-functional silicones (in concert with appropriate iodonium salt catalysts) seem to be capable of combining extremely fast noninerted UV cure³⁸ with EB curability, too.³⁹

Interesting and exciting new silicone chemistry is undergoing rapid acceptance by the traditionally conservative converting industry. The result is that yet-unknown liner materials and applications of silicone release agents will expand pressure-sensitive tag and label markets. Research and development by silicone manufacturers will drive this growth.

References

1. B. D. Karstedt, U.S. Patent 3,814,730.
2. B. A. Ashby, U.S. Patent 3,159,601.
3. H.F. Lameroux, U.S. Patent 3,220,972.
4. S. Nitzche et al., U.S. Patent 3,184,731.
5. G. Chandra et al., U.S. Patent 3,928,629.
6. A. Ossko et al., U.S. Patent 3,865,858.
7. M. Bargain, U.S. Patent 3,836,489.
8. J. F. Harrod et al., *J. Am. Chem. Soc.*, 86, 1776 (1964); 87, 16, 1133 (1965); 88, 3491 (1966).
9. L. N. Lewis et al., *J. Am. Chem. Soc.*, 108, 7228 (1986).
10. A. Berger et al., U.S. Patent 3,882,083.
11. G. V. Kookootsedes et al., U.S. Patent 3,445,420.
12. R. P. Eckberg, U.S. Patent 4,256,870.
13. R. P. Eckberg, U.S. Patent 4,347,346.
14. R. P. Eckberg, U.S. Patent 4,476,166.
15. S. Shirihata et al., U.S. Patent 4,465,818.
16. R. P. Eckberg, in *Radtech '88 Conference Proceedings*, New Orleans, 1988.
17. P. Sandford, U.S. Patent 4,123,604.
18. M. E. Grenoble et al., U.S. Patent 4,448,815.
19. A. J. Dallavia, U.S. Patent 4,526,953.

20. F. S. McIntyre et al., in *Proceedings of the 1987 TAPPI Polymers, Laminations, and Coatings Conference*, San Francisco, 1988.
21. J. D. Nordstrom et al., U.S. Patents 3,577,256; 3,650,813.
22. G. Koerner et al., U.S. Patent 4,306,050.
23. R. Viventi, U.S. Patent 3,8166,282.
24. J. Bokerman et al., U.S. Patent 4,052,059.
25. J. A. Colquhoun, U.S. Patent 4,070,525.
26. R. P. Eckberg et al., U.S. Patent 4,558,147.
27. F. Hockemeyer et al., U.S. Patent 4,571,349.
28. J. V. Crivello et al., *J. Polym. Sci.*, 17, 977, 1047 (1979).
29. J. V. Crivello et al., in *Radcure IV Proceedings*, Chicago, 1982.
30. F. D. Mendecine, U.S. Patent 4,046,930.
31. R. P. Eckberg et al., U.S. Patent 4,279,717.
32. R. P. Eckberg et al., U.S. Patent 4,421,904.
33. R. P. Eckberg et al., U.S. Patent 4,547,431.
34. R. H. Bickford, in *Radtech '88 Conference Proceedings*, New Orleans, 1988.
35. G. R. Homan et al., U.S. Patent 4,525,566.
36. T. J. Drahnak, U.S. Patent 4,510,094.
37. R. P. Eckberg, U.S. Patent 4,670,531.
38. J. V. Crivello et al., U.S. Patent 4,617,238.
39. S. C. Lapin, in *Radcure '88 Conference Proceedings*, Baltimore, 1988.

Silicone Hard Coatings

93.1	Introduction	93-1
93.2	Substrates	93-2
93.3	Uses	93-2
93.4	Application of the Coating.....	93-2
93.5	Conclusions	93-3

Edward A. Bernheim
Exxene Corporation

93.1 Introduction

Silicone (polysiloxane) hard coatings are finishes of superior abrasion resistance and inertness to hostile chemical and environmental conditions. They consist of several monomers and other ingredients, and the makeup of the formulations varies from manufacturer to manufacturer. Among the highly varied components are monomeric silanes, dimerized silanes, silane hydrozylates, silaceous materials, leveling agents, flow control agents, cross-linking agents, and catalysts of various types. Silicone coatings are solvent-borne coatings. Some of the possible solvents are alcohols and glycol ethers. This includes such alcohols as isopropanol, propanol, ethanol, *n*-butanol, isobutanol, and methanol.

Polysiloxane coatings are applicable to many substrates, but the majority of applications are on nonmetallic surfaces, especially plastics. Silicone coatings can be dyed or pigmented, but for the most part these coatings are used as clear top coatings. They have excellent light transmission and actually improve the optical properties of the material that is coated.

Some of the plastics that are used with polysiloxane coatings are polycarbonate, acrylic, polyarylate, polysulfone, vinyls, nylons, polyester, cellulose acetate, cellulose acetate-butyrate, and polyolefins, just to name a few. Despite this plethora of materials, acrylics and polycarbonates are generally the plastics of choice.

Silicone hard coatings do not have automatic adhesion to all plastic surfaces. Materials such as polycarbonate and acrylics will, in many cases, have tape adhesion without need of surface treatment, etch, or primer coat. Many of the other substrates cannot be coated successfully without pretreatment. Many of the materials require either a corona discharge or a plasma treatment. For long-term outdoor stability, polycarbonate requires a primer coat to be applied first.

Plastic, to be coated, comes in many forms. Silicone coatings are used on cast sheet stock, extruded sheet stock, molded parts, lenses, windows, films, etc. The application methods are also quite varied. Some of the methods are spraying, flow coating, spin coating, dip coating with various withdrawal speeds and, with some formula modifications, pad coating and roller coating. The coatings are not suitable for screen or gravure application.

Hard silicone coatings are useful as antifog, antistatic photochromic, color-dyed, pigmented, UV absorbing, UV stabilized for exterior exposure, chemical resistance, 5-min curing, and tinted coatings. Many of these properties can be combined in one coating. The coatings are used in such diverse areas as the automotive, electronic, computer hardware, architectural and architectural glazing, recreation, sporting goods, protective eyewear, safety, and optical industries.

TABLE 93.1 Cure Schedules and Pretreatment of Some Substrates

Plastic Substrate	Typical Cure Temperature (°F)	Typical Cure Time (min)	Prime Coat, or Surface Treatment (Recommendation)
Polycarbonate	250	5–60	Primer (exterior and some interior use)
Acrylic	190	20–120	None
Polyarylate	190–325	20–60	Primer or solvent addition
Vinyl	140	60–180	Corona or plasma discharge
Cellulose acetate	150	30–60	Alkali etch
Cellulose acetate-butylate	145–200	30–60	Alkali etch
Polyester	180–375	4–60	Corona or plasma discharge

The coatings cure thermally at baking schedules that vary with the heat stability of the substrate. The baking schedule can be influenced by such process variables as airflow, nonair media, and uniformity of heating. There are many types of silicone coating, and because of this most data given will have large variances. The cure times of these coatings vary from 5 min to 3 h. Since these are solvent-borne coatings, if they are placed in heat immediately after coating, the higher area of the coating strata will cure first, leaving solvent entrapped in the film. Solvent entrapment in the coating entails such possible problems as lower abrasion resistance, weaker adherence to the surface of the substrate, chemical resistance, and loss of some durability.

The parts must be free of dust, dirt, grease, and mold release. When not in use, this type of coating should be stored at a temperature of 40°F. Storage of the coatings at low temperature increases the life of the coating by three or four times that of the same coating under ambient conditions. The storage life for polysiloxane coatings is anywhere from 2 weeks to about 17 months at room temperature. With this wide range of stabilities, the stability of the coating chosen should be confirmed by querying the manufacturer. In many cases, it is wise to have the coating shipped by refrigerated truck or by air freight.

The price of the coatings may vary from \$70 to \$200 per gallon. The coverage can vary from 300 square feet per gallon to as much as 2000 square feet per gallon, depending on drip reusability, dilution, and coating viscosity.

93.2 Substrates

The data in Table 93.1 suggest how silicone hard coatings are used. The coatings are applicable for many other substrates. Solvent addition will change coating properties and give additional adhesion in some cases. With treatment, the use of these coatings on metals is quite possible. The solvent flash-off time will also have an effect on the ultimate cure schedule. The more complete the removal of solvent, the quicker the time of cure. Hardness is increased by longer cure times.

93.3 Uses

Table 93.2 gives a number of current uses for polysiloxane coatings. These very versatile coatings are alcohol based, which makes them quite mild even on sensitive substrates. The biggest problem in determining a new use is the heat stability of the material to be coated. The length of the cure time will also help to determine whether the process is feasible.

93.4 Application of the Coating

A typical application procedure is summarized as follows:

1. Remove all protective masking and wrapping material.
2. Check the parts for optical quality.

TABLE 93.2 Some Uses of Polysiloxane Hard Coatings

Train windows	Plane windows
Glazing for windows	Car headlight
Car taillights	Auto parts
Computer screens (low gloss)	Electronic components
Gauge covers	Instrument covers
Electronic sensors (antifog properties help continuous readability)	
Computer housings	Instrument housings
Protected printed parts	Racquetball glasses
Ski goggles	Swimming goggles
Sunglasses	Safety glasses
Prescription glasses (may require tintable coating)	
Chemical splash glasses	Fireman's face shields
Lenses for gas masks	Full face shields
Scuba masks	Plano lenses
Shields for self-contained breathing apparatus	
Bus windows	Truck windows
Motorcycle shields	Watch crystals
Surgical shields	Outdoor lighting
Operating theater lights	Dental lights

- Clean the parts. Some of the methods are solvent cleaning with alcohols and other mild solvents, ultrasonic cleaning with aqueous cleaning solution or trichlorotrifluoroethane, vapor degreasing, and roll cleaning machines that remove particulate with a high tack, nondeposit surface.
- Before coating, treat the parts to prevent any possible static problems. This can be accomplished in a number of ways.
- Perform annealing, which may be necessary in some parts, depending on substrate, coating, and the stress in the ultimate part.
- Consider such other factors in the coating operation as temperature at which the material must be maintained, temperature of the room, maximum and minimum humidity, material of construction for coating vessels, and need of filtration.
- Be sure that the parts have their solvent flash-off under very clean conditions. Baking should be performed for the required time period and temperature.

The following coating processes may be used:

Dip Coating. The part is immersed in the bath and withdrawn by hand or by a mechanized method. Slow withdrawal produces even coating thickness from top to bottom and no drip buildup at the bottom. Faster withdrawal methods produce parts faster, but with less coating uniformity and a greater buildup at the bottom of the part.

Flow Coating. This consists of running a filtered stream of coating across the top of a part and letting the excess material drip off at the bottom. This method is good for coating one side of a part.

Spray Coating. This easily automated method is suitable for coating one or both sides of a part. The coating might have to be diluted to be sprayed.

93.5 Conclusions

Hard polysiloxane coatings have become important in many industries. In the overall framework of modern coating technology, these coatings are in their infancy. Their tremendous hardness and excellent properties in very hostile environments make them candidates for expansion into other areas of use.

94

Pressure-Sensitive Adhesives and Adhesive Products

94.1	Introduction	94-1
94.2	Adhesives.....	94-1
94.3	Adhesive Properties.....	94-2
	Tack • Peel Adhesion • Shear Resistance • Other Tests • Dynamic Mechanical Analysis	
94.4	Products	94-5
	Tapes • Labels • Other Products	
94.5	Processing	94-5
	Coating • Drying • Slitting and Die-Cutting	
	References	94-7

D. Satas*

Satas & Associates

94.1 Introduction

Pressure-sensitive adhesives (PSAs) adhere to various surfaces just by application of a light pressure and usually can be easily and cleanly separated. To meet these basic requirements, the adhesive must be sufficiently soft in order to be tacky to touch and also have a sufficient cohesive strength to maintain its integrity upon separation.

The invention of rubber-based PSAs is attributed to Dr. Henry Day.¹ Such an adhesive consisted of India rubber, pine gum, and other ingredients. The first patent was issued to Shecut and Day in 1845.² The early uses were limited to medical applications, and the progress of further development was slow. The first industrial applications of pressure-sensitive tapes appeared only in 1920 and labels in the late 1930s.

The technology of PSAs and adhesive products is covered extensively in the *Handbook*.³

94.2 Adhesives

The basis of a PSA is an elastomer made tacky by addition of tackifying resins. Natural rubber was the first material used and still is among the most important elastomers for compounding of PSAs. The general composition of such compounded adhesives is as follows.

- Elastomer, 30 to 60%
- Tackifier, 40 to 60%
- Plasticizer, 0 to 30%

*Deceased.

Filler, 0 to 30%

Antioxidants, 1 to 2%

Other elastomers used widely in addition to natural rubber are styrenic block copolymers, especially those with isoprene midblock. Block copolymers made the basis for successful hot-melt adhesives. Styrene butadiene rubber, polyisobutylene, and butyl rubber are also used.

These elastomers must be tackified with resins compatible with the elastomer forming a tacky material. The resins may be synthetic of petroleum origin (based on C5 or C9 monomers) or they may be based on wood rosin collected from coniferous trees (or from tall oil, a by-product of paper manufacturing). Such rosins are chemically altered to improve their stability.

Another category of PSAs is copolymers of acrylic esters. These polymers are inherently tacky and do not require compounding with resins or other additives, although they may be sometimes compounded to enhance or change their properties. They are clear and have a good resistance to oxidation and ultraviolet (UV) light. Acrylic copolymers quickly became the most important materials for pressure-sensitive products.

Silicone PSAs are also available. They are expensive and their usage is small, but their usefulness at high and low temperatures is unique and not approached by other polymers.

PSAs are available in several forms: as solutions in organic solvents, as aqueous emulsions, as hot-melts, as 100% solids for calendaring or extrusion applications, and as 100% reactive materials for thermal or irradiation curing after application. Solution adhesives are the easiest to apply and are the most versatile in their properties. They are not desirable environmentally, because of solvent emission; but many companies have invested in solvent recovery equipment and can effectively handle solution adhesives. Hot-melt application has the advantages of environmental acceptability, high coating speeds, and less expensive equipment. Hot-melt adhesives are based mainly on block copolymers. Aqueous adhesive emulsions, along with hot-melts, are the fastest growing types. Acrylic adhesives are important as aqueous emulsions, though SBR and natural rubber latexes are also used. The 100% solid adhesives are used in calendaring processes and can be applied by extrusion. There is considerable current interest in 100% reactive adhesives, especially cured by UV radiation, but their future is questionable.

94.3 Adhesive Properties

The main properties of PSAs are considered in the trade to be tack, peel adhesion, and shear resistance. Sometimes these properties are thought to constitute the adhesive performance. If under the adhesive performance we understand the adhesive product behavior in its application, then these test values, although important, are not sufficient.

94.3.1 Tack

Tack is the capability of the adhesive to form a bond at low pressure during a short time period. It is measured (most frequently) as the force required to separate such an instantaneous bond formed at low pressure. A subjective measure of tack is experienced by placing a thumb over the adhesive surface and quickly removing it. Tack is tested by several techniques, and it is basically defined by the testing method. Thus, the probe tack test has been designed to approximate thumb tack, the loop tack and quick stick techniques are similar to peel testing, and the rolling ball tack test employs a steel ball rolling on the adhesive surface. While tack is the main property that makes the adhesive pressure sensitive, its numerical determination depends on the testing technique used, and the tack value is not that important in describing the adhesive performance. [Figure 94.1](#) shows the loop tack measurement.

94.3.2 Peel Adhesion

Peel adhesion is measured by applying the tape to a standard stainless steel panel and measuring the force required to remove the tape by peeling at 180 or 90 degrees. The peel test gives important data in

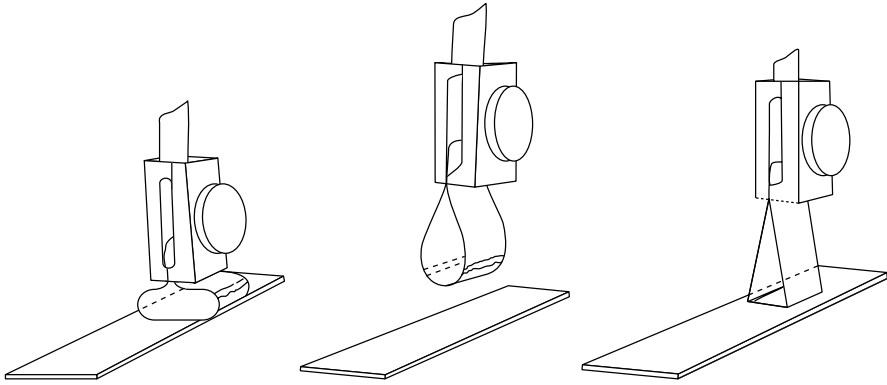

FIGURE 94.1 Loop tack test.

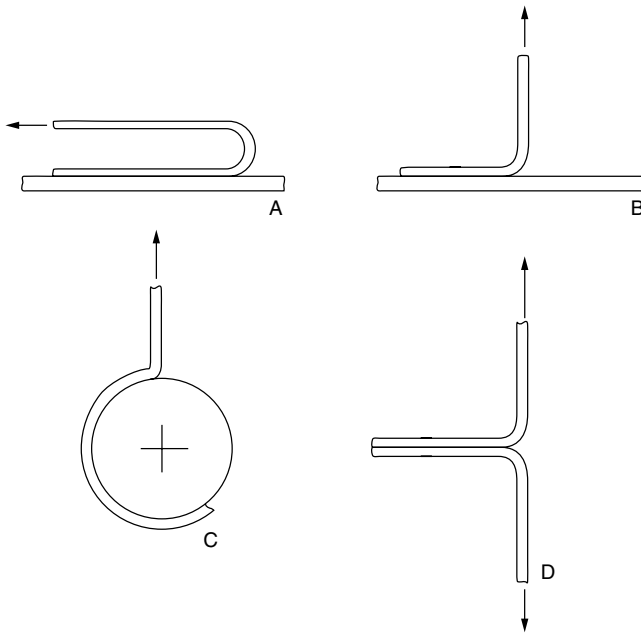

FIGURE 94.2 Schematic diagram of various peel tests: (A) 180-degree peel; (B) 90-degree peel; (C) drum peel (tape unwind); (D) T-peel.

evaluating the adhesive. However, the peel values depend on the test conditions and on the stiffness of the tape backing. We are measuring not only the force required to break the adhesive bond but also the energy expended to deform the backing and the adhesive itself. The test results, therefore, are comparable only to the adhesive applied to the same backing. Figure 94.2 shows the 180° peel test arrangement, and Figure 94.3 shows the peel test results for tapes with various backings and various backing thicknesses.

In the case of paper label stock, the failure is paper failure, except in the case of removable adhesives. In label stock, however, the release of silicone-coated liner from the adhesive is important, and the release is tested similarly to the peel test.

94.3.3 Shear Resistance

Shear resistance is the only test of the main three tests that measures directly the cohesive strength of the adhesive, and it correlates well with its viscosity. The shear resistance can be measured by recording the

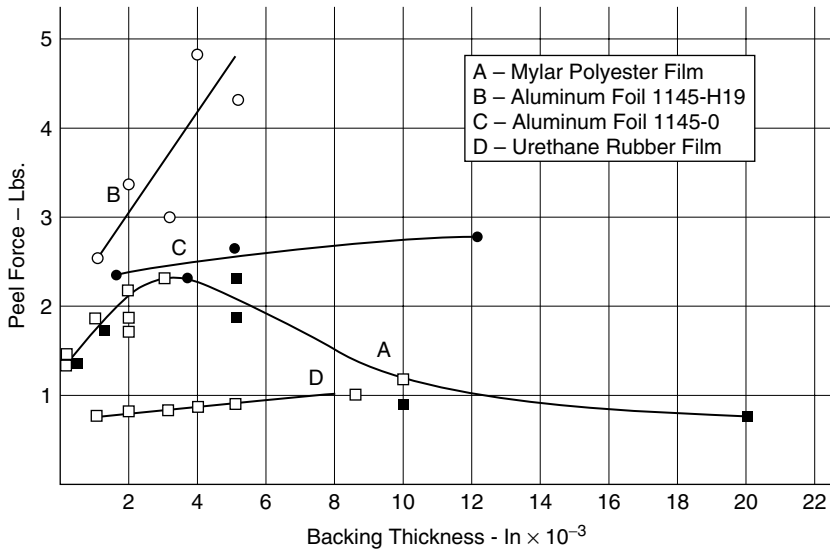

FIGURE 94.3 The dependence of peel force on the backing thickness in a 180-degree peel test. [Reprinted from *Adhesive Age*, 9(8) (1966).]

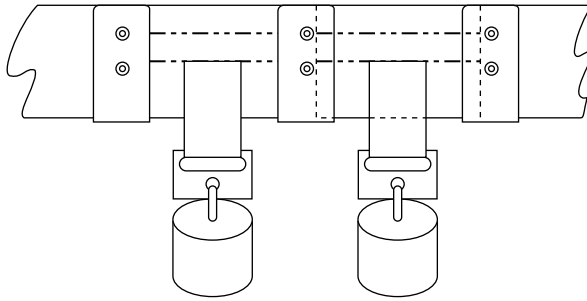

FIGURE 94.4 Shear test.

time to failure (cohesive) under some static load. Shear creep is measured by the distance the adhesive has moved in a given time under a static load. Shear resistance shows directly the capability of the adhesive to carry the load, and it is an important factor in predicting the adhesive's behavior under the load. Figure 94.4 shows the shear test setup.

94.3.4 Other Tests

The main information expected from testing is the determination of whether the adhesive performs well in the intended application. The above tests generally do not give such information, and therefore a large number of specific application tests are used. Special tests are available or are improvised for various applications, such as hospital and first aid tapes, electrical tapes, packaging uses, masking and surface protection tapes, and other uses.

94.3.5 Dynamic Mechanical Analysis

PSAs are viscoelastic materials, i.e., their properties depend upon the rate of force application. Therefore, it is of interest to investigate the mechanical adhesive properties (such as moduli) at various shear rates. Such data also appear to shed considerable light on the adhesive performance, which mainly depends on the bulk adhesive properties. This test is covered in a separate chapter.

94.4 Products

PSA-coated products are subdivided into three main groups: tapes, label stock, and other products. Tapes are narrow strips of material with adhesive applied on one side and wound in a roll. Generally no release liner is needed; the adhesive unwinds from the outer side of the backing, which may be coated with a special release coating.

Label stock is printable material with the adhesive coating on one side, which is protected by easily removable silicone-coated liner.

94.4.1 Tapes

Tapes can be subdivided according to the backing material used: film tapes, fabric, paper, foil, foam, etc. Special tape products are double-coated tapes, which have adhesive on both sides of a supporting sheet (film, paper, nonwoven fabric, foam), and transfer tapes, which consist of an unsupported adhesive film. Double-coated tapes and transfer tapes are protected by a silicone-coated release liner. These tapes are heavily used for product assembly applications and mounting and holding uses.

Tapes are also subdivided according to their application. Packaging tapes are the largest single application. This field is dominated by OPP film tape, but other film, paper, and glass fiber reinforced tapes are also used. Medical tapes and related products constitute an important product area. Office tapes are dominated by matte acetate film tape, although cellophane film tapes are still used. Electrical tapes include many products starting with black vinyl electrician's tape and ending with high-temperature fiber/film tapes with silicone adhesive. The automotive industry consumes many different tapes: electrical harness wraps, paint masking tapes, product (including foam) assembly tapes, and tapes for many other applications. The construction industry requires paint masking tapes, foam tapes for gasketing, tapes for insulation of heating and air conditioning ducts, and many other uses. The appliance industry uses wood grain and other surface decorating tapes, tapes for attaching name plates, foam gasketing tapes, etc. Tapes are used in all industries for many different applications. In most cases, PSAs are used for easier and more convenient application.

94.4.2 Labels

PSAs are increasingly used for labels. Although they are more expensive than labels secured by waterborne or hot-melt adhesives, because a release liner is required, PSA label application equipment is less expensive, it is easier and cleaner to run, and the adhesive is quite suitable for plastic surfaces, such as polyethylene containers. PSAs are used for impervious foil labels; they are easier to use for intricate label design, and they are used for transparent film invisible labels.

The label industry consists of two separate groups. Large manufacturing companies produce label stock: unprinted adhesive-coated large rolls or sheets. These are sold to label manufacturers who print and die-cut the labels. While there are only few label stock manufacturers, there are many label printers, often servicing a limited geographical area.

94.4.3 Other Products

PSAs are used for many different products other than tapes and labels. The medical area is a large one for a variety of dressings, transdermal drug delivery systems, and other products and devices that use pressure-sensitive adhesives to secure these devices to the human body. Easily removable stickers (Post-its) have been developed for office uses. There are many other office uses that employ PSAs. The list of other products is difficult to exhaust, and this area is growing fastest and carries the highest markup.

94.5 Processing

PSAs are applied in thin layers on various substrates. Most of the coating is carried out roll-to-roll, i.e., the substrate is supplied as a wound roll, it is unwound, the adhesive is applied to the substrate's surface,

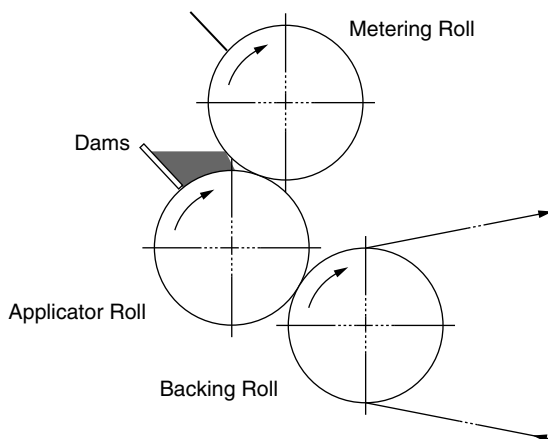

FIGURE 94.5 Top nip fed three-roll reverse roll coater.

the adhesive is dried or otherwise hardened, and then the substrate is rewound into a large roll. Further processing then starts with the material in a large coated roll.

94.5.1 Coating

The adhesives are applied by specialized coating equipment. They must be liquid, or sufficiently fluid, to form a thin layer in the coating head. Coating equipment is discussed in several books.^{4,5} Several techniques are used for PSA coating. The reverse roll coater (see Figure 94.5) is the most versatile and frequently used machine for solvent-borne and aqueous adhesives. Knife-over-roll coaters are used for heavier solvent-borne adhesive coaters. The slot orifice coater is the main technique for the application of hot-melt adhesives, and this technique is also useful for the coating of aqueous emulsion adhesives. Calendering is used for some specialized adhesive products. The compounded solid adhesive is squeezed and formed into a thin sheet between heavy calender rolls. Calendering was the main coating technique early in the development of PSA products.

94.5.2 Drying

If the adhesive is applied as solution or emulsion, it requires drying before it can be wound up. Forced air convection dryers dominate this application, with less frequently used infrared heating. The web is carried through the oven supported on idlers, sometimes on an apron, or sometimes supported by an air cushion in floatation ovens. More detailed information on web drying can be found in several books.^{4,5} No drying is needed in hot-melt coating: cooling is sufficient to solidify the adhesive. UV irradiation is also used as means of solidifying reactive adhesive coatings by the initiation of a polymerization reaction in the reactive oligomer and monomer mixture.

94.5.3 Slitting and Die-Cutting

Large rolls produced on the drying equipment are slit to narrow tapes or to wide material in case of label stock to be printed and die-cut. Several slitting techniques are used: shear, score, and razor blade. See Reference 3 for more detailed information on the slitting of PSA products. The label stock is die cut by cutting through the label material and leaving the backup release liner uncut. Rotary die cutters are usually employed. The matrix between the labels is peeled off and the labels are then dispensed as needed.

References

1. C. W. Bemmels, "Pressure-sensitive tapes and labels," in *Handbook of Adhesives*. I. Skeist, Ed. New York: Van Nostrand Reinhold, 1977.
2. W. H. Shecut and H. H. Day, U.S. Patent 3,965 (1845).
3. D. Satas, Ed., *Handbook of Pressure Sensitive Adhesive Technology*, 3d ed. Warwick, RI: Satas and Associates, 1999.
4. D. Satas, Ed., *Web Processing and Converting Technology and Equipment*. New York: Van Nostrand Reinhold, 1984.
5. E. D. Cohen and E. B. Gutoff, Eds., *Modern Coating and Drying Technology*. New York: VCH Publishers, 1992.

95

Self-Seal Adhesives

Larry S. Timm
Findley Adhesives, Inc.

95.1 Introduction	95-1
Adhesion and Cohesion • Seal Performance	
95.2 Application Techniques.....	95-3
Handling • Procedures	

95.1 Introduction

Cohesives, often referred to as “self-seal adhesives,” are coatings which in a dry state exhibit the unique ability to selectively stick to themselves when brought together under pressure.

95.1.1 Adhesion and Cohesion

Natural rubber is the ingredient common to all self-seal adhesives. It is this raw material, generally utilized in the latex form, which confers or facilitates the ability to cohere.

Natural latex consists of long chain, high molecular weight molecules, the ends of which are thought to contain an extra double bond protected with a weak hydrogen-bonded protein molecule. It is believed that when such molecules are positioned in intimate contact and mechanical or thermal energy is introduced, the following reaction takes place. First, the weakly hydrogen-bonded protein molecule breaks from the long chain and second, stored elastic energy from within the molecule is released, causing molecular vibration. The subsequent entanglement of the chains and joining at the now-available bonding sites produces a molecular inseparable condition referred to as a cohesive seal (Figure 95.1, Figure 95.2, and Figure 95.3).

In application, the greater the number of bonding sites utilized to impart adhesion, the smaller the number remaining to facilitate subsequent adhesion.

Laboratory evaluation on the functionality of self-seal formulations confirms the significance of achieving an appropriate adhesive/cohesive balance relative to a specific substrate.

Through product selection or formula modification, it is possible to enhance or accentuate the adhesive or the cohesive properties, but not, however, without inversely diminishing the other set. A product exhibiting the appropriate adhesive/cohesive balance is chosen after considering the seal functionality requirements mandated by the application and other pertinent performance parameters. In addition, product selection can be made only after the influence of the specific substrate on the adhesive/cohesive balance has been acknowledged.

Coating weight also affects seal functionality. Approximately 3.5 g/m² is required to ensure proper film formation, generating optimum adhesive functionality; 5.0 g/m² is generally suggested as the coating weight offering the most reliable performance. Consequently, the adhesive/cohesive balance is typically evaluated at this coating weight, whereas 7.0 g/m² represents perhaps the highest commercially viable coating weight for one-pass applications that require enhancement of the cohesive functionality over that which is available through formulation.

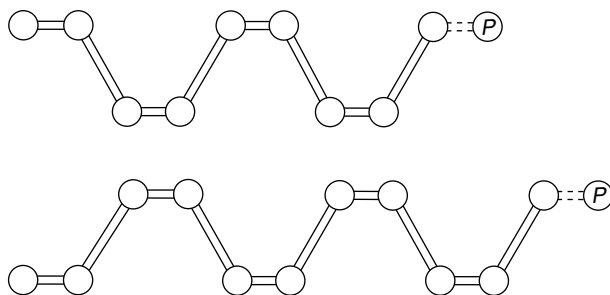

FIGURE 95.1 Long chain natural latex molecules.

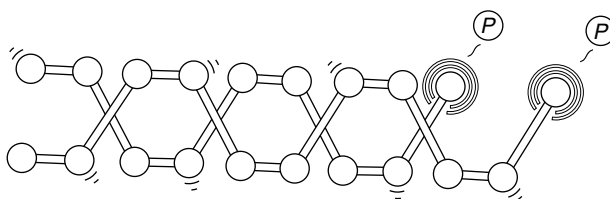

FIGURE 95.2 The effect of energy in seal formation: molecular excitation; severing of the “protein” molecule.

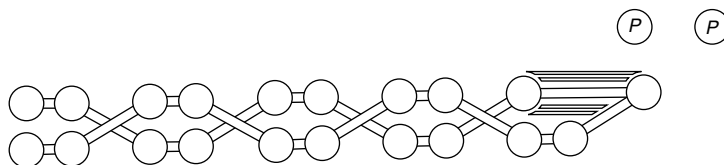

FIGURE 95.3 Cohesive seal consisting of both chemical bonds.

Drying or, more significantly, insufficient drying, can influence the performance of the product as well. Excessive retained moisture is the equivalent of a plasticizer addition, minimizing adhesion while accentuating cohesion. Additionally, retained moisture can create a roll blocking problem. Polyamide-based overprint lacquers typically employed for release can themselves become softened in the presence of excessive moisture.

Cohesives are dried at temperatures ranging from 50 to 90°C; however, drying is best accomplished at a web temperature of 60 to 70°C and through the use of a scrubbing zoned drying, or otherwise minimizing the amount of moisture-laden recirculated air.

95.1.2 Seal Performance

Eminently important in evaluating, testing, and anticipating seal performance is an understanding of the significance of the mode of failure. Simply stated, observe and record whether the seal strength obtained represents an adhesive, cohesive, or substrate failure. In these respective cases, the self-seal is not adhering to the substrate, the self-seal is not adequately sticking to itself, or delamination or fiber tear/film destruct, is occurring.

Some further descriptive commentary on the mode of failure is appropriate:

- *Webby*: adhesive failure (en masse release from one or the other side)
- *Leggy*: adhesive failure (tenacious, elongating, rubber-like bands)
- *Stringy*: cohesive failure (short or fine elastic strands, splitting seal)
- *100% cohesive failure* (visually appears undisturbed, as before sealing)

Thus, significant in evaluating seal performance is the recording of the procedures utilized in testing. Test methods used should relate as closely as possible to the actual conditions employed in commercial seal formation.

Self-seals are pressure respondent. The greater the pressure, the more immediate the cohesion response. However, the introduction of mechanical energy can help to form a bond and generate a suitable response in a mature seal. A seal is considered to be mature after 1 h, but some minimal increase in strength may continue to develop for up to 24 h before a fully stabilized condition is achieved. Typically associated with an increase in seal strength is a change in the mode of failure. For instance, a 100% cohesive failure at 300 g/25 mm could yield a substrate destruct seal at 800 g/25 mm with increased pressure or aging. No such similar change or improvement would be realized from a seal exhibiting an adhesive failure. It is only the developing cohesive response that is subject to this improvement.

As already mentioned, it is an accepted practice to utilize polyamide-based overprint lacquers to inhibit roll blocking. Careful consideration must, in fact, be given to selecting an ink-overprint system that is specific to the substrate and suitable for use in conjunction with self-seals. This not only assures proper release and eliminates ink pick, but also minimizes the potential for offset contamination. Offset contamination is represented by an accumulation of migrating slip or release modifiers from the printed surface to the surface of the self-seal, diminishing or inhibiting the subsequent cohesive response.

95.2 Application Techniques

In relaying techniques and procedures developed to facilitate cohesive applications via gravure, it is appropriate to define some of the inherent product limitations and physical characteristics that affect their use.

95.2.1 Handling

Cohesives are perishable. They have a suggested shelf life, and proper rotation of inventory is required.

Cohesives must be protected from freezing; ideally they are stored at 10 to 30°C in tightly closed containers.

Although as a general rule cohesives are not subject to settling, they do, in fact, stratify, as a result of their low viscosity and variable specific gravity, and must therefore be well stirred before use.

Cohesives are susceptible to contamination. Transfer of material should be made only to clean, water-rinsed containers.

Particulate matter and/or solvents, including alcohol, will reduce mechanical stability, and cohesive formulations should not be adulterated. Any such modifications can interfere with product performance.

It is advisable to discard used cohesive rather than returning it to a storage container; this eliminates the possibility of cross-contaminating fresh material.

Cleanup is best accomplished with cool water. Ammoniated water or alkali detergent may also be used. Completely dried material may be stripped or peeled from equipment. The use of solvent is not recommended.

Cohesives are preserved with ammonia, which is highly corrosive to copper and/or copper alloys. Additionally, the incorporation of copper ions into a cohesive will cause accelerated degradation. Therefore, any such contact must be avoided.

As copper is typically employed as the base for gravure cylinders, it is imperative that a hard, impervious chrome plating be utilized over 100% of the cylinder. Sometimes a nickel flash is employed immediately under the chrome for added protection.

Cohesives stabilized for machinability may be shear sensitive, and excessive shear must be avoided.

Cohesives should not be pumped by means of gear pumps routinely used for inks. A diaphragm pump can be utilized. However, a systaltic pump employing alkali-resistant flexible tubing is preferred.

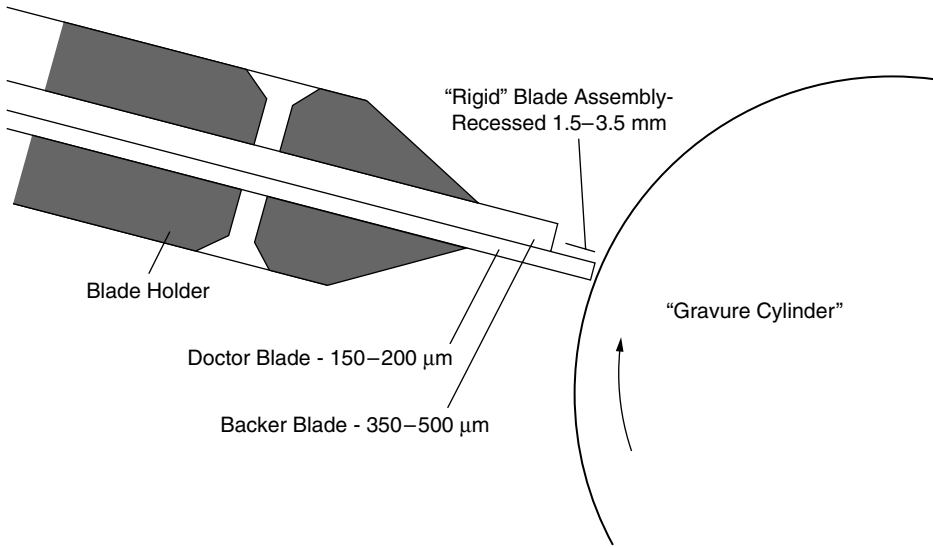

FIGURE 95.4 Schematic of a rigid blade assembly.

95.2.2 Procedures

Experience has shown that shear generated by blade doctoring can be minimized through maintaining as steep an angle as possible (i.e., 90° tangent to the cylinder). It is suggested that a well-dressed, rigid blade assembly be utilized; typically blue steel 150 to 200 μm doctor, 350 to 500 μm backer, recessed 1.5 to 3.5 mm (Figure 95.4).

To further reduce shear generated at the doctor blade in pattern applications, scavenger bars on overall etching of cylinder ends should be considered. Oscillating the blade through the widest parameters and at its fastest speed will also aid in the elimination of particles formed in the land areas. Also suggested is the under cutting of the impression roll to eliminate inadvertent backside coating, should shear-generated particles cause the ends of the blade to lift (Figure 95.5, Figure 95.6).

Ammonia, used as a volatile preservative, functions as the secondary stabilizer as well. During intermittent or low usage runs, aeration may cause a reduction in the ammonia level sufficient to create machining difficulties. In such situations, nondetergent 26° Be (29.4%) ammonium hydroxide should be added to a pH of 9.5 to 10.5.

Cohesives are quick drying, facilitating their utilization on high speed converting equipment. However, unlike solvent-borne inks, once dry they will not redisperse in themselves. Therefore, to minimize drying

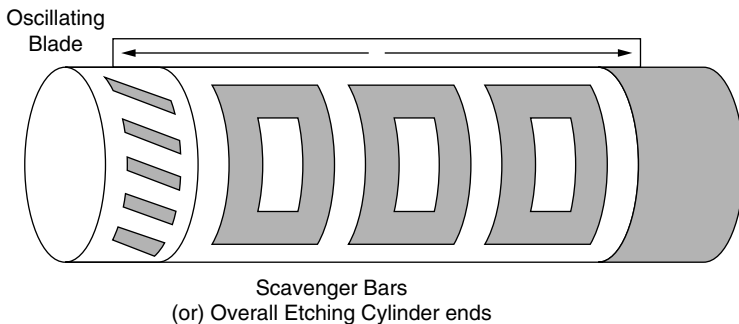

FIGURE 95.5 Schematic of a gravure cylinder with scavenger bars, 100% etching of a cylinder end, and oscillating doctor blade.

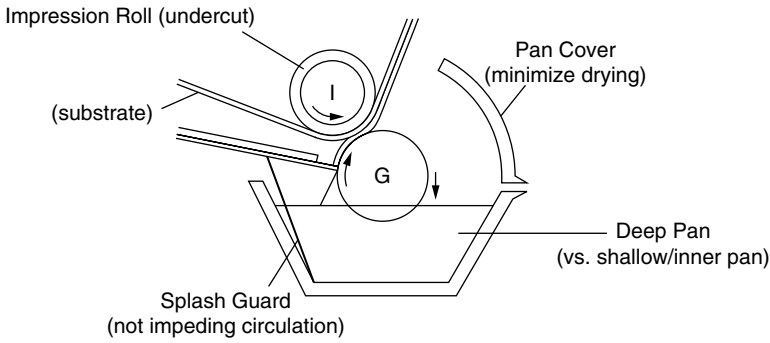

FIGURE 95.6 Schematic of a gravure station.

in the application station, it is suggested that all other “make-ready” be accomplished before cohesive is added to the pan. Once added, the gravure cylinder must be kept rotating, ideally flooding the cylinder when not actually coating. Before it is dropped or reseated, the blade should be wiped with a rag moistened with water, remove any dried material or other contaminants.

The pan ideally should be deep, thereby increasing volume, and covered if possible, with the flow not restricted by inappropriate positioning of the splash guard.

Additionally, thought should be given to minimizing hot drafts from the driers onto the application station.

Rewind tension should be carefully controlled to avoid blocking from too tight a roll. Cohesives exhibit antitelescoping frictions, and low rewind tensions are indeed functional in this respect. Cohesive-coated wrap typically produces noise through the rewind and slitting operations because of the inherent tendency to cling.

Converted rolls should be cradled or stored on end, rather than on their sides. This is to reduce intermittent blocking, which could be caused by the weight of the roll.

96.1	Introduction	96-1
96.2	The Solgel Process	96-1
96.3	Thin Film Applications	96-2
	Optical Coatings • Electronic Coatings • Abrasion Coatings • Protective Coatings • Porous Coatings • Composites	
96.4	Advantages	96-3
	Bibliography	96-4

Lisa C. Klein

*Rutgers–The State University of
New Jersey*

96.1 Introduction

Solgel processing is now well accepted as a technology for thin films and coatings. Indeed, the solgel process is an alternative to chemical vapor deposition, sputtering, and plasma spray. Not only have solgel thin films proved to be technically sound alternatives, they have been shown to be commercially viable, as well.

The technology of solgel thin films has been around for over 30 years. The process is quite simple. A solution containing the desired oxide precursor is prepared with a solvent and water. It is applied to a substrate by spinning, dipping, or draining. The process is able to apply a coating to the inside and outside of complex shapes simultaneously. The films are typically 1 μm , uniform over large areas and adherent. The equipment is inexpensive, especially in comparison to any deposition techniques that involve vacuum. Coatings can be applied to metals, plastics, and ceramics. Typically, the coatings are applied at room temperature, though most need to be calcined and densified with heating. Both amorphous and crystalline coatings can be obtained.

96.2 The Solgel Process

The solgel process is the name given to any one of a number of processes involving a solution or sol that undergoes a solgel transition. A solution is truly a single-phase liquid, while a sol is a stable suspension of colloidal particles. At the transition, the solution or sol becomes a rigid, porous mass by destabilization, precipitation, or supersaturation. The solgel transition to a rigid two-phase system is not reversible.

The first step is choosing the right reagents. To illustrate this, silica will be used as the model system. Of the available silicon alkoxides, tetraethylorthosilicate (TEOS) is used most often, because it reacts slowly with water, comes to equilibrium as a complex silanol, and in a one-quarter hydrolyzed state has a shelf life of about 6 months. The clear TEOS liquid is the product of the reaction of SiCl_4 with ethanol. The colorless liquid, $\text{Si}(\text{OC}_2\text{H}_5)_4$, has a density of about 0.9 g/cm^3 , is easy to handle safely, and is extremely pure when distilled. There are several commercial suppliers.

The other ingredients are alcohol and water. Ethanol serves as the mutual solvent for TEOS and water. As soon as TEOS is introduced into ethanol with water, the chemical reactions of hydrolyzation and polymerization begin. The chemical reactions are approximately as follows:

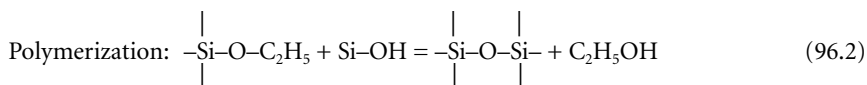
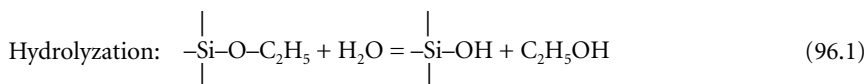

An acid is usually added to control the rates of these reactions. This mixing takes between 1 and 3 hours, while the solution viscosity increases. Complete hydrolysis of $\text{Si}(\text{OC}_2\text{H}_5)_4$ to $\text{Si}(\text{OH})_4$ would give silicic acid. This does not occur. Instead, a condensation occurs between silanols and ethoxy groups to give bridging oxygens or siloxane groups.

In the systems described above, the solgel transition is reached when the one-phase liquid becomes a two-phase alcogel, solid plus liquid. Alcogel is used to differentiate gels prepared with alkoxides from those prepared from ion-exchanged solutions or colloidal sols. Those gels are called hydrogels. Once through the solgel transition, the solvent phase is removed by ordinary evaporation to create xerogels or by hypercritical evacuation to create aerogels. At this point, the dried gel is a microporous oxide.

When it comes to coatings, the solution is said to go through its solgel transition while the coating is on the substrate. What is observed is that a liquid film undergoes a sharp increase in viscosity. If the substrate has been handled properly, a tacky gel covers the surface uniformly.

The majority of formulations are for oxides. For example, silica is used as an amorphous coating that may be applied for passivation of a surface or improving surface perfection. Titania is an example of an amorphous or crystalline coating that may be used for its high index of refraction or its electrical properties. Alumina is generally a crystalline coating that finds use in harsh environments. Of course, there are other specialized applications that call for multicomponent oxides. Increasingly, there are formulations for nonoxides, carbides, nitrides, and fluorides, along with organic-inorganic coatings.

96.3 Thin Film Applications

When considering where solgel coatings find use, several broad areas come to mind. These include optical coatings, electronic coatings, abrasion coatings, protective coatings, porous coatings, and composites.

96.3.1 Optical Coatings

One of the first applications was for rearview mirrors for cars from Schott Glaswerk. These coatings consist of titania-silica-titania interference filters that give the effect of total reflectance and replace conventional metallizing. Another early application was solar reflecting films for windows. These coatings consist of Pd-containing titania films that show selective absorption.

In addition, there are antireflective coatings of several types. Both borosilicates and titania silicates have been developed for this application. Antireflection in the ultraviolet (UV) range has been accomplished with thoria and hafnia films. Broadband antireflection has been developed for laser optics, using silica broadband antireflective coatings with reduced UV scattering.

96.3.2 Electronic Coatings

Thin films have been applied from solution for numerous electronic and magnetic applications. Indium tin oxide (ITO) has been developed for electrically conducting transparent films for displays. Optoelectronics and PZT have been prepared. Iron oxide layers have been used for magnetic films. Vanadia layers have been used for antistatic films. Barium titanate has been prepared in thin layers for multilayer capacitors. Tantalate has been used for capacitors as well. The advantage of the gel thin films is that the

thinner the layer, the higher the capacitance of the device, and the higher the density of devices possible on a chip.

Tungstate films and niobate films have been prepared for electrochromic displays. More recently, there has been work on devices, such as titania thin films for electrodes, antimony-doped tin oxide films for transparent heat mirrors, and reaction-formed silicon oxynitride films for oxidation masks in microelectronic device fabrication.

96.3.3 Abrasion Coatings

Alumina coatings have been developed because they provide higher hardness on the surface of many substrates, in particular, stainless steel. In porous and dense conditions, a simple application of alumina on the surface can provide scuff resistance. Ceramics in general have higher hardness than metals and plastics. This means that ceramic coatings have fewer tendencies to show scratches. There is utility in applying such coatings to windows, especially polycarbonate windows.

96.3.4 Protective Coatings

Early on, phosphate coatings were applied to silicate glass panels to improve their chemical resistance to attack by water. This improvement was accomplished in 0.2 μm . This points out one of the primary advantages of solgel processed films — the material use is efficient. Any excess material is recovered and can be used again. Even relatively costly components such as zirconia can be considered.

Generally, because the gel is amorphous, meaning no stoichiometric rules, any amount of metal oxides can be added to a composition. Being thin, solgel films do not delaminate when the substrate is bent. Finally, because the gel is porous, it is undetectable when a cover coat is applied and fired.

96.3.5 Porous Coatings

Of course, fully dense oxides can be obtained from gels with appropriate heat treatment. On the other hand, microporous films find unique applications modifying a physical property such as thermal conductivity or in performing physically as a membrane.

96.3.6 Composites

Microporous gel can be infiltrated with organic monomers and polymers to form organic–inorganic coatings or hybrid coatings. The low temperature of the solgel process enables the combination of organic and inorganic in ways not possible with conventional processes. The new field of organic–inorganic nanocomposites is in its early stages.

96.4 Advantages

The advantages of the solgel process in general are high purity, homogeneity, and low temperature. Because alkoxides can be multiply distilled, the products can be relatively free of impurities. Because the mixing is accomplished in solution, components mix on the atomic scale in relatively short times. If the plan is to use this process to make a dense material, the porous dried gel can be compacted at temperatures lower than conventional films.

In addition to an energy savings for this low temperature process, there is a reduction in volatilization. In fact, this process can make some compositions that cannot be made by conventional means because of phase separation or devitrification.

Another way to look at this process is that initially it creates an amorphous material that is porous. The porosity provides access to the nanostructure, allowing the design of a variety of nanocomposites.

Bibliography

- Bradley, D. C., R. C. Mehrotra, and D. P. Gaur, *Metal Alkoxides*. London: Academic Press, 1978.
- Brinker, C. J., and G. W. Scherer, *Sol-Gel Science*. New York: Academic Press, 1990.
- Klein, L. C., Ed., *Sol-Gel Optics: Processing and Applications*. Dordrecht: Kluwer, 1994.
- Klein, L. C., Ed., *Sol-Gel Technology for Thin Films, Fibers, Preforms, Electronics and Specialty Shapes*. Park Ridge, NJ: Noyes Publication, 1988.
- Schmidt, H., and M. Mennig, "Wet Coating Technologies for Glass." www.solgel.com/articles/Nov00/mennig.htm.
- Segal, D., *Chemical Synthesis of Advanced Ceramic Materials*. Cambridge: Cambridge University Press, 1989.
- Turova, N. Y., E. P. Turevskaya, V. G. Kessler, and M. I. Yanovskaya, *The Chemistry of Metal Alkoxides*. Dordrecht: Kluwer, 2002.
- Wright, J. D., and N. A. J. M. Sommerdijk, *Sol-Gel Materials: Chemistry and Applications*. London: Gordon & Breach, 2001.

97

Radiation-Cured Coatings

97.1	Introduction	97-1
97.2	Equipment	97-2
	Electron Beam • Ultraviolet Light	
97.3	Chemistry.....	97-3
	Photoinitiators • Formulation	
97.4	End Uses	97-8
	References	97-8

Joseph V. Koleske
Consultant

97.1 Introduction

Curing coatings by means of radiation represents one of the new techniques that is replacing the use of conventional or low solids, solvent-borne coatings. Radiation-cured coatings offer a manufacturer several important features. These include the following:

- High solids — usually 100% solids
- Low capital investment (with certain specific exceptions)
- Low energy curing costs — low power requirements and elimination of solvent costs
- Rapid cure speeds
- Ability to cure a variety of substrates, including heat-sensitive substrates such as plastics and parts for the electronics industry
- Increased productivity
- Shorter curing lines and decreased floor space requirements for operating line and for liquid coating storage
- A variety of different chemistries from which to select, and thus broad formulating latitude from the wide variety of formulation ingredients available

The main sources of actinic energy for curing coatings by radiation are electron beam and ultraviolet light.* It 1984, Pincus¹ indicated that there were four suppliers of electron beam (EB) equipment and more than 40 suppliers of ultraviolet light (UV) equipment. The ninth edition (1987) of the *Radiation Curing Buyer's Guide* lists the same number of EB suppliers and about 50 suppliers of UV equipment. In the United States, there were about 100 EB units and about 25,000 UV light units operational in 1983–1984.¹ These figures include laboratory, pilot, and production units. With the industry growing at about 10 to 15% per year,²⁻⁴ it is very reasonable to expect that these numbers had increased by the end

*It is realized that other radiation processes such as microwave, infrared, and gamma rays can be used to cure coatings. However, this chapter is only concerned with electron beam and ultraviolet light radiation, which are the most important commercial processes.

of the decade. Equipment for EB curing is significantly more expensive than that for UV curing, and it represents the exception listed above in the "low capital requirement" advantage of radiation curing. Even a laboratory-sized EB unit will run into six figures, whereas simple conveyorized UV systems can be obtained for a few thousand dollars. Furthermore, energy consumption is high with EB units and low in UV systems.

In 1980 about 80 million pounds of formulated radiation-curable product were sold in the United States. This number increased to 127 million pounds in 1985 and was expected to increase to 216 million pounds in 1990.⁴ About 88% of the 1985 total was cured by UV light and the remainder by EB. Thus, it is readily apparent that radiation curing is a specialty area, but it is one that is growing much faster than the overall coatings market. A study⁵ indicated that the market will be 336 million pounds by 1995, which represents a 9.2% compounded growth rate from the prediction for 1990.

There are two basic technologies involved in the radiation-cured coatings market. The older and more well-known technology involves free radical chemistry, and the cure of compounds containing unsaturation (i.e., acrylates, styrene/unsaturated polyester, and the like). The other technology involves cation chemistry and the cure of cycloaliphatic epoxides and compounds that will copolymerize with them under the influence of Brønsted or Lewis acids.

97.2 Equipment

97.2.1 Electron Beam

With EB curing, energy transfer is caused by energetic or accelerated electrons.⁶⁻⁹ Therefore, photoinitiators usually are not used in EB cure formulations and there are no photoinitiator fragments, which might have an odor or otherwise detract from properties in the cured coating. The electron source is a filament that is heated inside a vacuum tube. The electrons are accelerated to a high energy ($\sim 10^5$ V) by an impressed electrical field with the degree of acceleration increasing with increasing applied voltage. High voltages (150,000 to 300,000 V) are involved. The accelerated electrons pass through a metallic foil window and are sent on to the compound, which is capable of absorbing their energy and thus undergoing polymerization. The ability of the electrons to be absorbed by the compound (i.e., the radiation-curable formulation) depends on the material's density, and therefore depth of penetration is inversely proportional to density. The electron bombardment of the formulated coating abstracts hydrogen atoms from some of the molecules, thereby generating short-lived free radicals that can initiate the polymerization of acrylates and similar compounds that will interact and react with such species. Clear coatings of up to 20 mils (500 μm) and pigmented coatings of about 15 mils (400 μm) can be cured with EB equipment.

97.2.2 Ultraviolet Light

In general, UV light units operate with electromagnetic radiation that is in the optical region of 200 to 760 nm. They do produce infrared radiation of 760 nm to 1.0 mm, but this energy is thermal and acts either to anneal the cured coating and relieve internal stresses and strains or to enhance cure rate in cationic cure systems. Of course, in certain formulations, this thermal energy can have a deleterious effect by causing volatilization of reactants, and it is minimized in some equipment. In other cases, such as cationic UV curing, the thermal energy can be highly beneficial by kinetically enhancing the cure rate of the compounds.

Basically, in the case of UV curing, compounds susceptible to rapid polymerization are contacted with initiating species obtained by photolysis of a photoinitiator. In the UV cure* of such compounds, a photoinitiator that is capable of photolyzing or degrading to an active species is added to the formulation. When light of the proper wavelength strikes the photoinitiator, the active species is generated and

* Ultraviolet light photons are of relatively low energy ($\sim 10^3$ V) and are not capable of abstracting hydrogen atoms from molecules. Thus, a photoinitiator is needed when ultraviolet light curing technology is practiced.

polymerization rapidly takes place. Certain photoinitiators generate free radicals, and these are used to cure acrylates. Other photoinitiators generate cations, which are used to cure cycloaliphatic epoxide-based systems. It should be readily apparent that matching the output of the UV light source with the absorption spectra of the photoinitiator is an important aspect of this technology.

There are four different UV light curing technologies. These are as follows:

- Medium pressure mercury vapor lamps (in certain countries, low pressure and high pressure mercury vapor lamps are also used)
- Electrodeless vapor lamps
- Pulsed xenon lamps
- Lasers

Medium pressure mercury vapor (MPH) lamps have been used commercially for about 20 years. The bulb is an evacuated quartz tube that contains metallic mercury and has electrodes at each end. Electrical energy is supplied through the electrodes, and an arc is struck between them. This heats mercury in the tube to a plasma that emits UV, visible, and infrared radiation. Output ranges from about 100 to 400 in., and a warm-up time of 10 to 15 min is often recommended for the bulb to be fully operational. The systems can be doped to alter the emission spectrum, but usually only mercury is used.

Electrodeless lamps have been in use for about a decade and currently are very popular in the industry.^{10,11} The vacuum tube UV bulb is manufactured from quartz, which is invisible to the UV radiation. The bulb contains either mercury or other proprietary metals and gases. The system is activated by microwave or radiofrequency energy (i.e., it does not have electrodes). Because of the nature of this activation system, it essentially has instant on and off operation. A variety of doped bulbs are available with various output spectra that can be “matched” to that of different photoinitiators. Bulb lifetime is usually 5 to 10 times longer than that of standard MPH lamps.

Xenon lamps are quartz tubes filled with doped xenon. The lamp is powered by pulsed electrical current.^{10,12} These units offer very low heat output along with short time, extremely high peak intensity output. (Some types have as high as 8000 to 10,000 W output, although most operate at much lower intensities.) The output spectrum is continuous with this source rather than that of the discrete line types as from the MPH lamps. However, in certain instances, mercury is added to the tube contents to enhance curing in the region of mercury’s spectral lines. The output has also been modified with other metals such as iron and beryllium.

Argon ion and nitrogen lasers in combination with specific photoinitiators that have a strong absorbance at the emission line of the laser have been used to cure multifunctional acrylates.^{13,14} Although the studies are interesting and may hold promise for the future, at present, this is considered to be a research area of potential interest for the electronics industry.

97.3 Chemistry

Most of the following discussion deals with UV light technology. The reason for this is that photoinitiator breakdown is important to cure. In a general sense, the same compounds that will cure with the free radical photoinitiators will cure with EB.

97.3.1 Photoinitiators

97.3.1.1 Free Radical Type

Free radical generating photoinitiators are of two general functional types.^{15,16} The first type involves a mechanism known as *hemolytic fragmentation*, in which a compound such as a benzoin alkyl ether undergoes a photochemically induced fragmentation into highly active free radicals as described in [Figure 97.1](#).

The second type of free radical generation functions through a mechanism that is termed *electron transfer*. This mechanism involves a photolytic excitation of the photoinitiator from a ground state

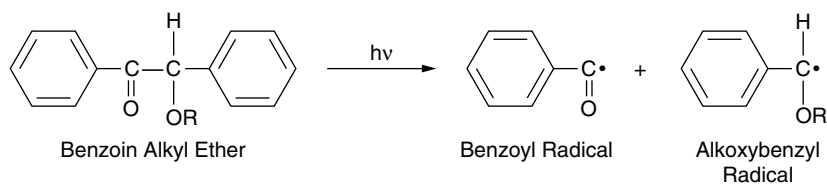

FIGURE 97.1 Homolytic fragmentation.

singlet to an excited triplet state. This is followed by electron transfer to a hydrogen atom donor, such as dimethylethanolamine (DMEA), and the formation of highly excited free radicals as described in Figure 97.2.

Typical commercial photoinitiators include compounds such as 2,2-diethoxyacetophenone, 2,2-dimethoxy-2-phenyl acetophenone, hydroxycyclohexylphenyl ketone, benzophenone-triethylamine, 2-methyl-1-4-(methylthio)-2-morpholino-propane-1, 1-phenyl-2,2-propane dione-2-(*o*-ethoxycarbonyl)oxime, and benzoin methyl, isopropyl, isobutyl, and other alkyl ethers.

Free radical generating photoinitiators of the foregoing types are inhibited or inactivated by oxygen as a result of a complex that forms between the light-activated photoinitiators and molecular oxygen. This effect can be overcome by inerting the coating with nitrogen during cure, by adding waxes to the system, or by using excess photoinitiator. Air that has been dispersed in the coating system during formulation contains oxygen, and it acts as a stabilizer. However, formulations containing very active photoinitiators of this type have a tendency to polymerize during storage if this oxygen is depleted over a period of time. Compounds that will help prevent such instability include phenothiazine and Mark 275 stabilizer.

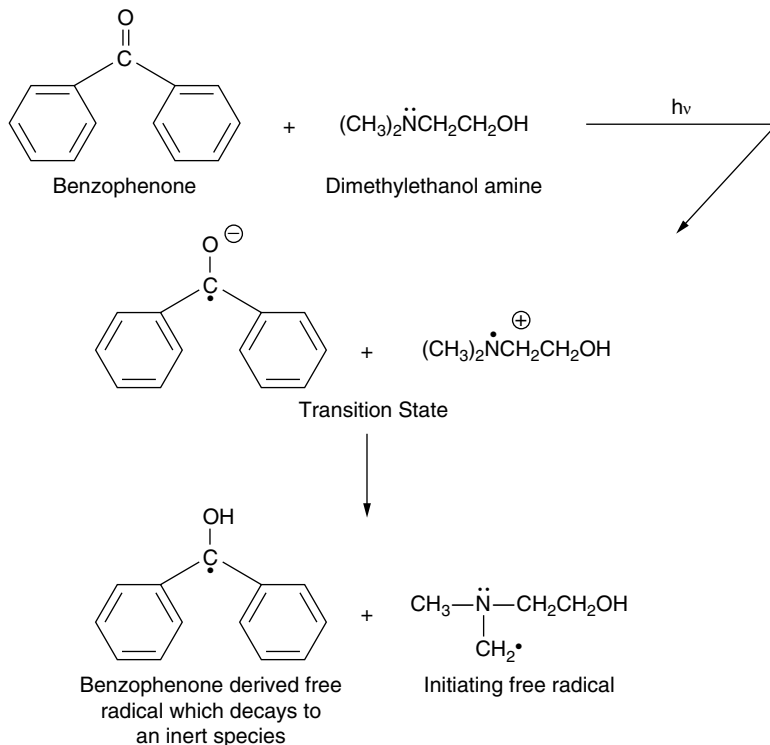

FIGURE 97.2 Electron transfers.

Tertiary amines will act as photosynergists,^{17,18} and they greatly enhance curing rate of compounds such as those described above. Ureas and amides also have been described as synergists for benzophenone.¹⁹ Compounds that have been used to accelerate cure rate of pigmented systems include isopropylthioxanthone, ethyl-4-dimethylaminobenzoate, and 2-chlorothio-xanthone.

97.3.1.2 Cationic Type

Although there are various types of photoinitiators that photolyze to yield a cationic species capable of polymerizing cycloaliphatic epoxides and active hydrogen compounds of the hydroxyl type or vinyl ethers, only the arylsulfonium salts are commercial at present. These types include aryldiazonium salts, aryliodonium salts, iron-arene complexes, aluminum complex-silanols, and the commercial arylsulfonium salts.^{20–24}

Aryldiazonium hexafluorophosphates and tetrafluoroborates decompose under the action of UV light and yield Lewis acids such as BF_3 and PF_3 , nitrogen, and other fragments.^{25–27} These photoinitiators were used in the infancy of cationic UV cure of cycloaliphatic epoxides. Although they were quite active for first-generation products, the disadvantages of thermal instability, which led to short shelf life, and of nitrogen evolution, which led to pinholes and bubbles in films thicker than about 0.2 mil, inhibited commercial use and led to their replacement by the onium salts in the marketplace.

The polymerization of epoxides with aluminum complex-silanol photoinitiators has been described.^{28,29} The technology is not being practiced in the United States, but it may be in use in Japan. The iron-arene complexes represent a new type of cationic photoinitiator that was recently described.^{30,31} When photolyzed, these compounds degrade to yield both Lewis acid-type catalysts and free radicals. Because these compounds are relatively new, detailed information about them is not available.

Various investigators studied the onium salts of iodine or the Group VI elements.^{32–37} Currently, the arylsulfonium salts are commercially used as photoinitiators. These compounds do not have the deficiencies of the diazonium salts because there is no nitrogen evolution on photolysis and, if protected from UV light, the systems can have ambient-condition shelf lives in excess of 2 years. When UV light interacts with the onium salts, an excited species is formed. This species undergoes homolytic bond cleavage to yield a radical cation, which extracts a hydrogen atom from a suitable donor and generates another free radical species. The new compound then gives up the proton for formation of a strong Brønsted acid. The Brønsted or protic acid that is the polymerization catalyst is of the form HMF_6 where M is a metal such as antimony, arsenic, or phosphorus. This catalyst is long-lived, and the cationic polymerization of the epoxide system can continue in the “dark” after initial exposure to UV light until the available epoxide is exhausted or the polymerization is terminated by some other mechanism. Thus, the onium salts generate both cationic species and free radicals and can be used in radiation-activated, dual-mechanism systems.

Note that the onium salt photoinitiator is a blocked or latent photochemical source of the strong Brønsted acid that acts as a catalyst/initiator for the formulated system. Because of the acidity of the UV-generated catalyst or initiator, it is necessary to keep the formulated system (substrate, coating equipment, etc.) free from basic compounds that would neutralize the acid and either negate or slow cure rate. Even very weak basic compounds will react or interact with the strong acidic species.

97.3.1.3 Dual-Mechanism Curing

Since the cationic photoinitiators generate both free radicals and Brønsted acids when exposed to UV light, it is possible to combine acrylates that will cure with free radicals and epoxides that cure with the protic acids. Free radical generating photoinitiators such as 2,2-diethoxyacetophenone can be added, if an additional source of free radicals is necessary. Experience has shown that this usually is not necessary. Of course, the benzophenoneamine systems described earlier should not be used. Little can be found in the literature^{38–40} about this interesting topic, but dual-mechanism curing should prove to be a useful technique in the future and merits further study.

Dual-mechanism systems that involve free radical chemistry coupled with thermal chemistry are also known. Dual-cure plastisols⁴¹ and dual-cure pigmented⁴² coatings have been reported. The combination

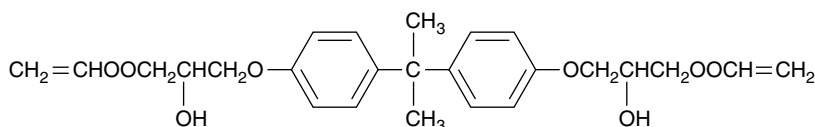

FIGURE 97.3 An “epoxy acrylate.”

of UV and infrared radiation for curing coatings, which can be beneficial for either of the dual-mechanism systems, has also been discussed.^{43–44}

97.3.2 Formulation

The subject of formulation involves both free-radical-curable ingredients and how they are used, and cationic-curable ingredients and how they are used. If one takes an extremely simplistic approach, only a single species that will cure under the influence of radiation is needed for a coating. However, most formulations contain a variety of ingredients to achieve the property balance that is needed to meet a given set of performance criteria.

Most formulations contain a base oligometric or multifunctional compound, a flexibilizer (which may be the base compound) a low viscosity, reactive diluent (which may be mono- or multifunctional), for viscosity control, a multifunctional acrylate for high cross-link density, a photoinitiator (unless electron beam cure is used), and usually a surfactant or flow and leveling agent. Combinations of more than one material of each type are usually used to optimize properties. The performance characteristics of specific end uses may also require use of a slip agent, nonreactive organic or inorganic fillers and/or pigments, adhesion promoters, flattening agents, an augmenting flow and leveling aid, or some other additive-type ingredient.

97.3.2.1 Free Radical Systems

In general, systems based on acrylates are used in free radical cure systems.^{45–48} The base material is usually an epoxy acrylate or a urethane acrylate. Epoxy acrylates are the reaction products of acrylic acid with various diglycidyl ethers of bisphenol A. The epoxy acrylates contain acrylate and hydroxyl functionality, but they do not contain epoxide functionality and should not be confused with the epoxides to be discussed in the cationic cure systems section. The term “epoxy acrylate” is a widely used and accepted misnomer; as can be seen by the structural formula in Figure 97.3, “acrylated epoxy” would be a better term to use for these compounds.

Urethane acrylates are often prepared by end capping a polyether, polyester, or caprolactone polyol with a diisocyanate and then reacting this isocyanate prepolymer with an hydroxyalkyl acrylate.^{49–51} The chemistry is more complex than this simple description, and the order of component addition is important to minimizing viscosity. Both epoxy acrylates and urethane acrylates have a high viscosity ($\geq 10^6$ cp) at ambient temperatures.⁵² To facilitate manufacture, handling, and later formulation, the compounds are often made in a low viscosity mono- or multifunctional acrylate, which will later serve as a reactive diluent and/or cross-linking agent in a formulated system.

In either the neat or the diluted form, these base compounds are diluted to application viscosity with more mono- or polyfunctional acrylate. Polyfunctional acrylates increase cross-link density and improve solvent resistance, increase hardness, and increase glass transition temperature. Care is always taken to avoid skin and eye contact and inhalation of the acrylates because of the potential for skin irritation, sensitization, and toxicological reaction. It is important to read the Material Safety Data Sheets supplied with these and all other compounds. The manufacturer’s precautions should be carefully read and heeded when working with these and other chemicals. The ACS Monograph *Chemical Carcinogens* (No. 182, published in 1984) is a useful general reference.

Acrylates are available from a variety of sources. In addition to the urethane acrylates and epoxy acrylates described above, polyfunctional acrylates such as trimethylol propane triacrylate, pentaerythritol triacrylate, 1,6-hexane diol diacrylate, tripropylene glycol diacrylate, and tetraethylene glycol diacrylate, are

available. There has been a trend to increase molecular weight by alkoxylation of compounds used to make multifunctional acrylates, to give them better handling and health characteristics. Monofunctional compounds useful as reactive diluents include *N*-vinyl-2-pyrrolidone, 2-ethylhexyl acrylate, dicyclopentadiene acrylate, hydroxyalkyl acrylates, hydroxylactone acrylates, and ethoxyethoxyethyl acrylate.

Specific formulations are highly varied, and performance requirements guide or dictate ingredient levels. Many formulations can be found in the cited literature or other literature available from material manufacturers.

97.3.2.2 Cationic or Epoxy Systems

The most important formulating ingredient in a cationic UV cure system is a cycloaliphatic epoxide of the 3,4-epoxy cyclohexylmethyl-3,4-epoxy cyclohexane carboxylate or bis(3,4-epoxy cyclohexylmethyl) adipate type.⁵³ Systems usually contain from 100% to about 30 to 49% cycloaliphatic epoxide. When this epoxide is used alone or at very high concentrations, strong, hard, and brittle coatings that are useful on rigid substrates result. These rigid coatings can be flexibilized and toughened in various ways. Although commercial, compounded flexibilizers/tougheners exist²⁰ for these systems, various polyols such as the propylene oxide⁵⁴ or caprolactone polyols⁵⁵ can be used. Polyester adipates can be used, but the relatively high acidity of these polyols can lead to shortened shelf life because the cycloaliphatic epoxides are well-known acid scavengers⁵⁶ and will readily react with any carboxylic or other acid groups in this system. This will either increase viscosity or cause gelation. Other flexibilizing agents include epoxidized soybean and linseed oil epoxides and epoxidized polybutadiene. Care should be exercised when incorporating these compounds in the formulation because they can cause significant softening, along with flexibilization, and little or no increase in toughness.

Relatively small amounts (~1 to 20%) of the diglycidyl ethers of bisphenol A can be added to systems. However, the light absorbing characteristics of these compounds lead to a decrease in cure rate and in depth of cure. In addition, the compounds cause rapid increases in viscosity. Novolac epoxides appear to cure well in cationic systems, but their high viscosity is rapidly reflected in formulation viscosity.

Low molecular weight epoxides available under trade names²⁰ can be used as reactive diluents. Although somewhat slower in reactivity than many other cycloaliphatic epoxides, limonene mono- and diepoxide can be used as reactive diluents. Vinyl ethers can act as reactive diluents and cure rate enhancers in cationic cure, cycloaliphatic epoxide based systems.^{57,58} These compounds have not been fully investigated, but the available evidence suggests that they have formulating potential.

Since nonbasic, active hydrogen compounds react under cationic conditions with the oxirane oxygen of cycloaliphatic epoxides to form an ether linkage between the compound and the ring and a secondary hydroxyl group on the epoxide ring,⁵⁴ low molecular weight alcohols, ethoxylated or propoxylated alcohols such as butoxyethanol, and similar compounds can be used as reactive diluents in cationic systems. However, since these compounds are monofunctional, they can act as chain stoppers — although they do generate the secondary, ring-attached hydroxyl group, which can further propagate polymerization or chain extension — and can be used only in limited amounts, about 1 to 10%, that are dependent on molecular weight. Low molecular weight glycols (diethylen glycol, 1,4-butanediol, etc.) can also be used. Such compounds may enhance cure rate by providing a source of active hydrogen; but, when used at permissible low levels, the glycols do not enhance toughness. In certain instances, inert solvents such as 1,1,1-trichloroethane are used to decrease viscosity and/or increase coverage from a given volume of coating. However, most end users prefer systems that only contain reactive components.

As mentioned above, the reaction mechanism of epoxides and hydroxyl groups^{53,54} is such that a new hydroxyl group is generated for every hydroxyl group that is present. Thus, the initial hydroxyl content of a formulation is conserved after the reaction is complete. Although low levels of hydroxyl groups will often enhance adhesion, too many of these groups can detract from performance characteristics and cause adhesion loss under wet, moist, or high humidity conditions.

Specific formulations are highly varied, and performance requirements guide or dictate ingredient levels. Many formulations can be found in the cited literature or other literature available from material manufacturers.

97.4 End Uses

Radiation-cured coatings, which are often taken to include inks, adhesives, and sealants, are used in a large number of ways for rigid and flexible metal, plastic, glass, paper, and wood substrates. Particular end-use arenas include the communication, construction, consumer products, electronics, graphic arts, medical/dental, packaging, and transportation markets. Specific end uses for radiation-cured compounds are numerous and include coatings for appliances, beer and beverage can bodies and ends, book covers, bottles and bottle caps, catalogs, closures, compact discs, cosmetic cartons, credit cards, decorative and functional foils and films, decorative mirrors, electronic components, flocked fabric, furniture, labels, magazines, magnetic tape, natural and simulated wood paneling, optical fibers, orthopedic casts and splints, photoresists, plastic cups and containers, printed circuit board assemblies (conformal coatings), record album jackets, solder masks, steel can ends for composite paper-metal cans, toys, transfer letters, and vinyl flooring.

References

1. A. H. Pincus, *Radiat. Curing*, 11(4), 16 (November, 1984).
2. Anon., "Revolution in radiation curing," *Chem. Week*, April 13, 20 (1983).
3. A. H. Pincus, "Radiation curing markets and marketing data," in *Proceedings of Radiation Curing VI*, Chicago, 1982.
4. J. Weisman, "Radiation curing in the United States — An overview," in *Proceedings of Conference on Radiation Curing Asia*, Tokyo, 1986, p. 11.
5. G. E. Ham, personal communication.
6. R. Kardashian and S. V. Nablo, *Adhes. Age*, December, 27 (1982).
7. S. V. Nablo, *Radiat. Curing*, 10(2), 23 (May 1983).
8. P. N. Cheremisinoff, O. G. Farah, and R. P. Ouellette, *Radio Frequency/Radiation and Plasma Processing*. Westport, CT: Technomic, p. 86.
9. W. Karmann, "Radiation curing equipment," Paper FC 83–269, *Proceedings of RADCURE'83 Conference* Lausanne, Switzerland, 1983.
10. E. Finnegan, *J. Radiat. Curing*, 9, 4 (July 1982).
11. J. C. Pelton, *Radiat. Curing*, 10(2), 10 (May 1983).
12. W. R. Schaeffer, "UV curing light sources — Equipment and applications," Paper FC85–768, presented at Finishing '85, Detroit, 1985.
13. C. Decker, *J. Polym. Sci. Polym. Chem. Ed.*, 21, 2451 (1983).
14. C. Decker, *J. Coat. Technol.*, 56, 29 (1984).
15. G. Oster and N. L. Yang, *Chem. Rev.*, 68(2), 125 (1968).
16. H. G. Heine, H. J. Rosenkranz, and H. Rudolph, *Angew. Chem.*, 11, 974 (1972).
17. M. R. Sander, C. L. Osborn, and D. J. Trecker, *J. Polym. Sci.*, 10, 3173 (1972).
18. C. L. Osborn and D. J. Trecker, U.S. Patent 3,759,807.
19. A. F. Jacobine and C. J. V. J. *Radiat. Curing*, 1026 (July 1983).
20. Union Carbide Corp., Products for Ultraviolet Light-Cured Cycloaliphatic Epoxide Coatings, Publication F-60354, 1986.
21. 3M/Industrial Chemical Products Division, UV Activated Epoxy Curative FX-512, 1986.
22. General Electric Company, UVE-1014 Epoxy Curing Agent, Publication 1MF-212, 1981.
23. Asahi Denka KK, Opt Photoinitiators for Cationic Cure, 1986.
24. Degussa AG, "Degacure KI 85, 1986.
25. J. J. Licari and P. C. Crepeau, U.S. Patent 3,205,157 (1965).
26. S. I. Schlesinger, U.S. Patent 3,708,296 (1973).
27. S. I. Schlesinger, *Photogr. Sci. Eng.* 18, 387 (1975).
28. S. Hayase, T. Ito, S. Suzuki, and M. Wada, *J. Polym. Sci. Polym. Chem. Ed.*, 20, 1433 (1982).
29. S. Hayase and Y. Onishi, U.S. Patent 4,476,290 (1984).

30. K. Meier, "Photopolymerization of epoxides — A new class of photoinitiators based on cationic iron-area complexes," Paper FC85-417, in *Proceedings of RADCURE Europe '85*, Basel, Switzerland, 1985.
31. K. Meier and H. Zweifel, *J. Radiat. Curing*, 13(4), 26 (October 1986).
32. J. V. Crivello and J. H. W. Lam, *Macromolecules*, 10, 1307 (1977).
33. J. V. Crivello, U. S. Patent 4,058,401 (1977); 4,138,255 (1979); 4,161,478 (1979).
34. G. H. Smith, U.S. Patent 4,173,476 (1979).
35. R. F. Zopf, *Radiat. Curing*, 9(4), 10 (1982).
36. R. S. Davidson and J. W. Goodwin, *Eur. Polym. J.*, 18, 589 (1982).
37. J. V. Crivello and J. L. Lee, *Polym. Photochem.*, 2, 219 (1982).
38. W. C. Perkins, *J. Radiat. Curing*, 8(1), 16 (1982).
39. F. A. Nagy, European Patent Application EP 82,603 (1983).
40. H. Baumann et al., East German Patent Application DD 158,281z (1983).
41. C. R. Morgan, "Dual UV/thermally curable plastisols." Paper FC83-249, in *Proceedings of RAD-CURE '83 Conference*, Lausanne, Switzerland, 1983.
42. A. Noomen, *J. Radiat. Curing*, 9(4), 16 (1982).
43. E. M. Barisonek, "Radiation curing hybrid systems," Paper FC83-254, in *Proceedings of RADCURE '83 Conference*, Lausanne, Switzerland, 1983.
44. J. L. Lambert, "Heating in the IR spectrum," Industrial Process Seminar, September 1975.
45. S. Saraiya and K. Hashimoto, *Mod. Paint Coatings*, 70(12), 37 (1980).
46. E. Levine, *Mod. Paint Coat.*, 73, 26 (1983).
47. C. B. Thanawalla and J. G. Victor, *J. Radiat. Curing*, 12, 2 (October 1985).
48. K. O'Hara, *Polym. Paint Colour J.*, 175 (4141), 254 (1985).
49. L. E. Hodakowski and C. H. Carder, U.S. Patent 4,131,602 (1978).
50. M. S. Salim, *Polym. Paint Colour J.*, 177(4203), 762 (1987).
51. B. Martin, *Radiat. Curing*, 13, 4 (August 1986).
52. G. Kùhe, *Polym. Paint Colour J.*, 173, 526 (August 10/24, 1983).
53. J. V. Koleske, O. K. Spurr, and N. J. McCarthy, "UV-cured cycloaliphatic epoxide coatings," in *14th National SAMPE Technical Conference*, Atlanta, 1982, p. 249.
54. J. V. Koleske, "Mechanical properties of cationic ultraviolet light-cured cycloaliphatic epoxide systems," in *Proceedings of RADCURE Europe '87*, Munich, West Germany, 1987.
55. J. V. Koleske, "Copolymerization and properties of cationic, UV-cured cycloaliphatic epoxide systems," in *Proceedings of RADTECH '88*, New Orleans, 1988.
56. Union Carbide Corp., "Cycloaliphatic Epoxide ERL-4221 Acid Scavenger-Stabilizer," publication F-5005, March 1984.
57. J. V. Crivello, J. L. Lee, and D. A. Conlon, "New monomers for cationic UV-curing," in *Proceedings of Radiation Curing VI*, Chicago, 1982.
58. GAF Corp., Triethylene Glycol Divinylether, 1987.

Nonwoven Fabric Binders

Albert G. Hoyle
Hoyle Associates

98.1 Introduction	98-1
98.2 Binders	98-1
Latex • Fiber • Powder • Netting • Film • Hot Melt • Solution	
Bibliography	98-4

98.1 Introduction

A nonwoven fabric is precisely what the name implies, a fibrous structure or fabric that is made without weaving. In a woven or knit fabric, warp and/or filling yarns are made and intertwined in various patterns (weaving or knitting) to interlock them and to give the manufactured fabrics integrity, strength, and aesthetic value. By contrast, in manufacturing a nonwoven fabric, the yarn formation and yarn intertwining steps (weaving or knitting) are bypassed, and a web (fibrous structure) is formed using dry-lay or wet-lay formation techniques. This web is bonded together by mechanical entanglement or by the addition of a binder to create a nonwoven fabric.

This chapter describes the various binders available for nonwoven bonding with their applications, and provides a listing of resource contacts for latex, binder solutions, fiber, powder, netting, film, and hot melt binder suppliers.

98.2 Binders

The degree of bonding achieved, using any of several binders, is enhanced when the carrier fiber and binder are of the same polymeric family. Increasing the amount of binder in relation to the carrier fiber increases product tensile strength and also overall bonding. Binders used in nonwovens are of the following types: latex, fiber, powder, netting, film, hot-melt, and solution.

At present, the binders most frequently used are latex, fiber, and powder, with fiber having the greatest growth potential for the future.

98.2.1 Latex

Latex binders are based mainly on acrylic, styrene-butadiene, vinyl acetate, ethylene-vinyl acetate, or vinyl/vinylidene chloride polymers and copolymers. Within any one series or group, very soft to very firm hands can be achieved by varying the glass transition temperature of the polymer. The lower the T_g , the softer the resultant nonwoven. These temperatures range from -42° to $+100^\circ\text{C}$ in latex available today. Most latex are either anionic or nonionic. Some have high salt tolerances, allowing for addition of salts to achieve flame retardancy. Some are self-cross-linkable, and others are cross-linkable by the addition of melamine- or urea- formaldehyde resins and catalysts to achieve greater wash resistance and

high wet strength in cellulose-based nonwovens. Other latex, by means of special surfactants, can impart either hydrophobic or hydrophilic properties to the nonwoven. Still others, by means of certain surfactants, can be foamed easily to allow for foam application of the latex, resulting in greater economies in processing because of much lower energy demands for drying. Addition of thickeners to increase viscosity of the latex formulation makes for a much neater and cleaner application when print bonding is used. Addition of special heat-sensitive coagulants to the latex makes it possible to apply the latex to the fibrous web in a foamed state, and to gel or coagulate the foam in situ before it collapses while drying, resulting in permanently foamed, open cell nonwoven structure that is very water-absorptive and water-retentive. By and large, the acrylic-based latex are the most versatile ones in use, and they are also the most expensive to use.

98.2.2 Fiber

The main fiber binder types are morphologically classified as follows: amorphous homopolymer, amorphous copolymer, crystalline copolymer, and bicomponent fiber.

Classifying these by chemical origin, the ones most used today are polyester, polypropylene, polyethylene, polyamide, and vinyl chloride, vinyl acetate copolymer.

While latex binders are applied and processed by saturation, spray, foam, and print techniques, fiber binders are activated by thermal bonding methods. Thermal bonding, when first introduced, was used mainly in durable nonwovens and not used at all in disposables such as diaper top sheets and sanitary product covers — both exceedingly high volume items — for two reasons: (a) the higher prices of binder fibers when compared to latex, and (b) the properties needed in disposable nonwovens — softness, strength, porosity, capability of transferring liquids to an inner absorptive medium, and no adverse reactions upon skin contact. As energy cost increased in the late 1960s and early 1970s, thermal bonding became a viable option for disposable as well as durable nonwovens.

98.2.2.1 Amorphous Homopolymer

The predominant amorphous homopolymer binder fibers were and still are polyester and polypropylene. The polyester binder fiber is blended with a polyester carrier fiber into a web by carding or air-lay methods and hot calendered to achieve a 100% bonded product. This gives a thin strong, low extensibility, papery product, which is being used successfully as a coating substrate and in electrical insulation. The 100% machine direction orientation from carding and relatively high binder content result in relatively low extensibility and high tensile strength, properties that are important, specifically, in coating substrates for tapes and for electrical insulation. Amorphous homopolymer polyester binder fiber is used exclusively in area bonding for industrial products.

Polypropylene carrier fiber can be self-bonded by making a blend of coarse and fine denier fibers and using the fine denier fiber as the binder for the coarse one. This procedure is practical because polypropylene has a sharp bonding temperature and an almost simultaneous melting point, in the vicinity of 165°C, when the blend is hot calendered, the fine denier fiber is melted while the coarse one is relatively untouched. A practical blend is one containing fibers of 6, 3, and 1.8 deniers per filament (d/f), and running the calender at 163 to 165°C. A highly compacted, fairly stiff nonwoven results, which is used in water filtration. A polypropylene fiber with a slightly lower melting point than regular polypropylene has been developed for use as a binder fiber. This fiber is capable of being used a binder for regular polypropylene fibers of any denier and, with the sharp melting range characteristic of polypropylene, is usable in point bonding of disposables containing fibers other than polyester, as well as in area-bonded products.

98.2.2.2 Amorphous Copolymer

With the advent of point bonding by hot calendaring and the development of amorphous copolymers, mainly polyesters, work was reinitiated in adapting thermal bonding to disposable product needs. Overall area bonding is not acceptable in most disposables because open areas are needed for porosity and for the passing of liquids.

The development of amorphous copolymers with activation temperatures lower than amorphous homopolymers was an important development, allowing the making of a soft, absorbent, thin cover stock on a heated spot bonding calender at speeds high enough to make the process and product competitive.

Amorphous copolymer fibers are available with working temperatures in the calender from 227°C down to 163°C, allowing a full range of light- to medium-weight products, either 100% area bonded or else point bonded to be made at efficient processing speeds.

98.2.2.3 Crystalline Copolymer

Crystalline copolymer binder fibers are available in both polyamide and polyester types. These fibers are characterized by very sharp melting points, where the fiber is converted almost instantly to liquid when heat is applied. Microscopic studies show that the binder fiber, once molten, tends to congregate in droplets at carrier fiber interstices throughout the nonwoven.

Thermal bonding with this type of fiber can be effected in two ways: spot bonding with a heated spot bonding calender, and bonding with a through air oven with or without a consequent cold calendaring step, using an overall bonding calender. Through air oven heating is the preferred method of bonding because greater control and consistency can be achieved by using it.

A crystalline copolymer binder fiber can be used to produce a spot-bonded product with open unbonded areas, a spot-bonded product with open bonded areas, an overall bonded bulky product, and an overall bonded compacted but not papery product.

98.2.2.4 Bicomponent Fiber

A bicomponent is a fiber formed by coextrusion of two different polymers. It is available commercially in polyamide, polyester, and polyolefin (polypropylene–polyethylene) combinations. The polyamides and polyesters are of the core sheath type, with the matrix fiber as the core and the binder fiber as the sheath. In the polyamide bicomponent, the core fiber is nylon 66 and the sheath fiber is nylon 6.

In the polyester bicomponent, both the carrier and the binder fibers generically are polyesters; the main difference is a lower melting or softening point in the binder fiber portion. The polyolefin bicomponent is of the side-to-side type. Polypropylene, the carrier fiber, is one side, and polyethylene, the binder fiber, is the other side. In all three instances — polyamide, polyester, and polyolefin — the melting or processing temperature of the binder fiber is sufficiently lower than that of the carrier fiber that the carrier fiber is not affected by the heat used in the bonding step.

Nonwovens containing bicomponent fibers are processed similarly to those containing crystalline copolymers, and the resulting nonwovens have properties similar to those made using crystalline copolymers. Overall economics tend to favor use of crystalline copolymers, but achieving the best quality product favors use of bicomponent fibers.

98.2.3 Powder

Because of refinements in powder application techniques and an increase in polymers available in powder form, use of powder as a thermal binder is now a viable process. Polyester, polyamide, polypropylene, and polyethylene are available in a variety of mesh sizes. The preferred method of bonding is radiant heat followed by cold calendaring.

Products made with powder binders contain 10 to 20% binder. They have a soft hand and are porous. Possible markets are diaper top sheets, sanitary napkins, mattress pads, wipes, and medical-surgical products. Powder binders give characteristics and properties similar to crystalline copolymer fibers. Advantages of using powder over crystalline copolymer fibers are economies of powder versus fiber and versatility of binder selection. Disadvantages are less efficient application methods of powder versus fiber and permanence of location of powder once applied.

98.2.4 Netting

The netting type of binder is applied to a lightly prebonded web using a hot calender. The effect achieved is similar to that of spot or pattern bonding and is one-sided. Low or high amounts of binder

can be deposited at the patterned bond points, depending on the netting pattern. The main advantage of this process is that it can be off machine; it is relatively simple and requires no large outlay for processing equipment.

98.2.5 Film

The film is combined with a web containing, a carrier fiber and an amorphous binder fiber in a hot calendaring operation. The end-product nonwoven is quite tough, very strong, very smooth on one side, and usually impermeable to vapor or liquid.

98.2.6 Hot Melt

Hot-melt thermal bonding is accomplished by applying a hot melt to a lightly prebonded web. The hot melt can be applied to the web directly from a patterned hot melt applicator roll or else cast on release paper and applied in a separate step in transfer printing or bonding equipment. Characteristics and properties of a nonwoven made in this manner resemble those of one made using a crystalline copolymer binder fiber or plastic netting as the binder.

Advantages of using this binder are the capability of applying special binder formulations in unique binding patterns.

98.2.7 Solution

Solution binders and coating adhesives are available in both aqueous and organic solvent mediums. In nonwoven bonding the only solutions used are aqueous based, and these are selected only for very specific applications.

Polyvinyl alcohol and some acrylics are used as prebinders or temporary binders for cellulose-based or fiberglass-based nonwovens when final bonding cannot or should not be preformed at that particular stage of processing or when regular binders are needed but only in very small amounts. Water resistance can be imparted by adding a cross-linking agent such as melamine- or urea-formaldehyde resin to the polyvinyl alcohol formulation or using a cross-linking acrylic followed by curing after the product is dried.

Bibliography

Hoyle, A. G., "Properties and characteristics of thermally bonded nonwovens," in *TAPPI Nonwoven Division Workshop on Synthetic Fibers for Wet Systems and Thermal Bonding Applications*, Technical Association of the Pulp and Paper Industry, 1986, pp. 51–54.

Nonwovens Industry. Rodman Publications Inc., 26 Lake Street, P. O. Box 555, Ramsey, NJ 07446; phone (201) 825–2552.

Nonwovens World. 2700 Cumberland Parkway N.W., Suite 530, Atlanta, GA 30339; phone (404) 432–3186.

Textile World. McGraw-Hill Publications Company, 1221 Avenue of the Americas, New York, NY 10020; phone (212) 391–4570.

99

Fire-Retardant/Fire-Resistive Coatings

99.1	Conventional Paints	99-1
99.2	Fire-Retardant Paints	99-1
99.3	Fire-Retardation Mechanism	99-2
99.4	Fire-Resistive Intumescent Coatings	99-3
99.5	Miscellaneous Coatings	99-4
	References	99-5

Joseph Green
FMC Corporation

Paint-type coatings can be divided into three general classes: conventional paints, varnishes, and enamels; fire-retardant coatings formulated with halogen compounds with or without special fillers; and intumescent coatings designed to foam upon application of heat or flame for development of an adherent fire-resistive cellular char.

99.1 Conventional Paints

Non-flame-retardant coatings usually give a low flame spread rating over asbestos-cement board, steel, or cement block. When the coatings are tested over wood and other flammable materials, flame spread ratings similar to those of the substrate are obtained.¹

The fire-retardant effectiveness of paints is highly dependent on the spreading rate or thickness of the coating as well as the composition. When conventional paints are applied at the heavy rate common for fire-retardant coatings, they give flame spread indices comparable to those of fire-retardant paints. For example, coating of latex and flat alkyd paints applied to tempered hardboard at an effective spreading rate of 250 ft²/gal reduced the flame spread index of the uncoated substrate by factors of 3 and 5, respectively.²

99.2 Fire-Retardant Paints

Fire-retardant coatings are particularly useful in marine applications. Ships are painted repeatedly to maintain maximum corrosion protection. As the layers of paint build, they pose a fire hazard even though the substrate is steel. In the event of fire, the paint may catch fire, melt, drip, and cause severe injury and damage to the vessel. Coatings are therefore formulated that do not sustain combustion; they should not spread the flame by rapid combustion nor contribute a significant amount of fuel to the fire.

Polyvinyl chloride containing 57% by weight chlorine is self-extinguishing. However, it is not a good vehicle for a flame-retardant coating because of its high melting point. This can be lowered substantially by copolymerization with other vinyl monomers such as vinyl acetate. To make these copolymers useful, addition of plasticizers and coalescing solvents is often necessary to give suitable application and per-

TABLE 99.1 Formulation for a Fire-Retardant Latex Paint

Ingredient	Parts by Weight
Polyvinyl acetate copolymer emulsion (55% solids)	20
Chlorinated paraffin	5
Antimony oxide	11
Titanium dioxide	22
Mica	9
Thickeners, etc.	3
Water	30

TABLE 99.2 Formulation for an Alkyd-Based Paint

Ingredient	Parts by Weight
Long oil alkyd	22
Chlorinated paraffin	7
Antimony oxide	6
Titanium dioxide	29
Micronized talc	7
Whiting	11
White spirit drier, etc.	18

formance properties. These additions dilute the overall concentration of chlorine thereby reducing the flame retardancy.³

Fire-retardant coatings are based primarily on chlorinated alkyds, alumina trihydrate, or a combination of chlorinated paraffins and antimony trioxide. Table 99.1 and Table 99.2 give typical formulations. Flame spread test results depend both on the substrate and the thickness of the film.⁴

99.3 Fire-Retardation Mechanism

The combustion of gaseous fuel is believed to proceed by a free radical mechanism:

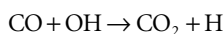
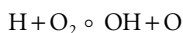
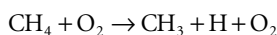

The H, OH, and O radicals are chain carriers and take part in a number of reactions in the flame zone.

The function of halogen containing compounds as flame retardants has been explained by the radical trap theory and takes place in the gas phase. In the foregoing reactions, liberated HCl or HBr competes for the radical species that are critical for flame propagation:

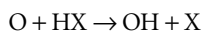
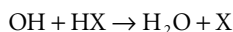
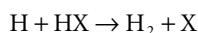
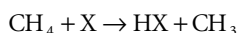

The active chain carriers are replaced with the much less active halogen radical, slowing the rate of energy production and helping flame extinguishments.

Antimony oxide is known as a flame-retardant synergist when used in combination with halogen compounds. Volatile antimony oxyhalide (SbOX) and/or antimony trihalide (SbX_3) form in the condensed phase and transport the halogen into the gas phase.

Phosphorus compounds are also used as primary flame retardants. The flame-retardant mechanism for phosphorus compounds varies with the type of compound, the polymer, and the combustion conditions.⁵ For example, some phosphorus compounds decompose to phosphoric acids and polyphosphates. A viscous surface glass forms and shields the substrate from the flame. If the phosphoric acid reacts with the polymer (e.g., to form a phosphate ester), subsequent decomposition results in a dense surface char. The coatings that form serve as a physical barrier to heat transfer from the flame to the substrate and to diffusion of gases; in other words, the substrate is isolated from heat, flame, and oxygen. This is the mechanism for fire-resistive intumescent coatings discussed below.

Triaryl phosphate esters are thermally stable, high boiling ($>350^\circ\text{C}$) materials. They can volatilize without significant decomposition into the flame zone, where they decompose. Flame inhibition reactions, similar to the halogen radical trap theory, have been proposed.⁶

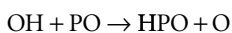
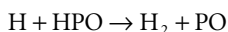
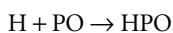

Alumina trihydrate (ATH) or magnesium hydroxide inhibits ignition by absorption of heat due to decomposition, releasing large volumes of water of hydration ($>30\%$).

99.4 Fire-Resistive Intumescent Coatings

Intumescent paints and mastics swell and char when exposed to heat and flame, giving a carbonaceous foam that insulates the substrate from heat, air, and fire. This may delay the onset of combustion of a wood or plastic substrate or delay the heat buildup and tensile loss of structural steel. In the latter case, thick coatings or mastics are used. These coatings are considered to be fire resistive and significantly more effective than fire-retardant coatings. The former offer protection to the substrate. Intumescent coatings require three basic ingredients: a carbonific or carbon producer such as pentaerythritol or other polyol, an acid releasing agent such as a phosphate, and a spumific or gas producer such as melamine. Polyols such as starch and dipentaerythritol (less water sensitive) are carbonifics. Other acid producers and their temperatures of decomposition are ammonium polyphosphate (215°C), monoammonium phosphate (417°C), and melamine phosphate (300°C); spumifics include urea (130°C), dicyandiamide (210°C), and melamine (300°C).⁷

When the coating or mastic is heated, the decomposing phosphate forms phosphoric acid. This esterifies the hydroxyl groups of the polyol, which subsequently decomposes, forming water and a carbonaceous char, regenerating the phosphoric acid. As the char forms, the paint binder softens and the spumific decomposes, liberating nonflammable gases. These gases expand the softened binder into a foam. A rigid carbonaceous foam is formed as charring of both carbonific and binder resin is completed.

Table 99.3 and Table 99.4 give examples of intumescent systems.⁴

When used as a thick mastic coating on structural steel, such materials can prevent the steel from reaching the failure point for 3 hours, as indicated in Table 99.5.

A unique intumescent coating containing no water-sensitive polyols is composed of *p,p'*-oxybis(benzenesulfonamide) in a vinyl chloride–vinylidene chloride copolymer binder. The addition of melamine pyrophosphate improves the homogeneity of the system.⁹ Dipentaerythriol can also be added to improve the homogeneity.¹⁰

TABLE 99.3 Formulation for a Typical Intumescent Emulsion Paint

Ingredient	Parts by Weight
Polyvinyl acetate latex	18
Ammonium polyphosphate	22
Pentaerythritol	12
Starch	3
Dicyandiamide	16
Titanium dioxide	4
Water	25

TABLE 99.4 Formulation for a Typical Intumescent Solvent-Thinner Paint

Ingredient	Parts by Weight
Vinyl toluene-butadiene copolymer	7
Ammonium polyphosphate	28
Dipentaerythritol	8
Melamine	9
Chlorinated paraffin	9
Titanium dioxide	6
Mineral spirits	33

TABLE 99.5 Ratings on Steel Column

Coating Thickness (in)	Rating (h)
0.31	1
0.39	1.5
0.58	2
0.78	2.5
0.97	3

Source: From Seiner, J. A., and T. A. Ward, *Poly. Paint Colour J.*, 178(4207), 75–78 (February 10, 1988).

Pitt-Char (PPG Industries) coating is a two-component epoxy-polyamide produce designed for structural steel. This intumescent epoxy coating requires no reinforcement and provides up to 3 hours of fire protection.¹¹

99.5 Miscellaneous Coatings

Magnesium oxychloride mastics will protect steel by releasing large quantities of water upon heating and by relatively high temperature calcining (500°C). This material can be painted or sprayed and can be used in exterior applications.¹²

Polystyrene foam block can be protected against fire for specified time periods. Building plastics containing gypsum and perlite and an expanded vermiculite, Portland cement, and limestone coating are particularly effective in protecting polystyrene foam block against the heat of a simulated mine fire.¹³

For an insight into potential methods of flame retarding polyurethane and epoxy coatings, an analogy with plastic flame retardants can be made. The most common way to achieve flame-retardant polyurethanes is by the addition of halogen, phosphorus, chlorophosphate, or chlorophosphonate compounds. Reactive halogen and phosphorus diols have also been used. Epoxy resins are generally flame retarded using the reactive tetrabromobisphenol A. Use of phosphorus-halogen compounds has been reported.

References

1. C. A. Hafer, Final Report, Project No. 3-294-26, Southwest Research Institute, San Antonio, TX, 1970.
2. D. Gross and J. J. Loftus, *Fire Res. Abstr. Rev.*, 3(3), 151–158 (1961).
3. W. S. Chang, R. L. Scriven, and R. B. Ross, in *Flame Retardant Polymeric Materials*, Vol. 1. M. Lewin, S. M. Atlas, and E. M. Pearce, Eds. New York: Plenum Press, 1975, pp. 399–447.
4. A. G. Walker, *Proceedings of the Fire Retardant Chemical Association Meeting*, Pinehurst, NC, October 27–30, 1985, pp. 51–61.
5. J. Green, *Plast. Compd.*, 10(3), 47 (May/June 1987).
6. J. W. Hastie, *J. Res. U.S. Natl. Bur. Stand.*, 77A(6), 733 (1973).
7. J. A. Shelton and M. G. Bivok, *Mater. Design*, 5, 41–42 (February/March 1984).
8. J. A. Seiner and T. A. Ward, *Poly. Paint Colour J.*, 178(4207), 75–78 (February 10, 1988).
9. S. H. Roth, J. Green, and J. J. Seipel, U.S. Patent 3,714,081 (January 30, 1973).
10. S. H. Roth, J. Green, and J. J. Seipel, U.S. Patent 3,714,082 (January 30, 1973).
11. *Modern Paint Coatings*, pp. 188–190, October 1984.
12. S. I. Kawaller, *Oil Gas J.*, 71(4), 78–80 (1973).
13. S. J. Luzik, *Fire Technol.*, 22, 311–328 (1986).

100

Leather Coatings

100.1	Introduction	100-1
100.2	Characteristics of Leather Coatings.....	100-2
	Main Coating • Unpigmented Ground Coatings • Aqueous Pigmented Coatings	
100.3	Technology of Decoration of Skins of Large Hoofed Animals with Artificial Grain	100-6
100.4	Some Nonstandard Coating Applications.....	100-7

Valentinas Rajeckas
Kaunas Polytechnic University

100.1 Introduction

Tanned leather is usually coated with a thin pigmented or lacquer coating. One of the purposes of such a coating is decorative. The coating may also change some physical properties of leather: it may decrease water and air permeability, increase its rigidity, etc. Such changes depend on the coating type, especially on the polymer used as a film former. The properties also depend on coating formation technology: the coating may penetrate deeply into leather, or it may remain only on the surface. The coating technology chosen depends on the leather structure and the degree of its surface damage.

Tanned leather is the midlayer of an animal's hide — the derma, which is processed chemically and mechanically. During processing, leather becomes resistant to bacterial and fungal attack; its thermal resistance and its resistance to water increase. The derma consists basically of collagen protein having a fibrous structure. Collagen in the derma is in the form of a fibrous mat, and the fibers extend at varying angles with respect to the leather surface. The fiber diameter is 100 to 300 μm . Other proteins (albumin, globulin) and mucosaccharides are located between fibers and bond the proteinaceous materials into multifiber ropy structures. Such a multicomponent leather structure determines its capability to deform — its elasticity and plasticity.

Leather is used for many applications: footwear, gloves, clothing, purses, furniture upholstery, saddles, and a variety of other uses. Leather is processed differently for each application: different chemicals are used; their quantity and processing conditions may also be different. Thus, leathers of different physical–mechanical properties are obtained: very soft, thin, and extensible for gloves and clothing, more rigid for footwear, and hard and stiff for soles. Often leather is dyed during processing. Dyeing may take place by the immersion of leather into a dye solution bath (usually in a rotating drum), or by covering the dry leather surface with a colored liquid coating. The latter technique confers a protective leather coating.

There is also another, but rarely used, method to form a surface coating: lamination of a polymeric film to the leather surface. In such cases, the surface is covered by a film, which is caused to adhere to the surface by pressing with a hot plate.

In general, there are several combinations of finished leather: undyed leather, dyed in a bath without a coating (aniline leather), surface dyed by applying a coating, and both bath dyed and surface coated. If the leather surface has many defects, these may be removed by grinding. In such cases, the coating is thicker and forms an artificial grain.

Coating of leather and coloring it by coating are accomplished by applying several coating layers. Initial grounding layers penetrate the surface of the derma and help to bond the leather. The midlayer is the most important; it has a protective and a decorative function. The top layer determines the gloss level, brings out the aesthetic qualities of the main layer, and often protects it from the effects of moisture.

The number of separate coating layers required to produce the desired leather surface quality depends on their composition and on the condition of the leather surface, which may be natural or polished. The formation of a leather surface coating generally consists of the following steps.

1. Application of a single nonpigmented seal coating. In the case of leather with a natural top grain, this coating is applied by spraying; in the case of a polished surface leather, by flow coating. This coating has a good penetration and it helps to bond collagen fibers and to form the ground for the formation of a new leather surface.
2. After some drying and light pressing (pressure 0.6 to 0.9 mPa and temperatures 55 to 60°C), the leather is coated with a pigmented ground coating. This coating may be applied by brushing.
3. After drying and sometimes light pressing, the main pigmented coating is applied. Depending on the color, it may consist of two or three separate applications; in the case of light colors, even four applications may be required.
4. The top coating is applied by spraying in a single or double application. Sometimes drying and pressure may be applied between the coats.

All these steps are not necessary in all cases. Depending on the leather's surface condition, sometimes the first ground coat may be omitted; quite often the second pigmented ground coating is omitted, and its function is performed by the main coat.

100.2 Characteristics of Leather Coatings

100.2.1 Main Coating

Leather coatings may be water- or solvent-borne. The main advantage of aqueous dispersions is the absence of flammable, volatile, and polluting organic solvents. Therefore, aqueous dispersions are used for leather coatings more often than solvent-borne coatings. That is especially true for footwear leather. Many different coating compositions are used.

The main coating ingredient is the film former or binder. Pigments are usually predispersed and added as a paste. Plasticizers are added to increase the flexibility, softness, and elasticity. Surface active agents improve wettability and therefore improve the adhesion. Waterborne coatings may employ thickeners to increase the viscosity. Cross-linking agents are used sometimes to improve temperature and chemical resistance. In the formulations for ground coatings, penetrating agents may be used; they usually are mixtures of surface active agents, organic solvents, and water. For solvent-borne coatings, organic solvents and diluents are used.

Various synthetic and natural materials are used as film formers. They are mainly aqueous emulsions of acrylic, and also of vinyl polymers and copolymers; polyurethanes and nitrocellulose, available as solvent solutions and aqueous dispersions; casein and its derivatives; and waxes and other materials capable of film forming and exhibiting a good adhesion to leather. The desired appearance of such coatings is also important in determining the choice of a binder.

Coatings are classified according to the binder used: thus we have emulsion, nitrocellulose, polyurethane, and casein coatings. Casein coatings, having the milk protein casein as the binder, are used less and less frequently. Casein as well as nitrocellulose is being replaced by various synthetic polymers.

100.2.2 Unpigmented Ground Coatings

The dermal structure consists of two main layers: the upper or gland layer and the lower or net layer. The gland layer is less dense and has large pores, and the fibers are bound less strongly together. The

gland layer is further weakened and damaged when the leather surface is ground. Therefore, before applying a pigmented coating over a ground leather surface (and sometimes one that is not ground), an unpigmented ground coat is applied. This coating penetrates the gland layer of derma, bonds its structural elements, increases the bond between the gland and net layers, and in this manner, eliminates leather breakage in the finished product. In addition, the unpigmented ground coating provides improved adhesion of the main coating.

Unpigmented ground coatings are prepared from various latexes, which are diluted with water and contain penetrating agents, which increase the penetration of the ground coating into leather. Penetrating agents consists of organic water-miscible solvents, such as alcohol, nonionic or anionic surfactants, and water. These components are mixed in various ratios: solvent 25 to 40%; surfactants 10 to 15%; the remainder, water. Polymer concentration in the ground coating is 7 to 10%. Depth and rate of penetration depend on the coating's capability of wetting leather, the density of the leather upper layer, its viscosity, and the chemical nature of the polymer. Penetrating agents improve the wetting capability. The penetrating capability of ground coatings can be characterized by the time required for a ground drop (0.1 ml) to be absorbed by leather. Absorption time of 3 to 8 sec is acceptable. A ground coating penetrates to one-third of the leather thickness. The composition of ground coatings is selected empirically, because the relationship between the coating's reinforcing properties, its adhesion, rate of penetration, wetting capability, and emulsion particle size is not easily defined.

A ground coating recommended by Reichhold Chemie is of the following composition, in parts by weight:

Durlin-binder 5318, 200
Durlin-binder 5534, 70
Durling-penetrator RCH-30, 130
Water, 600

Stall recommends the following ground coating:

Resin 6509, 70
Resin 6582, 30
Penetrator 6507, 60
Water, 280

The consumption of ground coatings is 150 to 200 g/m².

After application of the ground coat, leather is allowed to relax and to dry. Drying conditions are very important. Leather is dried horizontally at a slow rate. The temperature should not exceed 30°C, and only a mild air circulation should be used. At such conditions, water evaporation from the surface and its migration into internal capillaries of the leather proceed slowly and do not cause the migration of dispersed polymer to the surface. The polymer remains uniformly distributed in the gland layer of the leather.

In addition to aqueous polymer emulsions, polyurethane solutions, capable of forming elastic films, are used. If polyurethane has free isocyanate groups, formation of chemical bonds between isocyanate and functional groups in collagen may develop. This increases the interaction between the ground coating and fibrous structure of the gland layer of the leather.

100.2.3 Aqueous Pigmented Coatings

Aqueous pigmented coatings are the most widely used coatings in leather manufacturing. In these coatings, the film former is dispersed in water. They are prepared by blending pigment concentrates (paste consistency pigment dispersions, including a binder, which acts as a protective colloid with latex), various additives, and water to dilute to the required pigment concentration. Aqueous pigmented coatings are complicated colloidal systems; therefore, their stability is especially important. They must not coagulate when diluted with water, when subjected to a mechanical force (mixing, pumping, applying by brush), and under the addition of some electrolytes. It is important that the pigments be protected from flocculation and that they do not precipitate. The protective colloid and emulsifier must be compatible

with the latex film former and must form a uniform structure throughout the coating volume. The protective colloid function in various pigment pastes is performed by ammonium or sodium caseinates, methyl cellulose, carboxymethyl cellulose, or acrylic carboxylated copolymers. Film formers are acrylic and diene copolymer emulsions.

When formulating coatings, it is important to select components to ensure that the coating is elastic and resistant to aging, and that the pigments are uniformly distributed.

100.2.3.1 Acrylic and Diene Latexes

A latex may be blended by employing polymers that form soft and tacky coatings with polymers that form stronger and harder coatings. The elasticity temperature range may be expanded into lower temperatures by blending acrylic copolymers with diene latexes. However, diene copolymer latex films are less resistant to light. Therefore, acrylic latexes are more suitable for white coatings.

Diene copolymer latexes are prepared by copolymerizing various diene monomers with acrylic or methacrylic acid esters. Such useful copolymers are methyl methacrylate-chloroprene (30:70), methyl methacrylate-butadiene-acrylic acid (35:65:1.5), piperylene-acrylonitrile-methacrylic acid (68:30:2), and many other copolymers. Films from these copolymers retain their elasticity at least down to -20°C and are useful for blending with acrylic latexes to extend their low temperature flexibility.

100.2.3.2 Casein

Casein is a protein prepared from milk. It is soluble in dilute alkalis. It is used as a binder in the preparation of pigment concentrates and also in casein and combined casein-emulsion coatings.

Modified casein is a methylacrylate and ammonium caseinate emulsion polymerization product used as an additive in coating compositions with other, usually acrylic, latexes. Films of modified casein are elastic (elongation of 600 to 900%), strong (tensile modulus at failure 6 to 8 mPa), and soluble in water. However, they may be easily rendered hydrophobic by treatment with formaldehyde or solutions of polyvalent metal salts. Butadiene-ammonium caseinate copolymer latex has similar properties.

100.2.3.3 Wax Emulsions

Wax emulsions are water-dilutable dispersions at pH 7.5 to 8.5 and are stabilized with nonionic surfactants. The basis is usually montan or carnauba wax. Emulsions are used as additives to pigment and top coatings.

100.2.3.4 Pigment Concentrates

To obtain well-colored leather, it is important that pigments be well dispersed in the binder and that a strong bond be formed between pigment particles and the binder. Direct pigment dispersion in the coating is difficult. Aqueous polymer emulsions used for leather coatings are not sufficiently viscous to maintain a uniform distribution of pigments. Furthermore, emulsions might not be stable enough to allow a direct addition of pigment. Therefore, the pigment is dispersed separately in the binder solution, yielding a stable dispersion that can be safely blended with film forming emulsion and other additives to ensure the stability of the heterogeneous system. The pH should be similar in the two dispersions. Pigment concentrates, depending on the binder used, can be of varying composition: casein, where the binder is an aqueous alkaline casein solution, or a synthetic polymer base, mainly acrylic.

A pigment concentrate in casein may have the following composition (in parts by weight):

Pigments, 14 to 60

Casein, 3.8 to 8.6

Oil of alizarine, 2.4 to 4.0

Emulsifiers, 0.5 to 1.0

Antibacterial agent, 0.5 to 0.9

Water, up to 100

To prepare such a composition, casein glue is made up first (18 to 20%); then antibacterial agent is added, followed by other additives. The pigment is dispersed employing suitable equipment until a stable dispersion is obtained. Casein binder is suitable for the dispersion of all pigment types.

In addition to casein-based pigment concentrates, pigment dispersions based on acrylic polymer are used. Pigments are dispersed in a thickened acrylic emulsion. If the film former in the coating is an acrylic latex, it mixes well with such pigment dispersions. Acrylic dispersions also are more effective in improving the coating elasticity, as compared to casein dispersions. The composition of pigment dispersions in acrylic latex may be as follows:

- Pigments, 11.2
- Blend of two or three acrylic emulsions, 85.3
- Ammonium hydroxide (25%), 2.3
- Oil of alizarine, 0.7
- Surfactants, 0.5

Pigment concentrates based on acrylic emulsions are of a viscous paste consistency; they are easily dilutable with water, and they blend well with all aqueous emulsion film formers.

In addition to pigments, dyes may be used in coatings. In the preparation of pigment or pigment-dye blend coatings, attention must be paid to the pigment properties — their resistance to light, their opacity, and the elimination of such side effects as bronzing.

100.2.3.5 Nitrocellulose-Based Compositions

These products are used for nitrocellulose coatings, but most frequently, for top coatings over coatings of other types. Nitrocellulose solutions (lacquers) in organic solvents, or solution dispersions in water, are used.

Nitrocellulose lacquer is a solution of nitrocellulose in organic solvents and diluents compounded with plasticizers. Nitrocellulose is available in alcohol-soluble and -insoluble forms. The latter is used for leather coatings. Each type is available in several viscosity grades, depending on the molecular weight of the nitrocellulose. A compromise is usually made between the coating's physical properties, which improve with increasing molecular weight, and coating solids, which decrease with increasing molecular weight for a solution of required viscosity.

The solvents used are ethyl and butyl acetates, acetone, and methyl ethyl ketone. Alcohols (ethyl and isopropyl), while not solvents by themselves, enhance the solubility of nitrocellulose in other organic solvents. Diluents are miscible organic liquids that do not dissolve nitrocellulose but decrease the solution viscosity. They are also less expensive than true solvents. Such diluents are toluene, xylene, and some aliphatic-aromatic hydrocarbon blends. The choice of solvents/diluents for nitrocellulose lacquer is determined by economics and by such properties as sufficiently low volatility, lack of water absorption, or capability to form azeotropic blends with water. For film formation it is important to have an optimum amount of alcohol, which has a relatively low volatility.

Nitrocellulose is brittle, and therefore plasticizers are used in compounding nitrocellulose coatings. Plasticizers used are alkyl phthalates, castor oil, camphor oil, and others.

Nitrocellulose lacquer is a clear, water-white, easily dilutable, viscous liquid containing 15 to 18% solids. The tensile strength of nitrocellulose film is 1.5 to 1.8 mPa; elongation at break is 50 to 60%.

Aqueous nitrocellulose dispersions also contain some organic solvents, which facilitate the coalescence of nitrocellulose lacquer particles. Film formation from nitrocellulose dispersions that do not contain any solvent is difficult. Both types of dispersion are used: oil in water and water in oil. Nitrocellulose coatings are used as top coatings over aqueous emulsion coatings. The mechanical properties of nitrocellulose films obtained from aqueous dispersions are poorer than those obtained from solutions.

Leather that does not require vapor and air permeability (e.g., leathers used for applications other than footwear or clothing) may be coated entirely with nitrocellulose, starting with the ground coat and ending with the top coat. For the ground coat, aqueous nitrocellulose coatings are mainly used; the main coat consists of a pigmented nitrocellulose enamel, and the top coat is a clear nitrocellulose coating.

100.2.3.6 Polyurethane Coating Compositions

Coatings described here are used for all polyurethane coatings and also as top coats for coating of other types. Polyurethane solutions in organic solvents and aqueous dispersions are used. Coatings of this type

have a good adhesion to leather (because of the urethane groups). Polyurethane lacquers may be clear and colored (pigmented or dyed). Many different polyurethane structures are available: tridimensional, branched, or linear. Thus, coating properties may be obtained that exhibit variations in elasticity, resistance to solvents and abrasion, and thermal and light resistance. The main disadvantage of these coatings is that they mask the appearance of the leather surface and contribute to the artificial appearance of the product. This is mainly the case for coatings consisting entirely of polyurethane, but not for top coatings. Polyurethane coatings are also used to prepare varnished leather.

Polyurethane leather coatings are made from ester oligomers (molecular weight of about 2000) and isocyanates. Polyurethanes may vary widely in their properties. If oligomers have more than two hydroxyl groups, the resultant polyurethanes are three-dimensional structures and have a high chemical and temperature resistance. If ether oligomers or polyethers (polypropylene glycol, polytetramethylene glycol) are used, the resultant polyurethane film has a higher resistance to hydrolysis and better low temperature properties, retaining the elasticity at lower temperatures.

The synthesis of polyurethane is carried out in a solution of organic solvents, such as methyl ethyl ketone, dimethylformamide, butyl- and ethyl acetate, and their mixtures. Two main polyurethane polymerization processes are used: single stage and two stage. The two-stage process begins with the reaction between ester oligomers and isocyanate, which yields a low molecular weight prepolymer. In the second stage, under the effect of a chain extender (1,4-butanediol, diamines), the chains grow. In the manufacture of varnished leather, the second stage is usually carried out after coating application to the leather surface.

Polyurethane coatings can be applied by spraying or by flow coating. The coating is dried for about 16 hours at 30 to 40°C and low relative humidity (40 to 50%), with the leather sheets in the horizontal position.

Coatings with a metallic sheen may be prepared by the addition of metallic particles, prior to the application of a clear top coating.

A single-component polyurethane lacquer is a solution of thermoplastic, high molecular weight, linear polyurethane in organic solvents. Such lacquers are produced from linear polyesters and diisocyanates, and in dilute solution they are useful as top coats. Thermoplastic polyurethane films are elastic, their elongation at break reaches 1000%, and the elastic properties are retained over a wide temperature range (-30 to 120°C).

Aqueous polyurethane dispersions are obtained by the dispersion of polyurethane in water, employing emulsifiers. Aqueous dispersions are useful for pigmented coatings: ground coats, main color coat, and also for top coats.

Mixtures of polyurethane and nitrocellulose dispersions are also used as top coats. Such top coats dry faster, but their mechanical and aesthetic properties are poorer.

100.3 Technology of Decoration of Skins of Large Hoofed Animals with Artificial Grain

The processing technology becomes more complex when it is required to form an artificial grain. The natural grain is ground down and a coating is applied in several applications. An artificial grain, including one imitating natural leather, is formed.

This process starts by grinding the grain surface two or three times. Grinding is performed by employing special grinding-polishing equipment and using #5 to #6 abrasive paper. After grinding, the leather surface is coated with an unpigmented ground coat of the following composition (in parts by weight):

Acrylic dispersion (40%) solids, 100
Penetrator, 40
Water, 300

An unpigmented coating is applied by a curtain coater. Its consumption is about 0.2 to 0.3 kg/m² depending on the density of the leather's glandular layer. The leather is then stored for 8 to 24 hours, dried, stretched, pressed, and ground again. Pressing before grinding improves the grinding-polishing

quality. The leather is dyed by running it twice through special equipment, which also involves drying, initially at 110°C, and then at 80°C at the end of the drying tunnel. The drying cycle lasts 1 to 2 min. In the next step the leather is pressed at a plate temperature of 50 to 70°C and a pressure of 14.5 mPa.

One or two additional color coatings are applied until the surface is sufficiently well covered. Light and intense colors may require three or four coating applications. The leather is dried at 65 to 75°C after each coating and pressed at a plate temperature of 65 to 75°C and a pressure of 14.7 mPa. After this smooth press, the grain is pressed in by a hydraulic press at a temperature of 70 to 80°C and 14.7 mPa pressure. The process is ended by spraying one or two layers of top coat. Nitrocellulose lacquer (or emulsified lacquer) or polyurethane lacquer is used for the top coat.

100.4 Some Nonstandard Coating Applications

Rohm & Haas Company suggest employing foamed color coatings. Such coatings consist of few components: latex film former, pigment dispersion paste, and foaming agent. These coatings contain 50% solids and are applied to a coating weight of 0.4 to 0.5 kg/m². The application technology is not much different from the standard application techniques: drying, pressing, and coating spraying are employed. The coating is elastic and resistant to flexing (endures 20,000 to 40,000 flex cycles). The method is more economical than traditional techniques.

Another method is casting on a silicone elastomer matrix with a negative leather grain. A polyurethane coating is applied (a prepolymer containing free hydroxyl groups and an isocyanate cross-linker). Coating thickness varies from 0.15 to 1 mm. A leather (which also could be split leather) is pressed against the uncured coating and after a contact time of 10 to 15 min, it is dried in a drier, where a well-adhered coating is formed. After such curing, the leather is removed from the matrix.

101

Metal Coatings

101.1 Metallizing.....	101-1
Liquid Metal Processes • Solid Metal Processes • Vapor Processes • Plating	
101.2 Coating on Metals.....	101-4
Decoration • Protection	
References.....	101-6

Robert D. Athey, Jr.
Athey Technologies

There are two facets to metal coatings — coatings on metal substrates, and metals as coatings on any substrates. The latter can be lumped together in a one-word category called “metallizing,” which is done in many ways. The former, coatings on metal substrates, generally are thought of as paint-type materials but may include waxes, inks, and other coatings. The two topics will be dealt with separately, beginning with metallization, as those metal surfaces are often painted or coated for protection, as well.

101.1 Metallizing

The objective of metallizing techniques is to place metal on the substrate for appearance or protection of some sort. The classes of metallization are many and complicated, but may be separated by their process details. Processes that apply metal to surfaces may use metal as individual atoms or ions, as the fluid molten metal, or as the solid metal. We deal with each separately.

101.1.1 Liquid Metal Processes

101.1.1.1 Galvanizing

The metal item (iron or steel) is dipped into a molten bath of zinc, then withdrawn, and the excess zinc allowed to drip off. The item is cooled and the zinc crystallizes on the surface (giving an appearance called “spangle”), with the cooling rate determining the size of the zinc crystals showing on the surfaces. This process can be made continuous for rod, wire, coiled sheet or pipe, and semicontinuous for reinforcing rod, pipe, and cut sheet.

The process is not quite as simple as it sounds. There are iron/zinc compounds that form at the molten interfaces. The time of heating a molten zinc–iron interface governs the thickness of the interface containing these compounds, and the ratios of iron and zinc in the compounds at the interface. In addition, sal ammoniac (ammonium chloride) is used as a flux in the molten zinc, but it can appear as a blue coating or streak on the galvanized item, to the item’s detriment. That “sali”-contaminated item should be recoated.

The zinc layer on the item acts as a physical barrier to corrosion. However, as soon as there is physical damage to the zinc layer, exposing the iron, the zinc acts as a sacrificial anode, giving the iron electrolytic corrosion protection, as well. Since zinc is soft and easily corroded, it will “wear” away, showing the white

zinc oxide surface as the zinc layer becomes thinner. The white zinc oxide has substantial water solubility and washes away in rain. The zinc surface is often painted to give protection against these losses.

101.1.1.2 Flame/Plasma Spray

Although all the flame and plasma spray processes project liquid metal droplets through the air to the substrate, each starts with a solid metal wire or solid molten powder. The solid is taken into a device which heats it to the molten state, breaks it into microscopic droplets, and propels the droplets at the substrate. Longo edited a reference book on this topic.¹

The “flame” or “thermal” spray uses a modified oxyacetylene torch as the heat source. After the flame has been adjusted to its hottest, additional compressed air is blown into the flame. The wire or powder is then fed in via a funnel, and the blast of liquid metal particles is pointed at the substrate. The “plasma” spray uses an electric arc as the heat source to melt the wire or feed powder into the compressed airstream.

The distance between the molten metal’s origin and the substrate will determine the type of coating obtained. The close approach of the nozzle means that most particles will hit the substrate surface as a liquid. Many will stick, and transfer their heat to the substrate, but some particles will bounce off. If the nozzle is further away, the smaller liquid particles will solidify and bounce off the substrate, while the larger particles will still stick. If the nozzle is too far from the substrate, none of the particles will stick because they will have cooled too much. Losses from bounce-off or from premature cooling will be on the order of 25% of the weight of the metal sprayed.

The metals most commonly sprayed include copper, zinc, iron, and aluminum. Alloys and even metal oxides can also be sprayed, provided there is enough heat in the flame to make the particle soften. Since the sprayed metal is of lower density than the solid metal, there is occluded air, and even porosity. However, adhesion to most substrates is good, and is often assured by cleaning and roughening the surface (e.g., sandblasting). The inorganic coating may be built up enough to be machined, and may be strong enough to be a bearing surface.

101.1.1.3 Other Liquid Metal Coatings

Any solid can be dipped into a molten metal.

101.1.2 Solid Metal Processes

101.1.2.1 Sherrodizing

An item of steel or iron is put in a drum with powdered zinc and steel balls, and the drum is rotated. The zinc powder is essentially hammered onto the surface of the steel/iron item as individual spots. The length of time in the rotating drum, the amount of zinc powder, the number of steel balls, and the number of items to be treated all govern the actual amount of zinc that ends up on the surface of the item to be treated. The zinc coating on the iron/steel acts as a corrosion (rust) inhibitive protection for the item.

101.1.2.2 “Detaclad” Process

The construction of metal laminates, such as the coinage products now used by the U.S. Treasury, is a simple process involving a layer of metal applied to another metal surface by the force of an explosion on one surface. If silver is needed as an outer surface over copper, the explosive is on the side away from the copper in the setup, as shown in [Figure 101.1](#).

101.1.3 Vapor Processes

101.1.3.1 Vacuum Evaporation

The simplest of the vapor processes is vacuum evaporation. The items to be coated are put on racks that circle a central set of trays formed from electrical resistance heaters. A bell jar is lowered over the whole array, and sealed to be pumped down to 1 mm Hg of vacuum. The resistance heaters are fired off to evaporate the metal powder or slug in the tray, and the individual atoms of metal fly off in a straight

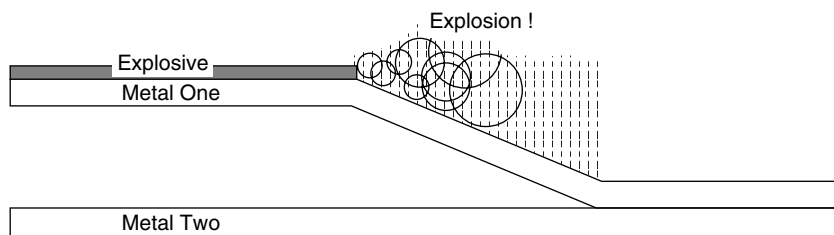

FIGURE 101.1 Explosive bonding of metal.

line toward the bell jar in all directions. The items to be coated are hit by these atoms in a line of sight from the resistance heater tray. The atoms condense on all surfaces facing the heater trays, forming discrete globules at first, and covering the whole surface as the globules coalesce.

The items to be coated must be treated to make sure the metal wets and adheres. Such treatments might be simple washing or precoating with a polar lacquer, or as complicated as a plasma etch or a corona discharge surface treatment. Even nonpolar materials like poly(propylene) or acrylonite-butadiene-styrene resins can be successfully coated with good adhesion by vacuum evaporation. Common items so treated include toy cars and lipstick cases.

Good continuous film coatings can be formed on just about any surface, at thicknesses ranging from micrometers to millimeters. Indeed, the transparent gold coating put on aircraft windshields for deicing/defogging is about 10 nm thick. This coating **MUST** be continuous, as any microhole in the coating would cause a blue “burn” spot as soon as current was applied.

Almost any metal may be vacuum evaporated, though some metals sublime, rather than undergo the preferred heat/liquefy/boil process. The subliming metals do not do quite the line of sight depositions desired, and the vacuum fittings can become plugged. The most common are aluminum, copper, gold, and silver.

Since the metal deposited by this process is in the bare, unprotected, metal atom form, it may corrode quickly if it is so disposed in the electrochemical series. One must apply topcoat for corrosion protection immediately. Sorg² described vacuum metallized parts for automobiles, while others compared a number of different approaches for automotive bright work.³ Sorko Licensing Company has a patent on making mirrors from clear acrylic sheet.⁴

101.1.3.2 Sputtering

The key elements in the sputtering process make it different from simple vacuum evaporation. The metal is vaporized by an electron beam, which charges the metal atoms or droplets with a negative charge. The substrate is made the cathodic target (or is directly in front of a cathodic target). Thus, electromotive force is the driving force coating the substrate. It is used quite successfully to coat Mylar films for sunshade applications with copper, aluminum, and even stainless steel. Sputter plating onto actual polymers has been described from plumbing fixtures.⁵

101.1.3.3 Chemical Vapor Deposition

A reference book on plasma deposition has been edited by Hochman and others.⁶ The substrate is placed in a container that is then evacuated, and a gas or gases are drawn in. The container has a cylindrical electrode just within the inner surface, and this is to react with each other or the surface of the substrate.

Monomers used in plasma deposition of polymer include methyl methacrylate,⁷ propylene,⁸ acrylic acid,⁹ acrylonitrile,¹⁰ norbornadiene,¹⁰ hexamethyldisiloxane,¹¹ tetrafluoroethylene,¹² ethylene,¹² and styrene.¹² Nonmonomers (such as pentafluorobenzene,¹³ methane,¹⁴ or tetrafluoromethane¹⁵) also may deposit polymeric coatings. Colloidal metal may be included within the polymer film to generate a colored coating.¹⁵

The advantage of plasma coating is the very thin film formed, with no pinholes and no contaminants (i.e., the additives needed in solvent or waterborne coatings).

101.1.4 Plating

101.1.4.1 Electroplating

A good place to start the investigation of plating processes is an annual handbook supplied by a trade magazine publisher.¹⁶ Plating on plastics has been reviewed by Saubestre¹⁷ and by Muller and associates.¹⁸ Springer and associates¹⁹ described details of polymer treatments^{20,21} and morphology²² as important in electroplating polymer surfaces. Safrenek²³ detailed the properties of electroplated metals and alloys. A zinc–nickel alloy electroplated onto steel is reputed to have better corrosion properties than galvanized steel.²⁴

101.1.4.2 Electroless Plating

The handbook cited earlier is a good reference for electroless plating as well.¹⁶ The idea is simply to put a metal solution on a surface, and let it deposit the zero valent metal on the surface because of an added chemical. It turns out not to be quite so simple, because addition of the reducing agent to a solution does not guarantee that the metal will deposit on the surface, and it does not mean that the deposit will adhere if deposited. Hence, there are sequences of “washes” and “activators” that prepare the substrate to accept the final plating formulation. In the case of plating on plastics, several oxidative techniques (chromic acid solutions, plasma etching, nitric acid washes, etc.) are used to prepare a surface. One process uses three deposition steps, with clean water rinses between, to end up with copper on plastic. The three solutions are tin chloride, palladium chloride, and a formulated copper solution that has reducing agent along with rate modifier and surface modifier chemicals as well. Rigorous rinsing between the metal solutions is needed to assure that the last solution does not become a slurry of colloidal copper, because of “dragout” or contamination by preceding metal ions. The electroless plating deposits are continuous, conductive, and bright, but are thin — micrometers in thickness.

101.2 Coating on Metals

Coatings for metals may be divided into two classes by main function: those that are decorative, and those that are protective. That is not to say that a protective coating cannot be decorative, but that the coating's main function is protective, while it is chosen to be decorative as an additional option.

101.2.1 Decoration

The decorative aspect of coatings lies in several features that are dealt with elsewhere in this book. Among those aspects are color, gloss/flatness, and texture. Each entails specific approaches the formulator uses to attain the desired appearance, mainly involving choices of vehicle (the adhesive that sticks the pigment particles together and then to a substrate), pigments, the ratio of pigments to vehicle, and (occasionally) the additive that confers a certain property when pigment or vehicle cannot.

Yet another aspect of decoration is pattern. If and when there are multiple colors on a surface, the shape described at the color interfaces can be important. The camouflage paints strive to have what appear to be random splotches, because a regular geometric pattern (especially a straight line) attracts the eye to a potential target. The multicolor paints (described in Chapter 87) have the dots, splotches, smears, and lines simulating natural mineral or rock formation surfaces. And the pattern is a main point in signage or artwork.

101.2.2 Protection

The metal substrate is generally thermodynamically unstable and is easily converted to the more thermodynamically stable oxide. However, the protection provided to the metal substrate is often designed to guard against sorts of attack other than chemical oxidation. Mechanical damage may aid the oxidation, by providing sites for the oxidant to work. Electrical exposure or damage can ease the chemical degradation. So, work on protecting a metal substrate must include consideration of the insults or attacks to

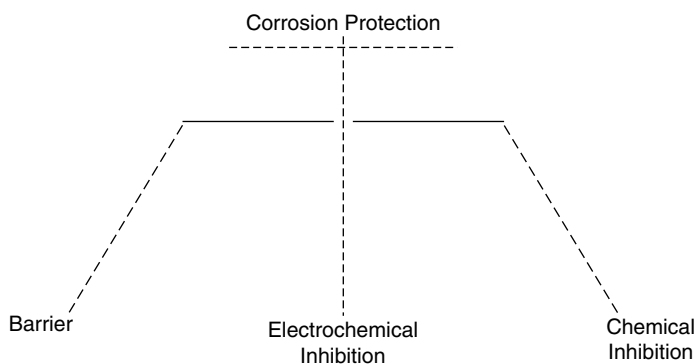

FIGURE 101.2 Corrosion protection schemes.

be expected. In the instance of corrosion, the protection may aim to prohibit contact of the coating with oxygen or water — each a necessary element of the corrosion reaction. The aim may also be to prohibit contact with corrosion catalysts — salts, acids or alkalis. Schweitzer²⁵ reviewed corrosion and protective schemes, and one unit of the educational booklets from the Federation of Societies for Coating Technology deals with corrosion protection^{26a} while another covers corrosion and surface protection for painting.^{26b} Wilmhurst²² described aqueous maintenance paints for corrosion protection in Australia, while Campbell and Flynn²⁷ did so for the United States and Poluzzi²⁸ for Italy. A Golden Gate Society for Coatings Technology Technical Committee study²⁹ showed the waterborne systems have come to equal the solvent-borne coatings for corrosion protection in aggressive environments (i.e., the Golden Gate Bridge).

At the National Coatings Center, we divide a “pitchfork” diagram (Figure 101.2) to describe the three major corrosion protection schemes. The main emphasis was on improving ways to give corrosion protection through combinations of some of the corrosion protection schemes.

Examples of the barrier coatings are fairly straightforward. As noted earlier, the zinc in galvanizing is initially a barrier, and any impervious coating is a barrier, be it wax, asphalt, coal tar, polyethylene, or whatever. There are selective barriers that aim to protect against corrosion by blocking a specific corrosive element. The wax, polyethylene, coal tar, or asphalt is specifically aimed at prevention of water permeation to the metal surface, as water is a specific corrosive substance. Other coatings (PVDC, Baresx-type nitriles, etc.) aim to prohibit oxygen permeation. In both cases, the coatings are diffusion barriers, and the key is to have a coating that dissolves as little as possible of the permeant within the coating, and also inhibits permeation. A highly polar coating material is always more water permeable than the nonpolar material, because water dissolves so well in the polar material that the polar material acts as a pipeline rather than a barrier. It is a chuckle to hear of silicones or acrylates described as waterproofings, but you have to understand the implied statement that they protect against liquid water, while water vapor goes through them 100 to 1000 times faster than it would go through a hydrocarbon barrier. Munger³⁰ reviewed protective coatings for corrosion prevention.

The electrochemical protection schemes are bound up in converting the iron or steel into a cathode, since the corrosion reaction is an anodic oxidation of the zero-valent iron metal to ionic forms (usually ferrous). The easiest way is to simply contact the metal with something that is oxidized more easily (zinc, magnesium, aluminum, etc.) and let the iron be the cathode while the other metal is corroded as the sacrificial anode. Indeed, there is a substantial market in bars of magnesium or zinc that are attached to iron (pipelines, underground tankage) to act as sacrificial anodes. We already noted that galvanized iron with the zinc surface damaged to penetrate to the iron is still electrochemically protecting the iron. The “zinc-rich” paints (having about 85% by weight of zinc metal powder and 15% binder) are also cathodic protectors of steel. But the sacrificial anode does send its corrosion products into the surroundings. In a tidal area, the sacrificial anode specified by some regulatory agencies feeds metal ions into the underground water while it is protecting the underground storage tank.

An alternative in cathodic protection is to impress a current onto the potentially corroding metal to make it cathodic. Here a battery, or a step-down transformer is used with another power source. This technique is used on shipboard for iron hulled vessels, and the battery can be recharged when needed. Some pipelines are cathodically protected with impressed current. The advantage is that there are no ions lost to the surroundings, hence subsequent contamination of water.

The chemical inhibitors are many and varied items of commerce and may work in many ways. Most are sold because they have been shown to work, though no mechanism is proposed. Some of the surfactant-type materials (oleyl sarcosine, for instance) may only add a physical barrier by adsorbing to the surface and blocking approach of oxygen, water, or catalytic ion. Other materials may adsorb on the metal and act as a pH modifier or buffer, as an amine would inhibit acid-catalyzed attack. Some inhibitors modify the electromotive potential at which corrosion occurs and are said to have "passivated" the surface. Most of the chemical inhibitors are low molecular weight compounds and can be washed away or otherwise rendered ineffective by chemical attacks or reactions. They are effective over short periods of time, and can be stabilized against erosions by formulation to some degree. For instance, there are oils into which corrosion inhibitors are formulated.

There are corrosion-inhibitive pigments. Seldom is there discussion of the mechanism by which these chemical inhibitive pigments work, and such characterization could extend their utility. It has been shown that nominally corrosion-inhibitive pigments do not work in some formulations (see SSPC literature and corrosion studies by the technical committees of the Northwest, New England, and Golden Gate Societies for Coatings Technology). Indeed, Nadim Ghanem (American University of Cairo) told of a basic lead carbonate formulation study in which the solvent-borne vinyl binder gave no corrosion protection, while a waterborne vinyl gave excellent protection. His hypothesis was that the coating needs to be permeable to water to get the lead ions to migrate to where they need to be to act as corrosion protectors. That may have also been the message in the Los Angeles Society for Coatings Technology work with aminosilane-treated talcs in latex formulations. Though many demonstrations of the effectiveness of the corrosion-inhibitive pigments exist, the mechanisms should be more thoroughly described to aid the formulator.

References

1. F. N. Longo, Ed., *Thermal Spray Coatings: New Materials, Processes and Applications*, American Society for Metals Conference Book. Metals Park, OH: ASM, 1985.
2. R. T. Sorg, *Prod. Finish.*, July, 72 (1978).
3. Anon., *Ind. Finish.*, January, 24 (1978).
4. British Patent 1,369,056; *Chem. Abstr.*, 83, 116382u.
5. M. Rogers, *Plast. Technol.*, November, 20 (1982).
6. R. H. Hochman et al., Eds., *Ion Implantation and Plasma Assisted Processes*, American Society for Metals Conference Book. Metals Park, OH: ASM, 1988.
7. Fujitsu Ltd., Japanese Patent 8,089,833 December 28, 1978; *Chem. Abstr.* 5. 39579m.
8. A. K. Sharma et al., *J. Appl. Polym. Sci.*, 26, 2197 (1981).
9. R. Athey et al., *J. Coatings Technol.*, 57(726), 71 (July 1985).
10. A. Morikana and Y. Asano, *J. Appl. Polym. Sci.*, 27, 2139 (1982).
11. C. Arnold, Jr., et al., *J. Appl. Polym. Sci.*, 27, 821 (1982).
12. M. R. Havens et al., *J. Appl. Polym. Sci.* 22(10), 2793 (1978).
13. D. T. Clark and M. Z. Abraham, *J. Polym. Sci., Polym. Chem. Ed.* 19, 2129 (1981).
14. N. Inagaki et al., *J. Polym. Sci., Polym. Lett. Ed.*, 19, 335 (1981).
15. H. A. Beale, *Ind. Res. Dev.*, July, 135 (1981).
16. M. Murphy, Ed., *Metal Finishing Handbook*, Hackensack, NJ.
17. E. B. Saubestre, in *Modern Electroplating*, 3rd ed., F. Lowenheim, Ed. New York; Wiley-Interscience, Chapter 28, 1974.
18. G. Muller et al., *Plating on Plastics*. Surrey, England: Portcullis Press.

19. J. Springer et al., *Angew. Makromol. Chem.*, 89, 81 (1980).
20. J. Springer et al., *Angew. Makromol. Chem.*, 89, 81 (1980).
21. J. Springer et al., *Angew. Makromol. Chem.*, 89, 81 (1980).
22. A. G. Wilmhurst, *Aust. Oil Colour Chem. Assoc.*, November, 12 (1978).
23. W. H. Safranek, *The Properties of Electrodeposited Metals and Alloys*. American Electroplaters and Surface Finishers Society, 1986.
24. S. A. Watson, *Nickel*. 4(1), 8 (September 1988).
25. P. A. Schweitzer, Ed., *Corrosion and Corrosion Protection Handbook*. New York, Dekker, 1983.
26. (a) Unit 27, *Anticorrosive Barriers and Inhibitive Primers*. Philadelphia: Federation of Societies for Coating Technology, 1979. (b) Unit 26, *Corrosion and the Preparation of Metallic Surfaces for Painting*. Philadelphia: FSCT, 1979.
27. D. Campbell and R. W. Flynn, *Am. Paint Coatings J.*, March 6, 55 (1978).
28. A. Poluzzi, *14th Annual FATIPEC Congress Proceedings*, 1978, p. 61.
29. R. Athey et al., *J. Coatings Technol.*, 57(726), 71 (July 1985).
30. C. H. Munger, *Corrosion Prevention by Protective Coatings*. National Association Engineering, 1984.

102

Corrosion and Its Control by Coatings

102.1	Introduction	102-1
	Energy Transfer • The Electrochemical Nature of Corrosion • Electrode Reactions • Polarization • Electrode Film Breakdown and Depolarization • Passivation and Depassivation • Area Effects	
102.2	Coatings.....	102-6
	Corrosion Control by Coatings • Barrier Coatings • Inhibitive Coatings • Zinc-Rich Coatings	
	References.....	102-9

Clive H. Hare

Coating System Design, Inc.

102.1 Introduction

102.1.1 Energy Transfer

The metallic state is in most metals an unstable condition resulting from the smelting operation, in which energy is imported by the ore as the metal is derived. After extraction, most metals undergo a slow deterioration process during which they shed this energy and return to a more stable condition in which they are combined with some element of their environment, such as an oxide, a sulfide, or some other corrosion product. This energy conversion process is known as corrosion.

102.1.2 The Electrochemical Nature of Corrosion

Corrosion is most usually driven by some electrochemical inhomogeneity in the metal or its environment. In this process, different areas of the metal, having different levels of free energy and therefore different corrosion potentials, become the electrodes of an electrochemical cell in contact with a common electrolyte.¹⁻⁵ The electrochemical couples are set up with areas of more active electrochemical potential acting as anodes of the cell, while more passive areas act as cathodes (Figure 102.1). Corrosion takes place at the anodes as metal dissolves into the electrolyte as ions, so releasing electrons, which pass through the metal to the adjacent cathode areas where they react with the environment. This flow of electricity, the electron passage from anode to cathode, and the accompanying charge transfer back through the electrolyte from cathode to anode, make up the corrosion current. The rate of the current flow, i.e., the magnitude of the corrosion current (I) that develops, is a measure of the amount of degradation and is related to the potential difference (V) between the anodic and cathodic sites by Ohm's law:

$$I = \frac{V}{R} \quad (102.1)$$

where R is the total resistance of the cell.

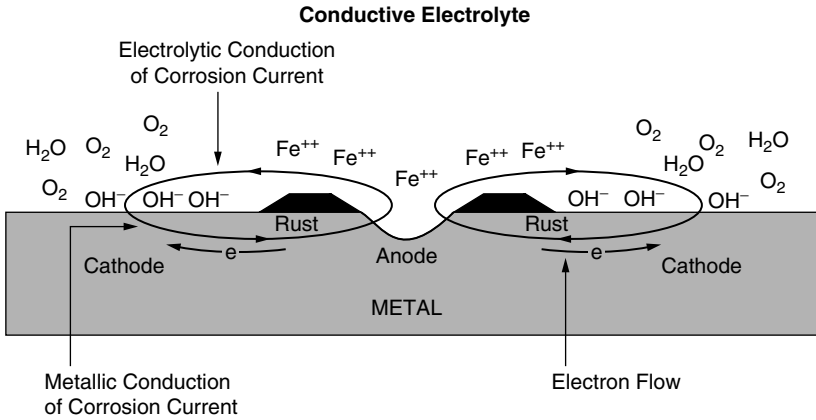

FIGURE 102.1 Electrochemical corrosion cell.

In the normal corrosion cell, R is in fact made up of several individual resistances: the resistances of the two electrodes (R_a and R_c), the resistance of the internal electrical contiguity between them, R_w , and the electrolytic resistance of the common electrolyte across their external faces, R_e .

Ohm's law may thus be rewritten

$$I = \frac{V}{R_a + R_c + R_w + R_e} \quad (102.2)$$

As the anode, the cathode, and their contiguity are all metallic, these resistances are negligible compared to the resistance of the electrolyte, which is ionic, and which may be exceedingly high in electrolytes of low ionic content (e.g., deionized water). The resistances of salt solutions, however, are much lower. It is for this reason that corrosion proceeds much faster in seawater, and only very slowly in freshwater.

Because of these things, the relationship shown in Equation (102.2) becomes practically equivalent to

$$I = \frac{V}{R_e} \quad (102.3)$$

Minimization of the conductivity of the electrolyte is, therefore, an important maxim in corrosion control.

Equally important, of course, is the minimization of V . All metals have different electrode potentials (see Table 102.1), and large potential differences are set up where the electrochemical cell is composed of different metals. The electrical contiguity of a more noble metal and an active one in contact with the same electrolyte can produce severe galvanic corrosion in the active metal. On the other hand, the deliberate electrical fixation of a more active metal (such as zinc) to one of more passive potential (steel) is a powerful stratagem that is widely employed to eliminate corrosion in the passive material in the presence of a common electrolyte. Zinc, magnesium, and rarely aluminum anodes (generally ingots or in the case of zinc often films) are widely used to protect steel in this manner.

Table 102.1 lists many common metals in terms of their electrochemical potential. Those having extremely positive electropotentials (gold, platinum, etc.) are very stable and do not corrode. They are found in nature in the metallic state.

102.1.3 Electrode Reactions

The chemical reaction at the anode (the dissolution of the metal) may be written

TABLE 102.1 Electrode Potentials

Electrode Reaction		Potential (volts)
Active		
Na	$\Leftrightarrow \text{Na}^+ + \text{e}$	-2.71
Mg	$\Leftrightarrow \text{Mg}^{+2} + 2\text{e}$	-2.38
Al	$\Leftrightarrow \text{Al}^{+3} + 3\text{e}$	-1.66
Zn	$\Leftrightarrow \text{Zn}^{+2} + 2\text{e}$	-0.76
Fe	$\Leftrightarrow \text{Fe}^{+2} + 2\text{e}$	-0.44
Pb	$\Leftrightarrow \text{Pb}^{+2} + 2\text{e}$	-0.13
H	$\Leftrightarrow \text{H}^+ + \text{e}$	0.00
Cu	$\Leftrightarrow \text{Cu}^{+2} + 2\text{e}$	0.34
Ag	$\Leftrightarrow \text{Ag}^+ + \text{e}$	0.80
Pt	$\Leftrightarrow \text{Pt}^{+2} + \text{e}$	1.2
Au	$\Leftrightarrow \text{Au}^{+3} + 3\text{e}$	1.4
Noble (Passive)		



where n is the valency of the metal.

In the case of iron, this equation becomes



The exact nature of the reaction at the surface of the cathode (in which electrons released in anodic dissolution are, in turn, consumed) depends upon the nature of the environment. Under neutral and alkaline conditions, the reaction involves oxygen and proceeds



Under acidic conditions, if oxygen is present, the reaction may proceed



Where oxygen is not available, hydrogen gas may form under acidic conditions:



Migration of the oxidative product (M^{n+}) from the anode and the reduction product (OH^-) from the cathode occurs until they combine to form the oxide, which precipitates. In the case of steel this may be $\text{Fe}(\text{OH})_2$, ferrous hydroxide, or, depending upon the nature of the environment, one of several precursor products, such as ferrous hydroxy chloride in salt water. Ferrous products are readily soluble, and this favors migration, so that oxide formations are not intimately associated with the anode but are loosely adherent and porous. Given sufficient oxygen, a second oxidation reaction will occur in steel corrosion, which converts the divalent ion to the trivalent ferric state,



The solubility of the trivalent corrosion product is much less than that of the ferrous product. Under normal circumstances, however, where the secondary oxidative process occurs gradually after the ferrous ions have migrated away from the anode, the corrosion product is no more tightly adherent than is the ferrous product from which it is formed, and films of rust, hydrated ferric oxide ($\text{Fe}_2\text{O}_3 \times \text{H}_2\text{O}$), are usually loose and crumbly.

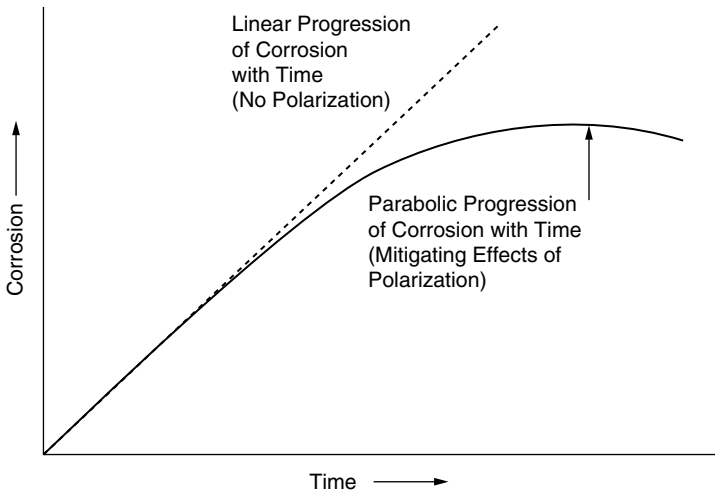

FIGURE 102.2 Polarization and its effect on corrosion rate.

102.1.4 Polarization

The accumulation of ions at the anode tends to insulate the metal from the electrolyte and reduce the amount of ions going into solution. In effect, the anode deposit or film increases the resistance of the electrochemical cell, and the cell is said to be anodically “polarized.” Similarly at the cathode, cathodic films are possible. In oxygen-deprived systems, for example, hydrogen gas may accumulate at the cathode, preventing further access of hydrogen ions and the consumption of electrons. The cathode reaction is therefore stifled, and the metal is said to be cathodically polarized. (Where oxygen levels are high enough, the cathode reaction occurs irrespective of the amount of H^+ ions, and in this case, the oxygen is said to have depolarized the cathode, allowing increased corrosion.)

The presence of these electrode films has a great effect on the rate of corrosion current transfer (i.e., the rate at which corrosion occurs). This can be illustrated in the resultant modification of the Ohm’s law Equation (102.3). Thus,

$$I = \frac{V}{R_{af} + R_{cf} + R_e} \quad (102.10)$$

where R_{af} and R_{cf} represent the resistances of the anode and cathode films, respectively. These resistances may be very high, and as such polarizing films build up, the rate of corrosion is greatly diminished (see Figure 102.2).

102.1.5 Electrode Film Breakdown and Depolarization

The permanence of such films has great significance to the control of corrosion of a specific metal. On aluminum, for example, under near neutral conditions, the naturally formed anode oxide film is very dense and insoluble (if thin) and quite resistant to mechanical removal. R_{af} becomes very high, and I becomes negligible. Aluminum, therefore, is quite resistant to corrosion under neutral conditions.

Where the environment is sufficiently acidic or alkaline, however, the oxide film on aluminum is chemically dissolved. Thus, the metal is stripped of polarizing film (depolarized) and corrodes rapidly, i.e., the cell reaction resumes its linear relationship between corrosion and time.

On other metals such as steel, the oxide film is normally less adherent and easily dislodged mechanically. Such physical removal of the oxide film has the same result as chemical removal, the corrosion rate

becoming more linear until additional corrosion product can repair the site of removal, and repolarization occurs. Mechanical agitation can also depolarize the cathode. If, under acidic conditions, the cathode, polarized with hydrogen gas, is rapidly agitated in the electrolyte, the physical shearing stresses will dislodge the bubbles of hydrogen, and the cathode will again be accessible to hydrogen ions from the electrolyte. Electrons will again be consumed, and corrosion will, as a consequence, increase.

If the secondary oxidative process on iron [see Equation (102.9)] can be engineered to occur rapidly and close enough to the anode, a more adherent, denser, and more permanent barrier film of hydrated ferric oxide will be formed across the anode. This effectively prevents further dissolution of the iron into the electrolyte and greatly increases the resistance of the anode film. Under these conditions, the metal behaves as if it were more noble than it actually is. This phenomenon is known as passivation, and the thin anode films involved are known as passive films.^{6,7}

102.1.6 Passivation and Depassivation

Certain materials such as chromates, phosphates, and molybdates are known to induce passivity artificially.⁶⁻¹⁰ These materials, known as corrosion inhibitors, if present as soluble ions within the electrolyte, will adsorb onto the metal surface, reinforce the natural oxide layer, and facilitate the passive state. Other materials, most commonly soluble chlorides and sulfates, effectively compete with inhibitive ions for adsorption onto the metal surface and tend to prevent passivity thereby.¹⁰ These salts are known as depassivating agents. The ratio of passivating ions to depassivating ions in any interfacial electrolytic environment will dictate the effectiveness of induced corrosion control.

Other factors will also affect the rate of corrosion. The passive state is more readily achieved under alkaline conditions, and, at high enough pH, oxygen alone will induce passivity without benefit of other inhibitors. Corrosion will increase on the other hand as the temperature of the system increases.

102.1.7 Area Effects

If the rate of corrosion is largely dependent upon the rate at which electrons from the anode are consumed by the cathode reaction, then the intensity of attack is dependent upon the ratio of the areas of cathode and anode sites (Figure 102.3).^{1,4} Where an anode is large compared to a given cathode, the effects of the corrosion current generated will be spread over the large anode area, so that corrosion is more general

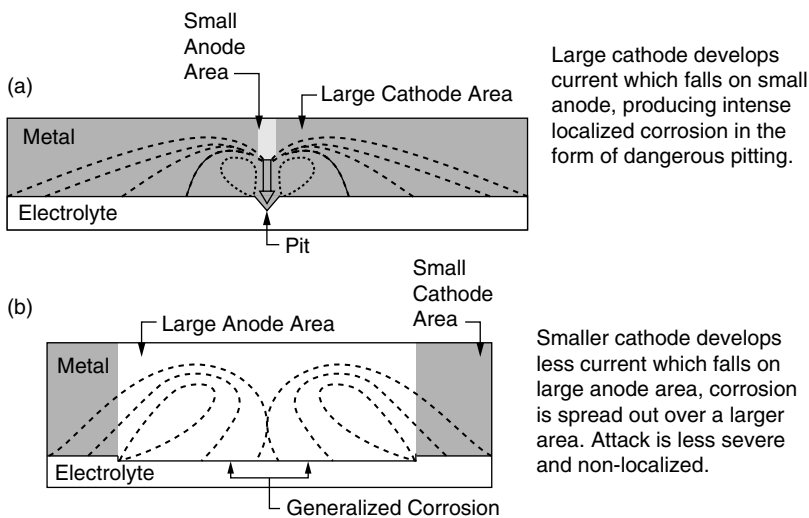

FIGURE 102.3 Area effects.

TABLE 102.2 Basic Techniques Employed in Corrosion Control by Coatings

Barrier coatings	Resistance inhibition; oxygen deprivation
Inhibitive pigments	Modification of interfacial environment (establishment of passive films)
Zinc-rich coatings	Prevention of current discharge from metal to environment by affixation of anode film

and attenuated. This type of corrosion, while undesirable, is not particularly dangerous. When the anode is small compared to the cathode, however, the current fall will be concentrated on a small area, and here corrosion will be intense. If the anode is small enough, this may lead to pitting attack, which is very dangerous and can perforate metal in a short time frame, especially where there is appreciable difference between anode and cathode potentials. Control of the area ratio is a most important consideration in corrosion engineering, and coating films may be effectively employed to modify this ration. Diminishment of the cathode area must always receive first priority in any design. Holiday detection, to eliminate anodic pinholes at which pitting may occur, is a critical quality assurance process in the application of barrier coatings.

102.2 Coatings

102.2.1 Corrosion Control by Coatings

Coatings play an important role in corrosion control, used either alone or as part of an overall strategy of corrosion control.¹¹ While theoretically, coatings may be employed in a variety of ways to modify, hinder, or thwart the corrosion reaction, three or four devices find practical application (see Table 102.2).

These devices are utilized in the three types of coatings employed in corrosion control.^{11,12} There are barrier coatings, functioning via resistance inhibition^{12,13,15,16} and/or oxygen deprivation,^{14,15} inhibitive coatings, functioning by modifying the interfacial chemical environment against the metal surface,^{7,8,9,11} and zinc-rich coatings, which prevent current discharge from the steel to the environment by employing a more anodically active metal (almost exclusively zinc) as a pigment at loadings high enough to ensure electrical contiguity with the substrate and low electrical resistance across the film.¹⁷

102.2.2 Barrier Coatings

It is a practical impossibility to prevent enough moisture transmission through even the densest films to control the cathode reaction by moisture deprivation.^{12,18,19} It is, however, possible by the use of impermeable barrier coatings to suppress both oxygen transmission and the transmission of ionic solutions to a sufficient extent that corrosion may be precluded.^{12,14,15,16} The prevention of oxygen access to the metal deprives the cathode reaction of critical fuel, and the film's resistance to ionic transfer renders any moisture that does access the substrate so high in resistivity that current transfer between the anodic and cathodic areas is frustrated (Figure 102.4).

Designing devices to utilize these precepts involves the use of molecularly dense films (highly uniform cross-linked thermosets and relatively crystalline thermoplastics).¹² These coatings are formulated with nonhydrophilic components and lamella pigments to give coating systems of high electrical resistance that maintain adhesion even under wet conditions.^{19,20} They are typified by fluoropolymers, highly cross-linked epoxies, and coal tar modified systems, pigmented with pigments such as aluminum flake.

Barrier coatings can be used alone or in combination with impressed current driven cathodic protection systems, where they act to minimize exposed cathode areas and thereby reduce the cost of required electricity that maintains the direction of current flow.¹¹ Barrier coatings can also be used to minimize cathode–anode area ratios in mixed metal systems where insulation is impractical, thereby eliminating pitting at exposed anodes.

Barrier coatings are widely used for extreme service such as the lining of water, fuel, food, and chemical storage tanks, for marine coatings, etc.

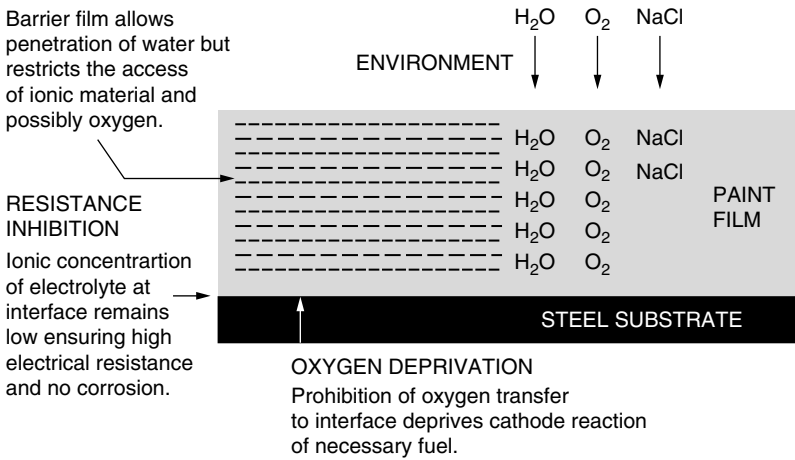

FIGURE 102.4 Corrosion control by barrier coatings.

102.2.3 Inhibitive Coatings

Inhibitive metal primers reduce corrosion by chemically modifying the interfacial condition against the metal.⁷⁻⁹ This is done by including pigments in the primer film that release oxidizing ions and other passivating moieties into the aqueous phase against the interface.¹¹ Reviews of pigments used in this manner may be noted in Refs. 21 and 22. In turn, this reduces the levels of electrolytic oxygen necessary to establish passive films on the metal⁵ beneath the coating (Figure 102.5). In order to minimize blistering and provide sufficient inhibitive ions to achieve long-term passivity without rapidly exhausting the available ionic reservoir (provided by the pigment), selection of both binder and inhibitive pigment is critical. Control of the PVC/CPVC is also important in order to maintain permeability so that there is sufficient moisture to access and dissolve enough inhibitive ions from the pigment in the film, but not so much that the film becomes too porous. Highly porous films will allow the transmission of depassivating ion species (chlorides and sulfates) into the film and through to the metal, there to compete with inhibitive ions for adsorption and so prevent passivation.^{9,11}

Inhibitive coatings are generally oleoresinous systems, oils, alkyds, epoxy esters, phenolic varnishes, etc., although epoxies and many latex primers also function by this mechanism. Inhibitive coatings are

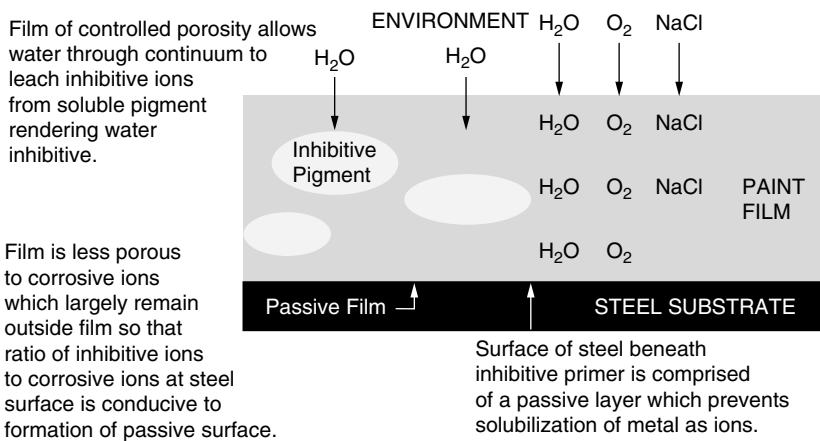

FIGURE 102.5 Corrosion protection by inhibitive primer.

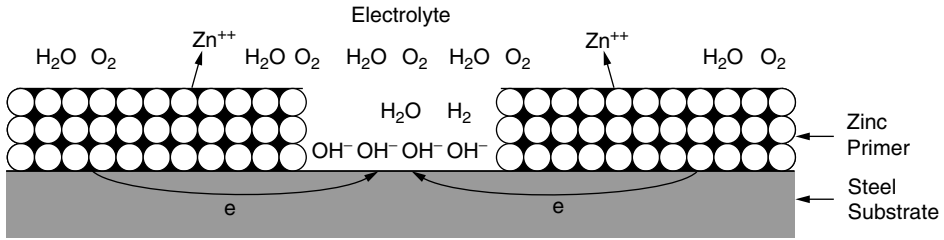

FIGURE 102.6 Fundamentals of zinc-rich protection. The presence of strongly electronegative zinc-pigmented coating short-circuits all local cell activity on steel. The steel becomes totally cathodic to the zinc anode. The zinc corrodes, but the steel will not corrode even at bare spots. It is mandatory that the zinc coating be in electrical contact with the steel surface; therefore, the steel must be stripped of all contamination.

generally used for light to moderate duty atmospheric service, although they may be part of relatively high performance systems such as automotive primers, aircraft coatings, and coil coating primers. They are generally not favored for long-term freshwater immersion service, however, or for continuous use under high-temperature, highly humid conditions.

The formulation of inhibitive metal primer is considered in several texts and papers.^{8,9,11,22,23}

102.2.4 Zinc-Rich Coatings

Zinc-rich coatings contain high loadings of zinc dust as a pigment and serve to prevent corrosion galvanically by acting as the anode of an electrochemical cell of which the steel substrate is the cathode (Figure 102.6).^{17,24} All local cell activity on the steel is thus overridden by the electrically proximate anodic primer, which itself corrodes sacrificially to protect the steel. Eventually the zinc surface becomes partially polarized with zinc corrosion product, and protection shifts to a quasi-barrier mechanism, as the corrosion product seals the porosities of the highly pigmented zinc film surface. Where organic binders (epoxies, high-styrene systems, moisture curing urethanes, etc.) are used, PVC/CPVC ratios must necessarily be adjusted to unity (or a little higher) in order to maintain the required conductivity (from pigment particle to pigment particle within the film and from pigment particle to substrate). This precept gives rise to exacting requirements in formulation, preapplication homogenization of the primer, and application itself. Too low a PVC will preclude cathodic protection; too high a PVC will result in weak films with poor mechanicals.²⁵

Inorganic binders such as alkaline silicates and alkyl silicates rely on chemical reaction of the binder with the zinc atoms on the surface of the zinc dust pigment, and probably the steel substrate also (during application and curing) to produce a wholly continuous, chemically bound, inorganic matrix of zinc silicate.^{17,26} While PVC/CPVC levels are somewhat less critical, high levels of zinc are still necessary to provide good cathodic protection over the long term. Although these films are more porous than are the organic zinc-rich systems, again the presence of water within the primer, even against the metal surface, is not threatening to steel, for zinc corrosion is its only consequence. As long as there remains sufficient zinc within the film, all oxidation must occur only within the film itself. Eventually zinc corrosion product packs the porosities and seals the film off as was the case with the surface of the organic zinc-rich film.

Zinc-rich primers are widely employed as nontopcoated systems in environments where the zinc corrosion product is not easily dissolved (i.e., in neutral environments). In such applications, inorganic zinc primers have protected steel for half a century and more. In other systems, especially where environments are either highly acidic or highly alkaline, and therefore reactive with the metal, both organic and inorganic zinc-rich primers are recoated with barrier topcoats (epoxies, vinyls, chlorinated rubbers, and urethanes) for additional protection.

References

1. F. L. LaQue and N. D. Greene, "Basics of corrosion," in *Corrosion Basics — An Introduction*. A. deS. Brasunas, Ed. Houston, TX: NACE, 1984, chap. 2.
2. J. C. Scully, "Aqueous corrosion," in *The Fundamentals of Corrosion*, 2nd ed. New York: Pergamon Press, 1975, chap. 2.
3. U. R. Evans, "Electrochemical corrosion," in *An Introduction to Metallic Corrosion*. London: Edward Arnold, 1963, chap. 11.
4. C. H. Hare, "Metallic corrosion," *J. Prot. Coat. and Linings*, 14(12), 74 (December 1997).
5. Z. W. Wicks, Corrosion protection by coatings, Federation Series on Coatings Technology, Federation of Societies for Coatings Technology.
6. M. Stern, "The mechanism of passivating type inhibitors," *J. Electrochem. Soc.*, 105(11), 638 (November 1958).
7. H. Leidheiser, "Mechanism of corrosion inhibition with special attention to inhibition in organic coatings," *J. Coat. Technol.*, 53(678), 29 (July 1981).
8. M. Svoboda and J. Mleziva, "Properties of coatings determined by anti-corrosive pigments," *Prog. in Org. Coat.*, 12, 251 (1984).
9. G. Salensky, "Corrosion inhibition," in *Handbook of Coatings Additives*. L. J. Calbo, Ed. New York: Marcel Dekker, 1987, chap. 12.
10. H. H. Uhlig, "Passivity," in *Corrosion and Corrosion Control*, 2nd ed. New York: John Wiley, 1971, pp. 76–79.
11. C. H. Hare, "Anticorrosive barrier and inhibitive primers," Federation Series on Coatings Technology. Philadelphia, PA: Federation of Societies for Coatings Technology, 1979.
12. J. E. O. Mayne, "Paints for the protection of steel — A review of research into their modes of action," *Br. Corros. J.*, May, 106 (1970).
13. R. C. Bacon, J. J. Smith, and F. M. Rugg, "Electrolytic resistance in evaluating protective merits of coatings on metal," *Ind. Eng. Chem.*, January, 161 (1948).
14. S. Guruviah, "The relation between the permeation of oxygen and water through paint films and corrosion of painted steel," *JOCCA*, 53(8), 669 (August 1970).
15. N. L. Thomas, "The barrier properties of paint coatings," *Prog. in Org. Coat.*, 19, 101 (1991).
16. W. Funke, "Towards environmentally acceptable corrosion protection by organic coatings," *J. Coat. Technol.*, October, 31 (1983).
17. A. C. Elm, *Zinc Dust Metal Protective Coatings*. Palmenton, PA: New Jersey Zinc Company, 1968.
18. A. S. Michaels, "Water and the barrier film," *Off. Dig.*, June, 638 (1965).
19. H. Leidheiser and W. Funke, "Water disbondment and wet adhesion of organic coatings on metal: A review and interpretation," *JOCCA*, May, 121 (1987).
20. W. Funke, "The role of adhesion in corrosion protection by organic coatings," *JOCCA*, September, 229 (1985).
21. M. J. Austin, "Anticorrosive inorganic pigments," in *Surface Coatings — Vol. I — Raw Materials and Their Usage*. P. Parson, Ed. London: Chapman and Hall, 1993, chap. 25, p. 409.
22. A. Smith, "Inorganic primer pigments," Federation Series on Coatings Technology. Philadelphia, PA: Federation of Societies for Coatings Technology, 1988.
23. C. H. Hare, "A review of inhibitive metal primers," *Mod. Paint and Coat.*, July, 26 (1996).
24. C. G. Munger, "Corrosion resistant zinc coatings," in *Corrosion Prevention by Protective Coatings*. Houston, TX: NACE, 1984, chap. 6, p. 129.
25. C. H. Hare et al., "Geometrics of organic zinc rich primers and their effect on pigment loadings," *Mod. Paint and Coat.*, 73(6), 30 (June 1983).
26. C. G. Munger, "Inorganic zinc coatings — past, present and future," *Mater. Performance*, May, 25 (1975).

103

Marine Coatings Industry

Jack Hickey

International Paint Company

Bibliography 103-2

Marine coatings are special-purpose coatings that are supplied to the shipbuilding and repair, offshore, and pleasure craft markets. The products used are diverse and unique and are formulated for severe climatic and immersion conditions.

As a result of these conditions, the coatings used must have maximum resistance properties to salt spray, constant seawater, and in the case of tankers, a broad range of chemicals. For these reasons, a substantial volume of products sold today are two-component epoxy primers, intermediate high builds, and tank linings.

Above-the-waterline finishes are still predominantly single-package alkyds or acrylics on commercial ships and offshore platforms. This is due to the subsequent ease of maintenance required. Similarly, single-pack alkyds, urethane-alkyds, and silicone-alkyds are predominant in the pleasure craft market, at least for hulls up to the 30- to 35-foot class.

Larger pleasure crafts are still painted with the single-pack finishes, but many such craft (yachts) are coated today with two-part aliphatic polyurethanes to achieve the best in gloss and gloss retention, abrasion resistance, and long-term durability.

The use of two-component products, whether applied to a ship's tanks or a yacht's topside, requires more professional applicators to achieve the best result. Such applicators must be familiar with multiple spray application equipment from the simple siphon cup to the sophisticated twin-feed heated airless spray.

Whether coating deep-sea ships, offshore platforms, or pleasure craft, one unique characteristic of the marine coatings industry is the need to protect the underwater surfaces from the attachment and growth of marine fouling organisms. These are living animals, algae or slime, that will adhere, colonize, and grow rapidly if not controlled through the use of antifouling coatings.

Antifouling paints are unique to this industry and make up approximately 50% of the total volume of coatings used. By their nature, in order to mitigate fouling attachment, antifouling paints contain biocides, which are registered with the U.S. Environmental Protection Agency (EPA) as pesticides under the Federal Insecticide, Fungicide and Rodenticide Act.

Subsequently, all antifouling paints must be both federally registered with the EPA and registered with the state EPA in which they are sold.

This unique class of product is expensive to develop, test, and register and thus is expensive for the customer. Most antifouling paints contain rosin (gum or wood) as part of the vehicle and a copper compound—cuprous oxide being the most common — as the biocide.

Some antifoulings are based on organotin-copolymer resins, which are biocidally active polymers along with a copper compound. These are generally the best-in-class for complete fouling control.

Unfortunately, the new ship construction industry in the United States is dramatically reduced compared to 20 to 25 years ago. Although there are still new construction shipyards, the volume of construction is primarily military with most commercial construction being done elsewhere.

Where ship construction is still active, zinc-rich primers, silicates, and epoxies are still prevalent for steel protection from corrosion.

In the pleasure craft industry, the most prevalent construction material is fiber-reinforced polyester (FRP) and polyester resin gelcoats.

In the shipbuilding/repair/offshore and pleasure craft market sectors, today's product technology is not driven simply by performance requirements but jointly with regulatory demands. The Clean Air Act and its amendments now control the volume of organic solvents (volatile organic compounds, VOCs) emitted, the chemical composition of the emitted compound (hazardous air pollutants, HAPS; ozone depleting substance, ODS), and airborne particulates.

These regulatory demands, coupled with the ever-increasing desire to minimize coating frequency, place heavy technical emphasis on the marine coatings industry and will continue to do so in the near future.

The marine coatings industry represents less than 10% of the total volume of paints sold in North America. Of this, the volume is split between commercial marine (primarily maintenance, military, pleasure craft, and offshore). The trends for volume increase are overall fair, with the bulk of the increase due to maintenance and repair.

There are several major suppliers that provide the majority of the marine coatings sold in North America. These include Courtaulds' Coatings, DeVoe & Reynolds, Ameron, Kopcoat, Hempel, and the latest entry, Sherwin Williams.

Bibliography

- N. I. Gaynes, *Formulation of Organic Coatings*. New York: Van Nostrand Reinhold, 1967.
- C. R. Martens, *Technology of Paints, Varnishes and Lacquers*. Huntington, NY: Robert Krieger, 1968.
- P. Nylén and E. Sunderland, *Modern Surface Coatings*. New York: Wiley Interscience, 1965.
- D. H. Parker, *Principles of Surface Coatings Technology*. New York: Wiley Interscience, 1965.
- P. Swaraj, *Surface Coatings Science and Technology*, 2nd ed. New York: John Wiley, 1996.
- G. P. A. Turner, *Introduction to Paint Chemistry and Principles of Paint Technology*, 3rd ed. London: Chapman & Hall, 1988.

104

Decorative Surface Protection Products

104.1	Introduction	104-1
104.2	History	104-1
104.3	Products.....	104-2
	Primary Substrate or Base Sheet • Pigmented Coating for Decorative Printing • Release Paper • Release Coatings • Pressure-Sensitive Adhesives	
104.4	Process of Manufacturing	104-5
	Application of Release Coatings • Adhesive Coating Application Process • Finishing	
104.5	Applications.....	104-7
	References	104-8

Jaykumar (Jay) J. Shah
Decora

104.1 Introduction

Decorative surface protection products, as the term suggests, are products that provide both decoration and protection to a wide variety of surfaces. These products are available to consumers in a variety of colors, decorative designs, and surface finishes. They are attractive, durable, washable, waterproof, and resistant to stains from food, beverages, and common household items. They must be conformable to a wide variety of surfaces, requiring no tools, water, or paste to be applied to any plain surface.

In most cases, they have informative and instructional carriers traditionally known as printed release liners, which are affixed by a flexible pressure-sensitive adhesive to a base sheet, also known as a primary substrate or a face stock. In some cases, the release liner has been eliminated by using an embossed primary substrate. Alternatively, the primary substrate may have been coated on one side with a release coating and on the other side with a low tack adhesive.¹ These products are known as self-wound adhesive coated decorative sheets. They are made in solid colors, decorative prints, and textured woodgrains.

104.2 History

Pressure-sensitive adhesive usage in making decorative surface protection products goes back to the early 1950s. Similar types of vinyl film were used by consumers on products such as printed and laminated tablecloths and printed draperies. The idea of printed film led to the making of decorative surface protection products by a low tack, pressure-sensitive adhesive on printed film.

The construction of decorative products is shown in [Figure 104.1](#).

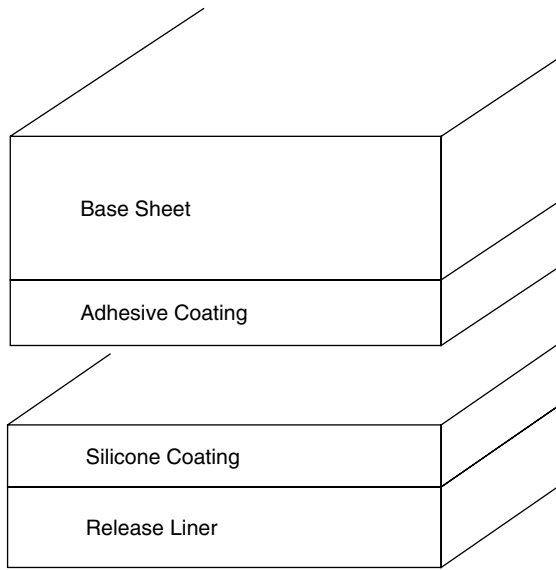

FIGURE 104.1 Construction of decorative products.

104.3 Products

The manufacturer planning to bring out a new product has many varieties to choose from. He should consider not only the physical, chemical, and thermal properties, but also the cost and ease of the processing method. The key to selecting the right material may be good communication between the processor and the material suppliers. The more rigid the specifications covering end use, the easier selection becomes.

104.3.1 Primary Substrate or Base Sheet

Typical substrates used are calendered plasticized vinyl films, extruded homo- or copolymers of polyolefin films, metallized polyolefins and polyester films, preimpregnated papers, treated cloth, and nonwovens.

Plasticized vinyl films have a dominant position as a decorative film product. These films are usually manufactured by the calendaring process. The method of making such films is discussed in detail by Reip.² Abrasion and stain resistance coupled with unlimited coloring and design possibilities have made vinyl films one of the largest base sheets in the decorative coated product field.

Films extruded from homo- or copolymers of polyolefin are flexible but tough and durable, moisture proof, and grease resistant. The film industry, through recent coextrusion techniques, is producing single- and multiple-ply laminated polyolefin films that are printable, dimensionally stable, and opaque or clear. These materials are becoming more popular because of their lower cost.

Cotton or cotton-polyester fabrics were used earlier because they are more durable, tough, moisture proof, and washable, as well as more easily printable than films. However, they are not as flexible and conformable as films. Their higher cost has made them less popular. They have been replaced in some applications by supported or unsupported nonwovens made from natural or synthetic fibers.

Decorative products made with printed and metallized polyester or polypropylene films provide brightness and contemporary design. Their use is limited because of more difficult handling and higher cost.

Impregnated paper has been used more recently because of its low cost. Self-wound decorative products have been made using such paper. Because impregnated papers are printable and can be made self-wound, they have more applications. However, papers tear easily and are not as flexible as films, limiting their application.

TABLE 104.1 Criteria to Select a Qualified Supplier for Base Sheet

Composition of Film
<i>Physical Properties</i>
Tensile strength
Elongation
Modulus
Tear strength
Dimensional stability ASTM D-1204 methanol (both machine direction and cross direction)
Opacity
Volatiles content
Surface finish (gloss)
Hardness
(Color)
<i>Routine Tests</i>
Opacity
Color
Gloss
General observation to check hand, voids, pinholes, gel particles, dimensional stability, roll counter, roll profile
Width and length roll

The criteria to be considered to qualify a supplier for the base sheet and routine tests performed in accepting base sheets from qualified suppliers are described in Table 104.1.

104.3.2 Pigmented Coating for Decorative Printing

An organic coating is made up of two principal components, a printable vehicle and a pigment. A vehicle is a film forming ingredient that enables the coating to convert from a mobile liquid to a solid film. It acts as a carrier and suspending agent for the pigment. The pigments are the coloring agents.

Vehicles or extenders are composed of film forming materials, thinners (solvents), and water or water-solvent mixtures that control viscosity, flow, and coating thickness, as well as driers, which facilitate application and improve drying qualities. Most common vehicles are made from acrylics and vinyl-based resins.

Pigments serve a decorative function. Closely associated with color is the hiding power function. There are white hiding pigments, colored pigments, and inert pigments. White pigments are used in making white bases for tinted and light shades. Colored pigments furnish the opacity and color of the finish. Earth-colored pigments are stable and are resistant to attack by heat, light, chemicals, and alkalis. The extender pigments used in the coating help control consistency, gloss, and smoothness, and leveling and filling qualities. They are chemically inactive.

Table 104.2 describes the characteristics that would be considered for qualifying a proper printing ink and routine tests performed on printing ink. The majority of base sheets and release papers can be printed by a direct gravure or rotogravure printing method. Flexographic printing and screen printing methods are also used in some cases.

104.3.3 Release Paper

Usually a bleached, semibleached, or unbleached high internal strength kraft paper is used. The most common types of paper used are sized machine-grade or machine finished. There are some products that use supercalendered-grade and polyethylene-coated kraft paper. Some European and Asian manufacturers have used parchment or glassine-grade paper because of cost and ease of availability. The paper should exhibit exceptional smoothness and should have uniform thickness. Most paper used has a thickness of 2 to 3 mils. It should retain a minimum moisture of 3 to 4% for better runnability and to keep from tearing.

TABLE 104.2 Characteristics for Qualifying a Printing Ink

Qualifying Tests	Routine Tests
Blocking	Viscosity
Cracking	Solids content
Drying	pH (if waterborne)
Color in half-tone	Weight per gallon
Color in masstone	Opacity
Color strength	Gloss
Hiding strength	Color in masstone (proof press)
Gloss	Blocking
Viscosity	Adhesion (tape test)
Pigment content	Color match to standard
Cell clean-out	
Scratch resistance	
Orientability	
Weight per gallon	
Foaming	
pH (if waterborne)	

TABLE 104.3 Criteria for Selecting a Release Paper*For Better Runnability*

Tensile strength (dry and wet), in machine and cross directions

Moisture content

Elmendorf tear

Mullen burst strength

Porosity

Caliper

Basis weight

For Better Coatability

Sizing in paper for better silicone holdout

Surface finish for better printability

Heat resistance and shrinkage resistance for better dimensional stability while drying coatings

Smoothness and porosity for better release coating

Good formation to minimize cockling tendency

Routine Physical Tests on a Qualified Paper

Caliper

Basis weight

Mullen burst strength

Tensile strength in machine and cross directions

Tear strength in machine and cross directions

Surface smoothness

Porosity

Color

Characteristics to be considered for selecting a paper and routine physical tests are listed in Table 104.3.

104.3.4 Release Coatings

Silicones are the most widely used materials for release coating applications. They give a low level of release and are useful for coating the release paper.

The basic chemistry and physical properties of silicone release coating are described in detail by Mary D. Fey and John E. Wilson.³

104.3.5 Pressure-Sensitive Adhesives

Although pressure-sensitive adhesive clearly takes a position of secondary importance in most products, careful selection of the adhesive should be an important function of a researcher.

The main function of the adhesive is to provide affinity to both the release liner and the base sheet used on these products. The adhesive should allow the base sheet enough time to move around the surface before bonding permanently. Another important function of the adhesive is to provide plasticizer migration resistance specifically when a plasticized vinyl film is used as a base sheet.

Another method of demonstrating improved pressure-sensitive properties is to compare the rate of buildup of peel adhesion to various surfaces with other candidates. The adhesive should provide good heat and humidity resistance and also better shrinkage resistance in the finished products.

Acrylics and vinyl-acrylic based pressure-sensitive adhesives appear to be the most promising compounds because of their UV and thermal stability and higher plasticizer migration resistance properties. These adhesives also provide better shrinkage resistance on the release papers and after the product is mounted on various surfaces. Basically, these adhesives have the versatility to adhere to a variety of surfaces. These adhesives are available in the forms of solutions and aqueous emulsions.

Several patents have been issued claiming the use of such adhesives on the decorative products.

Vinyl-acrylic adhesives for vinyl films have been suggested by R. L. Burke Jr.⁴ The patent claims that adhesives of these types substantially eliminate migration of the plasticizers from vinyl films and thereby eliminate film shrinkage during aging.

Vinyl methyl ether based adhesives, as suggested by Helmut J. Mueller of BASF,⁵ reduce the drop in adhesion strength caused by plasticizer migration. This phenomenon is due to the good compatibility of the vinyl methyl ether polymers with a great variety of solvents and plasticizers.

A new acrylic family is being developed specifically for low energy level surfaces such as polyolefin films.⁶

104.4 Process of Manufacturing

104.4.1 Application of Release Coatings

There are two basic types of converting operation for silicone release coatings: the off-line and the in-line coatings. In an off-line coating, only the silicone coating is applied, as shown in Figure 104.2. The adhesive and the base sheet are married to the release-coated liner in a subsequent operation.

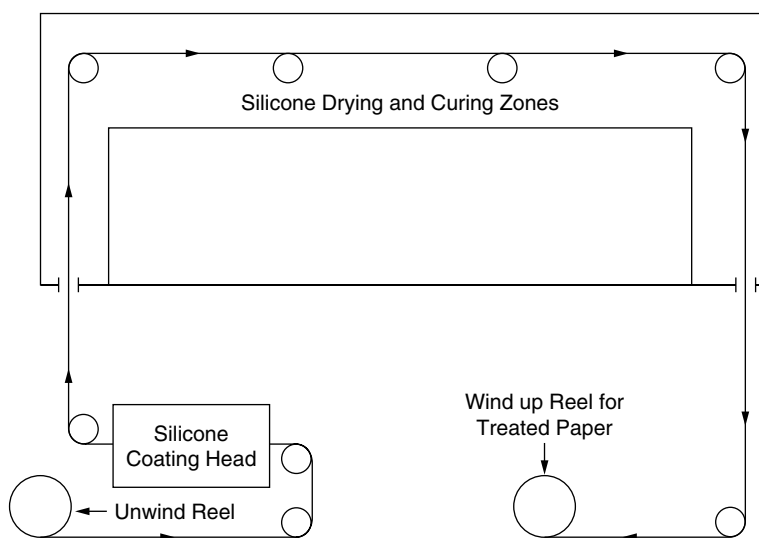

FIGURE 104.2 Off-line silicone coating.

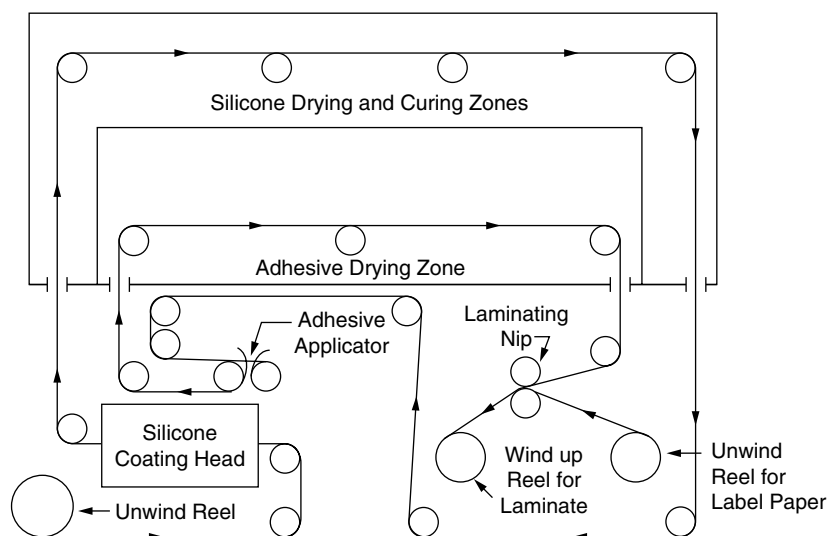

FIGURE 104.3 In-line silicone/adhesive coating and lamination.

In the in-line operation there may be multiple coating heads and a laminating station. The entire product is made in one continuous operation. First, the silicone release coating is applied and cured. Then the adhesive is applied to the release-coated substrate and dried. Finally, the base sheet is laminated to the adhesive-coated release liner. This operation is shown in Figure 104.3.

The line speed for off-line production of silicone coatings is usually faster than the in-line silicone coating operation. Line speeds are usually slower for in-line operations and depend on the adhesive drying rate, the length of the oven, and the efficiency of the drying oven. Silicone release coating is applied by different coating methods, such as direct gravure, wire-wound rods, air knife, and the offset gravure. The majority of solvent silicone release coatings are applied by the wire-wound rod or air knife methods.

Virtually all solventless silicone release coatings are applied by the three- or four-roll offset gravure or smooth roll coating method.

104.4.2 Adhesive Coating Application Process

Coating of solvent- or waterborne adhesives can be carried out by several different methods. The most commonly used methods of coating pressure-sensitive adhesives are direct gravure, wire-wound rod, reverse roll, direct roll, and knife-over-roll. Normally the reverse roll, direct roll, and knife-over-roll methods are used for high viscosity adhesive applications. The direct gravure and wire-wound rod methods are used for lower viscosity adhesives. The adhesive coating weights on these products may range from 0.2 to 1.0 oz/yd.² The adhesive is usually transfer coated. Transfer coating eliminates the need for exposing heat-sensitive substrates such as vinyl and olefin films to higher heat drying ovens.

104.4.3 Finishing

The finished product from coated rolls is slit into several popular widths and lengths. All these products are slit either in-line or off-line. The most common slitting method is score knives, but the shear slit method is also used in some applications. The finished product is then tested. Table 104.4 describes the most common tests that may be applicable to the end-use requirements.

TABLE 104.4 Routine Tests for Finished Products from Coated Rolls

Peel adhesion (0 min, 20 min, 24 h dwell) to
Varnished wood
Acrylic plastic sheet
Glass
Various other plastic surfaces
Stainless steel
Unpainted wallboard
Adhesive-to-adhesive anchorage
Release values from release liner
Adhesive coat weight
Total thickness
Free shrinkage at 158°F for 24 h
Mounted shrinkage at 110°F for 7 days
Tensile strength
Elongation

104.5 Applications

The primary purpose of these products is to beautify surfaces and fulfill aesthetic objectives. Besides decorating, the products protect surfaces and keep them clean. They repair, refinish, and transform worn surfaces from floor to ceilings, as well as windows, doors and walls, furniture, jewelry boxes, books, and an unlimited number of other surfaces.

Some of the specialty decorative adhesive-coated products described here can solve specific household and office problems.⁷

“Frosty look” products are made from embossed translucent film that looks like frosted glass. The film lets light come through, but shuts out unattractive views. It can be applied to any window or clear surface, and offers privacy in applications from shower stall doors to office partitions.

Transparent film products are exceptionally useful because of their unique see-through properties. They are excellent for book covers, covering recipe cards, mending torn pages, sealing valuable documents, protecting pictures in photo albums, and similar applications. They are also good for windowsills, splash areas, and nursery areas, and for temporarily protecting glass, metals, and plastic while products made of these materials are handled in transit.

“Velvet look,” known as “cushion all” products, with a velvety nylon surface, protect carpets from furniture dents and furniture from scratching. Other uses include lining jewelry drawers and boxes, tools and sewing boxes, and covering surfaces for a decorative effect. These products are good for craft work and for decorating walls, furniture, or the inside of picture frames.

“Stained glass look” and “leaded glass look” products are meant to provide a beautiful glowing radiance to any room. Light comes through the brilliant colors of these translucent and colorful patterns. The products are especially good for Christmas decorations or for problem windows year round.

“Quilt soft” products are attractive quilted materials providing protection from mildew and moths. They consist of two layers of film, softly padded with fiberfill and then quilted, and are used to line drawers and vanities, closets, and pad shelves. They provide a soft touch of luxury at low prices.

“Woodgrain vinyl” decorative products, available in a variety of patterns, add a new dimension of depth and beauty to furniture, walls, and shelving. They are woodlike patterns that are hard to distinguish from real wood. They are decorative and useful for splash areas.

“Burlap” products are available in various solid colors and add warmth of texture. Made from fabric combined with burlap, they are good for walls, corners, headboards, and bulletin boards.

Metallized or foil-based products can make any room in the house glitter with light. They can cover canisters, trays, boxes, desk accessories, lamp shades, books, table tops, wall panels, and furniture panels. Available in various designs and colors, these products reflect a contemporary mood.

“Wet look” products are designed to go slickly onto walls or lend a glossy sheen to furniture and accessories.

Some of the films and paper-backed products also have added fragrances, so the products not only decorate surfaces but also bring fresh flavor into the room.

This is not an all-inclusive list but an illustration of uses, provided for the reader’s interest in hopes of furthering understanding of the versatility of such products in fulfilling market needs.

References

1. M. C. Funk and E. A. Rugalska, Jr., U.S. Patent 3,575,788 (April 20, 1970).
2. H. Reip, *Adhes. Age*, 15(3), 17–23 (1972).
3. Mary D. Fey and John E. Wilson, in *Handbook of Pressure-Sensitive Adhesive Technology*, D. Satas, Ed. New York, Van Nostrand-Reinhold, 1982, chap. 18.
4. R. L. Burke, Jr., U.S. Patent 3,547,882 (December 15, 1970); United Merchants and Manufacturers.
5. Helmut J. Mueller, in *Handbook of Pressure-Sensitive Adhesive Technology*. D. Satas, Ed. New York, Van Nostrand-Reinhold, 1982, chap. 14, p. 340.
6. W. J. Sparks, “Advances in hot melt and waterborne acrylic PSAs,” *Adhes. Age*, 25(3), 38 (1982).
7. Comark Plastic, Division of United Merchants and Manufacturers, “Ideas to Help You Sell More,” 1967–1981, retail sales manuals.

105

Coated Fabrics for Protective Clothing

N. J. Abbott

*Albany International Research
Company*

105.1	Introduction	105-1
105.2	Protection from What?	105-1
105.3	Coating Materials.....	105-2
	Coating Types • Method of Application • Properties	
105.4	Markets and Standards	105-4
	Bibliography	105-4

105.1 Introduction

Our need for protection from the environment in which we live or work is becoming ever more complex and demanding. We can travel easily to any part of the earth, even to the vacuum of space, and we expect to be able to live more or less normal and active lives no matter where we are or what we may wish to do. We have become more conscious of the potential dangers that surround us at home and at work, and we expect some protection from hazards that only a short time ago were thought of as risks that our way of life required us to accept without question. Consequently, we have recently seen advances in the design of a wide range of protective clothing of ever higher levels of sophistication, made possible by the continuing development of new materials capable of providing improved protection from many threats to our well-being.

Protective clothing is commonly designed to isolate the body from its surroundings through the use of an assembly that includes as one of its components a continuous film, either in the form of a coating or a lamination. This is essential whenever resistance to absorption or penetration of a liquid is required, and is often used also for gases, though these can sometimes be adsorbed or chemically modified in a layer that may not be totally impermeable. Often a structure designed to provide protection from a nonfluid threat — cold, for example — will function effectively only if it remains dry. Some degree of resistance to wetting may be provided by giving the fibers a water-repellent treatment. But totally effective resistance to the penetration of water into the structure requires that a film be added to the assembly, which provides improved wind resistance but otherwise plays only a secondary role in providing protection from cold.

Coating or laminating, then, is widely used in protective clothing, and the properties of the films, as well as how they are incorporated into the clothing assembly, are of prime importance to the production of an acceptable garment.

105.2 Protection from What?

Perhaps our most universal need is for protection from rain and cold. Other needs are more specialized, and generally apply only to that segment of the population whose livelihood exposes them to annoyances

or dangers most of us seldom encounter. Firefighters, for example, and some industrial workers, confront sources of extreme heat which, without suitable protective clothing, could be life-threatening. Other workers run the risk of having molten metal splashed on them from a smelter or a welding operation. Many must handle toxic or corrosive liquids, or be exposed to toxic fumes in the course of their daily work. Farmers and other agricultural workers handle potentially dangerous chemicals in the form of fertilizers or pesticides. Those responsible for handling waste products from manufacturing operations run the risk that some of those products may be dangerous if handled improperly. Butchers and foresters need special protection against cutting because of the tools they must use. People working with viruses, bacteria, or other sources of infection, divers who must work underwater for extended periods of time, astronauts exposed to the vacuum of space, or people who run the risk of being exposed to x-ray or other electromagnetic or nuclear radiation may need virtually total isolation from their surroundings. Even football and hockey players must wear special protective pads to minimize the risk of injury.

The list of hazards from which we may want to be protected without serious impediment to our capability of performing necessary tasks is almost endless. Fortunately, the number of materials that can be used in protective clothing is also large, and the diversity of their characteristics is growing rapidly. Protection can now be provided against most threats, but not without some associated problems (see Chapter 106). To some extent, the protection can be obtained simply from the use of the right fiber in an appropriately designed garment. For the most part, however, fiber or fabric coatings are used to obtain the desired isolation of the body from a threat in the surrounding atmosphere.

105.3 Coating Materials

105.3.1 Coating Types

Any compound that can be applied to the surface of a fabric is a candidate for use in protective clothing. Because each application has its own set of requirements, most coating materials will find a use for which they are suited. Consequently, the designer of protective clothing has a broad material base to work from. Unfortunately, however, the task of choosing the best material for a specific purpose is not as simple as looking up a table of properties in a handbook.

Fabric coatings are seldom composed of a single chemical compound. Rather, they are formulated as a mixture of many ingredients, each designed to provide or improve a particular characteristic. Additives may include viscosity modifiers to assist in application; reaction modifiers to accelerate or retard setting during processing; hardness modifiers; flame retardants; ultraviolet absorbers; antioxidants; surface friction modifiers; abrasion resistance enhancers; pigments to provide color or modify appearance; light and heat reflectors; inert fillers to provide bulk or opacity, or to reduce cost; compounds or chemical modifications to increase water vapor permeability; and even copolymers or polymer mixes as major property modifiers. Consequently, although the characteristics of the major coating types can and should be considered, it must be clearly understood that significant changes in these characteristics can be achieved through proper formulation.

Coating types that are used in protective clothing include acrylic, butyl rubber, cellulose acetate, fluorocarbon, fluorosilicone, chlorosulfonated polyethylene (Hypalon), chloroprene (neoprene), polyamide (nylon), polyester, polyolefin (polyethylene, polypropylene), polyurethane (polyester and polyether types), polyvinyl chloride, silicone, vinyl acetate, and various metals (particularly aluminum).

105.3.2 Method of Application

Generally, coating materials are formulated for a specific method of application. Some may be best applied by blade coating; others are for calender coating; some must be used as films, either by a film lamination technique or in transfer coating; some are designed for extrusion coating; some for dip or saturation coating; some require solvent systems; some are water-based; and some are 100% solids.

105.3.3 Properties

The following general information indicates typical properties of the base polymer in each case. As discussed above, these properties often can be significantly altered by chemical modification and the use of additives.

A general statement may be made about the range of temperatures within which these coatings are useful. The upper limit of this range is determined by the temperature at which the polymer softens, melts, or starts to decompose; it is unaffected by additives, though it may be altered by chemical modification of the polymer chain. The lower limit may be modified somewhat by formulation or chemical modification. In general, most of these polymers stiffen as the temperature is reduced, few remaining usefully flexible below about -40°C . Exceptions to this are the fluoropolymers and silicones.

105.3.3.1 Nonmetallic Coatings

Acrylic. Useful temperature range -30 to 175°C . Poor chemical resistance, fair abrasion resistance, good sunlight resistance. Ignites and burns without additive protection. Moderate cost.

Butyl Rubber. Useful temperature range -50 to 120°C . Poor chemical resistance to aromatic or chlorinated hydrocarbons, otherwise fair to good. Good abrasion and sunlight resistance, poor flammability resistance. Low to moderate cost.

Cellulose Acetate. Useful temperature range -20 to 120°C . Good chemical resistance to hydrocarbons, otherwise fair to poor. Fair abrasion and sunlight resistance, poor flammability resistance. Low cost.

Chlorinated Polyethylene. Useful temperature range -40 to 160°C . Good chemical resistance except to chlorinated hydrocarbons and some other organics, excellent abrasion resistance, good sunlight resistance, burns but is self-extinguishing. Moderate cost.

Fluorocarbon. Useful temperature range -130 to 260°C . Excellent chemical resistance, fair abrasion resistance, excellent sunlight resistance; does not ignite or burn in air. High cost.

Fluorosilicone. Useful temperature range -70 to 200°C . Excellent chemical resistance, poor abrasion resistance, excellent sunlight resistance; does not ignite or burn in air. High cost.

Polyamide. Useful temperature range -40 to 120°C . Good chemical resistance except to acids and aromatic hydrocarbons. Excellent abrasion resistance, poor sunlight resistance; melts and burns. Moderate cost.

Polychloroprene. Use temperature range -40 to 120°C . Good chemical resistance except to chlorinated hydrocarbons. Good abrasion and sunlight resistance; burns but is self-extinguishing. Low to moderate cost.

Polyester. Useful temperature range -40 to 120°C . Good chemical resistance except to chlorinated hydrocarbons, alkalies, and organic acids. Good abrasion and sunlight resistance; ignites and burns. Low to moderate cost.

Polyolefin. Useful temperature range -70 to 120°C . Poor chemical resistance to chlorinated hydrocarbons, otherwise fair to good. Good abrasion resistance, excellent sunlight resistance; ignites and burns. Low cost.

Polyurethane. Useful temperature range -50 to 120°C (depending on the type — this is a class of polymers covering a wide range of properties). Excellent chemical resistance to aliphatic hydrocarbons, otherwise fair, although polyether types have good resistance to organic chemicals. Excellent abrasion resistance, fair to good sunlight resistance; ignites and burns without additive protection. Moderate cost.

Polyvinyl Acetate. Useful temperature range -20 to 100°C . Poor chemical resistance except to alkalies. Poor abrasion resistance, good sunlight resistance; ignites and burns. Low cost.

Polyvinyl Chloride. Useful temperature range -20 to 100°C . Fair to poor chemical resistance except to aliphatic hydrocarbons, alkalies, and inorganic acids. Good abrasion and sunlight resistance; ignites and burns without additive protection. Low cost.

Silicone. Useful temperature range -115 to 320°C . Good chemical resistance to acids and alkalis, otherwise fair to poor. Poor abrasion resistance, excellent sunlight resistance; chars but does not burn. High cost.

105.3.3.2 Metallic Coatings

The most common metal coating consists of aluminum that has been vacuum coated or otherwise deposited on a thermoplastic film, which is then thermally bonded to the fabric surface. Its function is to reflect infrared radiation. Consequently, its high reflectivity (95%+) must be retained through use. Its tendency to retain oily soils and to become brittle and flake off through flexing are problems that have never been satisfactorily overcome. Other metals, such as gold, silver, and nickel, are also used for special purposes.

105.4 Markets and Standards

The markets for protective clothing are small (by textile standards) and fragmented, because of the highly specialized nature of the individual needs addressed. Often the desired protection can be provided only by ingenious design, particularly of seams, closures, and means of ventilation. Consequently, protective clothing tends to be more expensive than conventional clothing, and consumer resistance to its use because of its awkwardness or lack of comfort further limits market size. However, a great deal of effort is going into the development of more satisfactory materials and innovative clothing design and manufacturing techniques, and we can confidently expect this to be a market of growing importance.

The need for standardization, particularly of testing procedures, is being answered by technical studies, as well as by the work of groups such as Committee F-23 on Protective Clothing of the American Association for Testing and Materials.

Bibliography

- Barker, R. L., and G. C. Coletta, Eds., *Performance of Protective Clothing*, symposium in Raleigh, NC, July 16–20, 1984. ASTM Committee F-23, ASTM Special Technical Publication 900, 1986.
- U.S. Department of Commerce, *Protective Clothing: Arctic and Tropical Environments* (January 1970–July 1987). NTIS, PB87-854542/RPS, 1987.
- U.S. Department of Commerce, *Protective Clothing: Fire and Radiation Environments* (January 1970–January 1988). NTIS, PB88-856950/RPS, 1988.
- U.S. Department of Commerce, *Protective Clothing: Industrial Environments* (January 1985–January 1987). NTIS, PB87-854147/RPS, 1987.
- U.S. Department of Commerce, *Protective Clothing: Survival, Aircraft and Combat Environments* (August 1981–December 1987). NTIS, PB8-854666/RPS, 1988.

106

Coated Fabrics for Apparel Use: The Problem of Comfort

N. J. Abbott

Albany International Research Company

106.1 The Physiology of Heat Regulation..... 106-1

106.2 Vapor Permeability Requirements 106-2
Breathable Films

Bibliography 106-3

Coatings or laminated films are commonly used in apparel fabrics to provide protection from wind, water, or other fluid (see also Chapter 105), or sometimes simply to answer the dictates of fashion. Almost any type of coating material may be used, particularly by the fashion designer, whose choice may be determined more by aesthetic considerations than by functionality or serviceability. But whenever a continuous coating is used in clothing, no matter what its type or purpose, there is one common problem: people are likely to find the clothing uncomfortable if worn for long periods of time, or during vigorous activity.

106.1 The Physiology of Heat Regulation

“Comfort” can be defined very simply and precisely. We feel comfortable when the temperature of our skin is within about 1° of 34°C and, of course, the physiology of our body controls that temperature very effectively under normal conditions. If there is a change in the ambient conditions or in any other factor, such as a reduction in physical exertion, which lowers the skin temperature, blood flow to that part of the body is increased. If, on the other hand, the skin temperature increases, there is an increase in the output of perspiration which, by its evaporation, produces a cooling effect. Activity levels that do not adversely affect our comfort, therefore, are those for which the body’s mechanisms can control skin temperature without the accumulation of liquid sweat on the skin.

Moisture is carried away from the skin by two mechanisms: by evaporation at the skin and transmission of that vapor through the clothing (as vapor); and by absorption of liquid water into the clothing. While the second mechanism is useful in keeping the skin dry, it is of little value as a cooling device. Temperature control is best achieved through evaporation of perspiration from the surface of the skin.

The amount of heat (provided by the body) required to evaporate 1 g of liquid perspiration from the skin at 34°C, and to dissipate it into the surrounding atmosphere, assumed for the purpose of this example to be at 27°C, 50% relative humidity, has been stated to be

$$E_T = L_{34} + E_C + E_V$$

where

L_{34} = latent heat of vaporization of water at 34°C = 578 calories

TABLE 106.1 Metabolic Rates, Perspiration Production, and Vapor Permeability Requirements for Various Levels of Physical Activity

Activity	Metabolic Rate (W)	Water Evaporation Rate (g/24 h)	Vapor Permeability Rate (g/m ² /24 h)
Sleeping	60	600	200
Sitting	100	3800	1300
Gentle walking	200	7600	2500
Active walking	300	11,500	3800
Active walking on the level, carrying a heavy pack	400	15,250	5000
Active walking in the mountains, carrying a heavy pack	600–800	23,000–30,000	8000–10,000
Very heavy work	100+	3800+	13,000+

E_C = heat required to expand the vapor from 34°C, 100% RH, to 27°C, 100% RH = 9 calories

E_V = heat required to expand the air containing the evaporated water in order to reduce its relative humidity from 100% to the humidity of the ambient air, 50% = 23 calories

Hence, the total cooling energy derived from evaporating 1 g of liquid perspiration and dissipating it into the surrounding atmosphere is

$$E_T = 578 + 9 + 23 = 620 \text{ calories}$$

This is true only, of course, if the clothing is capable of transmitting the vapor to the ambient atmosphere without a change of phase or of temperature (other than that provided for in the calculation). It is clear, then, that the moisture vapor permeability of the clothing must be high enough to pass vaporized perspiration at the rate at which it is being produced at the skin.

106.2 Vapor Permeability Requirements

Any estimate of the vapor permeability requirements of clothing must be based on estimates of a number of factors that depend on body size and physiology. Since these vary significantly from individual to individual, and even for one individual from one time to another, no precise values can be given. One of those factors consists of the metabolic rates corresponding to various levels of physical activity. Representative values of metabolic rates are shown in Table 106.1. Some of this metabolic energy is used to perform the work that is being done. Most of it, however, is turned into heat, which must be dissipated. Some of this is expelled in respiration. The remainder must be dissipated through the evaporative cooling mechanisms discussed above. Depending on the design of the clothing, some portion of the vaporized perspiration may reach the surrounding atmosphere directly through vents in the clothing by means of a bellows-type action. The remainder must pass through the clothing fabric as vapor. Table 106.1 gives values for the required vapor permeability of the fabric, based on representative values of all these variables, as well as of the total surface area of the clothing.

It has been suggested that clothing that is to be worn during periods of physical activity have a moisture vapor permeability of 6000 grams per square meter per 24 hours. Even the densest uncoated sportswear fabric easily meets this requirement. The addition of an impermeable coating, however, reduces the permeability to a level often not more than 100 g/m²/24h. To ensure that clothing made from coated fabric is comfortable, this permeability must be raised by as much as two orders of magnitude.

106.2.1 Breathable Films

Three basic approaches have been taken to the manufacture of coatings that are permeable to water vapor and, at the same time, resistant to the passage of liquid water (so-called breathable films):

1. Puncture the film with needles, laser beams, or other means to produce an array of micrometer-sized holes.
2. Make the film from a material that can be broken up into fine, fiberlike strands, with micrometer-sized spaces between the fibers.
3. Create monolithic polymer membranes that contain no through-going pores, in which transmission of water vapor occurs through a process known as activated diffusion. In such membranes, the water vapor condenses and dissolves in the surface and then diffuses through to the other side of the film, where it desorbs and evaporates into the surrounding space.

The first of these approaches, involving the mechanical puncturing of a cast film, appears in some ways to be a simple and direct way of achieving the desired permeability. However, because the holes need to be extremely small if water resistance is to be maintained, and very closely spaced if the desired permeability level is to be attained, there is at present no totally successful, economically viable product available.

The production of microporous films by expanding and splitting a continuous film of appropriate morphology has been a more successful approach. Several such products are commercially available, the best known being based on a polytetrafluoroethylene film. Others based on polypropylene or polyurethane are also being produced.

The third approach, the production of a permeable monolithic film, is being pursued aggressively by many companies throughout the world. Most of these products are based on a modified polyurethane or polyester, and several are already in use, particularly in sportswear.

The best of these "breathable" materials have moisture vapor permeabilities as high as about 4000 g/m²/24 h, which is high enough to keep a moderately active individual comfortable. It is not yet high enough to meet the needs imposed by vigorous activity, or the extreme requirements of, for example, the long-distance runner, hockey player, or fireman. But it is a significant improvement over the use of a regular continuous coating.

This is a rapidly changing area that is attracting a great deal of research and development effort. Recently, a new candidate material based on a modified amino acid [poly(*R*-methyl *L*-glutamate)] has been announced. This coating was stated to have a moisture vapor permeability of 8000 to 12,000 g/m²/24 h. We can confidently expect a proliferation of products to result and can look forward to a time when the long-term comfort of water-resistant clothing, even for the most active person, can be ensured.

Bibliography

- Fourt, L., and N. R. S. Hollies, *Clothing Comfort and Function*. New York: Dekker, 1970, pp. 21–30.
- Greenwood, K., W. H. Rees, and J. Lord, "Problems and protection and comfort in modern apparel fabrics," in *Studies in Modern Fabrics*. Manchester, UK: The Textile Institute, 1970, pp. 197–218.
- Hollies, N. R. S., and R. F. Goldman, *Clothing Comfort: Interaction of Thermal, Ventilation, Construction and Assessment Factor*. Ann Arbor, MI: Ann Arbor Science, 1977.
- Keighley, J. H., "Breathable fabrics and comfort in clothing," *J. Coated Fabrics*, 15, 89 (1985).
- Lomax, G. R., "The design of waterproof, vapour-permeable fabrics," *J. Coated Fabrics*, 15, 40 (1985).
- Lomax, G. R., "Coated fabrics. Part I. Lightweight breathable fabrics," *J. Coated Fabrics*, 15, 115 (1985).
- Newburgh, L., *Physiology of Heat Regulation*. Philadelphia: Saunders, 1949, pp. 99–117.
- Slater, K., "Comfort properties of textiles," *Textile Progress* (The Textile Institute, Manchester, UK), 9 (1977).
- U.S. Department of Commerce, *Comfort Factors in Protective Clothing* (January 1978–April 1987). NTIS, PB87-857678, 1987.

107

Architectural Fabrics

Marcel Dery
Chemical Fabrics Corporation

107.1	Introduction	107-1
107.2	Products.....	107-1

107.1 Introduction

In the late 1960s, the opportunity to economically encapsulate large, clear-spans dictated a light weight construction approach. The temporary nature of available fabrics was not objectionable, since many of the structures envisioned, such as halls for international expositions, required relatively short periods of actual use. This provided an impetus to reconsider the design implications for such structures and finally to a reconsideration of the materials of construction themselves.*

To fully exploit the potential of the fabric option, there was little doubt that a new generation of structural fabric would be required: materials tough enough to withstand the rigors of handling by construction crews, virtually impervious to the ravages of weather, able to meet all applicable life safety codes including fire hazard, and sufficiently translucent to provide natural illumination in daylight hours.

107.2 Products

While several available fabrics could meet some of these requirements, none would meet them all. Nevertheless, it seemed reasonable to believe that such properties could be engendered if the proper selection of materials were made. In retrospect, it now appears that the material eventually selected, fiberglass and Teflon perfluoropolymer resins, may be unique in their ability to confer these properties in an efficient and cost-effective manner.

Glass in its fibrous form is an outstanding candidate for a woven reinforcement: it is pound for pound as strong as steel. It is incombustible, and it is compatible with the elevated temperatures required for processing in conjunction with the most incombustible resins.

Teflon perfluoropolymer resins are the most chemically inert plastics known and are particularly noted for their ability to withstand exposure to the ultraviolet radiation, moisture, and smogs associated with the outdoor environment. The flammability characteristics of these resins are equally outstanding: such materials will not support combustion in atmospheres containing less than 98% oxygen. Also, because of their lower heats of combustion, perfluoropolymers contribute substantially less fuel value than a comparable mass of hydrocarbon polymers. Finally, both the light transmission and flame-resistive properties can be expected to be maintained indefinitely, since these properties are inherent in the plastic and are not dependent on additives, which may bloom to the surface and oxidize, or be washed away or attacked by microorganisms. By working within these functional requirements, a family of permanent architectural fabrics was developed. Certain characteristics of the composite do present mechanical

*Portions of this chapter were extracted from a presentation made by Dr. John A. Effenberger, Vice President and Technical Director at Chemical Fabrics Corporation.

TABLE 107.1 Typical Specifications for Architectural Fabrics

Property	Sheerfill			Fabrosorb
	I	II	III	
Weight, oz/yd ²	44	38	37	14
Thickness, in.	0.036	0.030	0.030	0.014
Tensile strength, lb/in.				
Warp	800	520	620	360
Fill	700	430	480	280
Flexfold strength, lb/in.				
Warp	700	440	500	305
Fill	600	360	375	240
Tear strength, lb.				
Warp	60	35	50	25
Fill	80	38	55	20
Coating adhesion, lb/in.				
Minimum average	15	13	13	4
Minimum single	10	10	11	4
Solar transmission, %				
High transmission	11	13	15	23
Low transmission	7	9	9	NA
Solar reflectance, % min	70	67	73	67
Fire resistance of roof coverings (class)	A	A	A	

problems. The brittleness of fiberglass must be addressed without compromising its inherently high strength and modulus of elasticity. And its sensitivity to hydrolysis must be effectively counteracted. Additionally, the low abrasion resistance of perfluoropolymer coatings had to be overcome. Last, a method for joining fabric panels into roofing elements with structural integrity equivalent to that of the fabric had to be developed.

The brittleness issue is addressed first by choosing the finest diameter filaments to assure maximum strand flexibility. The yarns are then plied and woven in a plain configuration with a high degree of openness to enhance elongation, tear strength, and translucency in a coated fabric. The woven fabric is subsequently heat set and treated with a finish to inhibit the penetration of moisture into the yarns during processing, to further enhance tear strength, and to control elongation. The effectiveness of this process is evidenced by the high initial tensile and tear strength and the retention of tensile strength upon folding or soaking in water. Typical mechanical specifications for Sheerfill architectural fabrics are shown in Table 107.1.

Perfluoroethylene, by nature, has a low abrasion resistance. Since architectural fabrics must withstand the rigors of weather, a method of enhancing this property had to be developed. A glass filler was added to the outermost coats, which greatly improved the abrasion resistance of the surface without affecting the self-cleaning properties. A self-cleaning property is inherent in perfluoroethylene coated roofs. This leads to much lower maintenance cost over conventional roofs. The low coefficient of friction allows dirt, snow, and water to easily leave the roof.

The procedure for joining panels of fabric into a completed roof is as follows. Panels are lapped to provide a 3 in. seam area. A film of polyfluoroethylene resin is used as a hot-melt adhesive. Because this joint must be as structurally sound as the fabric itself, it must be constructed to avoid creep of the adhesive under design load. These joints are normally as strong as the fabric itself and equally durable.

Aside from the purely mechanical aspects of architectural fabrics, critical considerations include weatherability, fire safety, acoustics, and solar-optical performance. Weatherability has been assessed both by accelerated Weather-o-Meter exposure and by continuing real-time exposure at various weather stations. Accelerated tests data indicate that it is realistic to expect the fabric to retain adequate structural properties for more than 20 years. The limited data available from real-time exposure tend to corroborate the expectation of exceptionally long life.

Permanent building codes in the United States have proven in the past to be most unyielding to fabric structure options. Sheerfill architectural fabric structures, however, have found acceptance under the most stringent of U.S. codes, and have been approved for every structure submitted, most of which involve high public occupancy.

Perhaps the most convincing test performed to substantiate the outstanding fire-resistive behavior of architectural fabrics is the ASTM-E-84 Tunnel Test. In such a test, an asbestos-cement board receives a flame-spread rating of zero and red oak flooring is rated at 100. Materials rated below 25 are given Class A certification. The Teflon–fiberglass composites used in permanent structures all are rated Class A in this demanding test.

Fabrorb Accoustical Fabric, manufactured by Chemfab, represents a fabric with high noise reduction capability over a broad frequency range. Fabrorb is, like Sheerfill, a composite of Teflon and fiberglass. It, therefore, shares many of its outstanding properties: it is strong, resistant to moisture and mildew, and highly resistant to fire. However, it has a somewhat porous construction, which facilitates the attenuation of sound within the fabric. Thus, it has been found to offer highly significant advantages as a linear material for fabric structures, particularly where it may also serve as a plenum to channel warm air for snow melting along the inner surface of the outer fabric.

As a result of its more open construction, made possible largely by the reduced mechanical loading of the liner, the Fabrorb liner has a relatively high solar transmission. Thus, in addition to its mechanical and acoustical functions, it is able along with the primary Sheerfill architectural fabric to provide an essentially double-glazed fabric roof with significant energy-conservant benefits to ordinary double-glazed windows.

Let us examine the solar–optical properties of architectural fabric in a general sense. The degree to which light may be transmitted through such fabrics is governed largely by the degree of openness in the woven fabric. A 400,000 square foot stadium roof has on the order of 20 billion point sources of light, each approximately 10 to 25 mils on edge. It is not difficult to understand why the transmitted light is of such a pleasing and diffuse quality.

The absolute level of solar transmission is on the order of 7 to 16%, with the upper limit dictated by minimal tensile strength requirements and the lower limit dictated by minimal tear strength and coating adhesion requirements. Since the solar spectrum encompasses wavelengths beyond the visible range, the actual transmission of visible light is somewhat less than the solar transmission.

Energy savings may be realized with the use of a doubly glazed configuration by the reduced need for artificial lighting, which can account for up to 50% of the total energy demand in a department store setting, and a reduced refrigeration requirement that results from very low shading coefficients.

One of the most outstanding characteristics of these fabrics is their ability to reflect upwards of 70% of the incident solar energy. Such a superwhite external reflector in combination with a liner of Fabrorb is capable of providing a doubly glazed roofing system with good light transmission (on the order of 4 to 8%) while providing summertime shading coefficients down to 0.08.

The calculated heat gains for architectural fabric glazings at comparable solar transmissions are substantially lower than those of reflective glass glazings and suggest a real benefit to be derived from reduced refrigeration investment and reduced operating costs during the cooling season on a life-cycle cost basis. Such performance could make a fabric structure more attractive than a conventional structure with substantially lower initial costs when sited in an appropriate climate.

108

Gummed Tape

Milton C. Schmit
Plymouth Printing Company, Inc.

108.1	Introduction	108-1
108.2	Products.....	108-1
108.3	Manufacturing	108-2

108.1 Introduction

Paper tape with a coating of an adhesive that may be easily activated by the application of water and used to seal corrugated cartons, historically has been produced with a coating of animal glue. For the past 20 to 30 years, adhesive formulas based on thin boiling waxy maize starch have almost completely replaced animal glue in this product in the United States. In the European market, animal glues have been replaced by modified potato starch based formulas.

Over the years, in the United States, the demand for plain paper tapes for carton sealing has been decreasing and these tapes have been replaced by reinforced double-ply tapes. In other areas of the world, paper tapes command a larger share of the carton sealing market. A product line that is often included with reinforced carton sealing tape is manufacturers' joint tape, a product used by manufacturers of corrugated cartons to form the tube of the carton.

108.2 Products

Paper sealing tapes are described by the basis weight (24 in. × 36 in. 500) of the paper being coated. They are identified as light duty, medium duty, and heavy duty. The common base weight is 35 lb per ream for light duty, 60 lb for medium duty, and 90 lb for heavy duty tapes.

In the reinforced tape market there is little agreement among manufacturers as to what constitutes a difference in grades. The Gummed Industries Association (GIA)*, a trade association of manufacturers of gummed tape, has developed voluntary grading standards, but not all manufacturers apply them. The standards contain a formula method of grading glass reinforced tapes and define the grades as light duty, medium duty, and heavy duty.

Reinforced paper tapes, after a history of using randomly scattered sisal fibers, cotton yarn in a sine wave pattern, and rayon in various patterns as the reinforcement, now are nearly always made using glass fiber yarn. The most popular glass patterns have yarn in the machine direction along with a diamond pattern in the cross-machine direction. There still is some tape made with a scrim-type pattern of machine- and cross-directional glass fiber at right angles to each other.

Laminating adhesives are either hot-melt or waterborne adhesives. Hot melts include the traditional laminating asphalt, which has lost popularity over the years, and amorphous polypropylene. Any reinforced tape not using asphalt or a black laminating material is termed "nonasphaltic" by the industry. Waterborne adhesives may be based on polyvinyl acetate, polyvinyl alcohol, or other paper laminating

*The Gummed Industries Association, Inc., P. O. Box 92, Greenlawn, NY 11740; phone (631) 261-0114.

polymers, often clay loaded for better surfacing and economy. The use of waterborne adhesives for the laminate will generally require a manufacturer to postgum the web after laminating, whereas a hot-melt lamination allows a pregumming of the adhesive carrying ply. Postgumming is often slower and presents a more irregular surface to be coated with adhesive. The nonasphaltic tapes are also termed nonstaining, as opposed to the asphaltic tapes.

The paper stock used for reinforced tapes ranges from 23 to 40 lb per ream. The paper surface that is to be adhesive coated is preferably a machine glazed (MG) as opposed to a machine finished (MF) surface.

108.3 Manufacturing

Clean and dry warehousing is needed for the storage of base paper, as well as any bagged adhesive ingredients. Bulk dry powdered adhesive ingredients may be stored in silos, with unloading and in-plant transportation by pneumatic piping systems. The hot-melt laminating materials may be received in block form and remelted, but most larger operations receive the material in hot tank trucks or in rail tankers, which can be reheated for unloading. Insulated bulk storage incorporating heat transfer oil heating is then used along with hot oil traced pumps and supply lines for in-plant transportation.

Adhesive is prepared most often in batch kettles, but continuous preparation is an alternative. Animal glue and starch formulations both need heat in their preparation and application. Kettles may be double walled for steam, hot water, or hot oil heat, or just insulated. Surface heating is too slow a method for raising the batch temperature, so steam injection is used. Agitation is important for the slurring of the ingredients and for maintaining them in suspension during cooking. Regulating equipment is needed to give reproducible cooking cycles. Many formulas are sensitive to the rate of heating and especially to the length of exposure at high temperature. Adhesive may be fed directly to the coating equipment or sent to a tank farm for distribution to the coaters. Again, these holding units must be heated or insulated so that the adhesive will not gel or thicken too much.

In the United States, most tape is coated by direct two- or three-roll coaters, while some of the European gummers are using slot die coaters, which can handle the higher viscosities of the potato starch formulas. Adhesive temperatures at the coating head may be anywhere between 150 and 190°F. In some cases, the coating rolls themselves are internally heated so that adhesive stringiness may be overcome. In both two- and three-roll coaters, the adhesive is metered between two steel rolls, with the gap being controlled by a screw-driver wedge, or directly by a screw or cam. A three-roll coater has the third roll rubber covered to nip the paper against the metered adhesive on the upper steel roll. A two-roll coater uses a high tension device to hold the web in contact with the adhesive film on the upper steel roll. Most modern coaters are equipped with coating width sensing equipment that contains a closed loop arrangement for control of adhesive coating weight. Immediately after the coating head, the coated side of the web passes over small-diameter, reverse-turning leveling rolls to remove any film splitting pattern from the adhesive surface. The web then passes through a conventional drying oven before being rewound for further processing. Several machines in the industry have the gumming head in line with the reinforcing and laminating equipment.

Laminating and reinforcement are carried out in one operation. The glass fiber yarn is formed into a pattern and fed between the two paper plies as they are nipped together. Most tape manufacturers have adopted the Scrim-master* as the machine to form the crow-web glass fiber diamond pattern because of its ability to operate at a much higher speed than any other equipment. Older style weaving equipment had either shuttles that had to cycle over the full width of the web, or a wheel that carried the spindles of yarn from one edge to the other. Both these methods were slow operating at less than 200 linear feet per minute.

The Scrim-master uses a rocking motion shuttle or wand to weave the yarn between pins mounted on two chains. Metal tubes mounted in the wand pass around the chain pins. The chains travel in channels

*Nashua Industrial Machine, Pine Street Extension, Nashua, NH 03060.

6 in. apart during this weaving operation. As the chains leave the weaving wand section, the chain channels angle away from each other, forming a “Y” configuration that moves the chains out to just beyond the width of the web. While the chain is traveling in the expanding legs of the “Y”, the glass fiber is running over the chain pins to form an expanded diamond matrix. At this point the channels again return to travel parallel with the web, carrying the expanded glass fiber matrix into a nip, where it is sandwiched between the paper plies.

The machine direction glass yarn is fed into this nip at the same time, the strands are held in place by a comb designed to give the desired spacing. The comb oscillates from 0.25 to 1 in. to ensure proper winding of the finished product — the yarn causes a protrusion in the lamination and will not allow the straight winding of a roll if the yarn is not oscillated.

Either of the two paper plies or both may be coated with the laminating adhesive before being brought together at the nip with the reinforcing fibers. Hot roll coaters or slot die coaters are used. The first nipping of the laminate sandwich is done in a soft or low pressure nip, followed by a heavily loaded nip. The paper side of the tape is to the rubber roll side of the nip with the adhesive surface to the steel roll, thereby lessening the effect of any yarn protrusion on the gummed surface.

The adhesive coating shrinks considerably when it is dried, causing heavy side curl of the coated web. The glue surface is cracked to relieve some of the curl producing stress in the web. This is done by drawing the tensioned web over small radius steel bars. This is often done in line on the slitting equipment as the web is cut to width and length. Good breaking gives about 100 crack lines per inch and is not easily seen by the naked eye. Before slitting, a secondary machine may be used to pass the tensioned web over bars set at an angle to the web (30 to 45° is common), and then over a 90° bar. This gives a three-directional breaking pattern. To control the breaking and to prevent a pigtail curl from developing, the tension over each bar may need to be independently controlled and the radius of the bars may need to be different.

Plain paper tapes, reinforced tapes, and manufacturer’s joint tapes are usually supplied in a nominal 3 in. width, with some grades being readily available also in 2.5 in. width. Roll length is highly variable, ranging from 375 to 800 linear feet for products used in the common bench type of tape wetting devices, while rolls for automatic taping equipment are run to lengths to give diameters of 20 to 24 in.

Most slitting of tape is done on single-shaft rewinders and with score cut knives. There is some shear cut slitting done as well. The smaller diameter rolls may be on cores or coreless, with inside diameters of 1.25 to 1.75 in. Larger diameter rolls are generally on cores with a wall thickness of at least 0.125 in. and an inside diameter the same as the small rolls or a 3 in. inside diameter core. A bowed roller mounted between the slitter knives and the windup will cause the individual webs to separate slightly and help to separate the log of rolls when the shaft is removed.

Roll separation, inspection, and packing are done manually with no automation, except for carton sealing in some plants. The cartons are identified by a lot number so that any complaints can be traced through the manufacturing cycle. Finished product is palletized and stretch wrapped or shrink wrapped for shipping or warehousing.

109

Transdermal Drug Delivery Systems

109.1	Introduction	109-1
109.2	Attributes of a Transdermal System	109-2
	Developing a Transdermal • Selecting Drug Candidate	
109.3	Future Approaches to Transdermal Delivery Systems	109-4

Gary W. Cleary
Cygnus Research Corporation

109.1 Introduction

A “transdermal approach or technology” can be defined as any method that allows a drug or biological marker to transit skin in either direction. A transdermal drug delivery system allows the drug or molecule to transit from the outside of skin, through its various layers, and finally into the circulatory system to exert a pharmacological action. There may be some exceptions to this definition — for example, a system may concentrate the drug in the skin layers or near the surface of the skin to exert a localized effect, such as wound dressings for antisepsis or improved healing processes.

The transdermal drug delivery approach offers new opportunities for old drugs and new avenues to medical therapy. Developing these new products is a complex task. Primarily, today’s transdermal designs include not only drugs, pharmaceutical vehicles, and other excipients but also polymeric films, specialty coatings, pressure-sensitive adhesives, and release substrates. They involve many different scientific and manufacturing disciplines that are unfamiliar to both the pharmaceutical industry and the pressure-sensitive adhesive industry. New technology that can be brought to bear will expand future opportunities.

In the 1870s, physicians and their associates were not only exploring new materials and adhesives for binding surgical wounds, but were also including medicaments in these adhesive tapes to treat conditions that respond to drugs in the systemic circulation. Medicated plasters have been used to treat back pain, and iodine-impregnated gauze pads were quite popular at one time, but these devices gained disfavor because of such problems as irritation, side effects, and changes in the drug regulatory environment.

Although, physicians have long been prescribing topical products for treatment of localized skin diseases, it was not until the 1950s in the United States that a drug was made commercially available for systemic circulation by means of a topical application. Topical delivery of nitroglycerin was achieved by means of an ointment that was rubbed into the skin and overwrapped with Saran film, which was secured to the skin by means of surgical tape. This was the forerunner of the current transdermal device that has pressure-sensitive adhesives as part of the product. It was not until 30 years later, in the early 1980s, that a more sophisticated transdermal product appeared on the market.

Several transdermal delivery systems had reached the U.S. market as of 1988. They ranged in design from the amorphous ointments to solid state laminates. A review of the patent literature indicates a flurry of activity in developing many different designs. Scopolamine (1980), nitroglycerin (1981), clonidine (1985), and estradiol (1986) are drugs that have reached the U.S. transdermal market. Drugs that are

sold outside the United States include isosorbide dinitrate and progesterone. The market to the pharmaceutical companies reached close to \$500 million in 1987. The products have been accepted by physicians and by patients as a viable dosage form.

109.2 Attributes of a Transdermal System

To begin a program of developing a transdermal, one should consider what it is that the product is to achieve; that is, one should develop a “product profile” that describes the essential attributes of the desired transdermal. Once the criteria have been determined, a list of attributes of the delivery system can be made to develop a product profile to provide direction to the formulator or “system designer.” These attributes will describe the following:

- Physical characteristics (system size and shape, thickness, construction, amount of drug, color, flexibility, etc.)
- Functionality (necessary rate of release through skin, rate of release from the system, degree of adhesion to skin, length of time to adhere on skin site, method of applying system to skin, etc.)
- Patient demography
- Degree of irritation tolerance by patient
- Cost to patient and to third-party payers
- Medical rationale and intended indications
- Required margins by pharmaceutical company
- Availability of raw materials
- Patentability
- Effect of regulatory environment

For example, Key Pharmaceutical Company’s first transdermal nitroglycerin product delivered 10 mg/day over a 20 cm² area (equal to 0.5 mg/cm²/day). This transdermal, which has been accepted by patients, was actually a 90 cm² system because of the peripheral adhesive (see below, Type III design). Cosmetic appearance and size of the system will affect patient acceptance. Depending on the size that patients deem to be acceptable, the maximum total amount of drug that can be delivered may be as high as 50 mg/day. The size of the system will then depend on how much the skin will allow through, what blood level is needed to be achieved to elicit the desired pharmacological effect, and perhaps the patient’s well-being. Skin irritation and sensitization are issues that must be addressed in the early stages of development. A skin reaction may be caused by the drug, or by any vehicles, enhancers, or polymer that may be present. The cost/benefit ratio of the transdermal compared to other dosage forms must be weighed, as well.

There are various ways to view the design of these transdermals. One way is to start by considering the design of the transdermal without regard to the mechanism of how the drug is released or controlled. [Figure 109.1](#), a schematic side view of the laminate construction that is found in transdermal products, facilitates a visual conception of the actual product, its components, and how it might be formulated and fabricated. There are four types of designs on the market:

- Type I: amorphous ointment, cream, lotion, or viscous dispersion that is applied directly to the skin — Nitrobid (Kremers-Urban)
- Type II: amorphous liquid dispersion that is sealed between two laminate structures on all sides — Transderm Nitro and Estraderm (Ciba)
- Type III: solid state polymer matrix attached to a peripheral adhesive tape — Nitro-Dur I (Key); Nitrodisc (Searle); Nitro TDS (Bolar)
- Type IV: solid state polymer film structures laminated together — Transderm Scop V (Ciba); Transderm-clonidine (Boehringer-Ingelheim); Nitro-Dur II (Key); Deponit (Wyeth)

These four types are not all-inclusive, as new approaches and combinations of each are always possible. All these designs have the potential to deliver a drug to the skin so that the drug can migrate through

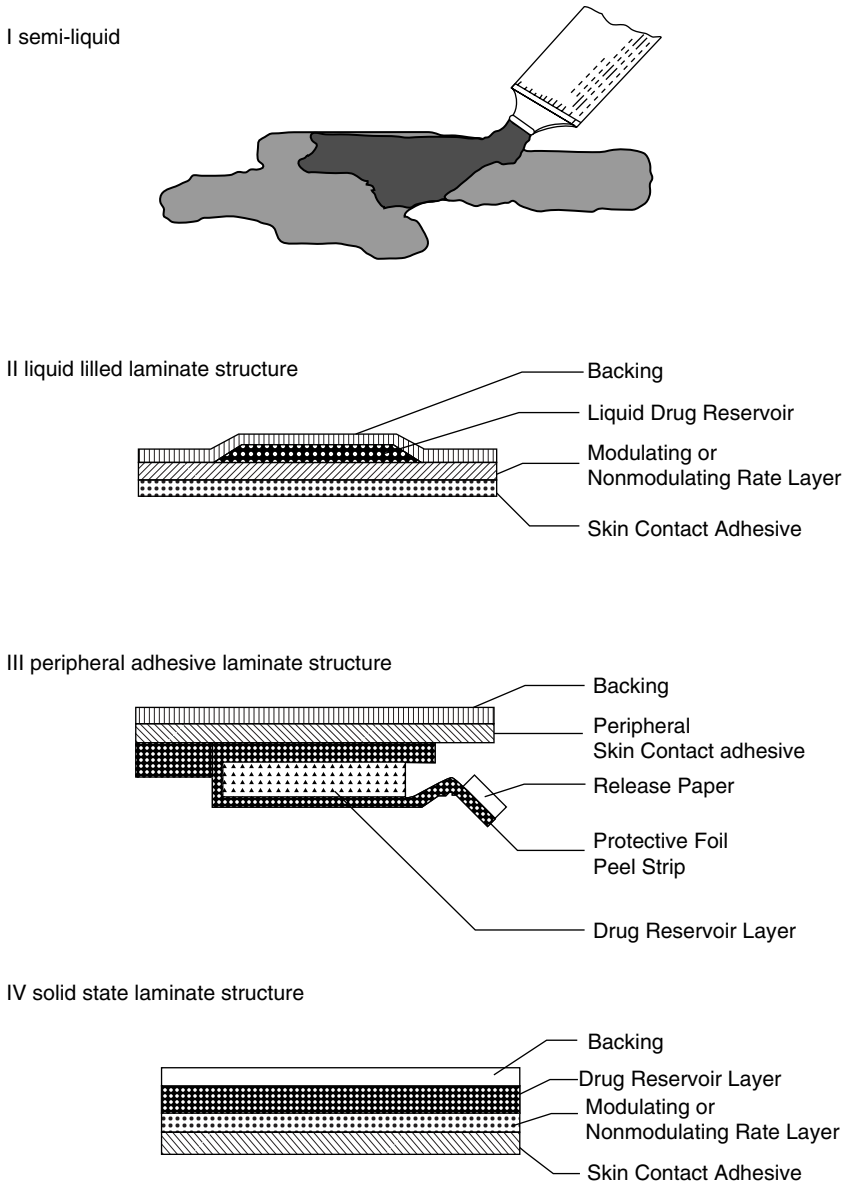

FIGURE 109.1 Schematic diagrams of four types of transdermal drug delivery system designs.

the skin. Types II, III, and IV have the adhesive and film laminate structure built into the final product. By understanding these basic designs, their advantages and disadvantages, one can incorporate the most suitable diffusional mechanism, using the appropriate plasticizers or vehicles, polymers, films or membranes, and adhesives, and matching the diffusivity of the drug through skin to achieve the desired delivery rate and plasma profile of the drug. The types of material that have been used in transdermal products that have reached the marketplace include the following:

- Pressure-sensitive adhesives: acrylates, silicone, and rubber-based adhesives
- Release liners: silicone and fluorocarbon coats on paper, polyester, or polycarbonate films
- Backings and membranes: ethylene-vinyl acetate, polypropylene, polyester, polyethylene, polyvinyl chloride, and aluminum films
- Specialty films: foams, nonwovens, microporous films, vapor-deposited aluminum films

The selection of materials and the system design will affect many of the attributes listed in the product profile.

109.2.1 Developing a Transdermal

Transdermal technology is relatively new, and to develop such dosage forms is a complex procedure from concept to commercial manufacture. The development of a transdermal system calls for a background in several disciplines or fields of study. These disciplines are interrelated and need to be considered simultaneously in the design of a transdermal delivery system. The basic foundation includes an understanding in the following:

- Skin properties
- Pharmaceutical formulation (pharmaceutics)
- Polymer and material science
- Mass transport
- Adhesion theory and formulation
- Pharmacology (pharmacodynamics and pharmacokinetics)
- Process engineering
- Fabrication, packaging, and manufacturing

109.2.2 Selecting Drug Candidate

What criteria are used to select a drug as a good potential candidate for delivery through the skin? The selection criteria include several factors that must be weighed at the same time to proceed in the development of a transdermal delivery system:

- Pharmacokinetic (what the body does to the drug) and pharmacodynamic (what the drug does to the body) information about the drug
- Ability of the drug molecule to permeate skin
- A targeted effective blood level
- Necessity for steady state delivery, or shape of blood level profile
- First-pass effect of the drug (high initial metabolism in the liver)
- Amount of drug needed
- Estimated size of system
- Need for skin penetrant enhancers to increase the amount of drug throughout
- Skin toxicity (irritation, sensitization)
- Side effects of drug
- Diffusional and solubility properties of drug

109.3 Future Approaches to Transdermal Delivery Systems

Transdermal delivery systems have reached the marketplace and have achieved widespread acceptability in therapeutics today. However, to achieve success as a dosage form, the selection and development of a drug candidate for transdermal delivery must be justifiable economically for both the patient and the manufacturer and must have a sound therapeutic rationale. There may be opportunity to expand a particular drug's current market if that market is quite small. This was seen with nitroglycerin, which after a century of use had a market of less than \$30 million/year. Five years after the first modern transdermal was introduced, however, the nitroglycerin market had exceeded \$300 million/year.

Not all drugs penetrate the skin easily at suitable therapeutic rates. If ways were found to put them through skin at higher rates of diffusion, a new transdermal market could be made. Some ways to attain suitable permeation rates could be through optimizing the formulation, changing the lipid solubility or physical properties through synthesis of new derivatives (homologues, analogues, or prodrugs) to effect

an improvement over the parent, or changing the skin permeability by means of chemical or electronic enhancers. Today, optimizing the formulation of a drug in a transdermal for passive diffusion is the predominant developmental approach. However, future approaches may include molecular modification of the drug, or using chemical or electronic means to increase skin permeation.

With the advent of post-World War II technology of electronics, medicine, and chemistry to produce a diversity of analytical instrumentation and sensitive drug assay methodology, combined with a better understanding of how the body affects drug metabolism, there have been advances in equipment and synthetic chemicals to produce new polymers, new film coatings, and new fabricating techniques. These innovations, as well as recent changes in the regulatory climate, and pressures to produce off-patent drug entities, are allowing the more venturesome to explore new ways to deliver drugs to the body. In this developmental climate comes a revitalization of the technique of using the skin as the portal of entry for drugs by means of transdermal delivery systems.

110

Optical Fiber Coatings

110.1	Introduction and Background	110-1
	Optical Waveguide Principles	
110.2	Coating	110-2
	Handleability • Coating Requirements • Composition of Fiber Coatings	
	References	110-4

Kenneth Lawson
DeSoto, Inc.

110.1 Introduction and Background

The concept of high speed data transmission on a beam of light was demonstrated by Alexander Graham Bell in 1880. His “photophone” used mirrors and sunlight to transmit low quality voice messages. Today’s technology has developed to a point of passing extremely high data rates (>2 Gbit/s) unrepeated through a high purity quartz fiber for distances exceeding 100 km.

Optical fibers offer many advantages over copper conductors and are gaining acceptance for the following reasons:

1. They carry more signals for greater distances without repeaters. A fiber with a 1 GHz bandwidth can transmit several thousand simultaneous telephone calls through use of state-of-the-art multiplexing techniques. Undersea cables have repeaters spaced as widely as 30 to 55 km, whereas copper cables require signal regeneration every 2 to 5 km.
2. Electromagnetic interference does not occur.
3. Cross-talk is eliminated because the optical signal is maintained in fiber and “short-circuits” do not occur.
4. Weight and volume of fiber cables are greatly reduced (for the same signal carrying capacity).

These advantages have led to the development of numerous optical fiber telecommunication networks, with an increasing awareness that the initial growth of this technology for long-distance trunk lines will continue to accelerate as fiber replaces copper wire in the subscriber loop (residential and business installations).

110.1.1 Optical Waveguide Principles

In any transparent material, light travels more slowly than in a vacuum. The ratio of these speeds is the index of refraction (n). When light, traveling in a material of one refractive index, strikes a material having a lower refractive index, the light is bent back toward the higher refractive index material. This phenomenon can be used to guide a light down a high purity glass rod, if the rod is clad with a material having a lower refractive index. Current telecommunication fibers employ a doped (germanium, phosphorus, etc.) silica core in combination with a lower refractive index ($n = 1.46$) silica cladding. The core will generally vary in thickness from 8 to 100 μm , whereas the outside diameter of the cladding is usually 125 μm . When made from pure silica, the resultant fibers have excellent strength (to 14,000 N/mm²)¹,

but they rapidly degrade as a result of the development of microscopic scratches, which are subject to growth, resulting in breakage when stressed (stress corrosion).

110.2 Coating

The application of a protective coating is required to preserve the optical fiber's strength and to protect it from lateral deformation, which can result in a reduced light signal (attenuation).

Attenuation is one of the major concerns of a fiber user. This is a measure of the light lost in passing through the fiber and is described in electronic terms as noise (i.e., decibels per kilometer: dB/km). This loss results from light scattering due to fluctuations of glass density, absorption due to impurities, and radiant signal loss due to microbending, the result of unequal forces or distortions of the glass fiber core.

Long-term durability of the fiber and its ability to transmit a signal of high fidelity is of paramount importance. Lifetimes of 25 to 40 years are generally expected, even though the anticipated environments vary from tropical climates to arctic winters to undersea water pressures. In addition, the fiber may be exposed to groundwater (having a pH of 2 to 12), solvents, steam, stress, and rapidly fluctuating temperatures. Under conditions of high stress and humidity, silica glass is known to undergo rapid stress corrosion through a process of hydrolysis, resulting in premature breaks of the communication link. To avoid this difficulty, manufacturers minimize flaws and conditions during fiber manufacture. To protect the glass, a protective buffer coating is applied within 1 or 2 sec of drawing, or as soon as the glass has cooled to below 100°C. The buffer coating is designed to protect the glass from being scratched. However, it is mandatory that the coating be free of any particulate matter, which may cause microscratches on the glass surface, forming a site for crack propagation.

110.2.1 Handleability

To keep up with increasing demand, the coating or coating system must lend itself to high production speeds. During the commercial development period of the late 1970s, typical production speeds varied from 0.5 to about 1 m/sec. At these slow speeds several coatings were found to be acceptable. Two-component polysiloxanes were found to offer the best overall properties, namely good strength, and minimal temperature dependence. (Their flexibility and modulus remain largely unchanged over a temperature range of -55 to 85°C.) Their durability is good, and their low modulus properties provide a soft coating, which protects the glass core from physical distortions and microbending. Major deficiencies of the silicones include relatively limited application and cure rates, high hydrogen generation, limited pot life (when catalyzed), and a high coefficient of surface friction, which requires overcoating. Other early coating systems included cellulose-based lacquers, Teflon extrusions, and polybutadiene rubbers.

110.2.2 Coating Requirements

In 1977 the demand for increased volume and productivity resulted in the development of ultraviolet (UV) light curable acrylate coatings, which met the needs for strength, longevity, and performance while also providing production speeds of 5 m/sec and faster.²⁻⁴ By using combinations of acrylate-functional oligomers and monomers, it is possible to formulate coatings having a wide range of useful properties, including the following:

- Modulus, 1 to 1000 MPa (125 to 150,000 psi)
- Elongation, 10 to 250%
- Hardness, 35 Shore A to 70 Shore D
- Tensile strength, 0.5 to 40 MPa (70 to 6000 psi)
- Low water absorption (<3%)

It has long been theorized⁵ that an optimal fiber coating system should consist of a very soft, low modulus, particulate-free coating against the glass to provide for surface protection and microbending

resistance. Microbending is the attenuation of the light signal caused by small bends of the core, resulting from nonuniform stresses on the fiber. The primary coating is followed by a harder, tough, secondary buffer to provide mechanical protection and water resistance, while offering a hard, slick surface that is compatible with subsequent cabling operations.

It is desirable that these coatings be applicable in-line, at maximum possible draw rates, and at several different outside diameters. Coating thicknesses may be from 3 μm . to nearly 400 μm .

The properties usually desired and generally provided by multifunctional acrylate coatings include the following⁶:

1. Primary buffer coatings

Good adhesion to the glass. Buffer removal or stripping can be accomplished with the use of solvents such as methylene chloride, or short lengths of coating can be removed mechanically.

Another construction might have minimal bonding to the glass to facilitate rapid, safe mechanical stripping of the buffer during installation.

Low tensile modulus over a range of operating temperatures (-55 to 85°C). Long stability, with excellent resistance to oxidation, hydrolysis, saponification, and UV light.

A satisfactorily high index of refraction, so that the coating can be applied using laser forward-scattering for concentricity control, and an index of refraction sufficiently higher than the cladding that light launched into the glass cladding will be stripped from the fiber⁷ (mode stripping) ($n > 1.48$).

Low glass transition temperature (T_g) to allow the primary coating to function without going through a glass transition phase that will cause differential expansion and contraction, resulting in microbending.

Low generation of hydrogen during the fiber's installed lifetime.

2. Secondary buffer coatings

Low surface free energy (i.e., low coefficient of friction and tack) as to allow for easy handling in the cable plant.

Low surface tack, to prevent binding or coupling of the coated fiber to the walls of a "loose tube" cable.

Good intercoat adhesion characteristics when overcoated with other components of a cable system (i.e., tape or extrusion coatings such as nylon, Hytrel Tefzel, etc.).

Excellent resistance to environmental factors such as water, acids, bases, solvents, and fungus growth.

High modulus to resist external lateral forces that will deform the light path.

High T_g to avoid differential expansion and contraction during thermal cycling. Low volatility to resist outgassing during hot extrusion applications to tightly buffered cable processes and long-term changes in physical properties.

The ability to be colored or to accept coloring, which permits individual fiber identification.

Resistance to the chemical gels used to fill "loose tube" cables.

110.2.3 Composition of Fiber Coatings

More than 75% of the world's quartz optical fiber is coated with acrylate-based materials and cured with UV light. The classical reaction chemistry uses photoinitiators to absorb photons generated by medium pressure mercury, xenon, or doped mercury lamps. For full cure in less than 1 sec, $1/\text{cm}^2$ of a wavelength of 300 to 390 nm is generally sufficient. Free radicals, which are produced by this reaction, cause rapid addition polymerization of the unsaturated acrylate groups. The proprietary chemistry is in the design and choice of the acrylate oligomers and reactive monomers. The oligomers are generally based on a range of polyesters, polyethers, and epoxy polymers, which have been esterified with acrylic acid (core-acted with a diisocyanate and a hydroxyfunctional acrylate). The reactive diluents are both mono- and multifunctional. Solvents are used only rarely for viscosity control. Stabilizers, inhibitors, flow aids, and

a wide assortment of additives are used to gain required properties. Secondary buffers may include pigments or soluble dyes for color identification.

Two-component polymethylsiloxane coatings are used in decreasing quantities for quartz telecommunication fiber. A phenyl variation provides the high refractive index required for a primary buffer, but at a significant cost disadvantage. The usual low refractive index makes silicones the coatings of choice for most all-plastic fiber and high loss, "plastic clad silica" (PCS) fiber. Physical properties of the silicones are excellent, but line speeds are generally limited to speeds well below 2 m/sec. Silicones are also difficult to mechanically remove from glass fiber for splicing, because they leave a residue.

Fluorine- and silicone-modified acrylates are used for specialty applications, as are polyimides for high temperature resistance. A new class of inorganic, hermetic coatings is being commercialized to provide stronger, more durable fiber. These include various vapor-deposited coatings such as reactive silica and titanium nitrides and carbides, as well as molten aluminum. Gold and indium have also been used.

References

1. C. I. Schlef et al. *J. Radiat. Curing*, April, 11 (1982).
2. U. C. Paek and C. M. Schroeder, *Appl. Opt.*, 120(23/1), 4028–4034 (December 1981).
3. K. R. Lawson and O. R. Cutler, *J. Radiat. Curing*, April, 4–10 (1982).
4. G. A. Perry, "Performance of acrylate-coated single-mode fibers," in *Proceedings of Interwire '87*, Atlanta, October 27, 1987.
5. J. A. Jefferies, and R. J. Klaiber, *Western Electric Eng.*, October, 13–23 (1980).
6. K. R. Lawson, "Advances in UV cured coatings for optical fibers," in *Proceedings of Rad. Cure Europe '83*, FC83-264, Society of Manufacturing Engineers, 1983.
7. K. R. Lawson, R. E. Ansel, and J. J. Stanton, "UV cured coatings for optical fibers," in *Proceedings of Fifth Radiation Curing Conference*, Association of Finishing Processes—Society of Manufacturing Engineers, 1985.

Exterior Wood Finishes

111.1	Introduction	111-1
111.2	Exterior Substrates.....	111-3
	Wood Properties and Weathering • Wood and Wood-Based Products • Water-Soluble Extractives	
111.3	Exterior Finishes	111-7
	Natural Weathering • Applied Finishes	
111.4	Summary	111-11
	References	111-11

William C. Feist
Consultant

111.1 Introduction

Wood exposed outdoors undergoes a number of physical and chemical phenomena mostly caused by moisture influences, sunlight, and temperature. The degradation of wood by any biological or physical agent modifies some of the organic components of wood. These components are primarily polysaccharides (cellulose and hemicelluloses) and polyphenolics (lignin). Extractives are also present in relatively small quantities, and their concentration determines color, odor, and other nonmechanical properties of a wood species. A change in the organic components may be caused by an enzyme, a chemical, or electromagnetic radiation, but invariably the net result is a change in molecular structure through some chemical reaction.

The relative effects of various energy forms on wood indoors and outdoors are compared in [Table 111.1](#). The most serious threat to wood indoors comes from thermal energy, and outdoors, from weathering — the combination of chemical, mechanical, and light energies. The weathering of wood is not to be confused with wood decay (rot), which results from organisms (fungi) acting in the presence of excess moisture and air for an extended period. Under conditions suitable for decay, wood can deteriorate rapidly, and the result is far different from that observed for natural outdoor weathering.

Weathering can be detrimental to the surfaces and appearance of wood. Thus, weathering must be taken into account when considering the preservation and protection of outdoor wood. Being a product of nature, wood is also subject to biological attack by fungi and insects. Most of these stressing factors, influencing factors, and weathering effects interact and influence a finished wood surface ([Figure 111.1](#)).

The primary functions of any wood finish (e.g., paint, varnish, wax, stain, oil) are to protect the wood surface, help maintain appearance, and provide cleanability. Unfinished wood can be used outdoors without protection. However, wood surfaces exposed to the weather without any finish are roughened by photodegradation and surface checking, change color, and slowly erode.

Wood and wood-based products in a variety of species, grain patterns, textures, and colors can be effectively finished by many different methods. Selection of the finish will depend on the appearance and degree of protection desired and on the substrates used. Also, different finishes give varying degrees of protection, so the type, the quality, the quantity, and the application method of the finish must be considered when selecting and planning the finishing or refinishing of wood and wood-based products.

TABLE 111.1 Relative Effects of Various Energy Forms on Wood

Form of Energy	Indoors		Outdoors	
	Result	Degree of Effect	Result	Degree of Effect
Thermal				
Intense	Fire	Severe	Fire	Severe
Slight	Darkening of color	Slight	Darkening of color	Slight
Light ^a	Color change	Slight	Extensive color changes	Severe
			Chemical degradation (especially lignin)	Severe
Mechanical	Wear and tear	Slight	Wear and tear	Slight
			Wind erosion	Slight
			Surface roughening	Severe
			Defiberization	Severe
Chemical	Staining	Slight	Surface roughening	Severe
	Discoloration	Slight	Defiberization	Severe
	Color change	Slight	Selective leaching	Severe
			Color change	Severe
			Strength loss	Severe

^a Both visible and ultraviolet light.

Stressing elements

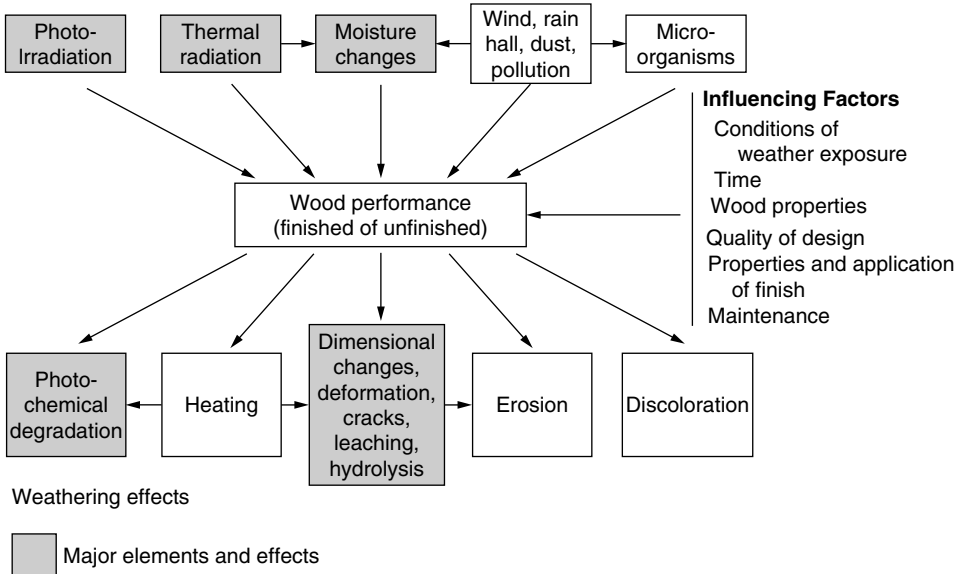

FIGURE 111.1 Stressing factors, influencing factors, and weathering effects that contribute to wood-finish performance.

Satisfactory performance of wood finishes is achieved when thorough consideration is given to the many factors that affect these finishes. These factors include the properties of the wood substrate, characteristics of the finishing material, details of application, and severity of exposure. Some of these important considerations are reviewed in this chapter. Additional sources of detailed information are listed in the references at the end of this chapter.

111.2 Exterior Substrates

111.2.1 Wood Properties and Weathering

Wood is a natural biological material and as such its properties vary not only from one species to another but within the same species. Some differences can even be expected in boards cut from the same tree. The natural and manufacturing characteristics of wood are important influences on finishing characteristics and durability.

The properties of wood that vary greatly from species to species are density, grain characteristics (presence of earlywood and latewood), texture (hardwood or softwood), presence and amount of heartwood or sapwood, and the presence of extractives, resins, and oils. The density of wood is one of the most important factors that affect finishing characteristics. Excessive dimensional change in wood constantly stresses a film-forming finish such as paint and may result in early failure of the finish. Density varies greatly from species to species and is important because high-density woods shrink and swell more than do low-density woods. The paintability of various softwoods and hardwoods is related to natural wood characteristics of density, presence of latewood, and texture, and to manufacturing characteristics such as ring orientation.

Wood surfaces that shrink and swell the least are best for painting. For this reason, vertical- or edge-grained surfaces (Figure 111.2) are far better than flat-grained surfaces of any species, especially for exterior use, where wide ranges of relative humidity and periodic wetting can produce equally wide ranges of swelling and shrinking. Table 111.2 lists the painting and weathering characteristics of softwoods and hardwoods.

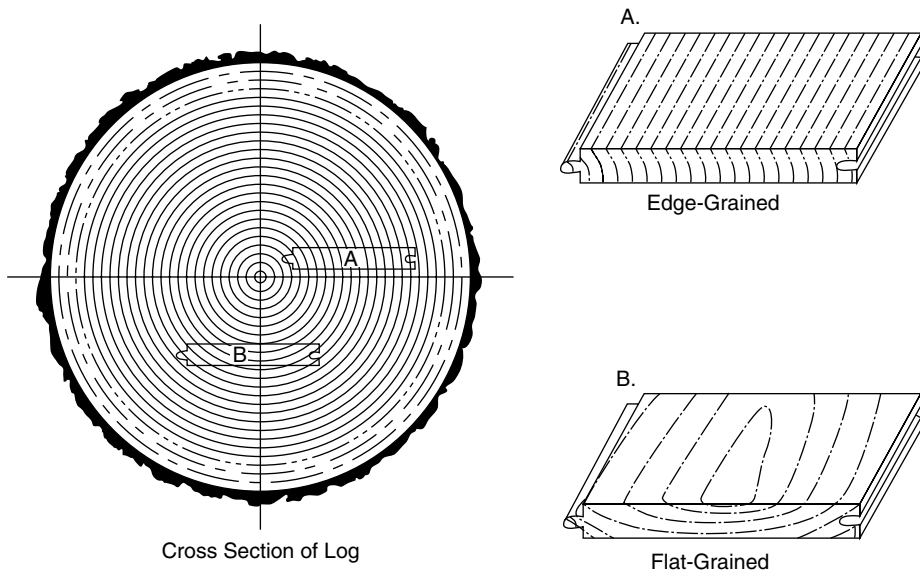

FIGURE 111.2 Edge-grained (or vertical-grained or quartersawn) board A, and flat-grained (or slash-grained or plainsawn) board B, cut from a log.

TABLE 111.2 Characteristics of Selected Solid Woods for Painting and Finishing

Wood	Density (lb/ft ³) at 8% moisture content ^a	Paint-Holding Characteristic (I, best; V, worst) ^b		Weathering		
		Oil-Based Paint	Latex Paint	Resistance to cupping (1, most; 4, least)	Conspicuousness of checking (1, least; 2, most)	Color of Heartwood
Softwoods						
Cedars						
Alaska	30.4	I	I	1	1	Yellow
Incense	24.2	I	I	—	—	Brown
Port-Orford	28.9	I	I	—	1	Cream
Western red	22.4	I	I	1	1	Brown
White	20.8	I	I	—	—	Light brown
Cypress	31.4	I	I	1	1	Light brown
Douglas fir ^c	31.0	IV	II	2	2	Pale red
Larch	38.2	IV	—	2	2	Brown
Pine						
Eastern white	24.2	II	II	2	2	Cream
Norway	30.4	IV	II	2	2	Light brown
Ponderosa	27.5	III	II	2	2	Cream
Southern yellow ^c	38.2	IV	III	2	2	Light brown
Sugar	24.9	II	II	2	2	Cream
Western white	27.1	II	II	2	2	Cream
Redwood	27.4	I	I	1	1	Drak brown
Spruce	26.8	III	II	2	2	White
Tamarack	36.3	IV	—	2	2	Brown
White fir	25.8	III	—	2	2	White
Western hemlock	28.7	III	II	2	2	Pale brown
Hardwoods						
Alder	28.0	III	—	—	—	Pale brown
American elm	35.5	V or III	—	4	2	Brown
Ash	41.5	V or III	—	4	2	Light brown
Aspen	26.3	III	II	2	1	Pale brown
Basswood	25.5	III	—	2	2	Cream
Beech	43.2	IV	—	4	2	Pale brown
Butternut	26.4	V or III	—	—	—	Light brown
Cherry	34.8	IV	—	—	—	Brown
Chestnut	29.5	V or III	—	3	2	Light brown
Eastern cottonwood	28.0	III	II	4	2	White
Gum	35.5	IV	III	4	2	Brown
Hickory	50.3	V or IV	—	4	2	Light brown
Lauan	27.4	IV	—	2	2	Brown
Magnolia	34.4	III	—	2	—	Pale brown
Maple, sugar	43.4	IV	—	4	2	Light brown
Oak						
White	45.6	V or IV	—	4	2	Brown
Northern red	42.5	V or IV	—	4	2	Brown
Yellow poplar	29.2	III	II	2	1	Pale brown
Yellow birch	42.4	IV	—	4	2	Light brown
Sycamore	34.7	IV	—	—	—	Pale brown
Walnut	37.0	V or III	—	3	2	Dark brown

^a 1 lb/ft³ = 16.2 kg/m³.

^b Woods ranked in group V are hardwoods with large pores, which require wood filler for durable painting. When the pores are properly filled before painting, group II applies.

^c Lumber and plywood.

Because the swelling of wood is directly proportional to density, low-density species are preferred over high-density species for painting. However, even high-swelling and dense wood surfaces with a flat grain can be stabilized with a resin-treated paper overlay (overlaid exterior plywood and lumber) to provide excellent surfaces for painting. Medium-density, stabilized fiberboard products with a uniform, low-density surface or paper overlay are also good substrates for exterior use. However, edge-grained heartwood of western red cedar and redwood are the woods most widely used for exterior siding and trim when painting is desired. These species are classified in group I, those woods easiest to keep painted (Table 111.2). Edge-grained surfaces of all species are considered excellent for painting, but most species are available only as flat-grained lumber.

Species classified in groups II through V (Table 111.2) are normally cut as flat-grained lumber, are high in density and swelling, or have defects such as knots or pitch. The specific classification depends upon the paint-holding characteristics of each species. Many species in groups II through IV are commonly painted, particularly the pines, Douglas fir, and spruce, but these species usually require more care and attention than the edge-grained surfaces of group I. Exterior paint will be more durable on edge-grained boards than on flat-grained.

111.2.2 Wood and Wood-Based Products

Three general categories of wood products are commonly used in exterior construction: (1) lumber, (2) plywood, and (3) reconstituted wood products, such as hardboard (a fiberboard) and particleboard. Each has characteristics that will affect the durability of any finish applied to it.

111.2.2.1 Lumber

Lumber, or solid wood, is being used less and less as an exterior siding, but it was once the most common wood material used in construction. Many older homes have solid wood siding. The ability of lumber to absorb and retain a finish is affected by species, by ring direction with respect to the surface (or how the piece was sawn from the log), and by smoothness.

Ring direction affects paint-holding characteristics and is determined at the time lumber is cut from a log (Figure 111.2). Most standard grades of lumber contain a high percentage of flat grain. Lumber used for board and batten siding, drop siding, or shiplap is frequently flat-grained. Bevel siding is commonly produced in several grades. In some cases, the highest grade of lumber is required to be edge-grained and all heartwood over most of the width for greater paint durability. Other grades may be flat-grained, edge-grained, or mixed-grain and without requirements as to heartwood.

Some species have wide bands of earlywood and latewood (Figure 111.3). Wide, prominent bands of latewood are characteristic of southern pine and most Douglas fir, and paint will not hold well on these species (Table 111.2). In contrast, slow grown redwood and cedar do not have wide latewood bands, and these species are preferred when paint will be used.

111.2.2.2 Plywood

Exterior plywood with a rough-sawn surface is commonly used for siding. Smooth-sanded plywood is not recommended for siding, but it is often used in soffits and other protected areas. Both sanded and rough-sawn plywood will develop surface checks (often described as face checking), especially when exposed to moisture and sunlight. These surface checks can lead to early paint failure when using oil or alkyd paints. Quality stain-blocking acrylic latex primers and topcoat paints generally perform better. The flat-grained pattern present in nearly all plywood can also contribute to early paint failure. Therefore, if smooth or rough-sawn plywood is to be painted, special precautions should be exercised. Penetrating stains are often more appropriate for rough-sawn exterior plywood surfaces, but quality acrylic latex paints also perform very well.

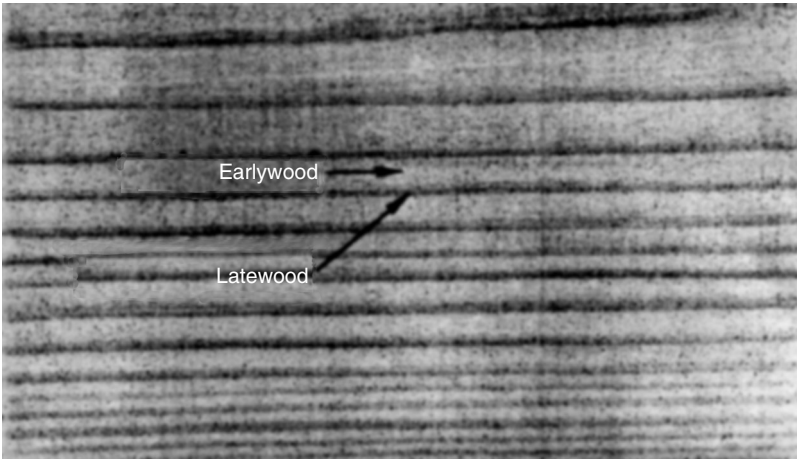

FIGURE 111.3 Earlywood and latewood bands in southern pine. These distinct bands often lead to early paint failure.

111.2.2.3 Reconstituted Wood Products

Reconstituted wood products are made by forming small pieces of wood into large sheets, usually 4 by 8 feet or as required for a specialized use, such as beveled siding. These products may be classified as fiberboard or particleboard, depending upon the nature of the basic wood component.

Fiberboards are produced from mechanical pulps. Hardboard is a relatively heavy type of fiberboard, and its tempered or treated form, designed for outdoor exposure, is used for exterior siding. It is often sold in 4- by 8-foot sheets as a substitute for solid wood beveled siding.

Particleboards are manufactured from whole wood in the form of splinters, chips, flakes, strands, or shavings. Waferboard, oriented strandboard, and flakeboard are three types of particleboard made from relatively large flakes or shavings.

Some fiberboards and particleboards are manufactured for exterior use. Film-forming finishes, such as paints and solid-color stains, will give the most protection to these reconstituted wood products. Some reconstituted wood products may be factory-primed with paint, and some may even have a factory-applied topcoat. Also, some may be overlaid with a resin-treated cellulose fiber sheet to provide a superior surface for paint.

111.2.3 Water-Soluble Extractives

Water-soluble extractives are extraneous materials that are naturally deposited in the lumens, or cavities, of cells in the heartwood of both softwoods and hardwoods. They are particularly abundant in those woods commonly used for exterior applications, such as western red cedar, redwood, and cypress, and are also found in lesser amounts in Douglas fir and southern yellow pine heartwood. The attractive color, good dimensional stability, and natural decay resistance of many species are due to the presence of extractives. However, these same extractives can cause serious finishing defects both at the time of finish application and later. Because the extractives are water soluble, they can be dissolved when free water is present and subsequently transported to the wood surface. When this solution of extractives reaches the painted surface, the water evaporates, and the extractives remain as reddish-brown marks.

Pitch in most pines and Douglas fir can be exuded from either sapwood or heartwood. Pitch is usually a mixture of rosin and turpentine; this mixture is called rosin. Rosin is brittle and remains solid at most normal temperatures. Turpentine, on the other hand, is volatile even at relatively low temperatures. By use of the proper kiln-drying techniques, turpentine can generally be driven from the wood, leaving behind only the solid rosin. However, for green (wet) lumber or even dried lumber marketed for general construction, different kiln schedules may be used, and the turpentine remains in the wood, mixed with

the rosin. The resultant rosin melts at a much lower temperature than does pure rosin, and consequently the mixture can move to the surface. If the surface is finished, the rosin may exude through the coating or cause it to discolor or blister.

In some species of wood the heartwood contains water-soluble extractives, while sapwood does not. These extractives can occur in both hardwoods and softwoods. Western red cedar and redwood are two common softwood species used in construction that contain large quantities of extractives. The extractives give these species their attractive color, good stability, and natural decay resistance, but they can also discolor paint. Woods such as Douglas fir and southern yellow pine also contain extractives that can cause occasional extractive staining problems.

111.3 Exterior Finishes

The various dimensions of wood and wood-based building materials are constantly changing because of changes in moisture content, which in turn are caused by fluctuations in the atmospheric relative humidity as well as the periodic presence of free moisture such as rain or dew. Water repellents provide protection against liquid water but are ineffective against water vapor (humidity). Film-forming finishes such as paint and varnish are effective against water vapor provided the films are thick enough. Because film-forming wood finishes like paint will last longer on stable wood, it is desirable to stabilize the wood by finishing it with a paintable water-repellent preservative as the first step in the finish system.

The protection of wood from moisture through applying a finish or coating depends on many variables. Among them are the thickness of the coating film, absence of defects and voids in the film, type of pigment (if any), chemical composition of the vehicle or resin, volume ratio of pigment to vehicle, vapor pressure gradient across the film, and length of exposure period. Regardless of the number of coatings used, the coating can never be entirely moisture proof. In the absence of wetting by liquid water, the moisture content of the wood depends on the ambient relative humidity. How quickly the wood achieves equilibrium with the ambient relative humidity depends on the properties of the coating. There is no way to eliminate completely the changing moisture content of wood in response to changing relative humidities. The coating simply slows down the rate at which the wood changes moisture content.

Film-forming finishes slow both the absorption of water vapor and the drying of the wood. In fact, the rate of drying is slowed more by the coating, and in cyclic high and low relative humidities, the moisture content of the wood increases with time. This retardation of drying can have a drastic effect on the durability of painted wood fully exposed to the weather. Paint coatings usually crack at the joint between two pieces of wood, particularly if they have different grain orientations (i.e., different dimensional stabilities). Water enters the wood through these cracks and is trapped by the coating. The wood moisture content can quickly reach the range at which decay fungi can prosper.

For a coating to be effective in minimizing moisture content changes of the wood, it must be applied to all wood surfaces, *particularly the end grain*. The end grain of wood absorbs moisture much faster than does the face grain, and finishes generally fail in this area first. Coatings having good moisture excluding effectiveness that are applied to only one side, will cause unequal sorption of moisture, increasing the likelihood of wood cupping.

111.3.1 Natural Weathering

The simplest finish for wood is created by the natural weathering process. Without paint or treatment of any kind, wood surfaces gradually change in color and texture and then stay almost unaltered for a long time if the wood does not decay. Generally, the dark-colored woods become lighter and the light-colored woods become darker. As weathering continues, all woods become gray, accompanied by photodegradation and gradual loss of wood cells at the surface. As a result, exposed unfinished wood will slowly wear away in a process called erosion (Figure 111.4).

The weathering process is a surface phenomenon and is so slow that most softwoods erode at an average rate of about 1/4 inch per century. Dense hardwoods erode at a rate of only 1/8 inch per century.

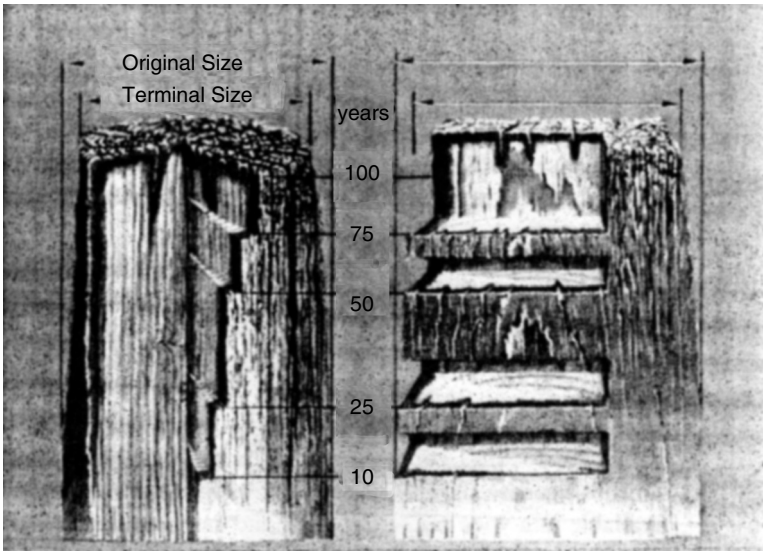

FIGURE 111.4 The weathering process of round and square timbers. Cutaway shows that interior wood below the surface is relatively unchanged, even though surface wood is weathered and eroded.

Very low density softwoods, such as western red cedar, may erode at a rate as high as 1/2 inch per century. In cold northern climates, erosion rates as low as 1/32 inch per century have been reported.

The physical loss of wood substance from the wood surface (erosion) during weathering depends not only on wood species and density, but also on growth rate, ring orientation, amount of irradiation, rain action, wind, and degree of exposure. Erosion also occurs most rapidly in thin-walled fibers of earlywood in softwoods and, at a slower rate, in dense latewood. Accompanying this loss of wood substance are the swelling and shrinking stresses caused by fluctuations in moisture content. All this results in surface roughening, grain raising, differential swelling of earlywood and latewood bands, and the formation of many small parallel checks and cracks. Larger and deeper cracks may also develop, and warping frequently occurs (Figure 111.4).

The weathering process is usually accompanied by the growth of dark-colored spores and mycelia of fungi or mildew on the surface, which gives the wood a dark gray, uneven, and unsightly appearance. In addition, highly colored wood extractives in such species as western red cedar and redwood add to the variable color of weathered wood. The dark brown color of extractives may persist for a long time in areas not exposed to the sun and where the extractives are not removed by the washing action of rain.

111.3.2 Applied Finishes

Finishes or coatings are applied to exterior wood surfaces for a variety of reasons. The particular reason will determine the type of finish selected and subsequently the amount of protection provided to the wood surface as well as the life expectancy for the finish. Two basic types of finishes (or treatments) are used to protect wood surfaces during outdoor weathering: (1) those that form a film, layer, or coating on the wood surface (film-forming) and (2) those that penetrate the wood surface, leaving no distinct layer or coating (non-film-forming). Film-forming finishes include paints of all descriptions, varnishes, varnish stains, and solid-color stains as well as overlays bonded to the wood surface. Penetrating finishes, which do not form a film over the wood, include oils, water repellents, solvent-borne stains, preservatives, and surface treatments.

Finishes can be also be divided into two other general categories: (1) opaque coatings, such as paints and solid-color stains, and (2) natural finishes, such as water repellents, water-repellent preservatives, penetrating oils, and semitransparent penetrating stains. For convenience, varnishes and varnish stains

(film-formers) are also included in the natural finishes. Wood preservatives and fire-retardant coatings might also be called “finishes” in some respects.

The outdoor finishes described in this section represent the range of finish types that are often used outdoors. Sources of information on the properties, treatment, and maintenance of exterior wood finishes are listed in the references at the end of this chapter, as is information on the suitability and expected life of the most commonly used finishes.

111.3.2.1 Paints

Paints are coatings commonly used on wood and provide the most protection of all the finishes because they block the damaging ultraviolet (UV) light rays from the sun. They are available in a wide range of colors and can be either oil- or latex-based. Paints are used for aesthetic purposes, to protect the wood surface from weathering, and to conceal certain defects.

Paints are applied to the wood surface and do not penetrate it deeply. The wood grain is completely obscured, and a surface film is formed. Paints perform best on smooth, edge-grained lumber of light-weight species. This surface film can blister or peel if the wood becomes wet or if inside water vapor moves through the house wall and into the wood siding because of the absence of a vapor-retarding material. Latex paints are porous and thus will allow some moisture movement. Some oil-based paints are resistant to moisture movement, but often they become more brittle with age and do not last as long as do acrylic latex paints.

Oil-based paint films usually provide the best shield from liquid water and water vapor. However, they are not necessarily the most durable, because they become brittle over time. No matter how well sealed, wood still moves with seasonal humidity, thus stressing and eventually cracking the brittle paint. On the other hand, latex paints, particularly the acrylic paints, remain more flexible with age. Even though latex paints allow more water vapor to pass through, they hold up better by stretching and shrinking with the wood. Most recent paint studies indicate that the acrylic and vinyl-acrylic latex paints provide the longest life of the exterior wood paints.

Of all the finishes, paints provide the most protection for wood against surface erosion and offer the widest selection of colors. A nonporous paint film retards penetration of moisture and reduces the problem of discoloration by wood extractives, paint peeling, and checking and warping of the wood. It is important to note that paint is not a preservative. It will not prevent decay if conditions are favorable for fungal growth. Original and maintenance costs are often higher for a paint finish than for a water-repellent preservative or a penetrating stain finish.

111.3.2.2 Solid-Color Stains

Solid-color stains are opaque finishes (also called hiding or heavy bodied). They are available in a wide range of colors and are made with a much higher concentration of pigment than the semitransparent penetrating stains. Solid-color stains will totally obscure the natural color and grain of wood. Oil-based solid-color stains form a film much like paint and as a result can peel loose from the substrate. Latex-based solid-color stains are also available and form a film, as do the oil-based solid-color stains. Both these stains are similar to thinned paints and can usually be applied over old paint or stains if the old finish is securely bonded to the wood.

111.3.2.3 Semitransparent Penetrating Stains

Semitransparent penetrating stains are only moderately pigmented and thus do not totally hide the wood grain. These stains penetrate the wood surface to a degree, are porous to water vapor, and do not form a surface film like paints. As a result, they will not blister or peel even if moisture moves through the wood. Penetrating stains are alkyd- or oil-based, and some may contain a fungicide (preservative or mildewcide) as well as a water repellent. Moderately pigmented latex-based (waterborne) stains are also available, but they do not penetrate the wood surface as do the oil-based stains.

The semitransparent stains are most effective on rough lumber, weathered lumber, or rough-sawn plywood surfaces, but they also provide satisfactory performance on smooth surfaces. They are available

in a variety of colors and are especially popular in the brown or red earth tones because they give a natural or rustic appearance. They are an excellent finish for weathered wood. Semitransparent penetrating, oil-based stains are not effective when applied over a solid-color stain or over old paint. They are not recommended for use on hardboard and oriented strandboard.

An effective stain of the semitransparent penetrating type is the Forest Products Laboratory natural finish developed in the 1950s. This finish has a linseed oil vehicle, a fungicide to protect the oil and wood from mildew, and a water repellent that protects the wood from an excessive penetration of water. It is available in durable red and brown iron oxide pigments that simulate the natural colors of redwood and cedar. A variety of other colors can also be achieved with this finish.

111.3.2.4 Water-Repellent Preservatives and Water Repellents

A water-repellent preservative may be used as a natural finish. It contains a fungicide or mildewcide (the preservative), a small amount of wax for water repellency, a resin or drying oil, and a solvent, such as turpentine or mineral spirits. Water-repellent preservatives do not contain coloring pigments. Therefore, the resulting finish will vary in color depending upon the species of wood. The mildewcide also prevents wood from darkening (graying).

The initial application of the water-repellent preservative to smooth wood surfaces is usually short-lived. During the first few years, the finish may have to be applied every year. After the wood has gradually weathered to a uniform color, the treatments are more durable and the wood needs refinishing only when the surface starts to become unevenly colored by fungi.

Inorganic pigments can be added to the water-repellent preservative solutions to provide special color effects, and the mixture is then similar to the semitransparent pigmented penetrating stains. Colors that match the natural color of the wood and extractives are usually preferred. As with semitransparent stains, the addition of pigment to the finish helps stabilize the color and increase the durability of the finish.

Some water-repellent preservatives may also be used as a treatment for bare wood before priming and painting or in areas where old paint has peeled, exposing bare wood, particularly around butt joints or in corners. This treatment keeps rain or dew from penetrating into the wood, especially at joints and end grain, and thus decreases the shrinking and swelling of wood. As a result, less stress is placed on the paint film, and its service life is extended. This stability is achieved by the small amount of wax present in water-repellent preservatives. The wax decreases the capillary movement or wicking of water up the back side of lap or drop siding. The fungicide inhibits surface decay. Water-repellent preservatives are also used as edge treatments for panel products like plywood.

Water repellents are also available. These are water-repellent preservatives with the fungicide, mildewcide, or preservative left out. Water repellents are not effective natural finishes by themselves but can be used as a stabilizing treatment before priming and painting.

111.3.2.5 Oils and Varnishes

Many oil or oil-based natural wood finish formulations are available for finishing exterior wood. The most common oils are linseed and tung. However, these oils may serve as a food source for mildew if applied to wood in the absence of a mildewcide. The oils will also perform better if a water repellent and a UV stabilizer are included in the formulation. Alkyd resin and related resin commercial formulas are also available. All these oil systems will protect wood exposed outdoors, but their average lifetime may be only as long as that described for the water-repellent preservatives.

Clear coatings of conventional spar or marine varnishes, which are film-forming finishes, are not generally recommended for exterior use on wood. Shellac or lacquers should never be used outdoors because they are very sensitive to water and are very brittle. Varnish coatings become brittle by exposure to sunlight and develop severe cracking and peeling, often in less than 2 years. Refinishing will often involve removing all the old varnish. Areas that are protected from direct sunlight by overhang or are on the north side of the structure can be finished with exterior-grade varnishes. Even in protected areas, a minimum of three coats of varnish is recommended, and the wood should be treated with a water-repellent preservative before finishing. Using compatible pigmented stains and sealers as undercoats will

also contribute to a greater service life of the clear varnish finish. In marine exposures, six coats of varnish should be applied for best performance.

111.4 Summary

Wood continues to play an important role as a structural material in today's high-tech society. As lumber and in reconstituted products, wood is commonly used for house siding, trim, decks, fences, and countless other exterior and interior applications. When wood is exposed to the elements, particularly sunlight and moisture, special precautions must be taken in structural design as well as in the selection and application of the finish.

This chapter described the characteristics of exterior wood finishes and their proper application to solid and reconstituted wood products. It described how manufacturing and construction practices affect the surfaces of wood products, how various types of finishes interact with the surface, and how weathering affects the finished surfaces. Methods for selecting various exterior wood finishes were presented.

References

1. D. L. Cassens and W. C. Feist, "Exterior wood in the South: Selection, applications and finishes," USDA Forest Service Forest Products Laboratory, General Technical Report FPL-GTR-69. Madison, WI: Forest Products Laboratory, 1991.
2. D. L. Cassens, B. R. Johnson, W. C. Feist, and R. C. De Groot, "Selection and use of preservative treated wood," Publication No. 7299. Madison, WI: Forest Products Society, 1995.
3. W. C. Feist, "Weathering of wood in structural uses," in *Structural Use of Wood in Adverse Environments*. R. W. Meyer and R. M. Kellogg, Eds. New York: Van Nostrand Reinhold, 1982, pp. 156–178.
4. W. C. Feist, "Finishing wood for exterior use," in *Finishing Eastern Hardwoods*. R. M. Carter, Ed. Madison, WI: Forest Products Research Society, 1983, pp. 185–198.
5. W. C. Feist, "Outdoor wood weathering and protection," in *Archaeological Wood, Properties, Chemistry, and Preservation*. R. Rowell, Ed. Advances in Chemistry Series, No. 225. Washington, DC: American Chemical Society, 1990, pp. 263–298.
6. W. C. Feist, "Painting and finishing exterior wood," *J. Coat. Technol.*, 68(856), 23–26 (1996).
7. W. C. Feist, "Finishing exterior wood," Federation Series on Coatings Technology. Blue Bell, PA: Federation of Societies for Coatings Technology, 1996.
8. W. C. Feist, "The challenges of selecting finishes for exterior wood," *Forest Products J.*, 47(5), 16–20 (1997).
9. W. C. Feist and D. N. -S. Hon, "Chemistry of weathering and protection," in *The Chemistry of Solid Wood*. R. M. Rowell, Ed. ACS Advances in Chemistry Series No. 207. Washington, DC: American Chemical Society, 1984, pp. 401–454.
10. Forest Products Laboratory, *Wood Handbook: Wood as an Engineering Material*, Agricultural Handbook No. 72 (revised). Madison, WI: U.S. Department of Agriculture, 1987.
11. T. M. Gorman and W. C. Feist, "Chronicle of 65 years of wood finishing research at the Forest Products Laboratory," USDA Forest Service General Technical Report FPL-GTR-60. Madison, WI: Forest Products Laboratory, 1989.
12. F. W. Kropf, J. Sell, and W. C. Feist, "Comparative weathering tests of North American and European exterior wood finishes," *Forest Products J.*, 44(10), 33–41 (1994).
13. K. A. McDonald, R. H. Falk, R. S. Williams, and J. E. Winandy, "Wood decks: Materials, construction, and finishing," Publication No. 7298. Madison, WI: Forest Products Society, 1996.
14. R. S. Williams, M. T. Knaebe, and W. C. Feist, "Finishes for exterior wood: Selection, application, and maintenance," Publication No. 7291. Madison, WI: Forest Products Society, 1996.

15. R. S. Williams, "Effects of acidic deposition on painted wood," in *Acidic Deposition: State of Science and Technology*. Effects of Acidic Deposition on Materials Report 19, National Acid Precipitation Assessment Program, Vol. 3, Section 4, 1991, pp. 19–165 to 19–202.
16. R. S. Williams, "Effects of acidic deposition on painted wood: A review," *J. Coat. Technol.*, 63(800), 53–73 (1991).

112

Pharmaceutical Tablet Coating

112.1	History.....	112-1
112.2	Reasons for Coating Tablets.....	112-1
112.3	Types of Coating.....	112-2
	The Sugar-Coated Tablet • The Film-Coated Tablet • Compression Coating	
	Bibliography.....	112-3

Joseph L. Johnson
Aqualon Company

112.1 History

The coating of solid pharmaceutical dosage forms began in the ninth century B.C., with the Egyptians. At that time the primary solid dosage form was the pill, a hand-shaped spherical mass containing drug, sugar, and other diluents. A variety of materials were used to coat pills, such as talc, gelatin, and sugar. Gold and silver were also used. Many of these coatings proved to be impervious to chemical attack in the digestive tract; as a result, the pill never released its active ingredient and was thus ineffective.

The candy-making industry was the first to develop and enhance the art of coating. It is most likely that the pharmaceutical industry adopted sugar coating technology for its own use. The first sugar-coated pills produced in the United States came out of Philadelphia in 1856. Coatings resistant to enteric or gastric fluids were developed in the 1880s. In 1953 the first compression-coated tablet was introduced, and in 1954 the first film-coated tablet was marketed.

112.2 Reasons for Coating Tablets

There are many reasons for coating tablets; some aesthetic, some functional. One important reason is to enhance drug stability; that is, to protect the drug from oxygen, moisture, and light, the three key causes of drug degradation. Coating can also be used to separate reactive components in a tablet formula.

Another important reason for tablet coating is identification. Tablet coatings may take on a variety of colors. A coated tablet may also be imprinted with a symbol or word. In the case of the film-coated tablet, the tablet core may be embossed with a symbol or word that remains visible after the coating process. The definitive identification of a coated tablet has saved patients and health care professionals alike. Additionally, coating is used to uniquely identify a branded product.

Tablet coating is done for aesthetic reasons as well. Often the appearance of the tablet core is mottled or otherwise unattractive. Coating masks this. Many times, too, the drug itself has a bitter taste. Coating masks this as well.

Tablet coating can also be used to control the duration and site of drug release. Overall, tablet coating, through an additional step in the manufacturing process, is often vital.

112.3 Types of Coating

There are two main types of tablet coating done today: sugar coating and film coating; film coating is the more popular. Coated tablets fall into three main subcategories depending on how the drug is released: immediate release, enteric release, and sustained release:

Immediate-release coating systems, as the name implies, allow immediate release of the drug compound to the body.

Enteric coatings are soluble only at a pH greater than 5 or 6. Thus, the drug is not released in the stomach but in the small intestine. Enteric coatings are by far the most unreliable because of the wide and unpredictable variance in gastric pH profiles. Gastric pH varies considerably based on stomach content, age of the patient, and disease state.

Sustained-release coatings permit drug to dissolve slowly over a period of time. This helps to reduce dosing intervals and improves therapeutic reliability.

Film coating can be carried out using either an organic solvent system, such as ethanol or methylene chloride, or by using water as a solvent. The solvent film coating systems are fast disappearing because of cost, environmental, and safety concerns. Most film coating carried out today is done with aqueous systems.

112.3.1 The Sugar-Coated Tablet

The sugar-coated tablet is the most elegant solid dosage form produced today. Its glossy appearance, slippery feel, and sweet taste are unmatched by any other coated tablet. The sugar-coated tablet is also the most difficult and time-consuming to produce. The tablet consists of a core upon which layer after layer of coating material is slowly and carefully built up. In some cases this is done by hand and in other cases automatically. In any event, there is still an art to sugar coating.

To successfully accept a sugar coating, the tablet cores must be robust. They are subjected to wetting and rolling in a coating pan with 50 kg or more of other cores. Generally the coating pan is spherical and has a solid exterior surface. Temperature-controlled air is introduced and removed from the pan via external ducts. The following procedure is used for the manual sugar coating of tablets.

The first step is to slightly waterproof the tablets by applying a coat of pharmaceutical-grade shellac.

This prevents the cores from dissolving prematurely in the presence of the other coating liquids that are to be applied.

The second step is subcoating: a solution composed of acacia, gelatin, and sugar is applied to the tablets. The wetted cores are then dusted with dicalcium phosphate or calcium sulfate and allowed to dry. This step is repeated many times until a smooth rounded tablet form has been achieved.

The third step is the grossing coat. The cores are wetted with a sugar solution and dusted with titanium dioxide powder. This creates a very white base coat on which color may be applied.

The fourth step is the color coat. In this instance an insoluble opaque color solid is suspended in sugar syrup and applied to the tablet. No dusting of the cores takes place. The tablets are simply air dried.

The fifth step is the shutdown coat. In this step diluted sugar syrup is applied to the tablet and allowed to dry. This produces a very smooth finish in preparation for the last step.

The last step is polishing of the tablets. The tablets are placed in a canvas-lined drum. Beeswax or carnauba wax is dissolved in methylene chloride, and the solution is applied to the tablets, which are tumbled until the solvent evaporates and tablets achieve a very high shine.

In all, 40 or more separate layers are applied during the manual sugar coating process. The process takes between five and eight 8-hour shifts to complete.

Automated sugar coating is generally faster. For example, the various syrups used in the coating process have the dusting powders suspended in them. The syrups are applied by spray. This process can be automated to reduce the number of operators required. Perforated coating pans, which greatly enhance

air throughput, are used almost exclusively. With greater air throughput, water evaporates more quickly, thus speeding the process. Using automated techniques, tablets can be sugar coated in about 16 hours.

112.3.2 The Film-Coated Tablet

The film-coated tablet consists of a core around which a thin, colored polymer film is deposited. Thus, a film-coated tablet gains about 3% of total tablet weight upon coating. The sugar-coated tablet undergoes a 100% weight gain. Overall, film coating is a much faster procedure, and much less prone to error.

The basic film coating formula consists of a film former, a pigment dispersion, a plasticizer, and a solvent. A variety of polymeric film formers can be used to coat tablets. By selecting the solubility properties of the polymer, one can produce an immediate-release, an enteric-release, or a sustained-release tablet.

The most popular immediate-release film formers are the water-soluble cellulose ether polymers. The two most common are hydroxypropylcellulose (HPC) and hydroxypropylmethylcellulose (HPMC). The low viscosity grades of these polymers are employed in the coating formula to maximize polymer solids concentration. Both these polymers are water soluble.

Water-insoluble film formers can also be used to prepare immediate-release coatings. These products fall into two categories: cellulose ethers and acrylate derivatives. The most common cellulose ether is ethylcellulose. This material is commercially available in two forms: as pure polymer and as an aqueous dispersion. The pure polymer is generally dissolved in an organic solvent; the dispersion is delivered out of an aqueous media. In both cases, a certain amount of water-soluble component (up to 50% of the total polymer solids) is included in the coating formula, to provide immediate drug release.

The ethylcellulose and acrylate compounds are also used to formulate sustained-release products. Again, a water-soluble component is included in the coating formula. However, the level is very low: usually about 3% of total polymer solids. When the coated dosage form is exposed to water, the water-soluble component dissolves. This leaves a porous film surface through which drug diffuses.

The third class of coatings, the enterics, resist the attack of gastric fluids. As a result, drug is released only in the small intestine. Enteric coatings are prepared by using a polymer with pH-dependent solubility properties. Cellulose esters, substituted with phthalate groups, are the primary polymers used in this application, especially cellulose acetate phthalate. Polyvinyl acetate phthalate is also used. Acrylate derivatives are also capable of providing enteric release.

112.3.3 Compression Coating

Compression coating is a technique wherein a large tablet either completely or partially surrounds a smaller tablet. Essentially, a small tablet is compressed first and is then surrounded by powder, which undergoes compression. This type of coating technique requires the use of special tableting machinery and it is used to produce sustained-release tablets.

Bibliography

- Florence, A. T., Ed., *Critical Reports on Applied Chemistry*, Vol. 6, *Materials Used in Pharmaceutical Formulation*. London: Blackwell Scientific Publications, 1984.
- Lachman, L., H. A. Leiberman, and J. L. Kanig, Eds., *The Theory and Practice of Industrial Pharmacy*, Philadelphia: Lea & Febiger, 1st ed., 1970; 2nd ed., 1976; 3rd ed., 1986.
- Osol, Arthur, Ed., *Remington's Pharmaceutical Sciences*. Easton, PA: Mack Publishing Company, 14th ed., 1970; 15th ed., 1975; 16th ed., 1980; 17th ed., 1985.

113.1	Yarns.....	113-1
113.2	Fabrics.....	113-2
	Woven Fabrics • Knitted Fabrics • Nonwovens	
	Bibliography	113-12

Algirdas Matukonis
Kaunas Technical University

Woven or knitted fabrics, and various types of nonwoven product, may be used as coating substrates. The physical–mechanical properties and the end-use performance of the coated fabrics depend significantly on the type of coating polymer and the substrate characteristics. Textile structures used for the backing of coated fabrics are complex three-dimensional constructions. The properties of these textile structures are determined by particular properties of constituent fibers and the construction of yarns and fabrics, as well as finishing processes. Knowledge of the characteristics of backing and its mechanical behavior is essential for predicting and understanding the properties of various coated materials.

113.1 Yarns

Processing of coated fabrics involves a wide range of natural and man-made fibers. Cotton and other vegetable fibers are the most important natural fibers used for backing. The types of man-made fiber most widely used for backing are high wet modulus viscose, polyester, polyamide, acrylic, polypropylene, polyethylene, and aramid fibers. It is well known that fiber properties are determined by the nature of the chemical composition, by the molecular and fine structure of the constituent polymer, and by the external structure of fibers. The fibers mentioned are used in the form of staple or yarns for the manufacture of woven, knitted, or nonwoven structures for backing.

There are two general classes of yarns: spun yarns made from natural and man-made staple fibers or their blends and continuous filament (multi- and monofilament) yarns.

Spun yarns are an assemblage of partly oriented and twisted staple fibers of relatively short definite length. The fibers in yarn are held together by twist, which causes the development of high radial forces and friction between fibers. Because of friction between fibers, the yarn obtains tensile strength and compactness. The fibers lie at varying angles to the axis of the yarn, with the fiber ends sticking out from the surface. The hairiness and the bulk of spun yarns play important roles with regard to absorbency and adhesion properties of backing materials made from these yarns. The amount of twist also determines the mechanical properties, first of all the breaking force and extension of spun yarns.

Continuous filament yarns are made by extruding the fiber forming polymer (solution or molten mass) through the holes in a spinneret. Filaments obtained by this way are long continuous fiber strands of indefinite length. The number of filaments is determined by the number of holes in the spinneret. Continuous filament yarns are characterized by a smooth, compact surface formed by parallel packing of straight filaments with minimal air spaces between them. Yarn made from one continuous filament is called monofilament yarn. Continuous filament yarns may be twisted or intermingled, to obtain required degrees of compactness and structure.

For improving bulk, stretch, warmth of handle, or moisture absorbency of continuous filament yarns, the process of texturing or bulking is widely used. Texturing or bulking alters the shape of filaments of thermoplastic yarns by introducing crimp loops or crinkles by means of deformation and simultaneous heat setting. The air bulking of continuous filament yarns of all types is also a rapidly expanding process. Three classes of textured filament yarns are manufactured: bulk yarns, stretch (with high elongation) yarns, and modified stretch yarns.

Yarn fineness (size) or linear density is expressed in terms of mass of unit length or tex (the mass in grams of 1000 m of yarn).

113.2 Fabrics

113.2.1 Woven Fabrics

Woven fabric is a textile structure made by interlacing two sets of yarns at right angles to each other. The yarns running along the length of the cloth are called the warp; the yarns going cross-wise, the weft. The warp threads in the weaving loom are separated by raising and lowering the frames and warp threads to form a shed, through which the weft yarn is propelled. The manner in which the sets of yarns are interlaced is known as weave. The mean number of ends or picks required to produce the weave (i.e., one complete yarn interlacing pattern) is called the repeat.

The weave, together with yarn linear density and thread spacing, to a great extent determines the properties and the appearance of fabrics. Weaves are usually represented on design paper. The warp yarn is shown by a vertical row between two lines of paper; the weft, respectively, by a horizontal row. If the warp thread goes above the weft thread, the corresponding square is filled in; if under the square is left unfilled. In the binary notation used in computer programming, filled squares are represented by "1" and blank ones are indicated as "0."

The variety of weaves is extremely great. Only a very limited range of weaves, mainly the basic weaves, are used for backing fabrics. There are three basic weaves: the plain weave, the twill weave, and the satin weave.

Plain weave (Figure 113.1) is the simplest. Each warp yarn interlaces with each filling yarn alternately, on the one-up/one-down principle. Plain weave fabrics constitute the largest group of woven materials used for backing purposes.

Because the plain weave is characterized by the highest quantity of interlacings in comparison with other weaves, it increases the tensile strength, increases the tendency to wrinkle, and decreases absorbency more than in comparable fabrics made with weaves of other types.

Twill weaves have yarn (warp or weft) floats on the surface of the fabric across two or more yarns of the opposite direction. The arrangement of warp and weft floats produces a diagonal pattern on the surface of fabric.

Twills are designated by a fraction, in which the numerator represents the number of warp threads that cover the weft thread and the denominator indicates the number of weft threads covering the warp yarns. A 1/3 filling faced twill is shown in Figure 113.2. It is clear that on opposite sides of fabric, the 3/

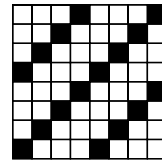
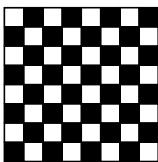

FIGURE 113.1 Plain weave.

FIGURE 113.2 Filling faced 1/3 twill weave.

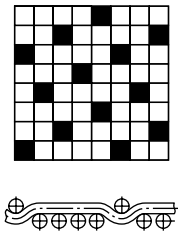

FIGURE 113.3 Satin weave: π yarn arrangement with the repeat of 5×5 yarns.

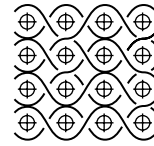

FIGURE 113.4 Four-layered fabric (derived from plain weave).

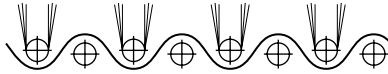

FIGURE 113.5 Weft-pile fabric.

1 twill is arranged with the twill wale going in the reverse direction. Since the relative amount of interlacing in the twill weave is less than in a plain weave, yarns can be packed closer, producing a thicker cloth. On the other side, fewer interlacings diminish the interfiber friction, which contributes to a greater pliability, softness, and wrinkle recovery of fabrics, but makes for lower strength. For backing manufacturing, a $2/2$ twill is widely used.

The satin weaves (Figure 113.3) have long yarn floats (over four yarns minimum) with a progression of interlacing by definite number (over two yarns minimum). When warp yarns predominate on the face of the fabric, we have a warp-faced fabric — satin with a higher warp count. If the weft covers the surface, the fabric is called sateen. The filling count of sateen fabrics is higher than of warp ends. The few interlacings of satin weave fabrics increase the pliability and wrinkle recovery, but also increase yarn slippage and raveling tendency. Fabrics of this type have a smooth, lustrous appearance because of the long floats.

Manufacturing of heavyweight coated materials requires corresponding woven backing with distinct thickness and mechanical properties. For this application, fabrics of two or more layers are used. The construction of four-layered fabric based on plain weave is shown in Figure 113.4.

For improving adhesion and absorbency as well as the aesthetic properties, various fabrics can be napped during finishing on one or both sides, producing a layer of fiber ends on the surface of the cloth. The weave of fabric used for napping usually must be filling-faced because of the raising ability of the long weft floats.

The most dense and durable three-dimensional pile cover is produced by means of special techniques. There are two ways to manufacture woven pile fabrics: using weft-pile and warp-pile technologies. In the weft-pile fabric (velveteen and corduroy) an additional set of filling, usually staple yarns with floats, is used. After weaving, the surface floats are cut and brushed, producing a dense, stable pile cover (Figure 113.5).

In warp-pile fabrics (velvets, plush, furlike fabrics), an extra set of warp staple or multifilament yarns is used. One very productive approach is the double-cloth method of warp-pile fabric manufacturing. Two parallel fabrics are woven in the special loom, face to face. The pile-warp interfacing connects both fabrics. As the pile is cut, two pile cloths are produced (Figure 113.6). In weft-pile fabrics the tufts of

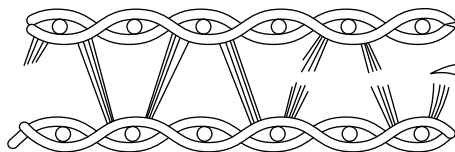

FIGURE 113.6 Warp-pile fabric (double-cloth method).

TABLE 113.1 Range of Breaking Characteristics of Woven Fabrics

Type of Fabric	Breaking Force (cN/tex)		Breaking Extension (%)	
	Warp Direction	Weft Direction	Warp Direction	Weft Direction
Cotton	5–7	4–7	4–8	16–24
Linen	6–8	5–6	5–21	5–8
Wool	2–5	1–3	20–28	28–33
Viscose	7–8	4–5	16–20	15–23
Nylon	20–26	7–16	20–22	26–28

pile are interlaced around ground warp yarn, and in the warp-pile fabrics they are interlaced around ground warp ends.

Some pile fabrics can be made very efficiently by tufting and punching extra yarns into woven base fabric by a series of needles, each carrying a pile yarn from a creel. The tufting pile can be cut or looped. The height of the pile depends on the type and end use of fabric. Velvet has a pile 1.5 mm high or shorter, velveteen not over 3 mm, plush usually 6 mm and longer, and furlike fabric 8 to 15 mm. Very important specific properties of all pile fabrics are the density of pile cover and resistance to shedding and pulling out. It must be noted that a coating polymer layer may be formed on the pile side of the fabric.

Other methods of producing pile fabrics, such as electrostatic flocking, using chenille yarn pile, etc., are also known.

The main structural characteristics of woven fabrics are linear density and count of constituent yarns, as mentioned previously, as well as weave, cover factor, and mass per unit area. Cover factor is expressed as follows:

$$K = \frac{d_y}{a_y} \times 100 = d_y S_y \times 100$$

where d_y is yarn diameter (mm), calculated on the base of linear density and apparent density of yarns, a_y is yarn spacing, and S_y is yarn count (number of threads per millimeter). Cover factor may be obtained for warp and weft yarns; it expresses the relative tightness of the fabric concerned. The magnitude of K in fabrics intended for coating varies in the ranges of 50 to 140% and 40 to 130% for warp and wefts, respectively. The mass per unit area (weight range) of fabrics depends on type and end use and varies from 40 to 400 g/m² or more.

Among the wide range of mechanical characteristics, there are several determining the field of use of coated woven fabrics. First, the fabric must have the required tensile strength and elongation. The tensile strength of fabric as well as of yarns is expressed in terms of tenacity in specific units: centinewtons per tex (cN/tex). Tenacity is calculated on the basis of the breaking force of a 50 mm wide strip and the number of linear density of threads in the strained system.

For approximate calculations, it may be assumed that the breaking force of a loaded thread system is expressed as the sum of the loaded yarn's breaking force multiplied by a factor 0.8 to 1.2, depending on the weave, thread count, type of fibers and yarns, finishing processes, and loading direction. In some cases the conditional value of tenacity is evaluated on the basis of breaking force and the whole mass of fabric strained (as in the case of nonwoven materials). The conditional values of breaking force and breaking extension of woven fabrics of various types are represented in Table 113.1. The strength of high-tech fabrics made from high tenacity fibers (polypropylene, polyethylene, aramid, and others) may be much higher.

The tensile behavior under load of fabrics of different types — woven, knit, and nonwoven — is shown in [Figure 113.7](#).

There are also other characteristics of fabrics that determine the usefulness of these materials for coating purposes. Important properties are tearing force, resistance to cyclic loading, bending stiffness,

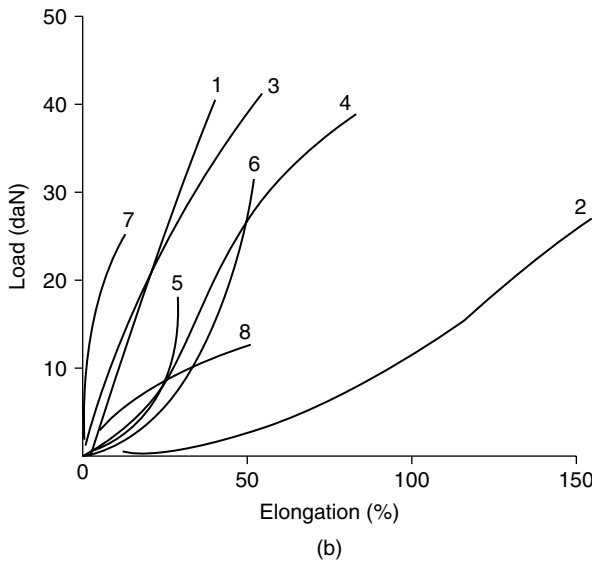
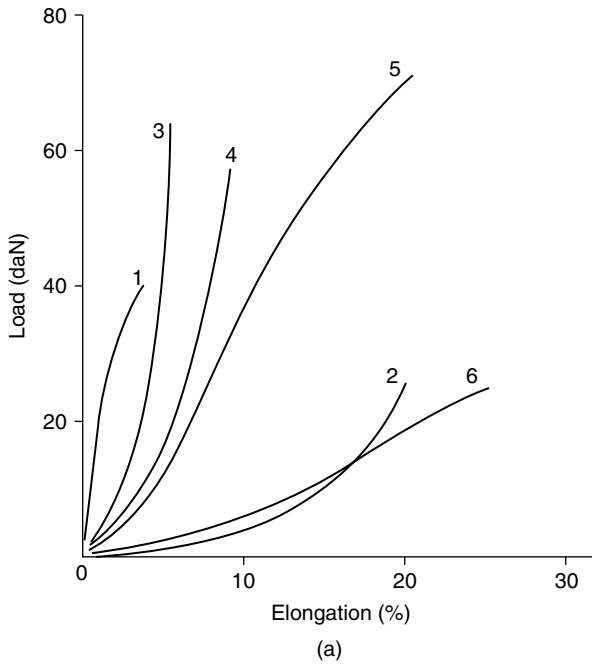

FIGURE 113.7 Load-elongation diagrams of different types of fabrics. (a) Woven fabrics: 1 and 2, cotton suiting; 3 and 4, linen; 5 and 6, nylon 6 taffetas (odd numbers — lengthwise extension; even numbers — crosswise extension). (b) Knits and nonwoven fabrics: 1 and 2, interlock double knit from viscose yarns; 3 and 4, tricot-charmà knit from nylon 6; 5 and 6, web stitchbonded cotton fabric; 7 and 8, adhesive-bonded nonwoven from viscose-nylon 6 blend (latex binding).

draped, porous, absorbent, elastic, and air permeable. Comparable information about the main properties of various fabric types is given in [Table 113.2](#).

113.2.2 Knitted Fabrics

Knitted fabrics are also important backing materials. Knitted fabric is a three-dimensional textile structure made by means of needles from a series of interlocking loops from a single yarn or an assemblage of yarns. The basic construction element of knitted structures is the loop. The lengthwise rows of loops in knitted fabric are named wales, and those running across the fabric are known as courses.

Depending on the number of threads taking part in the arrangement of loops, the two fundamental classes of knit structures are known as weft-knitted and warp-knitted fabrics. If the fabric is constructed from a single yarn with the loops made horizontally across the fabric, the principle of structure forming is known as weft knitting. Warp-knitted fabric is a vertical loop construction made from one or more sets of warp by forming the loops.

The weft knits are produced on flat-bed or circular machines of various types. There are three basic structures of weft-knitted fabrics: plain, rib, and purl. Obviously a wide range of modifications may be derived. The plain weft-knitted fabric structure is shown in [Figure 113.8a](#). The warp knits are made on two basic types of warp knitting machine — tricot and Raschel. The warp-knitted structures, as mentioned, require a set of threads fed from warp beams, each yarn producing a row of loops along the length of the material. The fabric is formed when the threads are moved from one needle to another on successive courses. Each warp set is controlled by yarn guides mounted in a guide bar. The number of guide bars depends on the number of warp sets. In different guide bars, yarns of different types may be fed. There are various structures of warp-knitted fabrics. For backing manufacture, tricot (plain jersey stitch), warp-knitted lockknit, and others are used. The warp-knitted tricot and warp-knitted lockknit structures are shown in [Figure 113.8b](#) and [Figure 113.8c](#).

A wide range of knitted fabrics can be made on the high speed multibar Raschel warp knitting machines. There are rigid and stretch fabrics, open-work fabrics, various tulles, nets, household fabrics, pile fabrics (velour, velvets), and industrial fabrics, including backing for coatings.

The main properties of knitted fabrics are determined by structure, which is characterized by the form and size of loops, the linear density of the constituent yarns, and the type of knitting structure. A very important parameter of knits is the cover factor, which expresses the relation of yarn diameter to loop length. Cover factor correlates with characteristics of stability and also with some mechanical properties.

The tricot fabrics have a high tensile and tear strength, as well as high resiliency, elasticity, and stability (see [Table 113.2](#)). Fabric of this type, if made from synthetic yarns, must be heat set to stabilize it against shrinkage. For tricot fabrics, a special finishing (e.g., antistatic, antishrink, flame-retardant) may be used.

The tenacity range of knitted fabric depending on type of knitting and type of fibers is 1 to 4 cN/tex (expressed by estimating the entire mass of fabric undergoing strain). The breaking extension is 50 to 250%.

Very important in achieving an increase in tensile strength has been the development of technology for manufacturing multiaxial warp-knit fabrics of various constructions, which are extremely suitable for backing uses. These fabrics can be produced on the tricot warp knitting and on Raschel machines. The basic principle is a sensible combination of the interlacing elements (loop and weft), which offers multiple fabric structure possibilities, especially dimensional stability. The simplest types of multiaxial warp-knit fabric are structures in which weft or warp or both systems are inserted in the knit structure. These additional straightened yarns are firmly bonded by the stitch construction and behave as load-bearing systems.

More complex constructions of multiaxial fabrics based on magazine weft insertion were recently developed. The number of load-bearing systems can be increased to three, four ([Figure 113.9](#)), or five by adding a diagonal yarn arrangement with a varied angle of insertion. Fabric becomes resistant to stretch in all directions because of these reinforcing structural elements. Depending on the construction, any yarn type and linear density may be used for the reinforcing system, including aramid, glass fiber,

TABLE 113.2 Comparison of Textile Properties

Fabric Type	Properties ^a											
	Thickness	Porosity	Specific Volume	Roughness	Tenacity	Braking Extension	Tear Force	Bending Stiffness	Compressibility	Elastic Modulus ^b	Drape Coefficient	Shear Strain
Woven	L/M	M	L	M	H	L/M	H	L/M	L	M	L/M	M
Knit	L	L/M	M	L	M	M	M/H	L	M/H	L	L	H
Stitchbonded (Malimo)	L	M	M	M	H	M	H	M	M	M	M	M/H
Adhesive-bonded	L/M	L/M	M	M	L/M	M	L	H	L/M	M	M/H	L
Stitchbonded (web)	M/H	H	H	L	M/H	L/M	M	H	M	H	L	L
Spunbonded	L	H	M	M	H	H	H	M/H	L	H	H	L

^a L, low; M, medium; H, high.

^b Modulus of elasticity (initial) expresses the ratio of stress to strain at the beginning of the stress-strain curve.

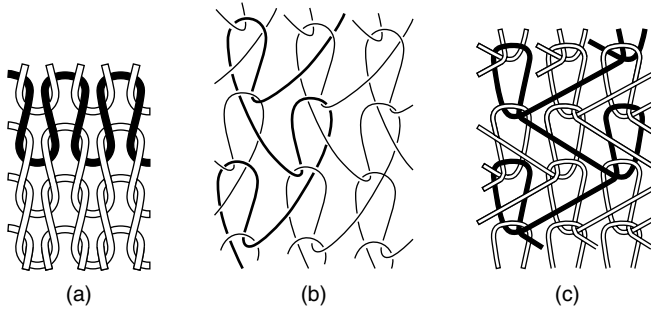

FIGURE 113.8 Knitted fabric structures: (a) weft-knitted fabric, (b) warp-knitted tricot structure, and (c) warp-knitted lockknit structure.

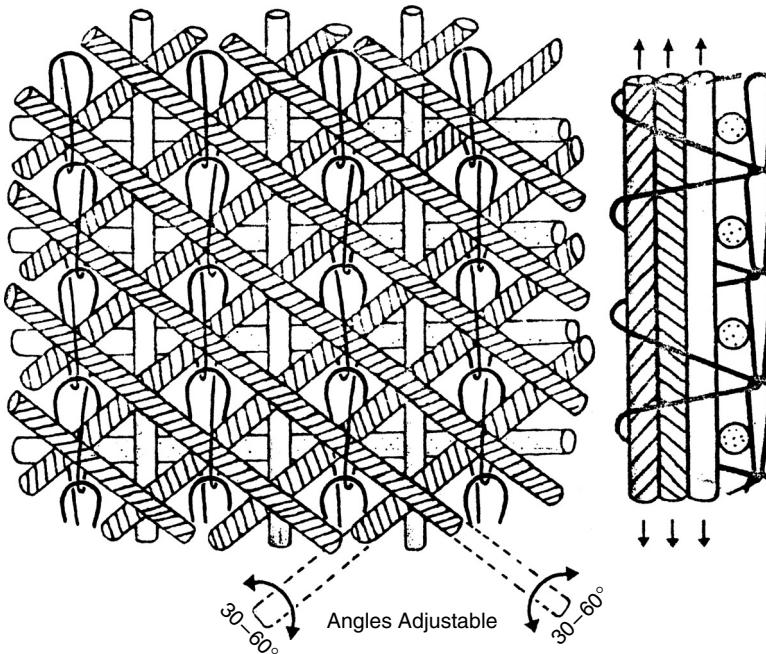

FIGURE 113.9 Multi-axial warp knit with four load-bearing systems, made on the Raschel machine (Karl Mayer, West Germany).

carbon fiber, and all traditional kinds of fibers. It is also possible to use a prebonded web on one or both sides of the construction as protective layer of fabric (Figure 113.10).

Multi-axial warp-knit fabric can be applied in all fields of household use, as well as for industrial applications.

The combined woven-knitted structure may be manufactured by means of the Metap machine (Czechoslovakia). The fabric consists of alternating lengthwise woven (85% of the whole surface) and knitted stripes. The properties of this fabric are analogous to those of woven structures. The fabric is suitable as a backing.

113.2.3 Nonwovens

The term “nonwoven” is applied generically to textile fabrics made from fibers, using unconventional methods. There are three groups of nonwoven fabric technology: physical–chemical methods, mechanical

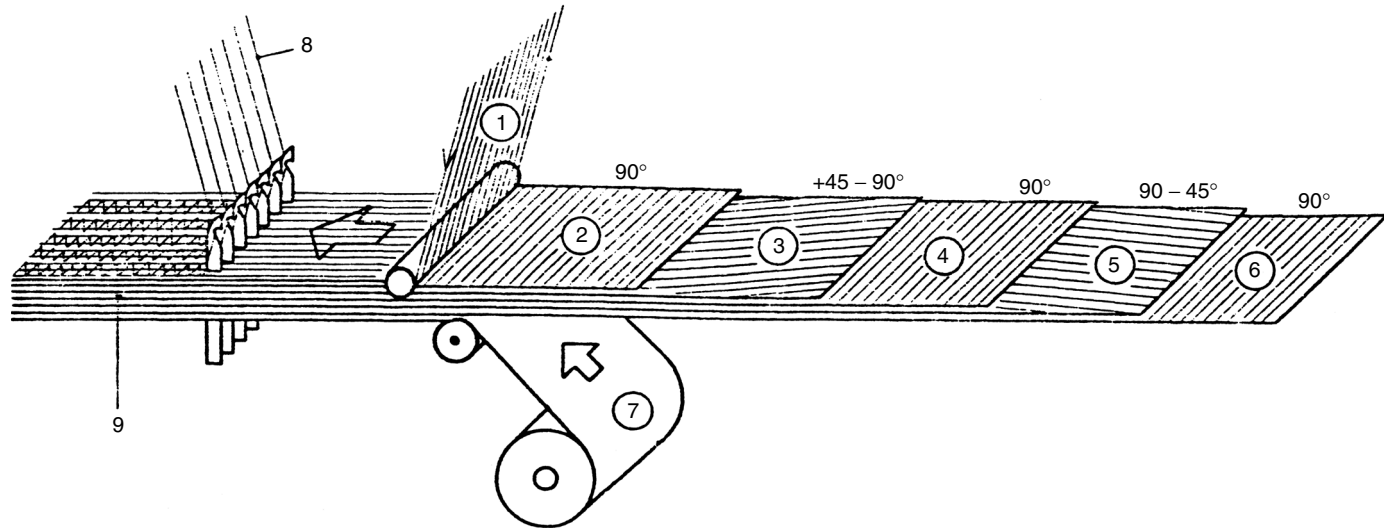

FIGURE 113.10 Multiaxial warp-knit fabric combined with prebonded web (made of Copcentra HS-ST machine, Liba, West Germany): 1, warp filler yarns; 2–6, weft yarn systems; 7, prebonded fiber web; 8, stitching warp system; 9, fabric formed.

technology, and combined technology. All techniques of nonwoven manufacture are characterized by a high operating speed and low fabric production costs in relation to conventional technologies.

113.2.3.1 Adhesive-Bonded Fabrics

Adhesive-bonded fabrics are made by the physical–chemical method, in which webs of fibers are strengthened by fiber-to-fiber adhesion. The web is prepared on special equipment based on carding or the aerodynamic principle; such machinery is capable of producing webs with random or oriented fiber distribution. The quality of the web determines to a large extent the quality of the nonwoven fabric. Adhesive-bonded fabric manufacturing uses a wide range of natural and man-made fibers or their blends.

Adhesion is achieved by means of the bonding agent, which may be an aqueous emulsion or a thermoplastic additive to the web. The adhesion of the bonding agent to the textile substrate must be good, and its cohesive strength must be adequate to withstand stresses during use. Because of the bonding action, the nonwoven fabric acquires strength and stiffness. The mechanical properties of fabrics (see Table 113.2) depend highly on binder content, fiber type, and fiber orientation in the web. It is possible to produce a nonwoven of this type with the weight range of 15 to 500 g/m² of either high flexibility but low strength or low flexibility but high strength. For increasing the drape properties and flexibility, the print bonding method is used. The spacing formed in this way between bonded areas allows freedom of movement of the fibers, which increases the fabric's flexibility.

Thermoplastic materials used for bonding web fibers are powders, fibers, yarns, nets, and films. Widely used in thermobonding technology are polyester fibers (including the hollow type), polyethylene, polyamide, and special binder fibers. Most often, two-component fibers are used, formed from polymers with different melting temperatures. Thermoplastic materials in the form of bonding fibers are processed by a heat treatment (oven sintering or hot calendering). Thus, at a suitable temperature, the sheets of bicomponent fibers that are in contact in a web will remain bonded upon cooling. Nonwovens made in this way are characterized by a weight range of 15 to 80 g/m² and by good handle properties, porosity, and bulk. The portion of binder fibers to adhesive is 10 to 50%.

The tensile strength of nonwovens is usually expressed in term of tenacity, as in the case of woven fabrics:

$$\text{tenacity} = \frac{\text{breaking force}}{\text{mass per unit length}}$$

Breaking force is determined on the base of a strip 50 mm wide. Therefore, the mass per unit length is expressed as mass of fabric strip 0.05 m wide and 1000 m length (tex).

The tenacity of adhesive- and thermobonded fabrics is in range 1 to 4 cN/tex.

113.2.3.2 Spunbonded Fabrics

The manufacture of spunbonded nonwoven fabrics consists of combining the preparation of webs with the production of man-made fibers. The whole sequence of operations, such as melt extruding and drawing of continuous filaments, arranging them on a moving collecting surface, forming a web, and bonding together by means of adhesive, thermobonding, or needlepunching, may be done in one process. Various man-made fibers may be used for the production of spunbonded nonwovens: viscose, polyester, nylon, polypropylene, polyethylene, and polyurethane fibers. The main spunbonded nonwoven properties depend on filament properties (linear density, tenacity, elongation, crimp, micromorphology), filament arrangement, and bonding parameters. These types of nonwoven fabrics are produced in weight range of 15 to 125 g/m². The use of randomly arranged continuous filaments contributes to a higher tear and tensile strength (5 to 8 cN/tex) in all directions, and also to good handle (see Table 113.2). By use of modified spunbonding techniques, it is possible to obtain fabrics with special properties, including those required for coating products (greater elasticity, elongation, and air permeability).

Trade names of spunbonded fabrics include Cerex (nylon 6 6), Reemay (polyester), Tyvar (polypropylene), and Tyvek (polyethylene).

Melt-blown fabrics also belong to the class of spunbonded nonwovens. The production process differs from the spunbonded method with respect to the principle of fiber production. The polymer here is melt-extruded through a row of die openings into a stream of hot high velocity air. The filaments formed are broken into fibers, which are entangled to form a web. The melt-blown fabric differs from the spunbonded one in that the web contains staple fibers rather than continuous filaments, with diameters in the range of 2 to 5 μm . This contributes to the softness, drapeability, opacity, and moderate strength of such fabrics. Strength may be increased by hot calendaring. The weight range of melt-blown fabrics is 60 to 500 g/m^2 .

113.2.3.3 Needlebonded (Needlepunched) Fabrics

Needlebanded fabrics are manufactured by a mechanical method. The principle of needlepunched fabric production is realized when the fibers move from one face of a web toward the other face as a result of the penetrating of the web by many barbed needles. Because of the transfer of fibers made by the needles of the punching machine, the fibers are interlocked, and the web obtains stability and strength. If required, the fabric may be finished by adhesive bonding or pressing, steaming, dyeing, and calendaring. The weight range of fabric is 200 to 1500 g/m^2 . The mechanical properties depend mainly on fiber characteristics, interfiber friction, web weight, and fabric finish treatment. Fibers of all types, and their blends, may be used for production of needlepunched fabrics. The strength of needlepunched fabrics varies in the range of 2 to 5 cN/tex . To increase fabric strength, additional backing in the form of a woven, knitted fabric or a film may be used. It is also possible to produce patterned colored fabrics by means of colored layers and by needling fibers from the top layer through the surface layer, making loops on the face of the fabric. Needlepunched fabrics with such special properties as flame retardancy, conductivity, and elasticity may be produced by using corresponding components.

113.2.3.4 Spunlaced Fabrics

Spunlaced fabrics are made by entanglement of the fibers in the web by means of streams of high pressure water jets. The web obtains the required bonding, which influences the strength, handle, drape, and air permeability of fabrics, the fluid fiber entangled fabrics may be made in the weight range of 20 to 70 g/m^2 and with a tenacity of 1.5 to 2.5 cN/tex . Polyester, polyamide, and other fibers may be used.

113.2.3.5 Stitchbonded Fabrics

There are several techniques for producing stitchbonded fabrics. The stitchbonding of fibrous web carried out by Arachne (Czechoslovakia), Maliwatt (East Germany), and VP (USSR) is widely known. The web of natural or man-made fibers prepared by the carding process, with oriented or random arrangement of fibers, is stitched with yarns by means of warp knitting technology units. This technology is therefore sometimes known as "knitsew." The type of stitch may be half-tricot, tricot, or others. The height of stitch varies from 1 to 6 mm. The gage of the VP machine is 2.5, 5, and 10; the gage of the Maliwatt varies from 3 to 22. Therefore, the number of courses in the fabric made varies from 5 to 25 (on a 50 mm base). The range of fabric weight is 160 to 400 g/m^2 for the VP and the Arachne, and 100 to 1600 g/m^2 for the Maliwatt. The mass of stitching yarns contributes 10 to 30% of whole fabric mass because the stitching system forms a continuous net of warp knit, filled with fibers of web.

The mechanical properties of the fabrics produced by stitching a basic web depend on the type of fibers used as much as on the fabric stitching structure, causing friction between elements of fabric construction. The stitching yarns also contribute to fabric tenacity in the lengthwise direction. The tenacity of the fabrics considered is 1.6 to 3.5 cN/tex . The fabrics have good handle and tear resistance, especially in the cross direction (see [Table 113.2](#)). After stitching the fabric may be processed by dyeing, pressing, or steaming.

Because of their tensile strength, tear strength, and resistance to cyclic straining, webstitched fabrics are often used as backings for artificial leather, industrial coated fabrics, and other purposes.

Stitchbonded fabrics made from yarns are produced using the Malimo (East Germany) technology. These fabrics are made with three sets of yarns. A warp system is fed from a warp beam. A set of weft

threads is laid at an angle with the warp by means of a carrier. The warp and weft are stitched together using a third system — sewing yarns fed from a beam by means of compound needles. For stitching, a chain stitch as well as the tricot stitch can be used. It is possible to use all types of spun and continuous filament yarns for fabric manufacture. The range of fabric weight is 100 to 800 g/m². The fabrics usually are subjected to processing operations similar to those of woven fabrics.

Many types of fabric for apparel, household, and industrial end uses can be produced by the Malimo technology. The mechanical properties of yarn stitchbonded fabrics are similar to those of woven fabrics: good form stability, elasticity, drapeability, and thermal insulation characteristics. The tensile tenacity may reach 8 to 10 cN/tex lengthwise and 4 to 5 cN/tex crosswise, depending on the kind and density of yarns and stitch used.

There are several techniques for producing loop-pile nonwoven fabrics, developed mainly on the basis of the Mali machines (East Germany) already mentioned. In the first of these technologies, known as Voltex, the fiber web is used to stitch pile loops on the existing basic fabric (conventionally woven, knitted, or nonwoven). The fabric produced has a loop-pile cover on one side. The range of basic fabric weight is 40 to 200 g/m². The weight of wool or man-made fiber web varies from 40 to 80 g/m². These fabrics are used for interlinings, artificial fur, and other applications.

The second method of manufacture of loop-pile nonwovens, known as Malipol (East Germany), is based on the pile stitching principle. The basic fabric, in the weight range of 150 to 180 g/m², is the same as that in the Voltex technology. The loops formed by the tricot knitting stitch cover one side of fabric. The pile yarns may be spun yarns of various types. The applications are the same as those for Voltex fabrics.

An analogous principle for the production of loop-pile stitchbonded nonwoven fabrics is also used in the Araloop (Czechoslovakia) and Kraftamatic (England) machines. The stitchbonded loop-pile fabric is produced from three sets of yarns on a Schusspol-type (East German) machine. The basic construction of the nonwoven is formed on the same principle as in Malimo technology. The loop piles are arranged by means of special mechanisms. The one-sided pile cover of man-made fiber yarns is stable and resistant to abrasion. The fabric serves for household uses (furnishing, carpets, etc.).

Pile fabrics also may be produced by flocking. This technique is carried out by the adhesive attachment of very short fibers (0.3 to 10 mm) in the erect position to the surface of a fabric. There are two basic methods for applying flock fibers: mechanical and electrostatic. After the flocking, the thermofixation process is carried out. The flocks are made mainly from man-made fibers. Pile height may be adjusted to suit the end use, which can be household goods or clothing, as well as some industrial applications, including backing for coated fabrics.

The mechanical properties of nonwovens in which a base fabric is used depend greatly on the characteristics of this basic construction element. The surface characteristics of a nonwoven obtained in this way will be determined by the pile system, its fiber composition, and the way in which the fibers or yarns are made up into a pile cover.

The main characteristics of the coated fabrics must be mentioned. They are fabric weight, thickness, tensile and tear strength, breaking extension, bending stiffness, resistance to cyclic bending, abrasion resistance, air permeability, transmission of water vapor, set after wetting and drying, and a number of particular properties influencing the performance of coated fabrics in actual use.

Bibliography

Böttcher, Peter, *Einsatz von Vliestoffzeugnissen und -verfahren in der Geotechnik*, 69, 557–561 (1988).

Collier, Ann M., *A Handbook of Textiles*. Exeter: Whetton, 1980.

Iljin, S. N., and M. Ch. Bernshtein, *Iskusstvennyye Kozhi*. Moscow: Legkaya i pishtchevaya promyshlennost, 1983.

Martin E., “Material- und konstruktionsabhaengige Eigenschaften von Geotextilien,” *Chemiefasernl Textilindustrie*, 36, 88, 114–115 (1986).

Matukonis, S., J. Palaima, and A. Vitakauskas, *Tekstiles medziagotyra*. Vilnius: Mokslas, 1976.

McConnell, R. L., M. F. Meyer, F. D. Petke, W. A. Haile, "Polyester adhesives in nonwovens and other textile applications," *J. Coated Fabrics*, 16(1), 199–208 (1987).

"Vliesstoffe auf der Techtexil '86," *Chemiefasern/Textilindustrile*, 36, 88, 581–587 (1986).

Nonwovens as Coating and Laminating Substrates

114.1	Introduction	114-1
114.2	Substrate Structures.....	114-2
	Spunbonded Webs • Carded Unidirectional Webs • Carded, Cross-Lapped, Needleponched Webs • Air-Lay Needleponched Webs • Poromerics • Hydraulically Entangled Webs • Wet-Lay Mats • Stitchbonded Materials	
114.3	End-Use Applications	114-4
	Home Furnishings • Construction Uses • Automotive: Landau Tops, Interior Paneling, and Car Seats • Consumer Products • Filtration: Microporous Membrane Substrates • Industrial Applications	
	Bibliography	114-6

Albert G. Hoyle
Hoyle Associates

114.1 Introduction

Before the advent of nonwovens, substrates available for coating and laminated products were woven and knit fabrics made out of spun yarns, mainly of cellulosic base. Properties of such fabrics were sharply defined and limited. They could be varied somewhat by changing the weave pattern, the yarn size, and the weight of the product. As a whole they were thick, had poor tear strength when coated, tended to lint, were uneven, had comparatively rough surfaces, and had holes or voids where the yarns intersected — poor properties when very thin and even coatings were needed.

Initial nonwovens of the carded and random air-lay type composed of synthetic fibers were an improvement in some respects but not all. Carded unidirectional webs were of good quality even at medium to low weights, but they were stiff and had too high an elongation for some end uses, as well as poor cross-directional strength and poor tear strength. Random air-lay fabrics had good isotropic strength and fair tear strength at low binder levels, but their quality was too poor for use as a coating substrate at anything lower than a weight of 85 g/m².

The introduction of finer deniers and continuous filament yarns in woven and knit fabrics used in coating substrates overcame some of the deficiencies of the spun yarn woven and knit fabrics, such as evenness of cover, roughness of surface, and minimum thickness. They also were an improvement over the initial nonwovens used, especially in regard to strength, strength/weight ratios, drape, and conformability for molding. However, these materials are much more expensive than either nonwovens or spun yarn wovens and knits.

Development of newer and finer fibers, binders, and processes for assembling them into nonwovens has resulted in a diversity of nonwoven substrates that are economically competitive and suitable functionally for use as substrates in the majority of coating and lamination applications.

Coated substrates are used in the following areas: home furnishings, construction, automotive, consumer products, filtration, and industrial applications.

114.2 Substrate Structures

114.2.1 Spunbonded Webs

Because of its diversity, ideal strength/weight ratio, and economics, the spunbonded web has the most potential for growth in the area of coating and laminating substrates. Thirty percent of the nonwovens made today in the United States are made by this process.

Spunbonded nonwovens are formed by extruding the proper formulation through a spinneret. The extruded continuous filaments are injected into an airstream, where they are drawn out and randomly distributed onto an open conveyor belt. Spunbonded filaments can be all of one composition or they can be coextruded filaments of two different compositions. Bonding of these materials can occur in a number of ways: thermobonding, either area of point bond, latex saturation, needlepunching, or hydrogen chloride gas bonding. The material can be made in a range of fiber fineness (denier/filament) to give an assortment of properties such as cover, quality, softness or stiffness, and strength. By changing the draft ratio as the material is deposited onto the conveyor from the extruder, one can achieve isotropic strength, unidirectional strength in the machine direction, or unidirectional strength in the cross-machine direction. In most instances, balanced strength in both directions appears to be the most desirable.

114.2.2 Carded Unidirectional Webs

Carded unidirectional webs are made by blending fibers of required polymeric composition and fineness, opening and mixing the fibrous blend, and feeding it into a card to form a web or mat having the fibers oriented predominantly in the machine direction. Bonding can occur in one of two ways: by incorporation of a binder fiber or powder in the fibrous mat, followed by the application of heat and pressure, or by application of a latex to the mat, followed by drying and possibly calendaring. In both instances, the web is thoroughly bonded together in length, width, and thickness. The fabric can vary considerably in stiffness, strength, and extensibility depending on the type and amount of binder that is applied. The web is stronger in the machine direction (MD) and more extensible in the cross-machine direction (CD) because of fiber orientation, but MD/CD strength ratios can range from 6 to 2 depending on fiber and binder selection and processing used.

114.2.3 Carded, Cross-Lapped, Needle punched Webs

Carded, cross-lapped, needlepunched webs are made almost identically to the unidirectional ones except that they are processed through a cross-lapper after the carding step. This takes the fibers from a unidirectional machine direction orientation to an orientation in a direction diagonal to each other, and predominantly at 45° to the right or to the left of the (vertical) machine direction. This results in a fabric that has a balanced strength and extensibility in both machine and cross-machine directions. Bonding is performed by needling alone or combined with thermal bonding using a gapped calender. Coarse denier fibers (6 denier/filament and up) in the staple length range of 5 to 18 cm are used for this.

114.2.4 Air-Lay Needle punched Webs

The air-lay needlepunch process uses the same type of opening and blending used for the carding process. The differences lie in the manner in which the fibrous web is formed and in the fiber orientation in the web. A carded web is mechanically formed and machine-direction oriented; the resultant nonwoven is

stronger in the machine direction. An air-lay web is formed by opening the fiber, air transporting it to a rotating cylinder or a flat screen using a rapidly rotating tooth roll (licker-in roll) and a vacuum, releasing the vacuum, and transferring the web to a conveyor, where it proceeds to the bonding step. When the fiber is deposited onto the conveyor from the airstream by evacuating the air through the screen conveyor, it is deposited in a random manner, forming a web that is truly isotropic. Both long staple (2.5 to 7.5 cm) and short staple (0.3 to 2.1 cm) fibers can be processed into a nonwoven using this method, but different pieces of equipment are necessary (i.e., one being more suited for processing long staple fiber, the other for short staple fiber). The minimum weight at which a good quality web can be made, using this process and long staple fiber, is 75 g/m². Attempting to make lighter weights results in blotchiness and a generally poor quality in the webs. Coating substrate webs of this type are very rarely less than 85 g/m². After air-laying, the web is further processed by needlepunching.

Needlepunching depends on mechanical fiber manipulation to achieve the bonding effect. Manipulation consists of entangling fibers with each other by the use of barbed needles penetrating and receding from the web as the web is conveyed under a reciprocating bed of barbed needles. Needle configuration, needle length, barb shape, and barb spacing serve to give varying degrees of entanglement. The bonding formed in this process is more a series of three-dimensional floating anchor points rather than rigid bond points in a planar structure. The product formed is extensible, bulky, conformable, distortable, and extremely absorbable. Should bulkiness, absorbability, and decreased extensibility be required with additional strength and increased rigidity, this could be accomplished by adding thermal binder fiber to the fiber blend before making the air-lay web and passing the needlepunched material through a gapped hot calender to thermally bond it, in addition to bonding by needlepunching alone.

114.2.5 Poromerics

Poromerics or synthetic leathers are made using a nonwoven fabric as a base and selected polyurethane formulations as impregnants and coatings. The base nonwoven can be used as a substrate for other waterproof, air-permeable coated fabrics as well, using a vinyl formulation for coating. The nonwoven mat blend using fibers of a very fine denier, a portion of which is a high shrinkage fiber, is made either by carding and cross-lapping or by air-laying. A very light preneedling on one surface to give the web integrity for conveying without distortion is followed by intense needlepunching from both outer surfaces (400 to 1800 punctures/cm²) to densify the web and give it leatherlike fiber orientation. To give the material density to act as a leatherlike substructure, further densifying is accomplished by passing the fabric through either wet or dry heat and shrinking it 30 to 50% in the machine direction. Then the material is impregnated and/or coated to form a synthetic leather.

114.2.6 Hydraulically Entangled Webs

Hydraulic entanglement is the process of entangling individual fibers with each other by using water jets with varying degrees of water pressure. The higher the water pressure, the greater is the degree of entanglement. Depending on the backing substrate used during the entangling process, one can get a product that has a uniform surface or one that is apertured. Most coating substrate end uses require a uniformly surfaced product. In a sense, one can consider hydraulic entangling to be a hydraulic needlepunching process. While hydraulic entanglement produces a material that is flatter and thinner than a needlepunched one, the bond formed has a lot in common with that produced by needlepunching. It is more like an anchor point than a rigid bond point, and the fabric made — like some needlepunched fabrics — tends to have low elastic recovery.

114.2.7 Wet-Lay Mats

The majority of the fibers used in wet-lay processing are in the length range of 0.3 to 0.6 cm. In papers, the fiber used is mostly wood pulp. In nonwovens, synthetic fibers, glass fibers, mineral fibers, and regenerated cellulose fibers are used as well as wood pulp. The ones most used are polyester, polyolefin,

glass, and rayon; occasionally polyamide, aramid, vinyl chloride–vinyl acetate copolymer, and acrylic are also used. More and more, however, longer lengths are being introduced to increase the strength, cohesiveness, and toughness of wet-lay nonwovens. As in dry-lay processing, the fibers have to be opened, dispersed, and carried to the web forming stage. The difference is that in dry-lay the transportation medium is mechanical (carding or garneting) or air, whereas in wet-lay the transportation medium is water. This process, wet-lay, resembles more the air-lay than the mechanical process. In both, the fiber is injected into, dispersed in, and carried by a fluid medium to a flat or a rotary screen, where the fluid is extracted and the fiber deposited onto the screen as a randomly oriented mat.

There are three main processes for wet-lay structuring: flat wire, inclined wire, and rotary wire cylinder. The one to use depends largely on the mat weight needed, the drainage properties of the fiber, and the fiber diameter. Wet-lay mats commonly used as coating substrates are bonded by using latex or by thermal bonding. In latex bonding the latex is either added to the fiber dispersion before web formation or flooded onto the wet-formed web in a second wet deposition step on the wire as the wet fiber mat goes by the second flooding station. These steps are normally followed by through-air drying and a series of dry cans to complete the process. Thermal bonding is accomplished by adding a thermal binder fiber to the initial fiber blend and following wet web deposition and drying with a hot calendaring step to activate the binder fiber. Because of the multiplicity of fibers present in the mat due to the short length of most wet-lay fibers, the mats are of extremely good quality and are isotropic. Wet-lay mats tend to be very even, flat, and thin, and they can have MD and CD strength that is quite high, with a stiff or soft handle, depending on the type and amount of binder present.

114.2.8 Stitchbonded Materials

Stitchbonding is the process of bonding a web by using stitching yarns, filaments, fibers, or just the stitching needles themselves to do the bonding. In many respects, a stitchbonded fabric resembles a woven fabric in its properties, and that is because its construction is similar in many ways to a woven fabric. In some ways, it also resembles a needlepunched or hydraulically entangled fabric, especially in the lighter stitching constructions and when no yarn or thread is used in stitchbonding.

114.3 End-Use Applications

114.3.1 Home Furnishings

114.3.1.1 Tablecloths

The nonwoven substrate for tablecloths could be a spunbond, a needled material, or a hydraulically entangled one. The substrate would be coated with a nonblocking vinyl formulation, dried, then color printed and/or embossed for aesthetic reasons. Properties needed in the substrate are softness, flexibility, isotropic strength, and puncture or snag resistance. The substrate could be a polyamide spunbonded with an acrylic latex binder, a needled polyester–rayon blend, or a hydraulically entangled polyester in the 45 to 55 g/m² range.

114.3.1.2 Upholstery

A typical nonwoven substrate for vinyl upholstery would have the following specifications: weight, 140 g/m²; composition, 100% polyester fiber; process, needlepunching an air-lay or a carded cross-lapped material; tensile strength, 35 to 45 lb/in. MD and CD; and extensibility, MD 100%, CD 50%. Depending on end-use requirements, the substrate could also be composed of polypropylene, and it could be made using hydraulic entanglement or spunbonding as the bonding process.

114.3.1.3 Draperies

A suitable drapery composition would be a stitchbonded fabric coated with a pigmented opaque acrylic foam as an inner liner. Also acceptable would be a hydraulically entangled polyester used as a liner and

reinforcement for a woven fabric (i.e., a flame-retardant drape made using a woven fiberglass fabric and a hydraulically entangled vinyl chloride base fiber web as a liner.

114.3.2 Construction Uses

114.3.2.1 Vinyl Floor Tile Reinforcement

A spunbonded, heat-bonded, copolyester fabric, weighing 50 g/m², with an MD and CD tensile strength of 35 to 40 lb/in., and an extensibility of 15%, MD and CD, is suitable as a floor tile base.

114.3.2.2 Roofing Membrane Substrate

A spunbonded polyester using an acrylic binder for heat resistance, instead of a copolymer thermal binder fiber system, in a weight range 25 to 100 g/m², is recommended as a roofing membrane substrate.

114.3.3 Automotive: Landau Tops, Interior Paneling, and Car Seats

A needlepunched, 100% polyester nonwoven laminated to a polyurethane foam on the bottom surface can be used as a coating base for a vinyl-coated fabric that is to be color printed and/or embossed. Substrates for tops are usually heavier, stronger, and less extensible than those used as substrates for car seats or door paneling. The needlepunched fabrics are made by carding followed by cross-lapping to bring the web up to the required weight, or they are made by the air-lay process. Substrates for landau tops are in the 225 g/m² weight range, while those for interior paneling and car seats are in the 140 g/m² range.

114.3.4 Consumer Products

114.3.4.1 Outer Garments, Handbags, and Luggage

Substrates for outer garments and luggage could be needlepunched fabrics with a high needled density to give good fiber entanglement and high strength, or highly hydraulically entangled materials with sufficient strength and weight for the particular end use. High tenacity polyester fiber would be preferred for use in these two instances because of the wear and abrasion associated with outer garments and luggage. Handbags can be made using hydraulically entangled materials with somewhat lower tensile strength, weight, and bonding, since physical property requirements for handbags are less stringent.

114.3.4.2 Clothing Labels and Wash-and-Wear Labels

Clothing labels are normally made with a medium to lightweight polyester spunbond that is impregnated and coated with a filled acrylic. The coating formulation and printing inks are selected for maximum printability, print durability, and fastness to washing and dry cleaning.

114.3.4.3 Footwear

A polyester-based poromeric material impregnated and coated with a suitable polyurethane formulation is an excellent leather substitute for shoes of all types.

114.3.5 Filtration: Microporous Membrane Substrates

Nonwoven fabrics per se are used in large volume as filtration media of all types. When used as coating substrates, their function is as a supportive reinforcement for a host of microporous membrane materials. Micromembranes, by the nature of their functionality, and for maximum filtering output, need to be as thin and as even as possible. To be ideal as a support and reinforcement, the substrate needs to have maximum isotropicity, evenness, and strength. Materials likely to be used as substrates for microporous membranes are (a) polyolefinic and polyester spunbonds, thermally bonded, made from fine denier fibers, with a high percentage of binder fiber and high calendering to achieve a very smooth surface for

coating, and (b) wet-lay polyester or polyolefin mats with suitable latex or thermal binder systems, fine denier fibers, and calendering as the final finishing step to effect a smooth and even coating surface.

114.3.6 Industrial Applications

114.3.6.1 Tape Base

A 100% polyester unidirectional carded web containing a fiber binder and heat calendered to effect a high degree of bonding for strength and low extensibility makes an ideal tape base. In addition, it requires low MD and CD heat relaxation shrinkage (1 to 2%) to prevent curling of the coated product in the drying tower. Proper selection of the carrier fiber and the binder/fiber ratio are extremely important in these products.

114.3.6.2 Coated Papers

Lightweight polyolefinic and polyester spunbonds are suitable for use as coated papers when the coatings contain filled binders designed to give good wet strength, printability, and good abrasion resistance.

114.3.6.3 Flocked Fabric Substrate

Substrates being used for the flocked fabric market are lightweight spunbonded polyolefins and polyamides, latex-bonded, carded, calendered materials of various compositions, hydraulically entangled fabrics, and wet-lay mats.

114.3.6.4 Electrical Insulation

Unidirectional, carded, highly calendered, thermally bonded 100% polyester webs containing a high ratio of binder to carrier fiber are used extensively as electrical insulation. Impurities, which are electrically conductive, cannot be tolerated even in trace amounts in this product. Evenness in thickness and weight, both crosswise and lengthwise, is very important for further processing (impregnation with a resin and/or lamination to a polyester film) as well as for end uses in motor and transformer windings and slot insertions. Carrier fibers and binder systems are constantly reassessed to improve higher temperature end use, which is directly related to greater motor efficiency. Most products are in the weight range of 20 to 100 g/m².

Bibliography

- Hoyle, A. G. "Properties and characteristics of thermally bonded nonwovens," in *TAPPI Nonwoven Division Workshop on Synthetic Fibers for Wet Systems and Thermal Bonding Applications*, Technical Association of the Pulp and Paper Industry, 1986, pp. 51–54.
- Hoyle, A. G. "Bonding as a nonwoven design tool," in *TAPPI Nonwovens Conference*, 1988, pp. 65–69. *Nonwovens Industry*. Rodman Publications Inc., Ramsey, NJ.
- Nonwovens World*. Atlanta, GA.
- Textile World*. McGraw-Hill Publications Company, New York.

115

General Use of Inks and the Dyes Used to Make Them

115.1	Ink-Jet Inks.....	115-1
115.2	Marker Inks for Children.....	115-2
115.3	Writing Inks.....	115-3
115.4	Permanent Inks.....	115-4
115.5	Dyes Used in Permanent Ink Systems.....	115-4
115.6	Current and Future Aspects.....	115-4

Carol D. Klein
Spectra Colors Corp.

The types of inks manufactured and their applications are so varied. The following is a general classification of inks and the colorants used in them. Generally, the main two colorant classifications are dyes and pigments — the main difference being that dyes are soluble while pigments are not. Some of the ink areas a dye supplier can focus on are ink-jet inks, marker inks for children including highlighter and disappearing inks, writing inks, stamp pad inks, ballpoint pen inks, ribbon inks, permanent inks, and artists' inks. Appropriate dyes must be specifically qualified and developed for each type of ink. The dyes listed below must be tested in the ink system to conform to low insolubility levels, purity, viscosity, surface tension, strength, shade, and solubility.

115.1 Ink-Jet Inks

Ink-jet inks can be water or solvent based. Many dyes used in other areas mentioned in this article are also used in ink-jet inks. The success of an ink-jet ink is extremely dependent on the relationship between the ink, the cartridge, and the substrate to be printed on. An aqueous-jet ink cannot be used in all aqueous ink-jet cartridges. The formulations stated in this article are good starting points for ink-jet inks as well. Purity of the ink is necessary, and many dyes used in ink-jet inks are filtered to the submicron range. Many characteristics of the ink, such as surface tension, viscosity, shade, color intensity, drying time, and light- and waterfastness, can be altered with minor modifications.

The main dyes used in aqueous ink-jet inks are as follows:

- Acid Yellow 17
- Acid Yellow 23
- Direct Yellow 11
- Direct Yellow 86
- Direct Yellow 107
- Direct Yellow 127
- Reactive Yellow 15

- Acid Red 52
- Direct Red 75
- Reactive Red 195
- Acid Blue 9
- Direct Blue 199
- Reactive Black 5
- Direct Black Liquid

Some ink-jet systems are based on solvent-based inks such as alcohol and methyl-ethyl-ketone (MEK), and hot-melt systems. Spirit-soluble, solvent-soluble, and oil-soluble dyes are generally used in these systems.

115.2 Marker Inks for Children

The issue of safety is foremost in the production of any product intended for use by children. The information presented below is just a guide and can be altered to adjust drying time, surface tension, viscosity, or any other property that is critical. The ability to wash ink from clothing and skin can be improved by replacing propylene glycol with one of the longer-chain polyethylene glycols.

A typical aqueous ink formulation for use by children is as follows:

Deionized water, 70 to 80%
Propylene glycol, 20 to 30%
Dye, 1 to 5%
Biocide, <0.5%
Surfactant (optional), <0.5%

The main dyes used in children's inks are as follows:

- Acid Yellow 17
- Acid Yellow 23
- Acid Red 1
- Acid Red 52
- Acid Red 73
- Acid Red 87
- Acid Red 388
- Basic Red 14
- Acid Blue 9
- Acid Blue 93
- Solvent Green 7
- Acid Violet 17
- Acid Black 2

The marker system is critical to ensure proper flow of the ink to the substrate. The ink flows by capillary forces from the reservoir, where it is held in the marker, through the nib and onto the substrate. The reservoir is generally made of synthetic fibers, such as polyester or cellulose acetate, and the nib can be made of bonded fibers, such as polyester or acrylic, felt, extruded plastic, or molded plastic.

The dyes used in children's markers must meet certain specifications, and many dyes, other than those mentioned, are available. Specialty types of inks are also made for children's products, such as highlighter, color-changing inks, and disappearing inks.

The following are dyes used for highlighter inks:

- Acid Red 52
- Acid Red 87
- Acid Red 388
- Basic Red 14

- Acid Blue 9
- Direct Blue 86
- Solvent Green 7

Listed as follows are dyes for color-changing and disappearing inks:

- Direct Yellow 4
- Acid Orange 7
- Basic Red 14
- Acid Blue 93
- Solvent Green 7
- Acid Green 3
- Acid Violet 19

The color-changing and disappearing features of the inks are formed by altering the pH of the dyes.

115.3 Writing Inks

Markers designed for writing are mostly also based on the capillary flow of the ink. The nibs can be fiber, extruded or molded plastic, or roller ball. The surface area of the nib is generally much smaller than that of the children's markers nibs. Aqueous ink formulations can be very similar to children's marker inks. However, due to the smaller surface area of the nibs, a balance must be obtained to ensure that the nib will not dry out too quickly when the cap is off, but will dry quickly enough on the substrate to avoid smearing. Also, the surface tension must be low enough to allow the proper flow but high enough so that feathering does not occur on the paper. Color intensity must be increased, as the width of the written line is very thin. Using the same formulation previously given and making minor changes for the various nib types will result in good and safe ink performance. Direct dyes are often used in these types of markers, as direct dyes generally have better waterfastness than acid and basic dyes.

The following are dyes used in writing inks:

- Direct Yellow 11
- Direct Red 81
- Direct Red 254
- Direct Blue 86
- Direct Blue 199
- Direct Black Liquid

Aqueous pigment dispersions are also used for greater permanency. Stamp pad inks are generally based on the same dyes that children's marking inks and writing inks utilize. The solvent system usually contains slower evaporating solvents, such as glycerin and glycol, and less water due to the large surface area of the stamp pad that is exposed to air for long periods of time.

Pens designed for writing are usually ballpoint nibs and have an open tube rather than a reservoir to hold the ink. Some of the solvents that are used are oleic acid, Dowanol EPH, glycol ethers, benzyl alcohol, as well as resin and dye. Ball pen inks are typically very viscous compared with other writing inks. The following are dyes used in ball pen and ribbon inks:

- Solvent Orange 3
- Solvent Red 39
- Solvent Red 49
- Solvent Blue 4
- Solvent Blue 38
- Solvent Blue 43
- Solvent Violet 8
- Solvent Black 7

- Solvent Black 46

These same dyes are also used in ribbon inks and usually contain oleic acid as the main solvent.

115.4 Permanent Inks

Permanent inks are used in both broad and fine-lined markers. As the effort to provide safer solvent systems continues, more systems are based on water, glycol ethers, and alcohols, although some systems are still based on xylene.

The water-based permanent systems are usually based on aqueous pigment dispersions that have a resin as a binder. The glycol ether and alcohol systems can use the same type of dye — spirit soluble. Again, a balance must be obtained in drying time using a slower-drying organic solvent in conjunction with the quicker-drying glycol ether or alcohol. A resin is also used as a binder for nonporous substrates.

A permanent ink formulation is as follows:

Alcohol or glycol ether, 70 to 85%

Resin, 10%

Glycol (optional), 5 to 10%

Dye, 5 to 10%

Many artist marker inks are based on this type of formulation.

115.5 Dyes Used in Permanent Ink Systems

The following are some of the dyes used in permanent ink systems:

- Solvent Yellow 25
- Solvent Yellow 88
- Solvent Orange 11
- Solvent Red 39
- Solvent Red 125
- Solvent Red 127
- Solvent Blue 38
- Solvent Blue 67
- Solvent Blue 70
- Solvent Black 5
- Solvent Black 28
- Solvent Black 29

This is a brief overview of the types of inks and the colorants used in them. Many other specialty inks can be formulated using the information given with a few slight modifications. As the ink industry is continually looking for safer and better products, the colorant industry has already started modifying and manufacturing products to meet their needs.

115.6 Current and Future Aspects

- Make liquid dyes from powder
- Tailor dye specifications to customer's demands
- Manufacture dyes for customer's specific product and application
- Consider a few of the potential areas for use of dyes:
 - Infrared inks
 - Ink-jet inks
 - Ribbon inks

- Marker inks
- Ballpoint inks
- Food
- Cleaners
- Cosmetics
- Drugs
- Wax
- Textiles
- Detergents
- Coatings
- Leak detection
- Plastics
- Paper
- Leather
- Candles
- Shoe polish

116

Gravure Inks

116.1	Introduction	116-1
116.2	Process	116-2
116.3	Substrate	116-2
116.4	Vehicles	116-2
116.5	Colorants	116-3
116.6	Formulations	116-3

Sam Gilbert
Sun Chemical Corporation

116.1 Introduction

Gravure is a high-speed printing process usually based on roll-to-roll mechanics. There are three basic gravure markets — publication, packaging, and product (or specialty).

Publication gravure is an exceptionally high speed, four-color process printing method, the primary function of which is the reproduction of text and pictures. The substrate printed is a very thin, generally low-basis weight paper. The primary end products include catalogues, magazines and newspaper inserts. Packaging gravure is a somewhat slower variation of the process using the same mechanics but not based solely on four-color work. The substrate range is also much wider — including film and foil as well as paperboard and paper label. Spot colors and coatings are often included. In packaging, the ultimate printed product is a package, in which the printing not only decorates the product but may also serve a functional purpose, such as a barrier. Product printing, like packaging, is relatively low speed. Substrates range from plastics to metals to paper. The end products include floor coverings, swimming pool liners, postage stamps, and wood grain materials for furniture or wall covering.

The process is based on printing from a recessed image that is engraved or etched into a metal cylinder. The cylinder is placed into a pan containing the ink. Excess ink is removed by use of a metal or plastic blade, and the ink left in the cells is then transferred to the substrate.

In recent years, there have been many pressures for changing the process. Some of these changes are being government regulation driven and some are cost driven. Print quality in gravure is quite high, and the challenge has been to respond to the need for change without loss of quality. Another area of challenge is the recent upsurge in Flexo print volume. As Flexo print quality has improved, and improved markedly, many jobs previously printed gravure have moved to Flexo. This is primarily a cost function when quality is perceived as equal or mutually satisfactory.

As changes in gravure have occurred, the inks have had to evolve as well. We are, therefore, seeing many changes in the solvents, resins, and additives used for gravure.

In gravure, whether publication or packaging, the amount of ink transferred to the substrate depends on the cell volumes and configurations, the substrate used, and the ink formulation. The actual print strength obtained depends on the colorant, the ratio of colorant to vehicle, and the viscosity of the applied material. The gravure system of using an engraved cylinder and wiping off excess ink gives very high print quality and positive control over the process. The process lends itself to long runs, but cylinder costs can be high.

116.2 Process

Gravure printing is based on the use of rigid cylinders. In publication, the cylinders are chrome-plated copper. In packaging or product gravure, alternative materials, such as plastic, are used as well. In publication, both sides of the roll are printed, then slit and folded at the end of the press. It is common in packaging and product gravure to run roll-to-roll using paper, plastic, or metal substrates.

The image is created by engraving the cylinder, forming cells that will hold the ink. The engraving process can be mechanical, chemical, or laser. Laser is experimental, and its importance in the future is still to be determined.

The engraved cylinder is rotated in a pan (called the fountain) that holds the ink. Excess ink that is picked up by the cylinder from the fountain is removed by using an oscillating blade made of steel or other materials, called the doctor blade, that is positioned in the roll direction. This leaves the ink in only the recessed cells after being wiped off by the blade. The ink in these cells is then transferred to the substrate and dried in an oven. Further work on the now printed web is determined by the end use. The web may be rewound for more work later, may be laminated, or may be finished at this time.

116.3 Substrate

In gravure, the substrate to be printed is highly critical. Is this publication gravure, and are we printing a very thin paper? Or, is it packaging gravure, and are we printing a wide range of materials, such as paper, board, polyolefins, polyesters, nylons, foils, metallized films, coextruded films, etc.? As previously discussed in flexography, the attributes desirable in the finished package will usually determine the substrate or substrates to be used. Surface printing or lamination is also decided on by the product needs. What is to be packaged? Is it solid or liquid? Is it fragile or flexible? Is the product perishable, corrosive, or moisture or light sensitive?

Obviously there are too many variables to be listed here. They all affect the final package appearance and affect the decision as to what materials we will use in the inks.

For publication gravure, the paper as mentioned is very thin, and it is printed on both sides. The choice of inks is then critical, as they must not penetrate through the paper. What is printed on one side cannot interfere with the appearance of the print on the other side. This is generally not a concern for packaging.

116.4 Vehicles

The actual ink vehicle to be used is determined after the substrate is chosen and when the end-use properties have been defined.

The vehicle used for publication is determined by the thin paper substrate, print speed, and the low costs necessary for catalogues or inserts. Packaging vehicles, on the other hand, are dependent on the substrate and the end use specified, but the cost considerations are much more flexible. What material is to be packaged? How is the package to be finished — by lamination or surface print? Do we need special properties, such as product resistance, scuff resistance, slip, or outdoor storage resistance?

As in flexography, the first decision is resin. What resin or combination of resins will give us adhesion to the substrate? How do we have to modify the resin to obtain the other necessary properties?

The vehicle is made up of resin or resins, solvents, and additives. The resins are expected to provide the bulk of the properties:

1. Adhesion
2. Gloss
3. Product resistance
4. Printability
5. Viscosity
6. Solvent release

The solvents dissolve the resin and act as carriers for the colorants and provide flow and viscosity to the ink. The additives provide those properties that the resins lack, such as rub, slip, etc. The colorant-to-resin ratio and the resin-to-solvent ratios provide printability and color intensity. Gravure, normally, applies a higher ink film thickness than does Flexo, and to obtain the same color strength, a lower colorant concentration is used for gravure.

Because gravure is printed from an impervious, rigid cylinder, a wide range of solvents can be used:

1. Aliphatic and aromatic hydrocarbons
2. Acetates
3. Alcohols
4. Ethers
5. Ketones
6. Water

Because plate swelling is not an issue in gravure, the solvents used can be much more active than the solvents used for Flexo. This means that a much wider range of resins can be used in the gravure process. Recently, there has been a lot of concern relative to the safety and health attributes of some solvents. Aliphatic hydrocarbons and ketones have both been at issue. Much work is being done to try to eliminate the use of these solvents. This work will probably make for major changes in publication and packaging gravure in future years.

116.5 Colorants

Colorants are the materials that give an ink its color. In gravure, this may include pigments or dyes. A wide variety of materials can be used as pigments. Metals, fluorescents, inorganic colors, and organic colors are included. Color selection is critical and is dependent on the end use of the material to be printed.

The colorant-to-vehicle ratio in an ink determines the ink strength as well as its printability and viscosity of application. The colorant is dispersed in the vehicle so that agglomerates are eliminated and all surfaces are coated with the vehicle. If excess vehicle is present, color intensity may be weak. If insufficient vehicle is present, properties of the finished item may suffer. The proper ratio produces good flow in the ink and good color strength and excellent finished properties.

Color strength in the finished product is controlled by printing viscosity, all things being equal. High viscosity gives more color but may create other problems. Low viscosity reduces color strength but may require better drying to eliminate retained solvent from the resin.

116.6 Formulations

Formulations are primarily solvent based. A lot of work has been done to create water-based publication inks. At present, this has not been successful, and solvent systems continue to be used with incineration or recovery of the solvent. In packaging, water has been used in a few applications, but this has also been limited, and traditional solvent inks continue to prevail.

The typical formulations for all three gravure processes are generally similar. Typical solvent systems are as follows:

- Color, 5 to 10%
- Resin, 25%
- Additives, 1 to 5%
- Solvents, balance

With as many variations as can exist in gravure, a typical ink formula could be very misleading. This formula is, at best, a generalization.

Artist's Paints: Their Composition and History

Michael Iskowitz
Kop Coat Marine Group

The aim of this chapter is to inform the professionals in the coatings industry (i.e., chemists, technicians, and color specialists) of the composition and character of artist's colors, while giving the artist, art student, salespeople, and corporate management a better understanding of the materials with which they work.

The oldest and most renowned coatings devised by man are artist's colors. The use of artist's colors coincides with the first use of coatings by mankind. Specifically, this is seen in the cave paintings of the Cro-Magnon era.

Coatings, along with early man, developed slowly. The next development in artist's colors came during the age of the Pharaohs. Possibly as early as 8000 B.C., but probably around 4700 B.C., the ancient Egyptians developed watercolor essentially in its present form.

Europe provided the next advance in artist's colors. In the year 1400 A.D., the Flemish developed tempera paint from egg yolks. This technology had spread to Venice by the early 15th century. Tempera paintings that showed technical excellence were being produced on a regular basis. At the same time, artists in Europe were learning to refine linseed oil into the mucilage free form by which linseed oil is recognized. The first published works on purification of linseed oil appeared in the year 1400 A.D.

As a necessary adjunct to linseed oil, the distillation of turpentine on a commercial level began in Venice in the early 15th century. As a result, the term "Venice Turpentine" came into existence and is used by artists to this day. At this time, the easel was also developed, and the use of artist's materials moved away from craft applications to that of "pure art."

The next stage in the development of artist's paints occurred in the United States. In the 1920s and 1930s, the first crude latices that could be used as vehicles for artist's colors were developed. These were inferior in quality and not very well received. As technology improved and better latices were made, better finished products developed. In the late 1940s, artist's acrylic colors were introduced into the marketplace. However, artists did not fully accept these as a useful quality product until the 1960s.

At the same time as the first styrene-butadiene latex products were being introduced in the 1920s, Dr. Joseph Mattiello was developing alkyd resins. Art materials companies began using these as an inexpensive partial or complete substitute for linseed oil in oil colors. Acceptance of these colors took a fairly long time. By the early 1980s, alkyd oil colors began to appear in stores, and they began to receive public acceptance.

In the 1990s, the last development in artist's color technology occurred. This was the advent of water-thinnable oil color. The old adage that "water and oil do not mix" was disproved by advances in technology. Water-thinnable oil colors have been readily available since 1993.

A few basic terms need to be explained before beginning a technical discussion of artist's colors. Reference will be made to the term "vehicle." A vehicle is the liquid portion of a paint. It is the part of

the paint that forms a film. A synonym for vehicle is binder. Vehicles come in many types. The types that will be discussed in this chapter include oil, tempera (based on egg yolks), watercolor (based on gums, sugar, and starch), alkyd (normally a polyester), and latex (plural is latices, chemically these are emulsions).

Artist's colors are generally sold in two grades: professional and student. The professional grade is generally used by those who make a living by producing and selling their artwork. The student grade is intended for use by students who aspire to a career in art.

There are many differences between the two grades. The professional grade generally contains high percentages of pure color (pigment). Student grade is normally characterized by lower percentages of color. Very often, student grade does not contain the "pure color" that is listed on the label. In this case, the word "HUE" appears on the label. This means that a single pigment or combination of pigments is being employed to approximate the "pure color." Very often, the "pure color" is very expensive, while the hue is cheaper. In addition, the hue rarely has the brilliance of the "pure color." A further difference is that the student grade often contains extender pigments to help reduce cost while still maintaining the consistency (artist term for this is "feel") of the professional grade.

Artist's colors are produced in a number of vehicle systems. As vehicle systems evolved, so did pigments. This chapter will outline historical development of vehicles and enumerate their compositions. Conjointly, this time-line formulary will contain the pigments associated with the system at discovery time. It will also list those pigments in use today, as well as what they replaced. Discovery dates of pigments, as well as the approximate date of first usage in artist's colors, will also be listed.

The very first artist's color created by prehistoric man was a black made from charcoal. This was used for drawing. There was no binder involved — just pure charcoal put onto surfaces such as rocks, cave walls, and hides. Soon after charcoal came into use, early man began using mud, which was available in various colors. These muds were various shades of natural iron oxide pigments (yellow, red, and brown) and were applied directly to cave walls. As was the case with charcoal, no binder was involved, just pure color. These muds were derived from riverbanks, lakefronts, and other similar places. They were used to create the now celebrated Cro-Magnon cave paintings. The paintings were of stick figures. They were thin lines of mud smeared across a cave wall in the form of a recognizable animal or human shape. Art stayed at this stage until the ancient Egyptians invented watercolor.

Watercolor came into prominence around 4700 B.C. in ancient Egypt. For the most part, watercolor is based on a transparent pigment system. The background of a brilliant white comes from the paper, which is used as the substrate. It is utilized to make white and light tints. Pigmentation consists of both transparent and nontransparent colors. The nontransparent colors are applied in an extremely diluted state. These colors are diluted to the point where they are almost as brilliant as the transparent colors. There is an alternate pigment system that employs white pigment as an opacifier. The choice of pigment system, whether in ancient times or today, has always been left to the artist. Neither system is wrong nor better. The choice depends on the desired artistic effect.

The palette (pigment choice) available in ancient Egypt for use in watercolor included a host of pigments known from the dawn of recorded history. [Table 117.1](#) lists colors used by the Egyptians. The list is set up by color type. This is then broken down to individual colors designated by color title and composition.

The composition of the vehicle used to make watercolor is basically unchanged from ancient times. The major ingredients used by the Egyptians were gum arabic (a product of Somalia), water, sugar syrup, glycerin, dried extract of ox bile, and dextrin, which is derived from white potatoes. Some more modern formulae replace the sugar syrup with pure glucose. The ox bile can be replaced with modern wetting agents of the type generally associated with latex house paint production. The ancient Egyptians had no need to use a preservative, because arid conditions in Egypt produced an atmosphere in which bacteria could not survive.

There is a system of similar composition called Gouache (pronounced GWASH). This system uses the same vehicle but employs opaque colors, usually with extender pigment added to increase dry opacity. Both systems employ the same pigmentation types.

TABLE 117.1 Colors Used by Ancient Egyptians

Color Type	Pigment and Composition
Black	Lampblack (residual ash from burning candles) and to a lesser degree charcoal and boneblack (charred animal bones)
Blue	Azurite (naturally occurring basic copper carbonate) and Egyptian blue (a mixture of copper silicates)
Brown	Assorted, naturally occurring umbers and earth colors
Green	Malachite (basic copper carbonate)
Red	Native red iron oxide
White	Chalk (calcium carbonate) and gypsum (calcium sulfate)
Yellow	Ochre (native yellow iron oxide) and naturally occurring orpiment (arsenic trisulfide)

The following summarizes the purpose of each ingredient in the vehicle.

Ingredient	Purpose
Gum arabic	Binder and adhesive
Glycerin	Provides "wet edge" to improve brushability, also helps to prevent settling and caking
Sugar syrup/glucose	Plasticizer
Ox bile/wetting agent	Assists wetting pigment when grinding colors
Water	Carrier for the system

While the basic vehicle of watercolor has remained the same over thousands of years, the colors certainly have changed. A modern palette has many more options in each color group. Modern chemistry and some older chemistry have replaced much of the ancient palette.

The modern palette consists of the following colors.

Color Type	Pigment and Composition
Black	Lampblack, Ivory Black (carbon black), Mars Black (synthetic black iron oxide)
Blue	Ultramarine Blue (complex silicates of aluminum and sodium with sulfur), Cobalt Blue (an amalgam of cobalt oxide, aluminum oxide and phosphoric acid), Cerulean Blue (Latin for "sky blue"; any artist worth his salt would not be caught dead saying "sky blue" — chemically it is cobaltous stannate), Manganese Blue (barium manganate), Phthalocyanine Blue (copper phthalocyanine)
Green	Viridian (hydrated chromium oxide), chromium oxide (anhydrous), Green Earth (a concoction of native clays with iron and manganese creating the color; color varies from green to yellowish to bluish), Phthalocyanine Green (chlorinated copper phthalocyanine)
Red	Cadmium Red (all shades) — cadmium mercury sulfide coprecipitated with barium. Sulfate Alizarin crimson (1,2-dihydroxyanthraquinone laked onto alumina hydrate), Indian Red, Light Red, and Mars Red (all are different shades of synthetic red iron oxide)
Violet	Cobalt Violet (originally cobalt arsenate replaced by the less toxic cobalt phosphate), Manganese Violet (manganese chloride treated with phosphoric acid and ammonium carbonate), Mars Violet (synthetic iron oxide)
Brown	Raw and Burnt Sienna, Raw and Burnt Umber (Both Raw Sienna and Raw Umber are naturally occurring oxides containing both iron oxide and manganese dioxide. Today, in addition to naturally occurring grades, synthetic grades are being produced. The synthetics are more reasonably priced. One drawback of lower price is a loss of color brilliance. The burnt versions of these pigments are merely calcined versions of the raw color. Both are what artists call warmer colors than the raws. Chemists say both are redder.)
Yellow	All shades of Cadmium Yellow, from Pale (very green undertone) to Orange, have the same composition as Cadmium Reds described above. Natural and synthetic iron oxide. Strontium Chromate Hansa yellow (green shade, called Hansa 10 G is diazo-4-chloro-2-nitroaniline coupled onto 2-chloroacetalanide). The red shade is called Yellow 74. It is diazo-4-nitro-2-anisidine coupled onto 2-acetoacetanilide. Cobalt Yellow (cobalt-potassium nitrate) — artists call this color Aureolin because the color resembles the color of the Oriole bird. But why use the simple spelling? Let's make it fancy, for art's sake.
White	Chinese White (zinc oxide), Titanium White (titanium dioxide)

Now let us turn our attention to oil color. Oil color, which was invented in the year 1400 A.D., originally had a palette that was very similar to that of the ancient watercolor palette. The most noticeable exception is the addition of a white color called Flake White (basic lead carbonate). Technology to make basic lead carbonate dates back to the days of ancient Rome. Another color, which, if it did not exist in the year 1400, was available shortly thereafter, is Naples Yellow. In its original form, Naples Yellow was lead antimoniate. Today, it is made as a hue from a combination of Cadmium Yellow, zinc oxide and Ochre (Natural Yellow iron oxide).

As time went on, the modern palette evolved to the point where it matched the modern watercolor palette with the exceptions noted above. The composition of oil color is fairly simple. Generally, only three items are used in an oil color formula. They are the colored pigment, the oil (usually alkali refined linseed oil) and a stabilizer (normally aluminum stearate). Over the years, different grades of oil have been used to make oil color. In the beginning of the 15th century, only raw linseed oil was available. Soon afterward, purification by heating was discovered. At the same time, people learned how to make "sun-bleached linseed oil." This is made by mixing linseed oil with water and exposing the mix to sunlight. The water acts to remove impurities in the oil, while the sun bleaches and lightens the oil. After a few weeks or months of exposure, the oil is separated from the water and then used. In later years, oil made by this technique was called "superior linseed oil." By the 17th century, both stand oil and refined linseed oil were in common use. Stand oil is partially polymerized linseed oil. The oil is polymerized by heating it to $550 \pm 25^\circ\text{F}$ and maintaining that temperature for a few hours. This causes the viscosity to increase significantly. A number of other effects can also be seen. These include the excellent leveling and gloss. Upon aging in dry films, stand oil shows much less yellowing than regular linseed oil. Less polymerization occurs during drying, because it is partially polymerized during the heating process. This, in turn, leads to less yellowing.

Originally, refined linseed oil was refined by an acid process. The mechanism called for acid (usually sulfuric acid) and water to be added to the oil. This removes impurities and lightens color. The best grades have all the water and acid removed before packaging. While acid refined linseed oil is still available, it has, for the most part, been replaced by alkali refined linseed oil. Here, a strong alkali replaces the acid. The use of alkali to refine linseed oil often removes more impurities and provides better color than would be seen with the use of acid as the refining agent.

Occasionally, other types of oil are used in the formulation of artist's colors. The most notable of these is poppyseed oil. It is used mainly in whites, because it is naturally colorless. This makes a white paint made from it appear "whiter" than paint made from amber-colored linseed oil. Less frequently, walnut oil is used as a linseed oil replacement. Walnut oil has the same clarity as poppyseed oil, but, upon aging, it can turn rancid and give off a strong odor. While the paint is perfectly useable, the perception of quality is totally ruined.

Well-formulated oil-based paint dries to a glossy, durable finish. The pigment volume concentration (PVC) is low, especially when compared to other types of artist's colors. A good example of this is tempera paints. Tempera and oil color were invented at the same time, but, due to tempera's radically different composition, it dries to a flat finish. The finish is due to the high PVC of the paint. The high PVC is a result of the tempera vehicle. Tempera paint was the first emulsion paint ever created. This emulsion is a naturally occurring phenomenon. The basis of tempera is egg yolk. The yolk contains a water solution of albumin, a nondrying oil called egg oil, and lecithin. Each ingredient has its own function. The albumin is a binder. When heated, albumin will coagulate to form a tough, insoluble permanent film. A cooked egg is an example of this coagulation. Likewise, when albumin is diluted with water and spread out in a thin film to be dried by sunlight, it coagulates to form a film. The egg oil acts as a plasticizer, and the lecithin is an excellent emulsifier. All that is needed to create a tempera paint from the yolk is pigment and water. Over the years, egg yolks were replaced with other substances to form alternate tempera paints. These emulsions are based on any of the following: gum arabic, wax, casein, and oil. All have some degree of acceptance.

After the acceptance of oil and tempera colors in the 15th century, creativity to develop new vehicles fell into a dark age. Yes, pigments did continue to develop. However, vehicles did not. The next few

changes in vehicle technology came in the 1920s. Two developments occurred simultaneously. These were the invention of the alkyd resin and the development of latex emulsions. The original alkyds were made by the reaction of glycerol (a polyhydric alcohol) with phthalic anhydride (a polybasic acid) in an oil medium. In time, glycerol was replaced by pentaerythritol (penta imparts greater flexibility and color stability to the resin). Alkyds were originally used in industrial and house paint systems. However, around 1960, some manufacturers of artist's paints began to partially replace linseed oil in selected colors. Full product lines based upon alkyd resin technology did not appear until the late 1970s/early 1980s. Today, almost every artist's paint producer has a full line of alkyd colors.

In the late 1920s, latex emulsion technology was also emerging. The original latices were made from styrene-butadiene. These were very poor in quality. Sometimes the emulsion would break. Sometimes reactions after processing occurred. These reactions included gelation and seeding of the emulsion. In the 1930s, resin producers began using methylmethacrylate as a basis for emulsions. By the end of World War II, latex emulsions were being used in house paint formulae. By 1952, boutique art shops began carrying a line of latex (now called acrylic) colors. The name change was the result of the switch from styrene-butadiene to methylmethacrylate. By 1960, all major manufacturers had complete lines of acrylic colors. The color palette for acrylic colors is the same as the palette for watercolor. There is no Flake White (basic lead carbonate) or zinc oxide due to the reactivity of these pigments with the latex.

The last advance in artist's paint technology came in 1993, with the advent of water-thinnable linseed oil paint. As stated earlier, water-thinnable linseed oil paint was created by dismissing the old myth that water and oil did not mix. Chemists were able to do this alteration of linseed oil. Linseed oil is a composite of between 17 to 21 different fatty acids. The number varies with the source of the oil, as is the case with most naturally occurring materials. All of these fatty acids are at varying percentage levels in the oil. Some of these acids are hydrophobic, while some are hydrophilic. By adding more of the hydrophilic acids, an oil that will accept water by forming a temporary emulsion is made. The beauty of water-thinnable oil colors is that they eliminate the need for solvents by serving as both thinner and cleanup agent. This greatly reduces studio toxicity. If, however, one wishes to use the solvents that have been used since the 15th century, the system will accept them. The palette that is in use for water-thinnable oil colors is the same as the palette for conventional oil color.

Table 117.2 summarizes the modern palette. Listed are the artist's name for a color, the chemical composition of the pigment, the date of discovery, the date of first usage in artist's colors, and the pigment replaced. This table refers only to pigment. Vehicle type has been deleted. All colors listed are available in all vehicle types described herein, with very few exceptions. In the discovery and first usage columns, the notation "Ant" means that the discovery or first usage goes back into antiquity.

Hopefully, this gives the reader an overview of the history and composition of artist's paints.

TABLE 117.2 The Modern Palette

Artist's Name	Chemical Composition	Discovery Date	First Used Date	Pigment Replaced
Alizarin Crimson	1,2-Dihydroxyanthraquinone laked onto alumina hydrate	1868	1868	Alizarin, an extract of the root of the Madder plant
Burnt Sienna	Calcined and roasted Raw Sienna (essentially iron oxide)	Ant.	Ant.	None
Burnt Umber	Calcined and roasted Raw Umber (essentially iron oxide and manganese dioxide)	Ant.	Ant.	None
Cadmium Colors				
1. Orange	All are cadmium-mercury sulfides coprecipitated with barium sulfate	1955–1960	Early 1980s	Cadmium sulfoselenide coprecipitated with barium sulfate and prior to that pure cadmium sulfoselenide (in use since 1846)
2. Red, Deep		1955–1960	Early 1980s	
3. Red, Medium		1955–1960	Early 1980s	
4. Red, Light		1955–1960	Early 1980s	
5. Yellow, Deep		1955–1960	Early 1980s	
6. Yellow, Medium		1955–1960	Early 1980s	
7. Yellow, Light		1955–1960	Early 1980s	
8. Black		1978	1993	
Cerulean Blue	Combined oxides of cobalt and tin Co^*nSnO	1805	1870	Mixed copper silicates
Chromium Oxide Green	Anhydrous chromic oxide	1809	1862	None
Cobalt Blue	Combined oxides of cobalt and aluminum	1802	1820–1830	Mixed copper silicates
Cobalt Green	Combined oxides of cobalt and zinc	1780	1835	None
Cobalt Violet	Anhydrous cobalt phosphate	?	1860	Anhydrous cobalt arsenate
Cobalt Yellow (a.k.a. Auereolin)	Potassium cobalt nitrite	1830	1860 (in United States)	None
Flake White	Basic lead carbonate	Ant.	Ant.	None
Green Earth	Native clay consisting mainly of anhydrous silicates of iron, aluminum, magnesium and potassium	Ant.	Ant.	None
Hansa Yellows				
1. Hansa Yellow G	Diazo-2-nitro-4- methylalanine coupled onto acetoacetalanine	1909	1915	None
2. Hansa Yellow 10G	Diazo-4-chloro-2- nitroaniline coupled onto 2- chloroacetalanide	1909	1930	None
Indian Red	Synthetic iron oxide (blue shade)	19th century	19th century	Natural Red iron oxide
Manganese Blue	Barium manganate	19th century	1940–1950	None
Manganese Violet	Manganese ammonium phosphate	19th century	1868	None
Mars Colors				
1. Black	Synthetic iron oxide mixes Ferro-ferric oxide	19th century	19th century	Natural iron oxides
2. Orange	Mixed iron and aluminum oxides	19th century	19th century	Natural iron oxides
3. Red	Mixed iron and aluminum oxides	19th century	19th century	Natural iron oxides
4. Violet	Pure ferrous oxide	19th century	19th century	Natural iron oxides
5. Yellow	Mixed iron and aluminum oxides	19th century	19th century	Natural iron oxides

TABLE 117.2 The Modern Palette (Continued)

Artist's Name	Chemical Composition	Discovery Date	First Used Date	Pigment Replaced
Naples Yellow Hue	Mixture of zinc oxide, Cadmium Yellow, and Yellow Oxide	Not Applic.	1920s	Lead antimoniate (known since the 1500s)
Phthalocyanine Blue	A 16-member ring comprised of four isoindole groups connected by four nitrogen atoms; in the center of the ring is a copper atom	1935	1936	Prussian Blue (ferric-ferrocyanide) discovered in 1704 and introduced in 1724
Phthalocyanine Green	Same as Phthalocyanine Blue but four chlorine atoms are added to each isoindole group	1938	1938	None
Quinacridone Colors				
1. Red (Yellow shade)	Gamma trans-linear Quinacridone	1955	1962	None
2. Red (Blue shade)	Gamma trans-linear Quinacridone	1955	1962	None
3. Violet	Beta trans-linear quinacridone	1955	1962	None
4. Magenta	Disulfonated trans-linear Quinacridone	1955	1962	None
Raw Sienna	A natural earth composed mainly of hydrous silicates and oxides of iron and aluminum	Ant.	Ant.	None
Raw Umber	A natural earth composed mainly of hydrous silicates and oxides of iron and manganese	Ant.	Ant.	None
Strontium Yellow	Strontium chromate	1836	1950	None
Titanium White	Mainly titanium dioxide ~60% with some zinc oxide and/or barium sulfate ~40% combined	1870	1920	Flake White (basic lead carbonate) known since antiquity
Ultramarine Colors				
1. Blue	All are complex silicates of sodium and aluminum with sulfur. The degree of sulfonation determines the color	1828	1828	Ground gemstone Lapis lazuli
2. Green				
3. Red				
4. Violet				
Vermillion	Mercuric sulfide	Ant.	8th century	Cinnibar, an ore with mercuric sulfide in it
Viridian	Hydrous chromic oxide	1838	1862	None
Yellow Ochre	A mixture of synthetic hydrous iron oxide with alumina and silica	19th century	19th century	Natural version of the same mixture. It dates into antiquity
Zinc White	Zinc oxide	About 1820	1834 in watercolor; 1900 in oil color	Chalk (calcium carbonate) Flake White (basic lead carbonate)

Source: Lewis, Peter A., *Federation Series on Coatings Technology—Organic Pigments*, 3rd ed., revised September 2000. Mayer, Ralph, *The Artist's Handbook of Materials and Techniques*, 3rd ed., revised 1970.

118

Fade Resistance of Lithographic Inks — A New Path Forward: Real World Exposures in Florida and Arizona Compared to Accelerated Xenon Arc Exposures

Eric T. Everett

Q-Panel Lab Products

John Lind

*Graphic Arts Technical Foundation
(GATF)*

John Stack

*National Institute for Occupational
Safety & Health/National Personal
Protective Technology Laboratory*

118.1	Florida and Arizona Outdoor under Glass Exposures.....	118-2
	Test Program • Effect of Seasonal Variation • Arizona Exposure	
118.2	Accelerated Xenon Arc Exposures	118-5
	Why Xenon Arc Testing? • The Test Program • Xenon Arc Test Results • Relative Humidity • Xenon Arc Exposure Compared to Florida Outdoor under Glass Exposure	
118.3	Conclusions	118-9
	Further Reading.....	118-10

How long will an ink remain fade resistant under the variety of lighting conditions that it may encounter during its service life? What is the cost of product failure? What is the price/performance trade-off between affordability and performance? Is there a quick method to determine which ink is best for a specific application? This paper answers these questions and provides a useful roadmap for assessing ink durability.

First, results are presented from real world sunlight through window glass exposures in Florida and Arizona. These internationally recognized test locations provide a “worst case” scenario by exposing inks to high ultraviolet (UV), high temperatures, and high relative humidity (RH).

Second, test results are presented from laboratory xenon arc exposures performed on an identical set of lithographic ink specimens. The purpose was twofold: (1) How well do laboratory xenon exposures correlate with Florida and Arizona exposures in terms of actual degradation and relative rank order? (2) How much faster are the accelerated laboratory exposures compared to the natural exposures?

This definitive study correlates real world and accelerated laboratory test results for lithographic inks.



FIGURE 118.1 Q-Lab weathering research service test facilities research center in Florida and Arizona performed fade resistance testing of lithographic inks in extreme environments.

118.1 Florida and Arizona Outdoor under Glass Exposures

Sunlight contains short wavelength UV and visible and infrared energy. UV is the primary cause of degradation in inks, with temperature and moisture as secondary stressors that can accelerate the rate of degradation.

Lithographic inks may encounter intense sunlight by being placed near a window, or worse yet, placed on a car dashboard during the summer months, where they will likely encounter high UV, high temperatures, and high humidity. Florida and Arizona test locations were chosen for this study because they provide these extreme environments (Figure 118.1).

118.1.1 Test Program

The Graphic Arts Technical Foundation (GATF) selected eight widely used lithographic ink colors: Yellow #1, Yellow #2, Yellow #3, Magenta, Violet, Orange, Red, and Purple (Figure 118.2). A Little Joe Proofing Press was used to make prints at typical offset film thicknesses. The inks were printed on a typical coated, 70-lb common paper substrate. Replicates of each ink color were printed for all of the exposures.

The ink test specimens were tested by Q-Lab Weathering Research Service in Florida and Arizona. They were placed in glass-covered cabinets, angled at 45 degrees south, to maximize exposure of sunlight filtered through window glass (Figure 118.3). The sunlight through window glass spectrum was chosen because it best represents worst case indoor lighting conditions.

The ink test specimens were measured for color change before, during, and after exposure. A spectrophotometer was used to take the color measurements in accordance to ASTM D2244. The total color change expressed in delta E units was recorded for each specimen.

Florida exposure tests were started at four seasonal intervals: fall equinox (9/21/02), winter solstice (12/21/02), spring equinox (3/21/03), and summer solstice (6/21/03). The Arizona exposure test was started in the fall (10/7/02).

Table 118.1 shows the total light energy intensity (i.e., radiant dosage) expressed in megajoules/m² at the conclusion of the various outdoor exposure tests, after 90 d in Florida and Arizona.

Figure 118.4 shows the fade resistance performance of the eight ink colors during the Florida fall exposure. Some ink colors had excellent fade resistance, while other ink colors had very poor fade resistance. After 90 d, the majority of ink test specimens were severely faded and not useful for analysis.

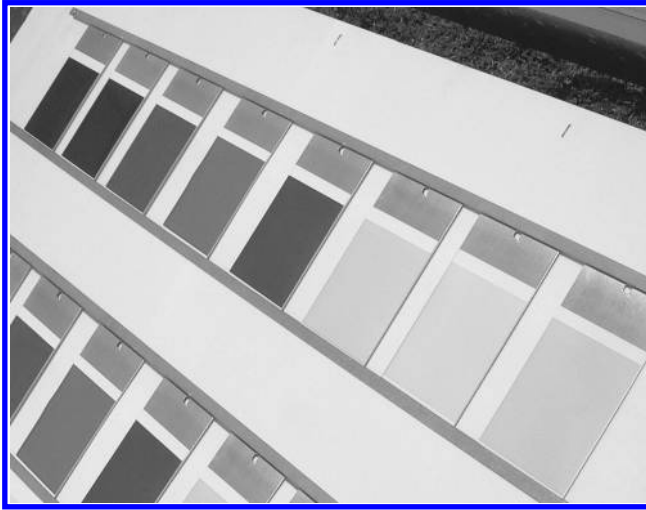

FIGURE 118.2 GATF technical staff selected eight representative lithographic ink colors printed on a standard substrate for fade resistance testing.



FIGURE 118.3 Ink specimens were placed in ASTM G24 glass-covered exposure racks in Florida and Arizona benchmark locations.

TABLE 118.1 Total Sunlight Outdoor Exposure Summary MJ/m² at 300 to 3000 nm

Exposure	Days	MJ/m ²
Florida fall	90	1926.17
Florida winter	90	1541.13
Florida spring	90	1252.54
Florida summer	90	1081.73
Arizona fall	90	1611.20

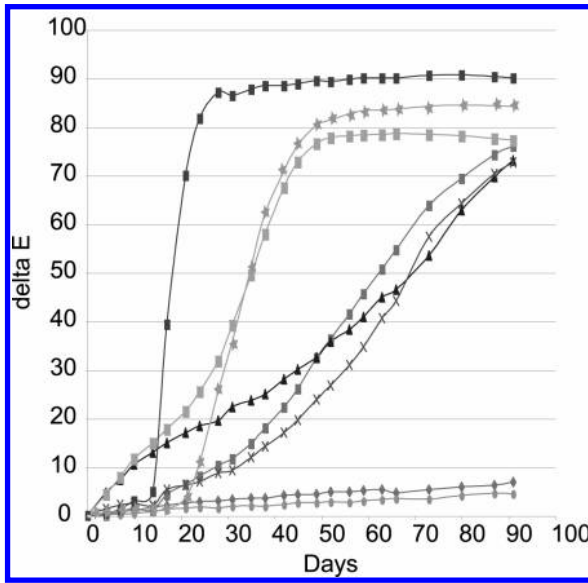

FIGURE 118.4 Fade resistance range for eight colors.

However, by 35 d, the inks exhibited a wide range of fade resistance, from excellent to poor. Therefore, 35 d was chosen to evaluate the performance of the inks in the various outdoor exposures.

Figure 118.5 shows the range of durability for the three Yellow ink test specimens in the Florida fall exposure. Despite being the same color, the three Yellow inks had significant differences in their fade resistance. Yellow A performed dramatically better than Yellow B or Yellow C. This is because Yellow A is fade resistant and suitable for fine art reproductions or outdoor applications, while Yellow B and C are intended for general commercial printing.

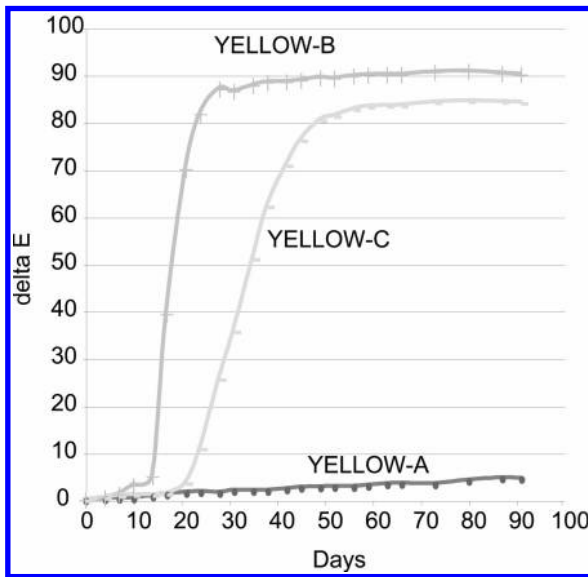

FIGURE 118.5 Fade resistance range for one color.

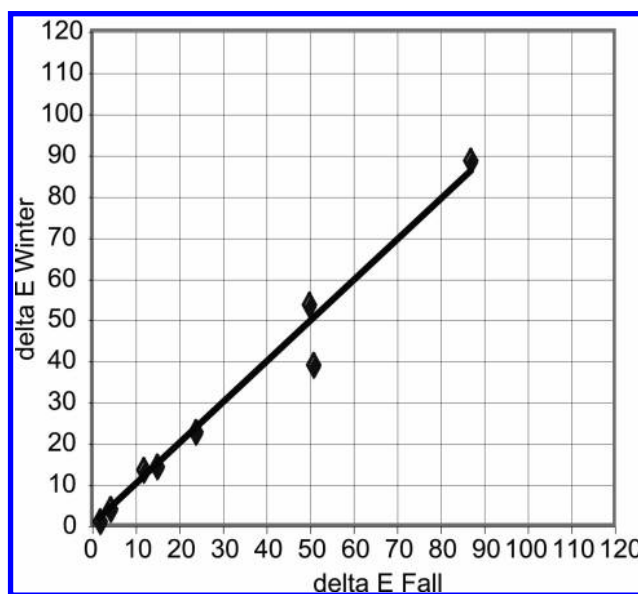

FIGURE 118.6 Fade resistance correlation for Florida: fall vs. winter.

118.1.2 Effect of Seasonal Variation

Because the natural exposures were only 35 d, the test was repeated at seasonal intervals to determine the effect of time of year on degradation. The results showed the time of year did not affect the fade resistance rankings. All seasonal exposures correlated with each other in terms of rank order. However, there was a difference in the rate of degradation.

In order to quantify the difference in the seasonal rates of degradation, the average delta E (at 35 d) can be compared. For example, the average delta E value of all the inks in the Florida winter exposure was 21, while it was 44 for the Florida fall exposure. In this case, the fall exposure was approximately 2 to 1 more severe than the winter exposure. One should not compare absolute values of specimens exposed at different times of the year since the rate varies by season. Such inconsistency may not play a factor when using accelerated fade testing equipment.

Figure 118.6 compares the Florida fall (35 d) and winter (45 d) exposures. There was perfect rank order correlation between the two exposures.

Figure 118.7 compares Florida winter (45 d) and Florida summer (35 d). There was perfect rank order (1.0) between the two seasonal exposures.

118.1.3 Arizona Exposure

The Arizona exposures correlated well with the Florida exposures. The Arizona exposures indicate that fast test results were obtained in the same time period (35 d) as the Florida exposures. Figure 118.8 compares Arizona and Florida at 35 d.

As shown in Table 118.2, rank order correlation values were all 0.90 and above for all of the outdoor exposures.

118.2 Accelerated Xenon Arc Exposures

Accelerated laboratory xenon arc exposures were performed on an identical set of lithographic ink specimens. As noted earlier, the goals were twofold: (1) How well did the lab exposures mimic actual

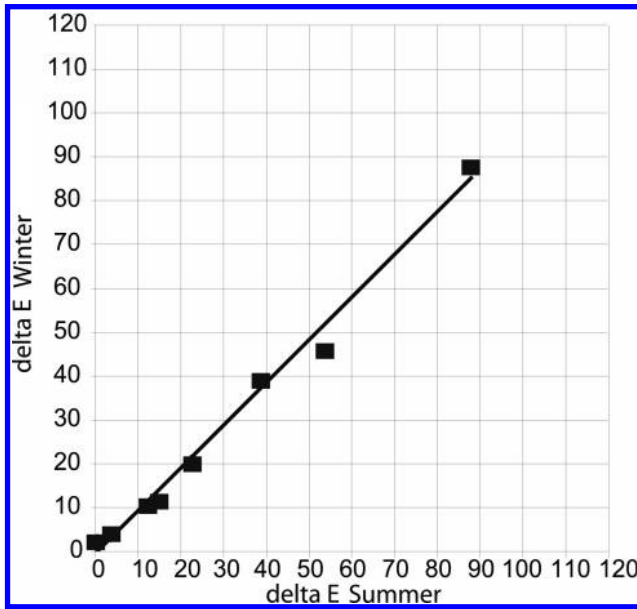

FIGURE 118.7 Fade resistance correlation for Florida: winter vs. summer.

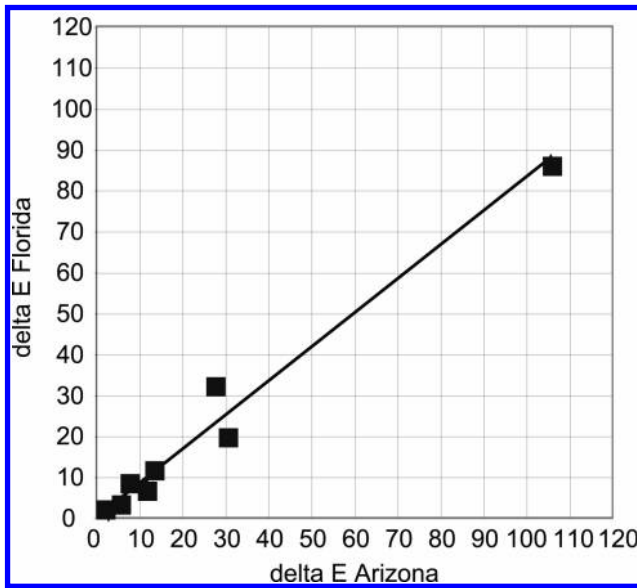

FIGURE 118.8 Fade resistance correlation: Florida: vs. Arizona.

TABLE 118.2 Rank Order Correlation Matrix

	Florida Summer	Florida Fall	Florida Winter	Florida Spring	Arizona Fall
Florida Summer	—	0.98	0.93	0.98	0.90
Florida Fall	0.98	—	1.0	0.95	0.98
Florida Winter	0.93	1.0	—	0.97	0.96
Florida Spring	0.98	0.95	0.97	—	0.93
Arizona Fall	0.90	0.98	0.96	0.93	—

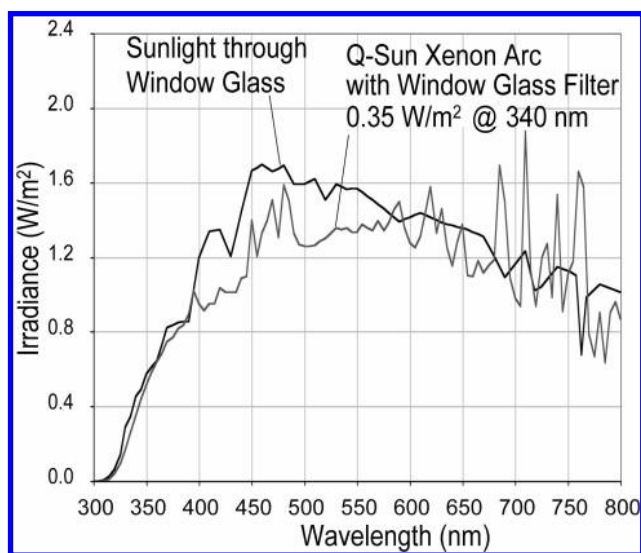

FIGURE 118.9 Q-Sun with window glass filter vs. sunlight through window glass.

real world exposures with regard to their actual degradation mode and relative rank order? (2) How much faster were the lab exposures compared to the natural exposures?

118.2.1 Why Xenon Arc Testing?

Historically, the inks industry has used accelerated laboratory tests to get fast results. Xenon arc testers are widely used because they provide fast results by accelerating critical environmental stresses such as direct spectrum, light intensity, RH, and temperature.

For most indoor products, direct sunlight coming through the window is the most severe indoor lighting condition. A recent Kodak study concluded that indirect, window-filtered daylight dominates the indoor lighting environment in homes (Bugner, LaBarca et. al, 2003). Consequently, this GATF/Q-Panel study used Q-Sun xenon testers equipped with “window glass filters” to achieve an appropriate spectrum (Figure 118.9).

118.2.2 The Test Program

GATF and Q-Panel’s Q-Lab Weathering Research Service tested ink specimens in Q-Sun Xenon Test Chambers (Figure 118.10). One xenon tester was a small “tabletop” unit without RH control (Xe-1), while the other was a full-sized, full-featured xenon tester with precise control of RH (Xe-3H). Exposures were performed in these different xenon arc models to see if repeatable results could be achieved (Table 118.3).

118.2.3 Xenon Arc Test Results

After 10 d, both the tabletop xenon arc and full-featured xenon arc discriminated the good performing inks from bad performing inks. Figure 118.11 shows the fade resistance performance of the eight ink colors in the tabletop xenon arc test apparatus.

118.2.4 Relative Humidity

To determine the effect of RH, the inks were exposed in a xenon arc that controlled RH at 50% (Q-Sun Xe-3-H) and another xenon arc where the effective RH was approximately 15% (Q-Sun Xe-1). Figure

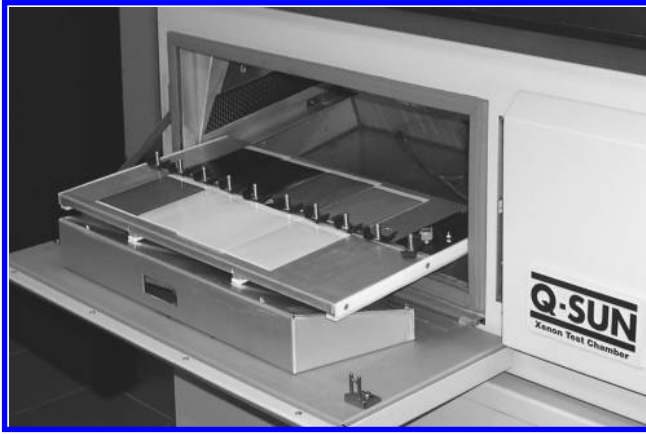

FIGURE 118.10 GATF and Q-Lab tested inks in Q-Sun Xenon Test Chambers.

TABLE 118.3 Xenon Arc Exposure Test Conditions

Q-Sun Xenon (Xe-1 and Xe-3H)
ASTM D3424, Method 3
Window Glass Filter
Irradiance Level: 0.55 W/m ² /nm at 340 nm
RH: Xe-1 Effective RH = 15%
Xe-3 RH = 50%
Exposure Cycle: Continuous Light at 63 ± 3°C (145 ± 5°F)
Test Duration: 31 d
Total Radiant Exposure = 1473 kJ/m ² at 340 nm

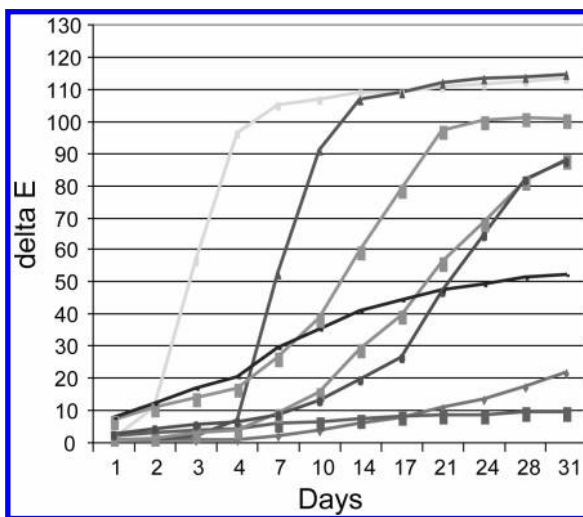

FIGURE 118.11 Q-Sun fade resistance range.

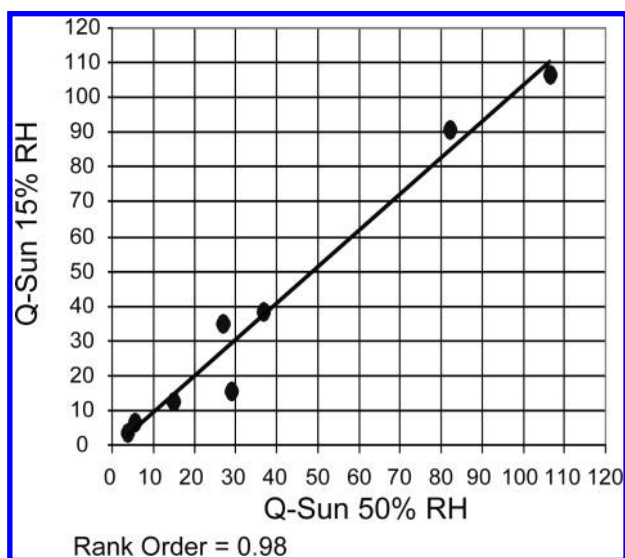

FIGURE 118.12 Effect of relative humidity delta E.

118.12 compares the exposures after 10 d. There was excellent correlation. Control of RH made very little difference for these particular inks.

118.2.5 Xenon Arc Exposure Compared to Florida Outdoor under Glass Exposure

The outdoor under glass exposures established a benchmark for fade resistance testing of inks in the extreme environments of Florida and Arizona. Next, the xenon arc exposures were compared to the outdoor benchmark data. Figure 118.13 compares the xenon exposure at 10 d to the Florida under glass exposure at 35 d. Although the numerical results were not identical, the results show excellent rank order correlation between the two exposures. In this comparison, the xenon arc exposure at 10 d was approximately equivalent to 35 d in Florida. For this particular set of test specimens, the xenon arc exposure provided an acceleration factor of almost 4 to 1.

As shown in Table 118.4, rank order values for xenon arc and outdoor exposures were all very good.

118.3 Conclusions

1. The Florida and Arizona outdoor under glass exposures provided an extreme environment and quickly separated inks with excellent fade resistance from inks with poor fade resistance.
2. All outdoor exposures correlated with each other.
3. All outdoor exposures were fast and effective. In 35 d, the relative durability of all ink specimens was determined.
4. In this series of tests, the time of year did not make a difference in ranking performance of inks. Seasonal variability made a difference only in the speed of degradation.
5. Outdoor exposures are highly useful for fade resistance testing of any ink. It is recommended that an ink be tested on a variety of paper substrates since it has been reported (Tobias and Everett, 2002) that the substrate on which an ink is printed on may also affect its stability.
6. Like the Florida and Arizona outdoor under glass exposures, the xenon arc exposures separated the inks with good fade resistance from the inks with poor fade resistance. Although no accelerated lab test can replace actual real world exposures, the xenon arc exposures correlated very well with the established outdoor exposure benchmark data.

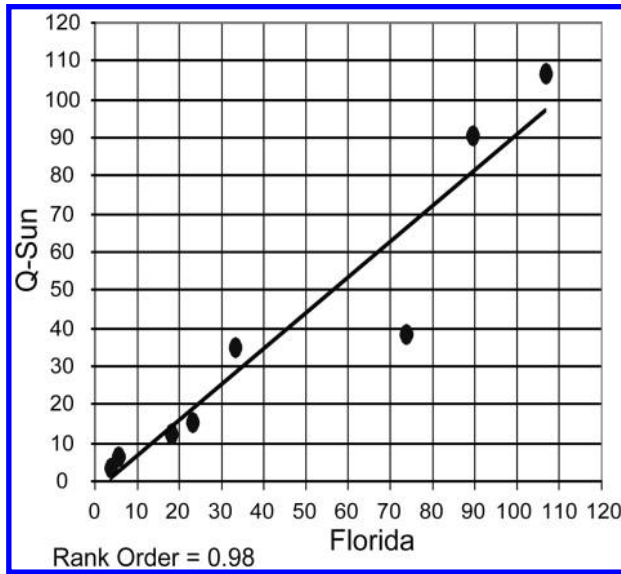

FIGURE 118.13 Florida (35 d) vs. Q-Sun (10 d) delta E.

TABLE 118.4 Rank Order Correlation Matrix

	Q-Sun Xenon	Florida Summer 35 d	Florida Fall 35 d	Florida Winter 35 d	Florida Spring 35 d	Arizona Fall 35 d
Q-Sun Xenon	—	0.98	0.97	0.83	0.95	0.88
Florida Summer	0.98	—	0.98	0.93	0.98	0.90
Florida Fall	0.97	0.98	—	1.0	0.95	0.98
Florida Winter	0.83	0.93	1.0	—	0.97	0.96
Florida Spring	0.95	0.98	0.95	0.97	—	0.93
Arizona Fall	0.88	0.90	0.98	0.96	0.93	—

- The tabletop xenon arc tester (Q-Sun Xe-1) provided the same test results as the full-featured xenon tester (Q-Sun Xe-3-H). For this particular study, RH did not make a noticeable difference in the test results.
- The xenon arc exposures were quick. In only 10 d, the xenon arc reproduced 35 d of Florida under glass exposure. Depending upon the time of the year, the acceleration factor ranged from about 4 to 1 to almost 7 to 1. However, a word of caution: these acceleration factors may not be valid for other sets of inks.

Further Reading

- ASTM D2244, Test Method for Calculation of Color Differences from Instrumentally Measured Color Coordinates.
- ASTM D3424, Standard Test Methods for Evaluating the Relative Lightfastness and Weatherability of Printed Matter.
- ASTM G24, Standard Practice for Conducting Exposures to Daylight Filtered through Glass.
- ASTM G151, Standard Practice for Exposing Nonmetallic Materials in Accelerated Test Devices That Use Laboratory Light Sources.
- ASTM G155, Standard Practice for Operating Xenon Arc Light Apparatus for Exposure of Nonmetallic Materials.

- Bugner, Douglas, Joseph LaBarca et. al, "Survey of Environmental Conditions Relative to Display of Photographs in Consumer Homes," *IS&T Publications*, 2003.
- Lucas, Julie, "Keep Your True Colors: Lightfastness and Weathering Testing," *GATF World*, May/June 2001.
- Tobias, Russell H. and Eric T. Everett, "Lightfastness Studies of Water-Based Inkjet Inks on Coated and Uncoated Papers," *IS&T Publications*, 2002.