

Technical guide - 6th edition 2010

# Electrical installation handbook

## Protection, control and electrical devices

Power and productivity  
for a better world™





# Electrical installation handbook

## Protection, control and electrical devices

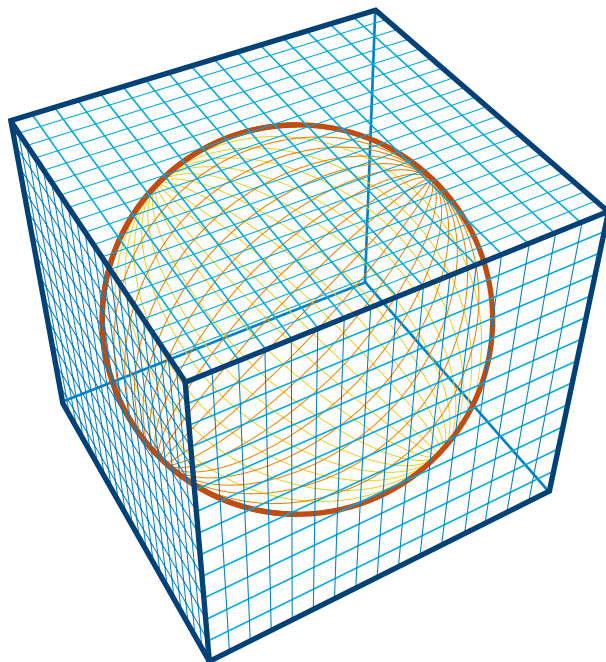

First edition 2003  
Second edition 2004  
Third edition 2005  
Fourth edition 2006  
Fifth edition 2007  
Sixth edition 2010

*Published by ABB SACE  
via Baioni, 35 - 24123 Bergamo (Italy)*

All rights reserved



# Electrical installation handbook

## Protection, control and electrical devices

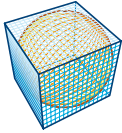

### **General aspects**

---

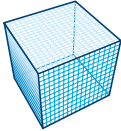

Part 1

### **Protection and control devices**

---

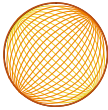

Part 2

### **Electrical devices**

---



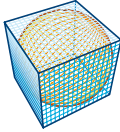

---

# General aspects

## Index

<b>Introduction</b> .....	6
<b>1 Standards</b>	
1.1 General aspects.....	7
1.2 IEC Standards for electrical installation.....	19

---

# Introduction

## Scope and objectives

The scope of this electrical installation handbook is to provide the designer and user of electrical plants with a quick reference, immediate-use working tool. This is not intended to be a theoretical document, nor a technical catalogue, but, in addition to the latter, aims to be of help in the correct definition of equipment, in numerous practical installation situations.

The dimensioning of an electrical plant requires knowledge of different factors relating to, for example, installation utilities, the electrical conductors and other components; this knowledge leads the design engineer to consult numerous documents and technical catalogues. This electrical installation handbook, however, aims to supply, in a single document, tables for the quick definition of the main parameters of the components of an electrical plant and for the selection of the protection devices for a wide range of installations. Some application examples are included to aid comprehension of the selection tables.

## Electrical installation handbook users

The electrical installation handbook is a tool which is suitable for all those who are interested in electrical plants: useful for installers and maintenance technicians through brief yet important electrotechnical references, and for sales engineers through quick reference selection tables.

## Validity of the electrical installation handbook

Some tables show approximate values due to the generalization of the selection process, for example those regarding the constructional characteristics of electrical machinery. In every case, where possible, correction factors are given for actual conditions which may differ from the assumed ones. The tables are always drawn up conservatively, in favour of safety; for more accurate calculations, the use of DOCWin software is recommended for the dimensioning of electrical installations.



---

# 1 Standards

---

## 1.1 General aspects

In each technical field, and in particular in the electrical sector, a condition sufficient (even if not necessary) for the realization of plants according to the **“status of the art”** and a requirement essential to properly meet the demands of customers and of the community, is the respect of all the relevant laws and technical standards.

Therefore, a precise knowledge of the standards is the fundamental premise for a correct approach to the problems of the electrical plants which shall be designed in order to guarantee that **“acceptable safety level”** which is never absolute.

### *Juridical Standards*

These are all the standards from which derive rules of behavior for the juridical persons who are under the sovereignty of that State.

### *Technical Standards*

These standards are the whole of the prescriptions on the basis of which machines, apparatus, materials and the installations should be designed, manufactured and tested so that efficiency and function safety are ensured.

The technical standards, published by national and international bodies, are circumstantially drawn up and can have legal force when this is attributed by a legislative measure.

	<b>Application fields</b>		
	<b>Electrotechnics and Electronics</b>	<b>Telecommunications</b>	<b>Mechanics, Ergonomics and Safety</b>
International Body	IEC	ITU	ISO
European Body	CENELEC	ETSI	CEN

This technical collection takes into consideration only the bodies dealing with electrical and electronic technologies.

## **IEC International Electrotechnical Commission**

The *International Electrotechnical Commission* (IEC) was officially founded in 1906, with the aim of securing the international co-operation as regards standardization and certification in electrical and electronic technologies. This association is formed by the International Committees of over 40 countries all over the world.

The IEC publishes international standards, technical guides and reports which are the bases or, in any case, a reference of utmost importance for any national and European standardization activity.

IEC Standards are generally issued in two languages: English and French. In 1991 the IEC has ratified co-operation agreements with CENELEC (European standardization body), for a common planning of new standardization activities and for parallel voting on standard drafts.

# 1 Standards

## GENELEC European Committee for Electrotechnical Standardization

The *European Committee for Electrotechnical Standardization* (CENELEC) was set up in 1973. Presently it comprises 31 countries (Austria, Belgium, Bulgaria, Cyprus, Croatia, Czech Republic, Denmark, Estonia, Finland, France, Germany, Greece, Hungary, Iceland, Ireland, Italy, Latvia, Lithuania, Luxembourg, Malta, Netherlands, Norway, Portugal, Poland, Romania, Slovakia, Slovenia, Spain, Sweden, Switzerland, United Kingdom) and cooperates with 12 affiliates (Albania, Belarus, Georgia, Bosnia and Herzegovina, Tunisia, Former Yugoslav Republic of Macedonia, Serbia, Libia, Montenegro, Turkey, Ukraine and Israel) which have first maintained the national documents side by side with the CENELEC ones and then replaced them with the Harmonized Documents (HD).

There is a difference between EN Standards and Harmonization Documents (HD): while the first ones have to be accepted at any level and without additions or modifications in the different countries, the second ones can be amended to meet particular national requirements.

EN Standards are generally issued in three languages: English, French and German.

From 1991 CENELEC cooperates with the IEC to accelerate the standards preparation process of International Standards.

CENELEC deals with specific subjects, for which standardization is urgently required.

When the study of a specific subject has already been started by the IEC, the European standardization body (CENELEC) can decide to accept or, when necessary, to amend the works already approved by the International standardization body.

## EC DIRECTIVES FOR ELECTRICAL EQUIPMENT

Among its institutional roles, the European Community has the task of promulgating directives which must be adopted by the different member states and then transposed into national law.

Once adopted, these directives come into juridical force and become a reference for manufacturers, installers, and dealers who must fulfill the duties prescribed by law.

Directives are based on the following principles:

- harmonization is limited to essential requirements;
- only the products which comply with the essential requirements specified by the directives can be marketed and put into service;
- the harmonized standards, whose reference numbers are published in the Official Journal of the European Communities and which are transposed into the national standards, are considered in compliance with the essential requirements;
- the applicability of the harmonized standards or of other technical specifications is facultative and manufacturers are free to choose other technical solutions which ensure compliance with the essential requirements;
- a manufacturer can choose among the different conformity evaluation procedure provided by the applicable directive.

The scope of each directive is to make manufacturers take all the necessary steps and measures so that the product does not affect the safety and health of persons, animals and property.

# 1 Standards

## “Low Voltage” Directive 2006/95/CE

The Low Voltage Directive refers to any electrical equipment designed for use at a rated voltage from 50 to 1000 V for alternating current and from 75 to 1500 V for direct current.

In particular, it is applicable to any apparatus used for production, conversion, transmission, distribution and use of electrical power, such as machines, transformers, devices, measuring instruments, protection devices and wiring materials.

The following categories are outside the scope of this Directive:

- electrical equipment for use in an explosive atmosphere;
- electrical equipment for radiology and medical purposes;
- electrical parts for goods and passenger lifts;
- electrical energy meters;
- plugs and socket outlets for domestic use;
- electric fence controllers;
- radio-electrical interference;
- specialized electrical equipment, for use on ships, aircraft or railways, which complies with the safety provisions drawn up by international bodies in which the Member States participate.

## Directive EMC 2004/108/CE (“Electromagnetic Compatibility”)

The Directive on electromagnetic compatibility regards all the electrical and electronic apparatus as well as systems and installations containing electrical and/or electronic components. In particular, the apparatus covered by this Directive are divided into the following categories according to their characteristics:

- domestic radio and TV receivers;
- industrial manufacturing equipment;
- mobile radio equipment;
- mobile radio and commercial radio telephone equipment;
- medical and scientific apparatus;
- information technology equipment (ITE);
- domestic appliances and household electronic equipment;
- aeronautical and marine radio apparatus;
- educational electronic equipment;
- telecommunications networks and apparatus;
- radio and television broadcast transmitters;
- lights and fluorescent lamps.

The apparatus shall be so constructed that:

- a) the electromagnetic disturbance it generates does not exceed a level allowing radio and telecommunications equipment and other apparatus to operate as intended;
- b) the apparatus has an adequate level of intrinsic immunity to electromagnetic disturbance to enable it to operate as intended.

An apparatus is declared in conformity to the provisions at points a) and b) when the apparatus complies with the harmonized standards relevant to its product family or, in case there aren't any, with the general standards.

# 1 Standards

## CE conformity marking

The CE conformity marking shall indicate conformity to all the obligations imposed on the manufacturer, as regards his products, by virtue of the European Community directives providing for the affixing of the CE marking.



When the CE marking is affixed on a product, it represents a declaration of the manufacturer or of his authorized representative that the product in question conforms to all the applicable provisions including the conformity assessment procedures. This prevents the Member States from limiting the marketing and putting into service of products bearing the CE marking, unless this measure is justified by the proved non-conformity of the product.

*Flow diagram for the conformity assessment procedures established by the Directive 2006/95/CE on electrical equipment designed for use within particular voltage range:*

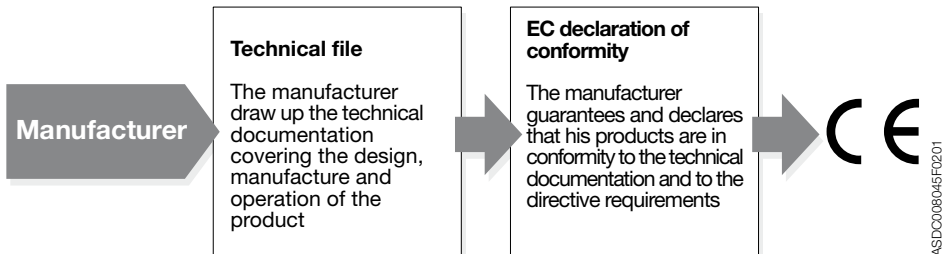

## Naval type approval

The environmental conditions which characterize the use of circuit breakers for on-board installations can be different from the service conditions in standard industrial environments; as a matter of fact, marine applications can require installation under particular conditions, such as:

- environments characterized by high temperature and humidity, including salt-mist atmosphere (damp-heat, salt-mist environment);
- on board environments (engine room) where the apparatus operate in the presence of vibrations characterized by considerable amplitude and duration.

In order to ensure the proper function in such environments, the shipping registers require that the apparatus has to be tested according to specific type approval tests, the most significant of which are vibration, dynamic inclination, humidity and dry-heat tests.

# 1 Standards





ABB SACE circuit-breakers (Tmax-Emax) are approved by the following shipping registers:

• <b>RINA</b>	Registro Italiano Navale	Italian shipping register
• <b>DNV</b>	Det Norske Veritas	Norwegian shipping register
• <b>BV</b>	Bureau Veritas	French shipping register
• <b>GL</b>	Germanischer Lloyd	German shipping register
• <b>LRs</b>	Lloyd's Register of Shipping	British shipping register
• <b>ABS</b>	American Bureau of Shipping	American shipping register









It is always advisable to ask ABB SACE as regards the typologies and the performances of the certified circuit-breakers or to consult the section certificates in the website <http://bol.it.abb.com>.

## Marks of conformity to the relevant national and international Standards









The international and national marks of conformity are reported in the following table, for information only:

COUNTRY	Symbol	Mark designation	Applicability/Organization
EUROPE		–	Mark of compliance with the harmonized European standards listed in the ENEC Agreement.
AUSTRALIA		AS Mark	Electrical and non-electrical products. It guarantees compliance with SAA (Standard Association of Australia).
AUSTRALIA		S.A.A. Mark	Standards Association of Australia (S.A.A.). The Electricity Authority of New South Wales Sydney Australia
AUSTRIA		Austrian Test Mark	Installation equipment and materials







# 1 Standards

COUNTRY	Symbol	Mark designation	Applicability/Organization
AUSTRIA		ÖVE Identification Thread	Cables
BELGIUM		CEBEC Mark	Installation materials and electrical appliances
BELGIUM		CEBEC Mark	Conduits and ducts, conductors and flexible cords
BELGIUM		Certification of Conformity	Installation material and electrical appliances (in case there are no equivalent national standards or criteria)
CANADA		CSA Mark	Electrical and non-electrical products. This mark guarantees compliance with CSA (Canadian Standard Association)
CHINA		CCC Mark	This mark is required for a wide range of manufactured products before being exported to or sold in the Peoples Republic of China market.
Czech Republic		EZU' Mark	Electrotechnical Testing Institute
Slovakia Republic		EVPU' Mark	Electrotechnical Research and Design Institute

# 1 Standards



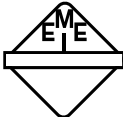
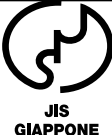





COUNTRY	Symbol	Mark designation	Applicability/Organization
CROATIA		KONKAR	Electrical Engineering Institute
DENMARK		DEMKO Approval Mark	Low voltage materials. This mark guarantees the compliance of the product with the requirements (safety) of the "Heavy Current Regulations"
FINLAND		Safety Mark of the Elektriska Inspektoratet	Low voltage material. This mark guarantees the compliance of the product with the requirements (safety) of the "Heavy Current Regulations"
FRANCE		ESC Mark	Household appliances
FRANCE		NF Mark	Conductors and cables – Conduits and ducting – Installation materials
FRANCE		NF Identification Thread	Cables
FRANCE		NF Mark	Portable motor-operated tools
FRANCE		NF Mark	Household appliances

# 1 Standards







COUNTRY	Symbol	Mark designation	Applicability/Organization
GERMANY		VDE Mark	For appliances and technical equipment, installation accessories such as plugs, sockets, fuses, wires and cables, as well as other components (capacitors, earthing systems, lamp holders and electronic devices)
GERMANY		VDE Identification Thread	Cables and cords
GERMANY		VDE Cable Mark	For cables, insulated cords, installation conduits and ducts
GERMANY		VDE-GS Mark for technical equipment	Safety mark for technical equipment to be affixed after the product has been tested and certified by the VDE Test Laboratory in Offenbach; the conformity mark is the mark VDE, which is granted both to be used alone as well as in combination with the mark GS
HUNGARY		MEEI	Hungarian Institute for Testing and Certification of Electrical Equipment
JAPAN		JIS Mark	Mark which guarantees compliance with the relevant Japanese Industrial Standard(s).
IRELAND		IIRS Mark	Electrical equipment
IRELAND		IIRS Mark	Electrical equipment





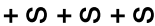





# 1 Standards

COUNTRY	Symbol	Mark designation	Applicability/Organization
ITALY		IMQ Mark	Mark to be affixed on electrical material for non-skilled users; it certifies compliance with the European Standard(s).
NORWAY		Norwegian Approval Mark	Mandatory safety approval for low voltage material and equipment
NETHERLANDS		KEMA-KEUR	General for all equipment
POLAND		KWE	Electrical products
RUSSIA		Certification of Conformity	Electrical and non-electrical products. It guarantees compliance with national standard (Gosstandard of Russia)
SINGAPORE		SISIR	Electrical and non-electrical products
SLOVENIA	 SIQ - Slovenia	SIQ	Slovenian Institute of Quality and Metrology
SPAIN		AEE	Electrical products. The mark is under the control of the Asociación Electrotécnica Española (Spanish Electrotechnical Association)

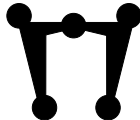

# 1 Standards

COUNTRY	Symbol	Mark designation	Applicability/Organization
SPAIN		AENOR	Asociación Española de Normalización y Certificación. (Spanish Standardization and Certification Association)
SWEDEN		SEMKO Mark	Mandatory safety approval for low voltage material and equipment.
SWITZERLAND	 * PZ 1	Safety Mark	Swiss low voltage material subject to mandatory approval (safety).
SWITZERLAND	 -----	-	Cables subject to mandatory approval
SWITZERLAND		SEV Safety Mark	Low voltage material subject to mandatory approval
UNITED KINGDOM		ASTA Mark	Mark which guarantees compliance with the relevant "British Standards"
UNITED KINGDOM	 BASEC	BASEC Mark	Mark which guarantees compliance with the "British Standards" for conductors, cables and ancillary products.
UNITED KINGDOM		BASEC Identification Thread	Cables

# 1 Standards

COUNTRY	Symbol	Mark designation	Applicability/Organization
UNITED KINGDOM		BEAB Safety Mark	Compliance with the "British Standards" for household appliances
UNITED KINGDOM		BSI Safety Mark	Compliance with the "British Standards"
UNITED KINGDOM		BEAB Kitemark	Compliance with the relevant "British Standards" regarding safety and performances
U.S.A.		UNDERWRITERS LABORATORIES Mark	Electrical and non-electrical products
U.S.A.		UNDERWRITERS LABORATORIES Mark	Electrical and non-electrical products
U.S.A.		UL Recognition	Electrical and non-electrical products
CEN		CEN Mark	Mark issued by the European Committee for Standardization (CEN): it guarantees compliance with the European Standards.
CENELEC		Mark	Cables

# 1 Standards

COUNTRY	Symbol	Mark designation	Applicability/Organization
CENELEC		Harmonization Mark	Certification mark providing assurance that the harmonized cable complies with the relevant harmonized CENELEC Standards – identification thread
EC		Ex EUROPEA Mark	Mark assuring the compliance with the relevant European Standards of the products to be used in environments with explosion hazards
CEEel		CEEel Mark	Mark which is applicable to some household appliances (shavers, electric clocks, etc).

## EC - Declaration of Conformity

The EC Declaration of Conformity is the statement of the manufacturer, who declares under his own responsibility that all the equipment, procedures or services refer and comply with specific standards (directives) or other normative documents.

The EC Declaration of Conformity should contain the following information:

- name and address of the manufacturer or by its European representative;
- description of the product;
- reference to the harmonized standards and directives involved;
- any reference to the technical specifications of conformity;
- the two last digits of the year of affixing of the CE marking;
- identification of the signer.

A copy of the EC Declaration of Conformity shall be kept by the manufacturer or by his representative together with the technical documentation.

---

# 1 Standards

---

## 1.2 IEC Standards for electrical installation

The following pages list the main Standards which refer to the most common low voltage electrical applications and report their publication years. The Standards might have been amended, but the relevant amendments are not mentioned here.

<b>STANDARD</b>	<b>YEAR</b>	<b>TITLE</b>
IEC 60027-1	1992	Letter symbols to be used in electrical technology - Part 1: General
IEC 60034-1	2010	Rotating electrical machines - Part 1: Rating and performance
IEC 60617-DB-Snapshot	2010	Graphical symbols for diagrams
IEC 61082-1	2006	Preparation of documents used in electrotechnology - Part 1: Rules
IEC 60038	2009	IEC standard voltages
IEC 60664-1	2007	Insulation coordination for equipment within low-voltage systems - Part 1: Principles, requirements and tests
IEC 60909-0	2001	Short-circuit currents in three-phase a.c. systems - Part 0: Calculation of currents
IEC 60865-1	1993	Short-circuit currents - Calculation of effects - Part 1: Definitions and calculation methods
IEC 60076-1	2000	Power transformers - Part 1: General
IEC 60076-2	1993	Power transformers - Part 2: Temperature rise
IEC 60076-3	2000	Power transformers - Part 3: Insulation levels, dielectric tests and external clearances in air
IEC 60076-5	2006	Power transformers - Part 5: Ability to withstand short circuit
IEC/TR 60616	1978	Terminal and tapping markings for power transformers
IEC 60076-11	2004	Power transformers - Part 11: Dry-type transformers
IEC 60445	2010	Basic and safety principles for man-machine interface, marking and identification - Identification of equipment terminals and conductor terminations
IEC 60073	2002	Basic and safety principles for man-machine interface, marking and identification - Coding for indicators and actuators
IEC 60447	2004	Basic and safety principles for man-machine interface, marking and identification - Actuating principles
IEC 60947-1	2007	Low-voltage switchgear and controlgear - Part 1: General rules
IEC 60947-2	2009	Low-voltage switchgear and controlgear - Part 2: Circuit-breakers

# 1 Standards

<b>STANDARD</b>	<b>YEAR</b>	<b>TITLE</b>
IEC 60947-3	2008	Low-voltage switchgear and controlgear - Part 3: Switches, disconnectors, switch-disconnectors and fuse-combination units
IEC 60947-4-1	2009	Low-voltage switchgear and controlgear - Part 4-1: Contactors and motor-starters – Electro-mechanical contactors and motor-starters
IEC 60947-4-2	2007	Low-voltage switchgear and controlgear - Part 4-2: Contactors and motor-starters – AC semiconductor motor controllers and starters
IEC 60947-4-3	2007	Low-voltage switchgear and controlgear - Part 4-3: Contactors and motor-starters – AC semiconductor controllers and contactors for non-motor loads
IEC 60947-5-1	2009	Low-voltage switchgear and controlgear - Part 5-1: Control circuit devices and switching elements - Electromechanical control circuit devices
IEC 60947-5-2	2007	Low-voltage switchgear and controlgear - Part 5-2: Control circuit devices and switching elements – Proximity switches
IEC 60947-5-3	2005	Low-voltage switchgear and controlgear - Part 5-3: Control circuit devices and switching elements – Requirements for proximity devices with defined behaviour under fault conditions
IEC 60947-5-4	2002	Low-voltage switchgear and controlgear - Part 5: Control circuit devices and switching elements – Section 4: Method of assessing the performance of low energy contacts. Special tests
IEC 60947-5-5	2005	Low-voltage switchgear and controlgear - Part 5-5: Control circuit devices and switching elements - Electrical emergency stop device with mechanical latching function
IEC 60947-5-6	1999	Low-voltage switchgear and controlgear - Part 5-6: Control circuit devices and switching elements – DC interface for proximity sensors and switching amplifiers (NAMUR)
IEC 60947-6-1	2005	Low-voltage switchgear and controlgear - Part 6-1: Multiple function equipment – Transfer switching equipment
IEC 60947-6-2	2007	Low-voltage switchgear and controlgear - Part 6-2: Multiple function equipment - Control and protective switching devices (or equipment) (CPS)
IEC 60947-7-1	2009	Low-voltage switchgear and controlgear - Part 7: Ancillary equipment - Section 1: Terminal blocks for copper conductors

# 1 Standards

<b>STANDARD</b>	<b>YEAR</b>	<b>TITLE</b>
IEC 60947-7-2	2009	Low-voltage switchgear and controlgear - Part 7: Ancillary equipment - Section 2: Protective conductor terminal blocks for copper conductors
IEC 61439-1	2009	Low-voltage switchgear and controlgear assemblies - Part 1: General rules
IEC 60439-2	2005	Low-voltage switchgear and controlgear assemblies - Part 2: Particular requirements for busbar trunking systems (busways)
IEC 60439-3	2001	Low-voltage switchgear and controlgear assemblies - Part 3: Particular requirements for low-voltage switchgear and controlgear assemblies intended to be installed in places where unskilled persons have access for their use - Distribution boards
IEC 60439-4	2004	Low-voltage switchgear and controlgear assemblies - Part 4: Particular requirements for assemblies for construction sites (ACS)
IEC 60439-5	2006	Low-voltage switchgear and controlgear assemblies - Part 5: Particular requirements for assemblies for power distribution in public networks
IEC 61095	2009	Electromechanical contactors for household and similar purposes
IEC/TR 60890	1987	A method of temperature-rise assessment by extrapolation for partially type-tested assemblies (PTTA) of low-voltage switchgear and controlgear
IEC/TR 61117	1992	A method for assessing the short-circuit withstand strength of partially type-tested assemblies (PTTA)
IEC 60092-303	1980	Electrical installations in ships. Part 303: Equipment - Transformers for power and lighting
IEC 60092-301	1980	Electrical installations in ships. Part 301: Equipment - Generators and motors
IEC 60092-101	2002	Electrical installations in ships - Part 101: Definitions and general requirements
IEC 60092-401	1980	Electrical installations in ships. Part 401: Installation and test of completed installation
IEC 60092-201	1994	Electrical installations in ships - Part 201: System design - General
IEC 60092-202	1994	Electrical installations in ships - Part 202: System design - Protection

# 1 Standards

STANDARD	YEAR	TITLE
IEC 60092-302	1997	Electrical installations in ships - Part 302: Low-voltage switchgear and controlgear assemblies
IEC 60092-350	2008	Electrical installations in ships - Part 350: General construction and test methods of power, control and instrumentation cables for shipboard and offshore applications
IEC 60092-352	2005	Electrical installations in ships - Part 352: Choice and installation of electrical cables
IEC 60364-5-52	2009	Electrical installations of buildings - Part 5-52: Selection and erection of electrical equipment – Wiring systems
IEC 60227		Polyvinyl chloride insulated cables of rated voltages up to and including 450/750 V
	2007	Part 1: General requirements
	2003	Part 2: Test methods
	1997	Part 3: Non-sheathed cables for fixed wiring
	1997	Part 4: Sheathed cables for fixed wiring
	2003	Part 5: Flexible cables (cords)
	2001	Part 6: Lift cables and cables for flexible connections
	2003	Part 7: Flexible cables screened and unscreened with two or more conductors
IEC 60228	2004	Conductors of insulated cables
IEC 60245		Rubber insulated cables - Rated voltages up to and including 450/750 V
	2008	Part 1: General requirements
	1998	Part 2: Test methods
	1994	Part 3: Heat resistant silicone insulated cables
	2004	Part 4: Cord and flexible cables
	1994	Part 5: Lift cables
	1994	Part 6: Arc welding electrode cables
	1994	Part 7: Heat resistant ethylene-vinyl acetate rubber insulated cables
	2004	Part 8: Cords for applications requiring high flexibility
IEC 60309-2	2005	Plugs, socket-outlets and couplers for industrial purposes - Part 2: Dimensional interchangeability requirements for pin and contact-tube accessories
IEC 61008-1	2010	Residual current operated circuit-breakers without integral overcurrent protection for household and similar uses (RCCBs) - Part 1: General rules
IEC 61008-2-1	1990	Residual current operated circuit-breakers without integral overcurrent protection for household and similar uses (RCCB's). Part 2-1: Applicability of the general rules to RCCB's functionally independent of line voltage



# 1 Standards

<b>STANDARD</b>	<b>YEAR</b>	<b>TITLE</b>
IEC 61008-2-2	1990	Residual current operated circuit-breakers without integral overcurrent protection for household and similar uses (RCCB's). Part 2-2: Applicability of the general rules to RCCB's functionally dependent on line voltage
IEC 61009-1	2010	Residual current operated circuit-breakers with integral overcurrent protection for household and similar uses (RCBOs) - Part 1: General rules
IEC 61009-2-1	1991	Residual current operated circuit-breakers with integral overcurrent protection for household and similar uses (RCBO's) Part 2-1: Applicability of the general rules to RCBO's functionally independent of line voltage
IEC 61009-2-2	1991	Residual current operated circuit-breakers with integral overcurrent protection for household and similar uses (RCBO's) - Part 2-2: Applicability of the general rules to RCBO's functionally dependent on line voltage
IEC 60670-1	2002	Boxes and enclosures for electrical accessories for household and similar fixed electrical installations - Part 1: General requirements
IEC 60669-2-1	2009	Switches for household and similar fixed electrical installations - Part 2-1: Particular requirements – Electronic switches
IEC 60669-2-2	2006	Switches for household and similar fixed electrical installations - Part 2: Particular requirements - Section 2: Remote-control switches (RCS)
IEC 60669-2-3	2006	Switches for household and similar fixed electrical installations - Part 2-3: Particular requirements – Time-delay switches (TDS)
IEC 60079-10-1	2009	Explosive atmospheres Part 10 -1: Classification of area - explosive gas atmospheres
IEC 60079-14	2007	Explosive atmospheres Part 14: Electrical installation design, selection and erection
IEC 60079-17	2007	Electrical apparatus for explosive gas atmospheres - Part 17: Inspection and maintenance of electrical installations in hazardous areas (other than mines)
IEC 60269-1	2009	Low-voltage fuses - Part 1: General requirements
IEC 60269-2	2010	Low-voltage fuses. Part 2: Supplementary requirements for fuses for use by authorized persons (fuses mainly for industrial application) examples of standardized system of fuses A to J

# 1 Standards

<b>STANDARD</b>	<b>YEAR</b>	<b>TITLE</b>
IEC 60269-3	2010	Low-voltage fuses - Part 3-1: Supplementary requirements for fuses for use by unskilled persons (fuses mainly for household and similar applications) - Sections I to IV: examples of standardized system of fuses A to F
IEC 60127-1/10		Miniature fuses -
	2006	Part 1: Definitions for miniature fuses and general requirements for miniature fuse-links
	2010	Part 2: Cartridge fuse-links
	1988	Part 3: Sub-miniature fuse-links
	2005	Part 4: Universal Modular Fuse-Links (UMF) Through-hole and surface mount types
	1988	Part 5: Guidelines for quality assessment of miniature fuse-links
	1994	Part 6: Fuse-holders for miniature cartridge fuse-links
	2001	Part 10: User guide for miniature fuses
IEC 60364-1	2005	Low-voltage electrical installations Part 1: Fundamental principles, assessment of general characteristics, definitions
IEC 60364-4-41	2005	Low-voltage electrical installations Part 4-41: Protection for safety - Protection against electric shock
IEC 60364-4-42	2010	Electrical installations of buildings Part 4-42: Protection for safety - Protection against thermal effects
IEC 60364-4-43	2008	Electrical installations of buildings Part 4-43: Protection for safety - Protection against overcurrent
IEC 60364-4-44	2007	Electrical installations of buildings Part 4-44: Protection for safety - Protection against voltage disturbances and electromagnetic disturbances
IEC 60364-5-51	2005	Electrical installations of buildings Part 5-51: Selection and erection of electrical equipment Common rules
IEC 60364-5-52	2009	Electrical installations of buildings Part 5-52: Selection and erection of electrical equipment Wiring systems
IEC 60364-5-53	2002	Electrical installations of buildings Part 5-53: Selection and erection of electrical equipment Isolation, switching and control
IEC 60364-5-54	2002	Electrical installations of buildings Part 5-54: Selection and erection of electrical equipment Earthing arrangements, protective conductors and protective bonding conductors

# 1 Standards

<b>STANDARD</b>	<b>YEAR</b>	<b>TITLE</b>
IEC 60364-5-55	2008	Electrical installations of buildings Part 5-55: Selection and erection of electrical equipment Other equipment
IEC 60364-6	2006	Electrical installations of buildings Part 6: Verification
IEC 60364-7	2004...2010	Electrical installations of buildings Part 7: Requirements for special installations or locations
IEC 60529	2001	Degrees of protection provided by enclosures (IP Code)
IEC 61032	1997	Protection of persons and equipment by enclosures - Probes for verification
IEC/TR 61000-1-1	1992	Electromagnetic compatibility (EMC) Part 1: General - Section 1: application and interpretation of fundamental definitions and terms
IEC/TR 61000-1-3	2002	Electromagnetic compatibility (EMC) Part 1-3: General - The effects of high-altitude EMP (HEMP) on civil equipment and systems



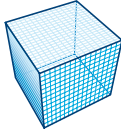

---

# Part 1

## Protection and control devices

## Index

### 1 Protection and control devices

1.1	Circuit-breaker nameplates.....	28
1.2	Main definitions .....	31
1.3	Types of releases.....	35
1.3.1	Thermomagnetic releases and only magnetic releases .....	35
1.3.2	Electronic releases.....	38
1.3.3	Residual current devices.....	44

### 2 General characteristics

2.1	Electrical characteristics of circuit breakers.....	50
2.2	Trip curves.....	58
2.2.1	Software "Curves 1.0" .....	59
2.2.2	Trip curves of thermomagnetic releases.....	60
2.2.3	Functions of electronic releases .....	65
2.3	Limitation curves .....	90
2.4	Specific let-through energy curves.....	93
2.5	Temperature derating .....	94
2.6	Altitude derating .....	106
2.7	Electrical characteristics of switch disconnectors .....	107

### 3 Protection coordination

3.1	Protection coordination .....	114
3.2	Discrimination tables .....	123
3.3	Back-up tables.....	156
3.4	Coordination tables between circuit breakers and switch disconnectors .....	162

### 4 Special applications

4.1	Direct current networks .....	166
4.2	Networks at particular frequencies; 400 Hz and 16 2/3 Hz .....	183
4.2.1	400 Hz networks .....	183
4.2.2	16 2/3 Hz networks.....	196
4.3	1000 Vdc and 1000 Vac networks .....	200
4.4	Automatic Transfer Switches .....	212

### 5 Switchboards

5.1	Electrical switchboards.....	214
5.2	MNS switchboards.....	229
5.3	ArTu distribution switchboards.....	230

**Annex A: Protection against short-circuit effects  
inside low-voltage switchboards .....** 233

**Annex B: Temperature rise evaluation  
according to IEC 60890 .....** 243

**Annex C: Application examples:  
Advanced protection functions with PR123/P and  
PR333/P releases .....** 257

# 1 Protection and control devices

## 1.1 Circuit-breaker nameplates

### Moulded-case circuit-breaker: SACE Tmax XT

**CIRCUIT-BREAKER TYPE**

Series <b>XT</b>	Size <b>1</b> <b>2</b> <b>3</b> <b>4</b>	Rated ultimate short-circuit breaking capacity at 415 Vac <b>B</b> = 18 kA (XT1) <b>C</b> = 25 kA (XT1) <b>N</b> = 36 kA <b>S</b> = 50 kA <b>H</b> = 70 kA <b>L</b> = 120 kA (XT2-XT4) <b>V</b> = 150 kA (XT2-XT4)	Size <b>160 A</b> <b>250 A</b>
---------------------	--	---	--------------------------------------

<b>Tmax XT1B 160</b>					$U_e=690V$ AC/500V DC $U_i=800V$ $U_{imp}=8kV$ S/N:
$U_e$ (V)	230	415	525	690	250
$I_{cu}$ (kA)	25	18	6	3	18
$I_{cs}$ (% $I_{cu}$ )	100	100	100	100	100
Cat A	~ 50-60Hz			--- 2P in series	

Rated insulation voltage **U<sub>i</sub>**; i.e. the maximum r.m.s. value of voltage which the circuit-breaker is capable of withstanding at the supply frequency under specified test conditions.

Rated impulse withstand voltage **U<sub>imp</sub>**; i.e. the peak value of impulse voltage which the circuit-breaker can withstand under specified test conditions.

**Serial number**

Rated ultimate short-circuit breaking capacity (**I<sub>cu</sub>**) and rated service short-circuit breaking capacity (**I<sub>cs</sub>**) at different voltage values.

According to the international Standard IEC 60947-2, the circuit breakers can be divided into Category **A**, i.e. without a specified short-time withstand current rating, or Category **B**, i.e. with a specified short-time withstand current rating.

**In** rated current

**CE** marking affixed on ABB circuit-breakers to indicate compliance with the following CE directives:  
 "Low Voltage Directive" (LVD) no. 2006/95/CE  
 "Electromagnetic Compatibility Directive" (EMC) no. 89/336 EEC.

28 Protection and control devices | ABB

# 1 Protection and control devices

## Moulded-case circuit-breaker: Tmax T

CIRCUIT-BREAKER TYPE			
Series <b>T</b>	Size <b>1</b> <b>2</b> <b>3</b> <b>4</b> <b>5</b> <b>6</b> <b>7</b>	Rated ultimate short-circuit breaking capacity at 415 Vac <b>B</b> = 16 kA <b>C</b> = 25 kA <b>N</b> = 36 kA <b>S</b> = 50 kA <b>H</b> = 70 kA <b>L</b> = 85 kA (for T2) <b>L</b> = 120 kA (for T4-T5-T7) <b>L</b> = 100 kA (for T6) <b>V</b> = 150 kA (for T7) <b>V</b> = 200 kA	Rated uninterrupted current 160 A 250 A 320 A 400 A 630 A 800 A 1000 A 1250 A 1600 A

<b>Tmax T2L 160</b>	$I_u=160A$	$U_e=690V$	$U_i=800V$	$U_{imp}=8kV$	IEC 60947-2			
$U_e$ (V)	230	400/415	440	500	690	250	500	Made in Italy
$I_{cu}$ (kA)	150	85	75	50	10	85	85	by ABB SACE
$I_{cs}$ (% $I_{cu}$ )	75	75	75	75	75	75	75	
Cat A	~ 50-60Hz			2 P $\overline{=}$ 3 P in series		CE		

Rated uninterrupted current  $I_u$

Rated operational voltage  $U_e$

Rated insulation voltage  $U_i$ ; i.e. the maximum r.m.s. value of voltage which the circuit-breaker is capable of withstanding at the supply frequency under specified test conditions.

Rated impulse withstand voltage  $U_{imp}$ ; i.e. the peak value of impulse voltage which the circuit-breaker can withstand under specified test conditions.

Rated ultimate short-circuit breaking capacity ( $I_{cu}$ ) and rated service short-circuit breaking capacity ( $I_{cs}$ ) at different voltage values.

According to the international Standard IEC 60947-2, the circuit breakers can be divided into Category **A**, i.e. without a specified short-time withstand current rating, or Category **B**, i.e. with a specified short-time withstand current rating.

**CE** marking affixed on ABB circuit-breakers to indicate compliance with the following CE directives: "Low Voltage Directive" (LVD) no. 2006/95/CE "Electromagnetic Compatibility Directive" (EMC) no. 89/336 EEC.

Compliance with the international Standard **IEC 60947-2**: "Low-Voltage switchgear and controlgear-Circuit-breakers".

# 1 Protection and control devices

## Air circuit-breaker: Emax

CIRCUIT-BREAKER TYPE			
Series <b>E</b>	Size <b>X1</b>	Rated ultimate short-circuit breaking capacity at 415 Vac	Rated uninterrupted current
	<b>1</b>	<b>B</b> = 42 kA	630 A
	<b>2</b>	<b>N</b> = 65 kA (50 kA E1)	800 A
	<b>3</b>	<b>S</b> = 75 kA (85 kA E2)	1000 A
	<b>4</b>	<b>H</b> = 100 kA	1250 A
	<b>6</b>	<b>L</b> = 130 kA (150 kA X1)	1600 A
		<b>V</b> = 150 kA (130 kA E3)	2000 A
			2500 A
			3200 A
			4000 A
			5000 A
			6300 A

Rated uninterrupted current **I<sub>u</sub>**

Rated operational voltage **U<sub>e</sub>**

Rated short-time withstand current **I<sub>cs</sub>**; i.e. the maximum current that the circuit-breaker can carry during a specified time.

SACE E3V 32		I <sub>u</sub> =3200A U <sub>e</sub> =690V					IEC 60947-2 made in Italy by ABB-SACE	CE
		I <sub>cs</sub> =85kA x 1s						
Cat B	~ 50-60 Hz							
U <sub>e</sub> (V)	230 415 440 525 690							
I <sub>cu</sub> (kA)	130 130 130 100 100							
I <sub>cs</sub> (kA)	100 100 100 85 85							

According to the international Standard IEC 60947-2, the circuit-breakers can be divided into Category **A**, i.e. without a specified short-time withstand current rating, or Category **B**, i.e. with a specified short-time withstand current rating.

Rated ultimate short-circuit breaking capacity (**I<sub>cu</sub>**) and rated service short-circuit breaking capacity (**I<sub>cs</sub>**) at different voltage values.

**CE** marking affixed on ABB circuit-breakers to indicate compliance with the following CE directives: "Low Voltage Directive" (LVD) no. 2006/95/CE "Electromagnetic Compatibility Directive" (EMC) no. 89/336 EEC.

Compliance with the international Standard **IEC 60947-2**: "Low-Voltage switchgear and controlgear-Circuit-breakers".



---

# 1 Protection and control devices

---

## 1.2 Main definitions

The main definitions regarding LV switchgear and controlgear are included in the international Standards IEC 60947-1, IEC 60947-2 and IEC 60947-3.

### **Main characteristics**

#### ***Circuit-breaker***

A mechanical switching device, capable of making, carrying and breaking currents under normal circuit conditions and also making, carrying for a specified time and breaking currents under specified abnormal circuit conditions such as those of short-circuit.

#### ***Current-limiting circuit-breaker***

A circuit-breaker with a break-time short enough to prevent the short-circuit current reaching its otherwise attainable peak value.

#### ***Plug-in circuit-breaker***

A circuit-breaker which, in addition to its interrupting contacts, has a set of contacts which enable the circuit-breaker to be removed.

#### ***Withdrawable circuit-breaker***

A circuit-breaker which, in addition to its interrupting contacts, has a set of isolating contacts which enable the circuit-breaker to be disconnected from the main circuit, in the withdrawn position, to achieve an isolating distance in accordance with specified requirements.

#### ***Moulded-case circuit-breaker***

A circuit-breaker having a supporting housing of moulded insulating material forming an integral part of the circuit-breaker.

#### ***Disconnecter***

A mechanical switching device which, in the open position, complies with the requirements specified for the isolating function.

#### ***Release***

A device, mechanically connected to a mechanical switching device, which releases the holding means and permits the opening or the closing of the switching device.

# 1 Protection and control devices

## Fault types and currents

### **Overload**

Operating conditions in an electrically undamaged circuit which cause an over-current.

### **Short-circuit**

The accidental or intentional connection, by a relatively low resistance or impedance, of two or more points in a circuit which are normally at different voltages.

### **Residual current ( $I_{\Delta}$ )**

It is the vectorial sum of the currents flowing in the main circuit of the circuit-breaker.

## Rated performances

### Voltages and frequencies

#### **Rated operational voltage ( $U_n$ )**

A rated operational voltage of an equipment is a value of voltage which, combined with a rated operational current, determines the application of the equipment and to which the relevant tests and the utilization categories are referred to.

#### **Rated insulation voltage ( $U_i$ )**

The rated insulation voltage of an equipment is the value of voltage to which dielectric tests voltage and creepage distances are referred. In no case the maximum value of the rated operational voltage shall exceed that of the rated insulation voltage.

#### **Rated impulse withstand voltage ( $U_{imp}$ )**

The peak value of an impulse voltage of prescribed form and polarity which the equipment is capable of withstanding without failure under specified conditions of test and to which the values of the clearances are referred.

#### **Rated frequency**

The supply frequency for which an equipment is designed and to which the other characteristic values correspond.

### Currents

#### **Rated uninterrupted current ( $I_n$ )**

The rated uninterrupted current for a circuit-breaker is a value of current, that the circuit-breaker can carry during uninterrupted service.

#### **Rated residual operating current ( $I_{\Delta n}$ )**

It is the r.m.s. value of a sinusoidal residual operating current assigned to the CBR by the manufacturer, at which the CBR shall operate under specified conditions.

## Performances under short-circuit conditions

# 1 Protection and control devices

## ***Rated making capacity***

The rated making capacity of an equipment is a value of current, stated by the manufacturer, which the equipment can satisfactorily make under specified making conditions.

## ***Rated breaking capacity***

The rated breaking of an equipment is a value of current, stated by the manufacturer, which the equipment can satisfactorily break, under specified breaking conditions.

## ***Rated ultimate short-circuit breaking capacity ( $I_{cu}$ )***

The rated ultimate short-circuit breaking capacity of a circuit-breaker is the maximum short-circuit current value which the circuit-breaker can break twice (in accordance with the sequence O – t – CO), at the corresponding rated operational voltage. After the opening and closing sequence the circuit-breaker is not required to carry its rated current.

## ***Rated service short-circuit breaking capacity ( $I_{cs}$ )***

The rated service short-circuit breaking capacity of a circuit-breaker is the maximum short-circuit current value which the circuit-breaker can break three times in accordance with a sequence of opening and closing operations (O – t – CO – t – CO) at a defined rated operational voltage ( $U_n$ ) and at a defined power factor. After this sequence the circuit-breaker is required to carry its rated current.

## ***Rated short-time withstand current ( $I_{cw}$ )***

The rated short-time withstand current is the current that the circuit-breaker in the closed position can carry during a specified short time under prescribed conditions of use and behaviour; the circuit-breaker shall be able to carry this current during the associated short-time delay in order to ensure discrimination between the circuit-breakers in series.

## ***Rated short-circuit making capacity ( $I_{cm}$ )***

The rated short-circuit making capacity of an equipment is the value of short-circuit making capacity assigned to that equipment by the manufacturer for the rated operational voltage, at rated frequency, and at a specified power-factor for ac.

# 1 Protection and control devices

## Utilization categories

The utilization category of a circuit-breaker shall be stated with reference to whether or not it is specifically intended for selectivity by means of an intentional time delay with respect to other circuit-breakers in series on the load side, under short-circuit conditions (Table 4 IEC 60947-2).

**Category A** - Circuit-breakers not specifically intended for selectivity under short-circuit conditions with respect to other short-circuit protective devices in series on the load side, i.e. without a short-time withstand current rating.

**Category B** - Circuit-breakers specifically intended for selectivity under short-circuit conditions with respect to other short-circuit protective devices in series on the load side, i.e. with and intentional short-time delay provided for selectivity under short-circuit conditions. Such circuit-breakers have a short-time withstand current rating.

A circuit-breaker is classified in category B if its  $I_{cw}$  is higher than (Table 3 IEC 60947-2):

12·In or 5 kA, whichever is the greater	for In ≤ 2500A
30 kA	for In > 2500A

## Electrical and mechanical durability

### *Mechanical durability*

The mechanical durability of an apparatus is expressed by the number of no-load operating cycles (each operating cycle consists of one closing and opening operation) which can be effected before it becomes necessary to service or replace any of its mechanical parts (however, normal maintenance may be permitted).

### *Electrical durability*

The electrical durability of an apparatus is expressed by the number of on-load operating cycles and gives the contact resistance to electrical wear under the service conditions stated in the relevant product Standard.

# 1 Protection and control devices

## 1.3 Types of releases

A circuit-breaker must control and protect, in case of faults or malfunctioning, the connected elements of a plant. In order to perform this function, after detection of an anomalous condition, the release intervenes in a definite time by opening the interrupting part.

The protection releases fitted with ABB SACE moulded-case and air circuit-breakers can control and protect any plant, from the simplest ones to those with particular requirements, thanks to their wide setting possibilities of both thresholds and tripping times.

Among the devices sensitive to overcurrents, the following can be considered:

- thermomagnetic releases and magnetic only releases;
- microprocessor-based releases;
- residual current devices.

The choice and adjusting of protection releases are based both on the requirements of the part of plant to be protected, as well as on the coordination with other devices; in general, discriminating factors for the selection are the required threshold, time and curve characteristic.

### 1.3.1 THERMOMAGNETIC RELEASES AND MAGNETIC ONLY RELEASES

The thermomagnetic releases use a bimetal and an electromagnet to detect overloads and short-circuits; they are suitable to protect both alternating and direct current networks.

The following table shows the types of thermo-magnetic and magnetic only trip units available for SACE Tmax XT and Tmax T circuit-breakers.

#### SACE Tmax XT

CBs	thermomagnetic releases				
	MF	MA	TMD	TMA	TMG
<b>XT1</b>	-	-	■	-	-
<b>XT2</b>	■	■	■	■	■
<b>XT3</b>	-	■	■	-	■
<b>XT4</b>	-	■	■	■	-

#### Legenda

MF Fixed magnetic only releases

MA Adjustable magnetic only releases

TMG Thermomagnetic release for generator protection

TMD Thermomagnetic release with adjustable thermal and fixed magnetic threshold

TMA Thermomagnetic release with adjustable thermal and magnetic threshold

# 1 Protection and control devices

## Power distribution

MCCBs		XT1	XT2	XT3	XT4				
In	Iu	160	160	250	250				
1,6		TMD	TMD	TMD	TMD				
2									
2,5									
3,2									
4									
5									
6,3									
8									
10									
12,5									
16						TMD TMG	TMD TMG	TMD	TMD
20									
25									
32									
40									
50	TMD								
63		TMA TMG	TMD TMG	TMA	TMA				
80									
100									
125									
160									
200									
225		-							
250			TMD/TMG						

### Legenda

MF Fixed magnetic only releases

MA Adjustable magnetic only releases

TMG Thermomagnetic release for generator protection

TMD Thermomagnetic release with adjustable thermal and fixed magnetic threshold

TMA Thermomagnetic release with adjustable thermal and magnetic threshold

## Motor protection

MCCBs		XT2	XT3	XT4
In	Iu	160	250	250
1		MF	TMD	TMD
2				
4				
8,5				
10				
12,5	MF	MA	MA	
20				
32				
52	MA			
80				
100				
125				
160				
200				

# 1 Protection and control devices

## Tmax T

CBs	thermomagnetic releases					
	MF	MA	TMF	TMD	TMA	TMG
<b>T1</b>	-	-	■	■	-	-
<b>T2</b>	■	■	-	■	-	■
<b>T3</b>	-	■	-	■	-	■
<b>T4</b>	-	■	-	■	■	-
<b>T5</b>	-	-	-	-	■	■
<b>T6</b>	-	-	-	-	■	-

## Power distribution

MCCBs		T1	T2	T3	T4	T5		T6	
In	Iu	160	160	250	250	400	630	630	800
1,6		TMD	TMD						
2									
2,5									
3,2									
4									
5									
6,3									
8									
10									
12.5									
16	TMF TMD	TMD	TMG	TMD					
20		TMG							
25		TMD							
32		TMG							
40		TMD							
50		TMG							
63		TMD							
80		TMG							
100		TMD							
125		TMG							
160	TMD	TMA							
200	TMD								
250	TMG								
320	TMD								
400	TMG								
500	TMD								
630	TMA								
800	TMG								

MCCBs		T2	T3	T4
In	Iu	160	250	250
1		MF		
1,6				
2				
2,5				
3,2				
4				
5				
6,5				
8,5				
10				
11		MA		
12,5				
20	MA			
25		MA		
32				
52	MA			
80				
100		MA		
125				
160				
200				

### Legenda

MF Fixed magnetic only releases  
 MA Adjustable magnetic only releases  
 TMG Thermomagnetic release for generator protection  
 TMF Thermomagnetic release with thermal and fixed magnetic threshold

TMD Thermomagnetic release with adjustable thermal and fixed magnetic threshold  
 TMA Thermomagnetic release with adjustable thermal and magnetic threshold

# 1 Protection and control devices

## 1.3.2 ELECTRONIC RELEASES

These releases are connected with current transformers (three or four according to the number of conductors to be protected), which are positioned inside the circuit-breaker and have the double functions of supplying the power necessary to the proper functioning of the release (self-supply) and of detecting the value of the current flowing inside the live conductors; therefore they are compatible with alternating current networks only.

The signal coming from the transformers and from the Rogowsky coils is processed by the electronic component (microprocessor) which compares it with the set thresholds. When the signal exceeds the thresholds, the trip of the circuit-breaker is operated through an opening solenoid which directly acts on the circuit-breaker operating mechanism.

In case of auxiliary power supply in addition to self-supply from the current transformers, the voltage shall be 24 Vdc  $\pm$  20%.

Besides the standard protection functions, releases provide:

- measurements of currents (Ekip LSI/LSIG + Ekip COM, Ekip M LRIU + Ekip COM, PR222, PR232, PR331, PR121);
- measurement of currents, voltage, frequency, power, energy, power factor (PR223, PR332, PR122) and moreover for PR333 and PR123, the measurement of harmonic distortions is available;
- serial communication with remote control for a complete management of the plant (Ekip LSI/LSIG + Ekip COM, Ekip M LRIU + Ekip COM, PR222, PR223, PR232, PR331, PR332, PR333, PR121, PR122, PR123).

The following table shows the types of electronic trip units available for SACE Tmax XT, Tmax T and Emax circuit-breakers.

CBs	electronic releases with ABB circuit breakers													
	Ekip	Ekip G	Ekip N	PR221	PR222	PR223	PR231	PR232	PR331	PR332	PR333	PR121	PR122	PR123
	I LSI LSIG	LS/I	LS/I	I LS/I	LSI LSIG	LSIG	I LS/I	LSI	LSIG	LI LSI LSIG LSRc	LI LSI LSIG	LI LSI LSIG	LI LSI LSIG LSRc	LI LSI LSIG
XT2	■	■	■	-	-	-	-	-	-	-	-	-	-	-
XT4	■	■	■	-	-	-	-	-	-	-	-	-	-	-
T2	-	-	-	■	-	-	-	-	-	-	-	-	-	-
T4	-	-	-	■	■	■	-	-	-	-	-	-	-	-
T5	-	-	-	■	■	■	-	-	-	-	-	-	-	-
T6	-	-	-	■	■	■	-	-	-	-	-	-	-	-
T7	-	-	-	-	-	-	■	■	■	■	-	-	-	-
X1	-	-	-	-	-	-	-	-	■	■	■	-	-	-
E1	-	-	-	-	-	-	-	-	-	-	-	■	■	■
E2	-	-	-	-	-	-	-	-	-	-	-	■	■	■
E3	-	-	-	-	-	-	-	-	-	-	-	■	■	■
E4	-	-	-	-	-	-	-	-	-	-	-	■	■	■
E5	-	-	-	-	-	-	-	-	-	-	-	■	■	■
E6	-	-	-	-	-	-	-	-	-	-	-	■	■	■



# 1 Protection and control devices

The following table shows the available rated currents with the SACE Tmax XT, Tmax T and Emax circuit- breakers.

MCCBs		XT2		XT4		T2		T4		T5		T6			T7			
In	Iu	160	160	250	160	250	320	400	630	630	800	1000	800	1000	1250	1600		
10		■ <sup>(1)</sup>	-	-	■	-	-	-	-	-	-	-	-	-	-	-		
25		■ <sup>(1)</sup>	-	-	■	-	-	-	-	-	-	-	-	-	-	-		
40		-	■	■	-	-	-	-	-	-	-	-	-	-	-	-		
63		■	■	■	■	-	-	-	-	-	-	-	-	-	-	-		
100		■	■	■	■	■	■	-	-	-	-	-	-	-	-	-		
160		■ <sup>(1)</sup>	■	■	■	■	■	-	-	-	-	-	-	-	-	-		
250		-	-	■ <sup>(1)</sup>	-	■	■	-	-	-	-	-	-	-	-	-		
320		-	-	-	-	-	■	■	■	-	-	-	-	-	-	-		
400		-	-	-	-	-	-	■	■	-	-	-	■	■	■	■		
630		-	-	-	-	-	-	-	■	■	-	-	■	■	■	■		
800		-	-	-	-	-	-	-	-	-	■	-	■	■	■	■		
1000		-	-	-	-	-	-	-	-	-	-	■	-	■	■	■		
1250		-	-	-	-	-	-	-	-	-	-	-	-	-	■	■		
1600		-	-	-	-	-	-	-	-	-	-	-	-	-	-	■		

<sup>(1)</sup> Not available for Ekip N and Ekip I; only for XT2 In=10 A not available with Ekip G

The following table shows the available rated currents for motor protection with the SACE Tmax XT and Tmax T circuit- breakers.

SACE Tmax XT					
MCCBs		XT2 160		XT4 160	XT4 250
In	Trip units	Ekip M I	Ekip M LIU or LRIU		
20		■	-	-	-
25		-	■	-	-
32		■	-	-	-
40		-	-	■	■
52		■	-	-	-
63		-	■	■	■
100		■	■	■	■
160		-	-	-	■

Tmax T					
MCCBs		T2 160	T4 250	T5 400	T6 800
In	Trip units	PR221MP LI	PR222MP LRIU		
40		■	-	-	-
63		■	-	-	-
100		■	■	-	-
160		-	■	-	-
200		-	■	-	-
320		-	-	■	-
400		-	-	■	-
630		-	-	-	■

# 1 Protection and control devices

ACBs		E3H-V		E3 N-S-H-V		E3 S-H-V-L		E3 N-S-H-V	E4S-H-V	E6V	E6H-V		
		E2S		E2N-S-L	E2B-N-S-L	E2B-N-S							
		E1B-N											
		X1B-N-L			X1B-N								
In	lu	630	800	1250 <sup>(2)</sup>	1600	2000	2500	3200	4000	3200	4000	5000	6300
400		■	■	■	■	■	■	■	-	-	-	-	-
630		■	■	■	■	■	■	■	-	-	-	-	-
800		-	■	■	■	■	■	■	-	-	-	-	-
1000		-	-	■	■	■	■	■	-	-	-	-	-
1250		-	-	■	■	■	■	■	■	■	-	-	-
1600		-	-	-	■	■	■	■	■	■	-	-	-
2000		-	-	-	-	■	■	■	■	■	-	-	-
2500		-	-	-	-	-	■	■	■	■	-	-	-
3200		-	-	-	-	-	-	■	■	■	■	■	■
4000		-	-	-	-	-	-	-	-	■	-	■	■
5000		-	-	-	-	-	-	-	-	-	-	■	■
6300		-	-	-	-	-	-	-	-	-	-	-	■

<sup>(2)</sup> Also for lu = 1000 A (not available for E3V and E2L).

### Example of reading from the table

The circuit-breaker type E3L is available with lu=2000A and lu=2500A, but it is not available with lu=3200A.

# 1 Protection and control devices

## 1.3.2.1 PROTECTION FUNCTIONS OF ELECTRONIC RELEASES

The protection functions available for the electronic releases are:

### **L - Overload protection with inverse long time delay**

Function of protection against overloads with inverse long time delay and constant specific let-through energy; it cannot be excluded.

### **L - Overload protection in compliance with Std. IEC 60255-3**

Function of protection against overloads with inverse long time delay and trip curves complying with IEC 60255-3; applicable in the coordination with fuses and with medium voltage protections.

### **S - Short-circuit protection with adjustable delay**

Function of protection against short-circuit currents with adjustable delay; thanks to the adjustable delay, this protection is particularly useful when it is necessary to obtain selective coordination between different devices.

### **S<sub>2</sub> - Double S**

This function allows two thresholds of protection function S to be set independently and activated simultaneously, selectivity can also be achieved under highly critical conditions.

### **D - Directional short-circuit protection with adjustable delay**

The directional protection, which is similar to function S, can intervene in a different way according to the direction of the short-circuit current; particularly suitable in meshed networks or with multiple supply lines in parallel.

### **I - Short-circuit protection with instantaneous trip**

Function for the instantaneous protection against short-circuit.

### **EFDP - Early Fault Detection and Prevention**

Thanks to this function, the release is able to isolate a fault in shorter times than the zone selectivities currently available on the market.

### **Rc - Residual current protection**

This function is particularly suitable where low-sensitivity residual current protection is required and for high-sensitivity applications to protect people against indirect contact.

### **G - Earth fault protection with adjustable delay**

Function protecting the plant against earth faults.

### **U - Phase unbalance protection**

Protection function which intervenes when an excessive unbalance between the currents of the single phases protected by the circuit-breaker is detected.

### **OT - Self-protection against overtemperature**

Protection function controlling the opening of the circuit-breaker when the temperature inside the release can jeopardize its functioning.

### **UV - Undervoltage protection**

Protection function which intervenes when the phase voltage drops below the preset threshold.

### **OV - Overvoltage protection**

Protection function which intervenes when the phase voltage exceeds the preset threshold.

### **RV - Residual voltage protection**

Protection which identifies anomalous voltages on the neutral conductor.

### **RP - Reverse power protection**

Protection which intervenes when the direction of the active power is oppo-

# 1 Protection and control devices

to normal operation.

## **UF - Under frequency protection**

This frequency protection detects the reduction of network frequency above the adjustable threshold, generating an alarm or opening the circuit.

## **OF - Overfrequency protection**

This frequency protection detects the increase of network frequency above the adjustable threshold, generating an alarm or opening the circuit.

## **M - Thermal memory**

Thanks to this function, it is possible to take into account the heating of a component so that the tripping is the quicker the less time has elapsed since the last one.

## **R - Protection against rotor blockage**

Function intervening as soon as conditions are detected, which could lead to the block of the rotor of the protected motor during operation.

## **linst - Very fast instantaneous protection against short-circuit**

This particular protection function has the aim of maintaining the integrity of the circuit-breaker and of the plant in case of high currents requiring delays lower than those guaranteed by the protection against instantaneous short-circuit. This protection must be set exclusively by ABB SACE and cannot be excluded.

## **Dual setting**

With this function it is possible to program two different sets of parameters (LSIG) and, through an external command, to switch from one set to the other.

## **K - Load control**

Thanks to this function, it is possible to engage/disengage individual loads on the load side before the overload protection L trips.

# 1 Protection and control devices

The following table summarizes the types of electronic release and the functions they implement:

				Ekip	
				Ekip-G	Tmax XT
				Ekip-N	
				PR221	Tmax T
				PR222	
				PR223	
				PR231	
				PR232	
				PR331	T7/X1
				PR332	
				PR333	X1
				PR121	Emax
				PR122	
				PR123	
Protection functions					
■ ■ ■ ■	■ ■ ■ ■ ■ ■	■ ■ ■ ■ ■ ■ ■ ■	■ ■ ■ ■ ■ ■ ■ ■	<b>L</b> (t=k/l <sup>2</sup> )	Protection against overload
			■ ■ ■ ■ ■ ■ ■ ■	<b>L</b>	Standard trip curve according to IEC 60255-3
■ ■ ■ ■	■ ■ ■ ■ ■ ■	■ ■ ■ ■ ■ ■ ■ ■	■ ■ ■ ■ ■ ■ ■ ■	<b>S1</b> (t=k)	Protection against short-circuit with time delay
■ ■ ■ ■	■ ■ ■ ■ ■ ■	■ ■ ■ ■ ■ ■ ■ ■	■ ■ ■ ■ ■ ■ ■ ■	<b>S1</b> (t=k/l <sup>2</sup> )	Protection against short-circuit with time delay
			■ ■ ■ ■ ■ ■ ■ ■	<b>S2</b> (t=k)	Protection against short-circuit with time delay
			■ ■ ■ ■ ■ ■ ■ ■	<b>D</b> (t=k)	Protection against directional short-circuit
■ ■ ■ ■	■ ■ ■ ■ ■ ■	■ ■ ■ ■ ■ ■ ■ ■	■ ■ ■ ■ ■ ■ ■ ■	<b>I</b> (t=k)	Protection against instantaneous short-circuit
■ ■ ■ ■	■ ■ ■ ■	■ ■ ■ ■ ■ ■ ■ ■	■ ■ ■ ■ ■ ■ ■ ■	<b>G</b> (t=k)	Protection against earth fault with adjustable delay
	■ ■ ■ ■	■ ■ ■ ■ ■ ■ ■ ■	■ ■ ■ ■ ■ ■ ■ ■	<b>G</b> (t=k/l <sup>2</sup> )	Protection against earth fault with adjustable delay
			■ ■ ■ ■ ■ ■ ■ ■	<b>Gext</b> (t=k)	Protection against earth fault with adjustable delay
			■ ■ ■ ■ ■ ■ ■ ■	<b>Gext</b> (t=k/l <sup>2</sup> )	Protection against earth fault with adjustable delay
			■ ■ ■ ■ ■ ■ ■ ■	<b>Gext</b> (Idn)	Protection against earth fault with adjustable delay
			○ ■ ■ ■ ○ ■ ■ ■	<b>Rc</b> (t=k)	Residual current protection
			■ ■ ■ ■ ■ ■ ■ ■	<b>U</b> (t=k)	Protection against phase unbalance
			■ ■ ■ ■ ■ ■ ■ ■	<b>OT</b>	Protection against temperature out of range
			○ ■ ■ ■ ○ ■ ■ ■	<b>UV</b> (t=k)	Protection against undervoltage
			○ ■ ■ ■ ○ ■ ■ ■	<b>OV</b> (t=k)	Protection against overvoltage
			○ ■ ■ ■ ○ ■ ■ ■	<b>RV</b> (t=k)	Protection against residual voltage
			○ ■ ■ ■ ○ ■ ■ ■	<b>RP</b> (t=k)	Protection against reverse active power
			○ ■ ■ ■ ○ ■ ■ ■	<b>UF</b>	Protection against underfrequency
			○ ■ ■ ■ ○ ■ ■ ■	<b>OF</b>	Protection against overfrequency
			■ ■ ■ ■ ■ ■ ■ ■	<b>Inst</b>	Instantaneous self-protection
	■ ■ ■ ■		■ ■ ■ ■ ■ ■ ■ ■	<b>EF</b>	Early Fault Detection and Prevention

○ Only with PR120/V for Emax and PR330/V for X1

# 1 Protection and control devices

## 1.3.3 RESIDUAL CURRENT DEVICES

The residual current releases are associated with the circuit-breaker in order to obtain two main functions in a single device:

- protection against overloads and short-circuits;
- protection against indirect contacts (presence of voltage on exposed conductive parts due to loss of insulation).

Besides, they can guarantee an additional protection against the risk of fire deriving from the evolution of small fault or leakage currents which are not detected by the standard protections against overload.

Residual current devices having a rated residual current not exceeding 30 mA are also used as a means for additional protection against direct contact in case of failure of the relevant protective means.

Their logic is based on the detection of the vectorial sum of the line currents through an internal or external toroid.

This sum is zero under service conditions or equal to the earth fault current ( $I_A$ ) in case of earth fault.

When the release detects a residual current different from zero, it opens the circuit-breaker through an opening solenoid.

As we can see in the picture the protection conductor or the equipotential conductor have to be installed outside the eventual external toroid.

### Generic distribution system (IT, TT, TN)

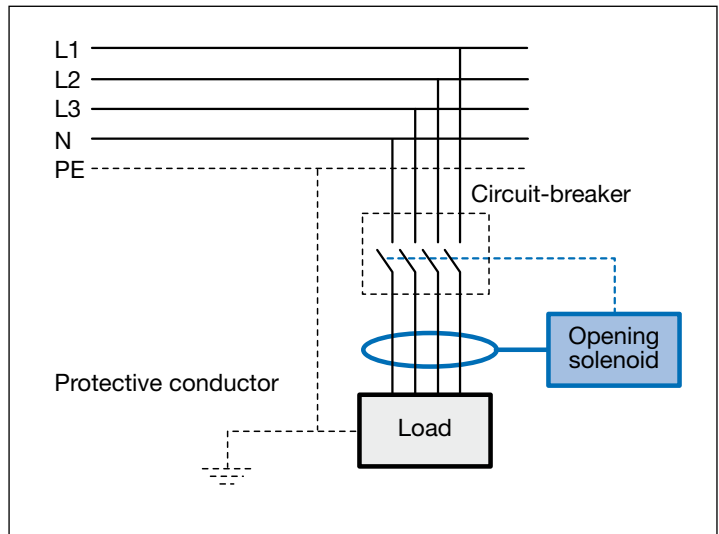





The operating principle of the residual current release makes it suitable for the distribution systems TT, IT (even if paying particular attention to the latter) and TN-S, but not in the systems TN-C. In fact, in these systems, the neutral is used also as protective conductor and therefore the detection of the residual current would not be possible if the neutral passes through the toroid, since the vectorial sum of the currents would always be equal to zero.

# 1 Protection and control devices

One of the main characteristics of a residual current release is its minimum rated residual current  $I_{\Delta n}$ . This represents the sensitivity of the release.

According to their sensitivity to the fault current, the residual current circuit-breakers are classified as:

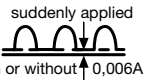
- type AC: a residual current device for which tripping is ensured in case of residual sinusoidal alternating current, in the absence of a dc component whether suddenly applied or slowly rising;
- type A: a residual current device for which tripping is ensured for residual sinusoidal alternating currents in the presence of specified residual pulsating direct currents, whether suddenly applied or slowly rising.
- type B residual current device for which tripping is ensured for residual sinusoidal alternating currents in presence of specified residual pulsating direct currents whether suddenly applied or slowly rising, for residual direct currents may result from rectifying circuits.

	Form of residual current	Correct functioning of residual current devices		
		Type	AC	A
Sinusoidal ac	 suddenly applied	AC	A	B
	 slowly rising	+	+	+
Pulsating dc	 suddenly applied with or without $\uparrow$ 0,006A		+	+
	 slowly rising			
Smooth dc				+

In presence of electrical apparatuses with electronic components (computers, photocopiers, fax etc.) the earth fault current might assume a non sinusoidal shape but a type of a pulsating unidirectional dc shape. In these cases it is necessary to use a residual current release classified as type A.

In presence of rectifying circuits (i.e. single phase connection with capacitive load causing smooth direct current, three pulse star connection or six pulse bridge connection, two pulse connection line-to-line) the earth fault current might assume a unidirectional dc shape. In this case it is necessary to use a residual current release classified as type B.

# 1 Protection and control devices

In order to fulfill the requirements for an adequate protection against earth faults ABB SACE has designed the following product categories:

## - Miniature circuit-breakers:

- RCBOs(residual current operated circuit-breakers with integral overcurrent protection) DS201, DS202C series with rated current from 1 A up to 40 A;
- RCBOs (residual current operated circuit-breakers with integral overcurrent protection) DS200 with rated current from 6A up to 63A;
- RCBOs (residual current operated circuit-breakers with integral overcurrent protection) DS800 with 125A rated current;
- RCDBlocks(residual current blocks) DDA 200 type to be coupled with the thermal magnetic circuit-breakers type S200 with rated current from 0.5 A to 63 A;
- RCDBlocks (residual current blocks) DDA 60, DDA 70, DD 90 type to be coupled with the thermal magnetic circuit-breakers type S290 with rated current from 80 A to 100 A with C characteristic curve;
- RCDBlocks (residual current blocks) DDA 800 type to be coupled with the thermal magnetic circuit-breakers type S800N and S800S with rated current up to 100 A. These blocks are available in two sizes: 63 A and 100 A;
- RCCBs (residual current circuit-breakers) F200 type, with rated current from 16 A to 125 A.
- RD2-RD3: residual current monitor for fixing on DIN rail.

## - Tmax XT moulded case circuit breakers:

- RC Sel 200mm XT1 (with adjustable time of non trip): residual current releases can be installed in 200mm modules; it can be coupled with X1 circuit breakers with a rated current up to 160A.
- RC Sel XT1-XT3 (with adjustable time of non trip): residual current releases to be coupled with circuit breakers XT1, XT3 with a rated current up to 160A with XT1 and 250A with XT3



# 1 Protection and control devices

- RC Inst XT1-XT3 (instantaneous): residual current releases to be coupled with circuit breakers XT1, XT3 with a rated current up to 160A.
- RC Sel XT2-XT4 (with adjustable time of non trip): residual current releases to be coupled with circuit breakers XT2, XT4 with a rated current up to 160A with XT2 and 250A with XT4
- RC B Type XT3 (with adjustable time of non trip): residual current releases to be coupled with circuit breaker XT3 with a rated current up to 225A
- Electronic trip units Ekip LSIG for circuit breakers XT2 and XT4 with a rated current from 10 to 250A.

		RC Sel 200mm XT1	RC Inst XT1-XT3	RC Sel XT1-XT3	RC Sel XT2-XT4	RC B Type XT3
Type		"L" shaped	"L" shaped	"L" shaped	Placed below	Placed below
Technology		Microprocessor - based				
Primary power supply voltage	[V]	85...500	85...500	85...500	85...500	85...500
Operating frequency	[Hz]	45...66	45...66	45...66	45...66	45...66
Self-supply		■	■	■	■	■
Test operation range		85...500	85...500	85...500	85...500	85...500
Rated service current	[A]	up to 160	up to 160-XT1 up to 250-XT3	up to 160-XT1 up to 250-XT3	up to 160-XT2 up to 250-XT4	up to 225
Rated residual current trip	[A]	0.03-0.05-0.1- 0.2-0.3-0.5-1- 3-5-10	0.03-0.1-0.3- 0.5-1-3	0.03-0.05-0.1- 0.3-0.5-1-3- 5-10	0.03-0.05-0.1- 0.3-0.5-1-3- 5-10	0.03-0.05-0.1- 0.3-0.5-1
Adjustable NON-trip time settings et 2xIΔn	[s]	Instantaneous	Instantaneous	Instantaneous	Instantaneous	Instantaneous
		0.1-0.2-0.3- 0.5-1-2-3		0.1-0.2-0.3- 0.5-1-2-3	0.1-0.2-0.3- 0.5-1-2-3	0.1-0.2-0.3- 0.5-1-2-3

		RC Sel 200mm	RC Inst	RC Sel	RC Sel	RC B Type	Ekip LSIG
	In \ Type	A	A	A	A	B	-
XT1	16÷160	■	■	■	-	-	-
XT2	1.6÷160	-	-	-	■	-	■
XT3	63÷250	-	■	■	-	■ <sup>(1)</sup>	-
XT4	16÷250	-	-	-	■	-	■

<sup>(1)</sup> Up to 225 A

# 1 Protection and control devices

## - Tmax T moulded case circuit breakers:

- RC221 residual current releases to be coupled with circuit-breakers Tmax T1, T2, T3 with rated current from 16 A to 250A;
- RC222 residual current releases to be coupled with circuit-breakers Tmax T1,T2,T3,T4,T5 with rated currents from 16A to 500A;
- RC223 residual current releases to be coupled with circuit-breaker Tmax T4 with rated currents up to 250A;
- electronic releases PR222DS/P, PR223 DS/P LSIG for circuit breakers T4, T5, T6 with rated current from 100A to 1000A;
- electronic releases PR331, PR332 LSIG for the circuit breaker Tmax T7 with rated currents from 800A to 1600A;
- electronic release R332 with residual current integrated protection for the circuit-breaker type Tmax T7 with rated uninterrupted current from 800A to 1600A.

Circuit-breaker size		RC221		RC222		RC223	
		T1-T2-T3	T1-T2-T3	T4 and T5 4p	T4 4p		
Type		"L" shaped			placed below		
Technology		microprocessor-based					
Action		With trip coil					
Primary service voltage <sup>(1)</sup>	[V]	85...500	85...500	85...500	110...500		
Operating frequency	[Hz]	45...66	45...66	45...66	0-400-700-1000		
Self-supply		■	■	■	■		
Test operation range <sup>(1)</sup>		85...500	85...500	85...500	110...500		
Rated service current	[A]	up to 250 A	up to 250 A	up to 500 A	up to 250 A		
Rated residual current trip	[A]	0.03-0.1-0.3 0.5-1-3	0.03-0.05-0.1-0.3 0.5-1-3-5-10	0.03-0.05-0.1 0.3-0.5-1-3-5-10	0.03-0.05-0.1 0.3-0.5-1		
Time limit for non-trip	[s]	Istantaneous	Istantaneous - 0.1 -0.2-0.3-0.5-1-2-3	Istantaneous - 0.1 -0.2-0.3-0.5-1-2-3	Istantaneous -0- 0.1 -0.2-0.3-0.5-1-2-3		
Tolerance over trip times			±20%	±20%	±20%		

<sup>(1)</sup> Operation up to 50 V phase-neutral (55 V for RC223).

	In	Type	RC 221	RC 222	RC 223	PR332 LSIRc	PR222 LSIG	PR223 LSIG	PR332 LSIRc
			A-AC	A-AC	B	A-AC	-	-	-
T1	16÷160		■	■	-	-	-	-	-
T2	10÷160		■	■	-	-	-	-	-
T3	63÷250		■	■	■ <sup>(1)</sup>	-	-	-	-
T4	100÷320		-	■	■ <sup>(2)</sup>	-	■	■	-
T5	320÷630		-	■	-	-	■	■	-
T6	630÷1000		-	-	-	-	■	■	-
T7	800÷1600		-	-	-	■	-	-	■

<sup>(1)</sup> Up to 225 A

<sup>(2)</sup> Up to 250 A

# 1 Protection and control devices

## - Emax air circuit breaker:

- PR331, PR332, PR333 LSIG electronic releases for the circuit breaker Emax X1 with rated uninterrupted currents from 630A to 1600A;
- Air circuit breaker equipped with electronic releases type PR121, PR122, PR123 LSIG for the circuit breaker Emax E1 to E6 with rated uninterrupted currents from 400A to 6300A.
- PR332, PR333 electronic releases with residual current integrated protection for circuit-breaker Emax X1 with rated uninterrupted currents from 630A to 1600A;
- PR122 and PR123 electronic releases with residual current integrated protection for circuit-breakers Emax E1 to E6 with rated uninterrupted currents from 400A to 6300A

		PR332 PR333 LIRc	PR122 LIRc	PR331 PR332 PR333 LSIG	PR121 PR122 PR123 LSIG
		A-AC	A-AC	-	-
X1	Type				
	In	400÷1600	■	-	■
E1	400÷1600	-	■	-	■
E2	400÷2000	-	■	-	■
E3	400÷3200	-	■	-	■
E4	1250÷4000	-	-	-	■
E6	3200÷6300	-	-	-	■

## Residual current relay with external transformer

ABB SACE circuit breaker can be combined also with the residual current relays RCQ 020/A with separate toroid in order to fulfill the requirements when the installation conditions are particularly restrictive, such as with circuit breakers already installed, limited space in the circuit breaker compartment etc.

Thanks to the settings characteristics of the residual current and of the trip times, the residual current relays with external transformer can be easily installed also in the final stages of the plant; in particular, by selecting the rated residual current  $I_{\Delta n}=0.03A$  with instantaneous tripping, the circuit-breaker guarantees protection against indirect contact and represents an additional measure against direct contact also in the presence of particularly high earth resistance values. Such residual current relays are of the type with indirect action: the opening command given by the relay must cause the tripping of the circuit-breaker through a shunt opening release (to be provided by the user).

Residual current relays		SACE RCQ 020/A
Power supply voltage	AC [V]	115-230...415
Operating frequency	[Hz]	45÷66
TripThreshold adjustment $I_{\Delta n}$	[A]	0.03-0.05-0.1-0.3-0.5-1-3-5-10-30
Trip time adjustment	[s]	Inst-0.1-0.2-0.3-0.5-0.7-1-2-3-5

## 2 General characteristics

### 2.1 Electrical characteristics of circuit-breakers

#### Pro M compact miniature circuit-breakers

The following table shows an overview of the MCBs, for further details please refer to the technical catalogue.

Series		S200	S200 M	S200 P			SN 201 L	SN 201	
<b>Characteristics</b>		B, C, D, K, Z B, C, D, K, Z		B, C, D, K, Z			B, C	B, C, D	
<b>Rated current</b>	[A]	$0.5 \leq I_n \leq 63$	$0.5 \leq I_n \leq 63$	$0.2 \leq I_n \leq 25$	$32 \leq I_n \leq 40$	$50 \leq I_n \leq 63$	$2 \leq I_n \leq 40$	$2 \leq I_n \leq 40$	
<b>Breaking capacity</b>	[kA]								
<b>Reference standard</b>	Nr. poles Ue [V]								
IEC 23-3/EN 60898	<b>Icn</b> 230/400	6	10	25	15	15	4.5	6	
IEC/EN 60947-2	<b>Icu</b> 1, 1P+N	133	20	25 <sup>2</sup>	40	25	10	15	
		230	10	15 <sup>2</sup>	25	15	15	6	10
	2, 3, 4	230	20	25 <sup>2</sup>	40	25	25		
		400	10	15 <sup>2</sup>	25	15	15		
	2, 3, 4	500							
		690							
	<b>Ics</b> 1, 1P+N	133	15	18.7 <sup>2</sup>	20	18.7	18.7	6	10
		230	7.5	11.2 <sup>2</sup>	12.5	11.2	7.5	4.5	6
	2, 3, 4	230	15 <sup>1</sup>	18.7 <sup>2</sup>	20	18.7	18.7		
		400	7.5	11.2 <sup>2</sup>	12.5	11.2	7.5		
	2, 3, 4	500							
		690							
IEC/EN 60947-2	<b>Icu</b> 1, 1P+N	24	20						
Direct cuttnt		60	10	10	15	10	10	15	
T=I/R≤5ms for all series, except S280 UC and S800-UC	2	125							
		250							
whwre T=I/R<15ms	2	48	20						
		125	10	10	15	10	10	10	15
		250							
		500							
	3, 4	600							
		800							
	3, 4	375							
		500							
		750							
		1000							
	3, 4	1200							
		24	20						
	<b>Ics</b> 1, 1P+N	60	10	10	15	10	10	15	
		125							
	2	250							
		48	20						
		125	10	10	15	10	10	15	
		250							
	3, 4	500							
		600							
		800							
		375							
	3, 4	500							
		750							

<sup>1</sup> Only up to 40 A; 10 kA up to 50/63 A

<sup>2</sup> < 50 A

<sup>3</sup> Only for D characteristic

<sup>4</sup> Values are not for all rated currents

<sup>5</sup> 3 poles

<sup>6</sup> 4 poles

## 2 General characteristics

SN 201 M	S 280	S 280 UC		S 290	S800S					S800N	S800C
B, C $2 \leq I_n \leq 40$	B, C $80 \leq I_n \leq 100$	B, K, Z $0.2 \leq I_n \leq 40$	K, Z $50 \leq I_n \leq 63$	C, D, K $80 \leq I_n \leq 125$	B, C, D $10 \leq I_n \leq 125$	K $10 \leq I_n \leq 125$	KM $20 \leq I_n \leq 80$	UCB $10 \leq I_n \leq 125$	UCK $10 \leq I_n \leq 125$	B, C, D $10 \leq I_n \leq 125$	B, C, D, K $10 \leq I_n \leq 125$
10	6			10	25					20	15
20	15	10	6								
10	6	6	4.5	20 (15) <sup>3</sup>	50	50	50			36	
	10	10	6	25	50	50	50			36	25
	6	6	4.5	20 (15) <sup>3</sup>	50	50	50			36	25
					15 <sup>4</sup>	15 <sup>4</sup>	15 <sup>4</sup>			10 <sup>4</sup>	25
					6 <sup>4</sup>	6 <sup>4</sup>	6 <sup>4</sup>			4.5	
10	15	7.5	6								
7.5	6	6	4.5	10 (7.5) <sup>3</sup>	40	40	40			30	18
	10	7.5	6	12.5	40	40	40			30	18
	6	6	4.5	10 (7.5) <sup>3</sup>	40	40	40			30	18
					11 <sup>4</sup>	11 <sup>4</sup>	11 <sup>4</sup>			8 <sup>4</sup>	
					4 <sup>4</sup>	4 <sup>4</sup>	4 <sup>4</sup>			3	
15	10			25							
		6	4.5		30	30	30				
								50	50	20	10
15	10										
		6	4.5		30	30	30			20	10
								50	50		
					30 <sup>5</sup>	30 <sup>5</sup>	30 <sup>5</sup>	30 <sup>5</sup>	30 <sup>5</sup>	20 <sup>5</sup>	10 <sup>5</sup>
					30 <sup>6</sup>	30 <sup>6</sup>	30 <sup>6</sup>	30 <sup>6</sup>	30 <sup>6</sup>	20 <sup>6</sup>	10 <sup>6</sup>
								50	50		
15	10			12.5							
		6	4.5		30	30	30			20	10
								50	50		
15	10										
		6	4.5		30	30	30			20	10
								50	50		
					30 <sup>5</sup>	30 <sup>5</sup>	30 <sup>5</sup>	30 <sup>5</sup>	30 <sup>5</sup>	20 <sup>5</sup>	10 <sup>5</sup>
					30 <sup>6</sup>	30 <sup>6</sup>	30 <sup>6</sup>	30 <sup>6</sup>	30 <sup>6</sup>	20 <sup>6</sup>	10 <sup>6</sup>
								50	50		

## 2 General characteristics

### Tmax XT moulded-case circuit-breakers

			XT1				
Size	[A]		160				
Poles	[Nr.]		3, 4				
Rated service voltage, <b>U<sub>e</sub></b>	(AC) 50-60Hz	[V]	690				
	(DC)	[V]	500				
Rated insulation voltage, <b>U<sub>i</sub></b>		[V]	800				
Rated impulse withstand voltage, <b>U<sub>imp</sub></b>		[kV]	8				
Version			Fixed, Plug-in <sup>2</sup>				
<b>Breaking capacities</b>			<b>B</b>	<b>C</b>	<b>N</b>	<b>S</b>	<b>H</b>
<b>Rate ultimate short-circuit breaking capacity, I<sub>cu</sub></b>							
I <sub>cu</sub> @ 220-230V 50-60Hz (AC)	[kA]		25	40	65	85	100
I <sub>cu</sub> @ 380V 50-60Hz (AC)	[kA]		18	25	36	50	70
I <sub>cu</sub> @ 415V 50-60Hz (AC)	[kA]		18	25	36	50	70
I <sub>cu</sub> @ 440V 50-60Hz (AC)	[kA]		15	25	36	50	65
I <sub>cu</sub> @ 500V 50-60Hz (AC)	[kA]		8	18	30	36	50
I <sub>cu</sub> @ 525V 50-60Hz (AC)	[kA]		6	8	22	35	35
I <sub>cu</sub> @ 690V 50-60Hz (AC)	[kA]		3	4	6	8	10
I <sub>cu</sub> @ 250V (DC) 2 poles in series	[kA]		18	25	36	50	70
I <sub>cu</sub> @ 500V (DC) 2 poles in series	[kA]		18	25	36	50	70
<b>Rate service short-circuit breaking capacity, I<sub>cs</sub></b>							
I <sub>cs</sub> @ 220-230V 50-60Hz (AC)	[kA]		100%	100%	75% (50)	75%	75%
I <sub>cs</sub> @ 380V 50-60Hz (AC)	[kA]		100%	100%	100%	100%	75%
I <sub>cs</sub> @ 415V 50-60Hz (AC)	[kA]		100%	100%	100%	75%	50% (37.5)
I <sub>cs</sub> @ 440V 50-60Hz (AC)	[kA]		75%	50%	50%	50%	50%
I <sub>cs</sub> @ 500V 50-60Hz (AC)	[kA]		100%	50%	50%	50%	50%
I <sub>cs</sub> @ 525V 50-60Hz (AC)	[kA]		100%	100%	50%	50%	50%
I <sub>cs</sub> @ 690V 50-60Hz (AC)	[kA]		100%	100%	75%	50%	50%
I <sub>cs</sub> @ 250V (DC) 2 poles in series	[kA]		100%	100%	100%	75%	75%
I <sub>cs</sub> @ 500V (DC) 2 poles in series	[kA]		100%	100%	100%	75%	75%
<b>Rate short-circuit making capacity, I<sub>cm</sub></b>							
I <sub>cm</sub> @ 220-230V 50-60Hz (AC)	[kA]		52.5	84	143	187	220
I <sub>cm</sub> @ 380V 50-60Hz (AC)	[kA]		36	52.5	75.6	105	154
I <sub>cm</sub> @ 415V 50-60Hz (AC)	[kA]		36	52.5	75.6	105	154
I <sub>cm</sub> @ 440V 50-60Hz (AC)	[kA]		30	52.5	75.6	105	143
I <sub>cm</sub> @ 500V 50-60Hz (AC)	[kA]		13.6	36	63	75.6	105
I <sub>cm</sub> @ 525V 50-60Hz (AC)	[kA]		9.18	13.6	46.2	73.6	73.5
I <sub>cm</sub> @ 690V 50-60Hz (AC)	[kA]		4.26	5.88	9.18	13.6	17
Category of use (IEC 60947-2)			A				
Reference standard			IEC 60947-2				
Isolation behaviour			■				
Mounted on DIN rail			DIN EN 50022				
Mechanical life	[No. Operations]		25000				
	[No. Hourly Operations]		240				
Electrical life @ 415 V (AC)	[No. Operations]		8000				
	[No. Hourly Operations]		120				

<sup>(1)</sup> 90kA @ 690V only for XT4 160. Available shortly, please ask ABB SACE

<sup>(2)</sup> XT1 plug in version only with I<sub>n</sub> max = 125A

## 2 General characteristics

XT2					XT3		XT4				
160					250		160/250				
3, 4					3, 4		3, 4				
690					690		690				
500					500		500				
1000					800		1000				
8					8		8				
Fixed, Withdrawable, Plug-in					Fixed, Plug-in		Fixed, Withdrawable, Plug-in				
N	S	H	L	V	N	S	N	S	H	L	V
65	85	100	150	200	50	85	65	85	100	150	200
36	50	70	120	200	36	50	36	50	70	120	150
36	50	70	120	150	36	50	36	50	70	120	150
36	50	65	100	150	25	40	36	50	65	100	150
30	36	50	60	70	20	30	30	36	50	60	70
20	25	30	36	50	13	20	20	25	45	50	50
10	12	15	18	20	5	8	10	12	15	20	25 (90°)
36	50	70	120	150	36	50	36	50	70	120	150
36	50	70	120	150	36	50	36	50	70	120	150
100%	100%	100%	100%	100%	75%	50%	100%	100%	100%	100%	100%
100%	100%	100%	100%	100%	75%	50% (27)	100%	100%	100%	100%	100%
100%	100%	100%	100%	100%	75%	50% (27)	100%	100%	100%	100%	100%
100%	100%	100%	100%	100%	75%	50%	100%	100%	100%	100%	100%
100%	100%	100%	100%	100%	75%	50%	100%	100%	100%	100%	100%
100%	100%	100%	100%	75%	75%	50%	100%	100%	100%	100%	75% (20)
100%	100%	100%	100%	100%	100%	75%	100%	100%	100%	100%	100%
100%	100%	100%	100%	100%	100%	75%	100%	100%	100%	100%	100%
143	187	220	330	440	105	187	143	187	220	330	440
75.6	105	154	264	440	75.6	105	75.6	105	154	264	330
75.6	105	154	264	330	75.6	105	75.6	105	154	264	330
75.6	105	143	220	330	52.5	84	75.6	105	143	220	330
63	75.6	105	132	154	40	63	63	75.6	105	132	154
40	52.5	63	75.6	105	26	40	40	52.5	94.5	105	105
17	24	30	36	40	7.65	13.6	17	24	30	36	40
A					A		A				
IEC 60947-2					IEC 60947-2		IEC 60947-2				
■					■		■				
DIN EN 50022					DIN EN 50022		DIN EN 50022				
25000					25000		25000				
240					240		240				
8000					8000		8000				
120					120		120				

## 2 General characteristics

### Tmax T moulded-case circuit-breakers

		Tmax T1 1P		Tmax T1			Tmax T2			
				B	C	N	N	S	H	L
Rated uninterrupted cur rent, <b>I<sub>n</sub></b>	[A]	160		160			160			
Poles	[Nr]	1		3/4			3/4			
Rated service cur rent, <b>U<sub>e</sub></b>	(AC) 50-60 Hz [V]	240		690			690			
	(DC) [V]	125		500			500			
Rated impulse withstand voltage, <b>U<sub>imp</sub></b>	[kV]	8		8			8			
Rated insulation voltage, <b>U<sub>i</sub></b>	[V]	500		800			800			
Test voltage at industrial f reQUENCY for 1 min.	[V]	3000		3000			3000			
Rated ultimate short-ci rcuit breaking capacity, <b>I<sub>cu</sub></b>		<b>B</b>	<b>B</b>	<b>C</b>	<b>N</b>	<b>N</b>	<b>S</b>	<b>H</b>	<b>L</b>	
(AC) 50-60 Hz 220/230 V	[kA]	25*	25	40	50	65	85	100	120	
(AC) 50-60 Hz 380/415 V	[kA]	–	16	25	36	36	50	70	85	
(AC) 50-60 Hz 440 V	[kA]	–	10	15	22	30	45	55	75	
(AC) 50-60 Hz 500 V	[kA]	–	8	10	15	25	30	36	50	
(AC) 50-60 Hz 690 V	[kA]	–	3	4	6	6	7	8	10	
(DC) 250 V - 2 poles in series	[kA]	25 (at 125 V)	16	25	36	36	50	70	85	
(DC) 250 V - 3 poles in series	[kA]	–	20	30	40	40	55	85	100	
(DC) 500 V - 2 poles in series	[kA]	–	–	–	–	–	–	–	–	
(DC) 500 V - 3 poles in series	[kA]	–	16	25	36	36	50	70	85	
(DC) 750 V - 3 poles in series	[kA]	–	–	–	–	–	–	–	–	
Rated service short-ci rcuit breaking capacity, <b>I<sub>cs</sub></b>										
(AC) 50-60 Hz 220/230 V	[%I <sub>cu</sub> ]	75%	100%	75%	75%	100%	100%	100%	100%	
(AC) 50-60 Hz 380/415 V	[%I <sub>cu</sub> ]	–	100%	100%	75%	100%	100%	100%	75% (70 kA)	
(AC) 50-60 Hz 440 V	[%I <sub>cu</sub> ]	–	100%	75%	50%	100%	100%	100%	75%	
(AC) 50-60 Hz 500 V	[%I <sub>cu</sub> ]	–	100%	75%	50%	100%	100%	100%	75%	
(AC) 50-60 Hz 690 V	[%I <sub>cu</sub> ]	–	100%	75%	50%	100%	100%	100%	75%	
Rated short-ci rcuit making capacity, <b>I<sub>cm</sub></b>										
(AC) 50-60 Hz 220/230 V	[kA]	52.5	52.5	84	105	143	187	220	264	
(AC) 50-60 Hz 380/415 V	[kA]	–	32	52.5	75.6	75.6	105	154	187	
(AC) 50-60 Hz 440 V	[kA]	–	17	30	46.2	63	94.5	121	165	
(AC) 50-60 Hz 500 V	[kA]	–	13.6	17	30	52.5	63	75.6	105	
(AC) 50-60 Hz 690 V	[kA]	–	4.3	5.9	9.2	9.2	11.9	13.6	17	
Opening time (415 V)	[ms]	7	7	6	5	3	3	3	3	
Utilisation category (IEC 60947-2 )		A		A				A		
Reference Standard		IEC 60947-2		IEC 60947-2				IEC 60947-2		
Isolation behaviour		■		■				■		
Interchangeability		–		–				–		
Versions		F		F				F-P		
Mechanical life	[No. operations]	25000		25000				25000		
	[No. Hourly operations]	240		240				240		
Electrical life @ 415 V A C	[No. operations]	8000		8000				8000		
	[No. Hourly operations]	120		120				120		

F = fixed circuit-breakers  
P = plug-in circuit-breakers  
W = withdrawable circuit-breakers

□ The breaking capacity for settings In=16 A and In=20 A is 16 kA



## 2 General characteristics

Tmax T3		Tmax T4					Tmax T5					Tmax T6				Tmax T7			
250		250/320					400/630					630/800/1000				800/1000/1250/1600			
3/4		3/4					3/4					3/4				3/4			
690		690					690					690				690			
500		750					750					750				-			
8		8					8					8				8			
800		1000					1000					1000				1000			
3000		3500					3500					3500				3500			
N	S	N	S	H	L	V	N	S	H	L	V	N	S	H	L	S	H	L	V <sup>(6)</sup>
50	85	70	85	100	200	200	70	85	100	200	200	70	85	100	200	85	100	200	200
36	50	36	50	70	120	200	36	50	70	120	200	36	50	70	100	50	70	120	150
25	40	30	40	65	100	180	30	40	65	100	180	30	45	50	80	50	65	100	130
20	30	25	30	50	85	150	25	30	50	85	150	25	35	50	65	40	50	85	100
5	8	20	25	40	70	80	20	25	40	70	80	20	22	25	30	30	42	50	60
36	50	36	50	70	100	150	36	50	70	100	150	36	50	70	100	-	-	-	-
40	55	-	-	-	-	-	-	-	-	-	-	-	-	-	-	-	-	-	-
-	-	25	36	50	70	100	25	36	50	70	100	20	35	50	65	-	-	-	-
36	50	-	-	-	-	-	-	-	-	-	-	-	-	-	-	-	-	-	-
-	-	16	25	36	50	70	16	25	36	50	70	16	20	36	50	-	-	-	-
75%	50%	100%	100%	100%	100%	100%	100%	100%	100%	100%	100%	100%	100%	100%	75%	100%	100%	100%	100%
75%	50% (27 kA)	100%	100%	100%	100%	100%	100%	100%	100%	100%	100%	100%	100%	100%	75%	100%	100%	100%	100%
75%	50%	100%	100%	100%	100%	100%	100%	100%	100%	100%	100%	100%	100%	100%	75%	100%	100%	100%	100%
75%	50%	100%	100%	100%	100%	100%	100%	100%	100%	100%	100%	100%	100%	100%	75%	100%	100%	75%	100%
75%	50%	100%	100%	100%	100%	100%	100%	100%	100%	100%	100%	75%	75%	75%	75%	100%	75%	75%	75%
105	187	154	187	220	440	660	154	187	220	440	660	154	187	220	440	187	220	440	440
75.6	105	75.6	105	154	264	440	75.6	105	154	264	440	75.6	105	154	220	105	154	264	330
52.5	84	63	84	143	220	396	63	84	143	220	396	63	94.5	105	176	105	143	220	286
40	63	52.5	63	105	187	330	52.5	63	105	187	330	52.5	73.5	105	143	84	105	187	220
7.7	13.6	40	52.5	84	154	176	40	52.5	84	154	176	40	46	52.5	63	63	88.2	105	132
7	6	5	5	5	5	5	6	6	6	6	6	10	9	8	7	15	10	8	8
A		A					B (400 A) <sup>(6)</sup> - A (630 A)					B (630A - 800A) <sup>(6)</sup> - A (1000A)				B <sup>(7)</sup>			
IEC 60947-2		IEC 60947-2					IEC 60947-2					IEC 60947-2				IEC 60947-2			
■		■					■					■				■			
-		■					■					■				■			
F-P		F-P-W					F-P-W					F-W <sup>(6)</sup>				F-W			
25000		20000					20000					20000				10000			
240		240					120					120				60			
8000		8000 (250 A) - 6000 (320 A)					7000 (400 A) - 5000 (630 A)					7000 (630A) - 5000 (800A) - 4000 (1000A)				2000 (S-H-L versions) - 3000 (V version)			
120		120					60					60				60			

<sup>(1)</sup> 75% for T5 630<sup>(2)</sup> 50% for T5 630<sup>(3)</sup> Icw = 5 kA<sup>(4)</sup> W version is not available on T6 1000 A<sup>(5)</sup> Icw = 7.6 kA (630 A) - 10 kA (800 A)<sup>(6)</sup> Only for T7 800/1000/1250 A<sup>(7)</sup> Icw = 20 kA (S,H,L versions) - 15 kA (V version)

**Notes:** in the plug-in version of T2,T3,T5 630 and in the withdrawable version of T5 630 the maximum rated current available is derated by 10% at 40 °C

## 2 General characteristics

### SACE Emax air circuit-breakers

#### Common data

Voltages		
Rated operational voltage U <sub>e</sub>	[V]	690 ~
Rated insulation voltage U <sub>i</sub>	[V]	1000
Rated impulse withstand voltage U <sub>imp</sub>	[kV]	12
Service temperature		
	[°C]	-25.....+70
Storage temperature		
	[°C]	-40.....+70
Frequency f		
	[Hz]	50 - 60
Number of poles		
		3 - 4
Version		
		Fixed -Withdrawable

Performance levels		
Currents: rated uninterrupted current (at 40 °C) I <sub>u</sub>		[A]
		[A]
		[A]
		[A]
		[A]
		[A]
Neutral pole current-carrying capacity for 4-pole CBs		[%I <sub>u</sub> ]
Rated ultimate breaking capacity under short-circuit I <sub>cu</sub>		
220/230/380/400/415 V ~		[kA]
440 V ~		[kA]
500/525 V ~		[kA]
660/690 V ~		[kA]
Rated service breaking capacity under short-circuit I <sub>cs</sub>		
220/230/380/400/415 V ~		[kA]
440 V ~		[kA]
500/525 V ~		[kA]
660/690 V ~		[kA]
Rated short-time withstand current I <sub>sw</sub>		
	(1s)	[kA]
	(3s)	[kA]
Rated making capacity under short-circuit (peak value) I <sub>cm</sub>		
220/230/380/400/415 V ~		[kA]
440 V ~		[kA]
500/525 V ~		[kA]
660/690 V ~		[kA]
<b>Utilisation category</b> (according to IEC 60947-2)		
<b>Isolation behaviour</b> (according to IEC 60947-2)		
<b>Overcurrent protection</b>		
Electronic releases for AC applications		
<b>Operating times</b>		
Closing time (max)		[ms]
Breaking time for I <sub>cu</sub> (max) <sup>(1)</sup>		[ms]
Breaking time for I <sub>sw</sub> (max)		[ms]

(1) Without intentional delays

(2) Performance at 600 V is 100 kA

#### SACE Emax air circuit-breakers

Rated uninterrupted current (at 40 °C) I <sub>u</sub>	[A]
Mechanical life with regular ordinary maintenance	[No. operations x 1000]
Operation frequency	[Operations/hour]
Electrical life	(440 V ~) [No. operations x 1000]
	(690 V ~) [No. operations x 1000]
Operation frequency	[Operations/hour]

X1			E1 B-N		
800	1250	1600	800	1000-1250	1600
12.5	12.5	12.5	25	25	25
60	60	60	60	60	60
6	4	3	10	10	10
3	2	1	10	8	8
30	30	30	30	30	30

## 2 General characteristics

X1			E1		E2				E3				E4			E6		
B	N	L	B	N	B	N	S	L	N	S	H	V	L	S	H	V	H	V
630	630	630	800	800	1600	1000	800	1250	2500	1000	800	800	2000	4000	3200	3200	4000	3200
800	800	800	1000	1000	2000	1250	1000	1600	3200	1250	1000	1250	2500	4000	4000	5000	4000	4000
1000	1000	1000	1250	1250	1600	1250			1600	1250	1600				6300	5000		
1250	1250	1250	1600	1600	2000	1600			2000	1600	2000					6300		
1600	1600				2000					2500	2000	2500						
										3200	2500	3200						
										3200								
100	100	100	100	100	100	100	100	100	100	100	100	100	100	50	50	50	50	50
42	65	150	42	50	42	65	85	130	65	75	100	130	130	75	100	150	100	150
42	65	130	42	50	42	65	85	110	65	75	100	130	110	75	100	150	100	150
42	50	100	42	50	42	55	65	85	65	75	100	100	85	75	100	130	100	130
42	50	60	42	50	42	55	65	85	65	75	85 <sup>(2)</sup>	100	85	75	85 <sup>(2)</sup>	100	100	100
42	50	150	42	50	42	65	85	130	65	75	85	100	130	75	100	150	100	125
42	50	130	42	50	42	65	85	110	65	75	85	100	110	75	100	150	100	125
42	42	100	42	50	42	55	65	65	65	75	85	85	65	75	100	130	100	100
42	42	45	42	50	42	55	65	65	65	75	85	85	65	75	85	100	100	100
42	42	15	42	50	42	55	65	10	65	75	75	85	15	75	100	100	100	100
			36	36	42	42	50	-	65	65	65	65	-	75	75	75	85	85
88.2	143	330	88.2	105	88.2	143	187	286	143	165	220	286	286	165	220	330	220	330
88.2	143	286	88.2	105	88.2	143	187	242	143	165	220	286	242	165	220	330	220	330
88.2	121	220	88.2	105	88.2	121	143	187	143	165	187	220	187	165	220	286	220	286
88.2	121	132	88.2	105	88.2	121	143	187	143	165	187	220	187	165	187	220	220	220
B	B	A	B	B	B	B	B	A	B	B	B	B	A	B	B	B	B	B
■	■	■	■	■	■	■	■	■	■	■	■	■	■	■	■	■	■	■
■	■	■	■	■	■	■	■	■	■	■	■	■	■	■	■	■	■	■
80	80	80	80	80	80	80	80	80	80	80	80	80	80	80	80	80	80	80
70	70	70	70	70	70	70	70	70	70	70	70	70	70	70	70	70	70	70
30	30	12	30	30	30	30	30	12	30	30	30	30	12	30	30	30	30	30

E2 B-N-S				E2 L		E3 N-S-H-V				E3 L		E4 S-H-V		E6 H-V					
800	1000-1250	1600	2000	1250	1600	800	1000-1250	1600	2000	2500	3200	2000	2500	3200	4000	3200	4000	5000	6300
25	25	25	25	20	20	20	20	20	20	20	20	15	15	15	15	12	12	12	12
60	60	60	60	60	60	60	60	60	60	60	60	60	60	60	60	60	60	60	60
15	15	12	10	4	3	12	12	10	9	8	6	2	1.8	7	5	5	4	3	2
15	15	10	8	3	2	12	12	10	9	7	5	1.5	1.3	7	4	5	4	2	1.5
30	30	30	30	20	20	20	20	20	20	20	20	20	20	10	10	10	10	10	10

## 2 General characteristics

### SACE Emax air circuit-breakers with full-size neutral conductor

		<b>E4S/f</b>	<b>E4H/f</b>	<b>E6H/f</b>
<b>Rated uninterrupted current (at 40 °C) I<sub>u</sub></b>	[A]	<b>4000</b>	<b>3200</b>	<b>4000</b>
	[A]		<b>4000</b>	<b>5000</b>
				<b>6300</b>
Number of poles		4	4	4
Rated operational voltage <b>U<sub>e</sub></b>	[V ~]	690	690	690
<b>Rated ultimate short-circuit breaking capacity I<sub>cu</sub></b>				
220/230/380/400/415 V ~	[kA]	80	100	100
440 V ~	[kA]	80	100	100
500/525 V ~	[kA]	75	100	100
660/690 V ~	[kA]	75	100	100
<b>Rated service short-circuit breaking capacity I<sub>cs</sub></b>				
220/230/380/400/415 V ~	[kA]	80	100	100
440 V ~	[kA]	80	100	100
500/525 V ~	[kA]	75	100	100
660/690 V ~	[kA]	75	100	100
<b>Rated short-time withstand current I<sub>cw</sub></b>				
(1s)	[kA]	75	85	100
(3s)	[kA]	75	75	85
<b>Rated short-circuit making capacity I<sub>cm</sub></b>				
220/230/380/400/415 V ~	[kA]	176	220	220
440 V ~	[kA]	176	220	220
500/525 V ~	[kA]	165	220	220
660/690 V ~	[kA]	165	220	220
Utilization category (in accordance with IEC 60947-2)		B	B	B
Isolation behavior (in accordance with IEC 60947-2)		■	■	■
<b>Overall dimensions</b>				
Fixed: H = 418 mm - D = 302 mm L	[mm]	746	746	1034
Withdrawable: H = 461 - D = 396.5 mm L	[mm]	774	774	1062
<b>Weight (circuit-breaker complete with releases and CT, not including accessories)</b>				
Fixed	[kg]	120	120	165
Withdrawable (including fixed part)	[kg]	170	170	250

## 2 General characteristics

### 2.2 Characteristic curves and the software “Curves”

#### 2.2.1 Curves 1.0

The software “Curves”, which can be downloaded from our web site <http://bol.it.abb.com>, is a tool dedicated to who works in the electrical engineering field.

This program allows the visualization of :

- I-t LLL: tripping characteristics for three-phase faults;
- I-t LL: tripping characteristics for two-phase faults;
- I-t LN: tripping characteristics for single-phase faults;
- I-t LPE: tripping characteristics for phase-to-earth faults;
- I- $I^2$ t LLL: specific let-through energy for three-phase faults;
- I- $I^2$ t LL: specific let-through energy for two-phase faults;
- I- $I^2$ t LN: specific let-through energy for single-phase faults;
- I- $I^2$ t LPE: specific let-through energy for phase-to-earth faults;
- Peak: current limitation curve;
- Cable and fuse characteristic curves.

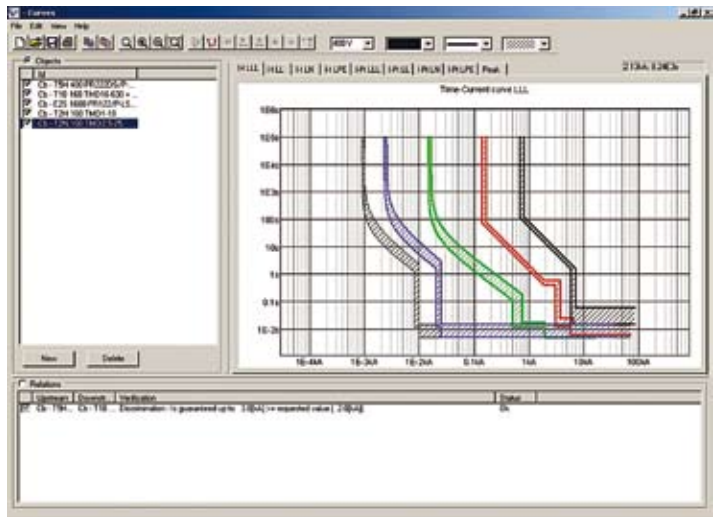

Besides, other program features are the verifications of cable protection, of human beings' protection and of discrimination. The algorithms for the verification of the cable protection are described in the international standards. The algorithms for the verification of discrimination are implemented in accordance with the guidelines provided in ABB SACE Technical Application Papers, specifically “QT1: Low voltage selectivity with ABB circuit-breakers” (QT1 from now on). The software “Curves” displays tripping and limiting characteristics according to the catalogues.

## 2 General characteristics

### 2.2.2 Trip curves of thermomagnetic and magnetic only releases

The overload protection function must not trip the circuit-breaker in 2 hours for current values which are lower than 1.05 times the set current, and must trip within 2 hours for current values which are lower than 1.3 times the set current.

By "cold trip conditions" it is meant that the overload occurs when the circuit-breaker has not reached the normal working temperature (no current flows through the circuit-breaker before the anomalous condition occurs); on the contrary "hot trip conditions" refers to the circuit-breaker having reached the normal working temperature with the rated current flowing through, before the overload current occurs. For this reason "cold trip conditions" times are always greater than "hot trip conditions" times.

The protection function against short-circuit is represented in the time-current curve by a vertical line, corresponding to the rated value of the trip threshold  $I_3$ . In accordance with the Standard IEC 60947-2, the real value of this threshold is within the range  $0.8 \cdot I_3$  and  $1.2 \cdot I_3$ . The trip time of this protection varies according to the electrical characteristics of the fault and the presence of other devices: it is not possible to represent the envelope of all the possible situations in a sufficiently clear way in this curve; therefore it is better to use a single straight line, parallel to the current axis.

All the information relevant to this trip area and useful for the sizing and coordination of the plant are represented in the limitation curve and in the curves for the specific let-through energy of the circuit-breaker under short-circuit conditions.

The following pages show some examples reporting the settings of thermomagnetic releases.

To simplify the reading of these examples, the tolerance of the protection functions has not been considered.

For a proper setting it is necessary to consider the tolerances referred to the type of thermomagnetic release used; for these information please refer to the technical catalogues.

## 2 General characteristics

The following figure shows the time-current tripping curve of a circuit-breaker equipped with thermomagnetic release:

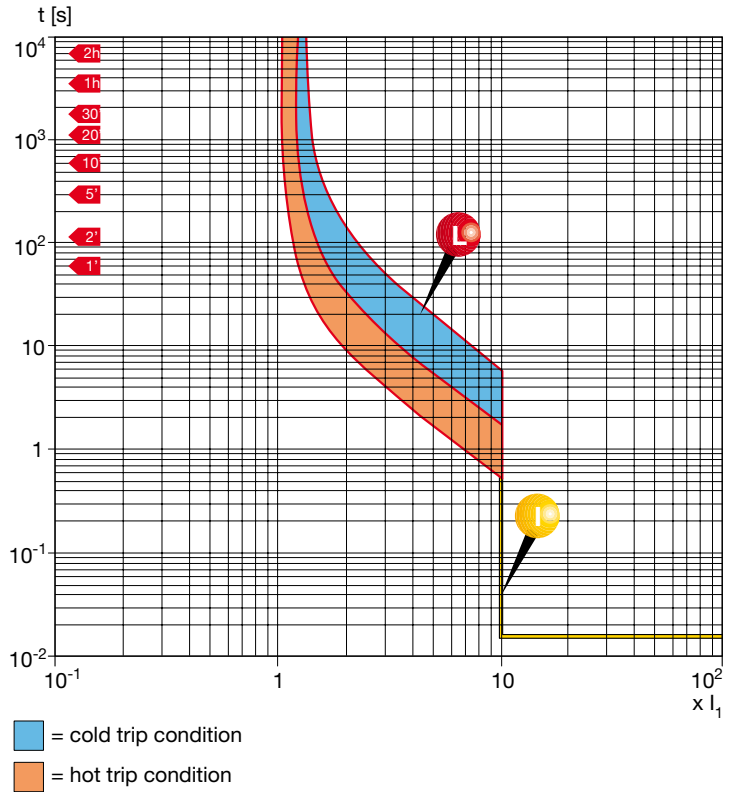

## 2 General characteristics

### Overload protection (L)

To set correctly the function L of the release is necessary to know the load current ( $I_b$ ) and divide it for the rated current of the thermomagnetic releases, taking the setting available higher or equal to the value obtained.

$$\text{Setting } L = \frac{I_b}{I_n}$$

Besides, in case of protection of a cable, it is necessary to comply with the following relation :

$I_b < I_1 < I_2$  where  $I_2$  is the conductor carrying capacity and  $I_1$  is the current set on the overload protection.

Example:

XT4N 250 TMA 200 with thermomagnetic release TMA. (with function L adjustable from 0.7 to 1 x  $I_n$ )

$I_b = 170\text{A}$

$$\text{Setting } L = \frac{I_b}{I_n} = \frac{170}{200} = 0.85$$

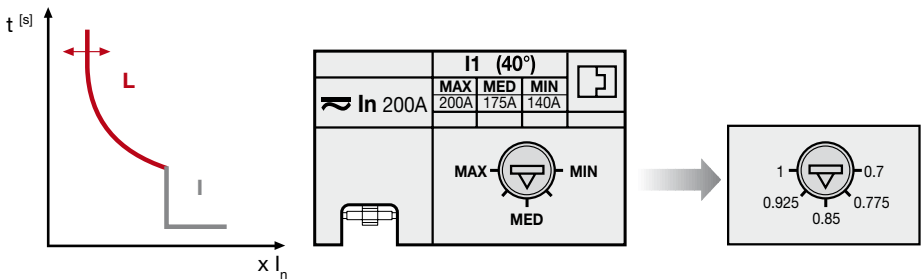



## 2 General characteristics

### Short-circuit instantaneous protection (I)

To set the magnetic function of the release is necessary to know the minimum value of the short-circuit current that we can have in the plant.

The I3 threshold shall comply with following condition:

$$I_3 \leq I_{kmin}$$

$$I_3 = \text{setting} \times I_n$$

To detect the setting it is necessary to divide the  $I_{kmin}$  by the rated current of the releases and take the setting value immediately lower.

$$\text{Setting}_I = \frac{I_{kmin}}{I_n}$$

Example:

XT4N 250 TMA 200 with thermomagnetic release TMA with instantaneous function adjustable from 5 (=1000A) to 10 (=2000A).

$I_{kmin} = 1800 \text{ A}$

$$\text{Setting}_I = \frac{I_{kmin}}{I_n} = \frac{1800}{200} = 9$$

It is possible to choose:  $\approx 8.75$  :

$$I_3 = 8.75 \times 200 = 1750 \leq 1800 \text{ A}$$

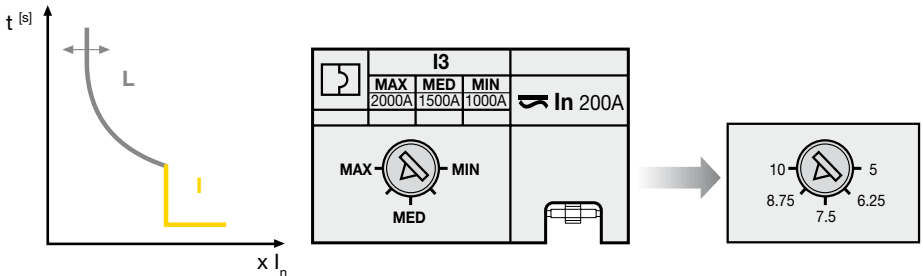

## 2 General characteristics

### Example of thermomagnetic release setting

Consider a circuit-breaker type XT2 160 In 160 and, using the trimmer for the thermal regulation, select the current threshold, for example at  $144 \text{ A}$ ; the magnetic trip threshold, fixed at  $10xI_n$ , is equal to  $1600 \text{ A}$ .

Note that, according to the conditions under which the overload occurs, that is either with the circuit-breaker at full working temperature or not, the trip of the thermal release varies considerably. For example, for an overload current of  $600 \text{ A}$ , the trip time is between  $6$  and  $30 \text{ s}$  for hot trip, and between  $30$  and  $100 \text{ s}$  for cold trip.

For fault current values higher than  $1600 \text{ A}$ , the circuit-breaker trips instantaneously through magnetic protection.

### XT2 160 - In 160 Time-current curves

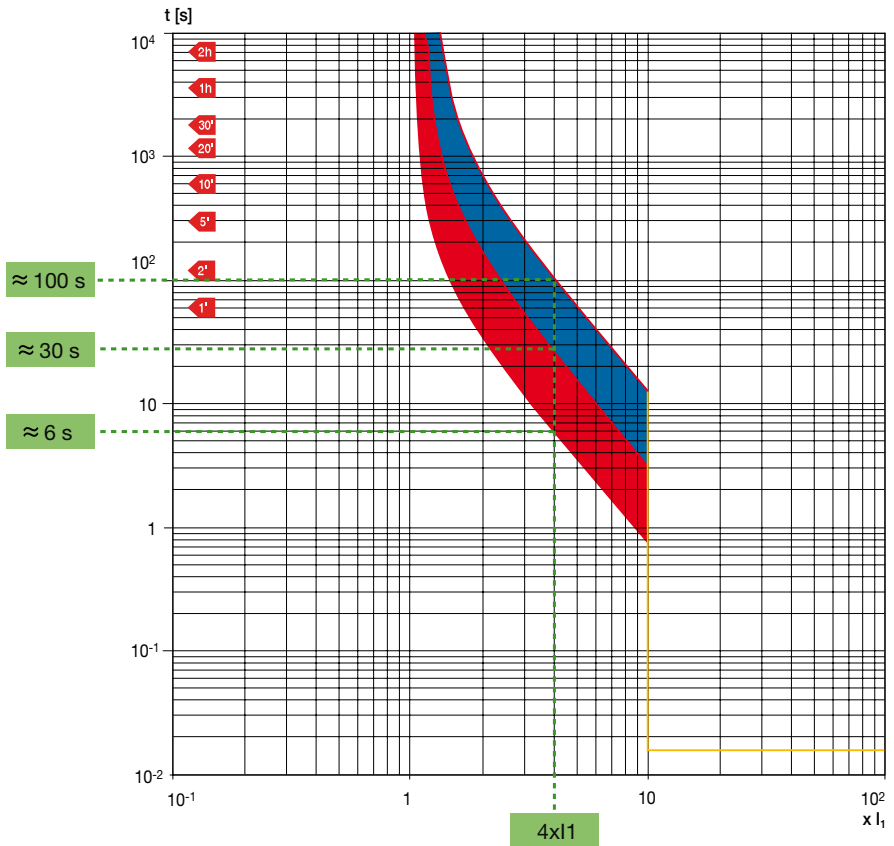

## 2 General characteristics

### 2.2.3 The functions of electronic releases

In the following pages the protection functions of the electronic releases for both moulded-case as well as air circuit breakers are reported; as regards the availability of the protection functions with the different releases, reference shall be made to the table on page 43.

The examples shown in these pages show how it is possible to set the electronic release by means of the dip-switch on the front of the circuit-breaker; this operation can be carried out also through the controls viewing the LED display (for the releases PR122-PR123-PR332-PR333) or electronically through the test unit PR 010T or with SD-TESTBUS 2.

To simplify the reading of the examples, the tolerance of the protection functions has not been considered. For a correct setting it is necessary to take into consideration the tolerances relevant to the different protection functions referred to the electronic trip unit used; for this information please consult the technical catalogue.

The figure below shows the time-current tripping curve of a circuit-breaker equipped with an electronic release having the protection functions LSIG which are described in the following pages:

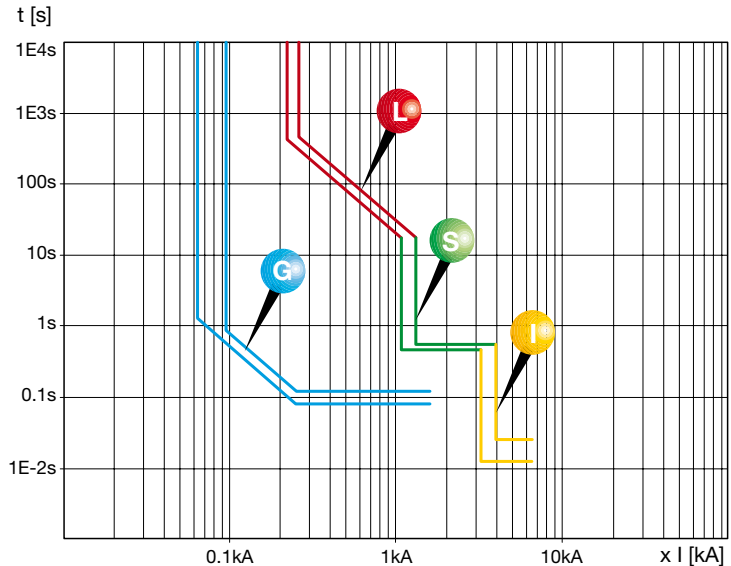

## 2 General characteristics

### Overload protection (L function)

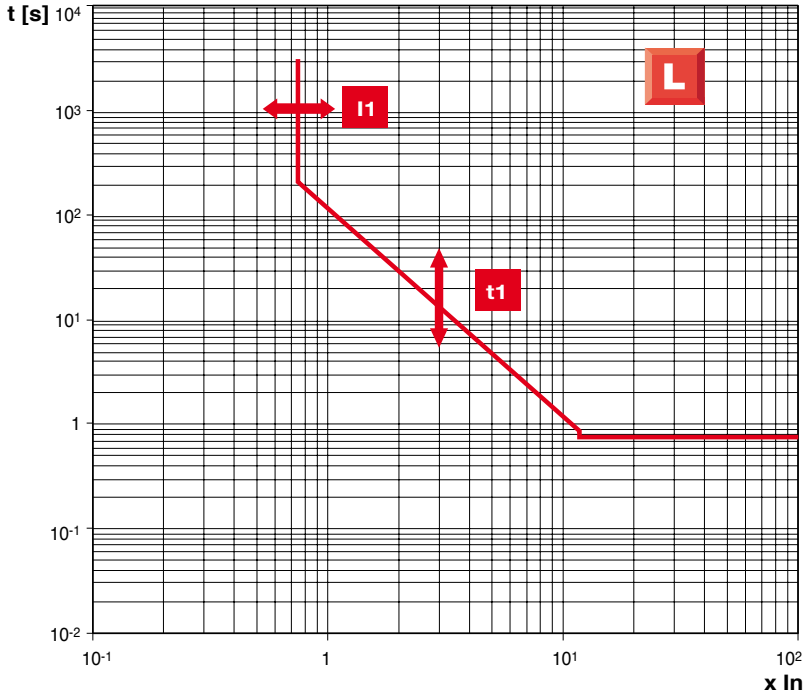

The application field of this protection function refers to all the installations which can be subject to overloads - usually of low value but of long duration - which are dangerous for the life of apparatus and cables.

These currents usually occur in a sound circuit, where the line results to be overloaded (this event is more likely than a real fault).

The trip curve of this protection (which cannot be excluded) is defined by a current threshold  $I_1$  and by a trip time  $t_1$ . More exactly :

- $I_1$  represents the current value beyond which the protection function commands the opening of the circuit-breaker according to an inverse time trip characteristic, where the time-current connection is given by the relation  $I^2t = \text{constant}$  (constant specific let-through energy);
- $t_1$  represents the trip time of the protection, in seconds, corresponding to a well defined multiple of  $I_1$  and it is used to identify a defined curve among those made available by the trip unit.

As regards the settings available please consult the technical catalogues.

## 2 General characteristics

To set properly L threshold, it is necessary to know the current required by the load ( $I_b$ ), divide it by the  $I_n$  of the trip unit and take the setting immediately higher than or equal to the value obtained :

$$\text{Setting } L = \frac{I_b}{I_n}$$

Besides, in case of cable protection, the following relation shall be observed  $I_b < I_1 < I_z$  where  $I_z$  is the conductor carrying capacity and  $I_1$  is the current value set for the overload protection.

Example :

XT2N 160, trip unit type Ekip LSI  $I_n=100$ , function L ( $I_1=0.4$  at  $1 \times I_n$  with step 0.02) through manual setting.

$I_b= 85A$

$$\text{Setting } L = \frac{I_b}{I_n} = \frac{85}{100} = 0.85$$

$I_1=0.86$  is chosen.

Through the manual setting, the dip-switches shall be positioned so that a coefficient equal to 0.86 is obtained; this coefficient multiplied by the rated current of the trip unit gives the required current value. The figure below shows the correct combination of dip-switches to obtain the required multiplying factor:

$$I_1 = 100 \times (0.4 + 0.02 + 0.04 + 0.08 + 0.32) = 86A$$

The trip time of L function for an overload current varies according to the type of curve used.

As regards the release considered in the example, the available curves are 4 and each of them is characterized by the passage by a characteristic multiple ( $3 \times I_1$ ) to which a different trip time ( $t_1=3s, 12s, 36s, 60s$ ) corresponds; since these are curves with  $I^2 t = \text{const}$ , it is possible to identify multiples different from  $3 \times I_1$  after the setting of  $t_1$ .

Being a curve with  $I^2 t = \text{const}$ , the condition

$$(3 \times I_1)^2 \times t_1 = \text{const} = I^2 t$$

must be always verified.

(\*) 0.4 is the fixed value, which cannot be excluded

## 2 General characteristics

where the expression  $I^2t$  represents the product of a generic fault current to the square and the time necessary to the protection to extinguish it.

Assuming an overload current of 300A ( $I_{ol}$ ) and having set  $t_1$  at 3s, the following results :

$$(3 \times I_{ol})^2 \times t_1 = I_{ol}^2 \times t \rightarrow t = \frac{(3 \times 86)^2 \times 3}{(300)^2} = 2.21s$$

At the same overload level ( $I_{ol}$ )=300A, if  $t_1$  had been set at 36s, the trip time would have been :

$$(3 \times I_{ol})^2 \times t_1 = I_{ol}^2 \times t \rightarrow t = \frac{(3 \times 86)^2 \times 36}{(300)^2} = 26.62s$$

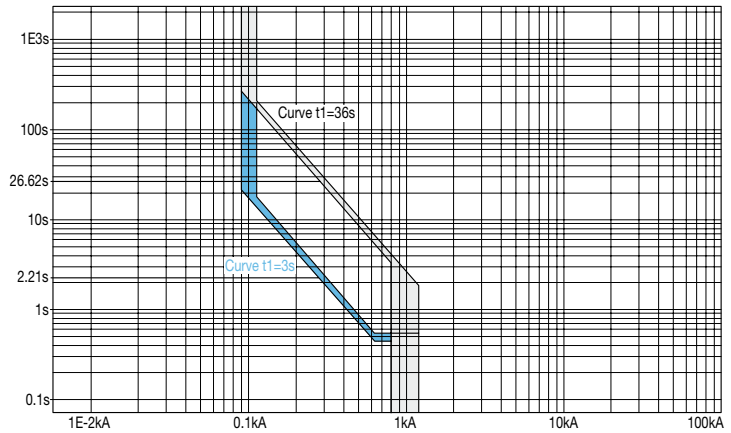

The time  $t_1$  shall be chosen keeping into consideration any co-ordination with cables or other devices either on the supply or the load side of the circuit-breaker under consideration.

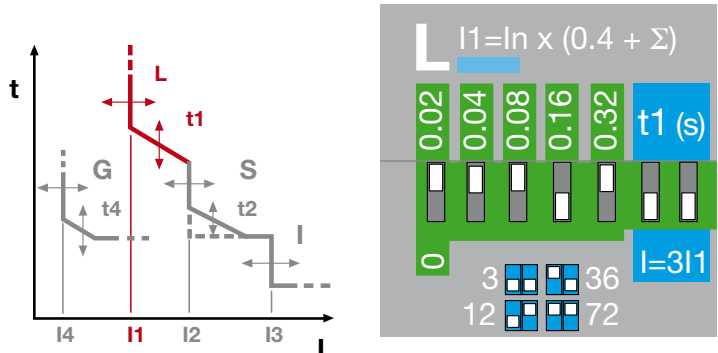

## 2 General characteristics

### Short-circuit protection with time delay (function S)

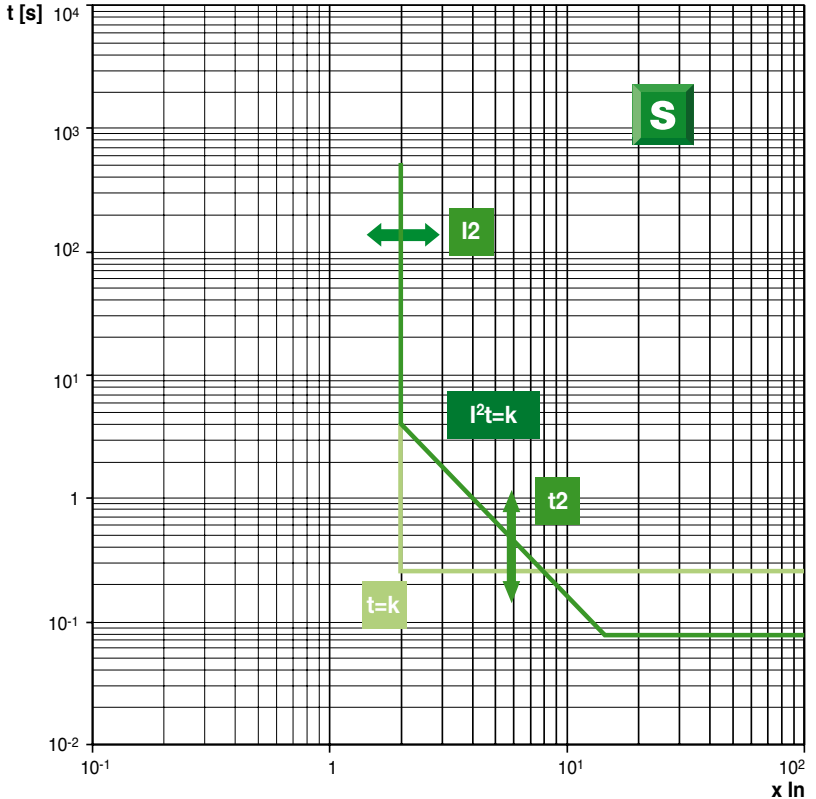

This protection function is used to introduce a trip time-delay in case of short-circuit. S function is necessary when time-current discrimination is required so that the tripping is delayed more and more by approaching the supply sources.

The trip curve of this protection (which can be excluded) is defined by a current threshold  $I_2$  and by a trip time  $t_2$ . In details :

- $I_2$  represents the current value beyond which the protection function commands the opening of the circuit-breaker, according to one of the following tripping characteristics:
  - with inverse time delay, where the link time-current is given by the relation  $I^2t = k$  (constant let-through energy)
  - with definite time, where the trip time is given by the relation  $t=k$  (constant time); in this case the tripping time is equal for any value of current higher than  $I_2$ ;
- $t_2$  represents the trip time of the protection, in seconds, in correspondence with:
  - a well defined multiple of  $\ln$  for the tripping curve at  $I^2t = k$ ;
  - $I_2$  for the tripping curve at  $t = k$ .

As regards the availability of the settings with the different trip units, please refer to the technical catalogues.

## 2 General characteristics

In order to adjust properly the function S of a circuit-breaker equipped with an electronic trip unit it is necessary to divide the  $I_{kmin}$  value (the lowest short-circuit current among all the available ones) by the  $I_n$  value of the trip unit and then to take the setting value immediately lower.

$$\text{Setting}_s = \frac{I_{kmin}}{I_n}$$

Example :

XT4N 250 with trip unit Ekip LSIG  $I_n$  250

function S ( $I_2=1-1.5-2-2.5-3-3.5-4.5-5.5-6.5-7-7.5-8-8.5-9-10 \times I_n$ )

$I_{kmin}=900A$

$$\text{Setting}_s = \frac{I_{kmin}}{I_n} = \frac{2000}{250} = 8$$

then, the value 7.5 is to be chosen.

As in the previous example, the figure shows the correct positioning of the dip switches so that the required multiplying factor can be obtained:

$$I_2 = 250 \times (2+5.5) = 1875 A < 2000 A$$

The time delay  $t_2$  of function S changes according to the selected characteristic: either  $t=constant$  or  $I^2t=constant$ .

By selecting  $t_2=const$ , in case of short-circuit, all the overcurrents higher or equal to  $I_2$  (in this case 1875 A) shall be extinguished within the set time  $t_2$ ;

instead, by selecting the characteristic curve with  $I^2t=const$ , the same considerations made for the determination of the trip time  $t_1$  are valid, taking into account the proper thresholds  $I_2$ .

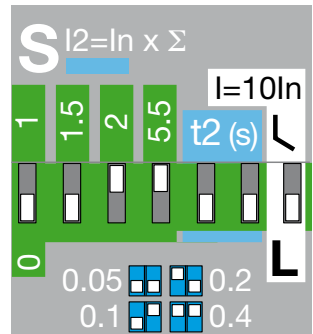
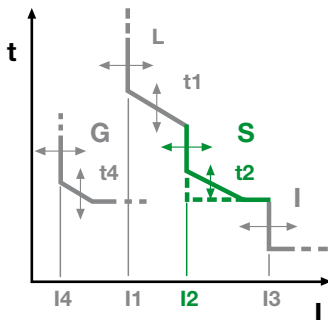



## 2 General characteristics

### Short-circuit instantaneous protection (I function)

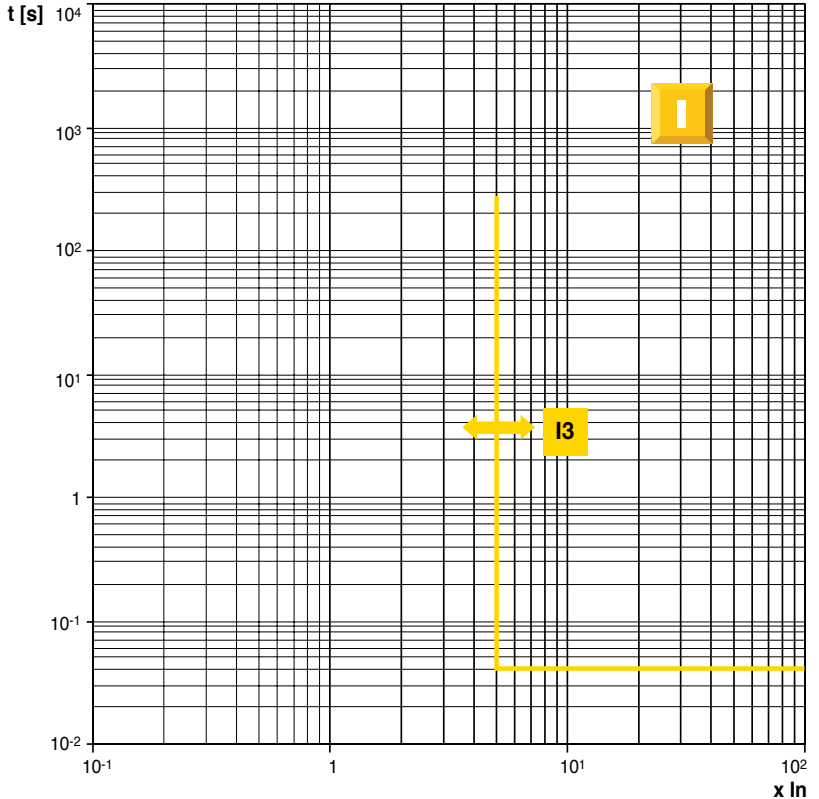

This function allows to have instantaneous protection in case of short-circuit. This protection is active for fault currents exceeding the set threshold  $I_3$ ; the trip time (instantaneous) cannot be set.

Function I can be excluded; the term "excludible" means that the trip threshold of the current is increased in comparison with the maximum threshold which can be adjusted through standard settings.

In order to set properly the threshold I, it is necessary to know the lowest short-circuit current of those which can occur at the installation point.

The threshold  $I_3$  shall comply with the following relation:

$$I_3 \leq I_{\min}$$

$$I_3 = \text{setting} \cdot x I_n$$

As regards the availability of the settings with the different trip units, please refer to the technical catalogues.

## 2 General characteristics

To determine the value to be set, the  $I_{kmin}$  value shall be divided by the  $I_n$  value and the setting value immediately lower shall be taken:

$$\text{Setting } I = \frac{I_{kmin}}{I_n}$$

Example:

XT4N 160 with trip unit Ekip LSIG In100

function I ( $I_3=1-1.5-2-2.5-3-3.5-4.5-5.5-6.5-7-7.5-8-8.5-9-10 \times I_n$ )

$I_{kmin}=900 \text{ A}$

$$\text{Setting } I = \frac{I_{kmin}}{I_n} = \frac{900}{100} = 9$$

8.5 is to be chosen.

As in the previous example, the figure shows the correct positioning of the dip switches so that the required multiplying factor can be obtained:

$$I_3 = 100 \times (1+2+5.5) = 850 \text{ A} < 900$$

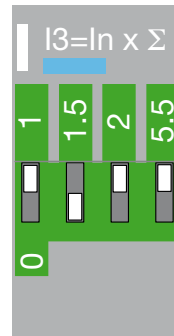
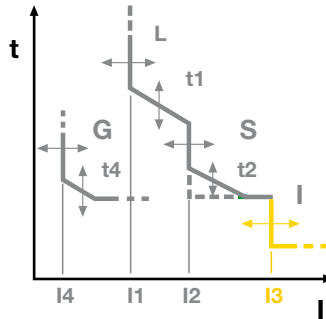

## 2 General characteristics

Earth fault protection (function G)

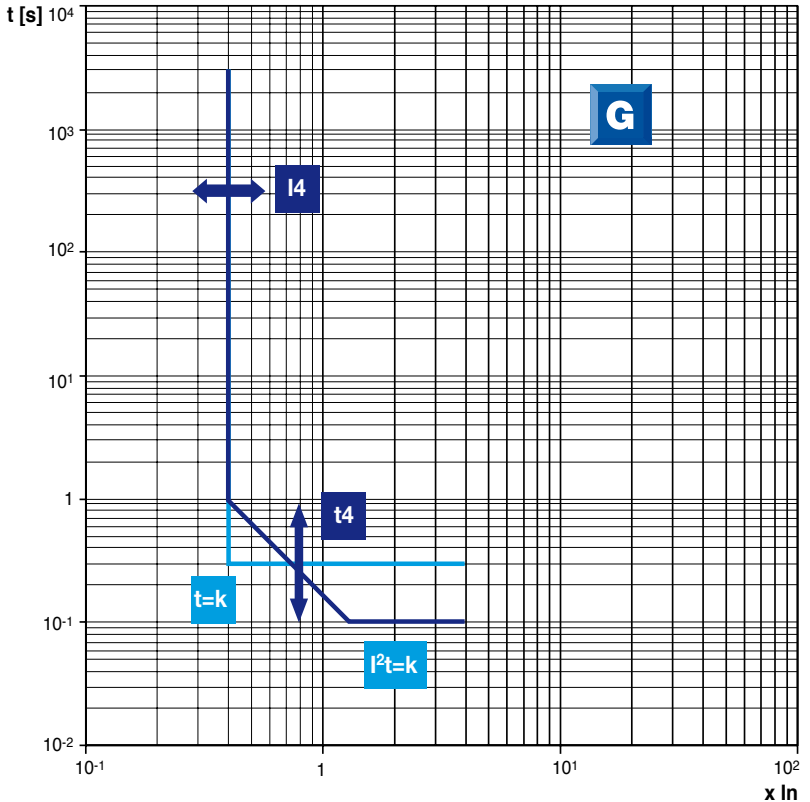

Protection G can assess the vectorial sum of the currents flowing through the live conductors (the three phases and the neutral).

In a sound circuit, this sum is equal to zero, but in the presence of an earth fault, a part of the fault current returns to the source through the protective conductor and/or the earth, without affecting the live conductors. The trip curve of this protection (which can be excluded) is defined by a current threshold  $I_4$  and by a trip time  $t_4$ . More precisely:

- $I_4$  represents the current value beyond which the protection function commands the opening of the circuit-breaker, according to one of the following tripping characteristics:
  - with inverse time delay, where the link time-current is given by the relation  $I^2t = k$  (constant let-through energy)
  - with definite time, where the trip time is given by the relation  $t=k$  (constant time); in this case the tripping time is equal for any value of current higher than  $I_4$ ;
- $t_4$  represents the trip time of the protection, in seconds, in correspondence with:
  - a well defined multiple of  $I_n$  for the tripping curve at  $I^2t = k$ ;
  - $I_4$  for the tripping curve at  $t = k$ .

As regards the availability of the settings with the different trip units, please refer to the technical catalogues.

## 2 General characteristics

In order to set properly the current  $I_d$  and the time  $t_d$  of the function G, it is necessary to comply with the requirements reported in the installation Standard (see Chapter 4 of Part 2 - "Protection of human beings").

Example:

XT4N 250 with trip unit Ekip LSIG In 250

function G ( $I_d=0.2-0.25-0.45-0.55-0.75-0.8-1 \times I_n$ )

$I_{k_{PE}}=120 \text{ A}$

distribution system: TN-S.

In TN systems, a bolted fault to ground on the LV side usually generates a current with a value analogous to that of a short-circuit and the fault current flowing through the phase and/or the protection conductor (or the conductors) does not affect the earthing system at all.

The relation concerning TN-S distribution systems  $Z_s \times I_a \leq U_o$  can be expressed as follows:

$$I_a \leq \frac{U_o}{Z_s} = I_{k_{LPE}}$$

where:

- $U_o$  is the voltage phase-to-PE;
- $Z_s$  is the fault ring impedance;
- $I_a$  is the trip current within the time delay established by the Standard (see Chapter 4 of Part 2 - "Protection of human beings").
- $I_{k_{LPE}}$  is the fault current phase-to-PE

Therefore, it is possible to affirm that the protection against indirect contacts is verified if the trip current  $I_a$  is lower than the fault current phase-PE ( $I_{k_{PE}}$ ) which is present in correspondence with the exposed conductive part to be protected. Then:

$$\text{Setting } G = \frac{I_{k_{PE}}}{I_n} = \frac{120}{250} = 0.48$$

the setting 0.45 is selected.

## 2 General characteristics

As in the previous example, the figure shows the correct positioning of the dip switches so that the required multiplying factor can be obtained:

$$I_4 = 250 \times (0.2 + 0.25) = 112,5 \text{ A} < 120 \text{ A}$$

The trip time  $t_4$  shall be chosen according to the provisions of the installation standards; with the trip unit under consideration, the available curves which define  $t_4$  are with  $I^2t$  constant; therefore, in order to define the trip time it is necessary to apply the same considerations made for the determination of the trip time  $t_1$ , but taking into account the proper thresholds  $I_4$  and the relevant characteristic curves ( $t_4$ ).

Assuming to use a release with trip time  $t_4 = \text{constant}$ , when the set threshold  $I_4$  is reached and exceeded, the circuit-breaker shall trip within the set time  $t_4$ .

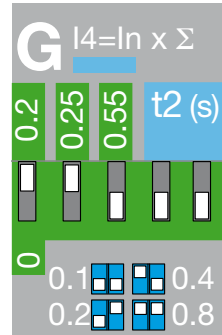
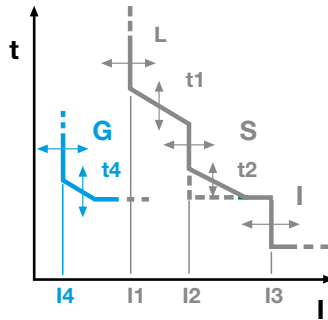

## 2 General characteristics

*Protection against directional short-circuit with adjustable time-delay (function D)*

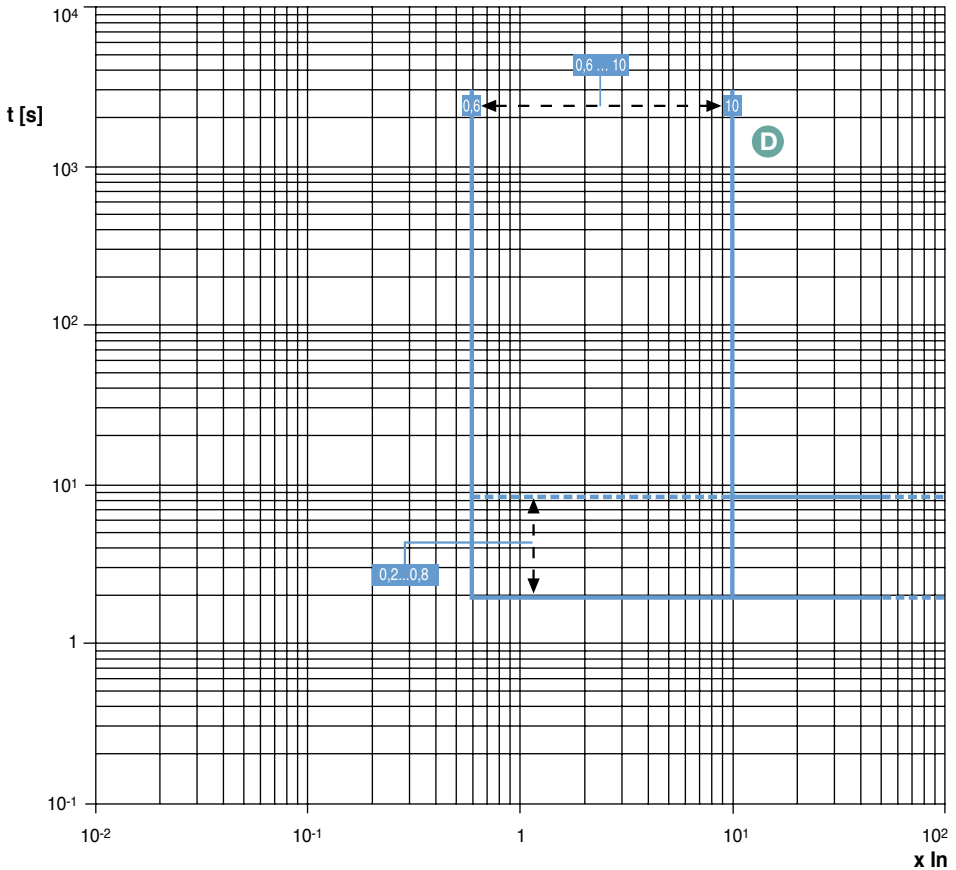

This protection is very similar to function S with definite time. It allows to identify, besides the intensity, also the direction of the fault current and consequently to understand whether the fault is either on the supply or on the load side of the circuit-breaker, thus excluding only the part of the installation affected by the fault. Its use is particularly suitable in the ring distribution systems and in the installations with more supply lines in parallel.

The adjustable current thresholds are in a range from 0.6 to  $10xI_n$  and the trip times can be set within a range from 0.2 to 0.8 seconds.

Function D can be excluded.

## 2 General characteristics

### Protection against unbalanced phase (function U)

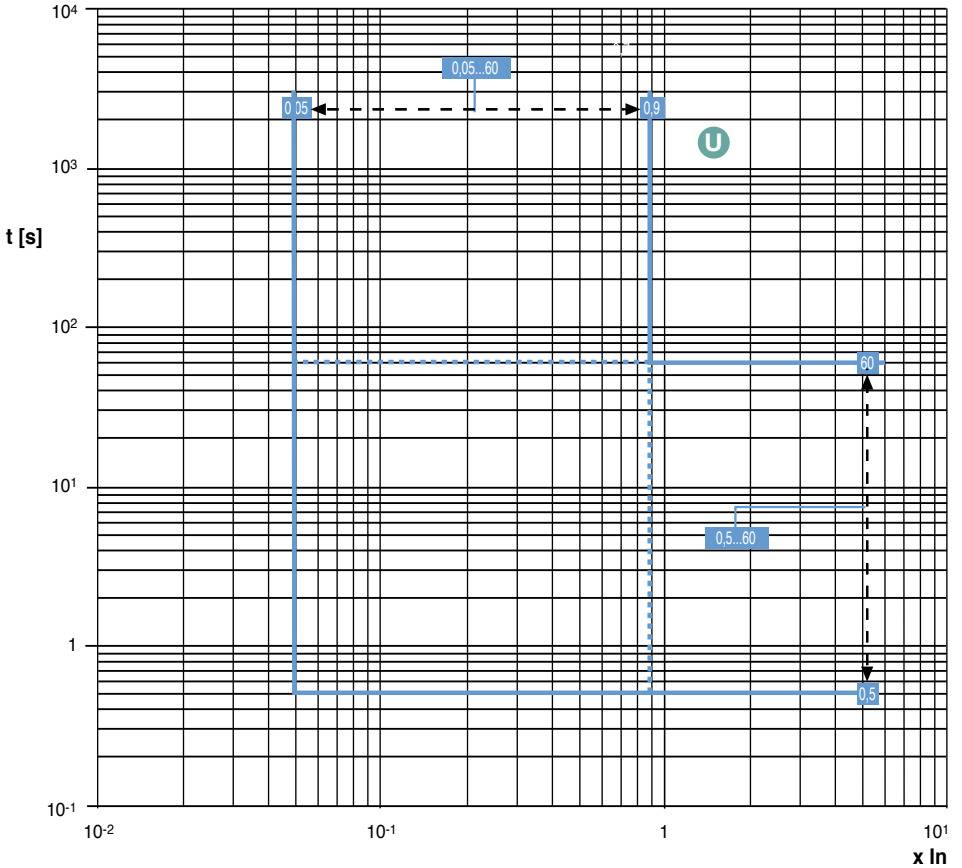

This protection makes the circuit-breaker open when an unbalanced phase current exceeding the set threshold is detected.

The possible settings are 5% to 90% of the rated current, and the trip times can be set in the range from 0.5 to 60 s.

The protection function U is used above all in the installations with the presence of rotary machines, where an unbalanced phase might cause unwanted effects on the same machines. Function U can be excluded.

## 2 General characteristics

### Protection against undervoltage (function UV)

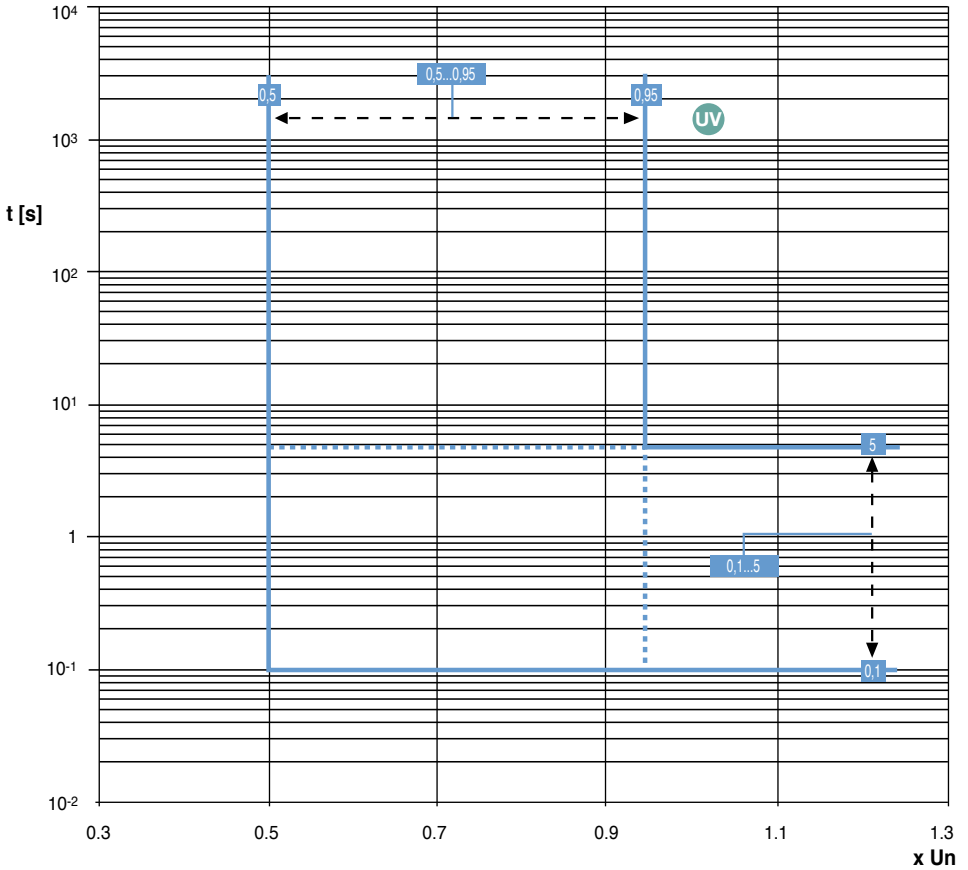

This protection trips after the adjusted time ( $t_8$ ) has elapsed when the phase voltage decreases below the set threshold  $U_8$ .

The voltage threshold can be set in the range from 0.5 to  $0.95 \times U_n$  and the time threshold from 0.1 to 5 s.

Function UV can be excluded.



## 2 General characteristics

### Protection against overvoltage (function OV)

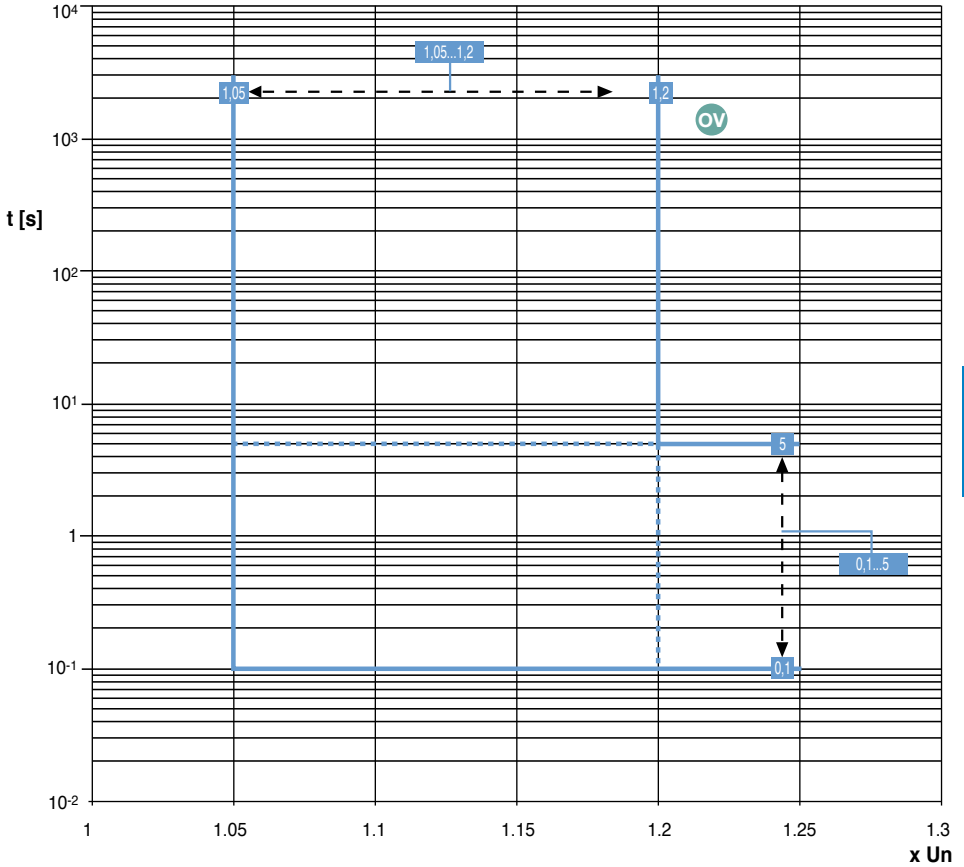

This protection trips after the set time ( $t_9$ ) has elapsed, when the phase voltage exceeds the set threshold  $U_9$ .

The voltage threshold can be set in the range from 1.05 to 1.2 $\times U_n$  and the time threshold from 0.1 to 5 s.

Function OV can be excluded.

## 2 General characteristics

### Protection against residual voltage (function RV)

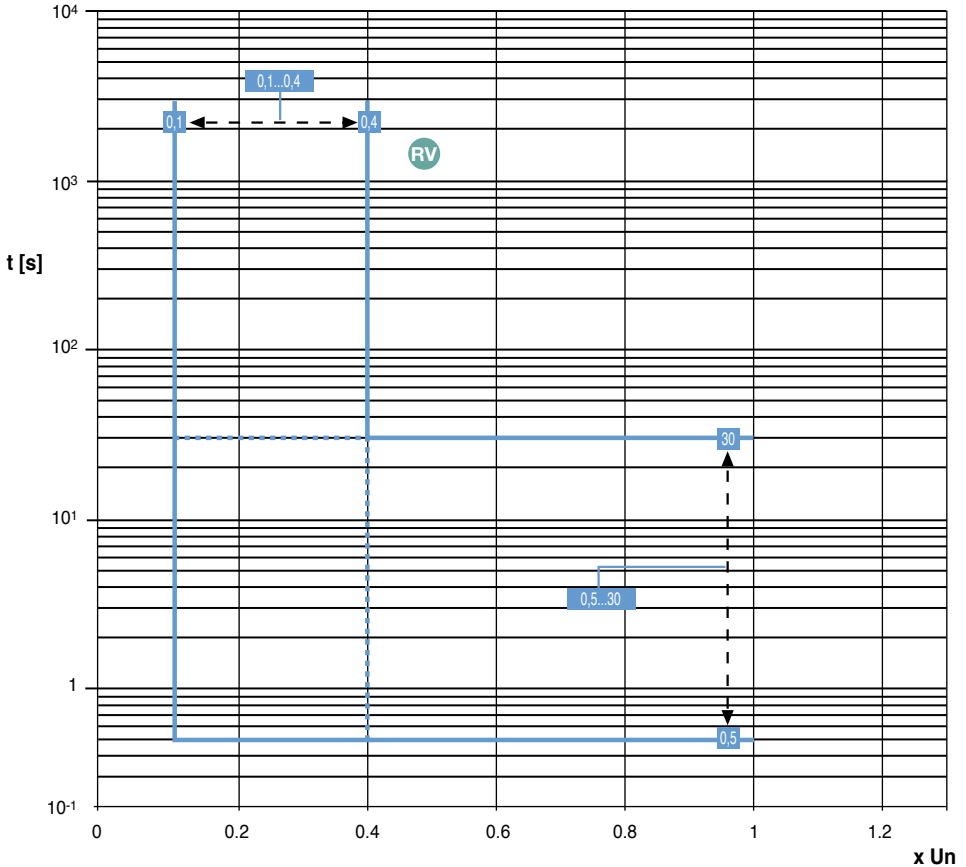

The protection against residual voltage allows to detect the faults which cause the movements of the star centre in case of system with isolated neutral.

This protection trips after the set time when the residual voltage exceeds the threshold  $U_{10}$ .

This threshold can be set in a range from 0.1 to  $0.4xU_n$  and the time threshold from 0.5s to 30s.

Function RV can be excluded.

## 2 General characteristics

### Protection against reversal of power (function RP)

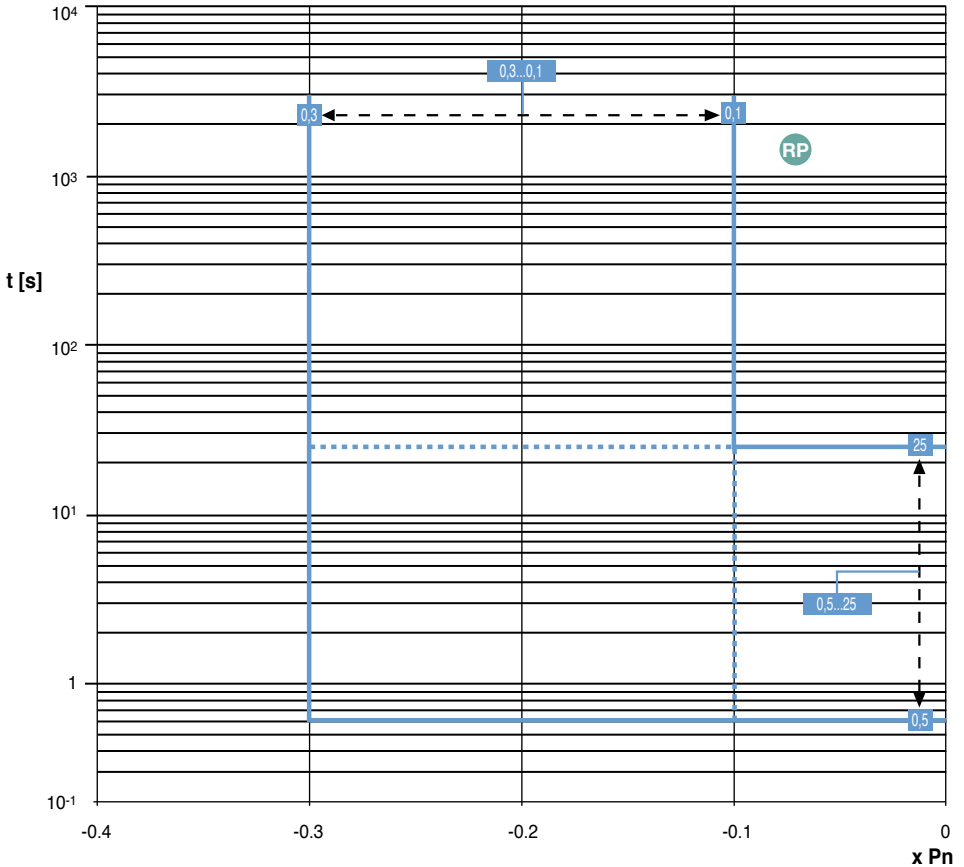

The protection against reversal of power is particularly suitable for protection of large rotary machines (e.g. motors).

Under certain conditions a motor may generate power instead of absorbing it. When the total reverse active power (sum of the power of the three phases) exceeds the set power threshold  $P_{11}$ , the protection function trips after the set time-delay  $t_{11}$  causing the circuit-breaker opening

## 2 General characteristics

### *Protection against minimum frequency (function UF)*

This protection intervenes by generating an alarm or making the circuit-breaker open after the adjusted time-delay ( $t_9$ ) when the frequency varies below the set threshold  $f_{12}$ .

It is used above all for installations supplied by generators and co-generation plants.

### *Protection against maximum frequency (function OF)*

This protection intervenes by generating an alarm or making the circuit-breaker open after the adjusted time-delay ( $t_{10}$ ) when the frequency exceeds the set threshold  $f_{13}$ .

It is used above all for installations supplied by generators and co-generation plants.

### *Protection against overtemperature (function OT)*

This protection allows signaling of the presence of anomalous temperatures which might cause malfunctioning of the electronic components of the trip unit.

If the temperature reaches the first threshold, ( $70^{\circ}\text{C}$ ), the trip unit shall advise the operator through the lightening up of the "warning" led; should the temperature reach the second threshold ( $85^{\circ}\text{C}$ ), besides the lightening up of the "warning" and "alarm" leds, the circuit-breaker would be tripped (by enabling the proper parameter).

### *Overload protection with curves according to IEC60255-3*

This protection function against overload finds its application in the co-ordination with MV releases and fuses.

In fact it is possible to obtain a co-ordination among the tripping curves of the circuit-breakers by getting nearer to the slopes of the tripping curves of MV releases or fuses, so that time-current selectivity between LV and MV is obtained. Besides being defined by a current threshold  $I_1$  and by a trip time  $t_1$ , the curves according to Std. IEC 60255 are defined by the parameters "K" and "a" which determine their slope.

The parameters are the following:

Parameters	Curve typology		
	A	B	C
<b>K</b>	0.14	13.5	80.0
<b>a</b>	0.02	1.0	2.0

The curve L complying with Std. IEC 60255-3 is available both for the electronic trip units type PR332-PR333 for T7 and X1 series circuit-breakers, as well as for the electronic trip units type PR122-PR123 for Emax series circuit-breakers.

## 2 General characteristics

### Curve A

$k=0.14$   $\alpha=0.02$

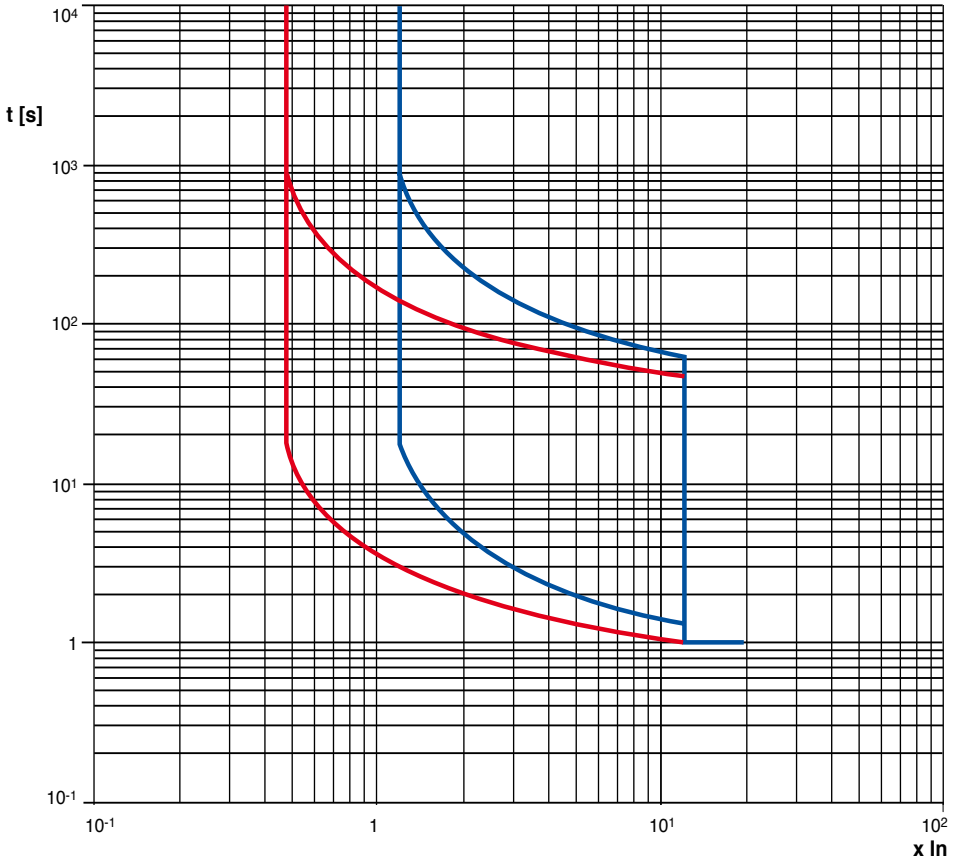

## 2 General characteristics

### Curve B

$k=13.5$   $\alpha=1$

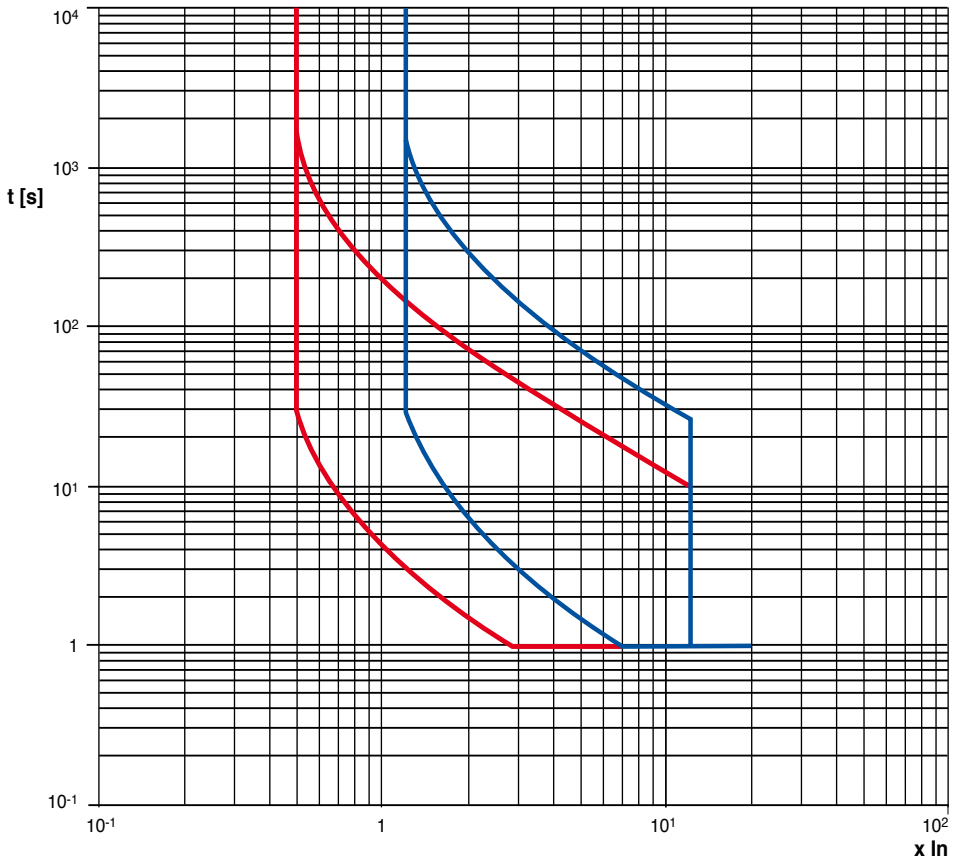

## 2 General characteristics

### Curve C

$k=80$   $\alpha=2$

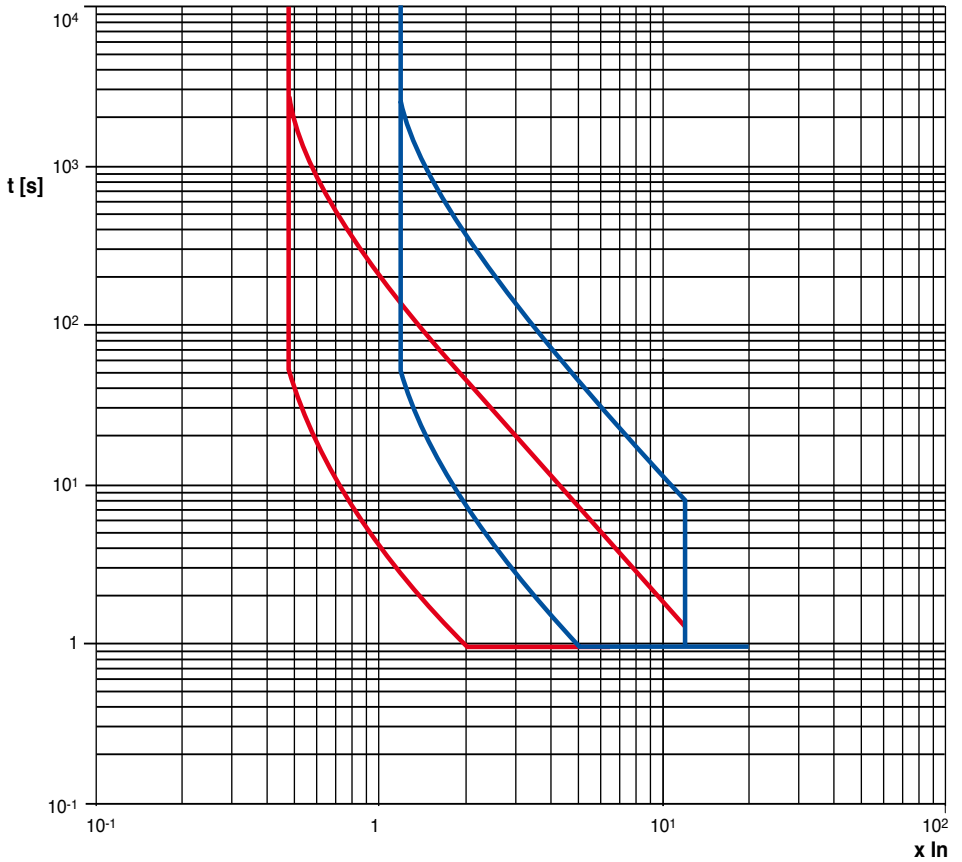

## 2 General characteristics

### Motor protection

*L*: motor protection function against overload according to the indications and classes defined by the Std. IEC 60947-4-1

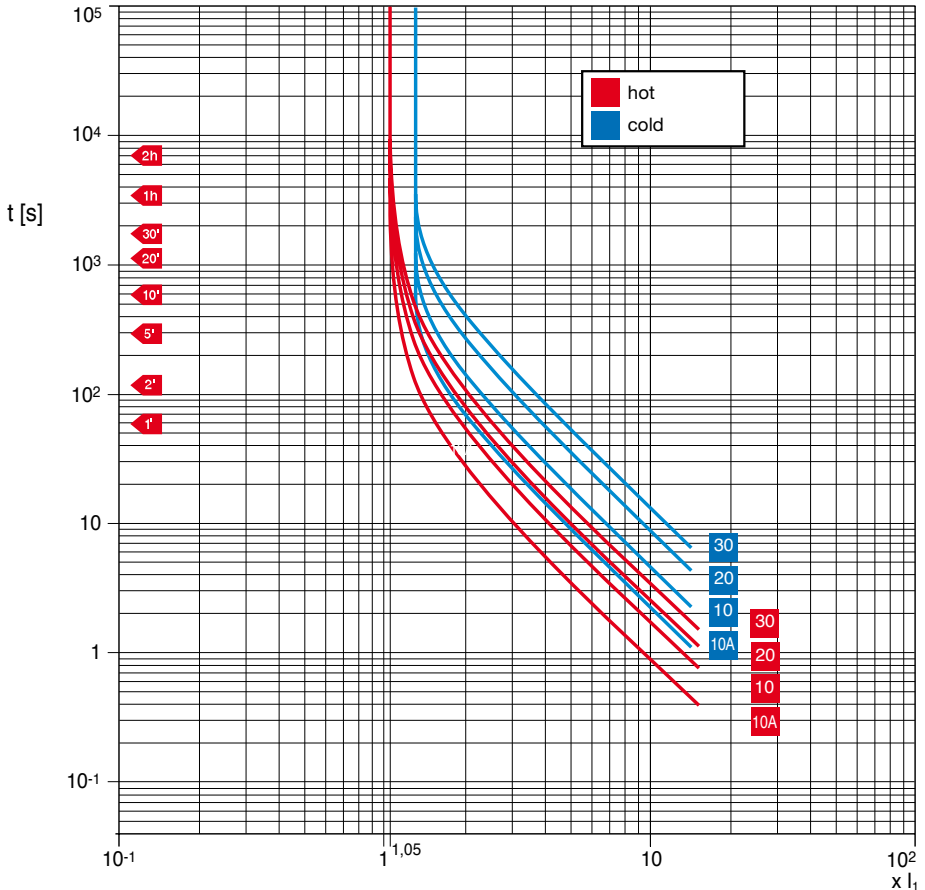

Function L implemented on MP and Ekip M trip units protects the motor against overloads, according to the indications and the classes defined by the Std. IEC 60947-4-1. The protection is based on a pre-defined thermal model, which by simulating the copper and iron overtemperatures inside motors, allows to safeguard properly the motor itself. The trip time-delay is set by selecting the trip class defined in the above mentioned Standard.

The function is temperature-compensated and sensitive to the lack of phase. Function L, which cannot be excluded, can be set manually from a minimum of 0.4 to a maximum of  $1 \times I_n$ . Besides, it is necessary to select the starting class of the motor, which determines the trip time with a current equal to  $7.2 \times I_n$  in compliance with the prescriptions of item 4.7.3 of the Std. IEC 60947-4-1 4.7.3. For further details see Chapter 2.3 of Part 2.



## 2 General characteristics

### Motor protection

*I: protection against short-circuit with instantaneous trip*

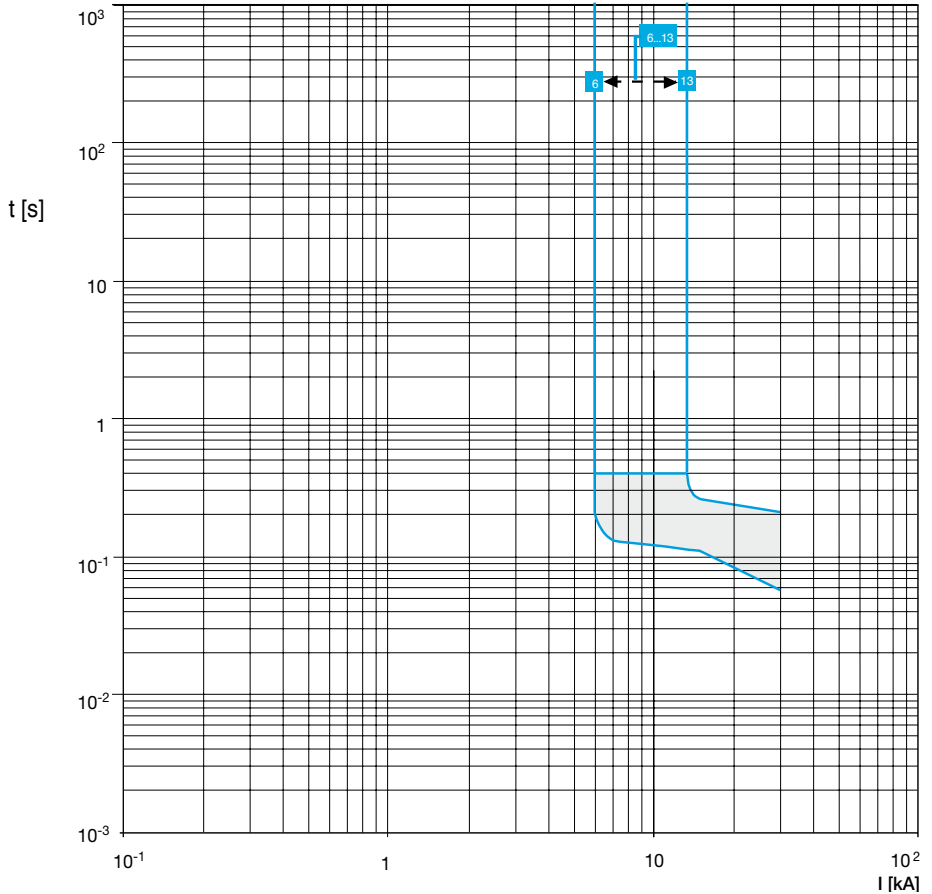

This protection function trips in case of phase-to-phase short-circuit. It is enough that one phase only exceeds the set threshold to cause the instantaneous opening of the circuit-breaker.

The trip current can be set up to 13 times the rated current of the trip unit.

## 2 General characteristics

### Motor protection

R: Protection against rotor block

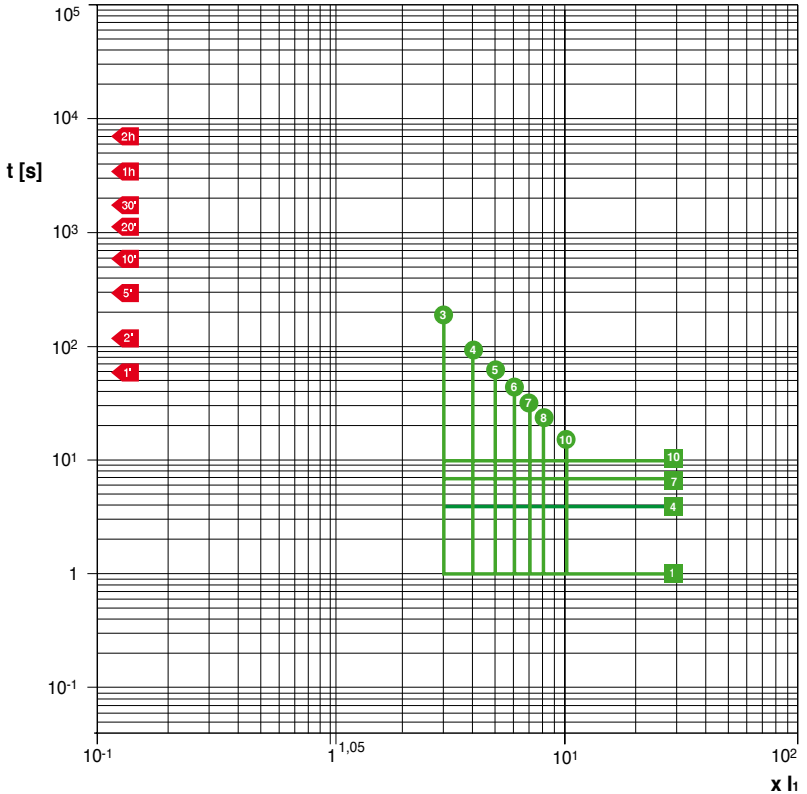

Function R protects the motor against possible rotor block during operation. Protection R has the characteristics of protecting the motor in two different ways, according to whether the fault is present at start-up or whether it occurs during normal service of an already active plant.

In the former case, protection R is linked to protection L for time selection as well: in the presence of a fault during the start-up, protection R is inhibited for a time equal to the time set according to the trip class. Once this time has been exceeded, protection R becomes active causing a trip after the set time  $t_5$ . In the latter case, protection R is already active and the protection tripping time shall be equal to the set value  $t_5$ . This protection intervenes when at least one of the phase current exceeds the established value and remains over that threshold for the fixed time  $t_5$ .

## 2 General characteristics

### Motor protection

*U: Protection against phase unbalance*

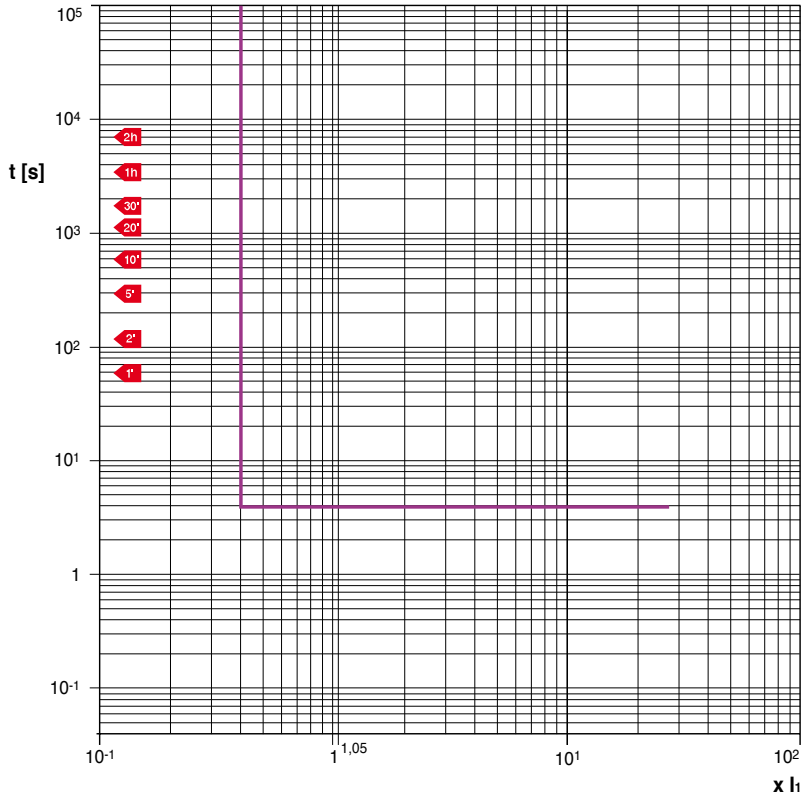

Function U can be used in those cases where a particularly accurate control is needed as regards phase lack/unbalance. This protection intervenes if the r.m.s. value of one or two currents drop below the level equal to 0.4 times the current  $I_1$  set for protection L and remain below it for longer than 4 seconds. This protection can be excluded.

## 2 General characteristics

### 2.3 Limitation curves

A circuit-breaker in which the opening of the contacts occurs after the passage of the peak of the short-circuit current, or in which the trip occurs with the natural passage to zero, allows the system components to be subjected to high stresses, of both thermal and dynamic type. To reduce these stresses, current-limiting circuit-breakers have been designed (see Chapter 1.2 “Main definitions”), which are able to start the opening operation before the short-circuit current has reached its first peak, and to quickly extinguish the arc between the contacts; the following diagram shows the shape of the waves of both the prospective short-circuit current as well as of the limited short-circuit current.

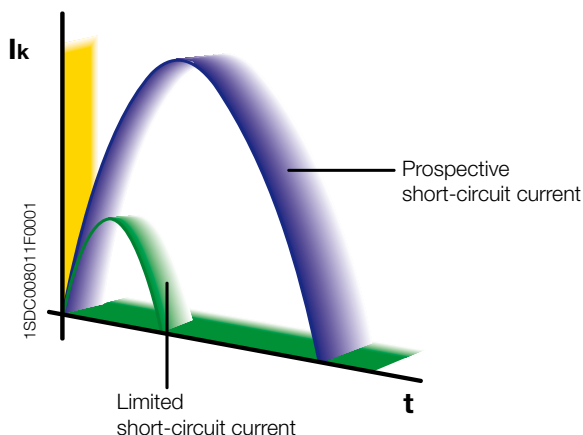

The following diagram shows the limit curve for Tmax XT2L160, In160 circuit-breaker. The x-axis shows the effective values of the symmetrical prospective short-circuit current, while the y-axis shows the relative peak value. The limiting effect can be evaluated by comparing, at equal values of symmetrical fault current, the peak value corresponding to the prospective short-circuit current (curve A) with the limited peak value (curve B).

## 2 General characteristics

Circuit-breaker XT2L160 with thermomagnetic release In 20 at 400 V, for a fault current of 90 kA, limits the short-circuit peak to 14.6 kA only, with a remarkable reduction compared with the peak value in the absence of limitation (198 kA).

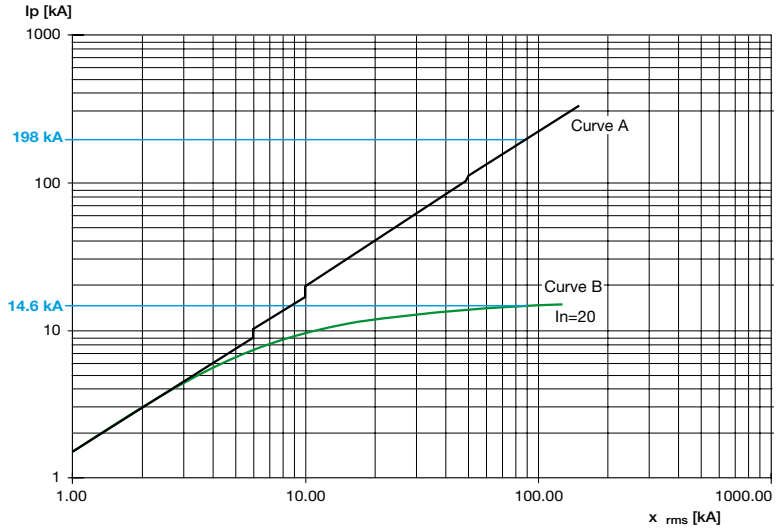

Considering that the electro-dynamic stresses and the consequent mechanical stresses are closely connected to the current peak, the use of current limiting circuit-breakers allows optimum dimensioning of the components in an electrical plant. Besides, current limitation may also be used to obtain back-up protection between two circuit-breakers in series.

## 2 General characteristics

In addition to the advantages in terms of design, the use of current-limiting circuit-breakers allows, for the cases detailed by Standard IEC 61439-1, the avoidance of short-circuit withstand verifications for switchboards. Clause 8.2.3.1 of the Standard “Circuits of ASSEMBLIES which are exempted from the verification of the short-circuit withstand strength” states that:

“A verification of the short-circuit withstand strength is not required in the following cases...

For ASSEMBLIES protected by current-limiting devices having a cut-off current not exceeding 17 kA at the maximum allowable prospective short-circuit current at the terminals of the incoming circuit of the ASSEMBLY...”

The example in the previous page included among those considered by the Standard: if the circuit-breaker was used as a main breaker in a switchboard to be installed in a point of the plant where the prospective short-circuit current is 90 kA, it would not be necessary to carry out the verification of short-circuit withstand.

## 2 General characteristics

### 2.4 Specific let-through energy curves

In case of short-circuit, the parts of a plant affected by a fault are subjected to thermal stresses which are proportional both to the square of the fault current as well as to the time required by the protection device to break the current. The energy let through by the protection device during the trip is termed "specific let-through energy" ( $I^2t$ ), measured in  $A^2s$ . The knowledge of the value of the specific let-through energy in various fault conditions is fundamental for the dimensioning and the protection of the various parts of the installation.

The effect of limitation and the reduced trip times influence the value of the specific let-through energy. For those current values for which the tripping of the circuit-breaker is regulated by the timing of the release, the value of the specific let-through energy is obtained by multiplying the square of the effective fault current by the time required for the protection device to trip; in other cases the value of the specific let-through energy may be obtained from the following diagrams.

The following is an example of the reading from a diagram of the specific let-through energy curve for a circuit-breaker type XT2L 160 In 20 at 400 V. The x-axis shows the symmetrical prospective short-circuit current, while the y-axis shows the specific let-through energy values, expressed in  $MA^2s$ . Corresponding to a short-circuit current equal to 90 kA, the circuit-breaker lets through a value of  $I^2t$  equal to 0.218  $MA^2s$ .

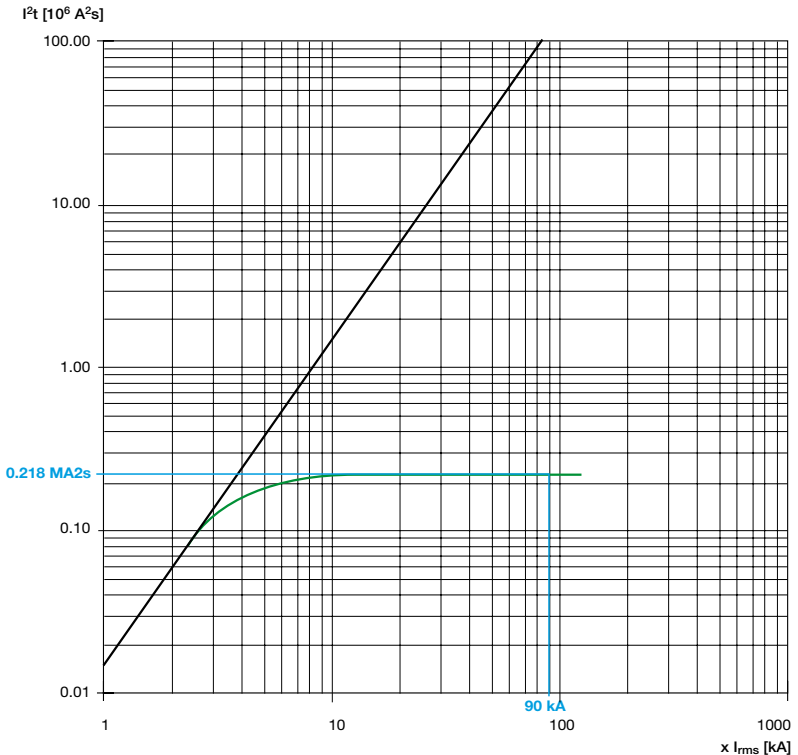

1SDC008013F0001

## 2 General characteristics

### 2.5 Temperature derating

Standard IEC 60947-2 states that the temperature rise limits for circuit-breakers working at rated current must be within the limits given in the following table:

**Table 1 - Temperature rise limits for terminals and accessible parts**

Description of part*	Temperature rise limits	
	K	
- Terminal for external connections		80
- Manual operating means:	metallic	25
	non metallic	35
- Parts intended to be touched but not hand-held:	metallic	40
	non metallic	50
- Parts which need not be touched for normal operation:	metallic	50
	non metallic	60

\* No value is specified for parts other than those listed but no damage should be caused to adjacent parts of insulating materials.

These values are valid for a maximum reference ambient temperature of 40°C, as stated in Standard IEC 60947-1, clause 6.1.1.

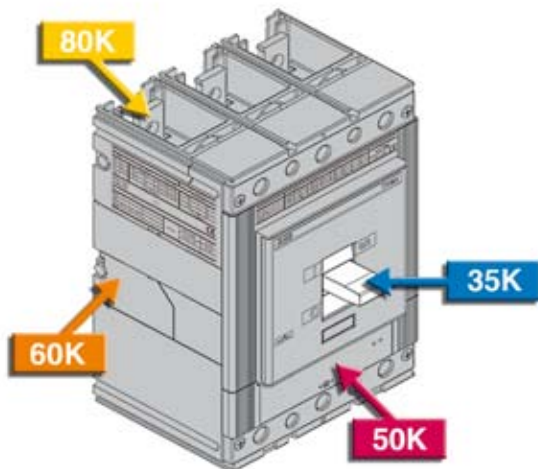



## 2 General characteristics

Whenever the ambient temperature is other than 40°C, the value of the current which can be carried continuously by the circuit-breaker is given in the following tables:

### SACE Tmax XT circuit-breakers with thermomagnetic release

In [A]	30 °C		40 °C		50 °C		60 °C		70 °C		
	MIN	MAX	MIN	MAX	MIN	MAX	MIN	MAX	MIN	MAX	
<b>XT1</b>	16	12	17	11,2	16	11	15	10	14	9	13
	20	15	21	14	20	13	19	12	18	11	16
	25	18	26	17,5	25	16	23	15	22	14	20
	32	24	34	22,4	32	21	30	20	28	18	26
	40	29	42	28	40	27	38	25	35	23	33
	50	37	53	35	50	33	47	31	44	28	41
	63	46	66	44,1	63	41	59	39	55	36	51
	80	59	84	56	80	53	75	49	70	46	65
	100	74	105	70	100	66	94	61	88	57	81
	125	92	131	87,5	125	82	117	77	109	71	102
160	118	168	112	160	105	150	98	140	91	130	
<b>XT2</b>	1,6	1,2	1,7	1,1	1,6	1,1	1,5	1	1,4	0,9	1,3
	2	1,5	2,2	1,4	2	1,3	1,9	1,2	1,7	1,1	1,6
	2,5	1,8	2,6	1,8	2,5	1,6	2,3	1,5	2,2	1,4	2
	3	2,5	3,5	2,1	3	2	2,8	1,8	2,6	1,6	2,3
	4	2,9	4,2	2,8	4	2,6	3,7	2,5	3,5	2,2	3,2
	6,3	4,6	6,6	4,4	6,3	4,1	5,9	3,9	5,5	3,6	5,1
	8	5,9	8,4	5,6	8	5,3	7,5	4,9	7	4,6	6,5
	10	7,4	10,5	7	10	6,5	9,3	6,1	8,7	5,7	8,1
	12,5	9,2	13,2	8,8	12,5	8,2	11,7	7,6	10,9	7,1	10,1
	16	11,9	17	11,2	16	10,5	15	9,8	14	9,1	13
	20	14,7	21	14	20	13,3	19	11,9	17	11,2	16
	32	23,8	34	22,4	32	21	30	19,6	28	18,2	26
	40	29,4	42	28	40	25,9	37	24,5	35	22,4	32
	50	37,1	53	35	50	32,9	47	30,1	43	28	40
	63	46,2	66	44,1	63	41,3	59	38,5	55	35,7	51
	80	58,8	84	56	80	52,5	75	49	70	45,5	65
100	73,5	105	70	100	65,1	93	60,9	87	56,7	81	
125	92,4	132	87,5	125	81,9	117	76,3	109	70,7	101	
160	117,6	168	112	160	105	150	97,3	139	90,3	129	

## 2 General characteristics

In [A]	30 °C		40 °C		50 °C		60 °C		70 °C		
	MIN	MAX	MIN	MAX	MIN	MAX	MIN	MAX	MIN	MAX	
<b>XT3</b>	63	46	66	44	63	41	59	39	55	36	51
	80	59	84	56	80	53	75	48	69	45	64
	100	74	105	70	100	65	93	61	87	56	80
	125	92	132	88	125	81	116	76	108	70	100
	160	118	168	112	160	104	149	97	139	90	129
	200	148	211	140	200	130	186	121	173	113	161
250	184	263	175	250	163	233	151	216	141	201	
<b>XT4</b>	16	12	17	11	16	10	14	9	13	8	12
	20	16	23	14	20	12	17	11	15	9	13
	25	19	27	18	25	16	23	15	21	13	19
	32	25	36	22	32	19	27	17	24	15	21
	40	30	43	28	40	26	37	24	34	21	30
	50	38	54	35	50	32	46	29	42	27	39
	63	47	67	44	63	41	58	37	53	33	48
	80	60	86	56	80	52	74	46	66	41	58
	100	74	106	70	100	67	95	60	85	53	75
	125	94	134	88	125	81	115	74	105	67	95
	160	118	168	112	160	105	150	96	137	91	130
	200	147	210	140	200	133	190	123	175	112	160
	225	168	241	158	225	146	208	133	190	119	170
250	183	262	175	250	168	240	161	230	154	220	

## 2 General characteristics

### Tmax T circuit-breakers with thermomagnetic release

In [A]	10 °C		20 °C		30 °C		40 °C		50 °C		60 °C		70 °C	
	MIN	MAX	MIN	MAX	MIN	MAX	MIN	MAX	MIN	MAX	MIN	MAX	MIN	MAX

<b>T1</b>	16	13	18	12	18	12	17	11	16	11	15	10	14	9	13
	20	16	23	15	22	15	21	14	20	13	19	12	18	11	16
	25	20	29	19	28	18	26	18	25	16	23	15	22	14	20
	32	26	37	25	35	24	34	22	32	21	30	20	28	18	26
	40	32	46	31	44	29	42	28	40	26	38	25	35	23	33
	50	40	58	39	55	37	53	35	50	33	47	31	44	28	41
	63	51	72	49	69	46	66	44	63	41	59	39	55	36	51
	80	64	92	62	88	59	84	56	80	53	75	49	70	46	65
	100	81	115	77	110	74	105	70	100	66	94	61	88	57	81
	125	101	144	96	138	92	131	88	125	82	117	77	109	71	102
160	129	184	123	176	118	168	112	160	105	150	98	140	91	130	

<b>T2</b>	1,6	1,3	1,8	1,2	1,8	1,2	1,7	1,1	1,6	1	1,5	1	1,4	0,9	1,3
	2	1,6	2,3	1,5	2,2	1,5	2,1	1,4	2	1,3	1,9	1,2	1,7	1,1	1,6
	2,5	2	2,9	1,9	2,8	1,8	2,6	1,8	2,5	1,6	2,3	1,5	2,2	1,4	2
	3,2	2,6	3,7	2,5	3,5	2,4	3,4	2,2	3,2	2,1	3	1,9	2,8	1,8	2,6
	4	3,2	4,6	3,1	4,4	2,9	4,2	2,8	4	2,6	3,7	2,4	3,5	2,3	3,2
	5	4	5,7	3,9	5,5	3,7	5,3	3,5	5	3,3	4,7	3	4,3	2,8	4
	6,3	5,1	7,2	4,9	6,9	4,6	6,6	4,4	6,3	4,1	5,9	3,8	5,5	3,6	5,1
	8	6,4	9,2	6,2	8,8	5,9	8,4	5,6	8	5,2	7,5	4,9	7	4,5	6,5
	10	8	11,5	7,7	11	7,4	10,5	7	10	6,5	9,3	6,1	8,7	5,6	8,1
	12,5	10,1	14,4	9,6	13,8	9,2	13,2	8,8	12,5	8,2	11,7	7,6	10,9	7,1	10,1
	16	13	18	12	18	12	17	11	16	10	15	10	14	9	13
	20	16	23	15	22	15	21	14	20	13	19	12	17	11	16
	25	20	29	19	28	18	26	18	25	16	23	15	22	14	20
	32	26	37	25	35	24	34	22	32	21	30	19	28	18	26
	40	32	46	31	44	29	42	28	40	26	37	24	35	23	32
	50	40	57	39	55	37	53	35	50	33	47	30	43	28	40
	63	51	72	49	69	46	66	44	63	41	59	38	55	36	51
80	64	92	62	88	59	84	56	80	52	75	49	70	45	65	
100	80	115	77	110	74	105	70	100	65	93	61	87	56	81	
125	101	144	96	138	92	132	88	125	82	117	76	109	71	101	
160	129	184	123	178	118	168	112	160	105	150	97	139	90	129	

## 2 General characteristics

In [A]	10 °C		20 °C		30 °C		40 °C		50 °C		60 °C		70 °C		
	MIN	MAX	MIN	MAX	MIN	MAX	MIN	MAX	MIN	MAX	MIN	MAX	MIN	MAX	
<b>T3</b>	63	51	72	49	69	46	66	44	63	41	59	38	55	35	51
	80	64	92	62	88	59	84	56	80	52	75	48	69	45	64
	100	80	115	77	110	74	105	70	100	65	93	61	87	56	80
	125	101	144	96	138	92	132	88	125	82	116	76	108	70	100
	160	129	184	123	176	118	168	112	160	104	149	97	139	90	129
	200	161	230	154	220	147	211	140	200	130	186	121	173	112	161
	250	201	287	193	278	184	263	175	250	163	233	152	216	141	201
<b>T4</b>	20	19	27	18	24	16	23	14	20	12	17	10	15	8	13
	32	26	43	24	39	22	36	19	32	16	27	14	24	11	21
	50	37	62	35	58	33	54	30	50	27	46	25	42	22	39
	80	59	98	55	92	52	86	48	80	44	74	40	66	32	58
	100	83	118	80	113	74	106	70	100	66	95	59	85	49	75
	125	103	145	100	140	94	134	88	125	80	115	73	105	63	95
	160	130	185	124	176	118	168	112	160	106	150	100	104	90	130
	200	162	230	155	220	147	210	140	200	133	190	122	175	107	160
250	200	285	193	275	183	262	175	250	168	240	160	230	150	220	
<b>T5</b>	320	260	368	245	350	234	335	224	320	212	305	200	285	182	263
	400	325	465	310	442	295	420	280	400	265	380	250	355	230	325
	500	435	620	405	580	380	540	350	500	315	450	280	400	240	345
<b>T6</b>	630	520	740	493	705	462	660	441	630	405	580	380	540	350	500
	800	685	965	640	905	605	855	560	800	520	740	470	670	420	610

### Examples:

Selection of a moulded-case circuit-breaker, with thermomagnetic release, for a load current of 160 A, at an ambient temperature of 60°C. From the table referring to SACE Tmax XT3, it can be seen that the most suitable breaker is the XT3 In 200, which can be set from 121 A to 173 A.

## 2 General characteristics

### Circuit-breakers with electronic release

			up to 40°C		50°C		60°C		70°C	
			I <sub>max</sub> (A)	I <sub>1</sub>	I <sub>max</sub> (A)	I <sub>1</sub>	I <sub>max</sub> (A)	I <sub>1</sub>	I <sub>max</sub> (A)	I <sub>1</sub>
<b>XT2</b>	fixed	F	160	1	160	1	146	0,92	131	0,82
<b>XT4</b>	fixed	F	250	1	250	1	238	0,96	213	0,86
<b>T4 320</b>	fixed	FC	320	1	294	0,92	269	0,84	243	0,76
		F	320	1	294	0,92	269	0,84	243	0,76
		R (HR)	320	1	294	0,92	269	0,84	243	0,76
		R (VR)	320	1	307	0,96	281	0,88	256	0,8
	plug-in	FC	320	1	294	0,92	268	0,84	242	0,76
		F	320	1	294	0,92	268	0,84	242	0,76
		HR	320	1	294	0,92	268	0,84	242	0,76
		VR	320	1	307	0,96	282	0,88	256	0,8
<b>T5 400</b>	fixed	FC	400	1	400	1	400	1	352	0,88
		F	400	1	400	1	400	1	352	0,88
		R (HR)	400	1	400	1	400	1	352	0,88
		R (VR)	400	1	400	1	400	1	368	0,92
	plug-in	FC	400	1	400	1	368	0,92	336	0,84
		F	400	1	400	1	368	0,92	336	0,84
		R (HR)	400	1	400	1	368	0,92	336	0,84
		R (VR)	400	1	400	1	382	0,96	350	0,88
<b>T5 630</b>	fixed	FC	630	1	580	0,92	529	0,84	479	0,76
		F	630	1	580	0,92	529	0,84	479	0,76
		HR	630	1	580	0,92	529	0,84	479	0,76
		VR	630	1	605	0,96	554	0,88	504	0,80
	plug-in	F	567	0,9	502	0,8	458	0,72	409	0,64
		HR	567	0,9	502	0,8	458	0,72	409	0,64
		VR	567	0,9	526	0,82	480	0,76	429	0,68

#### Caption

F= Front flat terminals

FC= Front terminals for cables

HR= Rear flat horizontal terminals

VR= Rear flat vertical terminals

R= Rear terminals

EF= Front extended

FC Cu = Front terminals for copper cables

FC CuAl= Front terminals for CuAl cables

ES= Front extended spread terminals

## 2 General characteristics

			up to 40°C		50°C		60°C		70°C	
			I <sub>max</sub> (A)	I <sub>l</sub>	I <sub>max</sub> (A)	I <sub>l</sub>	I <sub>max</sub> (A)	I <sub>l</sub>	I <sub>max</sub> (A)	I <sub>l</sub>
<b>T6 630</b>	fixed	FC	630	1	630	1	598,1	1	567	0,9
		R (VR)	630	1	630	1	630	1	598,5	0,95
		R (HR)	630	1	630	1	567	0,9	504	0,8
	plug-in	F	630	1	598,5	0,95	567	0,9	567	0,9
		VR	630	1	630	1	598,5	0,95	504	0,8
		HR	630	1	598,5	0,95	567	0,9	504	0,8
<b>T6 800</b>	fixed	FC	800	1	800	1	760	0,95	720	0,9
		R (VR)	800	1	800	1	800	1	760	0,95
		R (HR)	800	1	800	1	720	0,9	640	0,8
	plug-in	F	800	1	760	0,95	720	0,9	640	0,8
		VR	800	1	800	1	760	0,95	720	0,9
		HR	800	1	760	0,95	720	0,9	640	0,8
<b>T6 1000</b>	fixed	FC	1000	1	926	0,93	877	0,88	784	0,78
		R (HR)	1000	1	926	0,93	845	0,85	756	0,76
		R (VR)	1000	1	1000	1	913	0,92	817	0,82
		ES	1000	1	900	0,9	820	0,82	720	0,72
<b>T7 1000 V version</b>	fixed	VR	1000	1	1000	1	1000	1	894	0,89
		EF-HR	1000	1	1000	1	895	0,89	784	0,78
	plug-in	VR	1000	1	1000	1	913	0,91	816	0,82
		EF-HR	1000	1	1000	1	895	0,89	784	0,78
<b>T7 1250 V version</b>	fixed	VR	1250	1	1201	0,96	1096	0,88	981	0,78
		EF-HR	1250	1	1157	0,93	1056	0,85	945	0,76
	plug-in	VR	1250	1	1157	0,93	1056	0,85	945	0,76
		EF-HR	1250	1	1000	0,8	913	0,73	816	0,65
<b>T7 1250 S-H-L version</b>	fixed	VR	1250	1	1250	1	1250	1	1118	0,89
		EF-HR	1250	1	1250	1	1118	0,89	980	0,78
	plug-in	VR	1250	1	1250	1	1141	0,91	1021	0,82
		EF-HR	1250	1	1250	1	1118	0,89	980	0,78
<b>T7 1600 S-H-L version</b>	fixed	VR	1600	1	1537	0,96	1403	0,88	1255	0,78
		EF-HR	1600	1	1481	0,93	1352	0,85	1209	0,76
	plug-in	VR	1600	1	1481	0,93	1352	0,85	1209	0,76
		EF-HR	1600	1	1280	0,8	1168	0,73	1045	0,65

### Caption

F= Front flat terminals

FC= Front terminals for cables

HR= Rear flat horizontal terminals

VR= Rear flat vertical terminals

R= Rear terminals

EF= Front extended

FC Cu = Front terminals for copper cables

FC CuAl= Front terminals for CuAl cables

ES= Front extended spread terminals

### Example:

Selection of a moulded-case circuit-breaker, with electronic release, in withdrawable version with rear flat horizontal bar terminals, for a load current equal to 720 A, with an ambient temperature of 50 °C. From the table referring to Tmax T6, it can be seen that the most suitable breaker is the T6 800, which can be set from 320 A to 760 A.

## 2 General characteristics

### Emax X1 with horizontal rear terminals

Temperature [°C]	X1 630		X1 800		X1 1000		X1 1250		X1 1600	
	%	[A]	%	[A]	%	[A]	%	[A]	%	[A]
10	100	630	100	800	100	1000	100	1250	100	1600
20	100	630	100	800	100	1000	100	1250	100	1600
30	100	630	100	800	100	1000	100	1250	100	1600
40	100	630	100	800	100	1000	100	1250	100	1600
45	100	630	100	800	100	1000	100	1250	100	1600
50	100	630	100	800	100	1000	100	1250	97	1550
55	100	630	100	800	100	1000	100	1250	94	1500
60	100	630	100	800	100	1000	100	1250	93	1480

### Emax X1 with vertical rear terminals

Temperature [°C]	X1 630		X1 800		X1 1000		X1 1250		X1 1600	
	%	[A]	%	[A]	%	[A]	%	[A]	%	[A]
10	100	630	100	800	100	1000	100	1250	100	1600
20	100	630	100	800	100	1000	100	1250	100	1600
30	100	630	100	800	100	1000	100	1250	100	1600
40	100	630	100	800	100	1000	100	1250	100	1600
45	100	630	100	800	100	1000	100	1250	100	1600
50	100	630	100	800	100	1000	100	1250	100	1600
55	100	630	100	800	100	1000	100	1250	98	1570
60	100	630	100	800	100	1000	100	1250	95	1520

### Emax E1

Temperature [°C]	E1 800		E1 1000		E1 1250		E1 1600	
	%	[A]	%	[A]	%	[A]	%	[A]
10	100	800	100	1000	100	1250	100	1600
20	100	800	100	1000	100	1250	100	1600
30	100	800	100	1000	100	1250	100	1600
40	100	800	100	1000	100	1250	100	1600
45	100	800	100	1000	100	1250	98	1570
50	100	800	100	1000	100	1250	96	1530
55	100	800	100	1000	100	1250	94	1500
60	100	800	100	1000	100	1250	92	1470
65	100	800	100	1000	99	1240	89	1430
70	100	800	100	1000	98	1230	87	1400

## 2 General characteristics

### Emax E2

Temperature [°C]	E2 800		E2 1000		E2 1250		E2 1600		E2 2000	
	%	[A]	%	[A]	%	[A]	%	[A]	%	[A]
10	100	800	100	1000	100	1250	100	1600	100	2000
20	100	800	100	1000	100	1250	100	1600	100	2000
30	100	800	100	1000	100	1250	100	1600	100	2000
40	100	800	100	1000	100	1250	100	1600	100	2000
45	100	800	100	1000	100	1250	100	1600	100	2000
50	100	800	100	1000	100	1250	100	1600	97	1945
55	100	800	100	1000	100	1250	100	1600	94	1885
60	100	800	100	1000	100	1250	98	1570	91	1825
65	100	800	100	1000	100	1250	96	1538	88	1765
70	100	800	100	1000	100	1250	94	1510	85	1705

### Emax E3

Temperature [°C]	E3 800		E3 1000		E3 1250		E3 1600		E3 2000		E3 2500		E3 3200	
	%	[A]	%	[A]	%	[A]	%	[A]	%	[A]	%	[A]	%	[A]
10	100	800	100	1000	100	1250	100	1600	100	2000	100	2500	100	3200
20	100	800	100	1000	100	1250	100	1600	100	2000	100	2500	100	3200
30	100	800	100	1000	100	1250	100	1600	100	2000	100	2500	100	3200
40	100	800	100	1000	100	1250	100	1600	100	2000	100	2500	100	3200
45	100	800	100	1000	100	1250	100	1600	100	2000	100	2500	100	3200
50	100	800	100	1000	100	1250	100	1600	100	2000	100	2500	97	3090
55	100	800	100	1000	100	1250	100	1600	100	2000	100	2500	93	2975
60	100	800	100	1000	100	1250	100	1600	100	2000	100	2500	89	2860
65	100	800	100	1000	100	1250	100	1600	100	2000	97	2425	86	2745
70	100	800	100	1000	100	1250	100	1600	100	2000	94	2350	82	2630



## 2 General characteristics

### Emax E4

Temperature [°C]	E4 3200		E4 4000	
	%	[A]	%	[A]
10	100	3200	100	4000
20	100	3200	100	4000
30	100	3200	100	4000
40	100	3200	100	4000
45	100	3200	100	4000
50	100	3200	98	3900
55	100	3200	95	3790
60	100	3200	92	3680
65	98	3120	89	3570
70	95	3040	87	3460

### Emax E6

Temperature [°C]	E6 3200		E6 4000		E6 5000		E6 6300	
	%	[A]	%	[A]	%	[A]	%	[A]
10	100	3200	100	4000	100	5000	100	6300
20	100	3200	100	4000	100	5000	100	6300
30	100	3200	100	4000	100	5000	100	6300
40	100	3200	100	4000	100	5000	100	6300
45	100	3200	100	4000	100	5000	100	6300
50	100	3200	100	4000	100	5000	100	6300
55	100	3200	100	4000	100	5000	98	6190
60	100	3200	100	4000	98	4910	96	6070
65	100	3200	100	4000	96	4815	94	5850
70	100	3200	100	4000	94	4720	92	5600

## 2 General characteristics

The following table lists examples of the continuous current carrying capacity for circuit-breakers installed in a switchboard with the dimensions indicated below. These values refer to withdrawable switchgear installed in non segregated switchboards with a protection rating up to IP31, and following dimensions: 2000x400x400 (HxLxD) for X1, 2300x800x900 (HxLxD) for X1 - E1 - E2 - E3; 2300x1400x1500 (HxLxD) for E4 - E6.

The values refer to a maximum temperature at the terminals of 120 °C. For withdrawable circuit-breakers with a rated current of 6300 A, the use of vertical rear terminals is recommended.

For switchboards with the following dimensions (mm): 2000x400x400

Type	I <sub>n</sub> [A]	Vertical terminals				Horizontal and front terminals			
		Continuous capacity [A]			Busbars section [mm <sup>2</sup> ]	Continuous capacity [A]			Busbars section [mm <sup>2</sup> ]
		35°C	45°C	55°C		35°C	45°C	55°C	
X1B/N/L 06	630	630	630	630	2x(40x5)	630	630	630	2x(40x5)
X1B/N/L 08	800	800	800	800	2x(50x5)	800	800	800	2x(50x5)
X1B/N/ 10	1000	1000	1000	1000	2x(50x8)	1000	1000	1000	2x(50x10)
X1L 10	1000	1000	1000	960	2x(50x8)	1000	950	890	2x(50x10)
X1B/N/ 12	1250	1250	1250	1250	2x(50x8)	1250	1250	1200	2x(50x10)
X1L 12	1250	1250	1205	1105	2x(50x8)	1250	1125	955	2x(50x10)
X1B/N 16	1600	1520	1440	1340	2x(50x10)	1400	1330	1250	3x(50x8)

For switchboards with the following dimensions (mm): 2300x800x900

Type	I <sub>n</sub> [A]	Vertical terminals				Horizontal and front terminals			
		Continuous capacity [A]			Busbars section [mm <sup>2</sup> ]	Continuous capacity [A]			Busbars section [mm <sup>2</sup> ]
		35°C	45°C	55°C		35°C	45°C	55°C	
X1B/N/L 06	630	630	630	630	2x(40x5)	630	630	630	2x(40x5)
X1B/N/L 08	800	800	800	800	2x(50x5)	800	800	800	2x(50x5)
X1B/N/L 10	1000	1000	1000	1000	2x(50x8)	1000	1000	1000	2x(50x10)
X1L 10	1000	1000	1000	1000	2x(50x8)	1000	960	900	2x(50x10)
X1B/N/L 12	1250	1250	1250	1250	2x(50x8)	1250	1250	1200	2x(50x10)
X1L 12	1250	1250	1250	1110	2x(50x8)	1250	1150	960	2x(50x10)
X1B/N 16	1600	1600	1500	1400	2x(50x10)	1460	1400	1300	3x(50x8)

## 2 General characteristics

Type	I <sub>n</sub> [A]	Vertical terminals				Horizontal and front terminals			
		Continuous capacity			Busbars section [mm <sup>2</sup> ]	Continuous capacity			Busbars section [mm <sup>2</sup> ]
		35°C	45°C	55°C		35°C	45°C	55°C	
E1B/N 08	800	800	800	800	1x(60x10)	800	800	800	1x(60x10)
E1B/N 10	1000	1000	1000	1000	1x(80x10)	1000	1000	1000	2x(60x8)
E1B/N 12	1250	1250	1250	1250	1x(80x10)	1250	1250	1200	2x(60x8)
E1B/N 16	1600	1600	1600	1500	2x(60x10)	1550	1450	1350	2x(60x10)
E2S 08	800	800	800	800	1x(60x10)	800	800	800	1x(60x10)
E2N/S 10	1000	1000	1000	1000	1x(60x10)	1000	1000	1000	1x(60x10)
E2N/S 12	1250	1250	1250	1250	1x(60x10)	1250	1250	1250	1x(60x10)
E2B/N/S 16	1600	1600	1600	1600	2x(60x10)	1600	1600	1530	2x(60x10)
E2B/N/S 20	2000	2000	2000	1800	3x(60x10)	2000	2000	1750	3x(60x10)
E2L 12	1250	1250	1250	1250	1x(60x10)	1250	1250	1250	1x(60x10)
E2L 16	1600	1600	1600	1500	2x(60x10)	1600	1500	1400	2x(60x10)
E3H/V 08	800	800	800	800	1x(60x10)	800	800	800	1x(60x10)
E3S/H 10	1000	1000	1000	1000	1x(60x10)	1000	1000	1000	1x(60x10)
E3S/H/V 12	1250	1250	1250	1250	1x(60x10)	1250	1250	1250	1x(60x10)
E3S/H/V 16	1600	1600	1600	1600	1x(100x10)	1600	1600	1600	1x(100x10)
E3S/H/V 20	2000	2000	2000	2000	2x(100x10)	2000	2000	2000	2x(100x10)
E3N/S/H/V 25	2500	2500	2500	2500	2x(100x10)	2500	2450	2400	2x(100x10)
E3N/S/H/V 32	3200	3200	3100	2800	3x(100x10)	3000	2880	2650	3x(100x10)
E3L 20	2000	2000	2000	2000	2x(100x10)	2000	2000	1970	2x(100x10)
E3L 25	2500	2500	2390	2250	2x(100x10)	2375	2270	2100	2x(100x10)
E4H/V 32	3200	3200	3200	3200	3x(100x10)	3200	3150	3000	3x(100x10)
E4S/H/V 40	4000	4000	3980	3500	4x(100x10)	3600	3510	3150	6x(60x10)
E6V 32	3200	3200	3200	3200	3x(100x10)	3200	3200	3200	3x(100x10)
E6H/V 40	4000	4000	4000	4000	4x(100x10)	4000	4000	4000	4x(100x10)
E6H/V 50	5000	5000	4850	4600	6x(100x10)	4850	4510	4250	6x(100x10)
E6H/V 63	6300	6000	5700	5250	7x(100x10)	-	-	-	-

Note: the reference temperature is the ambient temperature

### Examples:

Selection of an air circuit-breaker, with electronic release, in withdrawable version, with vertical terminals, for a load current of 2700 A, with a temperature of 55 °C outside of the IP31 switchboard.

From the tables referring to the current carrying capacity inside the switchboard for Emax circuit-breaker (see above), it can be seen that the most suitable breaker is the E3 3200, with busbars section 3x(100x10) mm<sup>2</sup>, which can be set from 1280 A to 2800 A.

## 2 General characteristics

### 2.6 Altitude derating

For installations carried out at altitudes of more than 2000 m above sea level, the performance of low voltage circuit-breakers is subject to a decline.

Basically there are two main phenomena:

- the reduction of air density causes a lower efficiency in heat transfer. The allowable heating conditions for the various parts of the circuit-breaker can only be followed if the value of the rated uninterrupted current is decreased;
- the rarefaction of the air causes a decrease in dielectric rigidity, so the usual isolation distances become insufficient. This leads to a decrease in the maximum rated voltage at which the device can be used.

The correction factors for the different types of circuit-breakers, both moulded-case and air circuit-breakers, are given in the following table:

Rated operational voltage $U_e$ [V]				
Altitude	2000[m]	3000[m]	4000[m]	5000[m]
Tmax XT	690	600	540	470
Tmax T*	690	600	500	440
E <sub>max</sub>	690	600	500	440

Rated uninterrupted current $I_u$ [A]				
Altitude	2000[m]	3000[m]	4000[m]	5000[m]
Tmax XT	100%	98%	93%	90%
Tmax T	100%	98%	93%	90%
E <sub>max</sub>	100%	98%	93%	90%

\*Excluding Tmax T1P

---

## 2 General characteristics

---

### 2.7 Electrical characteristics of switch disconnectors

A switch disconnector as defined by the standard IEC 60947-3 is a mechanical switching device which, when in the open position, carries out a disconnecting function and ensures an isolating distance (distance between contacts) sufficient to guarantee safety. This safety of disconnection must be guaranteed and verified by the positive operation: the operating lever must always indicate the actual position of the mobile contacts of the device.

The mechanical switching device must be able to make, carry and break currents in normal circuit conditions, including any overload currents in normal service, and to carry, for a specified duration, currents in abnormal circuit conditions, such as, for example, short-circuit conditions.

Switch disconnectors are often used as:

- main sub-switchboard devices;
- switching and disconnecting devices for lines, busbars or load units;
- bus-tie.

The switch disconnector shall ensure that the whole plant or part of it is not live, safely disconnecting from any electrical supply. The use of such a switch disconnector allows, for example, personnel to carry out work on the plant without risks of electrical nature.

Even if the use of a single pole devices side by side is not forbidden, the standards recommend the use of multi-pole devices so as to guarantee the simultaneous isolation of all poles in the circuit.

The specific rated characteristics of switch disconnectors are defined by the standard IEC 60947-3, as detailed below:

- **I<sub>cw</sub> [kA]**: rated short-time withstand current:

is the current that a switch is capable of carrying, without damage, in the closed position for a specific duration

## 2 General characteristics

- **I<sub>cm</sub> [kA]:** rated short-circuit making capacity:

is the maximum peak value of a short-circuit current which the switch disconnector can close without damages. When this value is not given by the manufacturer it must be taken to be at least equal to the peak current corresponding to I<sub>cw</sub>. It is not possible to define a breaking capacity I<sub>cu</sub> [kA] since switch disconnectors are not required to break short-circuit currents

- **utilization categories with alternating current AC and with direct current DC:**

define the kind of the conditions of using which are represented by two letters to indicate the type of circuit in which the device may be installed (AC for alternating current and DC for direct current), with a two digit number for the type of load which must be operated, and an additional letter (A or B) which represents the frequency in the using.

With reference to the utilization categories, the product standard defines the current values which the switch disconnector must be able to break and make under abnormal conditions.

The characteristics of the utilization categories are detailed in Table 1 below. The most demanding category in alternating current is AC23A, for which the device must be capable of connecting a current equal to 10 times the rated current of the device, and of disconnecting a current equal to 8 times the rated current of the device.

From the point of view of construction, the switch disconnector is a very simple device. It is not fitted with devices for overcurrent detection and the consequent automatic interruption of the current. Therefore the switch disconnector cannot be used for automatic protection against overcurrent which may occur in the case of failure, protection must be provided by a coordinated circuit-breaker. The combination of the two devices allows the use of switch disconnectors in systems in which the short-circuit current value is greater than the electrical parameters which define the performance of the disconnector (back-up protection see Chapter 3.4. This is valid only for I<sub>so</sub>max and T<sub>max</sub> switch-disconnectors. For the E<sub>max</sub>/MS air disconnectors, it must be verified that the values for I<sub>cw</sub> and I<sub>cm</sub> are higher to the values for short-circuit in the plant and correspondent peak, respectively.

## 2 General characteristics

**Table1: Utilization categories**

Nature of current	Utilization categories		
	Utilization category		Typical applications
	Frequent operation	Non-frequent operation	
Alternating Current	AC-20A	AC-20B	Connecting and disconnecting under no-load conditions
	AC-21A	AC-21B	Switching of resistive loads including moderate overloads
	AC-22A	AC-22B	Switching of mixed resistive and inductive loads, including moderate overload
	AC-23A	AC-23B	Switching of motor loads or other highly inductive loads
Direct Current	DC-20A	DC-20B	Connecting and disconnecting under no-load conditions
	DC-21A	DC-21B	Switching of resistive loads including moderate overloads
	DC-22A	DC-22B	Switching of mixed resistive and inductive loads, including moderate overload (e.g. shunt motors)
	DC-23A	DC-23B	Switching of highly inductive loads

## 2 General characteristics

Tables 2, 3 and 4 detail the main characteristics of the disconnectors.

**Table 2: SACE Tmax XT switch disconnectors**

Size		[A]
Rated operating current in class AC21, $I_e$		[A]
Rated operating current in class AC22, $I_e$		[A]
Rated operating current in class AC23, $I_e$		[A]
Poles		[Nr.]
Rated service voltage, $U_e$ (AC)	50-60Hz	[V]
	(DC)	[V]
Rated insulation voltage, $U_i$		[V]
Rated impulse withstand voltage, $U_{imp}$		[kV]
Test voltage at industrial frequency for 1 min		[V]
Rated breaking capacity in short-circuit, $I_{cm}$ (Min) Disconnector only		[kA]
	(Max) With automatic	[kA]
Circuit-breaker on supply side Rated short-time withstand current for 1s, $I_{cw}$		[kA]
Versions		

**Table 3: Tmax T switch disconnectors**

				Tmax T1D	Tmax T3D
Conventional thermal current, $I_{th}$			[A]	160	250
Rated service current in category AC22, $I_e$			[A]	160	250
Rated service current in category AC23, $I_e$			[A]	125	200
Poles			[Nr.]	3/4	3/4
Rated service voltage, $U_e$	(AC) 50-60 Hz		[V]	690	690
	(DC)		[V]	500	500
Rated impulse withstand voltage, $U_{imp}$			[kV]	8	8
Rated insulation voltage, $U_i$			[V]	800	800
Test voltage at industrial frequency for 1 minute			[V]	3000	3000
Rated short-circuit making capacity, $I_{cm}$ (min) switch-disconnector only			[kA]	2.8	5.3
	(max) with circuit-breaker on supply side		[kA]	187	105
Rated short-time withstand current for 1s, $I_{cw}$			[kA]	2	3.6
Reference Standard				IEC 60947-3	IEC 60947-3
Versions				F	F - P
Terminals				FC Cu - EF - FC CuAl	F-FC CuAl-FC Cu-EF-ES-R
Mechanical life			[No. operations]	25000	25000
			[No. Hourly operations]	120	120
Weight	fixed	3/4 poles	[kg]	0.9/1.2	1.5/2
	plug-in	3/4 poles	[kg]	-	2.1/3.7
	withdrawable	3/4 poles	[kg]	-	-



## 2 General characteristics

Tmax XT1D	Tmax XT3D	Tmax XT4D
160	250	250
160	250	250
160	250	250
125	200	200
3,4	3,4	3,4
690	690	690
500	500	500
800	800	800
8	8	8
3000	3000	3000
2,8	5,3	5,3
187	105	105
2	3,6	3,6
Fixed / Plug-in	Fixed / Plug-in	Fixed / Withdrawable / Plug-in

Tmax T4D	Tmax T5D	Tmax T6D	Tmax T7D
250/320	400/630	630/800/1000	1000/1250/1600
250/320	400/630	630/800/1000	1000/1250/1600
250	400	630/800/800	1000/1250/1250
3/4	3/4	3/4	3/4
690	690	690	690
750	750	750	750
8	8	8	8
800	800	1000	1000
3000	3000	3500	3000
5.3	11	30	52.5
440	440	440	440
3.6	6	15	20
IEC 60947-3	IEC 60947-3	IEC 60947-3	IEC 60947-3
F - P - W	F - P - W	F-W	F-W
F-FC CuAl-FC Cu-EF-ES-R-MC-HR-VR	F-FC CuAl-FC Cu-EF-ES-R-HR-VR	F-FC CuAl-EF-ES-R-RC	F-EF-ES-FC CuAl HR/VR
20000	20000	20000	10000
120	120	120	60
2.35/3.05	3.25/4.15	9.5/12	9.7/12.5(manual)/11/14(motorizable)
3.6/4.65	5.15/6.65	–	–
3.85/4.9	5.4/6.9	12.1/15.1	29.7/39.6(manual)/32/42.6(motorizable)

KEY TO VERSIONS  
 F = Fixed  
 P = Plug-in  
 W = Withdrawable

KEY TO TERMINALS  
 F = Front  
 EF = Extended front  
 ES = Extended spreaded front

FC CuAl = Front for copper or aluminium cables  
 R = Rear threaded  
 RC = Rear for copper or aluminium cables  
 HR = Rear horizontal flat bar

VR = Rear vertical flat bar

## 2 General characteristics

**Table 4: Emax switch disconnectors**

		X1B/MS	E1B/MS	E1N/MS	E2B/MS	E2N/MS
<b>Rated uninterrupted current</b> (a 40 °C) $I_u$	[A]	1000	800	800	1600	1000
	[A]	1250	1000	1000	2000	1250
	[A]	1600	1250	1250		1600
	[A]		1600	1600		2000
	[A]					
	[A]					
<b>Rated operational voltage</b> $U_e$	[V ~]	690	690	690	690	690
	[V -]	250	250	250	250	250
<b>Rated insulation voltage</b> $U_i$	[V ~]	1000	1000	1000	1000	1000
<b>Rated impulse withstand voltage</b> $U_{imp}$	[kV]	12	12	12	12	12
<b>Rated short-time withstand current</b> $I_{cw}$	(1s) [kA]	42	42	50 <sup>(1)</sup>	42	55
	(3s) [kA]		36	36	42	42
<b>Rated short-circuit making capacity (peak value)</b> $I_{cm}$						
	220/230/380/400/415/440 V ~ [kA]	88.2	88.2	105	88.2	121
	500/660/690 V ~ [kA]	88.2	88.2	105	88.2	121

**Note:** the breaking capacity  $I_{cu}$ , at the maximum rated use voltage, by means of external protection relay, with 500 ms maximum timing, is equal to the value of  $I_{cw}$  (1s).

## 2 General characteristics

E2S/MS	E3N/MS	E3S/MS	E3V/MS	E4S/fMS	E4S/MS	E4H/fMS	E4H/MS	E6H/MS	E6H/f MS
1000	2500	1000	800	4000	4000	3200	3200	4000	4000
1250	3200	1250	1250			4000	4000	5000	5000
1600		1600	1600					6300	6300
2000		2000	2000						
		2500	2600						
		3200	3200						
690	690	690	690	690	690	690	690	690	690
250	250	250	250	250	250	250	250	250	250
1000	1000	1000	1000	1000	1000	1000	1000	1000	1000
12	12	12	12	12	12	12	12	12	12
65	65	75	85	75	75	85	100 <sup>(2)</sup>	100	100
42	65	65	65	75	75	75	75	85	85
187	143	165	187	165	165	187	220	220	220
143	143	165	187	165	165	187	220	220	220

<sup>(1)</sup>  $I_{cw} = 36 \text{ kA} @ 690 \text{ V}$ .

<sup>(2)</sup>  $I_{cw} = 85 \text{ kA} @ 690 \text{ V}$ .

---

## 3 Protection coordination

### 3.1 Protection coordination

The design of a system for protecting an electric network is of fundamental importance both to ensure the correct economic and functional operation of the installation as a whole and to reduce to a minimum any problem caused by anomalous operating conditions and/or malfunctions.

The present analysis discusses the coordination between the different devices dedicated to the protection of zones and specific components with a view to:

- guaranteeing safety for people and installation at all times;
- identifying and rapidly excluding only the zone affected by a problem, instead of taking indiscriminate actions and thus reducing the energy available to the rest of the network;
- containing the effects of a malfunction on other intact parts of the network (voltage dips, loss of stability in the rotating machines);
- reducing the stress on components and damage in the affected zone;
- ensuring the continuity of the service with a good quality feeding voltage;
- guaranteeing an adequate back-up in the event of any malfunction of the protective device responsible for opening the circuit;
- providing staff and management systems with the information they need to restore the service as rapidly as possible and with a minimal disturbance to the rest of the network;
- achieving a valid compromise between reliability, simplicity and cost effectiveness.

To be more precise, a valid protection system must be able to:

- understand what has happened and where it has happened, discriminating between situations that are anomalous but tolerable and faults within a given zone of influence, avoiding unnecessary tripping and the consequent unjustified disconnection of a sound part of the system;
- take action as rapidly as possible to contain damage (destruction, accelerated ageing, ...), safeguarding the continuity and stability of the power supply.

The most suitable solution derives from a compromise between these two opposing needs-to identify precisely the fault and to act rapidly - and is defined in function of which of these two requirements takes priority.

### Over-current coordination

#### Influence of the network's electrical parameters (rated current and short-circuit current)

The strategy adopted to coordinate the protective devices depends mainly on the rated current ( $I_n$ ) and short-circuit current ( $I_s$ ) values in the considered point of network.

Generally speaking, we can classify the following types of coordination:

- current discrimination;
- time (or time-current) discrimination;
- zone (or logical) discrimination;
- energy discrimination;
- back-up.

## 3 Protection coordination

### Definition of discrimination

The **over-current discrimination** is defined in the Standards as “*coordination of the operating characteristics of two or more over-current protective devices such that, on the incidence of over-currents within stated limits, the device intended to operate within these limits does so, while the others do not operate*” (IEC 60947-1, def. 2.5.23);

It is possible to distinguish between:

- **total discrimination**, which means “*over-current discrimination such that, in the case of two over-current protective devices in series, the protective device on the load side provides protection without tripping the other protective device*” (IEC 60947-2, def. 2.17.2);
- **partial discrimination**, which means “*over-current discrimination such that, in the case of two over-current protective devices in series, the protective device on the load side provides protection up to a given over-current limit without tripping the other*” (IEC 60947-2, def. 2.17.3); this over-current threshold is called “*discrimination limit current  $I_s$* ” (IEC 60947-2, def. 2.17.4).

### Current discrimination

This type of discrimination is based on the observation that the closer the fault comes to the network's feeder, the greater the short-circuit current will be. We can therefore pinpoint the zone where the fault has occurred simply by calibrating the instantaneous protection of the device upstream to a limit value higher than the fault current which causes the tripping of the device downstream.

We can normally achieve total discrimination only in specific cases where the fault current is not very high (and comparable with the device's rated current) or where a component with high impedance is between the two protective devices (e.g. a transformer, a very long or small cable...) giving rise to a large difference between the short-circuit current values.

This type of coordination is consequently feasible mainly in final distribution networks (with low rated current and short-circuit current values and a high impedance of the connection cables).

The devices' time-current tripping curves are generally used for the study.

This solution is:

- rapid;
- easy to implement;
- and inexpensive.

On the other hand:

- the discrimination limits are normally low;
- increasing the discrimination levels causes a rapid growing of the device sizes.

The following example shows a typical application of current discrimination based on the different instantaneous tripping threshold values of the circuit-breakers considered.

### 3 Protection coordination

With a fault current value at the defined point equal to 1000 A, an adequate coordination is obtained by using the considered circuit-breakers as verified in the tripping curves of the protection devices.

The discrimination limit is given by the minimum magnetic threshold of the circuit-breaker upstream, XT1B160 In160.

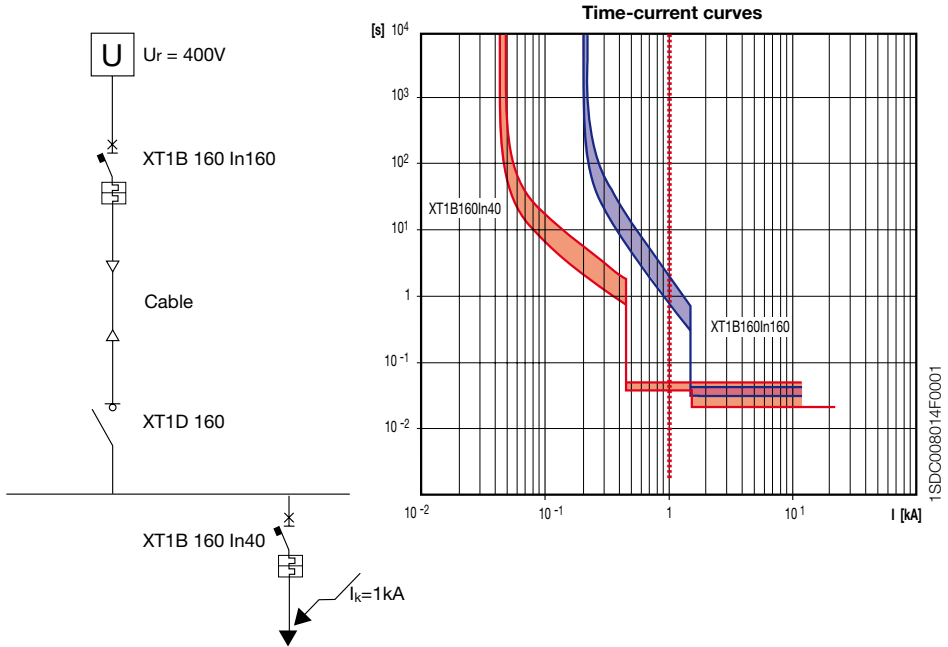

#### Time discrimination

This type of discrimination is an evolution from the previous one. The setting strategy is therefore based on progressively increasing the current thresholds and the time delays for tripping the protective devices as we come closer to the power supply source. As in the case of current discrimination, the study is based on a comparison of the time-current tripping curves of the protective devices.

#### ***This type of coordination:***

- is easy to study and implement;
- is relatively inexpensive;
- enables to achieve even high discrimination levels, depending on the  $I_{cw}$  of the upstream device;
- allows a redundancy of the protective functions and can send valid information to the control system,

#### ***but has the following disadvantages:***

- the tripping times and the energy levels that the protective devices (especially those closer to the sources) let through are high, with obvious problems concerning safety and damage to the components even in zones unaffected by the fault;

### 3 Protection coordination

- it enables the use of current-limiting circuit-breakers only at levels hierarchically lower down the chain; the other circuit-breakers have to be capable of withstanding the thermal and electro-dynamic stresses related to the passage of the fault current for the intentional time delay. Selective circuit-breakers, often air type, have to be used for the various levels to guarantee a sufficiently high short-time withstand current;
- the duration of the disturbance induced by the short-circuit current on the power supply voltages in the zones unaffected by the fault can cause problems with electronic and electro-mechanical devices (voltage below the electromagnetic releasing value);
- the number of discrimination levels is limited by the maximum time that the network can stand without loss of stability.

The following example shows a typical application of time discrimination obtained by setting differently the tripping times of the different protection devices.

Electronic release:	L (Long delay)	S (Short delay)	I (IST)
E4S 4000 PR121-LSI In4000	Setting: 0.93 Curve: 36s	Setting: 10 Curve: 0.5s	Off
E3N 2500 PR121-LSI In2500	Setting: 1 Curve: 24s	Setting: 10 Curve: 0.2s	Off
T7H 1600 PR332-LI In1600	Setting: 1 Curve: 18s		Setting: 10

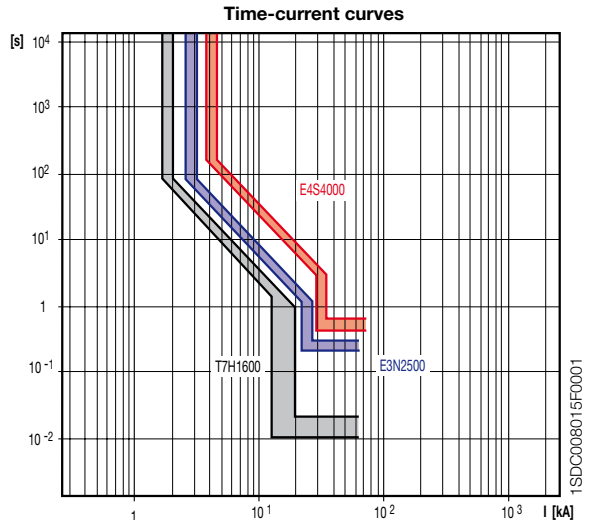
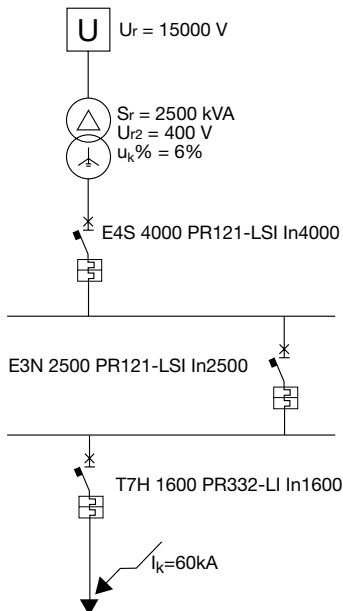

## 3 Protection coordination

### Zone (or logical) discrimination

The zone discrimination is available with MCCB (T4 L-T5 L-T6 L with PR223-EF) and ACB (with PR332/P - PR333/P - PR122 - PR 123).

This type of coordination is implemented by means of a dialogue between current measuring devices that, when they ascertain that a setting threshold has been exceeded, give the correct identification and disconnection only of the zone affected by the fault.

In practice, it can be implemented in two ways:

- the releases send information on the preset current threshold that has been exceeded to the supervisor system and the latter decides which protective device has to trip;
- in the event of current values exceeding its setting threshold, each protective device sends a blocking signal via a direct connection or bus to the protective device higher in the hierarchy (i.e. upstream with respect to the direction of the power flow) and, before it trips, it makes sure that a similar blocking signal has not arrived from the protective device downstream; in this way, only the protective device immediately upstream of the fault trips.

The first mode foresees tripping times of about one second and is used mainly in the case of not particularly high short-circuit currents where a power flow is not uniquely defined.

The second mode enables distinctly shorter tripping times: with respect to a time discrimination coordination, there is no longer any need to increase the intentional time delay progressively as we move closer to the source of the power supply. The maximum delay is in relation to the time necessary to detect any presence of a blocking signal sent from the protective device downstream.

#### **Advantages:**

- reduction of the tripping times and increase of the safety level;
- reduction of both the damages caused by the fault as well of the disturbances in the power supply network;
- reduction of the thermal and dynamic stresses on the circuit-breakers and on the components of the system;
- large number of discrimination levels;
- redundancy of protections: in case of malfunction of zone discrimination, the tripping is ensured by the settings of the other protection functions of the circuit-breakers. In particular, it is possible to adjust the time-delay protection functions against short-circuit at increasing time values, the closer they are to the network's feeder.

#### **Disadvantages:**

- higher costs;
- greater complexity of the system (special components, additional wiring, auxiliary power sources, ...).

This solution is therefore used mainly in systems with high rated current and high short-circuit current values, with precise needs in terms of both safety and continuity of service: in particular, examples of logical discrimination can be often found in primary distribution switchboards, immediately downstream of transformers and generators and in meshed networks.



## 3 Protection coordination

### Zone selectivity with Emax

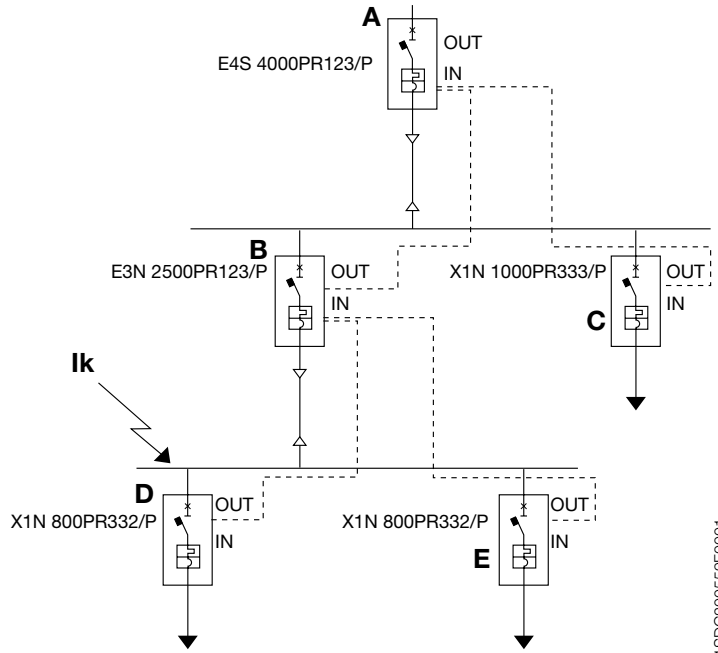

1SDC200559F0001

The example above shows a plant wired so as to guarantee zone selectivity with Emax CB equipped with PR332/P-PR333/P-PR122/P-PR123/P releases.

Each circuit-breaker detecting a fault sends a signal to the circuit-breaker immediately on the supply side through a communication wire; the circuit-breaker that does not receive any communication from the circuit-breakers on the load side shall launch the opening command.

In this example, with a fault located in the indicated point, the circuit-breakers D and E do not detect the fault and therefore they do not communicate with the circuit-breaker on the supply side (circuit-breaker B), which shall launch the opening command within the selectivity time set from 40 to 200 ms.

To actuate correctly zone selectivity, the following settings are suggested:

S	$t_2 \geq \text{selectivity time} + 70 \text{ ms}$
I	$I_3 = \text{OFF}$
G	$t_4 \geq \text{selectivity time} + 70 \text{ ms}$
Selectivity time	same settings for each circuit-breaker

### 3 Protection coordination

#### Zone selectivity for circuit-breakers type Tmax (T4L-T5L-T6L) with PR223 EF releases

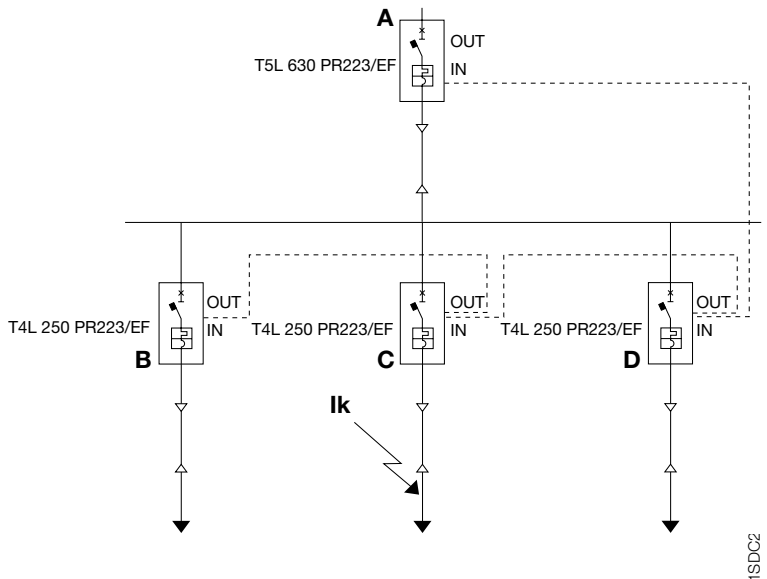

The example above shows a plant wired through an interlocking protocol (Interlocking, IL), so as to guarantee zone selectivity through PR223 EF release.

In case of short-circuit, the circuit-breaker immediately on the supply side of the fault sends through the bus a block signal to the protection device hierarchically higher and verifies, before tripping, that an analogous block signal has not been sent by the protection on the load side.

In the example in the figure, the circuit-breaker C, immediately on the supply side of the fault, sends a block signal to the circuit-breaker A, which is hierarchically higher. If, as in the given example, no protection on the load side is present, the circuit-breaker C shall open in very quick times since it has received no block signal.

Everything occurs in shorter times (10 to 15ms) than in the case of zone selectivity with the Emax series air circuit-breaker (40 to 200ms), thus subjecting the plant to lower electrodynamic stresses, and with a consequent cost reduction for the plant.

## 3 Protection coordination

### Energy discrimination

Energy coordination is a particular type of discrimination that exploits the current-limiting characteristics of moulded-case circuit-breakers. It is important to remember that a current-limiting circuit-breaker is “*a circuit-breaker with a break time short enough to prevent the short-circuit current reaching its otherwise attainable peak value*” (IEC 60947-2, def. 2.3).

In practice, ABB SACE moulded-case circuit-breakers SACE Tmax XT and Tmax T series, under short-circuit conditions, are extremely rapid (tripping times of about some milliseconds) and therefore it is impossible to use the time-current curves for the coordination studies.

The phenomena are mainly dynamic (and therefore proportional to the square of the instantaneous current value) and can be described by using the specific let-through energy curves.

In general, it is necessary to verify that the let-through energy of the circuit-breaker downstream is lower than the energy value needed to complete the opening of the circuit-breaker upstream.

This type of discrimination is certainly more difficult to consider than the previous ones because it depends largely on the interaction between the two devices placed in series and demands access to data often unavailable to the end user. Manufacturers provide tables, rules and calculation programs in which the minimum discrimination limits are given between different combinations of circuit-breakers.

#### **Advantages:**

- fast breaking, with tripping times which reduce as the short-circuit current increases;
- reduction of the damages caused by the fault (thermal and dynamic stresses), of the disturbances to the power supply system, of the costs...;
- the discrimination level is no longer limited by the value of the short-time withstand current  $I_{cw}$  which the devices can withstand;
- large number of discrimination levels;
- possibility of coordination of different current-limiting devices (fuses, circuit-breakers,..) even if they are positioned in intermediate positions along the chain.

#### **Disadvantage:**

- difficulty of coordination between circuit-breakers of similar sizes.

This type of coordination is used above all for secondary and final distribution networks, with rated currents below 1600A.

### Back-up protection

The back-up protection is an “*over-current coordination of two over-current protective devices in series where the protective device, generally but not necessarily on the supply side, effects the over-current protection with or without the assistance of the other protective device and prevents any excessive stress on the latter*” (IEC 60947-1, def. 2.5.24).

Besides, IEC 60364-4-43, 434.5.1 states: “... A lower breaking capacity is admitted if another protective device having the necessary breaking capacity is installed on the supply side. In that case, characteristics of the devices, must be co-ordinated so that the energy let through by these two devices does not exceed that which can be withstood without damage by the device on the load side and the conductors protected by these devices.”

## 3 Protection coordination

### **Advantages:**

- cost-saving solution;
- extremely rapid tripping.

### **Disadvantages:**

- extremely low discrimination values;
- low service quality, since at least two circuit-breakers in series have to trip.

## Coordination between circuit-breaker and switch disconnecter

### **The switch disconnecter**

The switch disconnectors derive from the corresponding circuit-breakers, of which they keep the overall dimensions, the fixing systems and the possibility of mounting all the accessories provided for the basic versions. They are devices which can make, carry and break currents under normal service conditions of the circuit.

They can also be used as general circuit-breakers in sub-switchboards, as bus-ties, or to isolate installation parts, such as lines, busbars or groups of loads. Once the contacts have opened, these switches guarantee isolation thanks to their contacts, which are at the suitable distance to prevent an arc from striking in compliance with the prescriptions of the standards regarding aptitude to isolation.

### **Protection of switch disconnectors**

Each switch disconnecter shall be protected by a coordinated device which safeguards it against overcurrents, usually a circuit-breaker able to limit the short-circuit current and the let-through energy values at levels acceptable for the switch-disconnector.

As regards overload protection, the rated current of the circuit-breaker shall be lower than or equal to the size of the disconnecter to be protected.

Regarding SACE Tmax XT and Tmax T series switch disconnectors the coordination tables show the circuit-breakers which can protect them against the indicated prospective short-circuit currents values.

Regarding Emax series switch disconnectors it is necessary to verify that the short-circuit current value at the installation point is lower than the short-time withstand current  $I_{cw}$  of the disconnecter, and that the peak value is lower than the making current value ( $I_{cm}$ ).

## 3 Protection coordination

### 3.2 Discrimination tables

The tables below give the selectivity values of short-circuit currents (in kA) between pre-selected combinations of circuit-breakers, for voltages from 230/240 to 415 V, according annex A of IEC 60947-2. The tables cover the possible combinations of ABB SACE Emax air circuit-breakers series, SACE Tmax XT and Tmax T moulded-case circuit-breakers series and the series of ABB modular circuit-breakers. The values are obtained following particular rules which, if not respected, may give selectivity values which in some cases may be much lower than those given. Some of these guidelines are generally valid and are indicated below; others refer exclusively to particular types of circuit-breakers and will be subject to notes below the relevant table.

#### General rules:

- the function I of electronic releases of upstream breakers must be excluded (I3 in OFF);
- the magnetic trip of thermomagnetic (TM) or magnetic only (MA-MF) breakers positioned upstream must be  $\geq 10 \cdot I_n$  and set to the maximum threshold;
- it is fundamentally important to verify that the settings adopted by the user for the electronic and thermomagnetic releases of breakers positioned either upstream or downstream result in time-current curves properly spaced.

#### Notes for the correct reading of the coordination tables:

The limit value of selectivity is obtained considering the lower among the given value, the breaking capacity of the CB on the supply side and the breaking capacity of the CB on the load side.

The letter T indicates total selectivity for the given combination, the corresponding value in kA is obtained considering the lower of the downstream and upstream circuit-breakers' breaking capacities (Icu).

The following tables show the breaking capacities at 415Vac for SACE Emax, SACE Tmax XT and Tmax T circuit-breakers.

Tmax XT @ 415V ac	
Version	Icu [kA]
B	18
C	25
N	36
S	50
H	70
L	120
V	150

Tmax T @ 415V ac	
Version	Icu [kA]
B	16
C	25
N	36
S	50
H	70
L (for T2)	85
L (for T4-T5-T7)	120
L (for T6)	100
V (for T7)	150
V	200

Emax @ 415V ac	
Version	Icu [kA]
B	42
N	65*
S	75**
H	100
L	130***
V	150****

\* For Emax E1 version N Icu=50kA

\*\* For Emax E2 version S Icu=85kA

\*\*\* For Emax X1 version L Icu=150kA

\*\*\*\* For Emax E3 version V Icu=130kA

#### Keys

<p>For MCCB (Moulded-case circuit-breaker) ACB (Air circuit-breaker) TM = thermomagnetic release – TMD (Tmax) – TMA (Tmax) M = magnetic only release – MF (Tmax) – MA (Tmax) EL = electronic release</p>	<p>For MCB (Miniature circuit-breaker): B = characteristic trip (I3=3...5In) C = characteristic trip (I3=5...10In) D = characteristic trip (I3=10...20In) K = characteristic trip (I3=8...14In) Z = characteristic trip (I3=2...3In)</p>
--	--

### 3 Protection coordination

#### Example:

From the selectivity table on page 154 it can be seen that breakers E2N1250 and T5H400, correctly set, are selective up to 55kA (higher than the short-circuit current at the busbar).

From the selectivity table on page 149 it can be seen that, between T5H400 and XT1N160 In125, the total selectivity is granted; as already specified on page 123 this means selectivity up to the breaking capacity of XT1N and therefore up to 36 kA (higher than the short-circuit current at the busbar).

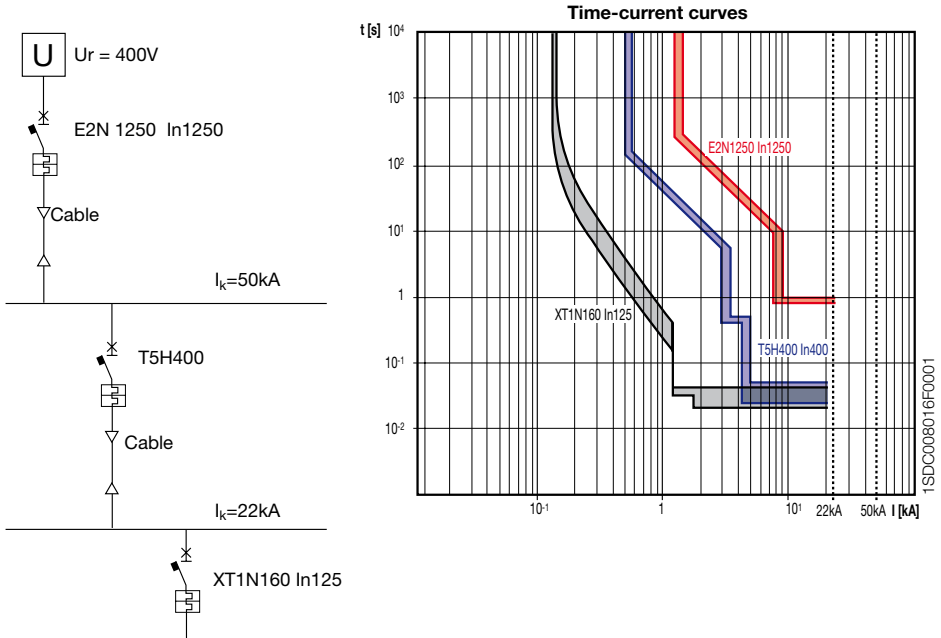

From the curves it is evident that between breakers E2N1250 and T5H400 time discrimination exists, while between breakers T5H400 and XT1N160 there is energy discrimination.

## 3 Protection coordination

### Index of discrimination tables

<b>MCB-MCB (230/240V)</b> .....	126
<b>MCCB (415V)-MCB (240V)</b> .....	128
<b>MCB-MCB (415V)</b>	
MCB-S2..B .....	130
MCB-S2..C .....	130
MCB-S2..D .....	132
MCB-S2..K .....	132
MCB-S2..Z .....	134
<b>MCCB-MCB (415V)</b>	
MCCB-S800 .....	136
MCCB-S2..B .....	138
MCCB-S2..C .....	140
MCCB-S2..D .....	142
MCCB-S2..K .....	144
MCCB-S2..Z .....	146
<b>MCCB-MCCB (415V)</b>	
MCCB-XT1 .....	148
MCCB-XT2 .....	150
MCCB-XT3 .....	152
MCCB-XT4 .....	152
MCCB-T5 .....	153
MCCB-T6 .....	153
<b>ACB-MCCB (415V)</b> .....	154
<b>MCCB-MCCB (400/415V)</b> .....	155

### 3 Protection coordination

#### MCB - SN @ 230/240 V

Load s. <sup>1</sup>	Char.	Supply s. <sup>2</sup>		S290				S800 N-S							
		I <sub>cu</sub> [kA]	C			D		B							
			I <sub>n</sub> [A]	80	100	125	80	100	15			36-50			
SN201L	B, C	6	2	Ⓟ	Ⓟ	Ⓟ	Ⓟ	Ⓟ	0,43 <sup>3</sup>	0,6	1,3	4	Ⓟ	Ⓟ	Ⓟ
			4	5	Ⓟ	Ⓟ	Ⓟ	Ⓟ		0,45	0,8	1,5	2,5	4	Ⓟ
			6	4,5	5	Ⓟ	5,5	Ⓟ			0,6	1,2	1,6	2,6	3,8
			10	4	4,5	5	5	5			0,5	1,1	1,4	2	3
			16	2,5	3,5	3,5	4	4,5			0,8	1,2	1,7	2,5	
			20	1,5	2,5	2,5	3	4,5				1	1,5	2,1	
			25	0,5	0,5	1,5	2	4					1,3	1,8	
			32	0,5	0,5	0,5	1,5	3,5					1,1	1,7	
			40	0,5	0,5	0,5	1,5	3,5						1,6	
SN201	B, C, D	10	2	6	8	9	7	8	0,43 <sup>3</sup>	0,6	1,3	4	9	Ⓟ	Ⓟ
			4	5	6	7,5	6	7		0,45	0,8	1,5	2,5	4	7,3
			6	4,5	5	6	5,5	6			0,6	1,2	1,6	2,6	3,8
			10	4	4,5	5	5	5			0,5	1,1	1,4	2	3
			16	2,5	3,5	3,5	4	4,5			0,8	1,2	1,7	2,5	
			20	1,5	2,5	2,5	3	4,5				1	1,5	2,1	
			25	0,5	0,5	1,5	2	4					1,3	1,8	
			32	0,5	0,5	0,5	1,5	3,5					1,1	1,7	
			40	0,5	0,5	0,5	1,5	3,5						1,6	
SN201M	B, C	10	2	6	8	9	7	8	0,43 <sup>3</sup>	0,6	1,3	4	9	Ⓟ	Ⓟ
			4	5	6	7,5	6	7		0,45	0,8	1,5	2,5	4	7,3
			6	4,5	5	6	5,5	6			0,6	1,2	1,6	2,6	3,8
			10	4	4,5	5	5	5			0,5	1,1	1,4	2	3
			16	2,5	3,5	3,5	4	4,5			0,8	1,2	1,7	2,5	
			20	1,5	2,5	2,5	3	4,5				1	1,5	2,1	
			25	0,5	0,5	1,5	2	4					1,3	1,8	
			32	0,5	0,5	0,5	1,5	3,5					1,1	1,7	
			40	0,5	0,5	0,5	1,5	3,5						1,6	

<sup>1</sup> Load side circuit-breaker 1P+N (230/240 V)

<sup>2</sup> For networks 230/240 V AC ⇒ two poles circuit-breaker (phase + neutral)

For networks 400/415 V AC ⇒ four poles circuit-breaker (load side circuit branched between one phase and the neutral)

<sup>3</sup> Only for curve B



### 3 Protection coordination

		S800 N-S							S800 N-S								
		C							D								
		36-50							36-50								
		25	32	40	50	63	80	100	125	25	32	40	50	63	80	100	125
	0,4 <sup>3</sup>	0,55	1,2	3	T	T	T	T		1,3	4,1	T	T	T	T	T	T
		0,43	0,75	1,3	2,1	3,9	T	T		0,8	1,6	3	5,4	T	T	T	T
			0,55	1,1	1,5	2,5	3,6	5,5		0,6	1,3	2	3,2	3,9	T	T	T
			0,45	1	1,3	1,9	2,8	4,2		0,5	1,2	1,65	2,6	3,1	T	T	T
				0,75	1,1	1,6	2,3	3,6			0,9	1,4	1,8	2,6	5	T	T
					0,9	1,4	1,9	3,3				1,3	1,6	2,2	4,2	5,4	T
						1,2	1,6	2,7					1,5	1,9	3,5	4,5	T
						1	1,5	2,5						1,8	2,8	4,2	5,5
							1,4	2,1						1,7	2,7	4	5
	0,4 <sup>3</sup>	0,55	1,2	3	6,6	T	T	T		1,3	4,1	T	T	T	T	T	T
		0,43	0,75	1,3	2,1	3,9	6,6	T		0,8	1,6	3	5,4	7,6	T	T	T
			0,55	1,1	1,5	2,5	3,6	5,5		0,6	1,3	2	3,2	3,9	8	T	T
			0,45	1	1,3	1,9	2,8	4,2		0,5	1,2	1,65	2,6	3,1	6,2	8,6	T
				0,75	1,1	1,6	2,3	3,6			0,9	1,4	1,8	2,6	5	6,3	8,8
					0,9	1,4	1,9	3,3				1,3	1,6	2,2	4,2	5,4	7,6
						1,2	1,6	2,7					1,5	1,9	3,5	4,5	6,6
						1	1,5	2,5						1,8	2,8	4,2	5,5
							1,4	2,1						1,7	2,7	4	5
	0,4 <sup>3</sup>	0,55	1,2	3	6,6	T	T	T		1,3	4,1	T	T	T	T	T	T
		0,43	0,75	1,3	2,1	3,9	6,6	T		0,8	1,6	3	5,4	7,6	T	T	T
			0,55	1,1	1,5	2,5	3,6	5,5		0,6	1,3	2	3,2	3,9	8	T	T
			0,45	1	1,3	1,9	2,8	4,2		0,5	1,2	1,65	2,6	3,1	6,2	8,6	T
				0,75	1,1	1,6	2,3	3,6			0,9	1,4	1,8	2,6	5	6,3	8,8
					0,9	1,4	1,9	3,3				1,3	1,6	2,2	4,2	5,4	7,6
						1,2	1,6	2,7					1,5	1,9	3,5	4,5	6,6
						1	1,5	2,5						1,8	2,8	4,2	5,5
							1,4	2,1						1,7	2,7	4	5

### 3 Protection coordination

#### MCCB @ 415 V 4p - SN @ 240 V

Load s.	Char.	$I_{cu}$ [kA]	$I_n$ [A]	Supply s.																
				XT1 160																
				B, C, N, S, H																
Release																				
TM																				
16	20	25	32	40	50	63	80	100	125 <sup>2</sup>	125	160 <sup>2</sup>	160	16	20	25	32				
SN201L	B, C	6	≤4	T	T	T	T	T	T	T	T	T	T	T	T	T	T			
			6	T	T	T	T	T	T	T	T	T	T	T	T	T	T	T		
			10			3	3	3	4,5	T	T	T	T	T	T		3'	3	3	
			16					3	4,5	5	T	T	T	T	T				3'	
			20						3	5	T	T	T	T	T				3'	
			25							5	T	T	T	T	T					
			32								T	T	T	T	T					
			40									T	T	T	T					
SN201	B, C, D	10	≤4	T	T	T	T	T	T	T	T	T	T	T	T	T	T			
			6	6	6	6	6	6	6	T	T	T	T	T	T	T	T	T		
			10			3	3	3	4,5	7,5	8,5	T	T	T	T	T		3'	3	3
			16					3	4,5	5	7,5	T	T	T	T				3'	
			20						3	5	6	T	T	T	T				3'	
			25							5	6	T	T	T	T					
			32								6	7,5	T	T	T					
			40									7,5	T	T	T					
SN201M	B, C	10	≤4	T	T	T	T	T	T	T	T	T	T	T	T	T	T			
			6	6	6	6	6	6	12	T	T	T	T	T	T	T	T	T		
			10			3	3	3	4,5	7,5	8,5	T	T	T	T		3'	3	3	
			16					3	4,5	5	7,5	T	T	T	T				3'	
			20						3	5	6	T	T	T	T				3'	
			25							5	6	T	T	T	T					
			32								6	T	T	T	T					
			40									T	T	T	T					

Supply side circuit-breaker 4P (load side circuit branched between one phase and the neutral)

Load side circuit-breaker 1P+N (230/240)

<sup>1</sup> Value valid only for magnetic only supply side circuit-breaker

<sup>2</sup> Value valid also with neutral 50%

### 3 Protection coordination

XT2 160										XT3 250															
N, S, H, L, V										N, S															
TM										EL				TM											
40	50	63	80	100	125 <sup>2</sup>	125	160 <sup>2</sup>	160	10	25	63	100	160	63	80	100	125 <sup>2</sup>	125	160 <sup>2</sup>	160	200 <sup>2</sup>	200	250 <sup>2</sup>	250	
T	T	T	T	T	T	T	T	T	T	T	T	T	T	T	T	T	T	T	T	T	T	T	T	T	T
T	T	T	T	T	T	T	T	T	T	T	T	T	T	T	T	T	T	T	T	T	T	T	T	T	T
3	4,5	T	T	T	T	T	T	T		T	T	T	T	T	T	T	T	T	T	T	T	T	T	T	T
3	4,5	5	T	T	T	T	T	T			T	T	T	5	T	T	T	T	T	T	T	T	T	T	T
	3	5	T	T	T	T	T	T			T	T	T	5	T	T	T	T	T	T	T	T	T	T	T
	3 <sup>1</sup>	5	T	T	T	T	T	T			T	T	T	5	T	T	T	T	T	T	T	T	T	T	T
	3 <sup>1</sup>		T	T	T	T	T	T			T	T	T		T	T	T	T	T	T	T	T	T	T	T
			T	T		T	T	T				T	T		T	T		T	T	T	T	T	T	T	T
T	T	T	T	T	T	T	T	T	T	T	T	T	T	T	T	T	T	T	T	T	T	T	T	T	T
T	T	T	T	T	T	T	T	T		T	T	T	T	T	T	T	T	T	T	T	T	T	T	T	T
3	4,5	7,5	8,5	T	T	T	T	T		T	T	T	T	7,5	8,5	T	T	T	T	T	T	T	T	T	T
3	4,5	5	7,5	T	7,5	T	T	T			T	T	T	5	7,5	T	7,5	T	T	T	T	T	T	T	T
	3	5	6	T	6	T	T	T			T	T	T	5	6	T	6	T	T	T	T	T	T	T	T
	3 <sup>1</sup>	5	6	T	6	T	T	T			T	T	T	5	6	T	6	T	T	T	T	T	T	T	T
	3 <sup>1</sup>		6	7,5	6	T	T	T			T	T	T		6	7,5	6	T	T	T	T	T	T	T	T
			6 <sup>1</sup>	7,5		T	T	T				T	T		6 <sup>1</sup>	7,5		T	T	T	T	T	T	T	T
T	T	T	T	T	T	T	T	T	T	T	T	T	T	T	T	T	T	T	T	T	T	T	T	T	T
T	T	T	T	T	T	T	T	T		T	T	T	T	T	T	T	T	T	T	T	T	T	T	T	T
3	4,5	7,5	8,5	T	T	T	T	T		T	T	T	T	7,5	8,5	T	T	T	T	T	T	T	T	T	T
3	4,5	5	7,5	T	7,5	T	T	T			T	T	T	5	7,5	T	7,5	T	T	T	T	T	T	T	T
	3	5	6	T	6	T	T	T			T	T	T	5	6	T	6	T	T	T	T	T	T	T	T
	3 <sup>1</sup>	5	6	T	6	T	T	T			T	T	T	5	6	T	6	T	T	T	T	T	T	T	T
	3 <sup>1</sup>		6	7,5	6	T	T	T			T	T	T		6	7,5	6	T	T	T	T	T	T	T	T
			6 <sup>1</sup>	7,5		T	T	T				T	T		6 <sup>1</sup>	7,5		T	T	T	T	T	T	T	T

### 3 Protection coordination

#### MCB - S2.. B @ 415 V

		Supply s.				S290		S800N-S					
Char.						D		B					
						15		36-50					
		I <sub>cu</sub> [kA]		I <sub>n</sub> [A]	80	100	40	50	63	80	100	125	
		10	15		25								
Load s.	B	-	-	-	≤2								
		-	-	-	3								
		-	-	-	4								
		S200	S200M	S200P	6	10,5	T	0,4	0,5	0,7	1	1,5	2,6
		S200	S200M	S200P	8	10,5	T		0,4	0,6	0,7	1	1,4
		S200	S200M	S200P	10	5	8		0,4	0,6	0,7	1	1,4
		S200	S200M	S200P	13	4,5	7			0,5	0,7	0,9	1,3
		S200	S200M	S200P	16	4,5	7				0,7	0,9	1,3
		S200	S200M	S200P	20	3,5	5					0,9	1,3
		S200	S200M	S200P	25	3,5	5					0,9	1,3
		S200	S200M-S200P	-	32		4,5					0,8	1,1
		S200	S200M-S200P	-	40							0,8	1,1
S200	S200M-S200P	-	50								1		
S200	S200M-S200P	-	63								0,9		

#### MCB - S2.. C @ 415 V

		Supply s.				S290		S800N-S						
Char.						D		B						
						15		36-50						
		I <sub>cu</sub> [kA]		I <sub>n</sub> [A]	80	100	32	40	50	63	80	100	125	
		10	15		25									
Load s.	C	S200	S200M	S200P	≤2	T	T	0,7	1,3	T	T	T	T	T
		S200	S200M	S200P	3	T	T		0,6	0,7	1,1	2,6	8,8	T
		S200	S200M	S200P	4	T	T		0,6	0,7	1	1,7	3,1	7
		S200	S200M	S200P	6	10,5	T		0,4	0,5	0,7	1	1,5	2,6
		S200	S200M	S200P	8	10,5	T			0,4	0,6	0,7	1	1,4
		S200	S200M	S200P	10	5	8			0,4	0,6	0,7	1	1,4
		S200	S200M	S200P	13	4,5	7				0,5	0,7	0,9	1,3
		S200	S200M	S200P	16	4,5	7					0,7	0,9	1,3
		S200	S200M	S200P	20	3,5	5						0,9	1,3
		S200	S200M	S200P	25	3,5	5						0,9	1,3
		S200	S200M-S200P	-	32		4,5						0,8	1,1
		S200	S200M-S200P	-	40								0,8	1,1
		S200	S200M-S200P	-	50									1
		S200	S200M-S200P	-	63									0,9

### 3 Protection coordination

S800N-S							S800N-S							
C							D							
36-50							36-50							
40	50	63	80	100	125	25	32	40	50	63	80	100	125	
0,4	0,5	0,7	1	1,5	2,6	0,5	1	1,2	2	2,8	9,9	21,3	Ⓣ	
	0,4	0,6	0,7	1	1,4	0,4	0,6	0,8	1,1	1,4	2,8	3,9	7,4	
	0,4	0,6	0,7	1	1,4	0,4	0,6	0,8	1,1	1,4	2,8	3,9	7,4	
		0,5	0,7	0,9	1,3	0,4	0,6	0,8	1,1	1,4	2,5	3,3	5,6	
			0,7	0,9	1,3		0,6	0,8	1,1	1,4	2,5	3,3	5,6	
				0,9	1,3			0,8	1,1	1,3	2,3	3	4,7	
				0,9	1,3			0,8	1,1	1,3	2,3	3	4,7	
				0,8	1,1			0,9	1,1	1,3	2,3	3	4,7	
				0,8	1,1				0,9	1,1	1,9	2,4	3,7	
					1					1,1	1,9	2,4	3,7	
					1						1,5	1,9	2,3	
					0,9							1,7	2,3	

S800N-S							S800N-S							
C							D							
36-50							36-50							
32	40	50	63	80	100	125	25	32	40	50	63	80	100	125
0,7	1,3	Ⓣ	Ⓣ	Ⓣ	Ⓣ	Ⓣ	Ⓣ	Ⓣ	Ⓣ	Ⓣ	Ⓣ	Ⓣ	Ⓣ	Ⓣ
	0,6	0,7	1,1	2,6	8,8	Ⓣ	0,7	2,2	4,4	Ⓣ	Ⓣ	Ⓣ	Ⓣ	Ⓣ
	0,6	0,7	1	1,7	3,1	7	0,7	1,3	2,2	4,4	7,7	Ⓣ	Ⓣ	Ⓣ
	0,4	0,5	0,7	1	1,5	2,6	0,5	1	1,2	2	2,8	9,9	22	Ⓣ
		0,4	0,6	0,7	1	1,4	0,4	0,6	0,8	1,1	1,4	2,8	3,9	7,4
		0,4	0,6	0,7	1	1,4	0,4	0,6	0,8	1,1	1,4	2,8	3,9	7,4
			0,5	0,7	0,9	1,3	0,4	0,6	0,8	1,1	1,4	2,5	3,3	5,6
				0,7	0,9	1,3		0,6	0,8	1,1	1,4	2,5	3,3	5,6
					0,9	1,3			0,8	1,1	1,3	2,3	3	4,7
					0,9	1,3			0,8	1,1	1,3	2,3	3	4,7
					0,8	1,1				0,9	1,1	1,9	2,4	3,7
					0,8	1,1					1,1	1,9	2,4	3,7
					1							1,5	1,9	2,3
					0,9								1,7	2,3

### 3 Protection coordination

#### MCB - S2.. D @ 415 V

Char.		Supply s.				S290		S800N-S							
		$I_{cu}$ [kA]				D		B							
						15		36-50							
Load s.	D	10	15	25	$I_n$ [A]	80	100	32	40	50	63	80	100	125	
		S200	-	S200P	≤2	⊕	⊕	0,5	0,7	2,1	⊕	⊕	⊕	⊕	
		S200	-	S200P	3	⊕	⊕		0,5	0,7	1,2	2,5	8,6	⊕	
		S200	-	S200P	4	⊕	⊕		0,4	0,7	1	1,7	3	7,7	
		S200	-	S200P	6	10,5	⊕			0,6	0,8	1,2	2	3,6	
		S200	-	S200P	8	10,5	⊕				0,7	0,9	1,3	2	
		S200	-	S200P	10	5	8					0,9	1,3	2	
		S200	-	S200P	13	3	5						1	1,5	
		S200	-	S200P	16	3	5							1,5	
		S200	-	S200P	20	3	5								
		S200	-	S200P	25		4								
		S200	S200P	-	32										
		S200	S200P	-	40										
		S200	S200P	-	50										
S200	S200P	-	63												

#### MCB - S2.. K @ 415 V

Char.		Supply s.				S290		S800N-S							
		$I_{cu}$ [kA]				D		B							
						15		36-50							
Load s.	K	10	15	25	$I_n$ [A]	80	100	32	40	50	63	80	100	125	
		S200	-	S200P	≤2	⊕	⊕	0,5	0,7	2,1	⊕	⊕	⊕	⊕	
		S200	-	S200P	3	⊕	⊕		0,5	0,7	1,2	2,5	8,6	⊕	
		S200	-	S200P	4	⊕	⊕		0,4	0,7	1	1,7	3	7,7	
		S200	-	S200P	6	10,5	⊕			0,6	0,8	1,2	2	3,6	
		S200	-	S200P	8	10,5	⊕				0,7	0,9	1,3	2	
		S200	-	S200P	10	5	8					0,9	1,3	2	
		-	-	S200P	13	3	5						1	1,5	
		S200	-	S200P	16	3	5							1,5	
		S200	-	S200P	20	3	5								
		S200	-	S200P	25		4								
		S200	S200P	-	32										
		S200	S200P	-	40										
		S200	S200P	-	50										
S200	S200P	-	63												

### 3 Protection coordination

S800N-S								S800N-S							
C								D							
36-50								36-50							
32	40	50	63	80	100	125	25	32	40	50	63	80	100	125	
0,5	0,7	2,1	T	T	T	T	2,3	T	T	T	T	T	T	T	
	0,5	0,7	1,2	2,5	8,6	T	0,7	1,3	4,4	T	T	T	T	T	
	0,4	0,7	1	1,7	3	7,7	0,7	1	2,2	4,4	7,7	T	T	T	
		0,6	0,8	1,2	2	3,6	0,6	0,8	1,5	2,5	3,6	12,1	24,2	T	
			0,7	0,9	1,3	2	0,5	0,7	1,1	1,5	2	4	5,5	9,9	
				0,9	1,3	2	0,5	0,7	1,1	1,5	2	4	5,5	9,9	
					1	1,5		0,6	0,9	1,2	1,5	2,6	3,4	5,2	
						1,5			0,9	1,2	1,5	2,6	3,4	5,2	
										0,9	1,1	1,8	2,2	3,2	
											1,1	1,8	2,2	3,2	
												1,7	2	2,9	
													1,9	2,6	
														2,2	

S800N-S								S800N-S							
C								D							
36-50								36-50							
32	40	50	63	80	100	125	25	32	40	50	63	80	100	125	
0,5	0,7	2,1	T	T	T	T	2,3	T	T	T	T	T	T	T	
	0,5	0,7	1,2	2,5	8,6	T	0,7	1,3	4,4	T	T	T	T	T	
	0,4	0,7	1	1,7	3	7,7	0,7	1	2,2	4,4	7,7	T	T	T	
		0,6	0,8	1,2	2	3,6	0,6	0,8	1,5	2,5	3,6	12,1	24,2	T	
			0,7	0,9	1,3	2	0,5	0,7	1,1	1,5	2	4	5,5	9,9	
				0,9	1,3	2	0,5	0,7	1,1	1,5	2	4	5,5	9,9	
					1	1,5		0,6	0,9	1,2	1,5	2,6	3,4	5,2	
						1,5			0,9	1,2	1,5	2,6	3,4	5,2	
										0,9	1,1	1,8	2,2	3,2	
											1,1	1,8	2,2	3,2	
												1,7	2	2,9	
													1,9	2,6	
														2,2	

### 3 Protection coordination

#### MCB - S2.. Z @ 415 V

Char.		Supply s.		S290		S800N-S									
		I <sub>cu</sub> [kA]		D		B									
				15		36-50									
Load s.	Z	10	15	25	I <sub>n</sub> [A]	80	100	32	40	50	63	80	100	125	
		S200	-	S200P	≤2	⊖	⊖	0,7	1,3	⊖	⊖	⊖	⊖	⊖	⊖
		S200	-	S200P	3	⊖	⊖		0,6	0,7	1,1	2,6	8,8	⊖	
		S200	-	S200P	4	⊖	⊖		0,6	0,7	1	1,7	3,1	7	
		S200	-	S200P	6	10,5	⊖		0,4	0,5	0,7	1	1,5	2,6	
		S200	-	S200P	8	10,5	⊖			0,4	0,6	0,7	1	1,4	
		S200	-	S200P	10	5	8			0,4	0,6	0,7	1	1,4	
		-	-	S200P	13	4,5	7					0,7	0,9	1,3	
		S200	-	S200P	16	4,5	7					0,7	0,9	1,3	
		S200	-	S200P	20	3,5	5						0,9	1,3	
		S200	-	S200P	25	3,5	5						0,9	1,3	
		S200	S200P	-	32	3	4,5						0,8	1,1	
		S200	S200P	-	40	3	4,5						0,8	1,1	
		S200	S200P	-	50		3							1	
S200	S200P	-	63										0,9		



### 3 Protection coordination

S800N-S								S800N-S							
C								D							
36-50								36-50							
32	40	50	63	80	100	125	25	32	40	50	63	80	100	125	
0,7	1,3	T	T	T	T	T	T	T	T	T	T	T	T	T	
	0,6	0,7	1,1	2,6	8,8	T	0,7	2,2	4,4	T	T	T	T	T	
	0,6	0,7	1	1,7	3,1	7	0,7	1,3	2,2	4,4	7,7	T	T	T	
	0,4	0,5	0,7	1	1,5	2,6	0,5	1	1,2	2	2,8	9,9	22	T	
		0,4	0,6	0,7	1	1,4	0,4	0,6	0,8	1,1	1,4	2,8	3,9	7,4	
		0,4	0,6	0,7	1	1,4	0,4	0,6	0,8	1,1	1,4	2,8	3,9	7,4	
				0,7	0,9	1,3		0,6	0,8	1,1	1,4	2,5	3,3	5,6	
				0,7	0,9	1,3		0,6	0,8	1,1	1,4	2,5	3,3	5,6	
					0,9	1,3			0,8	1,1	1,3	2,3	3	4,7	
					0,9	1,3			0,8	1,1	1,3	2,3	3	4,7	
					0,8	1,1			0,9	1,1	1,1	1,9	2,4	3,7	
					0,8	1,1				1,1	1,1	1,9	2,4	3,7	
						1						1,5	1,9	2,3	
						0,9							1,7	2,3	

### 3 Protection coordination

#### MCCB - S800 @ 415 V

Load s.	Char.	I <sub>cu</sub> [kA]	Supply s.		XT1 160								XT3 250							
			Version	B, C, N, S, H											N, S					
			Release	TM																
			I <sub>n</sub> [A]	25	32	40	50	63	80	100	125	160	63	80	100	125	160	200	250	
S800N	B C D	36	10	4,5	4,5	4,5	4,5	8	10	20 <sup>1</sup>	25 <sup>1</sup>	T	8	10	20 <sup>1</sup>	25 <sup>1</sup>	T	T	T	
			13		4,5	4,5	4,5	7,5	10	15	25 <sup>1</sup>	T	7,5	10	15	25 <sup>1</sup>	T	T	T	
			16			4,5	4,5	7,5	10	15	25 <sup>1</sup>	T	7,5	10	15	25 <sup>1</sup>	T	T	T	
			20				4,5	7,5	10	15	25 <sup>1</sup>	T	7,5	10	15	25 <sup>1</sup>	T	T	T	
			25					6	10	15	20 <sup>1</sup>	T	6	10	15	20 <sup>1</sup>	T	T	T	
			32						7,5	10	20 <sup>1</sup>	T		7,5	10	20 <sup>1</sup>	T	T	T	
			40							10	20 <sup>1</sup>	T			10	20 <sup>1</sup>	T	T	T	
			50								15	T				15	T	T	T	
			63									T					T	T	T	
			80									T <sup>2</sup>						T	T	
			100																T	T
			125																	T <sup>2</sup>
S800S	B C D K	50	10	4,5	4,5	4,5	4,5	8	10	20 <sup>1</sup>	25 <sup>1</sup>	T	8	10	20 <sup>1</sup>	25 <sup>1</sup>	36	36	T	
			13		4,5	4,5	4,5	7,5	10	15	25 <sup>1</sup>	T	7,5	10	15	25 <sup>1</sup>	36	36	T	
			16			4,5	4,5	7,5	10	15	25 <sup>1</sup>	T	7,5	10	15	25 <sup>1</sup>	36	36	T	
			20				4,5	7,5	10	15	25 <sup>1</sup>	T	7,5	10	15	25 <sup>1</sup>	36	36	T	
			25					6	10	15	20 <sup>1</sup>	T	6	10	15	20 <sup>1</sup>	36	36	T	
			32						7,5	10	20 <sup>1</sup>	T		7,5	10	20 <sup>1</sup>	36	36	T	
			40							10	20 <sup>1</sup>	T			10	20 <sup>1</sup>	36	36	T	
			50								15	T				15	36	36	T	
			63									T					36	36	T	
			80									T <sup>2</sup>						36	T	
			100																T	T
			125																	T <sup>2</sup>

- 1 Select the lowest value between what is indicated and the breaking capacity of the supply side circuit-breaker
- 2 Value valid only with S800N/S B or C characteristic

### 3 Protection coordination

#### MCCB-S800 @ 415 V

Load s.	Carat.	I <sub>cu</sub> [kA]	Supply s.	XT4												T4 - T5		
			Version	N, S, H, L, V														
			Release	TM												EL		EL
			I <sub>n</sub> [A]	20	25	32	40	50	63	80	100	125	160	200÷250	40÷63	100÷250	100÷630	
S800 N/S	B	36-50	10	6,5	6,5	6,5	6,5	6,5	6,5	6,5	11	T	T	T	T	6,5	T	T
			13	6,5	5	6,5	6,5	6,5	6,5	11	T	T	T	T	6,5	T	T	
			16		5	6,5	6,5	6,5	6,5	11	T	T	T	T	6,5	T	T	
			20			6,5 <sup>1</sup>	6,5	6,5	6,5	11	T	T	T	T	6,5	T	T	
			25				6,5	6,5	6,5	11	T	T	T	T	6,5	T	T	
			32					6,5	6,5	8	T	T	T	T	6,5	T	T	
			40					5 <sup>1</sup>	6,5	T	T	T	T		T	T		
			50						5 <sup>1</sup>	7,5	T	T	T		T	T		
			63							5 <sup>1</sup>	7	T	T		T	T		
			80								T <sup>1</sup>	T	T		T <sup>2</sup>	T <sup>2</sup>		
			100									T <sup>1</sup>	T		T <sup>2</sup>	T <sup>2</sup>		
			125										T		T <sup>2,3</sup>	T <sup>2,3</sup>		
	C	36-50	10	6,5	6,5	6,5	6,5	6,5	6,5	11	T	T	T	T	6,5	T	T	
			13	6,5	5	6,5	6,5	6,5	6,5	11	T	T	T	T	6,5	T	T	
			16	5 <sup>1</sup>	5	6,5	6,5	6,5	6,5	11	T	T	T	T	6,5	T	T	
			20			6,5 <sup>1</sup>	6,5	6,5	6,5	11	T	T	T	T	6,5	T	T	
			25				6,5	6,5	6,5	11	T	T	T	T	6,5	T	T	
			32					6,5	6,5	8	T	T	T	T	6,5	T	T	
			40						6,5	T	T	T	T		T	T		
			50						5 <sup>1</sup>	7,5	T	T	T		T	T		
			63							6,5 <sup>1</sup>	7	T	T		T	T		
			80								6,5 <sup>1</sup>	6,5	T		T <sup>2</sup>	T <sup>2</sup>		
			100									5 <sup>1</sup>	6,5		T <sup>2</sup>	T <sup>2</sup>		
			125												T <sup>2,3</sup>	T <sup>2,3</sup>		
	D	36-50	10	6,5	6,5	6,5	6,5	6,5	6,5	11	T	T	T	T	6,5	T	T	
			13	6,5	5	6,5	6,5	6,5	6,5	11	T	T	T	T	6,5	T	T	
			16				6,5	6,5	6,5	11	T	T	T	T	6,5	T	T	
			20						11	T	T	T	T		T	T		
			25						11	T	T	T	T		T	T		
			32							T	T	T	T		T	T		
			40								T	T	T		T	T		
			50									T	T		T	T		
			63										T		T	T		
			80												T <sup>2</sup>	T <sup>2</sup>		
			100												T <sup>2</sup>	T <sup>2</sup>		
			125												T <sup>2,3</sup>	T <sup>2,3</sup>		
	K	36-50	10	6,5 <sup>1</sup>		6,5	6,5	6,5	6,5	11	T	T	T	T	6,5	T	T	
			13	5 <sup>1</sup>		5 <sup>1</sup>	6,5	6,5	6,5	11	T	T	T	T	6,5	T	T	
			16				6,5	6,5	6,5	11	T	T	T	T	6,5	T	T	
			20					6,5	6,5	11	T	T	T	T	6,5	T	T	
			25					6,5 <sup>1</sup>		11 <sup>1</sup>	T	T	T	T		T	T	
			32							8 <sup>1</sup>	T <sup>1</sup>	T	T	T		T	T	
			40							6,5 <sup>1</sup>	T <sup>1</sup>	T <sup>1</sup>	T	T		T	T	
			50								7,5 <sup>1</sup>	T <sup>1</sup>	T <sup>1</sup>	T		T	T	
			63									7 <sup>1</sup>	T <sup>1</sup>	T <sup>1</sup>		T	T	
			80										T <sup>1</sup>	T <sup>1</sup>		T <sup>2</sup>	T <sup>2</sup>	
			100											7 <sup>1</sup>		T <sup>2</sup>	T <sup>2</sup>	
			125											6,5 <sup>1</sup>		T <sup>2,3</sup>	T <sup>2,3</sup>	

<sup>1</sup> Value valid only for magnetic only supply side circuit-breaker (for I<sub>n</sub> = 50 A, please consider MA52 circuit-breaker)

<sup>2</sup> For T4 I<sub>n</sub> = 100 A, value valid only for magnetic only supply

<sup>3</sup> For T4 I<sub>n</sub> = 160 A, value valid only for magnetic only supply

### 3 Protection coordination

#### MCCB - S2.. B @ 415 V

		Supply s.		XT2	XT1 - XT2								XT1 - XT2 - XT3					XT3				
Char.		I <sub>cu</sub> [kA]			Version	B, C, N, S, H, L, V																
		Release			TM																	
		10	15	25	I <sub>n</sub> [A]	12,5	16	20	25	32	40	50	63	80	100	125	160	200	250			
Load s.	B	S200	S200M	S200P	6	5,5 <sup>1</sup>	5,5	5,5	5,5	5,5	5,5	5,5	10,5	T	T	T	T	T	T			
		S200	S200M	S200P	10			3 <sup>1</sup>	3	3	3	4,5	7,5	8,5	17	T	T	T	T			
		S200	S200M	S200P	13			3 <sup>1</sup>		3	3	4,5	7,5	7,5	12	20	T	T	T	T		
		S200	S200M	S200P	16					3 <sup>1</sup>	3	4,5	5	7,5	12	20	T	T	T			
		S200	S200M	S200P	20					3 <sup>1</sup>		3	5	6	10	15	T	T	T			
		S200	S200M	S200P	25							3 <sup>1</sup>	5	6	10	15	T	T	T			
		S200	S200M-S200P	-	32							3 <sup>1</sup>		6	7,5	12	T	T	T			
		S200	S200M-S200P	-	40									5,5 <sup>1</sup>	7,5	12	T	T	T			
		S200	S200M-S200P	-	50									3 <sup>1</sup>	5 <sup>2</sup>	7,5	10,5	T	T			
		S200	S200M-S200P	-	63										5 <sup>2</sup>	6 <sup>3</sup>	10,5	T	T			
		-	-	-	80																	
		-	-	-	100																	
-	-	-	125																			

<sup>1</sup> Value valid only for XT2 magnetic only supply side circuit-breaker

<sup>2</sup> Value valid only for XT2-XT3 magnetic only supply side circuit-breaker

<sup>3</sup> Value valid only for XT3 magnetic only supply side circuit-breaker

<sup>4</sup> Value valid only for XT4 magnetic only supply side circuit-breaker

### 3 Protection coordination

XT4														T5	XT2				XT4				T4	T5			
B, C, N, S, H, L, V																											
TM														EL													
20	25	32	40	50	63	80	100	125	160	200	225	250	320÷500	25	63	100	160	40	63	100, 160	250	320	320÷630				
7,5 <sup>4</sup>	7,5	7,5	7,5	7,5	10,5	T	T	T	T	T	T	T	T	T	T	T	T	T	T	T	T	T	T				
5 <sup>4</sup>	5	5	5	6,5	7,5	9	T	T	T	T	T	T	T	T	T	T	T	T	T	T	T	T	T				
	5	5	5	6,5	7,5	8	T	T	T	T	T	T	T	T	T	T	T	T	T	T	T	T	T				
	3	5	5	6,5	7,5	8	T	T	T	T	T	T	T		T	T	T	T	T	T	T	T	T				
			5	5	5	7,5	T	T	T	T	T	T	T		T	T	T	T	T	T	T	T	T				
				5	5	7,5	T	T	T	T	T	T	T		T	T	T		T	T	T	T	T				
				5 <sup>4</sup>	5	7,5	T	T	T	T	T	T	T		T	T	T		T	T	T	T	T				
						6,5	T	T	T	T	T	T	T			T	T			T	T	T	T				
						5 <sup>4</sup>	T	T	T	T	T	T	T			10,5	10,5			T	T	T	T				
							T <sup>4</sup>	T <sup>4</sup>	T	T	T	T	T			10,5				T	T	T	T				

### 3 Protection coordination

#### MCCB - S2.. C @ 415 V

Char.	I <sub>cu</sub> [kA]			Supply s.	XT2	XT1 - XT2						XT1 - XT2 - XT3						XT3						
				Version	B, C, N, S, H, L, V																			
				Release	TM																			
				I <sub>n</sub> [A]	12,5	16	20	25	32	40	50	63	80	100	125	160	200	250						
Load s.	C	S200	S200M	S200P	≤2	⊕	⊕	⊕	⊕	⊕	⊕	⊕	⊕	⊕	⊕	⊕	⊕	⊕	⊕	⊕	⊕			
		S200	S200M	S200P	3	⊕	⊕	⊕	⊕	⊕	⊕	⊕	⊕	⊕	⊕	⊕	⊕	⊕	⊕	⊕	⊕	⊕		
		S200	S200M	S200P	4	⊕	⊕	⊕	⊕	⊕	⊕	⊕	⊕	⊕	⊕	⊕	⊕	⊕	⊕	⊕	⊕	⊕	⊕	
		S200	S200M	S200P	6	5,5 <sup>1</sup>	5,5	5,5	5,5	5,5	5,5	5,5	5,5	10,5	⊕	⊕	⊕	⊕	⊕	⊕	⊕	⊕	⊕	
		S200	S200M	S200P	8			5,5	5,5	5,5	5,5	5,5	10,5	⊕	⊕	⊕	⊕	⊕	⊕	⊕	⊕	⊕	⊕	
		S200	S200M	S200P	10			3 <sup>1</sup>	3	3	3	4,5	7,5	8,5	17	⊕	⊕	⊕	⊕	⊕	⊕	⊕	⊕	
		S200	S200M	S200P	13			3 <sup>1</sup>		3	3	4,5	7,5	7,5	12	20	⊕	⊕	⊕	⊕	⊕	⊕	⊕	
		S200	S200M	S200P	16					3 <sup>1</sup>	3	4,5	5	7,5	12	20	⊕	⊕	⊕	⊕	⊕	⊕	⊕	
		S200	S200M	S200P	20					3 <sup>1</sup>		3	5	6	10	15	⊕	⊕	⊕	⊕	⊕	⊕	⊕	
		S200	S200M	S200P	25							3 <sup>1</sup>	5	6	10	15	⊕	⊕	⊕	⊕	⊕	⊕	⊕	
		S200	S200M-S200P	-	32							3 <sup>1</sup>	6	7,5	12	⊕	⊕	⊕	⊕	⊕	⊕	⊕	⊕	
		S200	S200M-S200P	-	40								5,5 <sup>1</sup>	7,5	12	⊕	⊕	⊕	⊕	⊕	⊕	⊕	⊕	
		S200	S200M-S200P	-	50								3 <sup>1</sup>	5 <sup>2</sup>	7,5	10,5	⊕	⊕	⊕	⊕	⊕	⊕	⊕	
		S200	S200M-S200P	-	63									5 <sup>2</sup>	6 <sup>3</sup>	10,5	⊕	⊕	⊕	⊕	⊕	⊕	⊕	
		-	S290	-	80																	10	15	
-	S290	-	100																	7,5 <sup>3</sup>	15			
-	S290	-	125																	7,5 <sup>3</sup>				

<sup>1</sup> Value valid only for XT2 magnetic only supply side circuit-breaker

<sup>2</sup> Value valid only for XT2-XT3 magnetic only supply side circuit-breaker

<sup>3</sup> Value valid only for XT3 magnetic only supply side circuit-breaker

<sup>4</sup> Value valid only for XT4 magnetic only supply side circuit-breaker

<sup>5</sup> Value valid only for XT4 In160 supply side circuit-breaker

### 3 Protection coordination

XT4														T5	XT2					XT4				T4	T5		
B, C, N, S, H, L, V																											
TM														EL													
20	25	32	40	50	63	80	100	125	160	200	225	250	320÷500	10	25	63	100	160	40	63	100	160	250	320	320÷630		
T	T	T	T	T	T	T	T	T	T	T	T	T	T	T	T	T	T	T	T	T	T	T	T	T	T		
T	T	T	T	T	T	T	T	T	T	T	T	T	T	T	T	T	T	T	T	T	T	T	T	T	T		
T	T	T	T	T	T	T	T	T	T	T	T	T	T	T	T	T	T	T	T	T	T	T	T	T	T		
7,5	7,5	7,5	7,5	7,5	10,5	T	T	T	T	T	T	T	T	T	T	T	T	T	T	T	T	T	T	T	T		
7,5	7,5	7,5	7,5	7,5	10,5	T	T	T	T	T	T	T	T	T	T	T	T	T	T	T	T	T	T	T	T		
5	5	5	5	6,5	7,5	9	T	T	T	T	T	T	T	T	T	T	T	T	T	T	T	T	T	T	T		
	5	5	5	6,5	7,5	8	T	T	T	T	T	T	T	T	T	T	T	T	T	T	T	T	T	T	T		
	3	5	5	6,5	5	8	T	T	T	T	T	T	T	T	T	T	T	T	T	T	T	T	T	T	T		
			5	5	5	7,5	T	T	T	T	T	T	T	T	T	T	T	T	T	T	T	T	T	T	T		
				5	5	7,5	T	T	T	T	T	T	T	T	T	T	T	T	T	T	T	T	T	T	T		
				5 <sup>4</sup>	5	7,5	T	T	T	T	T	T	T	T	T	T	T	T	T	T	T	T	T	T	T		
					6,5	T	T	T	T	T	T	T	T	T	T	T	T	T	T	T	T	T	T	T	T		
					5 <sup>4</sup>	T	T	T	T	T	T	T	T	T	T	T	T	T	T	T	T	T	T	T	T		
						T <sup>4</sup>	T <sup>4</sup>	T	T	T	T	T	T	T	T	T	T	T	T	T	T	T	T	T	T		
								5	11	T	T	T	T	T	T	T	T	T	T	T	T	T	T	T	T		
								5 <sup>4</sup>	8	T	T	T	T	T	T	T	T	T	T	T	T	T	T	T	T		
								8 <sup>4</sup>	12 <sup>4</sup>	12	T	T	T	T	T	T	T	T	T	T	T	T	T	T	T		
																	4						T <sup>5</sup>	T	T		
																	4						12 <sup>4</sup>	T	T		
																	4							T	T		
																	4							T	T		

## 3 Protection coordination

### MCCB - S2.. D @ 415 V

Char.	$I_{cu}$ [kA]			Supply s.	XT2	XT1 - XT2						XT1 - XT2 - XT3					XT3		
				Version	B, C, N, S, H, L, V														
				Release	TM														
10	15	25	$I_n$ [A]	12,5	16	20	25	32	40	50	63	80	100	125	160	200	250		
Load s.	D	S200	S200M	S200P	≤2	T	T	T	T	T	T	T	T	T	T	T	T	T	T
		S200	S200M	S200P	3	T	T	T	T	T	T	T	T	T	T	T	T	T	T
		S200	S200M	S200P	4	T	T	T	T	T	T	T	T	T	T	T	T	T	T
		S200	S200M	S200P	6	5,5 <sup>1</sup>	5,5	5,5	5,5	5,5	5,5	5,5	10,5	T	T	T	T	T	T
		S200	S200M	S200P	8			5,5	5,5	5,5	5,5	5,5	10,5	12	T	T	T	T	T
		S200	S200M	S200P	10			3 <sup>1</sup>	3	3	3	3	5	8,5	17	T	T	T	T
		S200	S200M	S200P	13					2 <sup>1</sup>	2	2	3	5	8	13,5	T	T	T
		S200	S200M	S200P	16					2 <sup>1</sup>	2	2	3	5	8	13,5	T	T	T
		S200	S200M	S200P	20					2 <sup>1</sup>		2	3	4,5	6,5	11	T	T	T
		S200	S200M	S200P	25							2 <sup>1</sup>	2,5	4	6	9,5	T	T	T
		S200	S200M-S200P	-	32									4	6	9,5	T	T	T
		S200	S200M-S200P	-	40									3 <sup>1</sup>	5 <sup>2</sup>	8	T	T	T
		S200	S200M-S200P	-	50									2 <sup>1</sup>	3 <sup>2</sup>	5	9,5	T	T
		S200	S200M-S200P	-	63										3 <sup>2</sup>	5 <sup>3</sup>	9,5	T	T
		-	S290	-	80												4 <sup>3</sup>	10	15
-	S290	-	100												4 <sup>3</sup>	7,5 <sup>3</sup>	15		
-	-	-	125																

<sup>1</sup> Value valid only for XT2 magnetic only supply side circuit-breaker

<sup>2</sup> Value valid only for XT2-XT3 magnetic only supply side circuit-breaker

<sup>3</sup> Value valid only for XT3 magnetic only supply side circuit-breaker

<sup>4</sup> Value valid only for XT4 magnetic only supply side circuit-breaker

<sup>5</sup> Value valid only for XT4 In160 supply side circuit-breaker



### 3 Protection coordination

XT4														T5	XT2						XT4		T4	T5		
B, C, N, S, H, L, V																										
TM														EL												
20	25	32	40	50	63	80	100	125	160	200	225	250	320÷500	10	25	63	100	160	40	63	100, 160	250	320	320÷630		
T	T	T	T	T	T	T	T	T	T	T	T	T	T	T	T	T	T	T	T	T	T	T	T	T	T	
T	T	T	T	T	T	T	T	T	T	T	T	T	T	T	T	T	T	T	T	T	T	T	T	T	T	
T	T	T	T	T	T	T	T	T	T	T	T	T	T	T	T	T	T	T	T	T	T	T	T	T	T	
7,5	7,5	7,5	7,5	7,5	7,5	7,5	T	T	T	T	T	T	T	T	T	T	T	T	T	T	T	T	T	T	T	
7,5	7,5	7,5	7,5	7,5	7,5	7,5	T	T	T	T	T	T	T	T	T	T	T	T	T	T	T	T	T	T	T	
5 <sup>4</sup>	5	5	5	5	6	9	T	T	T	T	T	T	T	T	T	T	T	T	T	T	T	T	T	T	T	
	5 <sup>4</sup>		5	4	5	5,5	T	T	T	T	T	T	T	T	T	T	T	T	T	T	T	T	T	T	T	
			5 <sup>4</sup>	4	5	5,5	T	T	T	T	T	T	T	T	T	T	T	T	T	T	T	T	T	T	T	
			5 <sup>4</sup>	4 <sup>4</sup>	5	5	T	T	T	T	T	T	T	T	T	T	T	T	T	T	T	T	T	T	T	
				4 <sup>4</sup>	4 <sup>4</sup>	4,5	T	T	T	T	T	T	T	T	T	T	T	T	T	T	T	T	T	T	T	
					5 <sup>4</sup>	4,5 <sup>4</sup>	T	T	T	T	T	T	T	T	T	T	T	T	T	T	T	T	T	T	T	
						4,5 <sup>4</sup>	T	T	T	T	T	T	T	T	T	T	T	T	T	T	T	T	T	T	T	
							T <sup>4</sup>	T	T	T	T	T	T	T	T	T	T	T	T	T	T	T	T	T	T	
								T <sup>4</sup>	T <sup>4</sup>	T	T	T	T	T	T	T	T	T	T	T	T	T	T	T	T	
									5	11	T	T	T	T	T	T	T	T	T	T	T	T	T	T	T	
										8	T	T	T	T	T	T	T	T	T	T	T	T	T	T	T	
																	9,5	9,5			T	T	T	T	T	
																					T	T	T	T	T	
																						T <sup>5</sup>	T	T	T	
																							12 <sup>5</sup>	T	T	

### 3 Protection coordination

#### MCCB - S2.. K @ 415 V

Char.	I <sub>cu</sub> [kA]			Supply s.	XT2	XT1 - XT2					XT1 - XT2 - XT3					XT3				
				Version	B, C, N, S, H, L, V															
				Release	TM															
10	15	25	I <sub>n</sub> [A]	12,5	16	20	25	32	40	50	63	80	100	125	160	200	250			
Load s.	K	S200	S200M	S200P	≤2	T	T	T	T	T	T	T	T	T	T	T	T	T		
		S200	S200M	S200P	3	T	T	T	T	T	T	T	T	T	T	T	T	T	T	
		S200	S200M	S200P	4	T	T	T	T	T	T	T	T	T	T	T	T	T	T	
		S200	S200M	S200P	6	5,5 <sup>1</sup>	5,5	5,5	5,5	5,5	5,5	5,5	10,5	T	T	T	T	T	T	
		S200	S200M	S200P	8			5,5	5,5	5,5	5,5	5,5	10,5	12	T	T	T	T	T	
		S200	S200M	S200P	10			3 <sup>1</sup>	3	3	3	3	5	8,5	17	T	T	T	T	
		S200	S200M	S200P	13					2 <sup>1</sup>	3	3	5	7,5	10	13,5	T	T	T	
		S200	S200M	S200P	16					2 <sup>1</sup>	3	3	4,5	7,5	10	13,5	T	T	T	
		S200	S200M	S200P	20					2 <sup>1</sup>		3	3,5	5,5	6,5	11	T	T	T	
		S200	S200M	S200P	25							2 <sup>1</sup>	3,5	5,5	6	9,5	T	T	T	
		S200	S200M-S200P	-	32									4,5	6	9,5	T	T	T	
		S200	S200M-S200P	-	40									3 <sup>1</sup>	5	8	T	T	T	
		S200	S200M-S200P	-	50									2 <sup>1</sup>	3 <sup>2</sup>	6	9,5	T	T	
		S200	S200M-S200P	-	63										3 <sup>2</sup>	5 <sup>3</sup>	9,5	T	T	
		-	S290	-	80												4 <sup>3</sup>	10	15	
-	S290	-	100												4 <sup>3</sup>	7,5 <sup>3</sup>	15			
-	-	-	125																	

- <sup>1</sup> Value valid only for XT2 magnetic only supply side circuit-breaker
- <sup>2</sup> Value valid only for XT2-XT3 magnetic only supply side circuit-breaker
- <sup>3</sup> Value valid only for XT3 magnetic only supply side circuit-breaker
- <sup>4</sup> Value valid only for XT4 magnetic only supply side circuit-breaker
- <sup>5</sup> Value valid only for XT4 In160 supply side circuit-breaker

### 3 Protection coordination

XT4													T5	XT2					XT4			T4	T5	
B, C, N, S, H, L, V																								
TM													EL											
20	25	32	40	50	63	80	100	125	160	200	225	250	320÷500	10	25	63	100	160	40	63	100, 160	250	320	320÷630
T	T	T	T	T	T	T	T	T	T	T	T	T	T	T	T	T	T	T	T	T	T	T	T	T
T	T	T	T	T	T	T	T	T	T	T	T	T	T	T	T	T	T	T	T	T	T	T	T	T
7,5	7,5	7,5	7,5	7,5	8	T	T	T	T	T	T	T	T	T	T	T	T	T	T	T	T	T	T	T
7,5 <sup>4</sup>	7,5	7,5	7,5	7,5	8	T	T	T	T	T	T	T	T	T	T	T	T	T	T	T	T	T	T	T
	5 <sup>4</sup>	5	5	5	7,5	9	T	T	T	T	T	T	T	T	T	T	T	T	T	T	T	T	T	T
	5 <sup>4</sup>	5	5	5	7,5	8	T	T	T	T	T	T	T	T	T	T	T	T	T	T	T	T	T	T
					5	6	8	T	T	T	T	T	T			T	T	T	T	T	T	T	T	T
					5	6	6	T	T	T	T	T	T			T	T	T	T	T	T	T	T	T
					5 <sup>4</sup>	5,5 <sup>4</sup>	6 <sup>4</sup>	T	T	T	T	T	T			T	T	T		T	T	T	T	T
					5 <sup>4</sup>	5 <sup>4</sup>	6 <sup>4</sup>	T	T	T	T	T	T			T			T	T	T	T	T	T
						5 <sup>4</sup>	5,5 <sup>4</sup>	T	T	T	T	T	T				T	T		T	T	T	T	T
							5 <sup>4</sup>	T	T	T	T	T	T				9,5	9,5		T	T	T	T	T
								T	T	T	T	T	T					9,5		T	T	T	T	T
									5	11	T	T	T					4		T	<sup>5</sup> T	T	T	T
									5 <sup>4</sup>	8	T	T	T					4			12 <sup>5</sup>	T	T	T

### 3 Protection coordination

#### MCCB - S2.. Z @ 415 V

Char.	$I_{cu}$ [kA]			Supply s.	XT2	XT1 - XT2					XT1 - XT2 - XT3					XT3					
				Version	B, C, N, S, H, L, V																
				Release	TM																
				$I_n$ [A]	12,5	16	20	25	32	40	50	63	80	100	125	160	200	250			
Load s.	Z	S200	S200M	S200P	≤2	T	T	T	T	T	T	T	T	T	T	T	T	T	T	T	
		S200	S200M	S200P	3	T	T	T	T	T	T	T	T	T	T	T	T	T	T	T	T
		S200	S200M	S200P	4	T	T	T	T	T	T	T	T	T	T	T	T	T	T	T	T
		S200	S200M	S200P	6	5,5 <sup>1</sup>	5,5	5,5	5,5	5,5	5,5	5,5	5,5	10,5	T	T	T	T	T	T	T
		S200	S200M	S200P	8			5,5	5,5	5,5	5,5	5,5	10,5	T	T	T	T	T	T	T	T
		S200	S200M	S200P	10			3 <sup>1</sup>	3	3	3	4,5	8	8,5	17	T	T	T	T	T	T
		S200	S200M	S200P	16					3 <sup>1</sup>	3	4,5	5	7,5	12	20	T	T	T	T	T
		S200	S200M	S200P	20					3 <sup>1</sup>		3	5	6	10	15	T	T	T	T	T
		S200	S200M	S200P	25							3 <sup>1</sup>	5	6	10	15	T	T	T	T	T
		S200	S200M-S200P	-	32							3 <sup>1</sup>		6	7,5	12	T	T	T	T	T
		S200	S200M-S200P	-	40									5,5 <sup>1</sup>	7,5	12	T	T	T	T	T
		S200	S200M-S200P	-	50									4 <sup>1</sup>	5 <sup>2</sup>	7,5	10,5	T	T	T	T
		S200	S200M-S200P	-	63										5 <sup>2</sup>	6 <sup>3</sup>	10,5	T	T	T	T
		-	-	-	80																
		-	-	-	100																
-	-	-	125																		

- <sup>1</sup> Value valid only for XT2 magnetic only supply side circuit-breaker  
<sup>2</sup> Value valid only for XT2-XT3 magnetic only supply side circuit-breaker  
<sup>3</sup> Value valid only for XT3 magnetic only supply side circuit-breaker  
<sup>4</sup> Value valid only for XT4 magnetic only supply side circuit-breaker

### 3 Protection coordination

XT4													T5	XT2					XT4				T4	T5	
B, C, N, S, H, L, V																									
TM													EL												
20	25	32	40	50	63	80	100	125	160	200	225	250	320÷500	10	25	63	100	160	40	63	100, 160	250	320	320÷630	
T	T	T	T	T	T	T	T	T	T	T	T	T	T	T	T	T	T	T	T	T	T	T	T		
T	T	T	T	T	T	T	T	T	T	T	T	T	T	T	T	T	T	T	T	T	T	T	T	T	
T	T	T	T	T	T	T	T	T	T	T	T	T	T	T	T	T	T	T	T	T	T	T	T	T	
7,5	7,5	7,5	7,5	7,5	7,5	7,5	T	T	T	T	T	T	T	T	T	T	T	T	T	T	T	T	T	T	
7,5	7,5	7,5	7,5	7,5	7,5	7,5	T	T	T	T	T	T	T	T	T	T	T	T	T	T	T	T	T	T	
5	7,5	5	5	6,5	6,5	9	T	T	T	T	T	T	T	T	T	T	T	T	T	T	T	T	T	T	
	7,5 <sup>4</sup>	4,5	5	6,5	6,5	8	T	T	T	T	T	T	T	T	T	T	T	T	T	T	T	T	T	T	
			5	5	5	6,5	T	T	T	T	T	T	T	T	T	T	T	T	T	T	T	T	T	T	
				5	5	6,5	T	T	T	T	T	T	T	T	T	T	T	T	T	T	T	T	T	T	
				5	5	6,5	T	T	T	T	T	T	T	T	T	T	T	T	T	T	T	T	T	T	
					5 <sup>4</sup>	5	T	T	T	T	T	T	T	T	T	T	T	T	T	T	T	T	T	T	
						3,5 <sup>4</sup>	T	T	T	T	T	T	T	T	T	T	10,5	10,5				T	T	T	T
							T	T	T	T	T	T	T	T	T	10,5						T	T	T	T

## 3 Protection coordination

### MCCB - XT1 @ 415 V

		Supply s.	XT1	XT2						XT3			XT4									
Version			B, C N, S H	N, S, H, L, V						N, S			N, S, H, L, V									
Release			TM	TM, M	EL			TM, M			TM											
Size			160	160						250			160			250						
Load s.	$I_n$ [A]		160	160	25	63	100	160	160	200	250	63	80	100	125	160	200	225	250			
XT1	B	TM	160	16	3	3		3	3	3	3	4	5	10	10	10	10	10	10	10		
	B, C			20	3	3		3	3	3	3	4	5	10	10	10	10	10	10	10	10	
	B, C, N			25	3	3		3	3	3	3	4	5	10	10	10	10	10	10	10	10	10
				32	3	3		3	3	3	4	5		10	10	10	10	10	10	10	10	10
	B, C, N S, H			40	3	3		3	3	3	4	5			10	10	10	10	10	10	10	10
				50	3	3		3	3	3	4	5			10 <sup>1</sup>	10	10	10	10	10	10	10
				63	3	3		3	3	4	5				10 <sup>1</sup>	10	10	10	10	10	10	
				80				3		4	5					10	10	10	10	10	10	
				100							5						10 <sup>1</sup>	10	10	10	10	
				125														10 <sup>1</sup>	10 <sup>1</sup>	10		
	160																					

<sup>1</sup> Value valid only for magnetic only supply side circuit-breaker

<sup>2</sup> Value valid only for PR232/P, PR331/P and PR332/P trip units

<sup>3</sup> Available only with  $I_u \leq 1250A$

### 3 Protection coordination

XT4			T4	T5						T6					T7			
N, S, H, L, V			N, S, H, L, V	N, S, H, L, V						N, S, H, L					S, H, L, V <sup>3</sup>			
EL				TM		EL				TM, M		EL			EL			
250			320	400		630	400		630	630	800	630	800	1000	800	1000	1250	1600
100	160	250	320	320	400	500	320	400	630	630	800	630	800	1000	800 <sup>2</sup>	1000 <sup>2</sup>	1250 <sup>2</sup>	1600 <sup>2</sup>
10	10	10	10	36	36	36	36	36	36	36	36	36	36	36	36	36	36	36
10	10	10	10	36	36	36	36	36	36	36	36	36	36	36	36	36	36	36
10	10	10	10	36	36	36	36	36	36	36	36	36	36	36	36	36	36	36
10	10	10	10	36	36	36	36	36	36	36	36	36	36	36	36	36	36	36
10	10	10	10	36	36	36	36	36	36	36	36	36	36	36	36	36	36	36
10	10	10	10	36	36	36	36	36	36	36	36	36	36	36	36	36	36	36
		10	10	36	36	36	36	36	36	36	36	36	36	36	36	36	36	36
		10	10	36	36	36	36	36	36	36	36	36	36	36	36	36	36	36
		10	10	36	36	36	36	36	36	36	36	36	36	36	36	36	36	36
		10	10	36	36	36	36	36	36	36	36	36	36	36	36	36	36	36

### 3 Protection coordination

#### MCCB - XT2 @ 415 V

Load s.	Version	Release	Size	Supply s.	XT1	XT2						XT3			XT4												
				160	B, C N, S H	N, S, H, L, V						N, S			N, S, H, L, V												
						TM	TM,M	EL			TM, M			TM, M													
						160						250			160			250									
$I_n$ [A]	160	160	25	63	100	160	160	200	250	50	63	80	100	125	160	200	225	250									
XT2	N S H L V	TM	160	1,6-2,5	T	T	T	T	T	T	T	T	T	T	85	85	85	85	85	85	85	85	85	85			
				3,2	T	T	T	T	T	T	T	T	T	85	85	85	85	85	85	85	85	85	85	85	85	85	
				4-5	T	T	T	T	T	T	T	T	T	85	85	85	85	85	85	85	85	85	85	85	85	85	85
				6,3	10	10	10	10	10	10	10	10	15	40	85	85	85	85	85	85	85	85	85	85	85	85	85
				8	10	10	10	10	10	10	10	15	40	85	85	85	85	85	85	85	85	85	85	85	85	85	85
				10	10	10	10	10	10	10	10	15	40	85	85	85	85	85	85	85	85	85	85	85	85	85	85
				12,5	3	3		3	3	3	3	4	5	85	85	85	85	85	85	85	85	85	85	85	85	85	85
				16	3	3		3	3	3	3	4	5				70	70	70	70	70	70	70	70	70	70	70
				20	3	3		3	3	3	3	4	5				55 <sup>1</sup>	55	55	55	55	55	55	55	55	55	55
				25	3	3		3	3	3	3	4	5				50 <sup>1</sup>	50	50	50	50	50	50	50	50	50	50
				32	3	3		3	3	3	3	4	5				50 <sup>1</sup>	50	50	50	50	50	50	50	50	50	50
				40	3	3		3	3	3	3	4	5				50 <sup>1</sup>	50 <sup>1</sup>	50	50	50	50	50	50	50	50	50
				50	3	3		3	3	3	3	4	5				50 <sup>1</sup>	50 <sup>1</sup>	50	50	50	50	50	50	50	50	50
				63	3	3					3	3	4	5			50 <sup>1</sup>	50 <sup>1</sup>	50 <sup>1</sup>	50	50	50	50	50	50	50	50
				80							3	3 <sup>1</sup>	4	5				50 <sup>1</sup>	50 <sup>1</sup>	50 <sup>1</sup>	50	50	50	50	50	50	50
				100									4	5						50 <sup>1</sup>	50 <sup>1</sup>	50 <sup>1</sup>	50 <sup>1</sup>	50 <sup>1</sup>	50 <sup>1</sup>	50 <sup>1</sup>	50
	125																50 <sup>1</sup>	50 <sup>1</sup>	50 <sup>1</sup>	50 <sup>1</sup>	50 <sup>1</sup>	50 <sup>1</sup>	50 <sup>1</sup>	50			
	160																50 <sup>1</sup>	50 <sup>1</sup>	50 <sup>1</sup>	50 <sup>1</sup>	50 <sup>1</sup>	50 <sup>1</sup>	50 <sup>1</sup>	50			
		EL	160	10						3	4	50	50	50	50	50	50	50	50	50	50	50	50	50	50		
	25									3	4	50	50	50	50	50	50	50	50	50	50	50	50	50	50		
63										3	4						50	50	50	50	50	50	50	50			
100										3	4													50	50		
									3	4														50			

<sup>1</sup> Value valid only for magnetic only supply side circuit-breaker

<sup>2</sup> Value valid only for PR232/P, PR331/P and PR332/P trip units

<sup>3</sup> Available only with  $I_u \leq 1250A$



### 3 Protection coordination

XT4					T4	T5						T6					T7			
N, S, H, L, V					N, S, H, L, V	N, S, H, L, V						N, S, H, L					S, H, L, V <sup>3</sup>			
EL					EL	TM			EL			TM, M			EL		EL			
160				250	320	400	630	400	630	630	800	630	800	1000	800	1000	1250	1600		
40	63	100	160	250	320	320	400	500	320	400	630	630	800	630	800	1000	800 <sup>2</sup>	1000 <sup>2</sup>	1250 <sup>2</sup>	1600 <sup>2</sup>
85	85	85	85	85	85	T	T	T	T	T	T	T	T	T	T	T	T	T	T	T
85	85	85	85	85	85	T	T	T	T	T	T	T	T	T	T	T	T	T	T	T
85	85	85	85	85	85	T	T	T	T	T	T	T	T	T	T	T	T	T	T	T
85	85	85	85	85	85	T	T	T	T	T	T	T	T	T	T	T	T	T	T	T
85	85	85	85	85	85	T	T	T	T	T	T	T	T	T	T	T	T	T	T	T
85	85	85	85	85	85	T	T	T	T	T	T	T	T	T	T	T	T	T	T	T
85	85	85	85	85	85	T	T	T	T	T	T	T	T	T	T	T	T	T	T	T
		70	70	70	70	T	T	T	T	T	T	T	T	T	T	T	T	T	T	T
		55	55	55	55	T	T	T	T	T	T	T	T	T	T	T	T	T	T	T
		50	50	50	50	T	T	T	T	T	T	T	T	T	T	T	T	T	T	T
		50	50	50	50	T	T	T	T	T	T	T	T	T	T	T	T	T	T	T
		50	50	50	50	T	T	T	T	T	T	T	T	T	T	T	T	T	T	T
		50	50	50	50	T	T	T	T	T	T	T	T	T	T	T	T	T	T	T
		50	50	50	50	T	T	T	T	T	T	T	T	T	T	T	T	T	T	T
		50	50	50	50	T	T	T	T	T	T	T	T	T	T	T	T	T	T	T
		50	50	50	50	T	T	T	T	T	T	T	T	T	T	T	T	T	T	T
		50	50	50	50	T	T	T	T	T	T	T	T	T	T	T	T	T	T	T
50	50	50	50	50	50	T	T	T	T	T	T	T	T	T	T	T	T	T	T	T
	50	50	50	50	50	T	T	T	T	T	T	T	T	T	T	T	T	T	T	T
		50	50	50	50	T	T	T	T	T	T	T	T	T	T	T	T	T	T	T
		50	50	50	50	T	T	T	T	T	T	T	T	T	T	T	T	T	T	T
		50	50	50	50	T	T	T	T	T	T	T	T	T	T	T	T	T	T	T

### 3 Protection coordination

#### MCCB - XT3 @ 415 V

		Supply s.	XT3			XT4					XT4			T4	
Version			N, S			N, S, H, L, V					N, S, H, L, V			N, S, H, L, V	
Release			TM, M			TM, M					EL			EL	
Size			250			160		250			160		250	320	
Load s.		$I_n$ [A]	160	200	250	125	160	200	225	250	100	160	250	320	
XT3	N S	TM	250	63	3	4	5	7 <sup>1</sup>	7	7	7	7	7	7	7
				80	3 <sup>1</sup>	4	5		7 <sup>1</sup>	7	7	7	7	7	7
				100		4 <sup>1</sup>	5		7 <sup>1</sup>	7 <sup>1</sup>	7 <sup>1</sup>	7	7	7	7
				125						7 <sup>1</sup>	7 <sup>1</sup>			7	7
				160										7	7
				200											7
				250											

- <sup>1</sup> Value valid only for magnetic only supply side circuit-breaker
- <sup>2</sup> Value valid only for PR232/P, PR331/P and PR332/P trip units
- <sup>3</sup> Available only with  $I_u \leq 1250A$

#### MCCB - XT4 - T4 @ 415 V

		Supply s.	T5						T6					T7													
Version			N, S, H, L, V						N, S, H, L					S, H, L, V <sup>1</sup>													
Release			TM			EL			TM, M		EL			EL													
Size			400		630		400		630		630		800		1000		800		1000 <sup>2</sup>		1250		1600 <sup>2</sup>				
Load s.		$I_n$ [A]	320	400	500	320	400	630	630	800	630	800	1000	800 <sup>2</sup>	1000 <sup>2</sup>	1250 <sup>2</sup>	1600 <sup>2</sup>										
XT4	N S H L V	TM	160	16	T	T	T	T	T	T	T	T	T	T	T	T	T	T	T	T	T	T	T	T			
				20	T	T	T	T	T	T	T	T	T	T	T	T	T	T	T	T	T	T	T	T	T	T	
				25	T	T	T	T	T	T	T	T	T	T	T	T	T	T	T	T	T	T	T	T	T	T	T
				32	T	T	T	T	T	T	T	T	T	T	T	T	T	T	T	T	T	T	T	T	T	T	T
				40	T	T	T	T	T	T	T	T	T	T	T	T	T	T	T	T	T	T	T	T	T	T	T
				50	T	T	T	T	T	T	T	T	T	T	T	T	T	T	T	T	T	T	T	T	T	T	T
				63	T	T	T	T	T	T	T	T	T	T	T	T	T	T	T	T	T	T	T	T	T	T	T
			80	T	T	T	T	T	T	T	T	T	T	T	T	T	T	T	T	T	T	T	T	T	T	T	
			100		50	T	50	50	T	T	T	T	T	T	T	T	T	T	T	T	T	T	T	T	T	T	
			125			T	50	50	T	T	T	T	T	T	T	T	T	T	T	T	T	T	T	T	T	T	
			160			T	50	50	T	T	T	T	T	T	T	T	T	T	T	T	T	T	T	T	T	T	
			200			T	50	50	T	T	T	T	T	T	T	T	T	T	T	T	T	T	T	T	T	T	
			225			T		50	T	T	T	T	T	T	T	T	T	T	T	T	T	T	T	T	T	T	
			250			T		50	T	T	T	T	T	T	T	T	T	T	T	T	T	T	T	T	T	T	
			T4		EL	160	40	50	50	T	50	50	T	T	T	T	T	T	T	T	T	T	T	T	T	T	T
63	50	50					T	50	50	T	T	T	T	T	T	T	T	T	T	T	T	T	T	T			
100	50	50					T	50	50	T	T	T	T	T	T	T	T	T	T	T	T	T	T	T	T		
250	320	160	50	50	T	50	50	T	T	T	T	T	T	T	T	T	T	T	T	T	T	T	T				
		250	250		T		50	T	T	T	T	T	T	T	T	T	T	T	T	T	T	T	T				
320	320					50	T	T	T	T	T	T	T	T	T	T	T	T	T	T	T	T					

- <sup>1</sup> Available only with  $I_u \leq 1250A$
- <sup>2</sup> Value valid only for PR232/P, PR331/P and PR332/P trip units

### 3 Protection coordination

T5							T6					T7			
N, S, H, L, V							N, S, H, L					S, H, L, V <sup>3</sup>			
TM			EL				TM, M		EL			EL			
400		630	400		630	630	800	630	800	1000	800	1000	1250	1600	
320	400	500	320	400	630	630	800	630	800	1000	800 <sup>2</sup>	1000 <sup>2</sup>	1250 <sup>2</sup>	1600 <sup>2</sup>	
25	25	25	25	25	25	25	⊖	⊖	⊖	⊖	⊖	⊖	⊖	⊖	
25	25	25	25	25	25	25	⊖	⊖	⊖	⊖	⊖	⊖	⊖	⊖	
25	25	25	25	25	25	25	40	⊖	40	⊖	⊖	⊖	⊖	⊖	
20	20	20	20	20	20	20	36	⊖	36	⊖	⊖	⊖	⊖	⊖	
		20	20	20	20	20	36	⊖	36	⊖	⊖	⊖	⊖	⊖	
			20	20	20	20	30	⊖	30	⊖	⊖	⊖	⊖	⊖	
			20	20	20	20	30	40	30	40	⊖	⊖	⊖	⊖	

#### MCCB - T5 @ 415 V

				Supply s.	T6					T7				
		Version				N, S, H, L					S, H, L, V <sup>1</sup>			
		Release				TM, M		EL			EL			
		Size				630	800	630	800	1000	800	1000	1250	1600
Load s.			I <sub>n</sub> [A]		630	800	630	800	1000	800 <sup>2</sup>	1000 <sup>2</sup>	1250 <sup>2</sup>	1600 <sup>2</sup>	
T5	N S H L V	TM	400	320	30	30	30	30	30	⊖	⊖	⊖	⊖	
				400					30	30	⊖	⊖	⊖	⊖
			630	500					30	30	⊖	⊖	⊖	⊖
		EL	400	320	30	30	30	30	30	⊖	⊖	⊖	⊖	⊖
				400	30	30	30	30	30	⊖	⊖	⊖	⊖	⊖
			630	630					30	⊖	⊖	⊖	⊖	⊖

<sup>1</sup> Available only with  $I_u \leq 1250A$

<sup>2</sup> Value valid only for PR232/P, PR331/P and PR332/P trip units

#### MCCB - T6 @ 415 V

				Supply s.	T7				
		Version				S, H, L, V <sup>1</sup>			
		Release				EL			
		Size				800	1000	1250	1600
Load s.			I <sub>n</sub> [A]		800 <sup>2</sup>	1000 <sup>2</sup>	1250 <sup>2</sup>	1600 <sup>2</sup>	
T6	N S H L V	TM	630	630			40	40	
				800	800			40	40
		EL	630	630	40	40	40	40	
				800	800	40	40	40	40
			1000	1000			40	40	

<sup>1</sup> Available only with  $I_u \leq 1250A$ , maximum selectivity value is: 15kA

<sup>2</sup> Value valid only for PR232/P, PR331/P and PR332/P trip units

### 3 Protection coordination

#### ACB - MCCB @ 415 V

Load s.		Supply s.		X1			E1		E2				E3					E4			E6			
		Version		B	N	L	B	N	B	N	S	L <sup>1</sup>	N	S	H	V	L <sup>1</sup>	S	H	V	H	V		
		Release		EL			EL		EL				EL					EL						
		Size		800	800	800	800	800	1600	1000	800	1250	2500	1000	800	800	2000	4000	3200	3200	4000	3200		
XT1	B	TM	160	T	T	T	T	T	T	T	T	T	T	T	T	T	T	T	T	T	T	T		
	C			T	T	T	T	T	T	T	T	T	T	T	T	T	T	T	T	T	T	T	T	
	N			T	T	T	T	T	T	T	T	T	T	T	T	T	T	T	T	T	T	T	T	
	S			T	42	T	T	T	T	T	T	T	T	T	T	T	T	T	T	T	T	T	T	T
XT2	H	TM,EL	160	T	T	T	T	T	T	T	T	T	T	T	T	T	T	T	T	T	T	T		
	S			T	42	T	T	T	T	T	T	T	T	T	T	T	T	T	T	T	T	T	T	
	H			T	42	T	T	T	T	55	65	T	T	T	T	T	T	T	T	T	T	T	T	
	L			T	42	T	T	T	T	55	65	100	T	T	75	85	100	T	T	100	T	100	T	100
	V			T	42	T	T	T	T	55	65	100	T	T	75	85	100	T	T	100	T	100	T	100
XT3	N	TM	250	T	T	T	T	T	T	T	T	T	T	T	T	T	T	T	T	T	T	T		
	S			T	42	T	T	T	T	T	T	T	T	T	T	T	T	T	T	T	T	T	T	
XT4	N	TM,EL	160 250	T	T	T	T	T	T	T	T	T	T	T	T	T	T	T	T	T	T	T		
	S			T	42	T	T	T	T	T	T	T	T	T	T	T	T	T	T	T	T	T	T	
	H			T	42	T	T	T	T	55	65	T	T	T	T	T	T	T	T	T	T	T	T	
	L			T	42	T	T	T	T	55	65	100	T	T	75	85	100	T	T	100	T	100	T	100
	V			T	42	T	T	T	T	55	65	100	T	T	75	85	100	T	T	100	T	100	T	100
T4	N	TM,EL	320	T	T	T	T	T	T	T	T	T	T	T	T	T	T	T	T	T	T	T		
	S			T	42	T	T	T	T	T	T	T	T	T	T	T	T	T	T	T	T	T	T	
	H			T	42	T	T	T	T	55	65	T	T	T	T	T	T	T	T	T	T	T	T	
	L			T	42	T	T	T	T	55	65	100	T	T	75	85	100	T	T	100	T	100	T	100
	V			T	42	T	T	T	T	55	65	100	T	T	75	85	100	T	T	100	T	100	T	100
T5	N	TM,EL	400 630	T	T	T	T	T	T	T	T	T	T	T	T	T	T	T	T	T	T	T		
	S			T	42	T	T	T	T	T	T	T	T	T	T	T	T	T	T	T	T	T	T	
	H			T	42	T	T	T	T	55	65	T	T	T	T	T	T	T	T	T	T	T	T	
	L			T	42	T	T	T	T	55	65	100	T	T	75	85	100	T	T	100	T	100	T	100
	V			T	42	T	T	T	T	55	65	100	T	T	75	85	100	T	T	100	T	100	T	100
T6	N	TM,EL	630 800 1000	T	T	15	T	T	T	T	T	T	T	T	T	T	T	T	T	T	T	T		
	S			T	42	15	T	T	T	T	T	T	T	T	T	T	T	T	T	T	T	T	T	
	H			T	42	15	T	T	T	55	65	T	T	T	T	T	T	T	T	T	T	T	T	
	L			T	42	15	T	T	T	55	65	T	T	T	75	85	T	T	T	T	T	T	T	
T7	S	EL	800 1000 1250 1600	T	42	15	T	T	T	T	T	T	T	T	T	T	T	T	T	T	T	T		
	H			T	42	15	T	T	T	55	65	T	T	T	T	T	T	T	T	T	T	T	T	
	L			T	42	15	T	T	T	55	65	100	T	T	75	85	100	T	T	100	T	100	T	100
	V <sup>2</sup>			T	42	15	T	T	T	55	65	100	T	T	75	85	100	T	T	100	T	100	T	100

Table valid for Emax circuit-breaker only with PR121/P, PR122/P and PR123/P releases

<sup>1</sup> Emax L circuit-breaker only with PR122/P and PR123/P releases

<sup>2</sup> Available only with  $I_u \leq 1250A$

### 3 Protection coordination

#### MCCB - Tmax XT1, XT2 @ 400/415 V

				Supply s.	T4		T5			T6		
		Version		L								
		Release		PR223EF <sup>1</sup>						PR223EF		
		Size		250		320	400		630	800		
Load s.			I <sub>n</sub> [A]	160	250	320	320	400	630	630	800	
XT1	B, C, N	TM	160	16-100	50	50	50	50	50	50	Ⓣ	Ⓣ
				125		50	50	50	50	50	Ⓣ	Ⓣ
				160		50	50	50	50	50	Ⓣ	Ⓣ
XT2	N,S,H,L	TM, EL	160	10-100	75 <sup>2</sup>	75 <sup>2</sup>	75 <sup>2</sup>	85	85	85	85	85
				125		75 <sup>2</sup>	75 <sup>2</sup>	85	85	85	85	85
				160		75 <sup>2</sup>	75 <sup>2</sup>	85	85	85	85	85

<sup>1</sup> Release in auxiliary power supply and trip delayed parameter set ON

<sup>2</sup> Select the lowest value between what is indicated and the breaking capacity of the supply side circuit-breaker

#### MCCB - Tmax T4, T5, T6 @ 400/415 V

				Supply s.	T4		T5			T6	
		Version		L							
		Release		PR223EF							
		Size		250		320	400		630	800	
Load s.			I <sub>n</sub> [A]	250	320	320	400	630	630	800	
T4	L	PR223EF	250	160	Ⓣ	Ⓣ	Ⓣ	Ⓣ	Ⓣ	Ⓣ	Ⓣ
				250	Ⓣ	Ⓣ	Ⓣ	Ⓣ	Ⓣ	Ⓣ	Ⓣ
			320		Ⓣ	Ⓣ	Ⓣ	Ⓣ	Ⓣ	Ⓣ	Ⓣ
T5	L	PR223EF	400	320			Ⓣ	Ⓣ	Ⓣ	Ⓣ	Ⓣ
				400				Ⓣ	Ⓣ	Ⓣ	Ⓣ
			630	630					Ⓣ	Ⓣ	Ⓣ
T6	L	PR223EF	630	630						Ⓣ	Ⓣ
			800	800							Ⓣ

Table valid for release with auxiliary power supply connected through a shielded twisted-pair wire

## 3 Protection coordination

### 3.3 Back-up tables

The tables shown give the short-circuit current value (in kA) for which the back-up protection is verified for the chosen circuit-breaker combination, at voltages from 240 up to 415 V. These tables cover all the possible combinations between ABB SACE moulded-case circuit-breakers Tmax XT/Tmax T and those between the above mentioned circuit-breakers and ABB MCBs.

#### Notes for a correct interpretation of the coordination tables:

Tmax XT @ 415V ac	
Version	Icu [kA]
B	18
C	25
N	36
S	50
H	70
L	120
V	150

Tmax @ 415V ac	
Version	Icu [kA]
B	16
C	25
N	36
S	50
H	70
L (for T2)	85
L (for T4-T5)	120
L (for T6)	100
V (for T7)	150
V	200

Emax @ 415V ac	
Version	Icu [kA]
B	42
N	65*
S	75**
H	100
L	130***
V	150****

\* For Emax E1 version N Icu=50kA

\*\* For Emax E2 version S Icu=85kA

\*\*\* For Emax X1 version L Icu=150kA

\*\*\*\* For Emax E3 version V Icu=130kA

#### Keys

For MCCB (Moulded-case circuit-breaker) ACB (Air circuit-breaker) TM = thermomagnetic release – TMD (Tmax) – TMA (Tmax) M = magnetic only release – MF (Tmax) – MA (Tmax) EL = electronic release	For MCB (Miniature circuit-breaker): B = charateristic trip (I3=3...5In) C = charateristic trip (I3=5...10In) D = charateristic trip (I3=10...20In) K = charateristic trip (I3=8...14In) Z = charateristic trip (I3=2...3In)
---	---

## 3 Protection coordination

### Example:

From the coordination table on page 161 the following conclusion is derived: the circuit-breakers type T5H and XT1N are coordinated in back-up protection up to a value of 65 kA (higher than the short-circuit current measured at the installation point), although the maximum breaking capacity of XT1N, at 415 V, is 36 kA.

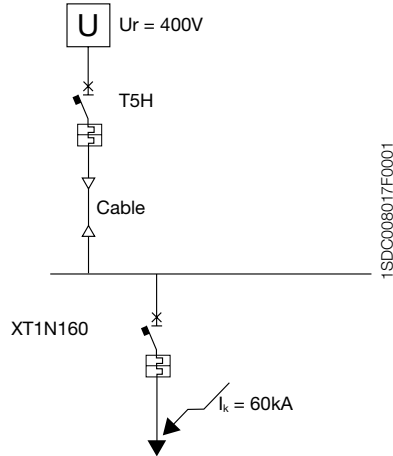

### MCB - MCB @ 240 V (Two-pole circuit-breakers)

Load s.	Char.	$I_{cu}$ [kA]	$I_n$ [A]	Supply s.	S200	S200M	S200P		S280	S290	S800
					B-C	B-C	B-C		B-C	C	B-C
					20	25	40	25	20	25	100
SN201L	B,C	6	2..40	20	25	40	25	15	15	100	
SN201	B,C,D	10	2..40	20	25	40	25	15	15	100	
SN201M	B,C	10	2..40	20	25	40	25	15	15	100	
S200	B,C,K,Z	20	0,5..63		25	40	25			100	
S200M	B,C	25	0,5..63			40				100	
S200P	B,C, D,K,Z	40	0,5..25							100	
		25	32..63							100	
S280	B,C	20	80, 100								
S290	C,D	25	80..125								

### 3 Protection coordination

#### MCCB @ 415 V - MCB @ 240 V

Load s.	Carat.	I <sub>n</sub> [A]	Supply s. <sup>1</sup>	XT1		XT2	XT3	XT1	XT2	XT3	XT1	XT2			
			Version	B	C	N		S		H		L	V		
			I <sub>cu</sub> [kA]	18	25	36		50		70		120	200		
SN201L	B,C	2..25	6	18	18	18	20	10	18	20	10	18	20	20	20
		32..40		10	18	10	18		10	18		10	18	18	18
SN201	B,C,D	2..25	10	18	18	18	25	18	18	18	18	18	25	25	25
		32..40		18	18	18	18		18	18		18	18	18	
SN201N	B,C	2..25	10	18	16	18	25	18	18	18	18	18	25	25	25
		32..40		18	18	18	18		18	18		18	18	18	

<sup>1</sup> Supply side circuit-breaker 4P (load side circuit branched between one phase and the neutral)

#### MCB - MCB @ 415 V

Load s.	Char.	I <sub>cu</sub> [kA]	I <sub>n</sub> [A]	Supply s.	S200	S200M	S200P		S280	S290	S800N	S800S
				B-C	B-C	B-C		B-C	C	B-C-D	B-C-D-K	
				10	15	25	15	6	15	36	50	
S200	B,C,K,Z	10	0,5..63	0,5..63	0,5..63	0,5..25	32..63	80, 100	80..125	25..125	25..125	
S200M	B,C	15	0,5..63		15	25	15		15	36	50	
S200P	B,C, D,K,Z	25	0,5..25							36	50	
		15	32..63							36	50	
S280	B,C	6	80, 100									
S290	C,D	15	80..125									
S800N	B,C,D	36	25..125									
S800S	B,C,D,K	50	25..125									



### 3 Protection coordination

#### MCCB - MCB @ 415 V

Load s.	Carat.	I <sub>n</sub> [A]	Supply s.	XT1		XT2	XT3	XT4	XT1	XT2	XT3	XT4	XT1	XT2	XT4	XT2	XT4	XT2	XT4	
			Version	B	C	N			S			H		L		V				
			I <sub>cu</sub> [kA]	18	25	36			50			70		120		150				
S200	B,C,K,Z	0,5..10	10	18	25	30	36	36	36	30	36	40	30	40	40	40	40	40	40	
		13..63						16				16								
S200M	B,C, D,K,Z	0,5..10	15	18	25	30	36	36	36	30	50	40	30	70	40	85	60	40	85	
		13..63						25				25							60	60
S200P	B,C, D,K,Z	0,5..10	25			30	36	36	36	30	50	40	40	30	70	40	85	40	85	40
		13..25				30	36	30	36	30	50	30	40	30	60	40	60	40	60	40
		32..63	15	18	25	30	36	25	36	30	50	25	40	30	60	40	60	40	60	40
S280	B,C	80..100	6	18	16	16	36	16	30	16	36	16	30	16	36	30	36	30	36	30
S290	C,D	80..125	15	18	25	30	36	30	30	30	50	30	30	30	70	30	85	30	85	30
S800N	B,C,D	10..125	36											70	70	85	120	85	150	
S800S	B,C,D,K	10..125	50											70	70	85	120	85	150	

### 3 Protection coordination

#### MCCB - MCCB @ 415 V

		Supply s.	XT1	XT2	XT3	XT4	T5	T6	XT1	XT2	XT3	XT4	T5	T6	T7		
		Version	C	N					S								
Load s.	Carat.	$I_{cu}$ [kA]	25	36					50								
XT1	B	16	25	36	36	36	36	30	30	36	50	50	50	36	36	36	
XT1	C	25		36	36	36	36	36	36	40	50	50	50	50	50	50	
XT1	N	36								50	50	50	50	50	50	50	
XT2											50	50	50	50	50	50	50
XT3													50	50	50	50	50
XT4														50	50	50	40
T5															50	50	50
T6																50	40
XT1	S	50															
XT2																	
XT3																	
XT4																	
T5																	
T6																	
XT1	H	70															
XT2																	
XT4																	
T5																	
T6																	
XT2	L	85															
XT4		120															
T5																	

<sup>1</sup> 120 kA per T7

### 3 Protection coordination

	XT1	XT2	XT4	T5	T6	T7	XT2	XT4	T5	T6	T7	XT2	XT4	T5	
	H						L					V			
	70						120			100 <sup>1</sup>		150		200	
	40	70	50	40	40	40	70	65	50	50		70	70	70	
	50	70	65	65	65	50	70	70	70	70	50	70	70	70	
	65	70	65	65	65	50	70	70	70	70	70	70	70	70	
		70	65	65	65	65	100	100	100	85	85	120	120	120	
			65	65	65	50		100	100	100	50		120	120	
			65	65	65	50		100	100	65	65		120	120	
				65	65	50			100	85	65			120	
					65	40				70	50				
	70	70	70	70	70	70	70	70	70	70	70	70	70	70	
			70	70	70	70	100	100	100	85	85	150	130	130	
			70	70	70			100	100	100			150	150	
			70	70	70	70		100	100	85	85		150	150	
				70	70	70			100	85	85			150	
					70					85	85				
							120	120	120	85	85	150	150	150	
								120	120	100	100		150	150	
									120	100	100		180	180	
										100	85				
												150	150	150	
													150	150	
														200	

## 3 Protection coordination

### 3.4 Coordination tables between circuit-breakers and switch disconnectors

The tables shown give the values of the short-circuit current (in kA) for which back-up protection is verified by the pre-selected combination of circuit-breaker and switch disconnector, for voltages between 380 and 415 V. The tables cover the possible combinations of moulded-case circuit-breakers in the SACE Tmax XT and Tmax T series, with the switch disconnectors detailed above.

Supply S.	Version	Icu	I <sub>th</sub> lu	Load S.	XT1D	XT3D	XT4D	T4D	T5D		T6D	
				I <sub>cw</sub> [kA]	2	3,6	3,6	3,6	6		15	
XT1	B	18	160	160	18	250	250	320	400	630	630	800
	C	25		18	18	18	18	18	18	18	18	18
	N	36		25	25	25	25	25	25	25	25	25
	S	50		36	36	36	36	36	36	36	36	36
	H	70		50	50	50	50	50	50	50	50	50
XT2	N	36	160	36	36	36	36	36	36	36	36	36
	S	50		50	50	50	50	50	50	50	50	
	H	70		70	70	70	70	70	70	70	70	
	L	120		120	120	120	120	120	120	120	120	
XT3	N	36	250		36	36	36	36	36	36	36	36
	S	50			50	50	50	50	50	50	50	50
XT4	N	36	160 250		36	36	36	36	36	36	36	36
	S	50			50	50	50	50	50	50	50	50
	H	70			70	70	70	70	70	70	70	70
	L	120			120	120	120	120	120	120	120	120
T4	N	36	320		36 <sup>1</sup>	36 <sup>1</sup>	36	36	36	36	36	36
	S	50			50 <sup>1</sup>	50 <sup>1</sup>	50	50	50	50	50	50
	H	70			70 <sup>1</sup>	70 <sup>1</sup>	70	70	70	70	70	70
	L	120			120 <sup>1</sup>	120 <sup>1</sup>	120	120	120	120	120	120
	V	200			200 <sup>1</sup>	200 <sup>1</sup>	200	200	200	200	200	200
T5	N	36	400 630					36 <sup>1</sup>	36	36	36	36
	S	50						50 <sup>1</sup>	50	50	50	50
	H	70						70 <sup>1</sup>	70	70	70	70
	L	120						120 <sup>1</sup>	120	120	120	120
	V	200						200 <sup>1</sup>	200	200	200	200
T6	N	36	630 800 1000							36 <sup>1</sup>	36 <sup>1</sup>	
	S	50								50 <sup>1</sup>	50 <sup>1</sup>	
	H	70								70 <sup>1</sup>	70 <sup>1</sup>	
	L	100								100 <sup>1</sup>	100 <sup>1</sup>	
T7	S	50	800 1000 1250 1600									
	H	70										
	L	120										
	V <sup>2</sup>	150										

<sup>1</sup> Value valid only with I1 (MCCB) <= Ith (MCS)

<sup>2</sup> Only for T7 1000 and T7 1250

### 3 Protection coordination

Notes for the correct reading of the coordination tables:

Tmax XT @ 415V ac	
Version	Icu [kA]
B	18
C	25
N	36
S	50
H	70
L	120
V	150

Tmax @ 415V ac	
Version	Icu [kA]
B	16
C	25
N	36
S	50
H	70
L (for T2)	85
L (for T4-T5)	120
L (for T6)	100
V (for T7)	150
V	200

	T7D		
	20		
	1000	1250	1600
	18	18	18
	25	25	25
	36	36	36
	50	50	50
	70	70	70
	36	36	36
	50	50	50
	70	70	70
	120	120	120
	150	150	150
	36	36	36
	50	50	50
	36	36	36
	50	50	50
	70	70	70
	120	120	120
	150	150	150
	36	36	36
	50	50	50
	70	70	70
	120	120	120
	200	200	200
	36	36	36
	50	50	50
	70	70	70
	120	120	120
	200	200	200
	36	36	36
	50	50	50
	70	70	70
	100	100	100
	50	50	50
	70	70	70
	120	120	120
	150 <sup>2</sup>	150 <sup>2</sup>	150 <sup>2</sup>

1SDCC008037F0201

### 3 Protection coordination

#### Example:

From the coordination table on page 162-163 it can be seen that circuit-breaker XT2S160 is able to protect the switch disconnector XT1D160 up to a short-circuit current of 50 kA (higher than the short-circuit current at the installation point). Overload protection is also verified, as the rated current of the breaker is not higher than the size of the disconnector.

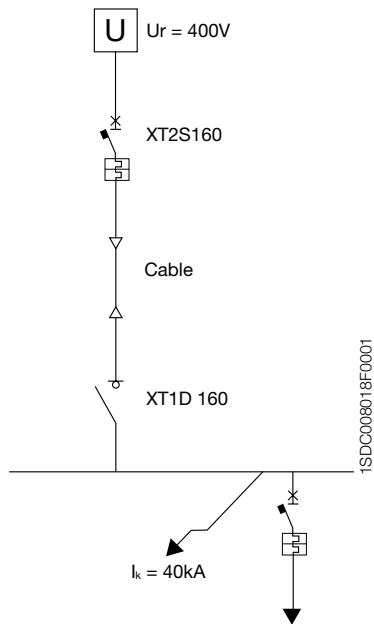

### 3 Protection coordination

#### Example:

For the correct selection of the components, the disconnector must be protected from overloads by a device with a rated current not greater than the size of the disconnector, while in short-circuit conditions it must be verified that:

$$I_{cw} \geq I_k$$

$$I_{cm} \geq I_p$$

Therefore, with regard to the electrical parameters of the single devices, Emax E2N1250/MS disconnector is selected, and a E2N1250 breaker.

That is:

$$I_{cw}(E2N /MS) = 55 \text{ kA} > 45 \text{ kA}$$

$$I_{cm}(E2N /MS) = 143 \text{ kA} > 100 \text{ kA}.$$

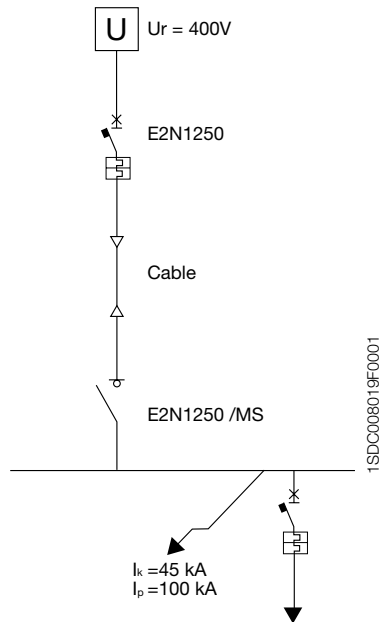

---

## 4 Special applications

---

### 4.1 Direct current networks

#### Main applications of direct current:

- Emergency supply or auxiliary services:  
the use of direct current is due to the need to employ a back-up energy source which allows the supply of essential services such as protection services, emergency lighting, alarm systems, hospital and industrial services, data-processing centres etc., using accumulator batteries, for example.
- Electrical traction:  
the advantages offered by the use of dc motors in terms of regulation and of single supply lines lead to the widespread use of direct current for railways, underground railways, trams, lifts and public transport in general.
- Particular industrial installations:  
there are some electrolytic process plants and applications which have a particular need for the use of electrical machinery.  
Typical uses of circuit-breakers include the protection of cables, devices and the operation of motors.

#### Considerations for the interruption of direct current

Direct current presents larger problems than alternating current does in terms of the phenomena associated with the interruption of high currents. Alternating currents have a natural passage to zero of the current every half-cycle, which corresponds to a spontaneous extinguishing of the arc which is formed when the circuit is opened.

This characteristic does not exist in direct currents, and furthermore, in order to extinguish the arc, it is necessary that the current lowers to zero.

The extinguishing time of a direct current, all other conditions being equal, is proportional to the time constant of the circuit  $T = L/R$ .

It is necessary that the interruption takes place gradually, without a sudden switching off of the current which could cause large over-voltages. This can be carried out by extending and cooling the arc so as to insert an ever higher resistance into the circuit.

The energetic characteristics which develop in the circuit depend upon the voltage level of the plant and result in the installation of breakers according to connection diagrams in which the poles of the breaker are positioned in series to increase their performance under short-circuit conditions. The breaking capacity of the switching device becomes higher as the number of contacts which open the circuit increases and, therefore, when the arc voltage applied is larger.

This also means that when the supply voltage of the installation rises, so must the number of current switches and therefore the poles in series.



## 4 Special applications

### **Calculation of the short-circuit current of an accumulator battery**

The short-circuit current at the terminals of an accumulator battery may be supplied by the battery manufacturer, or may be calculated using the following formula:

$$I_k = \frac{U_{Max}}{R_i}$$

where:

- $U_{Max}$  is the maximum flashover voltage (no-load voltage);
- $R_i$  is the internal resistance of the elements forming the battery.

The internal resistance is usually supplied by the manufacturer, but may be calculated from the discharge characteristics obtained through a test such as detailed by IEC 60896 – 1 or IEC 60896 – 2.

For example, a battery of 12.84 V and internal resistance of 0.005  $\Omega$  gives a short-circuit current at the terminals of 2568 A.

Under short-circuit conditions the current increases very rapidly in the initial moments, reaches a peak and then decreases with the discharge voltage of the battery. Naturally, this high value of the fault current causes intense heating inside the battery, due to the internal resistance, and may lead to explosion. Therefore it is very important to prevent and / or minimize short-circuit currents in direct currents systems supplied by accumulator batteries.

### **Criteria for the selection of circuit-breakers**

For the correct selection of a circuit-breaker for the protection of a direct current network, the following factors must be considered:

1. the load current, according to which the size of the breaker and the setting for the thermo-magnetic over-current release can be determined;
2. the rated plant voltage, according to which the number of poles to be connected in series is determined, thus the breaking capacity of the device can also be increased;
3. the prospective short-circuit current at the point of installation of the breaker influencing the choice of the breaker;
4. the type of network, more specifically the type of earthing connection.

Note: in case of using of four pole circuit-breakers, the neutral must be at 100%

### **Direct current network types**

Direct current networks may be carried out:

- with both polarities insulated from earth;
- with one polarity connected to earth;
- with median point connected to earth.

## 4 Special applications

### Network with both polarities insulated from earth

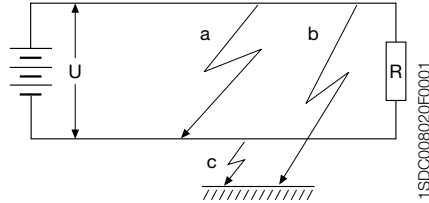

- Fault a: the fault, with negligible impedance, between the two polarities sets up a short-circuit current to which both polarities contribute to the full voltage, according to which the breaking capacity of the breaker must be selected.
- Fault b: the fault between the polarity and earth has no consequences from the point of view of the function of the installation.
- Fault c: again, this fault between the polarity and earth has no consequences from the point of view of the function of the installation.

In insulated networks it is necessary to install a device capable of signalling the presence of the first earth fault in order to eliminate it. In the worst conditions, when a second earth fault is verified, the breaker may have to interrupt the short-circuit current with the full voltage applied to a single polarity and therefore with a breaking capacity which may not be sufficient.

In networks with both polarities insulated from earth it is appropriate to divide the number of poles of the breaker necessary for interruption on each polarity (positive and negative) in such a way as to obtain separation of the circuit.

Diagrams to be used are as follows:

#### - MCBs type S800 UC - S280 UC

INSULATED NETWORK			
Rated voltage (Un)	≤ 500	≤ 750	
Protection + isolation function			
S800S UC	In = 10...125 A	50	50

INSULATED NETWORK		
Rated voltage (Un)	≤ 440	
Protection + isolation function		
S280 UC	In = 0,5...2 A	50
	In = 3...40 A	6
	In = 50...63 A	4,5

## 4 Special applications

### - MCCBs type Tmax XT

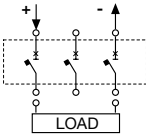
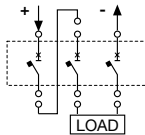
INSULATED NETWORK*			
Rated voltage (Un)	≤ 250	≤ 500	
Protection + isolation function			
XT1	B	18	18
	C	25	25
	N	36	36
	S	50	50
	H	70	70
XT2	N	36	36
	S	50	50
	H	70	70
	L	120	120
	V	150	150
XT3	N	36	36
	S	50	50
XT4	N	36	36
	S	50	50
	H	70	70
	L	120	120
	V	150	150

\* with these typologies of pole connection the possibility of a double fault to earth is considered unlikely.

## 4 Special applications

### - MCCBs type Tmax T

Rated voltage (Un)		INSULATED NETWORK						
		≤ 250		≤ 500		≤ 750		
Protection + isolation function								
		T1 160	B	16	20		16	
			C	25	30		25	
			N	36	40		36	
		T2 160	N	36	40		36	
S	50		55	50				
H	70		85	70				
L	85		100	85				
T3 250	N	36	40	36				
	S	50	55	50				
T4 250/320	N	36		25	16			
	S	50		36	25			
	H	70		50	36			
T5 400/630	L	100		70	50			
	V	150		100	70			
	N	36		20	16			
T6 630/800	S	50		35	20			
	H	70		50	36			
	L	100		65	50			

The positive pole (+) can be inverted with the negative pole (-).

\* with these typologies of pole connection the possibility of a double fault to earth is considered unlikely.

## 4 Special applications

### - ACBs type Emax

INSULATED NETWORK <sup>(1)</sup>						
Rated voltage (Un)		≤ 500	≤ 750	≤ 1000		
Isolation		■	■	■		
Protection		■	■	■		
PR122/DC		■	■	■		
PR123/DC		■	■	■		
Icu <sup>(2)</sup>		(kA)	(kA)	(kA)		
E2	B	800	35	25	25	25
		1000				
		1250				
		1600				
	N	1600	50	25	40	25
E3	N	800	60	40	50	35
		1000				
		1250				
		1600				
		2000				
	H	1600	65 <sup>(3)</sup>	40	50	40
		2000				
		2500				
E4	S	1600	75	65	65	50
		2000				
		2500				
		3200				
H	3200	100	65	65	65	
E6	H	3200	100	65	65	65
		4000				
		5000				

<sup>(1)</sup> the possibility of a double earth fault is considered negligible with this type of pole connections.

<sup>(2)</sup> Icu with L/R = 15ms according to IEC 60946-2 Standard. For Icu with L/R = 5ms and L/R = 30ms, ask ABB.

<sup>(3)</sup> 85kA only if supplied from lower terminals.

## 4 Special applications

### Network with one polarity connected to earth

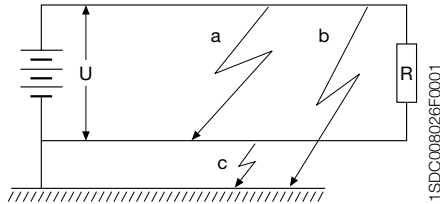

- Fault a: the fault between the two polarities sets up a short-circuit current to which both polarities contribute to the full voltage  $U$ , according to which the breaking capacity of the breaker is selected.
  - Fault b: the fault on the polarity not connected to earth sets up a current which involves the over-current protection according to the resistance of the ground.
  - Fault c: the fault between the polarity connected to earth and earth has no consequences from the point of view of the function of the installation.
- In a network with one polarity connected to earth, all the poles of the breaker necessary for protection must be connected in series on the non-earthed polarity. If isolation is required, it is necessary to provide another breaker pole on the earthed polarity.

Diagrams to be used with circuit isolation are as follows:

#### - MCBs type S800 UC - S280 UC

NETWORK WITH ONE POLARITY EARTHED			
Rated voltage ( $U_n$ )	$\leq 250$	$\leq 500$	$\leq 750$
Protection function			
S800S UC   $I_n = 10...125$ A	50	50	50

NETWORK WITH ONE POLARITY EARTHED			
Rated voltage ( $U_n$ )	$\leq 220$		$\leq 440$
Protection function			
Protection + isolation function			
S280 UC	$I_n = 0,5...2$ A	50	50
	$I_n = 3...40$ A	6	10
	$I_n = 50...63$ A	4,5	6
		4,5	4,5

## 4 Special applications

### - MCCBs type Tmax XT

NETWORK WITH ONE POLARITY EARTHED			
Rated voltage (Un)	≤ 250	≤ 500	
Protection + isolation function			
Protection function			
XT1	B	18	18
	C	25	25
	N	36	36
	S	50	50
	H	70	70
XT2	N	36	36
	S	50	50
	H	70	70
	L	120	120
	V	150	150
XT3	N	36	36
	S	50	50
XT4	N	36	36
	S	50	50
	H	70	70
	L	120	120
	V	150	150

## 4 Special applications

### - MCCBs type Tmax T

		NETWORK WITH ONE POLARITY EARTHED							
Rated voltage (Un)		≤ 250		≤ 500		≤ 750			
Protection + isolation function									
Protection function									
T1 160	B	16	20		16				
	C	25	30		25				
	N	36	40		36				
T2 160	N	36	40		36				
	S	50	55		50				
	H	70	85		70				
	L	85	100		85				
T3 250	N	36	40		36				
	S	50	55		50				
T4 250/320	N	36			25				16
	S	50			36				25
	H	70			50				36
T5 400/630	L	100			70				50
	V	150		100	70				
	N	36		20	16				
T6 630/800	S	50		35	20				
	H	70		50	36				
	L	100		65	50				



## 4 Special applications

### - ACBs type Emax

NETWORK WITH EARTHED NEGATIVE POLARITY <sup>(1)</sup>						
Rated voltage (Un)			≤ 500 <sup>(2)</sup>			
Isolation			■		■	
Protection			■		■	
PR122/DC			■		■	
PR123/DC			■		■	
type of fault			a	b	a	b
poles in series affected by the fault			3	2	4	3
Icu <sup>(3)</sup>			(kA)	(kA)	(kA)	(kA)
E2	B	800	35	20	35	35
		1000				
		1250				
		1600				
	N	1600	50	25	50	50
E3	N	800	60	30	60	60
		1000				
		1250				
		1600				
		2000				
	H	1600	65 <sup>(4)</sup>	40	65 <sup>(4)</sup>	65 <sup>(4)</sup>
		2000				
2500						
E4	S	1600	100	50	100	100
		2000				
		2500				
		3200				
	H	3200	100	65	100	100
E6	H	3200	100	65	100	100
		4000				
		5000				

(1) for networks with positive earthed polarity, ask ABB.

(2) for higher voltages, ask ABB.

(3) Icu with L/R = 15ms according to IEC 60946-2 Standard. For Icu with L/R = 5ms and L/R = 30ms, ask ABB.

(4) 85kA only if supplied from lower terminals.

Earthing shall be carried out on the supply side of the circuit-breaker.

## 4 Special applications

### Network with the median point connected to earth

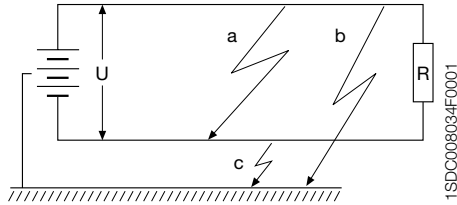

- Fault a: the fault between the two polarities sets up a short-circuit current to which both polarities contribute to the full voltage  $U$ , according to which the breaking capacity of the breaker is selected.
- Fault b: the fault between the polarity and earth sets up a short-circuit current less than that of a fault between the two polarities, as it is supplied by a voltage equal to  $0.5 U$ .
- Fault c: the fault in this case is analogous to the previous case, but concerns the negative polarity.

With network with the median point connected to earth the breaker must be inserted on both polarities.

Diagrams to be used are as follows:

#### - MCBs type S280 UC

NETWORK WITH THE MIDDLE POINT CONNECTED TO EARTH		
Rated voltage ( $U_n$ )	$\leq 220$	
Protection + isolation function		
S280 UC	$I_n = 0,5 \dots 2 \text{ A}$	50
	$I_n = 3 \dots 40 \text{ A}$	10
	$I_n = 50 \dots 63 \text{ A}$	6

## 4 Special applications

### - MCCBs type Tmax XT

NETWORK WITH THE MIDDLE POINT CONNECTED TO EARTH			
Rated voltage (Un)	≤ 250	≤ 500	
Protection + isolation function			
XT1	B	18	18
	C	25	25
	N	36	36
	S	50	50
	H	70	70
XT2	N	36	36
	S	50	50
	H	70	70
	L	120	120
	V	150	150
XT3	N	36	36
	S	50	50
XT4	N	36	36
	S	50	50
	H	70	70
	L	120	120
	V	150	150

## 4 Special applications

### - MCCBs type Tmax T

NETWORK WITH THE MIDDLE POINT CONNECTED TO EARTH					
Rated voltage (Un)		≤ 250*	≤ 500**	≤ 750	
Protection + isolation function					
	T1 160	B	20	16	
		C	30	25	
N		40	36		
T2 160	N	40	36		
	S	55	50		
	H	85	70		
	L	100	85		
T3 250	N	40	36		
	S	55	50		
T4 250/320	N	36	25	16	
	S	50	36	25	
	H	70	50	36	
T5 400/630	L	100	70	50	
	V	100	100	70	
T6 630/800	N	36	20	16	
	S	50	35	20	
	H	70	50	36	
	L	100	65	50	

\* for the use of three-phase circuit-breakers please ask ABB

\*\* for the use of three-phase circuit-breakers (T4-T5-T6) please ask ABB

## 4 Special applications

### - ACBs type Emax

NETWORK WITH THE MID-POINT EARTHED																	
Rated voltage (Ue)			≤ 500			≤ 500			≤ 750			≤ 1000					
PR122/DC			-			-			-			-					
PR123/DC			■			■			■			■					
type of fault			a b c			a b c			a b c			a b c					
poles in series affected by the fault			3			2 (U/2) 1 (U/2)			4			2 (U/2) 2 (U/2)			4		
Icu <sup>(1)</sup>			kA			kA			kA			kA					
E2	B	800	35	35	18	35	35	35	25	25	25	25	25	25			
		1000															
		1250															
		1600															
	N	1600	50	50	25	50	50	50	40	40	40	25	25	25			
25	N	800	60	60	30	60	60	60	50	50	50	35	35	35			
		1000															
		1250															
		1600															
		2000															
	2500																
		H	1600	65 <sup>(2)</sup>	65	40	65 <sup>(2)</sup>	65 <sup>(2)</sup>	65 <sup>(2)</sup>	50	50	50	40	40	40		
		2000															
		2500															
E4	S	1600	75	75	35	75	75	75	65	65	65	50	50	50			
		2000															
		2500															
		3200															
	H	3200	100	100	50	100	100	100	65	65	65	65	65	65			
E6	H	3200	100	100	65	100	100	100	65	65	65	65	65	65			
		4000															
		5000															

<sup>(1)</sup> Icu with L/R = 15ms according to IEC 60946-2 Standard. For Icu with L/R = 5ms and L/R = 30ms, ask ABB.

<sup>(2)</sup> 85kA only if supplied from below.

## 4 Special applications

### Use of switching devices in direct current

#### Parallel connection of breaker poles

According to the number of poles connected in parallel, the coefficients detailed in the following table must be applied:

**Table 1: Correction factor for poles connected in parallel**

number of poles in parallel	2	3	4 (neutral 100%)
reduction factor of dc carrying capacity	0.9	0.8	0.7
breaker current carrying capacity	1.8xIn	2.4xIn	2.8xIn

The connections which are external from the breaker terminals must be carried out by the user in such a way as to ensure that the connection is perfectly balanced.

The following table shows the connections of poles in parallel with the relevant derating and performances under short-circuit conditions referred to the adopted network topology.

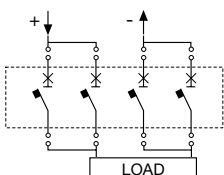
INSULATED NETWORK	
connection of the poles in parallel	electrical characteristics
	<p>To obtain such connection it is necessary to use a four-pole circuit-breaker with the neutral conductor at 100%.</p> <p>With a CB type T6 800, the available settings are:</p> <ul style="list-style-type: none"> <li>- maximum line current = 1440 A</li> <li>- instantaneous tripping = 14400 A (<math>\pm 20\%</math> tolerance)</li> </ul> <p>This application can be obtained with an installation voltage not exceeding 500Vd.c.</p> <p>The breaking capacities are (according to the different versions):</p> <p>N= 36kA with <math>Un &lt; 250Vd.c.</math> - 20kA with <math>Un &lt; 500Vd.c.</math>            S= 50kA with <math>Un &lt; 250Vd.c.</math> - 35kA with <math>Un &lt; 500Vd.c.</math>            H= 70kA with <math>Un &lt; 250Vd.c.</math> - 50kA with <math>Un &lt; 500Vd.c.</math>            L= 100kA with <math>Un &lt; 250Vd.c.</math> - 65kA with <math>Un &lt; 500Vd.c.</math></p>

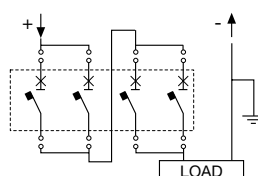
NETWORK WITH ONE POLARITY EARTHED	
protection function without insulation function	electrical characteristics
	<p>To obtain such connection it is necessary to use a four-pole circuit-breaker with the neutral conductor at 100%.</p> <p>With a CB type T6 800, the available settings are:</p> <ul style="list-style-type: none"> <li>- maximum line current = 1440 A</li> <li>- instantaneous tripping = 12960 A (<math>\pm 20\%</math> tolerance)</li> </ul> <p>This application can be obtained with an installation voltage not exceeding 500Vd.c.</p> <p>The breaking capacities are (according to the different versions):</p> <p>N= 36kA with <math>Un &lt; 250Vd.c.</math> - 20kA with <math>Un &lt; 500Vd.c.</math>            S= 50kA with <math>Un &lt; 250Vd.c.</math> - 35kA with <math>Un &lt; 500Vd.c.</math>            H= 70kA with <math>Un &lt; 250Vd.c.</math> - 50kA with <math>Un &lt; 500Vd.c.</math>            L= 100kA with <math>Un &lt; 250Vd.c.</math> - 65kA with <math>Un &lt; 500Vd.c.</math></p>

## 4 Special applications

### Behaviour of thermal releases

As the functioning of these releases is based on thermal phenomena arising from the flowing of current, they can therefore be used with direct current, their trip characteristics remaining unaltered.

### Behaviour of magnetic releases

The values of the trip thresholds of ac magnetic releases, used for direct current, must be multiplied by the following coefficient ( $k_m$ ), according to the breaker and the connection diagram:

**Table 2:  $k_m$  coefficient**

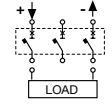
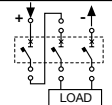
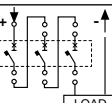
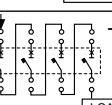
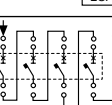
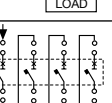
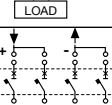
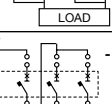
Connection modality	Circuit-breaker									
	XT1	XT2	XT3	XT4	T1	T2	T3	T4	T5	T6
	1.3	1.3	1.3	1.3	1.3	1.3	1.3	1.3	1.1	1.1
	1	1.15	1.15	1.15	1	1.15	1.15	1.15	1	1
	1	1.15	1.15	1.15	1	1.15	1.15	1.15	1	1
	-	-	-	-	-	-	-	1	0.9	0.9
	-	-	-	-	-	-	-	1	0.9	0.9
	-	-	-	-	-	-	-	1	0.9	0.9
	-	-	-	-	-	-	-	-	-	1
	-	-	-	-	-	-	-	-	-	0.9

## 4 Special applications

### Example

Data:

- Direct current network connected to earth;
- Rated voltage  $U_r = 250$  V;
- Short-circuit current  $I_k = 32$  kA
- Load current  $I_b = 230$  A

Using Table of page 173, it is possible to select the Tmax XT3N250  $I_n = 250$  A three pole breaker, using the connection shown (two poles in series for the polarity not connected to earth and one poles in series for the polarity connected to earth).

From km coefficient Table corresponding to the diagram select, and with breaker SACE Tmax XT3, it results  $k_m = 1.15$ ; therefore the nominal magnetic trip will occur at 2875 A (taking into account the tolerance, the trip will occur between 2300 A and 3450 A).



---

## 4 Special applications

---

### 4.2 Networks at particular frequencies: 400 Hz and 16 2/3 Hz

Standard production breakers can be used with alternating currents with frequencies other than 50/60 Hz (the frequencies to which the rated performance of the device refer, with alternating current) as appropriate derating coefficients are applied.

#### 4.2.1 400 Hz networks

At high frequencies, performance is reclassified to take into account phenomena such as:

- the increase in the skin effect and the increase in the inductive reactance directly proportional to the frequency causes overheating of the conductors or the copper components in the breaker which normally carry current;
- the lengthening of the hysteresis loop and the reduction of the magnetic saturation value with the consequent variation of the forces associated with the magnetic field at a given current value.

In general these phenomena have consequences on the behaviour of both thermo-magnetic releases and the current interrupting parts of the circuit-breaker.

To protect 400 Hz networks ABB SACE has developed a new series of electronic trip units, Ekip LS/E, LSI and LSIG: they are available for circuit-breakers type SACE Tmax XT.

The following tables refer to circuit-breakers with thermomagnetic releases, with a breaking capacity lower than 36 kA. This value is usually more than sufficient for the protection of installations where such a frequency is used, normally characterized by rather low short-circuit currents.

As can be seen from the data shown, the tripping threshold of the thermal element ( $I_{\theta}$ ) decreases as the frequency increases because of the reduced conductivity of the materials and the increase of the associated thermal phenomena; in general, the derating of this performance is generally equal to 10%.

Vice versa, the magnetic threshold ( $I_{\theta}$ ) increases with the increase in frequency.

## 4 Special applications

**Table 1: Tmax performance T1 16-63 A TMD**

		I1 (400Hz)			I3		
		MIN	MED	MAX	I3 (50Hz)	$K_m$	I3 (400Hz)
T1B 160							
T1C 160	In16	10	12	14	500	2	1000
T1N 160	In20	12	15	18	500	2	1000
	In25	16	19	22	500	2	1000
	In32	20	24.5	29	500	2	1000
	In40	25	30.5	36	500	2	1000
	In50	31	38	45	500	2	1000
	In63	39	48	57	630	2	1260

$K_m$  = Multiplier factor of I3 due to the induced magnetic fields

Trip curves  
thermomagnetic release

### T1 B/C/N 160

In 16 to 63 A  
TMD

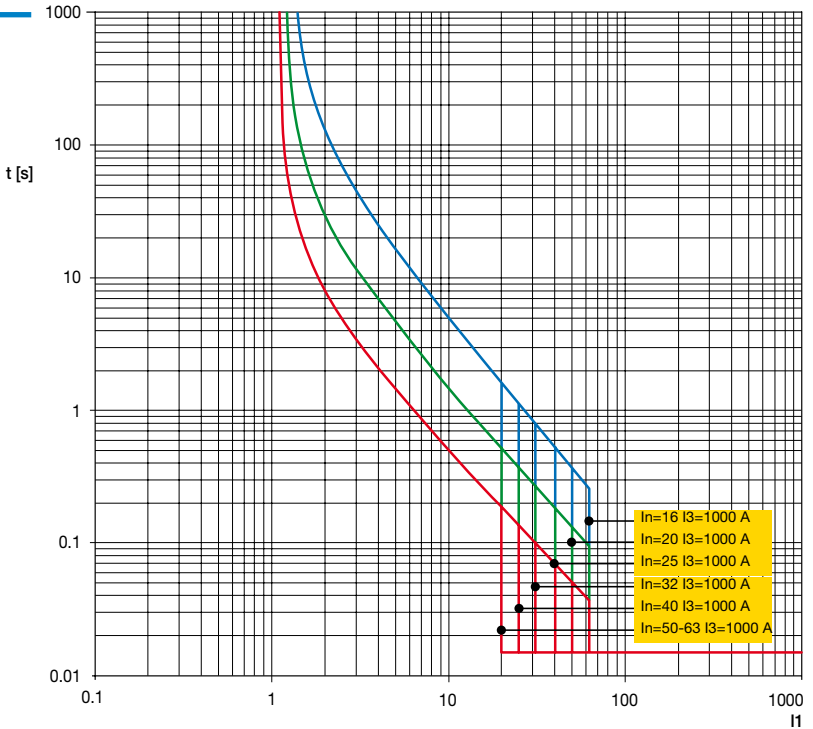

## 4 Special applications

**Table 2: Tmax performance T1 80 A TMD**

		I1 (400Hz)			I3		
		MIN	MED	MAX	I3 (50Hz)	$K_m$	I3 (400Hz)
T1B 160	In80	50	61	72	800	2	1600
T1C 160							
T1N 160							

$K_m$  = Multiplier factor of I3 due to the induced magnetic fields

Trip curves  
thermomagnetic release

### T1 B/C/N 160

In 80 A  
TMD

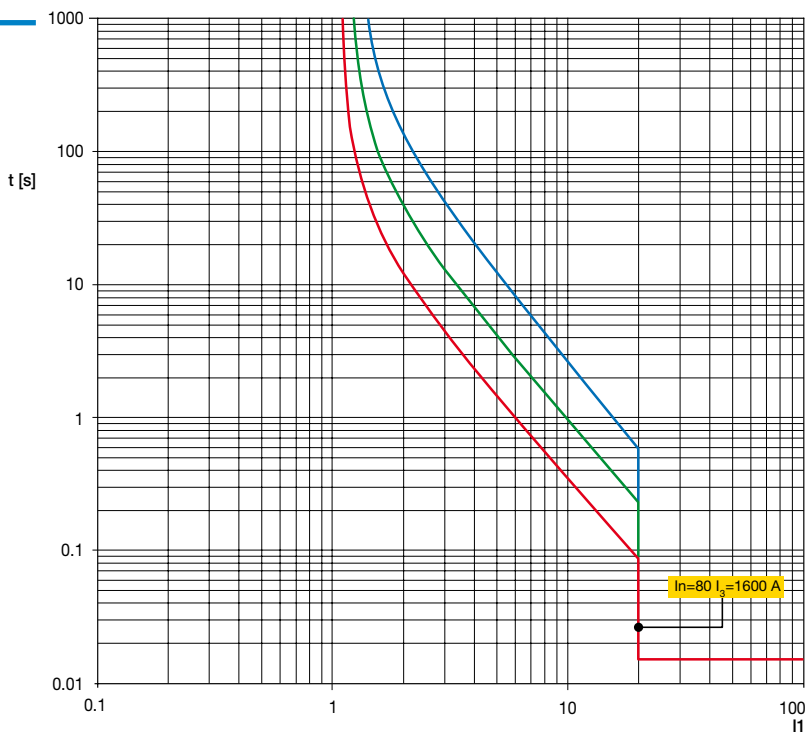

## 4 Special applications

**Table 3: Tmax performance T2 1.6-80 A TMD**

T2N 160	I1 (400Hz)			I3		
	MIN	MED	MAX	I3 (50Hz)	$K_m$	I3 (400Hz)
In1.6	1	1.2	1.4	16	1.7	27.2
In2	1.2	1.5	1.8	20	1.7	34
In2.5	1.5	1.9	2.2	25	1.7	42.5
In3.2	2	2.5	2.9	32	1.7	54.4
In4	2.5	3	3.6	40	1.7	68
In5	3	3.8	4.5	50	1.7	85
In6.3	4	4.8	5.7	63	1.7	107.1
In8	5	6.1	7.2	80	1.7	136
In10	6.3	7.6	9	100	1.7	170
In12.5	7.8	9.5	11.2	125	1.7	212.5
In16	10	12	14	500	1.7	850
In20	12	15	18	500	1.7	850
In25	16	19	22	500	1.7	850
In32	20	24.5	29	500	1.7	850
In40	25	30.5	36	500	1.7	850
In50	31	38	45	500	1.7	850
In63	39	48	57	630	1.7	1071
In80	50	61	72	800	1.7	1360

$K_m$  = Multiplier factor of I3 due to the induced magnetic fields

Trip curves  
thermomagnetic release

### T2N 160

In 1.6 to 80 A  
TMD

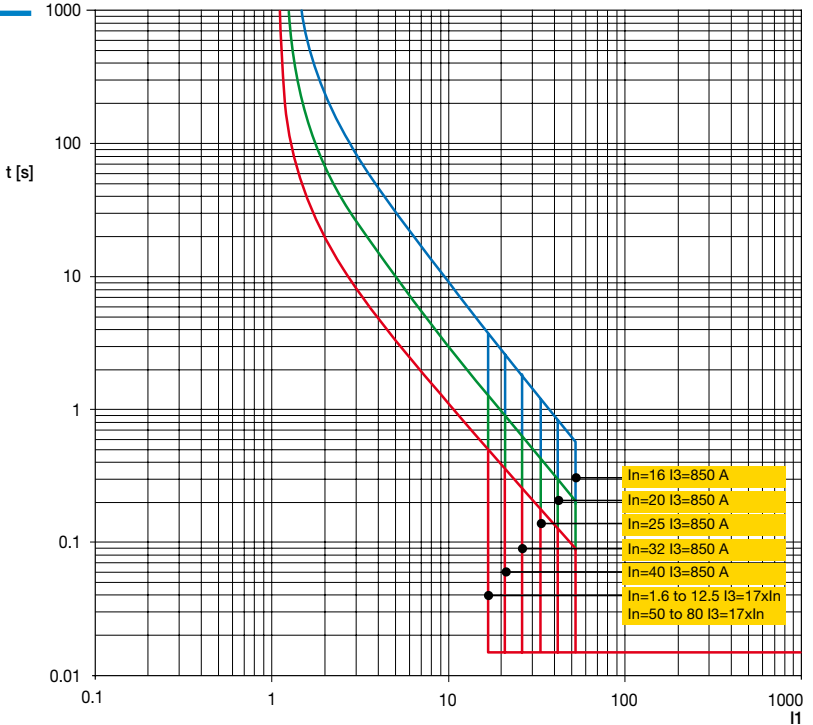

## 4 Special applications

**Table 4: Tmax performance T2 16-160 A TMG**

T2N 160	I1 (400Hz)			I3		
	MIN	MED	MAX	I3 (50Hz)	$K_m$	I3 (400Hz)
In16	10	12	14	160	1,7	272
In25	16	19	22	160	1,7	272
In40	25	30,5	36	200	1,7	340
In63	39	48	57	200	1,7	340
In80	50	61	72	240	1,7	408
In100	63	76,5	90	300	1,7	510
In125	79	96	113	375	1,7	637,5
In160	100	122	144	480	1,7	816

Trip curves  
thermomagnetic release

### T2N 160

In 16 to 160 A  
TMG

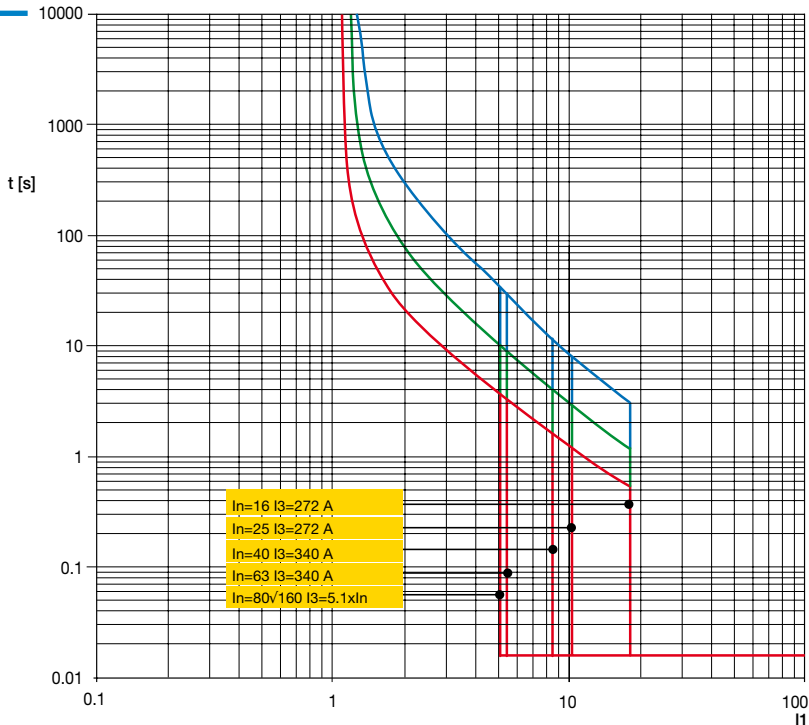

## 4 Special applications

**Table 5: Tmax performance T3 63-250 A TMG**

T3N 250	I1 (400Hz)			I3 (Low magnetic setting)		
	MIN	MED	MAX	I3 (50Hz)	$K_m$	I3 (400Hz)
In63	39	48	57	400	1.7	680
In80	50	61	72	400	1.7	680
In100	63	76.5	90	400	1.7	680
In125	79	96	113	400	1.7	680
In160	100	122	144	480	1.7	816
In200	126	153	180	600	1.7	1020
In250	157	191	225	750	1.7	1275

$K_m$  = Multiplier factor of I3 due to the induced magnetic fields

Trip curves  
thermomagnetic release

### T3N 250

In 63 to 250 A  
TMG

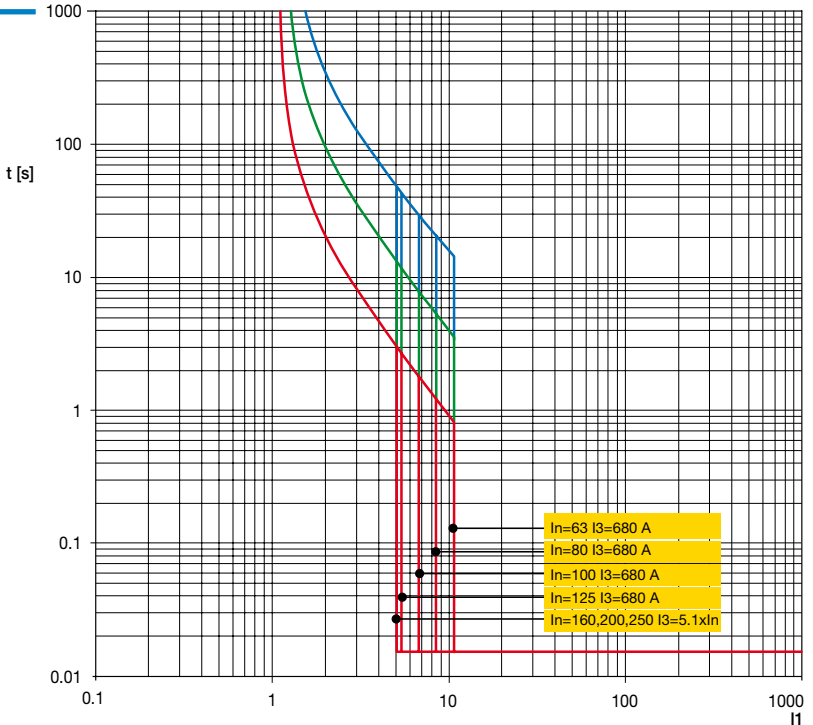

## 4 Special applications

**Table 6: Tmax performance T3 63-125 A TMD**

T3N 250	I1 (400Hz)			I3		
	MIN	MED	MAX	I3 (50Hz)	$K_m$	I3 (400Hz)
In63	39	48	57	630	1.7	1071
In80	50	61	72	800	1.7	1360
In100	63	76.5	90	1000	1.7	1700
In125	79	96	113	1250	1.7	2125

$K_m$  = Multiplier factor of I3 due to the induced magnetic fields

Trip curves  
thermomagnetic release

### T3N 250

In 63 to 125 A  
TMD

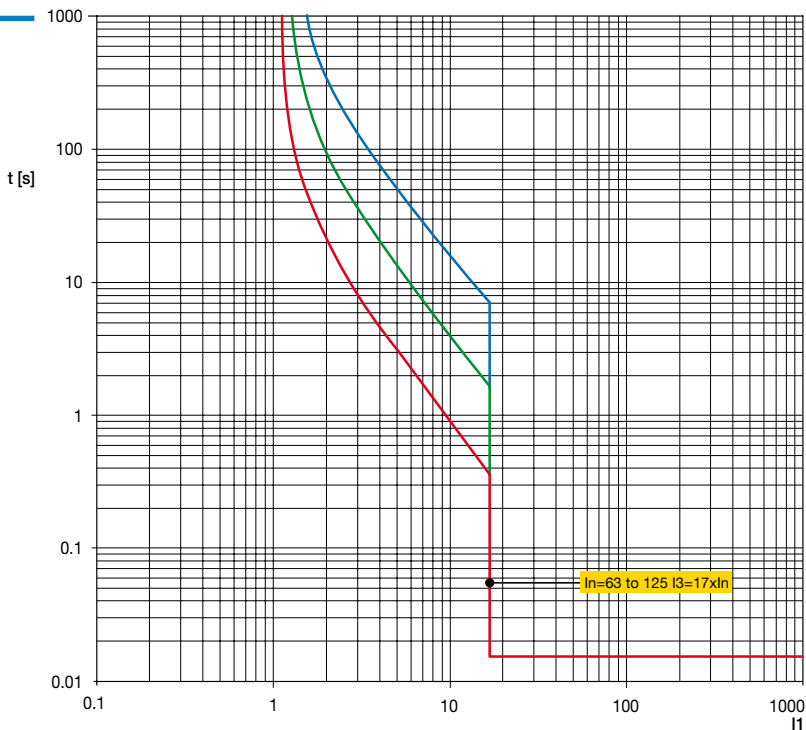

## 4 Special applications

**Table 7: Tmax performance T4 20-50 A TMD**

T4N 250		I1 (400Hz)			I3		
		MIN	MED	MAX	I3 (50Hz)	$K_m$	I3 (400Hz)
	In20	12	15	18	320	1.7	544
	In32	20	24.5	29	320	1.7	544
	In50	31	38	45	500	1.7	850

$K_m$  = Multiplier factor of I3 due to the induced magnetic fields

Trip curves  
thermomagnetic release

### T4N 250

In 20 to 50 A  
TMD

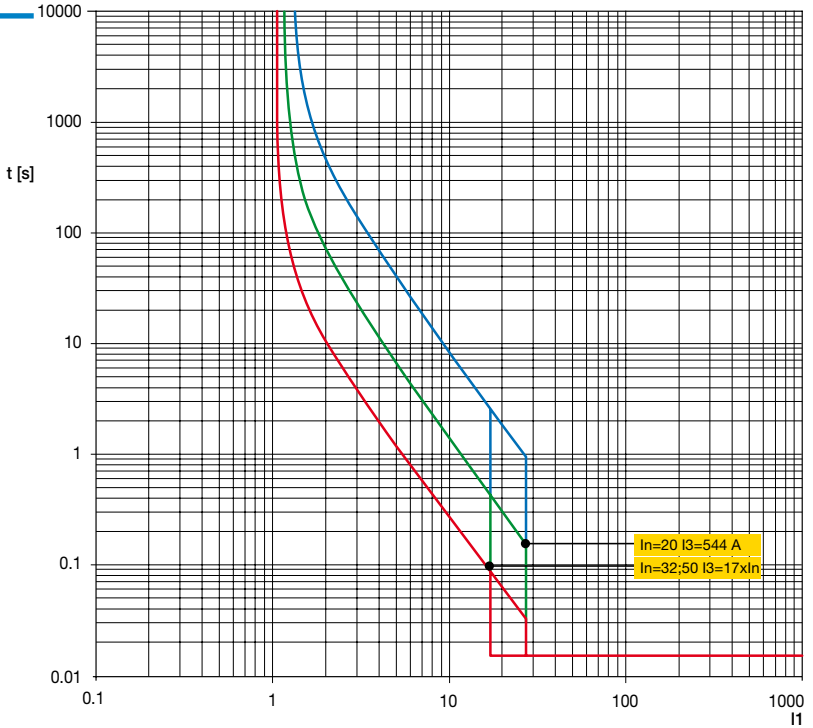



## 4 Special applications

**Table 8: Tmax performance T4N 80-250 A TMA**

T4N 250/320	I1 (400Hz)			I3 setting (MIN=5xIn)		
	MIN	MED	MAX	I3 @ 5xIn (50Hz)	$K_m$	I3 @ 5xIn (400Hz)
In80	50	61	72	400	1.7	680
In100	63	76.5	90	500	1.7	850
In125	79	96	113	625	1.7	1060
In160	100	122	144	800	1.7	1360
In200	126	153	180	1000	1.7	1700
In250	157	191	225	1250	1.7	2125

$K_m$  = Multiplier factor of I3 due to the induced magnetic fields

Trip curves  
thermomagnetic release

### T4N 250/320

In 80 to 250 A  
TMA

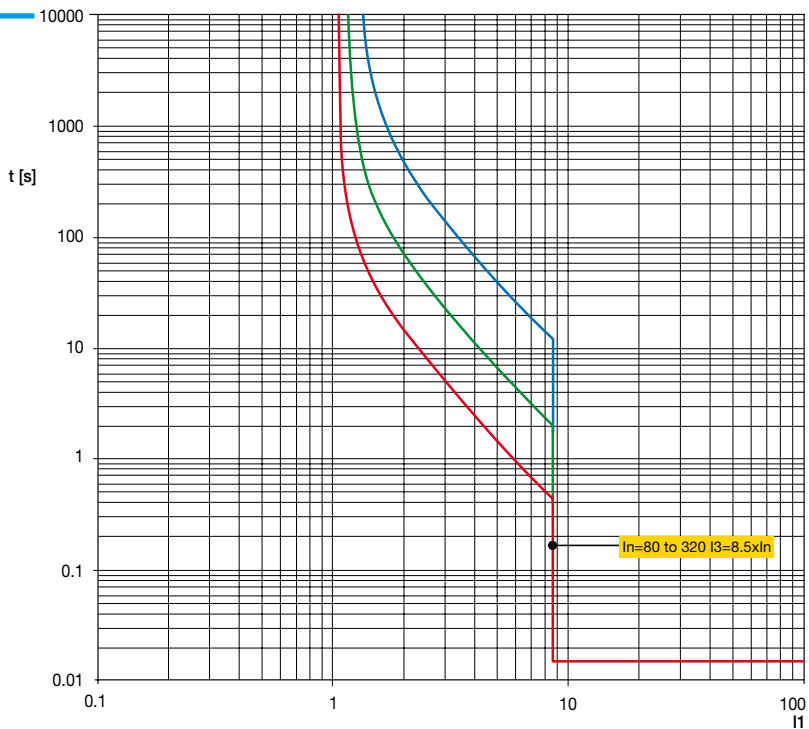

## 4 Special applications

**Table 9: Tmax performance T5N 320-500 A TMA**

T5N400/630	I1 (400Hz)			I3 setting (MIN=5xIn)		
	MIN	MED	MAX	I3 @ 5xIn(50Hz)	$K_m$	I3 @ 5xIn (400)Hz
In320	201	244	288	1600	1.5	2400
In400	252	306	360	2000	1.5	3000
In500	315	382	450	2500	1.5	3750

$K_m$  = Multiplier factor of I3 due to the induced magnetic fields

Trip curves  
thermomagnetic release

### T5 N 400/630

In 320 to 500 A  
TMA

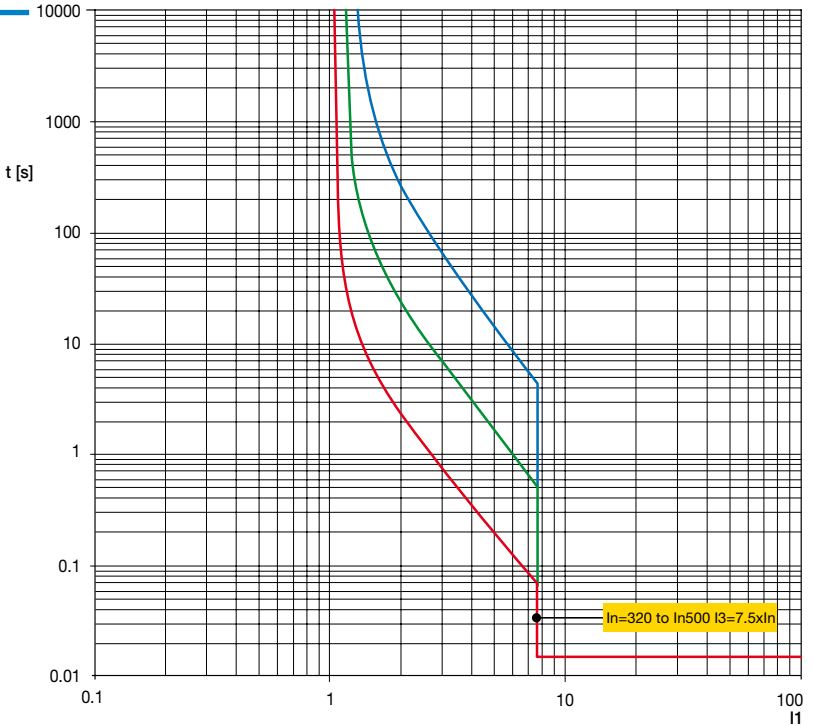

## 4 Special applications

**Table 10: Tmax performance T5N 320-500 A TMG**

T5N400/630	I1 (400Hz)			I3 setting (2.5...5xIn)		
	MIIN	MED	MAX	I3 @ 2.5..5xIn (50Hz)	$K_m$	I3 @ 2.5..5xIn (400Hz)
In320	201	244	288	800...1600	1.5	1200...2400
In400	252	306	360	1000...2000	1.5	1500...3000
In500	315	382	450	1250...2500	1.5	1875...3750

$K_m$  = Multiplier factor of I3 due to the induced magnetic fields

Trip curves  
thermomagnetic release

### T5N 400/630

In 320 to 500 A  
TMG

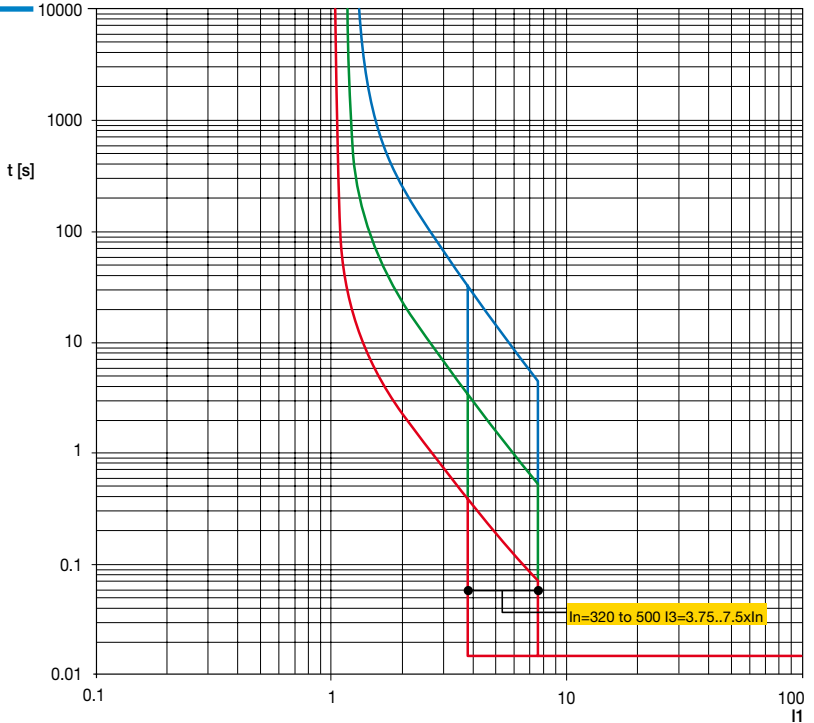

## 4 Special applications

**Table 11: Tmax performance T6N 630 A TMA**

T6N630	In630	I1 (400Hz)			I3 = 5/10In (set I3=5In)		
		MIN	MED	MAX	I3 (50Hz)	K <sub>m</sub>	I3 (400Hz)
		397	482	567	3150	1.5	4725

K<sub>m</sub> = Multiplier factor of I3 due to the induced magnetic fields

Trip curves  
thermomagnetic release

### T6N 630

In 630 A  
TMA

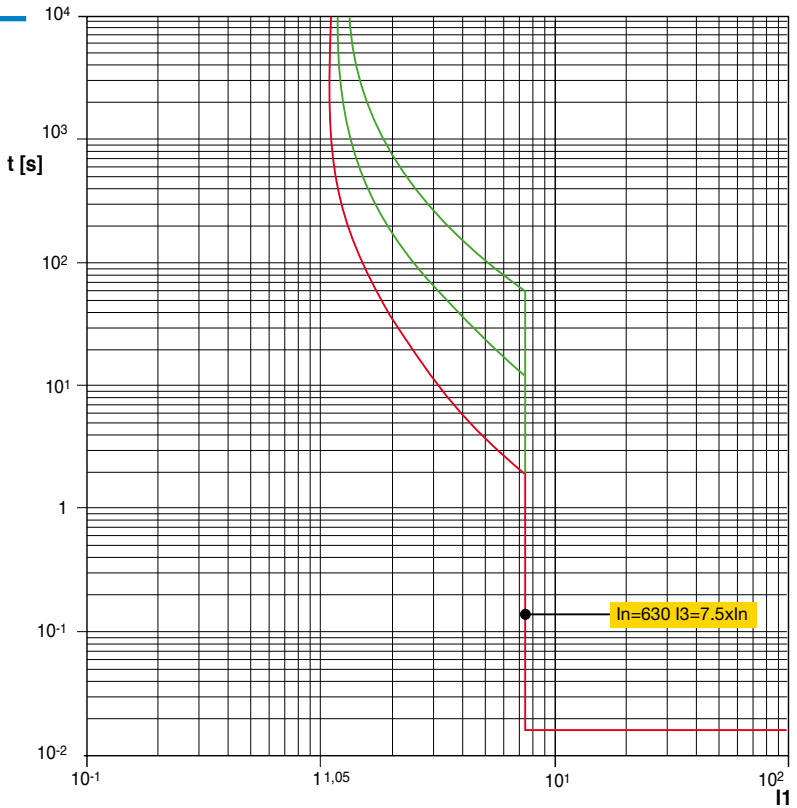

## 4 Special applications

**Table 12: Tmax performance T6N 800 A TMA**

T6N 800	In800	I1 (400Hz)			I3 = 5-10In (set I3=5In)		
		MIN	MED	MAX	I3 (50Hz)	K <sub>m</sub>	I3 (400Hz)
		504	602	720	4000	1.5	6000

K<sub>m</sub> = Multiplier factor of I3 due to the induced magnetic fields

Trip curves  
thermomagnetic release

### T6N 800

In 800 A  
TMA

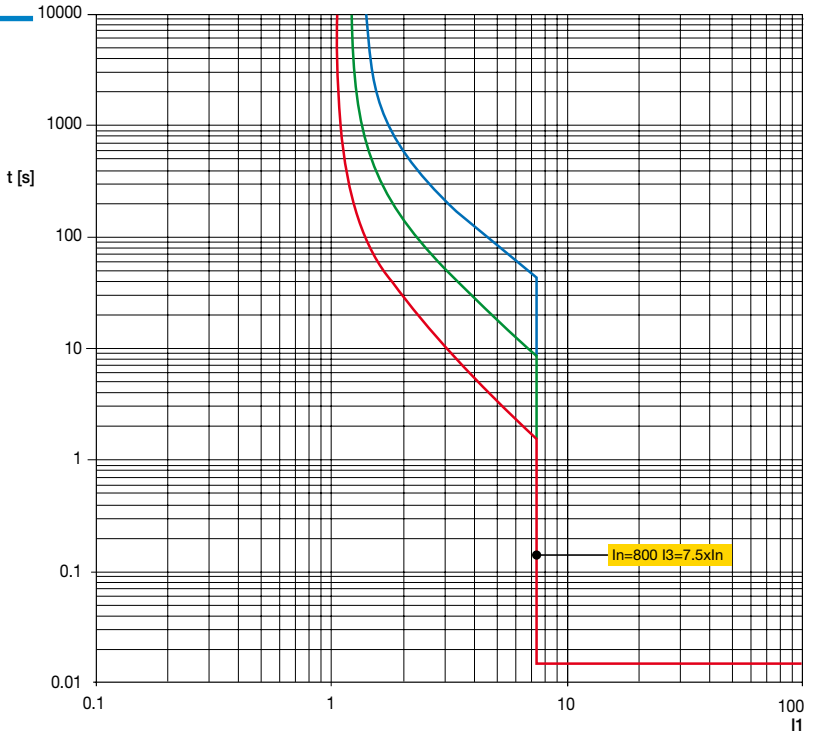

## 4 Special applications

### 4.2.2 16 2/3 Hz networks

Single phase distribution with a frequency of 16 2/3 Hz was developed for electrical traction systems as an alternative to three phase 50 Hz systems, and to direct current systems.

At low frequencies the thermal tripping threshold is not subject to any derating, while the magnetic threshold requires a correction coefficient  $k_m$ , as detailed in table 2.

The Tmax series thermomagnetic moulded-case circuit-breakers are suitable for use with frequencies of 16 2/3 Hz; the electrical performance and the relevant connection diagrams are shown below.

**Table 1: Breaking capacity [kA]**

Circuit-breaker	Rated current	Breaking capacity [kA]			
	[A]	250 V	500 V	750 V	1000 V <sup>(1)</sup>
T1B160	16 ÷ 160	16 (2P) 20 (3P)	16 (3P)	-	-
T1C160	25 ÷ 160	25 (2P) 30 (3P)	25 (3P)	-	-
T1N160	32 ÷ 160	36 (2P) 40 (3P)	36 (3P)	-	-
T2N160	1.6 ÷ 160	36 (2P) 40 (3P)	36 (3P)	-	-
T2S160	1.6 ÷ 160	50 (2P) 55 (3P)	50 (3P)	-	-
T2H160	1.6 ÷ 160	70 (2P) 85 (3P)	70 (3P)	-	-
T2L160	1.6 ÷ 160	85 (2P) 100 (3P)	85 (3P)	50 (4P) <sup>(2)</sup>	-
T3N250	63 ÷ 250	36 (2P) 40 (3P)	36 (3P)	-	-
T3S250	63 ÷ 250	50 (2P) 55 (3P)	50 (3P)	-	-
T4N250/320	20 ÷ 250	36 (2P)	25 (2P)	16 (3P)	-
T4S250/320	20 ÷ 250	50 (2P)	36 (2P)	25 (3P)	-
T4H250/320	20 ÷ 250	70 (2P)	50 (2P)	36 (3P)	-
T4L250/320	20 ÷ 250	100 (2P)	70 (2P)	50 (3P)	-
T4V250/320	20 ÷ 250	150 (2P)	100 (2P)	70 (3P)	-
T4V250	32 ÷ 250				40 (4P)
T5N400/630	320 ÷ 500	36 (2P)	25 (2P)	16 (3P)	-
T5S400/630	320 ÷ 500	50 (2P)	36 (2P)	25 (3P)	-
T5H400/630	320 ÷ 500	70 (2P)	50 (2P)	36 (3P)	-
T5L400/630	320 ÷ 500	100 (2P)	70 (2P)	50 (3P)	-
T5V400/630	320 ÷ 500	150 (2P)	100 (2P)	70 (3P)	-
T5V400/630	400 ÷ 500				40 (4P)
T6N630/800	630 ÷ 800	36 (2P)	20 (2P)	16 (3P)	-
T6S630/800	630 ÷ 800	50 (2P)	35 (2P)	20 (3P)	-
T6H630/800	630 ÷ 800	70 (2P)	50 (2P)	36 (3P)	-
T6L630/800	630 ÷ 800	100 (2P)	70 (2P)	50 (3P)	40 (4P)

<sup>(1)</sup> 1000V version circuit-breakers in dc, with neutral at 100%.

<sup>(2)</sup> Circuit-breakers with neutral at 100%.

## 4 Special applications

**Table 2:  $k_m$  factor**

	Diagram A	Diagram B-C	Diagram D-E-F
<b>T1</b>	1	1	-
<b>T2</b>	0.9	0.9	0.9
<b>T3</b>	0.9	0.9	-
<b>T4</b>	0.9	0.9	0.9
<b>T5</b>	0.9	0.9	0.9
<b>T6</b>	0.9	0.9	0.9

**Table 3: Possible connections according to the voltage, the type of distribution and the type of fault**

	Neutral not grounded	Neutral grounded*	
		L-N fault	L-E fault
250 V 2 poles in series	A1	A2	B2
250 V 3 poles in series**	B1	B2, C	B3
500 V 2 poles in series	A1	A2, B2	B2, C
500 V 3 poles in series**	B1	B2, C	C
750 V 3 poles in series	B1	B2, C	C
750 V 4 poles in series***	E-F	E1, D	E1
1000 V 4 poles in series	E-F	E1, C3	E1

\* In the case of the only possible faults being L-N or L-E (E=Earth) with non-significant impedance, use the diagrams shown. If both faults are possible, use the diagrams valid for L-E fault.

\*\* T1, T2, T3 only,

\*\*\* T2 only

### Connection diagrams

#### Diagram A1

Configuration with two poles in series (without neutral connected to earth)

- Interruption for phase to neutral fault: 2 poles in series
- Interruption for phase to earth fault: not considered

(The installation method must be such as to make the probability of a second earth fault negligible)

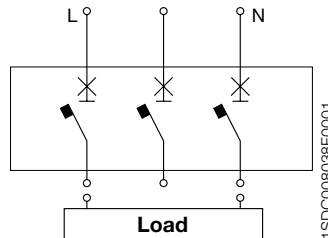

#### Diagram A2

Configuration with two poles in series (with neutral connected to earth)

- Interruption for phase to neutral fault: 2 poles in series
- Interruption for phase to earth fault: single pole (same capacity as two poles in series, but limited to 125V)

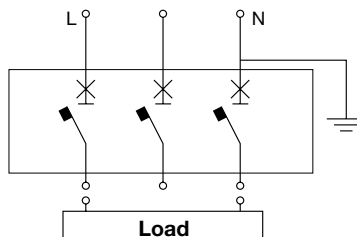

## 4 Special applications

### Diagram B1

Configuration with three poles in series (without neutral connected to earth)

- Interruption for phase to neutral fault: 3 poles in series
- Interruption for phase to earth fault: not considered

(The installation method must be such as to make the probability of a second earth fault negligible)

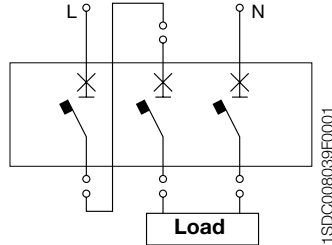

### Diagram B2

Configuration with three poles in series (with neutral connected to earth and interrupted)

- Interruption for phase to neutral fault: 3 poles in series
- Interruption for phase to earth fault: 2 poles in series

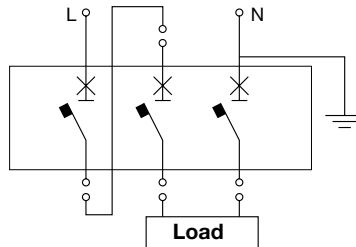

### Diagram C

Configuration with three poles in series (with neutral connected to earth but not interrupted)

- Interruption for phase to neutral fault: 3 poles in series
- Interruption for phase to earth fault: 3 poles in series

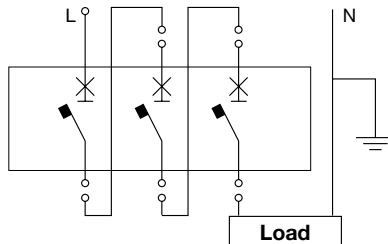



## 4 Special applications

### Diagram E-F

Configuration with four poles in series (without neutral connected to earth)

- Interruption for phase to neutral fault: 4 poles in series
- Interruption for phase to earth fault: not considered

(The installation method must be such as to make the probability of a second earth fault negligible)

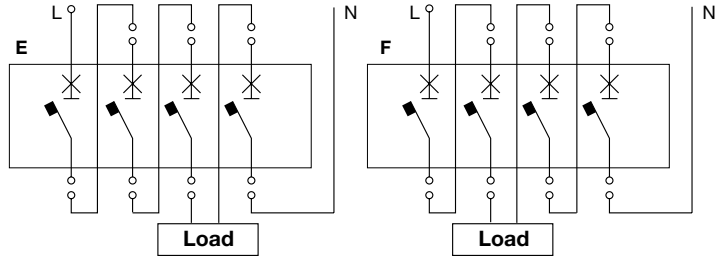

1SDC008042F0001

### Diagram D

Configuration with four poles in series, on one polarity (with neutral connected to earth and not interrupted)

- Interruption for phase to neutral fault: 4 poles in series
- Interruption for phase to earth fault: 4 poles in series

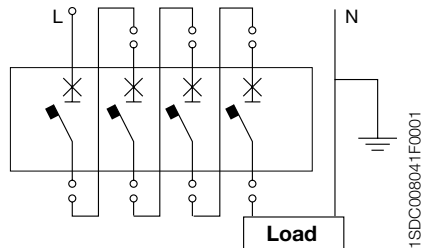

1SDC008041F0001

### Diagram E1

Interruption with four poles in series (with neutral connected to earth and interrupted)

- Interruption for phase to neutral fault: 4 poles in series
- Interruption for phase to earth fault: 3 poles in series

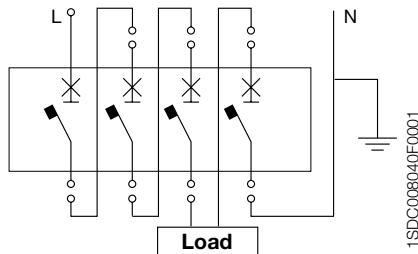

1SDC008040F0001

## 4 Special applications

### Example:

Network data:  
 Rated voltage 250 V  
 Rated frequency 16 2/3 Hz  
 Load current 120 A  
 Phase to neutral short-circuit current 45 kA  
 Neutral connected to earth

Assuming that the probability of a phase to earth fault is negligible, Table 3 shows that connections A2, B2 or B3 may be used.

Therefore it is possible to choose a Tmax T2S160 In125 circuit-breaker, which with the connection according to diagram A2 (two poles in series) has a breaking capacity of 50 kA, while according to diagrams B2 or B3 (three poles in series) the breaking capacity is 55 kA (Table 1). To determine the magnetic trip, see factor  $k_m$  in Table 2. The magnetic threshold will be:

$$I_3 = 1250 \cdot 0.9 = 1125 \text{ A}$$

whichever diagram is used.

If it is possible to have an earth fault with non significant impedance, the diagrams to be considered (Table 3) are only B2 or B3. In particular, in diagram B2 it can be seen that only 2 poles are working in series, the breaking capacity will be 50 kA (Table 1), while with diagram B3, with 3 poles working in series, the breaking capacity is 55 kA.

### 4.3 1000 Vdc and 1000 Vac networks

The Tmax and Emax /E 1000 V and 1150 V circuit-breakers are particularly suitable for use in installations in mines, petrochemical plants and services connected to electrical traction (tunnel lighting).

#### 5.3.1 1000 V dc networks

### 1000 Vdc Moulded case circuit-breakers

#### General characteristics

The range of Tmax moulded-case circuit-breakers for use in installations with rated voltage up to 1000 Vdc comply with international standard IEC 60947-2. The range is fitted with adjustable thermo-magnetic releases and is suitable for all installation requirements and has a range of available settings from 32 A to 800 A. The four-pole version circuit-breakers allow high performance levels to be reached thanks to the series connection of the poles.

The circuit breakers in the Tmax 1000 V range maintain the same dimensions and fixing points as standard circuit breakers.

These circuit-breakers can also be fitted with the relevant range of standard accessories, with the exception of residual current releases for Tmax.

In particular it is possible to use conversion kits for removable and withdrawable moving parts and various terminal kits.

## 4 Special applications

<b>1000 V dc Moulded-case circuit-breakers</b>		<b>T4</b>	<b>T5</b>	<b>T6</b>
Rated uninterrupted current, <b>I<sub>u</sub></b>	[A]	250	400/630	630/800
Poles	Nr.	4	4	4
Rated operational voltage, <b>U<sub>e</sub></b>	[V -]	1000	1000	1000
Rated impulse withstand voltage, <b>U<sub>imp</sub></b>	[kV]	8	8	8
Rated insulation voltage, <b>U<sub>i</sub></b>	[V]	1000	1000	1000
Test voltage at industrial frequency for 1 min.	[V]	3500	3500	3500
Rated ultimate short-circuit breaking capacity, <b>I<sub>cu</sub></b> (4 poles in series)	[kA]	<b>V</b> 40	<b>V</b> 40	<b>L</b> 40
Rated services short-circuit breaking capacity, <b>I<sub>cs</sub></b> (4 poles in series)	[kA]	20	20	
Rated short-time withstand current for 1 s, <b>I<sub>cw</sub></b>	[kA]	-	5 (400A)	7.6 (630A) - 10 (800A)
Utilisation category (EN 60947-2)		A	B (400A)-A (630A)	B
Isolation behaviour		■	■	■
IEC 60947-2, EN 60947-2		■	■	■
Thermomagnetic releases	TMD	■	-	-
Thermomagnetic releases	TMA	■	up to 500 A	■
Versions		F	F	F
Terminals	Fixed	FC Cu	FC Cu	F - FC CuAl - R
Mechanical life [No. operations / operations per hours]		20000/240	20000/120	20000/120
Basic dimensions, fixed	L [mm]	140	184	280
	D [mm]	103.5	103.5	103.5
	H [mm]	205	205	268

TERMINAL CAPTION  
F = Front  
EF = Front extended

ES = Front extended spread  
FC Cu = Front for copper cables  
FC CuAl = Front for CuAl cables

R = Rear orientated  
HR = Rear in horizontal flat bar  
VR = Rear in vertical flat bar

MC = Multicable

### Connection diagrams

Possible connection diagrams with reference to the type of distribution system in which they can be used follow.

#### Networks insulated from earth

The following diagrams can be used (the polarity may be inverted).

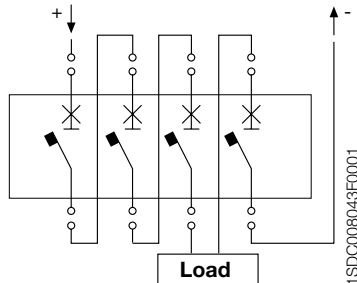

A) 3+1 poles in series (1000 Vdc)

## 4 Special applications

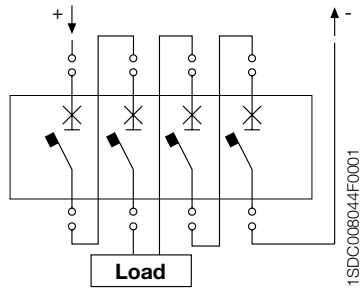

**B) 2+2 poles in series (1000 Vdc)**

It is assumed that the risk of a double earth fault in which the first fault is downstream of the breaker on one polarity and the second is upstream of the same switching device on the opposite polarity is null.

In this condition the fault current, which can reach high values, effects only some of the 4 poles necessary to ensure the breaking capacity.

It is possible to prevent the possibility of a double earth fault by installing a device which signals the loss of insulation and identifies the position of the first earth fault, allowing it to be eliminated quickly.

### Networks with one polarity connected to earth

As the polarity connected to earth does not have to be interrupted (in the example it is assumed that the polarity connected to earth is negative, although the following is also valid with the polarity inverted), the diagram which shows the connection of 4 poles in series on the polarity not connected to earth may be used.

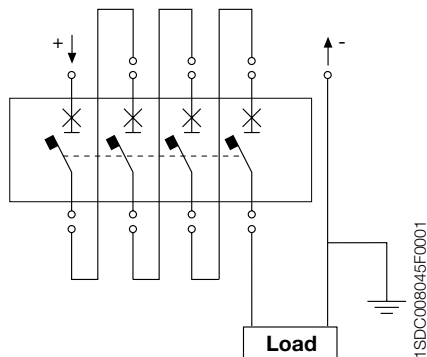

**C) 4 poles in series (1000 Vdc)**

## 4 Special applications

### Networks with median point of the supply source connected to earth

In the presence of an earth fault of positive or negative polarity, the poles involved in the fault work at  $U/2$  (500 V); the following diagram must be used:

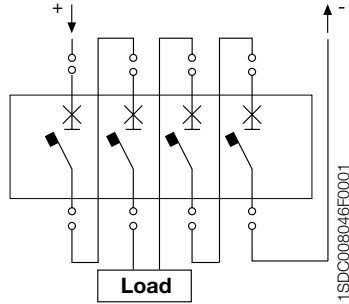

D) 2+2 poles in series (1000 Vdc)

### Correction factors for tripping thresholds

With regard to overload protection, no correction factors need to be applied. However, for the magnetic threshold values in use with 1000 Vdc with the previously described applicable diagrams, refer to the corresponding values for alternating current, multiplied by the correction factors given in the following table:

Circuit-breaker	$k_m$
T4V	1
T5V	0.9
T6L	0.9

### Circuit-breakers with thermomagnetic release for direct current

In [A]	32 <sup>(1)</sup>	50 <sup>(1)</sup>	80 <sup>(2)</sup>	100 <sup>(2)</sup>	125 <sup>(2)</sup>	160 <sup>(2)</sup>	200 <sup>(2)</sup>	250 <sup>(2)</sup>	320 <sup>(2)</sup>	400 <sup>(2)</sup>	500 <sup>(2)</sup>	630 <sup>(2)</sup>	800 <sup>(2)</sup>
T4V 250	■	■	■	■	■	■	■	■	-	-	-	-	-
T5V 400	-	-	-	-	-	-	-	-	■	■	-	-	-
T5V 630	-	-	-	-	-	-	-	-	-	-	■	-	-
T6L 630	-	-	-	-	-	-	-	-	-	-	-	■	-
T6L 800	-	-	-	-	-	-	-	-	-	-	-	-	■
$I_3 = (10 \times I_n)$ [A]	320	500	-	-	-	-	-	-	-	-	-	-	-
$I_3 = (5 - 10 \times I_n)$ [A]	-	-	400÷800	500÷1000	625÷1250	800÷1600	1000÷2000	1250÷2500	1600÷3200	2000÷4000	2500÷5000	3150÷6300	4000÷8000

<sup>(1)</sup> Thermal threshold adjustable from 0.7 and  $1 \times I_n$ ; fixed magnetic threshold

<sup>(2)</sup> Thermal threshold adjustable from 0.7 and  $1 \times I_n$ ; magnetic threshold adjustable between 5 and  $10 \times I_n$ .

## 4 Special applications

### Example

To ensure the protection of a user supplied with a network having the following characteristics:

Rated voltage	$U_r = 1000 \text{ Vdc}$
Short-circuit current	$I_k = 18 \text{ kA}$
Load current	$I_b = 420 \text{ A}$

Network with both polarities insulated from earth.

From the table of available settings, the circuit-breaker to be used is:

T5V 630  $I_n=500$  four-pole  $I_{cu}@1000 \text{ Vdc} = 40 \text{ kA}$

Thermal trip threshold adjustable from  $(0.7-1) \times I_n$  therefore from 350 A to 500 A to be set at 0.84.

Magnetic trip threshold adjustable from  $(5-10) \times I_n$  which with correction factor  $k_m = 0.9$  gives the following adjustment range: 2250 A to 4500 A. The magnetic threshold will be adjusted according to any conductors to be protected.

The connection of the poles must be as described in diagrams A or B.

A device which signals any first earth fault must be present.

With the same system data, if the network is carried out with a polarity connected to earth, the circuit-breaker must be connected as described in diagram C.

## 4 Special applications

### 1000 Vdc air switch disconnectors

The air switch disconnectors derived from the Emax air breakers are identified by the standard range code together with the code “/E MS”.

These comply with the international Standard IEC 60947-3 and are especially suitable for use as bus-ties or principle isolators in direct current installations, for example in electrical traction applications.

The overall dimensions and the fixing points remain unaltered from those of standard breakers, and they can be fitted with various terminal kits and all the accessories for the Emax range; they are available in both withdrawable and fixed versions, and in three-pole version (up to 750 Vdc) and four-pole (up to 1000 Vdc).

The withdrawable breakers are assembled with special version fixed parts for applications of 750/1000 Vdc.

The range covers all installation requirements up to 1000 Vdc / 6300 A or up to 750 Vdc / 6300 A.

A breaking capacity equal to the rated short-time withstand current is attributed to these breakers when they are associated with a suitable external relay.

The following table shows the available versions and their relative electrical performance:

		E1B/E MS		E2N/E MS		E3H/E MS		E4H/E MS		E6H/E MS		
		[A]	[A]	[A]	[A]	[A]	[A]	[A]	[A]	[A]	[A]	
Rated current (at 40 °C) $I_n$	[A]	800		1250		1250		3200		5000		
	[A]	1250		1600		1600		4000		6300		
	[A]			2000		2000						
	[A]					2500						
	[A]					3200						
Poles		3	4	3	4	3	4	3	4	3	4	
Rated service voltage $U_e$	[V]	750	1000	750	1000	750	1000	750	1000	750	1000	
Rated insulation voltage $U_i$	[V]	1000	1000	1000	1000	1000	1000	1000	1000	1000	1000	
Rated impulse withstand voltage $U_{imp}$	[kV]	12	12	12	12	12	12	12	12	12	12	
Rated short-time withstand current $I_{cw}$ (1s)	[kA]	20	20 <sup>(1)</sup>	25	25 <sup>(1)</sup>	40	40 <sup>(1)</sup>	65	65	65	65	
Rated making capacity $I_{cm}$	750VDC	[kA]	42	42	52.5	52.5	105	105	143	143	143	143
	1000VDC		-	42	-	52.5	-	105	-	143	-	143

**Note:** The breaking capacity  $I_{cu}$ , by means of external protection relay, with 500 ms maximum timing, is equal to the value of  $I_{cw}$  (1s).

(1) The performances at 750 V are:

for E1B/E MS  $I_{cw}$  = 25 kA,

for E2N/E MS  $I_{cw}$  = 40 kA and

for E3H/E MS  $I_{cw}$  = 50 kA.

## 4 Special applications

### Connection diagrams

Connection diagrams to be used according to the type of distribution system follow.

The risk of a double earth fault on different poles is assumed to be zero, that is, the fault current involves only one part of the breaker poles.

### Networks insulated from earth

The following diagrams may be used (the polarity may be inverted).

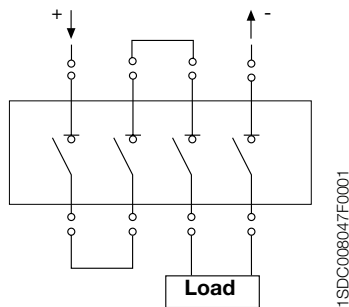

**E** 3+1 poles in series (1000 Vdc)

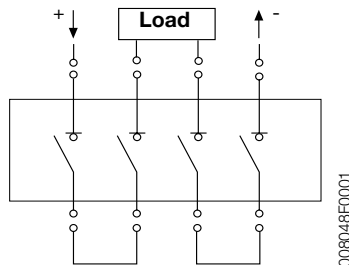

**F** 2+2 poles in series (1000 Vdc)



## 4 Special applications

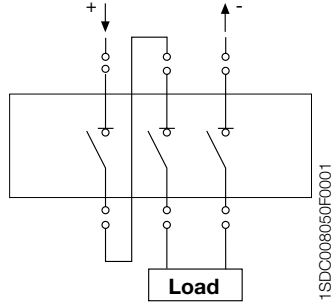

**G)** 2+1 poles in series (750 Vdc)

### Networks with one polarity connected to earth

The polarity connected to earth does not have to be interrupted (in the examples it is assumed that the polarity connected to earth is negative):

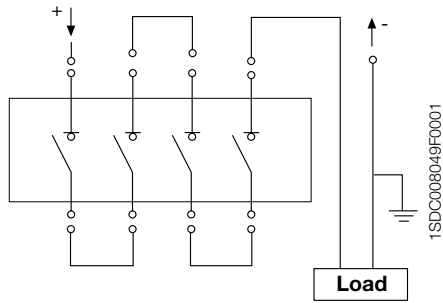

**H)** 4 poles in series (1000 Vdc)

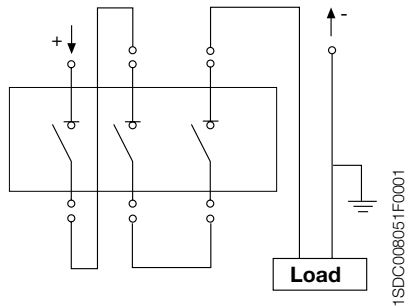

**I)** 3 poles in series (750 Vdc)

### Networks with median point of the supply source connected to earth

Only four-pole breakers may be used as in the configuration shown in diagram F).

## 4 Special applications

### 5.3.2 1000 Vac networks

#### Moulded-case circuit-breakers up to 1150 Vac

##### General characteristics

The circuit-breakers in the Tmax range up to 1150 V comply with the international standard IEC 60947-2.

These circuit breakers can be fitted with thermo-magnetic releases (for the smaller sizes) and with electronic releases. All installation requirements can be met with a range of available settings from 32 A to 800 A and with breaking capacity up to 20 kA at 1150 Vac.

#### Moulded-case circuit-breakers up to 1150 Vac

Rated uninterrupted current, <b>I<sub>u</sub></b>	[A]	
Poles	Nr.	
Rated service voltage, <b>U<sub>e</sub></b> (ac) 50-60Hz	[V]	
Rated impulse withstand voltage, <b>U<sub>imp</sub></b>	[kV]	
Rated insulation voltage, <b>U<sub>i</sub></b>	[V]	
Test voltage at industrial frequency for 1 min.	[V]	
Rated ultimate short-circuit breaking capacity, <b>I<sub>cu</sub></b>	(ac) 50-60 Hz 1000 V [kA]	
	(ac) 50-60 Hz 1150 V [kA]	
Rated service short-circuit breaking capacity, <b>I<sub>cs</sub></b>	(ac) 50-60 Hz 1000 V [kA]	
	(ac) 50-60 Hz 1150 V [kA]	
Rated short-circuit making capacity <b>I<sub>cm</sub></b>	(ac) 50-60 Hz 1000 V [kA]	
	(ac) 50-60 Hz 1150 V [kA]	
Utilisation category (EN 60947-2)		
Isolation behaviour		
Reference Standard		
Thermomagnetic releases	TMD	
	TMA	
Electronic releases	PR221DS/LS	
	PR221DS/I	
	PR222DS/P-LSI	
	PR222DS/P-LSIG	
	PR222DS/PD-LSI	
	PR222DS/PD-LSIG	
PR222MP		
Terminals		
Version		
Mechanical life	[No. operations]	
	[No. operations per hours]	
Basic dimension-fixed version <sup>(5)</sup>	3 poles W [mm]	
	4 poles W [mm]	
	D [mm]	
	H [mm]	
Weight	fixed	3/4 poles [kg]
	plug-in	3/4 poles [kg]
	withdrawable	3/4 poles [kg]

<sup>(1)</sup> Power supply only from above

<sup>(2)</sup> I<sub>cu</sub>=5kA

<sup>(3)</sup> I<sub>cu</sub>=7.6kA (630A) - 10kA (800A)

<sup>(4)</sup> Tmax T5630 is only available in the fixed version

<sup>(5)</sup> Circuit-breaker without high terminal covers

## 4 Special applications

The circuit-breakers in the range up to 1150 V maintain the same dimension as standard circuit breakers.

These circuit-breakers can also be fitted with the relevant range of standard accessories, with the exception of residual current releases.

The following tables show the electrical characteristics of the range:

<b>T4</b>			<b>T5</b>			<b>T6</b>		
<b>250</b>			<b>400/630</b>			<b>630/800</b>		
3, 4			3, 4			3, 4		
1000		1150	1000		1150	1000		1150
8			8			8		
1000		1150	1000		1150	1000		1150
3500			3500			3500		
<b>L</b>		<b>V</b>	<b>L</b>		<b>V<sup>(1)</sup></b>	<b>L<sup>(1)</sup></b>		<b>V<sup>(1)</sup></b>
12		20	12		20	12		20
		12			12			12
12		12	10		10			6
		6			6			
24		40	24		40			24
		24			24			
<b>A</b>			<b>B (400 A)<sup>(2)</sup>/A (630 A)</b>			<b>B<sup>(3)</sup></b>		
■			■			■		
IEC 60947-2			IEC 60947-2			IEC 60947-2		
-		■	-		-	-		-
-		■	-		■	-		■
■		■	■		■	■		■
■		■	■		■	■		■
■		■	■		■	■		■
■		■	■		■	■		■
■		■	■		■	■		■
■		■	■		■	■		■
■		-	■		-	■		-
FC Cu			FC Cu			F-FC CuAl-R		
F, P, W		F	F, P, W <sup>(4)</sup>		F			F
20000			20000			20000		
240			120			120		
105			140			210		
140			184			280		
103.5			103.5			103.5		
205			205			268		
2.35/3.05		2.35/3.05	3.25/4.15		3.25/4.15			9.5/12
3.6/4.65			5.15/6.65					
3.85/4.9			5.4/6.9					

TERMINAL CAPTION

F=Front

FC Cu= Front for copper cables

FC CuAl=Front for CuAl cables

R= Rear orientated

## 4 Special applications

The following tables show the available releases.

### Circuit-breakers with electronic release for alternating currents

	In100	In250	In320	In400	In630	In800
T4 250	■	■	-	-	-	-
T5 400	-	-	■	■	-	-
T5 630	-	-	-	-	■	-
T6L 630	-	-	-	-	■	-
T6L 800	-	-	-	-	-	■
$I_s$ (1÷10x In) [A] <sup>(1)</sup>	100÷1000	250÷2500	320÷3200	400÷4000	630÷6300	800÷8000
$I_s$ (1.5÷12 x In) [A] <sup>(2)</sup>	150÷1200	375÷3000	480÷3840	600÷4800	945÷7560	1200÷9600

<sup>(1)</sup> PR221

<sup>(2)</sup> PR222

### Circuit-breakers with thermomagnetic release for alternating currents

In [A]	32 <sup>(1)</sup>	50 <sup>(1)</sup>	80 <sup>(2)</sup>	100 <sup>(2)</sup>	125 <sup>(2)</sup>	160 <sup>(2)</sup>	200 <sup>(2)</sup>	250 <sup>(2)</sup>	320 <sup>(2)</sup>	400 <sup>(2)</sup>	500 <sup>(2)</sup>	630 <sup>(2)</sup>	800 <sup>(2)</sup>
T4V 250	■	■	■	■	■	■	■	■	-	-	-	-	-
T5V 400	-	-	-	-	-	-	-	-	■	■	-	-	-
T5V 630	-	-	-	-	-	-	-	-	-	-	■	-	-
T6L 630	-	-	-	-	-	-	-	-	-	-	-	■	-
T6L 800	-	-	-	-	-	-	-	-	-	-	-	-	■
$I_s = (10xI_n)$ [A]	320	500	-	-	-	-	-	-	-	-	-	-	-
$I_s = (5-10xI_n)$ [A]	-	-	400÷800	500÷1000	625÷1250	800÷1600	1000÷2000	1250÷2500	1600÷3200	2000÷4000	2500÷5000	31500÷6300	4000÷8000

<sup>(1)</sup> Thermal threshold adjustable from 0.7 and 1 x In; fixed magnetic threshold

<sup>(2)</sup> Thermal threshold adjustable from 0.7 and 1 x In; magnetic threshold adjustable between 5 and 10 x In.

### Air circuit-breakers and switch disconnectors up to 1150 Vac

For 1150 V alternating current applications, the following devices are available:

- **Circuit-breakers** in compliance with Standard IEC 60947-2

The special version breakers up to 1150 Vac are identified by the standard range code together with the suffix “/E”, and are derived from the correspondent Emax standard breakers and retain the same versions, accessories and overall dimensions.

The Emax range of breakers is available in both withdrawable and fixed versions with three and four poles, and can be fitted with accessories and equipped with the full range of electronic releases and microprocessors (PR332/P-PR333/P-PR121-PR122-PR123).

- **Switch disconnectors** in compliance with Standard IEC 60947-3

These breakers are identified by the code of the standard range, from which they are derived, together with the suffix “/E MS”. Three-pole and four-pole versions are available in both withdrawable and fixed versions with the same dimensions, accessory characteristics and installation as the standard switch disconnectors.

## 4 Special applications

The following tables show the electrical characteristics of the devices:

### Air circuit-breakers (up to 1150 Vac)

		XIB/E	E2B/E		E2N/E		E3H/E					E4H/E		E6H/E				
Rated uninterrupted current (at 40 °C) <b>I<sub>u</sub></b>	[A]	630/800 1000/1250 1600	1600	2000	1250	1600	2000	1250	1600	2000	2500	3200	3200	4000	4000	5000	6300	
	Rated service voltage <b>U<sub>e</sub></b>	[V-]	1000	1150	1150	1150	1150	1150	1150	1150	1150	1150	1150	1150	1150	1150	1150	1150
Rated insulation voltage <b>U<sub>i</sub></b>	[V-]	1000	1250	1250	1250	1250	1250	1250	1250	1250	1250	1250	1250	1250	1250	1250	1250	1250
Rated ultimate breaking capacity under short-circuit <b>I<sub>cu</sub></b>																		
1000 V	[kA]	20	20	20	30	30	30	50	50	50	50	50	65	65	65	65	65	65
1150 V	[kA]		20	20	30	30	30	30	30	30	30	30	65	65	65	65	65	65
Rated service breaking capacity under short-circuit <b>I<sub>cs</sub></b>																		
1000 V	[kA]	20	20	20	30	30	30	50	50	50	50	50	65	65	65	65	65	65
1150 V	[kA]		20	20	30	30	30	30	30	30	30	30	65	65	65	65	65	65
Rated short-time withstand current <b>I<sub>cw</sub></b> (1s)	[kA]	20	20	20	30	30	30	50 <sup>(1)</sup>	50 <sup>(1)</sup>	50 <sup>(1)</sup>	50 <sup>(1)</sup>	50 <sup>(1)</sup>	65	65	65	65	65	65
Rated making capacity under short-circuit (peak value) <b>I<sub>cm</sub></b>																		
1000 V	[kA]	40	40	40	63	63	63	105	105	105	105	105	143	143	143	143	143	143
1150 V	[kA]		40	40	63	63	63	63	63	63	63	63	143	143	143	143	143	143

<sup>(1)</sup> 30 kA @ 1150 V

### Air switch disconnectors (up to 1150 Vac)

		XIB/E MS	E2B/E MS	E2N/E MS	E3H/E MS	E4H/E MS	E6H/E MS
Rated current (at 40 °C) <b>I<sub>u</sub></b>	[A]	1000	1600	1250	1250	3200	4000
	[A]	1250	2000	1600	1600	4000	5000
	[A]	1600		2000	2000		6300
	[A]				2500		
	[A]				3200		
Poles		3/4	3/4	3/4	3/4	3/4	3/4
Rated service voltage <b>U<sub>e</sub></b>	[V]	1000	1150	1150	1150	1150	1150
Rated insulation voltage <b>U<sub>i</sub></b>	[V]	1000	1250	1250	1250	1250	1250
Rated impulse withstand voltage <b>U<sub>imp</sub></b>	[kV]	12	12	12	12	12	12
Rated short-time withstand voltage <b>I<sub>cw</sub></b> (1s)	[kA]	20	20	30	30 <sup>(1)</sup>	63	65
Rated making capacity under short-circuit (peak value) <b>I<sub>cm</sub></b>	[kA]	40	40	63	63 <sup>(2)</sup>	143	143

Note: The breaking capacity **I<sub>cu</sub>**, by means of external protection relay, with 500 ms maximum timing, is equal to the value of **I<sub>cw</sub>** (1s).

<sup>(1)</sup> The performance at 1000V is 50 kA

<sup>(2)</sup> The performance at 1000V is 105 kA

## 4 Special applications

### 4.4 Automatic Transfer Switches

In the electrical plants, where a high reliability is required from the power supply source because the operation cycle cannot be interrupted and the risk of a lack of power supply is unacceptable, an emergency line supply is indispensable to avoid the loss of large quantities of data, damages to working processes, plant stops etc.

For these reasons, transfer switch devices are used mainly for:

- power supply of hotels and airports;
- surgical rooms and primary services in hospitals;
- power supply of UPS groups;
- databanks, telecommunication systems, PC rooms;
- power supply of industrial lines for continuous processes.

ATS020 (in the versions 021 and 022) is the solution offered by ABB: it is an automatic transfer switch system with micro-processor based technology which allows switching of the supply from the normal line (N-Line) to the emergency line (E-Line) in case any of the following anomalies occurs on the main network:

- overvoltages and voltage dips;
- lack of one of the phases;
- asymmetries in the phase cycle;
- frequency values out of the setting range.

Then, when the network standard parameters are recovered, the system switches again the power supply to the main network (N-Line).

ATS020 is used in systems with two distinct supply lines connected to the same busbar system and functioning independently ("island condition"): the first one is used as normal supply line, the second is used for emergency power supply from a generator system. With ATS022 is also possible to provide the system with a device to disconnect the non-priority loads when the network is supplied from the E-Line.

The following scheme shows a plant having a safety auxiliary power supply:

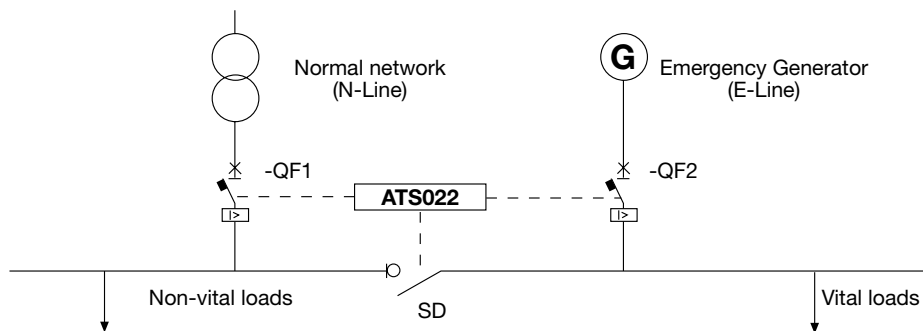

## 4 Special applications

ATS020 device is interfaced by means of appropriate terminals:

- with the protection circuit-breakers of the N-Line and of the E-Line, motorized and mechanically interlocked, to detect their status and send opening and closing commands according to the set time delays;
- with the control card of the Gen set to control its status and send start and stop commands;
- with any further signals coming from the plant in order to block the switching logic;
- with the N-Line to detect any possible anomaly and with the E-Line to verify the voltage presence;
- with an additional device to disconnect non-priority loads;
- with an auxiliary power supply at  $24 \text{ Vdc} \pm 20\%$  (or  $48 \text{ Vdc} \pm 10\%$ ). This supply source shall be present also in case of lack of voltage on both lines (N-Line and E-Line).

---

## 5 Switchboards

---

### 5.1 Electrical switchboards

An electrical assembly is a combination of more protection and switching devices, grouped together in one or more adjacent cases (column).

In an assembly the following parts can be distinguished: a case, called enclosure by the Standards, (it has the function of support and mechanical protection of the housed components), and the electrical equipment, formed by the internal connections and by the incoming and outgoing terminals for the connections to the plant). As all the components of an electrical system, also assemblies shall comply with the relevant product standard.

As far as Standards are concerned, an evolution has occurred with the replacement of the former IEC 60439-1 with the Stds. IEC 61439-1 and IEC 61439-2. The recent publication of the new Standard IEC 61439 has imposed an evolution and a refinement of the concept of switchgear and controlgear assembly, which has remained actually unchanged since 1990 when “Factory Assembled Boards” concept was replaced by TTA (Type-Tested Assemblies) and PTTA (Partially-Type-Tested Assemblies).

The new Standard still considers an assembly as a standard component of the plant, such as a circuit-breaker or a plug-and-socket, although it is constituted by the assembling of more apparatus, grouped together in one or more adjacent units (columns).

In an assembly the following parts can be distinguished: a case, called enclosure by the Standards, (it has the function of support and mechanical protection of the housed components), and the electrical equipment, formed by the internal connections and by the incoming and outgoing terminals for the connections to the plant). Such system shall be assembled in order to meet the safety requirements and satisfy as much as possible the functions for which it has been designed.

From this point of view, in Italy, the Law 46/90 and now the Ministerial Decree 37/08 oblige manufacturers to undersign a declaration of conformity to the rule for each action carried out on a plant excepted for ordinary maintenance. In the mandatory enclosures to this Declaration, in the list of the materials installed or changed, the assembly which has undergone actions is frequently mentioned.

As already known, to comply with the Article 2 of the Italian Law 186 dated 1st March 1968, the equipment and plants realized in compliance with CEI EN Standards are considered in accordance with the “rule of the art”. Therefore, as all the components of an electrical plant, also the assembly shall comply with the relevant product Standard. On this subject Stds. IEC 61439-1 and 2 have recently entered in force at international level, acknowledged within the corresponding Italian Standards CEI EN 61439-1 and 2.



## 5 Switchboards

These Standards apply to the low voltage assemblies for which the rated voltage does not exceed 1000 V in case of a.c. or 1500 V in case of d.c.).

IEC 61439-1 gives the general rules for LV assemblies, whilst the other parts to be issued concern the specific typologies of assemblies and are to be read together with the general rules. The envisaged parts are the following ones:

- IEC 61439-2: "Power switchgear and controlgear";
- IEC 61439-3: "Distribution boards" (to supersede IEC 60439-3);
- IEC 61439-4: "Assemblies for construction sites" (to supersede IEC 60439-4);
- IEC 61439-5: "Assemblies for power distribution" (to supersede IEC 60439-5);
- IEC 61439-6: "Busbar trunking systems" (to supersede IEC 60439-2).

Two other documents published by IEC about switchgear and controlgear assemblies are still available:

- the Std. IEC 60890 which represents a method of temperature rise assessment by calculation or by the application of design rules;
- the Std. IEC/TR 1117 which represents a method for assessing the short-circuit withstand strength by calculation or by the application of design rules.

### The Std. IEC 61439-1

As already said, the new package of Standards, defined by IEC through code 61439, consists of the basic Standard 61439-1 and by the specific Standards referred to the assembly typology. The first Standard deals with the characteristics, the properties and the performances which are in common to all the assemblies then considered in the relevant specific Standard.

This is the present structure of the new IEC 61439:

- 1) IEC 61439-1: "Low-voltage switchgear and controlgear assemblies - Part 1: "General rules";
- 2) IEC 61439-2: "Power switchgear and controlgear";
- 3) IEC 61439-3: "Distribution boards";
- 4) IEC 61439-4: "Assemblies for construction sites";
- 5) IEC 61439-5: "Assemblies for power distribution";
- 6) IEC 61439-6: "Busbar trunking systems".

As regards the declaration of conformity, each specific assembly typology shall be declared in compliance with the relevant product standard (that is the power switchgear and controlgear shall be declared complying with IEC 61439-2; the distribution boards in compliance with IEC 61439-3).

## 5 Switchboards

The passage, from the previous Std. IEC 60439 to the present IEC 61439, shall occur as follows: The “old” Std. 60439-1 shall be gradually superseded by the new Standards 61439-1 and 2, which are already available, but shall remain in force up to 31st October 2014 for the Power Switchgear and Controlgear (also called PSC-ASSEMBLIES). After that date, the new PSC assemblies shall have to comply only with the new Standards.

The period of validity for the Std. 60439-1 and for the other ones 60439-X extends up to 2014, for the construction of the other special assemblies (construction sites, busbar trunking systems, distribution, etc.), since for the time being these new standards are only envisaged, scheduled but non available yet.

The basic Standard establishes the requirements for the construction, safety and maintenance of the electrical assemblies by identifying the rated characteristics, the service environmental conditions, the mechanical and electrical requirements and the prescriptions relevant to the performances.

The former Std. dated 1990 divided the assemblies into two types, defining them TTA (type-tested assemblies) and PTTA (partially type-tested assemblies), according to their total or partial compliance with the laboratory type tests. The new Standard eliminates this dualism replacing it with the concept of “conforming” assembly, that is any assembly which complies with the design verifications prescribed by the Standard itself.

To this purpose, the Standard introduces three different but equivalent types of verification of requirements of conformity for an assembly; they are:

- 1) verification by laboratory testing (formerly called routine tests and now verification by testing);
- 2) verification by calculation (using old and new algorithms);
- 3) verification by satisfying design rules (analysis and considerations which are independent from the tests; verification by physical/analytical criteria or design deductions).

The different characteristics (temperature-rise, insulation, corrosion etc.) can be guaranteed by using any of these three methods; following one way or the other to guarantee the conformity of the assembly is unimportant.

Since it is not always possible to choose possible one of the three methods, Table D.1 of the Annex D of the Standard (see Table on the following page) lists for each characteristic to be verified which one of the three types of verification may be used.

## 5 Switchboards

No.	Characteristics to be verified	Clauses or subclauses	Verification options available		
			Verification by testing	Verification by calculation	Verification by satisfying design rules
1	Strength of materials and parts of the assembly:	10.2			
	Resistance to corrosion	10.2.2	YES	NO	NO
	Properties of insulating materials:	10.2.3			
	Thermal stability	10.2.3.1	YES	NO	NO
	Resistance of insulating material to normal heat	10.2.3.2	YES	NO	NO
	Resistance of insulating materials to abnormal heat and fire due to internal electric effects	10.2.3.3	YES	NO	NO
	Resistance to ultraviolet (UV) radiation				
	Lifting	10.2.4	YES	NO	NO
	Mechanical impact	10.2.4	YES	NO	NO
Marking	10.2.6	YES	NO	NO	
	10.2.7	YES	NO	NO	
2	Degree of protection of the enclosures	10.3	YES	NO	YES
3	Clearances and creepage distances	10.4	YES	YES	YES
4	Protection against electric shock and integrity of protective circuits:	10.5			
	Effective continuity between the exposed conductive parts of the assembly and the protective circuit	10.5.2	YES	NO	NO
	Effectiveness of the assembly for external faults	10.5.3	YES	YES	YES
5	Installation of switching devices and components	10.6	NO	NO	YES
6	Internal electrical circuits and connections	10.7	NO	NO	YES
7	Terminals for external conductors	10.8	NO	NO	YES
8	Dielectric properties:	10.9			
	Power-frequency withstand voltage	10.9.2	YES	NO	NO
	Impulse withstand voltage	10.9.3	YES	NO	YES
9	Temperature-rise limits	10.10	YES	YES	YES
10	Short-circuit withstand strength	10.11	YES	YES	YES
11	Electromagnetic compatibility (EMC)	10.12	YES	NO	YES
12	Mechanical operation	10.13	YES	NO	NO

## 5 Switchboards

As it can be noticed, for some characteristics, such as the resistance to corrosion or to mechanical impact only the verification by testing is accepted; instead, for other characteristics such as temperature-rise and short-circuit, the three verification modalities are all accepted: testing, calculation or design rules. Another important change in the new Standard is the better specification of the manufacturer figure. In particular two “ways of being” are defined for the manufacturer: the “original” manufacturer and the “assembly” manufacturer. The first one is the subject who has carried out initially the original design of the series to which belongs the assembly to be completed and to this purpose has carried out the design verifications (formerly type tests), the derivation calculations or the design rules, to cover all the available possibilities for the assembly verification.

It is evident that the highest and most performing the layouts that the original manufacturer is able to “standardize” and to propose, the greater the possibilities for him to have his assemblies constructed and consequently to make a good profit. The second one, identified as “assembly” manufacturer, is the subject who really builds the assembly, that is who gets the different parts and components and mounts them as required, thus carrying out the completed assembly, mounted and wired, exploiting one of the design opportunity already mentioned, ready to use, offered by the “original” manufacturer.

The Standard still accepts that some phases of the fitting of assemblies are carried out also out of the manufacturer’s laboratory or workshop (on site or on machine board), but the Std. instructions must be complied with. From an operational point of view, the manufacturers and the panel builders, i.e. the end manufacturers, could use as usual the products sold in kits and included in the catalogues of the “original” manufacturers, for assembling according to the arrangement they need.

To summarize, the “original” manufacturer shall:

- design (calculate, design and carry out) the desired assembly line;
- test some prototypes belonging to that assembly line;
- pass these tests to demonstrate the compliance with the mandatory prescriptions of the Standard;
- derive from the tests other configurations by calculation or other evaluations or measurements;
- add other configurations obtained without testing but thanks to suitable “design rules”;
- collect all the above mentioned information and make them available for the end customer by means of catalogues, slide rules or software, so that he can build the new assembly and use it and manage it as best as possible, by carrying out the suitable controls and maintenance.

## 5 Switchboards

The list of the design verifications prescribed by the Standard under the responsibility of the “original” manufacturer who, in compliance with Table of page 217, shall decide how to perform them includes the following:

Verification of the characteristics relevant to construction:

- Strength of materials and parts of the assembly;
- Degrees of protection IP of the assembly;
- Clearances and creepage distances;
- Protection against electric shock and integrity of protective circuits;
- Incorporation of switching devices and of components;
- Internal electrical circuits and connections;
- Terminals for external conductors.

Verifications of the characteristic relevant to the performance:

- Dielectric properties (power-frequency withstand voltage at 50 Hz and impulse withstand voltage);
- Verification of temperature-rise limits;
- Short-circuit withstand strength;
- Electromagnetic compatibility (EMC);
- Mechanical operation.

Instead, the “assembly” manufacturer shall have the responsibility of:

- the choice and the fitting of the components in full compliance with the given instructions;
- the performance of the routine verification on each manufactured assembly;
- the assembly certification.

The list of the routine tests prescribed by the Standard under the responsibility of the “assembly” manufacturer includes the following:

Characteristics pertaining to construction:

- Degrees of protection IP of the enclosure;
- Clearances and creepage distances;
- Protection against electric shock and integrity of protective circuits;
- Incorporation of switching devices and of components;
- Internal electrical circuits and connections;
- Terminals for external conductors;
- Mechanical operation.

Characteristics relevant to the performance:

- Dielectric properties (power-frequency withstand voltage at 50 Hz and impulse withstand voltage);
- Wiring and operation.

These verifications can be carried out in any sequence.

The fact that the routine verifications are carried out by the “assembly” manufacturer does not exempt the panel builder from verifying them after the transport and the erection of the assembly.

The main changes and news, introduced by the IEC 61439 in comparison with former IEC 60439, can be summarized with the diagrams shown in the next Figure.

# 5 Switchboards

**Standard IEC 60439-1**

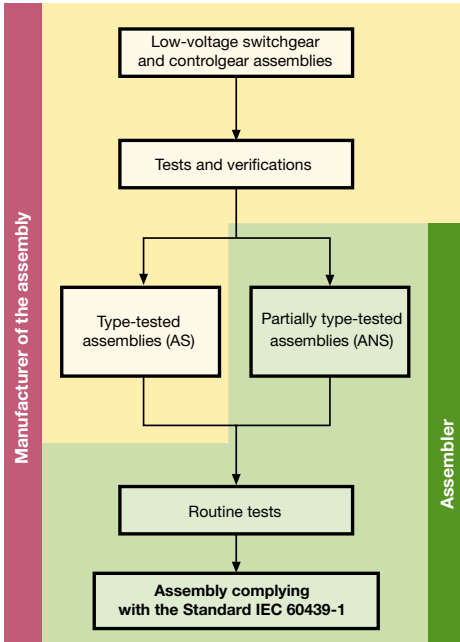

**Standard IEC 61439-1-2**

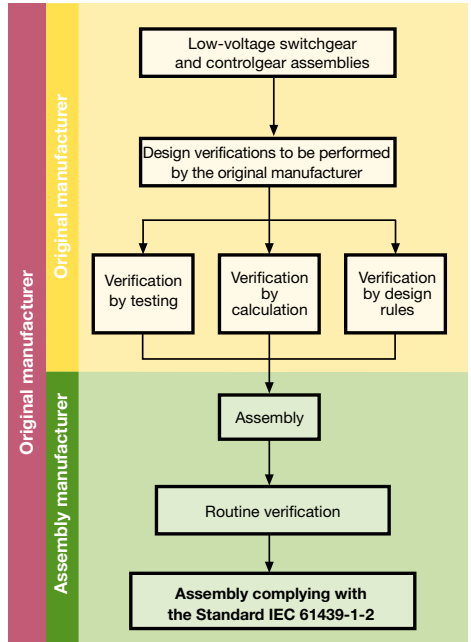

## 5 Switchboards

### Degrees of protection

The degree of protection IP indicates a level of protection provided by the assembly against access to or contact with live parts, against ingress of solid foreign bodies and against the ingress of liquid. The IP code is the system used for the identification of the degree of protection, in compliance with the requirements of Standard IEC 60529. Unless otherwise specified by the manufacturer, the degree of protection applies to the complete switchboard, assembled and installed for normal use (with door closed).

The manufacturer shall also state the degree of protection applicable to particular configurations which may arise in service, such as the degree of protection with the door open or with devices removed or withdrawn.

#### Elements of the IP Code and their meanings

Element	Numerals or letters	Meaning for the protection of equipment	Meaning for the protection of persons	Ref.
<b>Code letters</b>	<b>IP</b>			
First characteristic numeral		Against ingress of the solid foreign objects	Against access to hazardous parts with	Cl.5
	0	(non-protected)	(non-protected)	
	1	≥ 50 mm diameter	back of hand	
	2	≥ 12.5 mm diameter	finger	
	3	≥ 2.5 mm diameter	tool	
	4	≥ 1.0 mm diameter	wire	
	5	dust-protected	wire	
	6	dust-tight	wire	
Second characteristic numeral		Against ingress of water with harmful effects		Cl.6
	0	(non-protected)		
	1	vertically dripping		
	2	dripping (15° tilted)		
	3	spraying		
	4	splashing		
	5	jetting		
	6	powerful jetting		
	7	temporary immersion		
	8	continuous immersion		
Additional letter (optional)			Against access to hazardous parts with	Cl.7
	A		back of hand	
	B		finger	
	C		tool	
	D		wire	
Supplementary letter (optional)		Supplementary information specific to:		Cl.8
	H	High voltage apparatus		
	M	Motion during water test		
	S	Stationary during water test		
	W	Weather conditions		

## 5 Switchboards

### Form of separation and classification of switchboards

#### Forms of internal separation

By form of separation it is meant the type of subdivision provided within the switchboard. Separation by means of barriers or partitions (metallic or insulating) may have the function to:

- provide protection against direct contact (at least IPXXB) in the case of access to a part of the switchboard which is not live, with respect to the rest of the switchboard which remains live;
- reduce the risk of starting or propagating an internal arc;
- impede the passage of solid bodies between different parts of the switchboard (degree of protection of at least IP2X).

A partition is a separation element between two parts, while a barrier protects the operator from direct contact and from arcing effects from any interruption devices in the normal access direction.

The following table from Standard IEC 61439-1-2 highlights typical forms of separation which can be obtained using barriers or partitions:

Main criteria	Subcriteria	Form
No separation		Form 1
Separation of busbars from the functional units	Terminals for external conductors not separated from busbars	Form 2a
	Terminals for external conductors separated from busbars	Form 2b
Separation of busbars from the functional units and separation of all functional units from one another. Separation of the terminals for external conductors from the functional units, but not from each other	Terminals for external conductors not separated from busbars	Form 3a
	Terminals for external conductors separated from busbars	Form 3b
Separation of busbars from the functional units and separation of all functional units from one another, including the terminals for external conductors which are an integral part of the functional unit	Terminals for external conductors in the same compartment as the associated functional unit	Form 4a
	Terminals for external conductors not in the same compartment as the associated functional unit, but in individual, separate, enclosed protected spaces or compartments	Form 4b



## 5 Switchboards

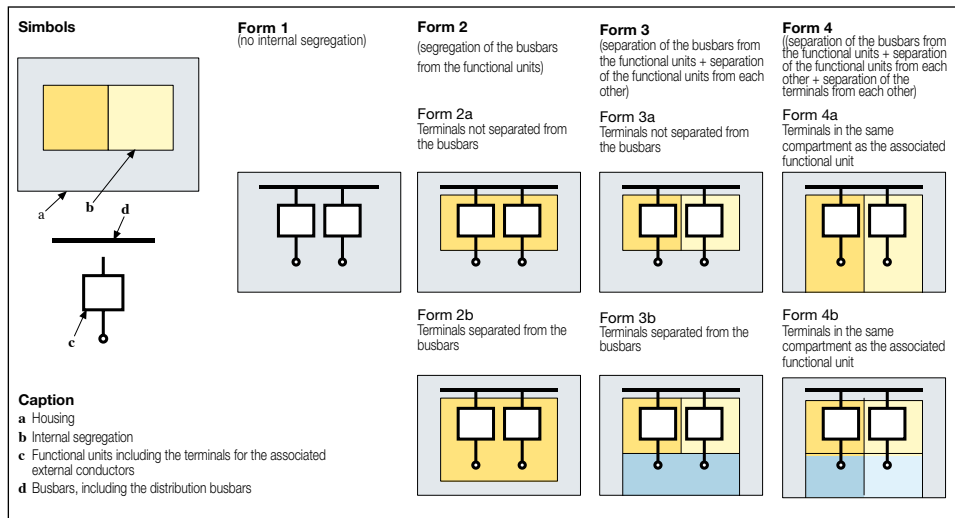

### Classification

Different classifications of electrical switchboard exist, depending on a range of factors.

Based on construction type, Standard IEC 61439-1 firstly distinguishes between open and enclosed assemblies.

A switchboard is enclosed when it comprises protective panels on all sides, providing a degree of protection against direct contact of at least IPXXB. Switchboards used in normal environments must be enclosed.

Open switchboards, with or without front covering, which have the live parts accessible. These switchboards may only be used in electrical plants.

With regard to external design, switchboards are divided into the following categories:

#### - Cubicle-type assembly

Used for large scale control and distribution equipment; multi-cubicle-type assembly can be obtained by placing cubicles side by side.

#### - Desk-type assembly

Used for the control of machinery or complex systems in the mechanical, iron and steel, and chemical industries.

#### - Box-type assembly

Characterized by wall mounting, either mounted on a wall or flush-fitting; these switchboards are generally used for distribution at department or zone level in industrial environments and in the tertiary sector.

## 5 Switchboards

### - Multi-box-type assembly

Each box, generally protected and flanged, contains a functional unit which may be an automatic circuit-breaker, a starter, a socket complete with locking switch or circuit-breaker.

With regard to the intended function, switchboards may be divided into the following types:

### - Main distribution boards

Main distribution boards are generally installed immediately downstream of MV/LV transformers, or of generators; they are also termed power centres. Main distribution boards comprise one or more incoming units, busbar connectors, and a relatively smaller number of output units.

### - Secondary distribution boards

Secondary distribution boards include a wide range of switchboards for the distribution of power, and are equipped with a single input unit and numerous output units.

### - Motor operation boards

Motor control boards are designed for the control and centralised protection of motors: therefore they comprise the relative coordinated devices for operation and protection, and auxiliary control and signalling devices.

### - Control, measurement and protection boards

Control, measurement and protection boards generally consist of desks containing mainly equipment for the control, monitoring and measurement of industrial processes and systems.

### - Machine-side boards

Machine-side boards are functionally similar to the above; their role is to provide an interface between the machine with the power supply and the operator.

### - Assemblies for construction sites (ASC)

Assemblies for construction sites may be of different sizes, from a simple plug and socket assembly to true distribution boards with enclosures of metal or insulating material. They are generally mobile or, in any case, transportable.

## Verification of the temperature-rise limits inside an assembly

### Introduction

The verification of the temperature-rise limits imposed by the Standard IEC 61439-1 can be carried out according to one or more of the following methods:

- verification test with current (in laboratory);
- deduction from design rules;
- algebraic calculation.

## 5 Switchboards

As a matter of fact, the Standard IEC 61439-1 prescribes compliance with the same temperature-rise limits of the previous version, limits which must not be exceeded during the temperature-rise test. These temperature-rise limits are applied taking into consideration an ambient temperature which must not exceed +40 °C and its average value referred to a 24 hour period shall not exceed +35 °C.

The following Table shows for the different components of the assembly, the temperature-rise limits given by the Standard.

Parts of assemblies	Temperature-rise K
Built-in components <sup>a)</sup>	(*) In accordance with the relevant product Standard requirements for the individual components or, in accordance with the manufacturer's instructions f), taking into consideration the temperature in the assembly
Terminals for external insulated conductors	70 <sup>b)</sup>
Busbars and conductors	Limited by: <ul style="list-style-type: none"> <li>- mechanical strength of conducting material <sup>g)</sup>;</li> <li>- possible effects on adjacent equipment;</li> <li>- permissible temperature limit of the insulating materials in contact with the conductor;</li> <li>- the effect of the temperature of the conductor on the apparatus connected to it;</li> <li>- for plug-in contacts, nature and surface treatment of the contact material.</li> </ul>
Manual operating means:	
- of metal	15 <sup>c)</sup>
- of insulating materials	25 <sup>c)</sup>
Accessible external enclosures and covers:	
- metal surfaces	30 <sup>d)</sup>
- insulating surfaces	40 <sup>d)</sup>
Discrete arrangements of plug and socket-type connections	Determined by the limits of those components of the related equipment of which they form part <sup>e)</sup>
<p><sup>a)</sup> The term "built-in components" means:</p> <ul style="list-style-type: none"> <li>- conventional switchgear and controlgear;</li> <li>- electronic sub-assemblies (e.g. rectifier bridge, printed circuit);</li> <li>- parts of the equipment (e.g. regulator, stabilized power supply unit, operational amplifier).</li> </ul> <p><sup>b)</sup> The temperature rise limit of 70 K is a value based on the conventional test of 10.10. An ASSEMBLY used or tested under installation conditions may have connections, the type, nature and disposition of which will not be the same as those adopted for the test, and a different temperature rise of terminals may result and may be required or accepted. Where terminals of the built-in component are also the terminals for external insulated conductors, the lower of the corresponding temperature-rise limits shall be applied.</p> <p><sup>c)</sup> Manual operating means within assemblies which are only accessible after the assembly has been opened, for example draw-out handles, which are operated infrequently, are allowed to assume a 25 K increase on these temperature-rise limits.</p> <p><sup>d)</sup> Unless otherwise specified in the case of covers and enclosures which are accessible but need not be touched during normal operation, an increase in the temperature-rise limits by 10 K is permissible. External surfaces and parts over 2 m from the base of the ASSEMBLY are considered inaccessible.</p> <p><sup>e)</sup> This allows a degree of flexibility in respect to equipment (e.g. electronic devices) which is subject to temperature-rise limits different from those normally associated with switchgear and controlgear.</p> <p><sup>f)</sup> For temperature-rise tests according to 10.10 the temperature-rise limits have to be specified by the Original Manufacturer taking into account any additional measuring points and limits imposed by the component manufacturer.</p> <p><sup>g)</sup> Assuming all other criteria listed are met a maximum temperature rise of 105 K for bare copper busbars and conductors shall not be exceeded.</p>	
<p>Nota: 105 K relates to the temperature above which annealing of copper is likely to occur. Other materials may have a different maximum temperature rise.</p>	

## 5 Switchboards

### Thermal verification of the assembly

As regards the temperature-rise limits, from the point of view of switchgear certification, it is possible to follow one of the three new available procedures, and in particular:

- 1) the verification test (formerly defined type-test), in which the temperature rises reached and maintained under service conditions are measured at pre-defined points inside the prototype assemblies actually tested with current at laboratory. Then these values are compared with the admissible ones (shown in the previous page); if the measured values are lower than or equal to the admissible ones, the test is considered as passed with those current values and under that determined conditions around (ambient temperature, humidity, etc.);
- 2) the derivation (from a cabled assembly tested) of similar variants; this procedure, applicable only if available the data obtained by testing, is used to verify the compliance of non-tested variants however answering to precise comparative rules with respect to the tested assembly arrangements.

The derived assemblies are considered in compliance if, compared with the tested arrangements, they have:

- the functional units of the same type (e.g.: same electrical diagrams, apparatus of the same size, same arrangements and fixing, same assembling structure, same cables and wiring) as the functional units used for the test;
- the same type of construction as used for the test;
- the same or increased overall dimensions as used for the test;
- the same or increased cooling conditions as used for the test (forced or natural convection, same or larger ventilation openings);
- the same or reduced internal separation as used for the test (if any);
- the same or reduced power losses in the same section as used for the test;
- the same or reduced number of outgoing circuits for every section.

## 5 Switchboards

3) the verification of the temperature rise through calculation. In this case the laboratory tests are not to be considered and mathematical algorithms of thermodynamic type – which are already in use since years by panel builders - are exploited. These methods of pure calculation are two, distinct and independent between them and alternative to tests. They are:

a) the so called “method of the powers” based on not-exceeding the upper limit of thermal power loss capability in a determined enclosure.

To establish the value of losses, in watt, the temperature rise in the empty assembly is simulated by inserting some adjustable heating resistors, which shall make the enclosure reach its thermal steady state.

Once the thermal steady state has been reached and after verifying that the temperature rise limits are included in the defined range, for each enclosure, the maximum value of the thermal power loss can be obtained.

This method is affected by some limitations and in particular is applied to switchgear assemblies:

- 1) with a single compartment and with current up to 630 A;
- 2) with homogeneous distribution of the internal losses;
- 3) in which the mechanical parts and the equipment installed are arranged so that air circulation is not but little hampered;
- 4) in which the conductors transport currents exceeding 200 A and the structural parts are so arranged that the losses due to eddy currents are negligible;
- 5) which house equipment used by the 80% of the specific conventional thermal current in free air.

b) the calculation algorithm of the Std. IEC 60890, applicable to multiple compartment assemblies rated current up to 1600 A (formerly up to 3150). In this case procedures of algebraic calculation without experimental data are used.

It is a calculation procedure which leads to the tracing, from bottom to top, of the thermal map of the assembly under steady state conditions, according to temperature values which grow linearly and reach their maximum value exactly at the top of the enclosure.

Thus, through the total power loss, it is possible to evaluate the temperature rise at different levels, inside the assembly, from bottom to top.

## 5 Switchboards

The Standards IEC 60890 and the IEC 61439-1 establishes that this calculation method is applicable only when the following conditions are met:

- the rated current of the assembly circuits shall not exceed 80% of the rated current (in free air) of the protective devices and of the electrical components installed in the circuit;
- there is an approximately even distribution of power loss inside the enclosure and there are no obstacles preventing its dispersion towards the outside of the assembly;
- the installed assembly is arranged so as that air circulation is little impeded;
- the installed assembly is designed for direct or alternating currents up to and including 60 Hz, with the total of supply currents not exceeding 1600 A;
- the conductors carrying currents exceeding 200 A and the structural parts are so arranged that eddy current losses are negligible;
- for the enclosures with ventilation openings, the cross-section of the air outlet openings is at least 1.1 times the cross-section of the air inlet openings;
- there are no more than three horizontal partitions for each section of the assembly;
- should the enclosures with external ventilation openings be divided into compartments, the surface of the ventilation openings in every internal horizontal partition shall be at least equal to 50% of the horizontal section of the compartment.

To calculate the temperature rise of the air inside an enclosure, once the requirements of the Standard have been met, the following must be considered:

- Dimensions of the enclosure
- Type of installation:
  - enclosure open to air on all sides;
  - wall-mounted enclosure;
  - enclosure designed for mounting in extremities;
  - enclosure in an internal position in a multicompartment switchboard;
- Any ventilation openings, and their dimensions
- Number of horizontal internal separators
- Power losses from the effective current flowing through any device and conductor installed within the switchboard or compartment.

The Standard allows the calculation of temperature rise of the air at mid-height and at the highest point of the switchboard.

Once the thermal map of the inside of the assembly from bottom to top has been drawn, the assembly is verified if the calculated air temperature at the mounting height of any device does not exceed the permissible ambient air temperature as declared by the device manufacturer.

This means for switching devices or electrical components in the main circuits that the continuous load does not exceed its permissible load at the calculated local air temperature and not more than 80 % of its rated current.

The Annex B explains the calculation method described in the Standard.

ABB supplies the client with calculation software which allows the temperature rise inside the switchboard to be calculated quickly.

---

# 5 Switchboards

---

## 5.2 MNS switchboards

MNS systems are suitable for applications in all fields concerning the generation, distribution and use of electrical energy; e. g., they can be used as:

- main and sub-distribution boards;
- motor power supply of MCCs (Motor Control Centres);
- automation switchboards.

The MNS system is a framework construction with maintenance-free bolted connections which can be equipped as required with standardized components and can be adapted to any application. The consistent application of the modular principle both in electrical and mechanical design permits optional selection of the structural design, interior arrangement and degree of protection according to the operating and environmental conditions.

The design and material used for the MNS system largely prevent the occurrence of electric arcs, or provide for arc extinguishing within a short time. The MNS System complies with the requirements laid down in VDE0660 Part 500 as well as IEC 61641 and has furthermore been subjected to extensive accidental arc tests by an independent institute.

The MNS system offers the user many alternative solutions and notable advantages in comparison with conventional-type installations:

- compact, space-saving design;
- back-to-back arrangement;
- optimized energy distribution in the cubicles;
- easy project and detail engineering through standardized components;
- comprehensive range of standardized modules;
- various design levels depending on operating and environmental conditions;
- easy combination of the different equipment systems, such as fixed and withdrawable modules in a single cubicle;
- possibility of arc-proof design (standard design with fixed module design);
- possibility of earthquake-, vibration- and shock-proof design;
- easy assembly without special tools;
- easy conversion and retrofit;
- largely maintenance-free;
- high operational reliability;
- high safety for human beings.

The basic elements of the frame are C-sections with holes at 25 mm intervals in compliance with Standard DIN 43660. All frame parts are secured maintenance-free with tapping screws or ESLOK screws. Based on the basic grid size of 25 mm, frames can be constructed for the various cubicle types without any special tools. Single or multi-cubicle switchgear assemblies for front or front and rear operations are possible.

Different designs are available, depending on the enclosure required:

- single equipment compartment door;
- double equipment compartment door;
- equipment and cable compartment door;
- module doors and/or withdrawable module covers and cable compartment door.

The bottom side of the cubicle can be provided with floor plates. With the aid of flanged plates, cable ducts can be provided to suit all requirements. Doors and cladding can be provided with one or more ventilation opening, roof plates can be provided with metallic grid (IP 30 – IP40) or with ventilation chimney (IP 40, 41, 42).

## 5 Switchboards

Depending on the requirements, a frame structure can be subdivided into the following compartments (functional areas):

- equipment compartment;
- busbar compartment;
- cable compartment.

The equipment compartment holds the equipment modules, the busbar compartment contains the busbars and distribution bars, the cable compartment houses the incoming and outgoing cables (optionally from above and from below) with the wiring required for connecting the modules as well as the supporting devices (cable mounting rails, cable connection parts, parallel connections, wiring ducts, etc.). The functional compartments of a cubicle as well as the cubicles themselves can be separated by partitions. Horizontal partitions with or without ventilation openings can also be inserted between the compartments.

All incoming/outgoing feeder and bus coupler cubicles include one switching device. These devices can be fixed-mounted switch disconnectors, fixed-mounted or withdrawable air or moulded-case circuit-breakers.

This type of cubicles is subdivided into equipment and busbar compartments; their size (H x W) is 2200 mm x 400 mm / 1200 mm x 600 mm, and the depth depends on the dimensions of the switchgear used.

Cubicles with air circuit-breakers up to 2000 A can be built in the reduced dimensioned version (W = 400 mm).

It is possible to interconnect cubicles to form optimal delivery units with a maximum width of 3000 mm.

### 5.3 ArTu distribution switchboards

The range of ABB SACE ArTu distribution switchboards provides a complete and integrated offer of switchboards and kit systems for constructing primary and secondary low voltage distribution switchboards.

With a single range of accessories and starting from simple assembly kits, the ArTu switchboards make it possible to assembly a wide range of configurations mounting modular, moulded-case and air circuit-breakers, with any internal separation up to Form 4.

ABB SACE offers a series of standardized kits, consisting of pre-drilled plates and panels for the installation of the whole range of circuit-breakers type System pro *M* compact, Tmax T, SACE Tmax XT and Emax X1, E1, E2, E3, E4 without the need of additional drilling operations or adaptations.

Special consideration has been given to cabling requirements, providing special seats to fix the plastic cabling duct horizontally and vertically.

Standardization of the components is extended to internal separation of the switchboard: in ArTu switchboards, separation is easily carried out and it does not require either construction of "made-to-measure" switchboards or any additional sheet cutting, bending or drilling work.

ArTu switchboards are characterized by the following features:

- integrated range of modular metalwork structures up to 4000 A with common accessories;
- possibility of fulfilling all application requirements in terms of installation (wall-mounting, floor-mounting, monoblock and cabinet kits) and degree of protection (IP31, IP41, IP43, IP65);
- structure made of hot-galvanized sheet;



## 5 Switchboards

- maximum integration with modular devices and ABB SACE moulded-case and air circuit-breakers;
- minimum switchboard assembly times thanks to the simplicity of the kits, the standardization of the small assembly items, the self-supporting elements and the presence of clear reference points for assembly of the plates and panels;
- separations in kits up to Form 4.

The range of ArTu switchboards includes four versions, which can be equipped with the same accessories.

### ArTu L series

ArTu L series consists of a range of modular switchboard kits, with a capacity of 24/36 modules per row and degree of protection IP31 (without door) or IP43 (basic version with door). These switchboards can be wall- or floor-mounted:

- wall-mounted ArTu L series, with heights of 600, 800, 1000 and 1200 mm, depth 204 mm, width 690 mm. Both System pro M modular devices and moulded-case circuit-breakers SACE Tmax XT and Tmax T1-T2-T3 are housed inside this switchboard series;
- floor-mounted ArTu L series, with heights of 1400, 1600, 1800 and 2000 mm, depth 240 mm, width 690/890 mm. System pro M modular devices, moulded- case circuit-breakers type SACE Tmax XT and Tmax T1-T2-T3-T4-T5-T6 (fixed version with front terminals) are housed inside this switchboard series.

### ArTu M series

ArTu M series consists of a range of modular switchboard kits, with a capacity of 24/36 modules per row and degree of protection IP31 (without door) or IP65. These switchboards can be wall- or floor-mounted:

- wall-mounted ArTu M series, with heights of 600, 800, 1000 and 1200 mm, depth 150/200 mm, width 600 mm. Both System pro M modular devices and moulded-case circuit-breakers SACE Tmax XT1-XT2-XT3 and Tmax T1-T2-T3 are housed inside this switchboard series;
- floor-mounted ArTu M series, with heights of 1400, 1600, 1800 and 2000 mm, depth 250 mm, width 600/800 mm. System pro M modular devices, moulded- case circuit-breakers type SACE Tmax XT and Tmax T1-T2-T3-T4-T5-T6 (fixed version with front terminals) are housed inside this switchboard series.

## 5 Switchboards

### ArTu K series

ArTu K series consists of a range of modular switchboard kits for floor-mounted installation with four different depths (150, 225, 300, 500, 700 and 800 mm) and with degree of protection IP31 (without front door), IP41 (with front door and ventilated side panels) or IP65 (with front door and blind side panels), in which it is possible to mount System pro M modular devices, the whole range of moulded-case circuit-breakers Tmax XT, Tmax T and Emax circuit-breakers X1, E1, E2, E3 and E4.

ArTu switchboards have three functional widths:

- 400 mm, for the installation of moulded-case circuit-breakers up to 630 A (T5);
- 600 mm, which is the basic dimension for the installation of all the apparatus;
- 800 mm, for the creation of the side cable container within the structure of the floor-mounted switchboard or for the use of panels with the same width.

The available internal space varies in height from 600 mm (wall-mounted L series) to 2000 mm (floor-mounted M series and K series), thus offering a possible solution for the most varied application requirements.

### ArTu PB Series (Panelboard and Pan Assembly)

The ArTu line is now upgraded with the new ArTu PB Panelboard solution.

The ArTu PB Panelboard is suitable for distribution applications with an incomer up to 800A and outgoing feeders up to 250A.

The ArTu PB Panelboard is extremely sturdy thanks to its new designed framework and it is available both in the wall-mounted version as well as in the floor-mounted one.

ArTu PB Panelboard customisation is extremely flexible due to the smart design based on configurations of 6, 12 and 18 outgoing ways and to the new ABB plug-in system that allows easy and fast connections for Tmax XT1-XT2-XT3 and Tmax T1-T2-T3.

Upon request, extension boxes are available on all sides of the structure, for metering purposes too.

The vertical trunking system is running behind the MCCB's layer allowing easy access to every accessory wiring (SR's, UV's, AUX contacts).

The ArTu PB Panelboard, supplied as a standard with a blind door, is available with a glazed one as well.

---

## **Annex A: Protection against short-circuit effects inside low-voltage switchboards**

The Std. IEC 61439-1 specifies that ASSEMBLIES (referred to hereafter as switchboards) shall be constructed so as to be capable of withstanding the thermal and dynamic stresses resulting from short-circuit currents up to the rated values.

Furthermore, switchboards shall be protected against short-circuit currents by means of circuit-breakers, fuses or a combination of both, which may either be incorporated in the switchboard or arranged upstream.

When ordering a switchboard, the user shall specify the short-circuit conditions at the point of installation.

This chapter takes into consideration the following aspects:

- the need or not to carry out the verification of the short-circuit withstand inside the assembly;
- the suitability of a switchgear for a plant according to the prospective short-circuit current of the plant and of the short-circuit parameters of the switchgear;
- the suitability of the busbar system according to the short-circuit current and to the protection devices;
- the verification of the short-circuit withstand of the assembly by applying the design rules defined in the IEC 61439-1.

## Annex A: Protection against short-circuit effects inside low-voltage switchboards

### Verification of short-circuit withstand strength

The verification of the short-circuit withstand strength is dealt with in the Standard IEC 61439-1, where, in particular, the cases requiring this verification and the different types of verification are specified.

The verification of the short-circuit withstand strength is not required if the following conditions are fulfilled:

- For switchboards having a rated short-time current ( $I_{cw}$ ) or rated conditional current ( $I_k$ ) not exceeding 10 kA.
- For switchboards protected by current limiting devices having a cut-off current not exceeding 17 kA at the maximum allowable prospective short-circuit current at the terminals of the incoming circuit of the switchboard.
- For auxiliary circuits of switchboards intended to be connected to transformers whose rated power does not exceed 10 kVA for a rated secondary voltage of not less than 110 V, or 1.6 kVA for a rated secondary voltage less than 110 V, and whose short-circuit impedance is not less than 4%.

Therefore, from an engineering point of view, the need to verify the short-circuit withstand strength may be viewed as follows:

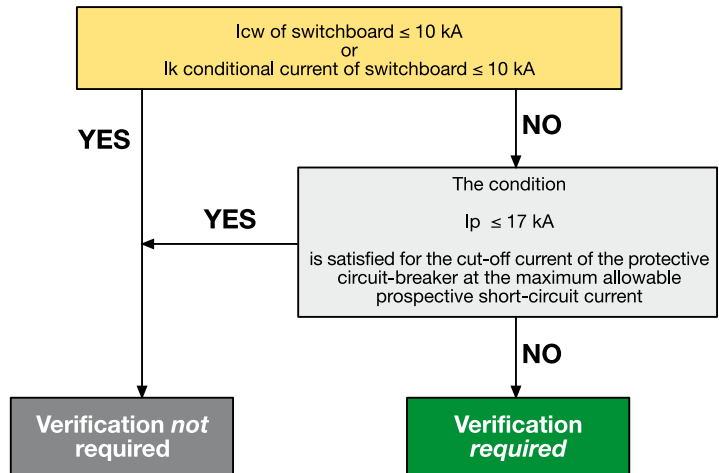

As regards the details of the test performance, reference shall be made directly to the Standard IEC 61439-1.

## Annex A: Protection against short-circuit effects inside low-voltage switchboards

### Short-circuit current and suitability of the switchboard for the plant

The verification of the short-circuit withstand strength is based on two values stated by the manufacturer in alternative to each other:

- the rated short-time current  $I_{cw}$
- the rated conditional short-circuit current  $I_k$

Based on one of these two values, it is possible to determine whether the switchboard is suitable to be installed in a particular point of the system.

***It shall be necessary to verify that the breaking capacities of the apparatus inside the switchboard are compatible with the short-circuit values of the system.***

Rated short-time withstand current  $I_{cw}$  is the r.m.s. value of the current relating to the short-circuit test for 1 s without openings of the protections, declared by the assembly manufacturer, that can be carried by the assembly without damage under specified conditions, defined in terms of a current and time. Different  $I_{cw}$  values for different times (e.g. 0.2 s; 3 s) may be assigned to an assembly. The switchboard shall be able to withstand the thermal and electro-dynamical stresses without damages or deformations which could compromise the operation of the system. From this test (if passed) it is possible to obtain the specific let-through energy ( $I^2t$ ) which can be carried by the switchboard:

$$I^2t = I_{cw}^2t$$

The test shall be carried out at a power factor value specified below in the Table 4 of the Std. IEC 61439-1. A factor "n" corresponding to this  $\cos\varphi$  value allows to determine the peak value of the short-circuit current withstood by the switchboard through the following formula:

$$I_p = I_{cw} \cdot n$$

**Table 4**

r.m.s. value of short-circuit current	power factor	
	$\cos\varphi$	n
$I \leq 5$ kA	0.7	1.5
$5 < I \leq 10$ kA	0.5	1.7
$10 < I \leq 20$ kA	0.3	2
$20 < I \leq 50$ kA	0.25	2.1
$50 < I$	0.2	2.2

*The values of this table represent the majority of applications. In special locations, for example in the vicinity of transformers or generators, lower values of power factor may be found, whereby the maximum prospective peak current may become the limiting value instead of the r.m.s. value of the short-circuit current.*

The conditional short-circuit current is a predetermined r.m.s. value of test current to which a defined peak value corresponds and which can be withstood by the switchboard during the operating time of a specified protective device. This device is usually the main circuit-breaker of the switchboard.

By comparing the two values  $I_{cw}$  and  $I_p$  with the prospective short-circuit current of the plant, it is possible to establish whether the switchboard is suitable to be installed at a specified point of the system.

The following diagrams show the method to determine the compatibility of the switchboard with the plant.

## Annex A: Protection against short-circuit effects inside low-voltage switchboards

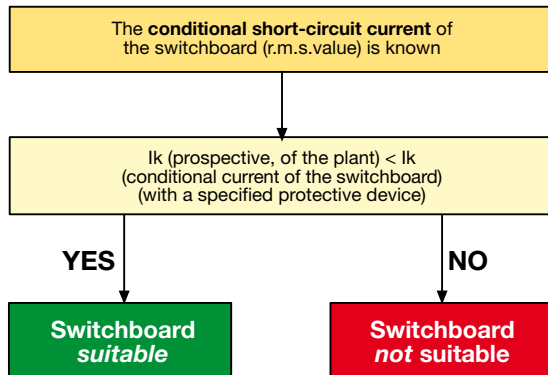
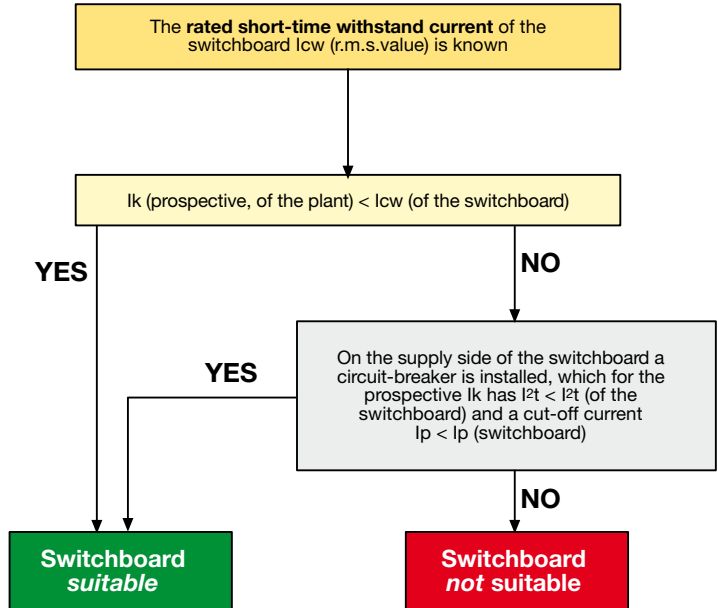

*The breaking capacities of the apparatus inside the switchboard shall be verified to be compatible with the short-circuit values of the plant.*

## Annex A: Protection against short-circuit effects inside low-voltage switchboards

### Example

Plant data:                      Rated voltage  $U_r=400\text{ V}$   
    Rated frequency  $f_r=50\text{ Hz}$   
    Short-circuit current  $I_k=35\text{ kA}$

Assume that in an existing system there is a switchboard with  $I_{cw}$  equal to 35kA and that, at the installation point of the switchboard, the prospective short-circuit current is equal to 35kA.

Now assume that an increase in the power supply of a plant is decided and that the short-circuit value rises to 60 kA.

Plant data after the increase:                      Rated voltage  $U_r=400\text{ V}$   
    Rated frequency  $f_r=50\text{ Hz}$   
    Short-circuit current  $I_k=60\text{ kA}$

Since the  $I_{cw}$  of the switchboard is lower than the short-circuit current of the system, in order to verify that the actual switchboard is still compatible, it is necessary to:

- determine the  $I^2t$  and  $I_p$  values let-through by the circuit-breaker on the supply side of the switchboard
- verify that the protective devices installed inside the switchboard have a sufficient breaking capacity (separately or in back-up)

$I_{cw} = 35\text{ kA}$  from which:

$$I^2t_{\text{switchboard}} = 35^2 \times 1 = 1225 \text{ MA}^2\text{s}$$

$$I_p_{\text{switchboard}} = 73.5 \text{ kA (according to Table 4)}$$

Assuming that on the supply side of the switchboard a circuit-breaker type Tmax T5H ( **$I_{cu}=70\text{ kA}@415\text{ V}$** ) is installed

$$I^2t_{\text{CB}} < 4\text{ MA}^2\text{s}$$

$$I_p_{\text{CB}} < 40\text{ kA}$$

since

$$I^2t_{\text{switchboard}} > I^2t_{\text{CB}}$$

$$I_p_{\text{switchboard}} > I_p_{\text{CB}}$$

it results that the switchboard (structure and busbar system) is suitable.

Assume that the circuit-breakers installed inside the switchboard are circuit-breakers type XT1, XT2 and XT3 version N with  **$I_{cu}=36\text{ kA}@415\text{ V}$** . From the back-up tables (see Chapter 3.3), it results that the circuit-breakers inside the switchboard are suitable for the plant, since their breaking capacity is increased to 65 kA thanks to the circuit-breaker type T5H on the supply side.

## Annex A: Protection against short-circuit effects inside low-voltage switchboards

### Selection of the distribution system in relation to short-circuit withstand strength

The dimensioning of the distribution system of the switchboard is obtained by taking into consideration the rated current flowing through it and the prospective short-circuit current of the plant.

The manufacturer usually provides tables which allow the choice of the busbar cross-section as a function of the rated current and give the mounting distances of the busbar supports to ensure the short-circuit withstand strength.

To select a distribution system compatible with the short-circuit data of the plant, one of these procedures shall be followed:

- **If the protective device on the supply side of the distribution system is known**

From the  $I_{cw}$  value of the distribution system it results:

$$I_{k_{\text{sys}}} = I_{cw} \cdot n \quad \text{where } n \text{ is the factor deduced from the Table 4}$$

$$I^2 t_{\text{sys}} = I_{cw}^2 \cdot t \quad \text{where } t \text{ is equal to } 1 \text{ s}$$

In correspondence with the prospective short-circuit current value of the plant the following values can be determined:

the cut-off current of the circuit-breaker

 $I_{p_{CB}}$ 

the specific let-through energy of the circuit-breaker

 $I^2 t_{CB}$ 

If  $I_{p_{CB}} < I_{p_{\text{sys}}}$  and  $I^2 t_{CB} < I^2 t_{\text{sys}}$ , then the distribution system is suitable.

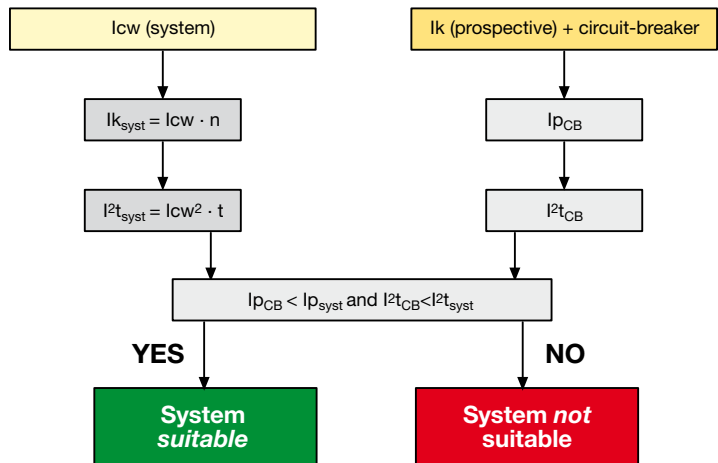

- **If the protective device on the supply side of the distribution system is not known**

The following condition must be fulfilled:

$$I_k \text{ (prospective)} < I_{cw} \text{ (system)}$$





## Annex A: Protection against short-circuit effects inside low-voltage switchboards

### Selection of conductors on the supply side of the protective devices

The Standard IEC 61439-1 prescribes that in a switchboard, the active conductors (distribution busbars included) positioned between the main busbars and the supply side of the single functional units, as well as the constructional components of these units, can be dimensioned according to the reduced short-circuit stresses which occur on the load side of the short-circuit protective device of the unit.

This may be possible if the conductors are installed in such a way throughout the switchboard that, under normal operating conditions, an internal short-circuit between phases and/or between phase and earth is only a remote possibility. It is advisable that such conductors are of solid rigid manufacture.

As an example, this Standard gives conductor types and installation requirements which allow to consider a short-circuit between phases and/or between phase and earth only a remote possibility.

Type of conductor	Requirements
Bare conductors or single-core conductors with basic insulation, for example cables according to IEC 60227-3.	Mutual contact or contact with conductive parts shall be avoided, for example by use of spacers.
Single-core conductors with basic insulation and a maximum permissible conductor-operating temperature above 90°C, for example cables according to IEC 60245-3, or heat-resistant PVC insulated cables according to IEC 60227-3.	Mutual contact or contact with conductive parts is permitted where there is no applied external pressure. Contact with sharp edges must be avoided. There must be no risk of mechanical damage. These conductors may only be loaded such that an operating temperature of 70°C is not exceeded.
Conductors with basic insulation, for example cables according to IEC 60227-3, having additional secondary insulation, for example individually covered cables with shrink sleeving or individually run cables in plastic conduits.	No additional requirements if there is no risk of mechanical damage.
Conductors insulated with a very high mechanical strength material, for example ETFE insulation, or double-insulated conductors with an enhanced outer sheath rated for use up to 3 kV, for example cables according to IEC 60502.	
Single or multi-core sheathed cables, for example cables according to IEC 60245-4 or 60227-4.	

Under these conditions or if anyway the integral short-circuit may be considered a remote possibility, the above described procedure shall be used to verify the suitability of the distribution system to the short-circuit conditions, when these are determined as a function of the characteristics of the circuit-breakers on the load side of the busbars.

## Annex A: Protection against short-circuit effects inside low-voltage switchboards

### Example

Plant data:

Rated voltage  $U_r=400\text{ V}$

Rated frequency  $f_r=50\text{ Hz}$

Short-circuit current  $I_k=45\text{ kA}$

In the switchboard shown in the figure, the vertical distribution busbars are derived from the main busbars.

These are 800 A busbars with shaped characteristics:

$I_n (\text{IP65}) = 800\text{ A}$ ,

$I_{cw\text{ max}} = 35\text{ kA}$

Since it is a "rigid" system with spacers, according to the Std. IEC 61439-1 a short-circuit between busbars is a remote possibility.

Anyway, a verification that the stresses reduced by the circuit-breakers on the load side of the system are compatible with the system is required.

Assuming that in the cubicles there are the following circuit-breakers:

Tmax XT3S250

Tmax XT2S160

it is necessary to verify that, in the case of a short-circuit on any outgoing conductor, the limitations created by the circuit-breaker are compatible with the busbar system; to comply with this requirement, at the maximum allowable prospective short-circuit current, the circuit-breaker with higher cut-off current and let-through energy must have an adequate current limiting capability for the busbar system.

In this case the circuit-breaker is type SACE Tmax XT3S250 In250.

The verification shall be carried out as in the previous paragraph:

From the  $I_{cw}$  of the busbar system, it derives:

$$I_{p_{\text{sys}}} = I_{cw} \cdot n = 35 \cdot 2.1 = 73.5 \quad [\text{kA}]$$

$$I^2 t_{\text{sys}} = I_{cw}^2 \cdot t = 35^2 \cdot 1 = 1225 \quad [(\text{kA})^2 \text{s}]$$

From the limitation and let-through energy curves

$$\begin{aligned} - I_k = 45\text{ kA} & \quad \text{corresponds at about} & I_{p_{\text{CB}}} = 30\text{ kA} \\ - I_k = 45\text{ kA} & \quad \text{corresponds at about} & I^2 t_{\text{CB}} = 3 [(\text{kA})^2 \text{s}] \end{aligned}$$

Thus, since

$$I_{p_{\text{CB}}} < I_{p_{\text{sys}}}$$

and

$$I^2 t_{\text{CB}} < I^2 t_{\text{sys}}$$

it results that the busbar system is compatible with the switchboard.

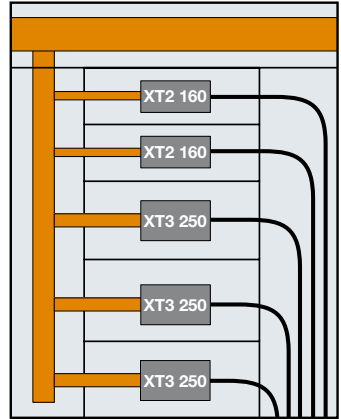

## Annex A: Protection against short-circuit effects inside low-voltage switchboards

### Short-circuit verification by design-rules

In compliance with the new Std. IEC 61439-1, the compliance of the assembly under short-circuit conditions can be proved in addition to laboratory tests (Icw) also by applying appropriate design-rules, which are pointed out in the following Table (Table 13 of the Std. IEC 61439-1).

Item No.	Requirements to be considered	YES	NO
1	Is the short-circuit withstand rating of each circuit of the ASSEMBLY to be assessed, less than or equal to, that of the reference design?		
2	Is the cross sectional dimensions of the busbars and connections of each circuit of the ASSEMBLY to be assessed, greater than or equal to, those of the reference design?		
3	Is the spacing of the busbars and connections of each circuit of the ASSEMBLY to be assessed, greater than or equal to, those of the reference design?		
4	Are the busbar supports of each circuit of the ASSEMBLY to be assessed of the same type, shape and material and have, the same or smaller spacing, along the length of the busbar as the reference design?		
5	Are the material and the material properties of the conductors of each circuit of the ASSEMBLY to be assessed the same as those of the reference design?		
6	Are the short-circuit protective devices of each circuit of the ASSEMBLY to be assessed equivalent, that is of the same make and series <sup>a)</sup> with the same or better limitation characteristics ( $I_{pk}^2t$ , $I_{pk}$ ) based on the device manufacturer's data, and with the same arrangement as the reference design?		
7	Is the length of unprotected live conductors, in accordance with 8.6.4, of each non-protected circuit of the ASSEMBLY to be assessed less than or equal to those of the reference design?		
8	If the ASSEMBLY to be assessed includes an enclosure, did the reference design include an enclosure when verified by test?		
9	Is the enclosure of the ASSEMBLY to be assessed of the same design, type and have at least the same dimensions to that of the reference design?		
10	Is the enclosure of the ASSEMBLY to be assessed of the same design, type and have at least the same dimensions to that of the reference design?		
'YES' to all requirements – no further verification required.			
'NO' to any one requirement – further verification is required, see 10.11.4 and 10.11.5 of the Standard.			
<sup>a)</sup> Short-circuit protective devices of the same manufacture but of a different series may be considered equivalent where the device manufacturer declares the performance characteristics to be the same or better in all relevant respects to the series used for verification, e.g. breaking capacity and limitation characteristics ( $I_{2t}$ , $I_{pk}$ ), and critical distances.			

---

## Annex B: Temperature rise evaluation according to IEC 60890

The calculation method suggested in the Standard IEC 60890 makes it possible to evaluate the temperature rise inside an assembly; the Standards IEC 60890 and the IEC 61439-1 establishes that this calculation method is applicable only when the following conditions are met:

the rated current of the assembly circuits shall not exceed 80% of the rated current (in free air) of the protective devices and of the electrical components installed in the circuit;

- there is an approximately even distribution of power loss inside the enclosure and there are no obstacles preventing its dispersion towards the outside of the assembly;
- the installed assembly is arranged so as that air circulation is little impeded;
- the installed assembly is designed for direct or alternating currents up to and including 60 Hz, with the total of supply currents not exceeding 1600 A;
- the conductors carrying currents exceeding 200 A and the structural parts are so arranged that eddy current losses are negligible;
- for the enclosures with ventilation openings, the cross-section of the air outlet openings is at least 1.1 times the cross-section of the air inlet openings;
- there are no more than three horizontal partitions for each section of the assembly;
- should the enclosures with external ventilation openings be divided into compartments, the surface of the ventilation openings in every internal horizontal partition shall be at least equal to 50% of the horizontal section of the compartment.

The data necessary for the calculation are:

- dimensions of the enclosure: height, width, depth;
- the type of installation of the enclosure (see Table 8);
- presence of ventilation openings;
- number of internal horizontal partitions;
- the power loss of the equipment installed in the enclosure (see Tables 13 and 14);
- the power loss of the conductors inside the enclosure, equal to the sum of the power loss of every conductor, according to Tables 1, 2 and 3.

For equipment and conductors not fully loaded, it is possible to evaluate the power loss as:

$$P = P_n \left( \frac{I_b}{I_n} \right)^2 \quad (1)$$

where:

$P$  is the actual power loss;

$P_n$  is the rated power loss (at  $I_n$ );

$I_b$  is the actual current;

$I_n$  is the rated current.

## Annex B: Temperature rise evaluation according to IEC 60890

Table 1: Operating current and power losses of insulated conductors

Cross-section (Cu)	Maximum permissible conductor temperature 70 °C											
	Air temperature inside the enclosure around the conductors											
	35 °C		55 °C		35 °C		55 °C		35 °C		55 °C	
	operating current	power losses 2)	operating current	power losses 2)	operating current	power losses 2)	operating current	power losses 2)	operating current	power losses 2)	operating current	power losses 2)
mm <sup>2</sup>	A	W/m	A	W/m	A	W/m	A	W/m	A	W/m	A	W/m
1.5	12	2.1	8	0.9	12	2.1	8	0.9	12	2.1	8	0.9
2.5	17	2.5	11	1.1	20	3.5	12	1.3	20	3.5	12	1.3
4	22	2.6	14	1.1	25	3.4	18	1.8	25	3.4	20	2.2
6	28	2.8	18	1.2	32	3.7	23	1.9	32	3.7	25	2.3
10	38	3.0	25	1.3	48	4.8	31	2.0	50	5.2	32	2.1
16	52	3.7	34	1.6	64	5.6	42	2.4	65	5.8	50	3.4
25					85	6.3	55	2.6	85	6.3	65	3.7
35					104	7.5	67	3.1	115	7.9	85	5.0
50					130	7.9	85	3.4	150	10.5	115	6.2
70					161	8.4	105	3.6	175	9.9	149	7.2
95					192	8.7	125	3.7	225	11.9	175	7.2
120					226	9.6	147	4.1	250	11.7	210	8.3
150					275	11.7	167	4.3	275	11.7	239	8.8
185					295	10.9	191	4.6	350	15.4	273	9.4
240					347	12.0	225	5.0	400	15.9	322	10.3
300					400	13.2	260	5.6	460	17.5	371	11.4
<b>Conductors for auxiliary circuits</b>												
0.12	2.6	1.2	1.7	0.5	Diam.							
0.14	2.9	1.3	1.9	0.6	-							
0.20	3.2	1.1	2.1	0.5	-							
0.22	3.6	1.3	2.3	0.5	0.5							
0.30	4.4	1.4	2.9	0.6	0.6							
0.34	4.7	1.4	3.1	0.6	0.6							
0.50	6.4	1.8	4.2	0.8	0.8							
0.56		1.6		0.7	-							
0.75	8.2	1.9	5.4	0.8	1.0							
1.00	9.3	1.8	6.1	0.8	-							
1) Any arrangement desired with the values specified referring to six cores in a multi-core bundle with a simultaneous load 100%												
2) single length												

## Annex B: Temperature rise evaluation according to IEC 60890

**Table 2: Operating current and power losses of bare conductors, in vertical arrangement without direct connections to apparatus**

Width x Thickness	Cross-section (Cu)	Maximum permissible conductor temperature 85 °C															
		Air temperature inside the enclosure around the conductors 35 °C								Air temperature inside the enclosure around the conductors 55 °C							
		50 Hz to 60 Hz ac				dc and ac to 16 2/3 Hz				50 Hz to 60 Hz ac				dc and ac to 16 2/3 Hz			
		operating current	power losses 1)	operating current	power losses 1)	operating current	power losses 1)	operating current	power losses 1)	operating current	power losses 1)	operating current	power losses 1)	operating current	power losses 1)	operating current	power losses 1)
mm x mm	mm <sup>2</sup>	A*	W/m	A**	W/m	A*	W/m	A**	W/m	A*	W/m	A**	W/m	A*	W/m	A**	W/m
12 x 2	23.5	144	19.5	242	27.5	144	19.5	242	27.5	105	10.4	177	14.7	105	10.4	177	14.7
15 x 2	29.5	170	21.7	282	29.9	170	21.7	282	29.9	124	11.6	206	16.0	124	11.6	206	16.0
15 x 3	44.5	215	23.1	375	35.2	215	23.1	375	35.2	157	12.3	274	18.8	157	12.3	274	18.8
20 x 2	39.5	215	26.1	351	34.8	215	26.1	354	35.4	157	13.9	256	18.5	157	12.3	258	18.8
20 x 3	59.5	271	27.6	463	40.2	271	27.6	463	40.2	198	14.7	338	21.4	198	14.7	338	21.4
20 x 5	99.1	364	29.9	665	49.8	364	29.9	668	50.3	266	16.0	485	26.5	266	16.0	487	26.7
20 x 10	199	568	36.9	1097	69.2	569	36.7	1107	69.6	414	19.6	800	36.8	415	19.5	807	37.0
25 x 5	124	435	34.1	779	55.4	435	34.1	78	55.6	317	18.1	568	29.5	317	18.1	572	29.5
30 x 5	149	504	38.4	894	60.6	505	38.2	899	60.7	368	20.5	652	32.3	369	20.4	656	32.3
30 x 10	299	762	44.4	1410	77.9	770	44.8	1436	77.8	556	27.7	1028	41.4	562	23.9	1048	41.5
40 x 5	199	641	47.0	1112	72.5	644	47.0	1128	72.3	468	25.0	811	38.5	469	24.9	586	38.5
40 x 10	399	951	52.7	1716	88.9	968	52.6	1796	90.5	694	28.1	1251	47.3	706	28.0	1310	48.1
50 x 5	249	775	55.7	1322	82.9	782	55.4	1357	83.4	566	29.7	964	44.1	570	29.4	989	44.3
50 x 10	499	1133	60.9	2008	102.9	1164	61.4	2141	103.8	826	32.3	1465	54.8	849	32.7	1562	55.3
60 x 5	299	915	64.1	1530	94.2	926	64.7	1583	94.6	667	34.1	1116	50.1	675	34.4	1154	50.3
60 x 10	599	1310	68.5	2288	116.2	1357	69.5	2487	117.8	955	36.4	1668	62.0	989	36.9	1814	62.7
80 x 5	399	1170	80.7	1929	116.4	1200	80.8	2035	116.1	858	42.9	1407	61.9	875	42.9	1484	61.8
80 x 10	799	1649	85.0	2806	138.7	1742	85.1	3165	140.4	1203	45.3	2047	73.8	1271	45.3	1756	74.8
100 x 5	499	1436	100.1	2301	137.0	1476	98.7	2407	121.2	1048	53.3	1678	72.9	1077	52.5	1756	69.8
100 x 10	999	1982	101.7	3298	164.2	2128	102.6	3844	169.9	1445	54.0	2406	84.4	1552	54.6	2803	90.4
120 x 10	1200	2314	115.5	3804	187.3	2514	115.9	4509	189.9	1688	61.5	2774	99.6	1833	61.6	3288	101.0

\*) one conductor per phase

\*\*) two conductors per phase

1) single length

## Annex B: Temperature rise evaluation according to IEC 60890

**Table 3: Operating current and power losses of bare conductors used as connections between apparatus and busbars**

Width x Thickness	Cross- section (Cu)	Maximum permissible conductor temperature 65 °C							
		Air temperature inside the enclosure around the conductors 35 °C				Air temperature inside the enclosure around the conductors 55 °C			
		50 Hz to 60 Hz ac and dc							
		operating current	power losses 1)	operating current	power losses 1)	operating current	power losses 1)	operating current	power losses 1)
mm x mm	mm <sup>2</sup>	A*	W/m	A**	W/m	A*	W/m	A**	W/m
12 x 2	23.5	82	5.9	130	7.4	69	4.2	105	4.9
15 x 2	29.5	96	6.4	150	7.8	88	5.4	124	5.4
15 x 3	44.5	124	7.1	202	9.5	102	4.8	162	6.1
20 x 2	39.5	115	6.9	184	8.9	93	4.5	172	7.7
20 x 3	59.5	152	8.0	249	10.8	125	5.4	198	6.8
20 x 5	99.1	218	9.9	348	12.7	174	6.3	284	8.4
20 x 10	199	348	12.8	648	22.3	284	8.6	532	15.0
25 x 5	124	253	10.7	413	14.2	204	7.0	338	9.5
30 x 5	149	288	11.6	492	16.9	233	7.6	402	11.3
30 x 10	299	482	17.2	960	32.7	402	11.5	780	21.6
40 x 5	199	348	12.8	648	22.3	284	8.6	532	15.0
40 x 10	399	648	22.7	1245	41.9	532	15.3	1032	28.8
50 x 5	249	413	14.7	805	27.9	338	9.8	655	18.5
50 x 10	499	805	28.5	1560	53.5	660	19.2	1280	36.0
60 x 5	299	492	17.2	960	32.7	402	11.5	780	21.6
60 x 10	599	960	34.1	1848	63.2	780	22.5	1524	43.0
80 x 5	399	648	22.7	1256	42.6	532	15.3	1032	28.8
80 x 10	799	1256	45.8	2432	85.8	1032	30.9	1920	53.5
100 x 5	499	805	29.2	1560	54.8	660	19.6	1280	36.9
100 x 10	999	1560	58.4	2680	86.2	1280	39.3	2180	57.0
120 x 10	1200	1848	68.3	2928	85.7	1524	46.5	2400	57.6

\*) one conductor per phase    \*\*) two conductors per phase    1) single length

1SDCC08042F0201



## Annex B: Temperature rise evaluation according to IEC 60890

Where enclosures without vertical partitions or individual sections have an effective cooling surface greater than about 11.5 m or a width greater than about 1.5 m, they should be divided for the calculation into fictitious sections, whose dimensions approximate to the foregoing values.

The following diagram shows the procedure to evaluate the temperature rise.

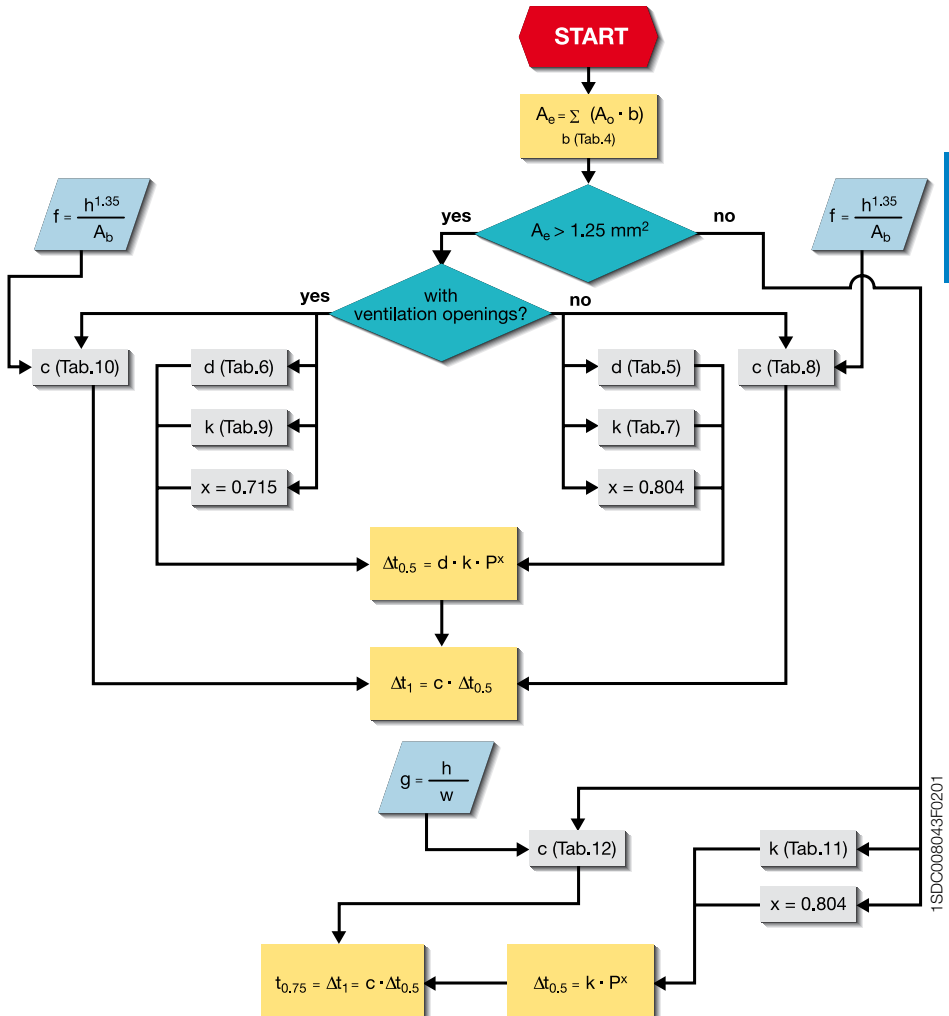

1SDC008043F0201

## Annex B: Temperature rise evaluation according to IEC 60890

**Table 4: Surface factor  $b$  according to the type of installation**

Type of installation	Surface factor $b$
Exposed top surface	1.4
Covered top surface, e.g. of built-in enclosures	0.7
Exposed side faces, e.g. front, rear and side walls	0.9
Covered side faces, e.g. rear side of wall-mounted enclosures	0.5
Side faces of central enclosures	0.5
Floor surface	Not taken into account

Fictitious side faces of sections which have been introduced only for calculation purposes are not taken into account

**Table 5: Factor  $d$  for enclosures without ventilation openings and with an effective cooling surface  $A_e > 1.25 \text{ m}^2$**

Number of horizontal partitions $n$	Factor $d$
0	1
1	1.05
2	1.15
3	1.3

**Table 6: Factor  $d$  for enclosures with ventilation openings and with an effective cooling surface  $A_e > 1.25 \text{ m}^2$**

Number of horizontal partitions $n$	Factor $d$
0	1
1	1.05
2	1.1
3	1.15

**Table 7: Enclosure constant  $k$  for enclosures without ventilation openings, with an effective cooling surface  $A_e > 1.25 \text{ m}^2$**









$A_e$ [ $\text{m}^2$ ]	$k$	$A_e$ [ $\text{m}^2$ ]	$k$
1.25	0.524	6.5	0.135
1.5	0.45	7	0.13
2	0.35	7.5	0.125
2.5	0.275	8	0.12
3	0.225	8.5	0.115
3.5	0.2	9	0.11
4	0.185	9.5	0.105
4.5	0.17	10	0.1
5	0.16	10.5	0.095
5.5	0.15	11	0.09
6	0.14	11.5	0.085

## Annex B: Temperature rise evaluation according to IEC 60890

**Table 8: Temperature distribution factor  $c$  for enclosures without ventilation openings, with an effective cooling surface  $A_b > 1.25 \text{ m}^2$**

$f = \frac{h^{1.35}}{A_b}$	Type of installation				
	1	2	3	4	5
0.6	1.225	1.21	1.19	1.17	1.113
1	1.24	1.225	1.21	1.185	1.14
1.5	1.265	1.245	1.23	1.21	1.17
2	1.285	1.27	1.25	1.23	1.19
2.5	1.31	1.29	1.275	1.25	1.21
3	1.325	1.31	1.295	1.27	1.23
3.5	1.35	1.33	1.315	1.29	1.255
4	1.37	1.355	1.34	1.32	1.275
4.5	1.395	1.375	1.36	1.34	1.295
5	1.415	1.395	1.38	1.36	1.32
5.5	1.435	1.415	1.4	1.38	1.34
6	1.45	1.435	1.42	1.395	1.355
6.5	1.47	1.45	1.435	1.41	1.37
7	1.48	1.47	1.45	1.43	1.39
7.5	1.495	1.48	1.465	1.44	1.4
8	1.51	1.49	1.475	1.455	1.415
8.5	1.52	1.505	1.49	1.47	1.43
9	1.535	1.52	1.5	1.48	1.44
9.5	1.55	1.53	1.515	1.49	1.455
10	1.56	1.54	1.52	1.5	1.47
10.5	1.57	1.55	1.535	1.51	1.475
11	1.575	1.565	1.549	1.52	1.485
11.5	1.585	1.57	1.55	1.525	1.49
12	1.59	1.58	1.56	1.535	1.5
12.5	1.6	1.585	1.57	1.54	1.51

where  $h$  is the height of the enclosure, and  $A_b$  is the area of the base.  
For "Type of installation":

Type of installation n°	
1	Separate enclosure, detached on all sides 
2	First or last enclosure, detached type  
3	Separate enclosure for wall-mounting  Central enclosure, detached type 
4	First or last enclosure, wall-mounting type   Central enclosure for wall-mounting and with covered top surface 
5	Central enclosure, wall-mounting type 

1SD008069F001

## Annex B: Temperature rise evaluation according to IEC 60890

**Table 9: Enclosure constant  $k$  for enclosures with ventilation openings and an effective cooling surface  $A_e > 1.25 \text{ m}^2$**

Ventilation opening in $\text{cm}^2$	$A_e \text{ [m}^2\text{]}$												
	1	1.5	2	2.5	3	4	5	6	7	8	10	12	14
50	0.36	0.33	0.3	0.28	0.26	0.24	0.22	0.208	0.194	0.18	0.165	0.145	0.135
100	0.293	0.27	0.25	0.233	0.22	0.203	0.187	0.175	0.165	0.153	0.14	0.128	0.119
150	0.247	0.227	0.21	0.198	0.187	0.173	0.16	0.15	0.143	0.135	0.123	0.114	0.107
200	0.213	0.196	0.184	0.174	0.164	0.152	0.143	0.135	0.127	0.12	0.11	0.103	0.097
250	0.19	0.175	0.165	0.155	0.147	0.138	0.13	0.121	0.116	0.11	0.1	0.095	0.09
300	0.17	0.157	0.148	0.14	0.133	0.125	0.118	0.115	0.106	0.1	0.093	0.088	0.084
350	0.152	0.141	0.135	0.128	0.121	0.115	0.109	0.103	0.098	0.093	0.087	0.082	0.079
400	0.138	0.129	0.121	0.117	0.11	0.106	0.1	0.096	0.091	0.088	0.081	0.078	0.075
450	0.126	0.119	0.111	0.108	0.103	0.099	0.094	0.09	0.086	0.083	0.078	0.074	0.07
500	0.116	0.11	0.104	0.1	0.096	0.092	0.088	0.085	0.082	0.078	0.073	0.07	0.067
550	0.107	0.102	0.097	0.093	0.09	0.087	0.083	0.08	0.078	0.075	0.07	0.068	0.065
600	0.1	0.095	0.09	0.088	0.085	0.082	0.079	0.076	0.073	0.07	0.067	0.065	0.063
650	0.094	0.09	0.086	0.083	0.08	0.077	0.075	0.072	0.07	0.068	0.065	0.063	0.061
700	0.089	0.085	0.08	0.078	0.076	0.074	0.072	0.07	0.068	0.066	0.064	0.062	0.06

**Table 10: Temperature distribution factor  $c$  for enclosures with ventilation openings and an effective cooling surface  $A_e > 1.25 \text{ m}^2$**

Ventilation opening in $\text{cm}^2$	$f = \frac{h^{1.35}}{A_e}$									
	1.5	2	3	4	5	6	7	8	9	10
50	1.3	1.35	1.43	1.5	1.57	1.63	1.68	1.74	1.78	1.83
100	1.41	1.46	1.55	1.62	1.68	1.74	1.79	1.84	1.88	1.92
150	1.5	1.55	1.63	1.69	1.75	1.8	1.85	1.9	1.94	1.97
200	1.56	1.61	1.67	1.75	1.8	1.85	1.9	1.94	1.97	2.01
250	1.61	1.65	1.73	1.78	1.84	1.88	1.93	1.97	2.01	2.04
300	1.65	1.69	1.75	1.82	1.86	1.92	1.96	2	2.03	2.06
350	1.68	1.72	1.78	1.85	1.9	1.94	1.97	2.02	2.05	2.08
400	1.71	1.75	1.81	1.87	1.92	1.96	2	2.04	2.07	2.1
450	1.74	1.77	1.83	1.88	1.94	1.97	2.02	2.05	2.08	2.12
500	1.76	1.79	1.85	1.9	1.95	1.99	2.04	2.06	2.1	2.13
550	1.77	1.82	1.88	1.93	1.97	2.01	2.05	2.08	2.11	2.14
600	1.8	1.83	1.88	1.94	1.98	2.02	2.06	2.09	2.12	2.15
650	1.81	1.85	1.9	1.95	1.99	2.04	2.07	2.1	2.14	2.17
700	1.83	1.87	1.92	1.96	2	2.05	2.08	2.12	2.15	2.18

## Annex B: Temperature rise evaluation according to IEC 60890

**Table 11: Enclosure constant  $k$  for enclosures without ventilation openings and with an effective cooling surface  $A_e \leq 1.25 \text{ m}^2$**

$A_e \text{ [m}^2\text{]}$	$k$	$A_e \text{ [m}^2\text{]}$	$k$
0.08	3.973	0.65	0.848
0.09	3.643	0.7	0.803
0.1	3.371	0.75	0.764
0.15	2.5	0.8	0.728
0.2	2.022	0.85	0.696
0.25	1.716	0.9	0.668
0.3	1.5	0.95	0.641
0.35	1.339	1	0.618
0.4	1.213	1.05	0.596
0.45	1.113	1.1	0.576
0.5	1.029	1.15	0.557
0.55	0.960	1.2	0.540
0.6	0.9	1.25	0.524

**Table 12: Temperature distribution factor  $c$  for enclosures without ventilation openings and with an effective cooling surface  $A_e \leq 1.25 \text{ m}^2$**

$g$	$c$	$g$	$c$
0	1	1.5	1.231
0.1	1.02	1.6	1.237
0.2	1.04	1.7	1.24
0.3	1.06	1.8	1.244
0.4	1.078	1.9	1.246
0.5	1.097	2	1.249
0.6	1.118	2.1	1.251
0.7	1.137	2.2	1.253
0.8	1.156	2.3	1.254
0.9	1.174	2.4	1.255
1	1.188	2.5	1.256
1.1	1.2	2.6	1.257
1.2	1.21	2.7	1.258
1.3	1.22	2.8	1.259
1.4	1.226		

where  $g$  is the ratio of the height and the width of the enclosure.

## Annex B: Temperature rise evaluation according to IEC 60890

Total (3/4 poles)  
power loss in W

Table 13: MCCB power losses

Releases	In[A]	XT1		XT2		XT3		XT4		T1P		T1		T2		T3		T4		T5		T6		T7 S,H,L		T7 V		
		F	P	F	P/W	F	P	F	P/W	F	F	F	P	F	P	F	P/W	F	P/W	F	W	F	W	F	W	F	W	
TMF	1												4.5	5.1														
	1.6			6	7.14								6.3	7.5														
	2			7.14	8.28								7.5	8.7														
	2.5			7.41	8.55								7.8	9														
	3			8.28	9.69																							
	3.2												8.7	10.2														
	4			7.41	8.55								7.8	9														
	5												8.7	10.5														
	6.3			9.99	11.7								10.5	12.3														
	8			7.71	0.12								8.1	9.6														
	10			8.85	10.26								9.3	10.8														
	12.5			3.15	3.72								3.3	3.9														
	16	4.5	4.5	3.99	4.56						1.5	4.5	4.2	4.8														
	20	5.4	6	4.86	5.7						1.8	5.4	5.1	6			10.8	10.8										
	25	6	8.4								2	6	6.9	8.4														
	32	6.3	9.6	7.71	9.12			13.32	13.32	2.1	6.3	8.1	9.6					11.1	11.1									
	40	7.8	13.8	11.13	13.11			13.47	14.16	2.6	7.8	11.7	13.8															
	50	11.1	15	12.27	14.25			14.04	14.76	3.7	11.1	12.9	15					11.7	12.3									
	63	12.9	18	14.55	17.1	12.9	15.3	15.9	17.28	4.3	12.9	15.3	18	12.9	15.3													
	80	14.4	21.6	17.4	20.52	14.4	17.4	16.56	18	4.8	14.4	18.3	21.6	14.4	17.4	13.8	15											
	100	21	30	24.24	28.5	16.8	20.4	18.72	20.88	7	21	25.5	30	16.8	20.4	15.6	17.4											
	125	32.1	44.1	34.2	41.91	19.8	23.7	22.32	25.92	10.7	32.1	36	44.1	19.8	23.7	18.6	21.6											
	160	45	60	48.45	57	23.7	28.5	26.64	32.4	15	45	51	60	23.7	28.5	22.2	27											
	200					39.6	47.4	35.64	44.64					39.6	47.4	29.7	37.2											
	250					53.4	64.2	49.32	63.36					53.4	64.2	41.1	52.8											
	320																	40.8	62.7									
	400																	58.5	93									
	500																	86.4	110.1									
630																					91.8	90						
800																					93	118.8						
PR21...	10											1.5	1.8															
	25											3	3.6															
	63											10.5	12															
	100											24	27.6			5.1	6.9											
	160											51	60			13.2	18											
	250														32.1	43.8												
	320														52.8	72	31.8	53.7										
	400																49.5	84					15	27	24	36		
	630																123	160.8	90	115	36	66	60	90				
	800																					96	124.8	57.9	105.9	96	144	
1000																					150		90	165	150	225		
1250																							141	258	234.9	351.9		
1600																							231	423				

The values indicated in the table refer to balanced loads, with a current flow equal to the In, and are valid for both circuit-breakers and switch-disconnectors, three-pole and four-pole versions. For the latter, the current of the neutral is nil by definition.

## Annex B: Temperature rise evaluation according to IEC 60890

Table 14: Emax power losses

Total (3/4 poles) power loss in W	X1-BN		X1-L		E1B-N		E2B-N-S		E2L		E3N-S-H-V		E3L		E4S-H-V		E6H-V			
	F	W	F	W	F	W	F	W	F	W	F	W	F	W	F	W	F	W		
In=630	31	60	61	90																
In=800	51	104	99	145	65	95	29	53			22	36								
In=1000	79	162	155	227	96	147	45	83			38	58								
In=1250	124	293	242	354	150	230	70	130	105	165	60	90								
In=1600	209	415			253	378	115	215	170	265	85	150								
In=2000							180	330			130	225	215	330						
In=2500											205	350	335	515						
In=3200											330	570			235	425	170	290		
In=4000															360	660	265	445		
In=5000																			415	700
In=6300																			650	1100

### Example

Hereunder an example of temperature rise evaluation for a switchboard with the following characteristics:

- enclosure without ventilation openings
- no internal segregation
- separate enclosure for wall-mounting
- one main circuit-breaker
- 5 circuit-breakers for load supply
- busbars and cable systems

#### Enclosure

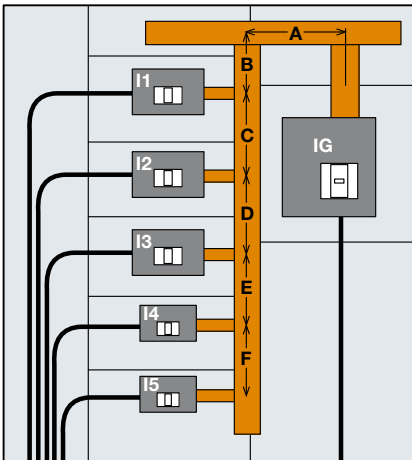

#### Circuit diagram

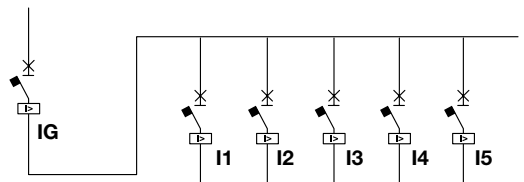

#### Dimensions [mm]

Height	Width	Depth	Number of horizontal partitions = 0
2000	1440	840	Separate enclosure for wall-mounting

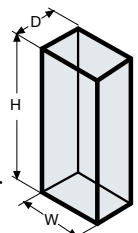

## Annex B: Temperature rise evaluation according to IEC 60890

The power losses from each component of the above switchboard are evaluated hereunder.

For the circuit-breakers, the power losses are calculated as  $P = P_n \left( \frac{I_b}{I_n} \right)^2$  with  $I_n$  and  $P_n$  given in the Tables 14 and 15.

The table below shows the values relevant to each circuit-breaker of the switchboard in question:

Circuit-breakers		<b>I<sub>n</sub> CB</b> [A]	<b>I<sub>b</sub></b> [A]	<b>Power losses</b> [W]
<b>I<sub>G</sub></b>	E2 2000 EL	2000	1340	80.7
<b>I<sub>1</sub></b>	T5 630 EL	630	330	33.7
<b>I<sub>2</sub></b>	T5 630 EL	630	330	33.7
<b>I<sub>3</sub></b>	T5 630 EL	630	330	33.7
<b>I<sub>4</sub></b>	XT3 250 TMD	250	175	26.2
<b>I<sub>5</sub></b>	XT3 250 TMD	250	175	26.2
<b>Total power loss of circuit-breakers [W]</b>				<b>234</b>

For the busbars, the power losses are calculated as  $P = P_n \left( \frac{I_b}{I_n} \right)^2 \cdot (3 \cdot \text{Length})$  with  $I_n$  and  $P_n$  given in the Table 2.

The table below shows the power losses of busbars:

Busbars	<b>Cross-section</b> nx[mm]x[mm]	<b>Length</b> [m]	<b>I<sub>b</sub></b> [A]	<b>Power losses</b> [W]
<b>A</b>	2x60x10	0.393	1340	47.2
<b>B</b>	80x10	0.332	1340	56
<b>C</b>	80x10	0.300	1010	28.7
<b>D</b>	80x10	0.300	680	13
<b>E</b>	80x10	0.300	350	3.5
<b>F</b>	80x10	0.300	175	0.9
<b>Total power loss of busbars [W]</b>				<b>149</b>

For the bare conductors connecting the busbars to the circuit-breakers, the power losses are calculated as  $P = P_n \left( \frac{I_b}{I_n} \right)^2 \cdot (3 \cdot \text{Length})$ , with  $I_n$  and  $P_n$  given in the Table 2. Here below the values for each section:

Connection bare conductors	<b>Cross-section</b> nx[mm]x[mm]	<b>Length</b> [m]	<b>I<sub>b</sub></b> [A]	<b>Power losses</b> [W]
<b>I<sub>G</sub></b>	2x60x10	0.450	1340	54
<b>I<sub>1</sub></b>	30x10	0.150	330	3.8
<b>I<sub>2</sub></b>	30x10	0.150	330	3.8
<b>I<sub>3</sub></b>	30x10	0.150	330	3.8
<b>I<sub>4</sub></b>	20x10	0.150	175	1.6
<b>I<sub>5</sub></b>	20x10	0.150	175	1.6
<b>Total power loss of bare conductors [W]</b>				<b>68</b>



## Annex B: Temperature rise evaluation according to IEC 60890

For the cables connecting the circuit-breakers to the supply and the loads, the power losses are calculated as  $P = P_n \left( \frac{I_b}{I_n} \right)^2 \cdot (3 \cdot \text{Length})$ , with  $I_n$  and  $P_n$  given in the Table 4.

Here below the power losses for each connection:

Cables	Cross-section	Length	I <sub>b</sub>	Power losses
	[n]xmm <sup>2</sup>	[m]	[A]	[W]
<b>IG</b>	4x240	1.0	1340	133.8
<b>I1</b>	240	2.0	330	64.9
<b>I2</b>	240	1.7	330	55.2
<b>I3</b>	240	1.4	330	45.4
<b>I4</b>	120	1.1	175	19
<b>I5</b>	120	0.8	175	13.8
<b>Total power loss of cables [W]</b>				<b>332</b>

Thus, the total power loss inside the enclosure is: **P = 784 [W]**

From the geometrical dimensions of the switchboard, the effective cooling surface  $A_e$  is determined below:

	Dimensions[m]x[m]	A <sub>n</sub> [m <sup>2</sup> ]	b factor	A <sub>n</sub>
Top	0.840x1.44	1.21	1.4	1.69
Front	2x1.44	1.64	0.9	2.59
Rear	2x1.44	1.64	0.5	1.44
Left-hand side	2x0.840	1.68	0.9	1.51
Right-hand side	2x0.840	1.68	0.9	1.51
<b>A<sub>e</sub>=Σ(A<sub>n</sub>·b)</b>				<b>8.75</b>

Making reference to the procedure described in the diagram at page 247, it is possible to evaluate the temperature rise inside the switchboard.

## Annex B: Temperature rise evaluation according to IEC 60890

From Table 7,  $k$  results 0.112 (value interpolated)

Since  $x = 0.804$ , the temperature rise at half the height of the enclosure is:

$$\Delta t_{0,5} = d \cdot k \cdot P^x = 1 \cdot 0.112 \cdot 784^{0.804} = 23.8 \text{ k}$$

For the evaluation of the temperature rise at the top of the enclosure, it is necessary to determine the  $c$  factor by using the  $f$  factor:

$$f = \frac{h^{1.35}}{A_b} = \frac{2^{1.35}}{1.44 \cdot 0.84} = 2.107 \quad (A_b \text{ is the base area of the switchboard})$$

From Table 8, column 3 (separate enclosure for wall-mounting),  $c$  results to be equal to 1.255 (value interpolated).

$$\Delta t_1 = c \cdot \Delta t_{0,5} = 1.255 \cdot 23.8 = 29.8 \text{ k}$$

Considering 35°C ambient temperature, as prescribed by the Standard, the following temperatures shall be reached inside the enclosure:

$$t_{0,5} = 35 + 23.8 \approx 59^\circ\text{C}$$

$$t_1 = 35 + 29.8 \approx 65^\circ\text{C}$$

Assuming that the temperature derating of the circuit-breakers inside the switchboard can be compared to the derating at an ambient temperature different from 40°C, through the tables of Chapter 2.5, it is possible to verify if the selected circuit-breakers can carry the required currents:

$$\begin{array}{llll} \text{E2 2000 at } 65^\circ\text{C} & I_n=1765 \text{ [A]} & > & I_g = 1340 \text{ [A]} \\ \text{T5 630 at } 65^\circ\text{C} & I_n=505 \text{ [A]} & > & I_1 = I_2 = I_3 = 330 \text{ [A]} \\ \text{XT3 250 at } 60^\circ\text{C} & I_n=216 \text{ [A]} & > & I_4 = I_5 = 175 \text{ [A]} \end{array}$$

# Annex C: Application examples

## Advanced protection functions with PR123/P and PR333/P releases

### Dual Setting

Thanks to the new PR123 and PR333 releases, it is possible to program two different sets of parameters and, through an external command, to switch from one set to the other.

This function is useful when there is an emergency source (generator) in the system, only supplying voltage in the case of a power loss on the network side.

#### Example:

In the system described below, in the case of a loss of the normal supply on the network side, by means of ABB SACE ATSO10 automatic transfer switch, it is possible to switch the supply from the network to the emergency power unit and to disconnect the non-primary loads by opening the QS1 switch-disconnector.

Under normal service conditions of the installation, the circuit-breakers C are set in order to be selective with both circuit-breaker A, on the supply side, as well as with circuit-breakers D on the load side.

By switching from the network to the emergency power unit, circuit-breaker B becomes the reference circuit-breaker on the supply side of circuit-breakers C. This circuit-breaker, being the protection of a generator, must be set to trip times shorter than A and therefore the setting values of the circuit-breakers on the load side might not guarantee the selectivity with B.

By means of the “dual setting” function of the PR123 and PR 333 releases, it is possible to switch circuit-breakers C from a parameter set which guarantees selectivity with A, to another set which make them selective with B.

However, these new settings could make the combination between circuit-breakers C and the circuit-breakers on the load side non-selective.

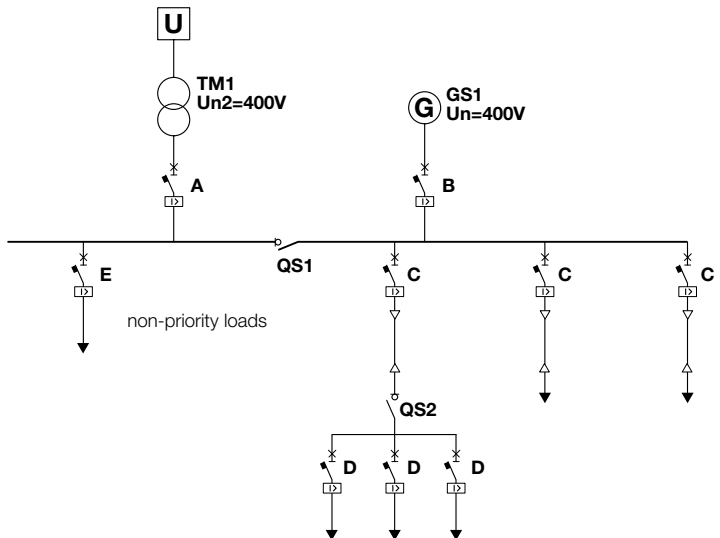

1SDCC008049F0201

## Annex C: Application examples

### Advanced protection functions with PR123/P and PR333/P releases

The figure at the side shows the time-current curves of the installation under normal service conditions. The values set allow no intersection of the curves.

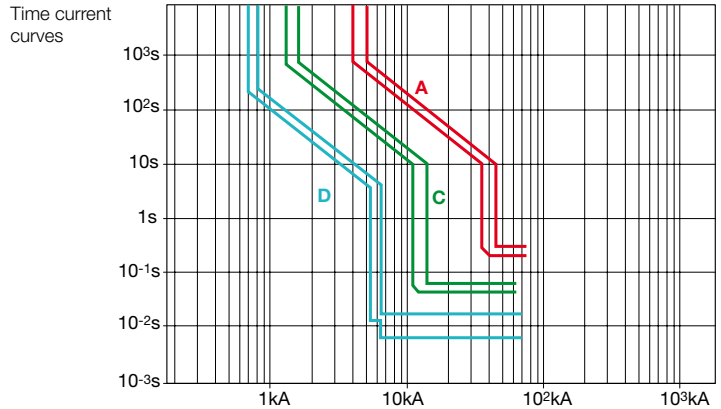

The figure at the side shows the situation in which, after switching, the power is supplied by the power unit through circuit-breaker B. If the settings of circuit-breakers C are not modified, there will be no selectivity with the main circuit-breaker B.

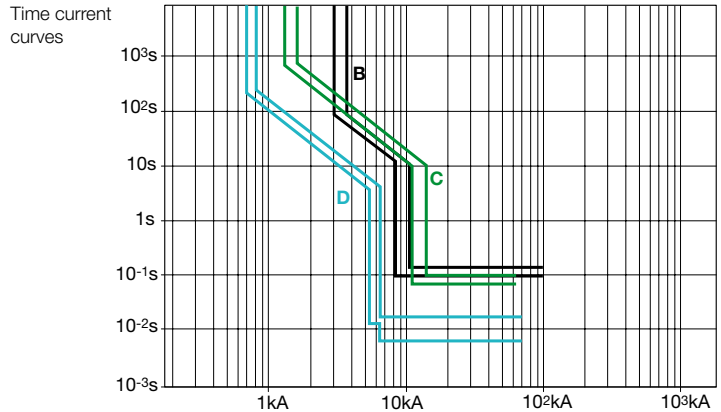

This last figure shows how it is possible to switch to a set of parameters which guarantees selectivity of circuit-breakers C with B by means of the “dual setting” function.

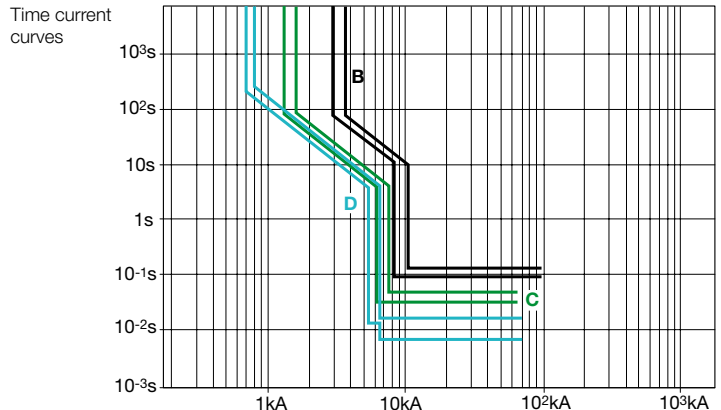

## Annex C: Application examples

### Advanced protection functions with PR123/P and PR333/P releases

#### Double G

The Emax type circuit-breakers, equipped with the PR123 and PR333 electronic releases, allow two independent curves for protection G:

- one for the internal protection (function G without external toroid);
- one for the external protection (function G with external toroid)

A typical application of function double G consists in simultaneous protection both against earth fault of the secondary of the transformer and of its connection cables to the circuit-breaker terminals (restricted earth fault protection), as well as against earth faults on the load side of the circuit-breaker (outside the restricted earth fault protection).

#### Example:

Figure 1 shows a fault on the load side of an Emax circuit-breaker: the fault current flows through one phase only and, if the vectorial sum of the currents detected by the four current transformers (CTs) results to be higher than the set threshold, the electronic release activates function G (and the circuit-breaker trips).

Figure 1

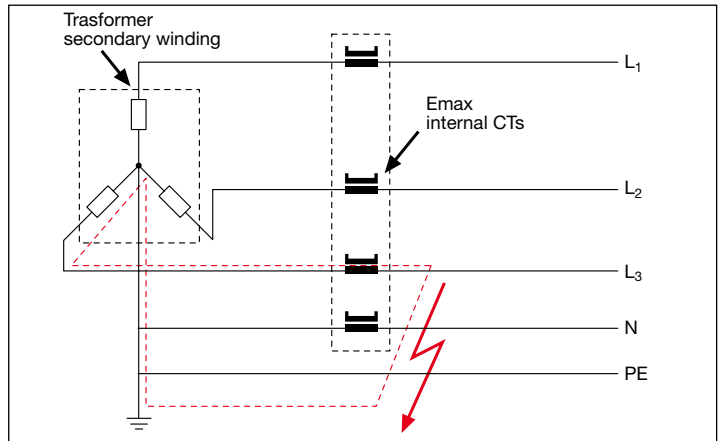

1SDC008050F0201

## Annex C: Application examples

### Advanced protection functions with PR123/P and PR333/P releases

With the same configuration, a fault on the supply side of the circuit-breaker (Figure 2) does not cause intervention of function G since the fault current does not affect either the CT of the phase or that of the neutral.

**Figure 2**

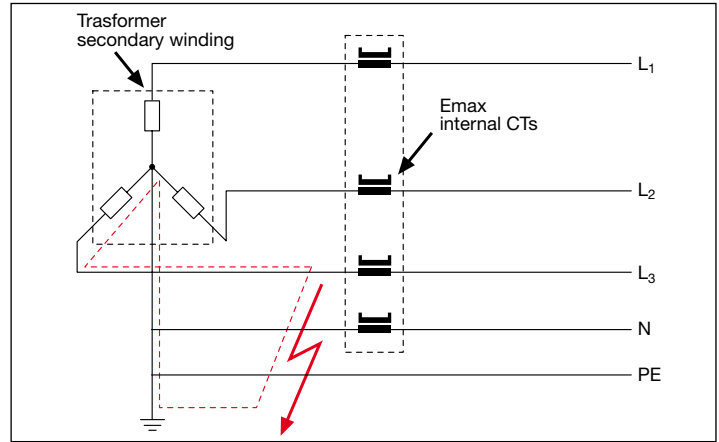

1SDC008051F0201

The use of function “double G” allows installation of an external toroid, as shown in Figure 3, so that earth faults on the supply side of Emax CB can be detected

as well. In this case, the alarm contact of the second G is exploited in order to trip the circuit-breaker installed on the primary and to ensure fault disconnection.

**Figure 3**

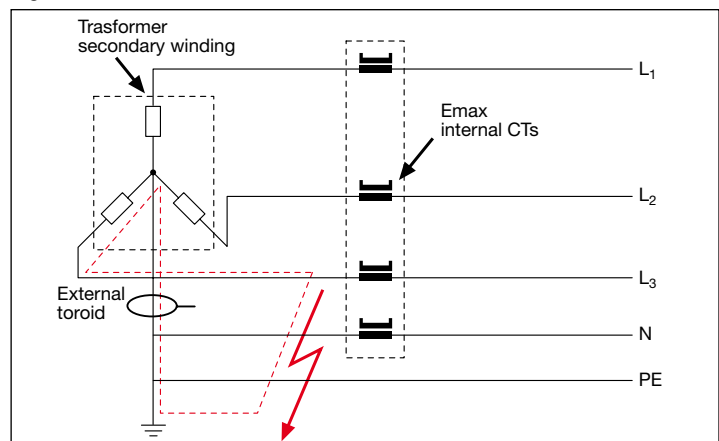

1SDC008052F0201

## Annex C: Application examples

### Advanced protection functions with PR123/P and PR333/P releases

If, with the same configuration as Figure 3, the fault occurs on the load side of the Emax circuit-breaker, the fault current would affect both the toroid as well as the current transformers on the phases. To define which circuit-breaker is to trip (MV or LV circuit-breaker), suitable coordination of the trip times is required: in particular, it is necessary to set the times so that LV circuit-breaker opening due to internal function G is faster than realization of the alarm signal coming from the external toroid. Therefore, thanks to the time-current discrimination between the two G protection functions, before the MV circuit-breaker on the primary of the transformer receives the trip command, the circuit-breaker on the LV side is able to eliminate the earth fault.

Obviously, if the fault occurred on the supply side of the LV circuit-breaker, only the circuit-breaker on the MV side would trip.

The table shows the main characteristics of the range of toroids (available only in the closed version).

#### Characteristics of the toroid ranges

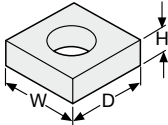
<b>Rated current</b>	<b>100 A, 250 A, 400 A, 800 A</b>
<b>Outer dimensions of the toroid</b>	
	W = 165 mm
	D = 160 mm
	H = 112 mm
<b>Internal diameter of the toroid</b>	Ø = 112 mm

1SDC008053F0201

## Annex C: Application examples

### Advanced protection functions with PR123/P and PR333/P releases

#### Double S

Thanks to the new PR123 and PR333 releases, which allows two thresholds of protection function S to be set independently and be activated simultaneously, selectivity can also be achieved under highly critical conditions.

Here is an example of how, by using the new release, it is possible to obtain a better selectivity level compared with the use of a release without "double S". This is the wiring diagram of the system under examination; in particular, attention must be focussed on:

- the presence, on the supply side, of a MV circuit-breaker, which, for selectivity reasons, imposes low setting values for the Emax circuit-breaker on the LV side
- the presence of a LV/LV transformer which, due to the inrush currents, imposes high setting values for the circuit-breakers on its primary side

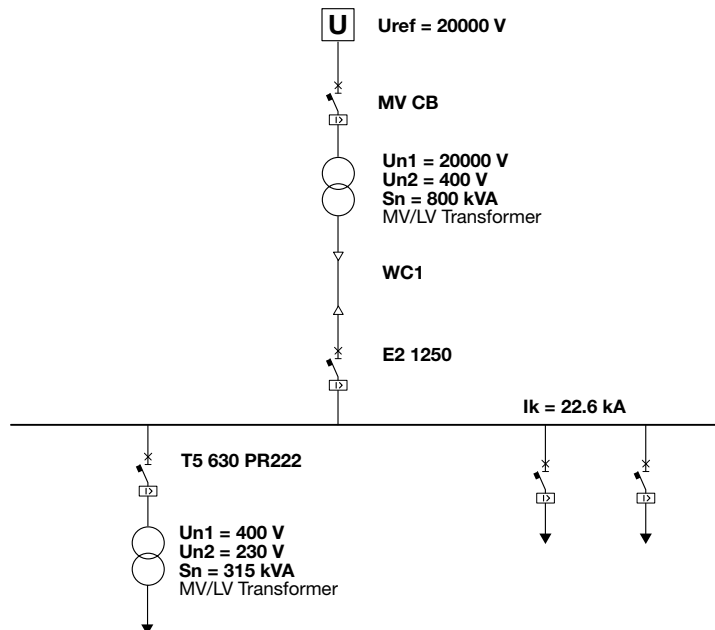

1SDC008054F0201



## Annex C: Application examples

### Advanced protection functions with PR123/P and PR333/P releases

#### Solution with a release without “double S”

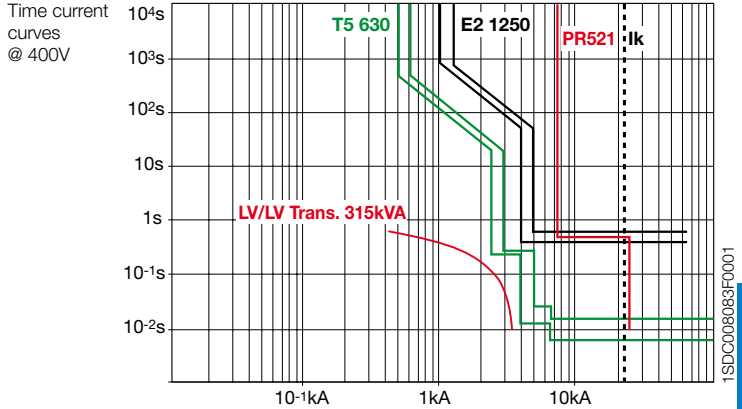

#### MV CB (PR521)

<b>50</b>	(I>): 50A	t=0.5s
<b>51</b>	(I>>): 500A	t=0s

		<b>E2N 1250 PR122 LSIG R1250</b>	<b>T5V 630 PR222DS/P LSIG R630</b>
<b>L</b>	Setting	0.8	0.74
	Curve	108s	12s
<b>S</b> t=constant	Setting	3.5	4.2
	Curve	0.5s	0.25s
<b>I</b>	Setting	OFF	7

In the case of a short-circuit, the Emax E2 circuit-breaker and the MV circuit-breaker will open simultaneously with this solution. Attention must be paid to the fact that, owing to the value  $I_k$ , function I of the E2 circuit-breaker has to be disabled (I3=OFF) so that selectivity with the T5 on the load side is guaranteed.

## Annex C: Application examples

### Advanced protection functions with PR123/P and PR333/P releases

#### Solution with the PR123 release with “double S”

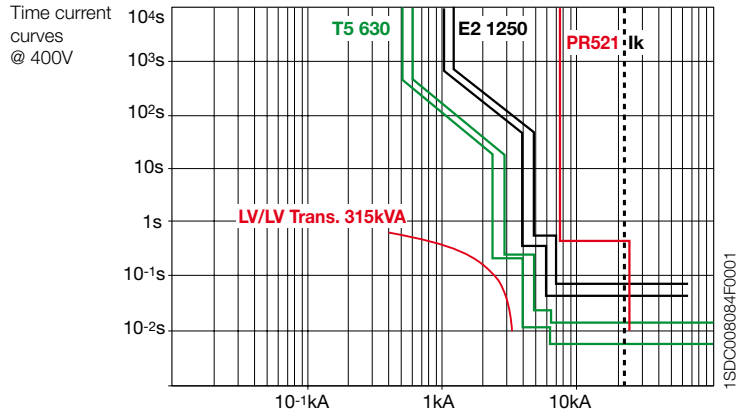

#### MV CB (PR521)

<b>50</b>	(I>): 50A	t=0.5s
<b>51</b>	(I>>): 500A	t=0s

		<b>E2N 1250 PR123 LSIG R1250</b>	<b>T5V 630 PR22DS/P LSIG R630</b>
<b>L</b>	Setting	0.8	0.74
	Curve	108s	12s
<b>S</b> t=constant	Setting	3.5	4.2
	Curve	0.5s	0.25s
<b>S2</b> t=constant	Setting	5	-
	Curve	0.05s	-
<b>I</b>	Setting	OFF	7

As evident, by means of the “double S” function, selectivity can be achieved both with the T5 circuit-breaker on the load side as well as with the MV circuit-breaker on the supply side.

A further advantage obtained by using the “double S” function is the reduction in the time of permanence of high current values under short-circuit conditions, which results in lower thermal and dynamic stresses on the busbars and on the other installation components.





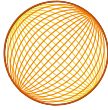

## Part 2

# Electrical devices

## Index

<b>1 Protection of feeders</b>	
1.1 Introduction.....	268
1.2 Installation and dimensioning of cables.....	271
1.2.1 Current carrying capacity and methods of installation.....	271
Installation not buried in the ground.....	280
Installation in ground.....	294
1.2.2 Voltage drop.....	308
1.2.3 Joule-effect losses.....	318
1.3 Protection against overload.....	319
1.4 Protection against short-circuit.....	322
1.5 Neutral and protective conductors.....	331
1.6 Busbar trunking systems.....	339
<b>2 Protection of electrical equipment</b>	
2.1 Protection and switching of lighting circuits.....	353
2.2 Protection and switching of generators.....	362
2.3 Protection and switching of motors.....	367
2.4 Protection and switching of transformers.....	405
<b>3 Power factor correction</b>	
3.1 General aspects.....	422
3.2 Power factor correction method.....	428
3.3 Circuit-breakers for the protection and switching of capacitor banks.....	435
<b>4 Protection of human beings</b>	
4.1 General aspects: effects of current on human beings.....	440
4.2 Distribution systems.....	442
4.3 Protection against both direct and indirect contact.....	445
4.4 TT system.....	448
4.5 TN system.....	452
4.6 IT system.....	454
4.7 Residual current devices.....	456
4.8 Maximum protected length for the protection of human beings.....	459
<b>5 Photovoltaic plants</b>	
5.1 Operating principle.....	464
5.2 Main components of a photovoltaic plants.....	465
5.2.1 Photovoltaic generator.....	465
5.2.2 Inverter.....	467
5.3 Typologies of photovoltaic plants.....	468
5.3.1 Stand-alone plants.....	468
5.3.2 Grid-connected plants.....	468
5.4 Earthing and protection against indirect contact.....	469
5.4.1 Plants with transformer.....	469
5.4.2 Plants without transformer.....	473
5.5 Protection against overcurrents and overvoltages.....	475
5.5.1 Protection against overcurrents on DC side.....	475
5.5.2 Protection against overcurrents on AC side.....	480
5.5.3 Choice of the switching and disconnecting devices.....	481
5.5.4 Protection against overvoltages.....	481
<b>6 Calculation of short-circuit current</b>	
6.1 General aspects.....	485
6.2 Fault typologies.....	485
6.3 Determination of the short-circuit current: "short-circuit power method".....	487
6.3.1 Calculation of the short-circuit current.....	487
6.3.2 Calculation of the short-circuit power at the fault point.....	490
6.3.3 Calculation of the short-circuit current.....	491
6.3.4 Examples.....	493
6.4 Determination of the short-circuit current I <sub>k</sub> downstream of a cable as a function of the upstream one.....	497
6.5 Algebra of sequences.....	499
6.5.1 General aspects.....	499
6.5.2 Positive, negative and zero sequence systems.....	500
6.5.3 Calculation of short-circuit currents with the algebra of sequences.....	501
6.5.4 Positive, negative and zero sequence short-circuit impedances of electrical equipment.....	504
6.5.5 Formulas for the calculation of the fault currents as a function of the electrical parameters of the plant.....	507
6.6 Calculation of the peak value of the short-circuit current.....	510
6.7 Considerations about UPS contribution to the short-circuit.....	511
<b>Annex A: Calculation of load current I<sub>b</sub></b> .....	514
<b>Annex B: Harmonics</b> .....	518
<b>Annex C: Calculation of the coefficient k for the cables</b> .....	526
<b>Annex D: Main physical quantities and electrotechnical formulas</b> .....	530

---

# 1 Protection of feeders

---

## 1.1 Introduction

The following definitions regarding electrical installations are derived from the Standard IEC 60050.

### Characteristics of installations

**Electrical installation** (of a building) An assembly of associated electrical equipment to fulfil a specific purpose and having coordinated characteristics.

**Origin of an electrical installation** The point at which electrical energy is delivered to an installation.

**Neutral conductor** (symbol N) A conductor connected to the neutral point of a system and capable of contributing to the transmission of electrical energy.

**Protective conductor PE** A conductor required by some measures for protection against electric shock for electrically connecting any of the following parts:

- exposed conductive parts;
- extraneous conductive parts;
- main earthing terminal;
- earth electrode;
- earthed point of the source or artificial neutral.

**PEN conductor** An earthed conductor combining the functions of both protective conductor and neutral conductor

**Ambient temperature** The temperature of the air or other medium where the equipment is to be used.

### Voltages

**Nominal voltage** (of an installation) Voltage by which an installation or part of an installation is designated.

Note: the actual voltage may differ from the nominal voltage by a quantity within permitted tolerances.

### Currents

**Design current** (of a circuit) The current intended to be carried by a circuit in normal service.

**Current-carrying capacity** (of a conductor) The maximum current which can be carried continuously by a conductor under specified conditions without its steady-state temperature exceeding a specified value.

**Overcurrent** Any current exceeding the rated value. For conductors, the rated value is the current-carrying capacity.

**Overload current** (of a circuit) An overcurrent occurring in a circuit in the absence of an electrical fault.

**Short-circuit current** An overcurrent resulting from a fault of negligible impedance between live conductors having a difference in potential under normal operating conditions.

# 1 Protection of feeders

**Conventional operating current** (of a protective device) A specified value of the current which cause the protective device to operate within a specified time, designated conventional time.

**Overcurrent detection** A function establishing that the value of current in a circuit exceeds a predetermined value for a specified length of time.

**Leakage current** Electrical current in an unwanted conductive path other than a short circuit.

**Fault current** The current flowing at a given point of a network resulting from a fault at another point of this network.

## Wiring systems

**Wiring system** An assembly made up of a cable or cables or busbars and the parts which secure and, if necessary, enclose the cable(s) or busbars.

## Electrical circuits

**Electrical circuit** (of an installation) An assembly of electrical equipment of the installation supplied from the same origin and protected against overcurrents by the same protective device(s).

**Distribution circuit** (of buildings) A circuit supplying a distribution board.

**Final circuit (of building)** A circuit connected directly to current using equipment or to socket-outlets.

## Other equipment

**Electrical equipment** Any item used for such purposes as generation, conversion, transmission, distribution or utilization of electrical energy, such as machines, transformers, apparatus, measuring instruments, protective devices, equipment for wiring systems, appliances.

**Current-using equipment** Equipment intended to convert electrical energy into another form of energy, for example light, heat, and motive power.

**Switchgear and controlgear** Equipment provided to be connected to an electrical circuit for the purpose of carrying out one or more of the following functions: protection, control, isolation, switching.

**Portable equipment** Equipment which is moved while in operation or which can easily be moved from one place to another while connected to the supply.

**Hand-held equipment** Portable equipment intended to be held in the hand during normal use, in which the motor, if any, forms an integral part of the equipment.

**Stationary equipment** Either fixed equipment or equipment not provided with a carrying handle and having such a mass that it cannot easily be moved.

**Fixed equipment** Equipment fastened to a support or otherwise secured in a specific location.

# 1 Protection of feeders

## Installation dimensioning

The flow chart below suggests the procedure to follow for the correct dimensioning of a plant.

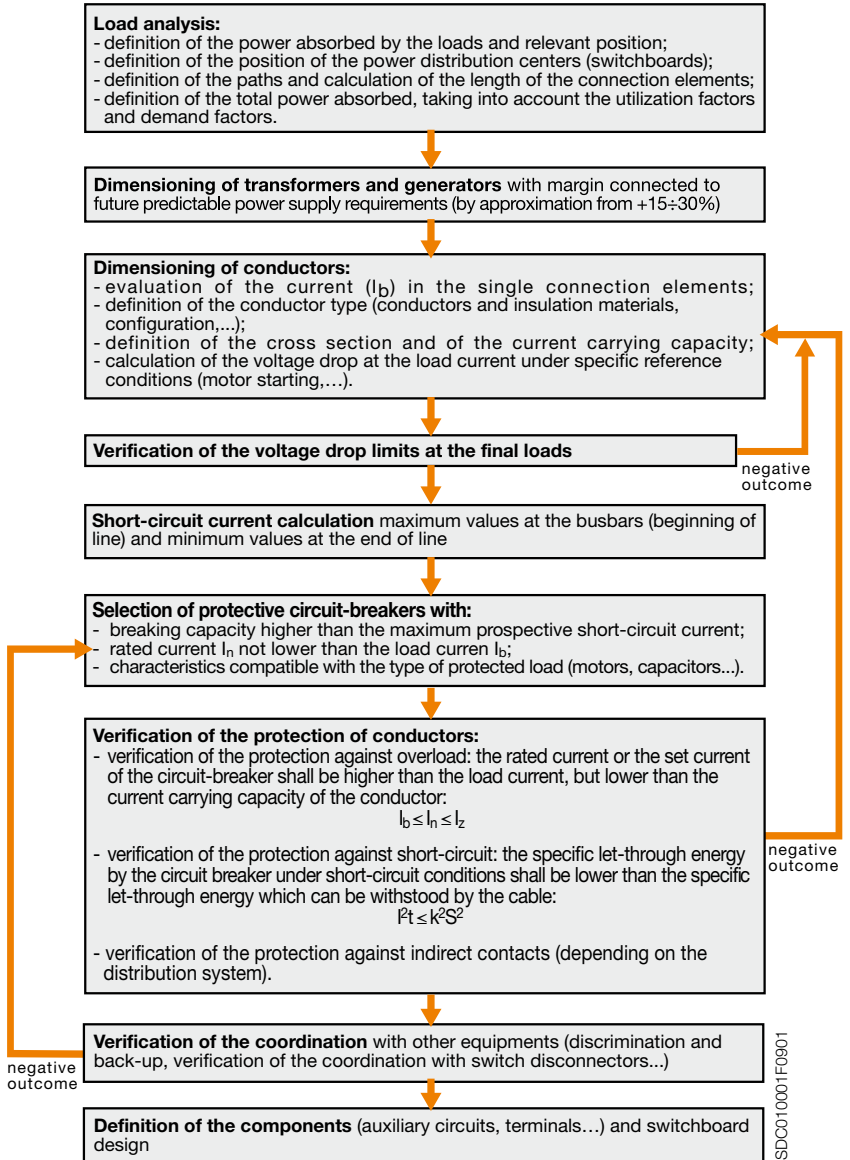



# 1 Protection of feeders

## 1.2 Installation and dimensioning of cables

For a correct dimensioning of a cable, it is necessary to:

- choose the type of cable and installation according to the environment;
- choose the cross section according to the load current;
- verify the voltage drop.

### 1.2.1 Current carrying capacity and methods of installation

#### Selection of the cable

The international reference Standard ruling the installation and calculation of the current carrying capacity of cables in residential and industrial buildings is IEC 60364-5-52 "Electrical installations of buildings – Part 5-52 Selection and Erection of Electrical Equipment- Wiring systems".

The following parameters are used to select the cable type:

- conductive material (copper or aluminium): the choice depends on cost, dimension and weight requirements, resistance to corrosive environments (chemical reagents or oxidizing elements). In general, the carrying capacity of a copper conductor is about 30% greater than the carrying capacity of an aluminium conductor of the same cross section. An aluminium conductor of the same cross section has an electrical resistance about 60% higher and a weight half to one third lower than a copper conductor.
- insulation material (none, PVC, XLPE-EPR): the insulation material affects the maximum temperature under normal and short-circuit conditions and therefore the exploitation of the conductor cross section [see Chapter 1.4 "Protection against short-circuit"].
- the type of conductor (bare conductor, single-core cable without sheath, single-core cable with sheath, multi-core cable) is selected according to mechanical resistance, degree of insulation and difficulty of installation (bends, joints along the route, barriers...) required by the method of installation.

**Table 1 shows the types of conductors permitted by the different methods of installation.**

Conductors and cables		Method of installation							
		Without fixings	Clipped direct	Conduit systems	Cable trunking systems (including skirting trunking, flush floor trunking)	Cable ducting systems	Cable ladder, cable tray, cable brackets	On insulators	Support wire
Bare conductors		-	-	-	-	-	-	+	-
Insulated conductors <sup>b</sup>		-	-	+	+ <sup>a</sup>	+	-	+	-
Sheathed cables (including armoured and mineral insulated)	Multi-core	+	+	+	+	+	+	0	+
	Single-core	0	+	+	+	+	+	0	+
+ Permitted. - Not permitted. 0 Not applicable, or not normally used in practice.									
<sup>a</sup> Insulated conductors are admitted if the cable trunking systems provide at least the degree of protection IP4X or IPXXD and if the cover can only be removed by means of a tool or a deliberate action.									
<sup>b</sup> Insulated conductors which are used as protective conductors or protective bonding conductors may use any appropriate method of installation and need not be laid in conduits, trunking or ducting systems.									

# 1 Protection of feeders

For industrial installations, multi-core cables are rarely used with cross section greater than 95 mm<sup>2</sup>.

## Methods of installation

To define the current carrying capacity of the conductor and therefore to identify the correct cross section for the load current, the standardized method of installation that better suits the actual installation situation must be identified among those described in the mentioned reference Standard.

From Tables 2 and 3 it is possible to identify the installation identification number, the method of installation (A1, A2, B1, B2, C, D1, D2, E, F, G) and the tables to define the theoretical current carrying capacity of the conductor and any correction factors required to allow for particular environmental and installation situations.

**Table 2: Method of installation**

Situations		Method of installation							
		Without fixings	Clipped direct	Conduit systems	Cable trunking systems (including skirting trunking, flush floor trunking)	Cable ducting systems	Cable ladder, cable tray, cable brackets	On insulators	Support wire
Building voids	Accessible	40	33	41, 42	6, 7, 8, 9, 12	43, 44	30, 31, 32, 33, 34	-	0
	Not accessible	40	0	41, 42	0	43	0	0	0
Cable channel		56	56	54, 55	0		30, 31, 32, 34	-	-
Buried in ground		72, 73	0	70, 71	-	70, 71	0	-	-
-Embedded in structure		57, 58	3	1, 2, 59, 60	50, 51, 52, 53	46, 45	0	-	-
Surface mounted		-	20, 21, 22, 23, 33	4, 5	6, 7, 8, 9, 12	6, 7, 8, 9	30, 31, 32, 34	36	-
Overhead/free in air		-	33	0	10, 11	10, 11	30, 31, 32, 34	36	35
Window frames		16	0	16	0	0	0	-	-
Architrave		15	0	15	0	0	0	-	-
Immersed 1		+	+	+	-	+	0	-	-
-	Not permitted.								
0	Not applicable or not normally used in practice.								
+	Follow manufacturer's instructions.								



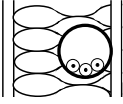
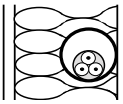
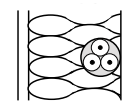
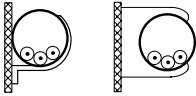
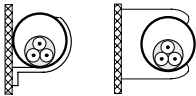
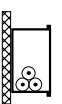
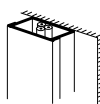
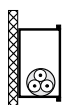
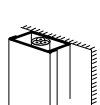

# 1 Protection of feeders

**Table 3: Examples of methods of installation**



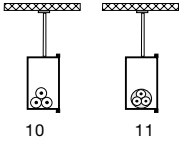

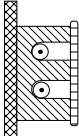
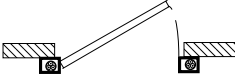
Item No.	Methods of installation	Description	Reference method of installation to be used to obtain current-carrying capacity
1	 Room	Insulated conductors or single-core cables in conduit in a thermally insulated wall <sup>a, c</sup>	A1
2	 Room	Multi-core cables in conduit in a thermally insulated wall <sup>a, c</sup>	A2
3	 Room	Multi-core cable direct in a thermally insulated wall <sup>a, c</sup>	A1
4		Insulated conductors or single-core cables in conduit on a wooden or masonry wall or spaced less than $0,3 \times$ conduit diameter from it <sup>f</sup>	B1
5		Multi-core cable in conduit on a wooden or masonry wall or spaced less than $0,3 \times$ conduit diameter from it <sup>c</sup>	B2
6		Insulated conductors or single-core cables in cable trunking (includes multi-compartment trunking) on a wooden or masonry wall – run horizontally <sup>b</sup> – run vertically <sup>b, c</sup>	B1
7			
8		Multi-core cable in cable trunking (includes multi-compartment trunking) on a wooden or masonry wall – run horizontally <sup>b</sup> – run vertically <sup>b, c</sup>	Under consideration <sup>d</sup> Method B2 may be used
9			

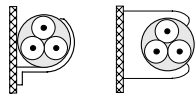
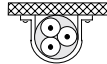
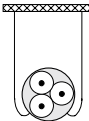
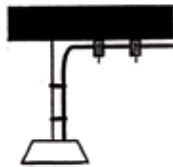
NOTE 1 The illustrations are not intended to depict actual product or installation practices but are indicative of the method described.

# 1 Protection of feeders

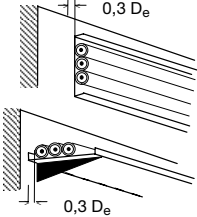
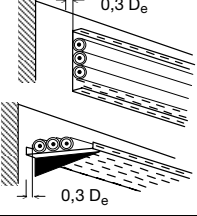
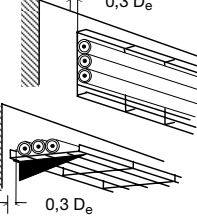
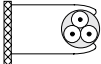
Item No	Methods of installation	Description	Reference method of installation to be used to obtain current-carrying capacity
10		Insulated conductors or single-core cable in suspended cable trunking <sup>b</sup>	B1
11		Multi-core cable in suspended cable trunking <sup>b</sup>	B2
12		Insulated conductors or single-core cable run in mouldings <sup>c,e</sup>	A1
15		Insulated conductors in conduit or single-core or multi-core cable in architrave <sup>c,f</sup>	A1
16		Insulated conductors in conduit or single-core or multi-core cable in window frames <sup>c,f</sup>	A1
20		Single-core or multi-core cables: – fixed on, or spaced less than $0,3 \times$ cable diameter from a wooden or masonry wall <sup>c</sup>	C
21		Single-core or multi-core cables: – fixed directly under a wooden or masonry ceiling	C, with item 3 of Table 5
22		Single-core or multi-core cables: – spaced from a ceiling	Under consideration Method E may be used
23		Fixed installation of suspended current-using equipment	C, with item 3 of Table 5

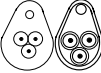



# 1 Protection of feeders

Item No.	Methods of installation	Description	Reference method of installation to be used to obtain current-carrying capacity
30		Single-core or multi-core cables: On unperforated tray run horizontally or vertically <sup>c, h</sup>	C with item 2 of Table 5
31		Single-core or multi-core cables: On perforated tray run horizontally or vertically <sup>c, h</sup>	E or F
32		Single-core or multi-core cables: On brackets or on a wire mesh tray run horizontally or vertically <sup>c, h</sup>	E or F
33		Single-core or multi-core cables: Spaced more than 0,3 times cable diameter from a wall	E or F or method G <sup>9</sup>
34		Single-core or multi-core cables: On ladder <sup>c</sup>	E or F
35		Single-core or multi-core cable suspended from or incorporating a support wire or harness	E or F
36		Bare or insulated conductors on insulators	G

# 1 Protection of feeders

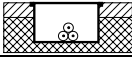
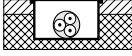
Item No.	Methods of installation	Description	Reference method of installation to be used to obtain current-carrying capacity
40		Single-core or multi-core cable in a building void <sup>c, h, i</sup>	1,5 D <sub>e</sub> V < 5 D <sub>e</sub> B2 5 D <sub>e</sub> V < 20 D <sub>e</sub> B1
41		Insulated conductor in conduit in a building void <sup>c, i, j, k</sup>	1,5 D <sub>e</sub> V < 20 D <sub>e</sub> B2 V 20 D <sub>e</sub> B1
42		Single-core or multi-core cable in conduit in a building void <sup>c, k</sup>	Under consideration The following may be used: 1,5 D <sub>e</sub> V < 20 D <sub>e</sub> B2 V 20 D <sub>e</sub> B1
43		Insulated conductors in cable ducting in a building void <sup>c, i, j, k</sup>	1,5 D <sub>e</sub> V < 20 D <sub>e</sub> B2 V 20 D <sub>e</sub> B1
44		Single-core or multi-core cable in cable ducting in a building void <sup>c, k</sup>	Under consideration The following may be used: 1,5 D <sub>e</sub> V < 20 D <sub>e</sub> B2 V 20 D <sub>e</sub> B1
45		Insulated conductors in cable ducting in masonry having a thermal resistivity not greater than 2 K·m/W <sup>c, h, i</sup>	1,5 D <sub>e</sub> V < 5 D <sub>e</sub> B2 5 D <sub>e</sub> V < 50 D <sub>e</sub> B1
46		Single-core or multi-core cable in cable ducting in masonry having a thermal resistivity not greater than 2 K·m/W <sup>c</sup>	Under consideration The following may be used: 1,5 D <sub>e</sub> V < 20 D <sub>e</sub> B2 V 20 D <sub>e</sub> B1
47		Single-core or multi-core cable: – in a ceiling void – in a raised floor <sup>h, i</sup>	1,5 D <sub>e</sub> V < 5 D <sub>e</sub> B2 5 D <sub>e</sub> V < 50 D <sub>e</sub> B1

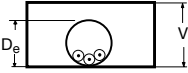
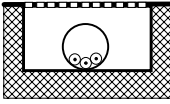
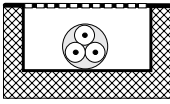
# 1 Protection of feeders

Item No.	Methods of installation	Description	Reference method of installation to be used to obtain current-carrying capacity
50		Insulated conductors or single-core cable in flush cable trunking in the floor	B1
51		Multi-core cable in flush cable trunking in the floor	B2
52		Insulated conductors or single-core cables in flush cable trunking <sup>c</sup>	B1
53			B2
54		Insulated conductors or single-core cables in conduit in an unventilated cable channel run horizontally or vertically <sup>c, i, l, n</sup>	$1,5 D_e \quad V < 20 D_e$ B2 $V \geq 20 D_e$ B1
55		Insulated conductors in conduit in an open or ventilated cable channel in the floor <sup>m, n</sup>	B1
56		Sheathed single-core or multi-core cable in an open or ventilated cable channel run horizontally or vertically <sup>n</sup>	B1
57		Single-core or multi-core cable direct in masonry having a thermal resistivity not greater than $2 \text{ K} \cdot \text{m/W}$  Without added mechanical protection <sup>o, p</sup>	C

# 1 Protection of feeders

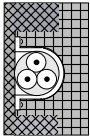
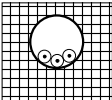
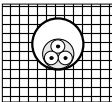
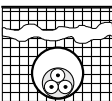
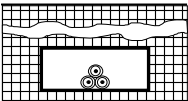
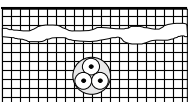
Item No.	Methods of installation	Description	Reference method of installation to be used to obtain current-carrying capacity
58		<p>Single-core or multi-core cable direct in masonry having a thermal resistivity not greater than 2 K·m/W</p> <p>With added mechanical protection <sup>o, p</sup></p>	C
59		<p>Insulated conductors or single-core cables in conduit in masonry <sup>p</sup></p>	B1
60		<p>Multi-core cables in conduit in masonry <sup>p</sup></p>	B2
70		<p>Multi-core cable in conduit or in cable ducting in the ground</p>	D1
71		<p>Single-core cable in conduit or in cable ducting in the ground</p>	D1
72		<p>Sheathed single-core or multi-core cables direct in the ground</p> <p>– without added mechanical protection <sup>q</sup></p>	D2

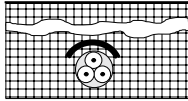

# 1 Protection of feeders

Item No.	Methods of installation	Description	Reference method of installation to be used to obtain current-carrying capacity
73		Sheathed single-core or multi-core cables direct in the ground – with added mechanical protection <sup>g</sup>	D2
<p><sup>a</sup> The inner skin of the wall has a thermal conductance of not less than 10 W/m<sup>2</sup>·K.</p> <p><sup>b</sup> Values given for installation methods B1 and B2 are for a single circuit. Where there is more than one circuit in the trunking the group reduction factor given in Table 5 is applicable, irrespective of the presence of an internal barrier or partition.</p> <p><sup>c</sup> Care shall be taken where the cable runs vertically and ventilation is restricted. The ambient temperature at the top of the vertical section can be increased considerably. The matter is under consideration.</p> <p><sup>d</sup> Values for reference method B2 may be used.</p> <p><sup>e</sup> The thermal resistivity of the enclosure is assumed to be poor because of the material of construction and possible air spaces. Where the construction is thermally equivalent to methods of installation 6 or 7, reference method B1 may be used.</p> <p><sup>f</sup> The thermal resistivity of the enclosure is assumed to be poor because of the material of construction and possible air spaces. Where the construction is thermally equivalent to methods of installation 6, 7, 8, or 9, reference methods B1 or B2 may be used.</p> <p><sup>g</sup> The factors in Table 5 may also be used.</p> <p><sup>h</sup> D<sub>e</sub> is the external diameter of a multi-core cable:            - 2,2 × the cable diameter when three single core cables are bound in trefoil, or            - 3 × the cable diameter when three single core cables are laid in flat formation.</p> <p><sup>i</sup> V is the smaller dimension or diameter of a masonry duct or void, or the vertical depth of a rectangular duct, floor or ceiling void or channel. The depth of the channel is more important than the width.</p> <p><sup>j</sup> D<sub>e</sub> is the external diameter of conduit or vertical depth of cable ducting.</p> <p><sup>l</sup> D<sub>e</sub> is the external diameter of the conduit.</p> <p><sup>m</sup> For multi-core cable installed in method 55, use current-carrying capacity for reference method B2.</p> <p><sup>n</sup> It is recommended that these methods of installation are used only in areas where access is restricted to authorized persons so that the reduction in current-carrying capacity and the fire hazard due to the accumulation of debris can be prevented.</p> <p><sup>o</sup> For cables having conductors not greater than 16 mm<sup>2</sup>, the current-carrying capacity may be higher.</p> <p><sup>p</sup> Thermal resistivity of masonry is not greater than 2 K·m/W, the term “masonry” is taken to include brickwork, concrete, plaster and the like (other than thermally insulating materials).</p> <p><sup>q</sup> The inclusion of directly buried cables in this item is satisfactory when the soil thermal resistivity is of the order of 2,5 K·m/W. For lower soil resistivities, the current-carrying capacity for directly buried cables is appreciably higher than for cables in ducts.</p>			

# 1 Protection of feeders

## Installation not buried in the ground: choice of the cross section according to cable carrying capacity and type of installation

The cable carrying capacity of a cable that is not buried in the ground is obtained by using this formula:

$$I_z = I_0 k_1 k_2 = I_0 k_{\text{tot}}$$

where:

- $I_0$  is the current carrying capacity of the single conductor at 30 °C reference ambient temperature;
- $k_1$  is the correction factor if the ambient temperature is other than 30 °C;
- $k_2$  is the correction factor for cables installed bunched or in layers or for cables installed in a layer on several supports.

### Correction factor $k_1$

The current carrying capacity of the cables that are not buried in the ground refers to 30 °C ambient temperature. If the ambient temperature of the place of installation is different from this reference temperature, the correction factor  $k_1$  on Table 4 shall be used, according to the insulation material.

**Table 4: Correction factor for ambient air temperature other than 30 °C**

Ambient temperature <sup>(a)</sup> °C	Insulation			
	PVC	XLPE and EPR	Mineral <sup>(a)</sup>	
			PVC covered or bare and exposed to touch 70 °C	Bare not exposed to touch 105 °C
10	1.22	1.15	1.26	1.14
15	1.17	1.12	1.20	1.11
20	1.12	1.08	1.14	1.07
25	1.06	1.04	1.07	1.04
35	0.94	0.96	0.93	0.96
40	0.87	0.91	0.85	0.92
45	0.79	0.87	0.87	0.88
50	0.71	0.82	0.67	0.84
55	0.61	0.76	0.57	0.80
60	0.50	0.71	0.45	0.75
65	–	0.65	–	0.70
70	–	0.58	–	0.65
75	–	0.50	–	0.60
80	–	0.41	–	0.54
85	–	–	–	0.47
90	–	–	–	0.40
95	–	–	–	0.32

<sup>(a)</sup> For higher ambient temperatures, consult manufacturer.

# 1 Protection of feeders

## Correction factor $k_2$

The cable current carrying capacity is influenced by the presence of other cables installed nearby. The heat dissipation of a single cable is different from that of the same cable when installed next to the other ones. The factor  $k_2$  is tabled according to the installation of cables laid close together in layers or bunches.

Definition of layer or bunch

*layer*: several circuits constituted by cables installed one next to another, spaced or not, arranged horizontally or vertically. The cables on a layer are installed on a wall, tray, ceiling, floor or on a cable ladder;

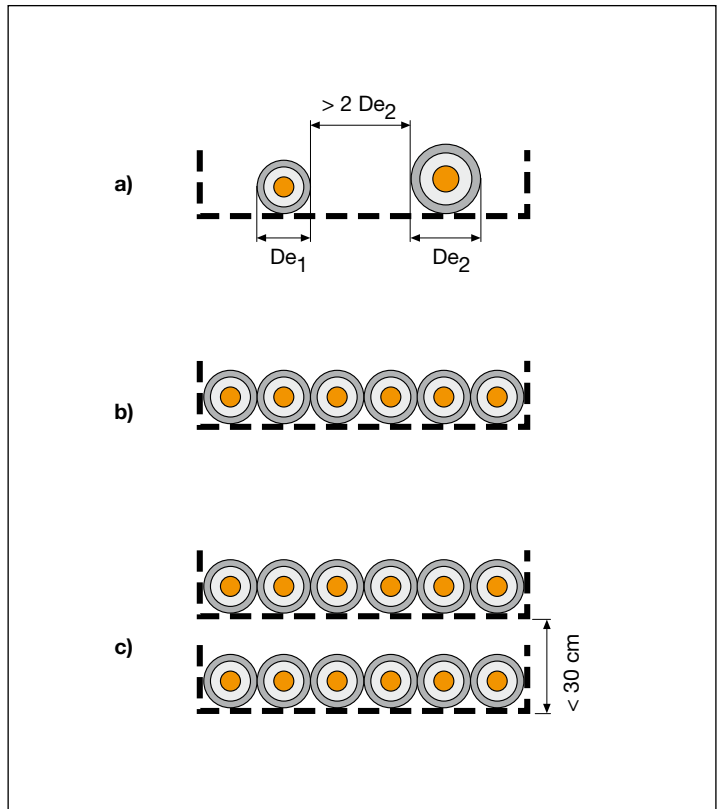

Cables in layers: a) spaced; b) not spaced; c) double layer

*bunch*: several circuits constituted by cables that are not spaced and are not installed in a layer; several layers superimposed on a single support (e.g. tray) are considered to be a bunch.

# 1 Protection of feeders

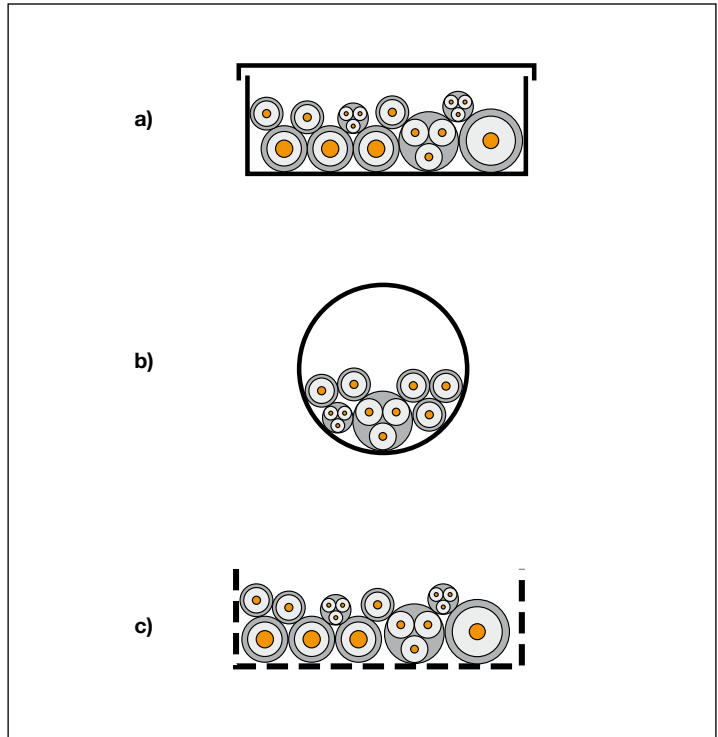

Bunched cables: a) in trunking; b) in conduit; c) on perforated tray

1SDC010003F0001

The value of correction factor  $k_2$  is 1 when:

- the cables are spaced:
  - two single-core cables belonging to different circuits are spaced when the distance between them is more than twice the external diameter of the cable with the larger cross section;
  - two multi-core cables are spaced when the distance between them is at least the same as the external diameter of the larger cable;
- the adjacent cables are loaded less than 30 % of their current carrying capacity.

The correction factors for bunched cables or cables in layers are calculated by assuming that the bunches consist of similar cables that are equally loaded. A group of cables is considered to consist of similar cables when the calculation of the current carrying capacity is based on the same maximum allowed operating temperature and when the cross sections of the conductors is in the range of three adjacent standard cross sections (e.g. from 10 to 25 mm<sup>2</sup>).

The calculation of the reduction factors for bunched cables with different cross sections depends on the number of cables and on their cross sections. These factors have not been tabled, but must be calculated for each bunch or layer.

# 1 Protection of feeders

The reduction factor for a group containing different cross sections of insulated conductors or cables in conduits, cable trunking or cable ducting is:

$$k_2 = \frac{1}{\sqrt{n}}$$

where:

- $k_2$  is the group reduction factor;
- $n$  is the number of multi-core cables of the number of circuit in the group

The reduction factor obtained by this equation reduces the danger of overloading of cables with a smaller cross section, but may lead to under utilization of cables with a larger cross section. Such under utilization can be avoided if large and small cables are not mixed in the same group.

The following tables show the reduction factor ( $k_2$ ).

**Table 5: Reduction factor for grouped cables**

Item	Arrangement (cables touching)	Number of circuits or multi-core cables												To be used with current-carrying capacities, reference
		1	2	3	4	5	6	7	8	9	12	16	20	
1	Bunched in air, on a surface, embedded or enclosed	1.00	0.80	0.70	0.65	0.60	0.57	0.54	0.52	0.50	0.45	0.41	0.38	Methods A to F
2	Single layer on wall, floor or unperforated tray	1.00	0.85	0.79	0.75	0.73	0.72	0.72	0.71	0.70				
3	Single layer fixed directly under a wooden ceiling	0.95	0.81	0.72	0.68	0.66	0.64	0.63	0.62	0.61	No further reduction factor for more than			Method C
4	Single layer on a perforated horizontal or vertical tray	1.00	0.88	0.82	0.77	0.75	0.73	0.73	0.72	0.72	nine circuits or multicore cables			
5	Single layer on ladder support or cleats etc.	1.00	0.87	0.82	0.80	0.80	0.79	0.79	0.78	0.78				Methods E and F

NOTE 1 These factors are applicable to uniform groups of cables, equally loaded.

NOTE 2 Where horizontal clearances between adjacent cables exceeds twice their overall diameter, no reduction factor need be applied.

NOTE 3 The same factors are applied to:

- groups of two or three single-core cables;
- multi-core cables.

NOTE 4 If a system consists of both two- and three-core cables, the total number of cables is taken as the number of circuits, and the corresponding factor is applied to the tables for two loaded conductors for the two-core cables, and to the tables for three loaded conductors for the three-core cables.

NOTE 5 If a group consists of  $n$  single-core cables it may either be considered as  $n/2$  circuits of two loaded conductors or  $n/3$  circuits of three loaded conductors.

NOTE 6 For some installations and for other methods not provided for in the above table, it may be appropriate to use factors calculated for specific case, see for example tables 6-7.

# 1 Protection of feeders

**Table 6: Reduction factor for single-core cables with method of installation F**

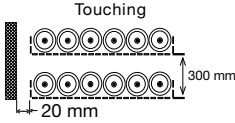
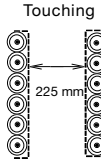
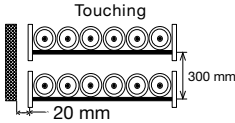
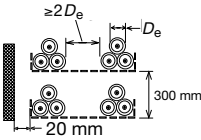
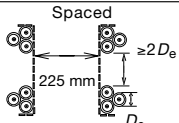
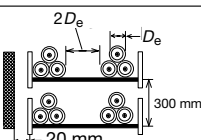
Method of installation in Table 3			Number of trays	Number of three-phase circuits (note 4)			Use as a multiplier to rating for
				1	2	3	
Perforated trays (note 3)	31		1	0.98	0.91	0.87	Three cables in horizontal formation
			2	0.96	0.87	0.81	
			3	0.95	0.85	0.78	
Vertical perforated cable trays systems (note 4)	31		1	0.96	0.86	-	Three cables in vertical formation
			2	0.95	0.84	-	
Cable ladder system cleats, etc. (note 3)	32 33 34		1	1.00	0.97	0.96	Three cables in horizontal formation
			2	0.98	0.93	0.89	
			3	0.97	0.90	0.86	
Perforated cable trays system (note 3)	31		1	1.00	0.98	0.96	
			2	0.97	0.93	0.89	
			3	0.96	0.92	0.86	
Vertical perforated cable trays system (note 4)	31		1	1.00	0.91	0.89	Three cables in trefoil formation
			2	1.00	0.90	0.86	
Cable Ladder system cleats, etc. (note 3)	32 33 34		1	1.00	1.00	1.00	
			2	0.97	0.95	0.93	
			3	0.96	0.94	0.90	

NOTE 1 Values given are averages for the cable types and range of conductor sizes considered in Table 8 to 9 (installation methods E, F and G). The spread of values is generally less than 5 %.

NOTE 2 Factors are given for single layers of cables (or trefoil groups) as shown in the table and do not apply when cables are installed in more than one layer touching each other. Values for such installations may be significantly lower and should be determined by an appropriate method.

NOTE 3 Values are given for vertical spacing between cable trays of 300 mm and at least 20 mm between cable trays and wall. For closer spacing the factors should be reduced.

NOTE 4 Values are given for horizontal spacing between cable trays of 225 mm with cable trays mounted back to back. For closer spacing the factors should be reduced.

NOTE 5 For circuits having more than one cable in parallel per phase, each three phase set of conductors should be considered as a circuit for the purpose of this table.

NOTE 6 If a circuit consists of  $m$  parallel conductors per phase, then for determining the reduction factor this circuit should be considered as  $m$  circuits.

# 1 Protection of feeders

**Table 7: Reduction factor for multi-core cables with method of installation E**

Method of installation in Table 3		Number of trays or ladders	Number of cables per tray or ladder							
			1	2	3	4	6	9		
Perforated cable tray systems (note 3)	31			1	1,00	0,88	0,82	0,79	0,76	0,73
		2	1,00	0,87	0,80	0,77	0,73	0,68		
				1	1,00	1,00	0,98	0,95	0,91	-
				2	1,00	0,99	0,96	0,92	0,87	-
				3	1,00	0,98	0,95	0,91	0,85	-
Vertical perforated cable tray systems (note 4)	31			1	1,00	0,88	0,82	0,78	0,73	0,72
		2	1,00	0,88	0,81	0,76	0,71	0,70		
				1	1,00	0,91	0,89	0,88	0,87	-
				2	1,00	0,91	0,88	0,87	0,85	-
Unperforated cable tray systems	31			1	0,97	0,84	0,78	0,75	0,71	0,68
		2	0,97	0,83	0,76	0,72	0,68	0,63		
		3	0,97	0,82	0,75	0,71	0,66	0,61		
		6	0,97	0,81	0,73	0,69	0,63	0,58		
Cable ladder systems, cleats, etc. (note 3)	32 33 34			1	1,00	0,87	0,82	0,80	0,79	0,78
		2	1,00	0,86	0,80	0,78	0,76	0,73		
		3	1,00	0,85	0,79	0,76	0,73	0,70		
		6	1,00	0,84	0,77	0,73	0,68	0,64		

# 1 Protection of feeders

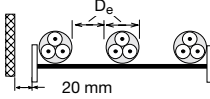
Method of installation in Table 3			Number of trays or ladders	Number of cables per tray or ladder					
				1	2	3	4	6	9
Spaced 			1	1,00	1,00	1,00	1,00	1,00	–
			2	1,00	0,99	0,98	0,97	0,96	–
			3	1,00	0,98	0,97	0,96	0,93	–
<p>NOTE 1 Values given are averages for the cable types and range of conductor sizes considered in Tables 8 to 9 (installation methods E, F and G). The spread of values is generally less than 5 %.</p> <p>NOTE 2 Factors apply to single layer groups of cables as shown above and do not apply when cables are installed in more than one layer touching each other. Values for such installations may be significantly lower and has to be determined by an appropriate method.</p> <p>NOTE 3 Values are given for vertical spacing between cable trays of 300 mm and at least 20 mm between cable trays and wall. For closer spacing the factors should be reduced.</p> <p>NOTE 4 Values are given for horizontal spacing between cable trays of 225 mm with cable trays mounted back to back. For closer spacing the factors should be reduced.</p>									



# 1 Protection of feeders

## To summarize:

The following procedure shall be used to determine the cross section of the cable:

1. from Table 3 identify the method of installation;
2. from Table 4 determine the correction factor  $k_1$  according to insulation material and ambient temperature;
3. use Table 5 for cables installed in layer or bunch, Table 6 for single-core cables in a layer on several supports, Table 7 for multi-core cables in a layer on several supports or the formula shown in the case of groups of cables with different sections to determine the correction factor  $k_2$  appropriate for the numbers of circuits or multi-core cables;
4. calculate the value of current  $I'_b$  by dividing the load current  $I_b$  (or the rated current of the protective device) by the product of the correction factors calculated:

$$I'_b = \frac{I_b}{k_1 k_2} = \frac{I_b}{k_{\text{tot}}}$$

5. from Table 8 or from Table 9, depending on the method of installation, on insulation and conductive material and on the number of live conductors, determine the cross section of the cable with capacity  $I_0 \geq I'_b$ ;
6. the actual cable current carrying capacity is calculated by  $I_z = I_0 k_1 k_2$ .

# 1 Protection of feeders

**Table 8: Current carrying capacity of cables with PVC or EPR/XLPE insulation (method A-B-C)**

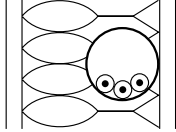
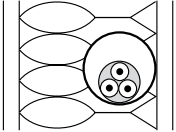
S[mm <sup>2</sup> ]	Loaded conductors	Installation method		A1								A2													
																									
		Conductor				Cu				Al				Cu				Al				Cu			
		Insulation				XLPE EPR		PVC		XLPE EPR		PVC		XLPE EPR		PVC		XLPE EPR		PVC		XLPE EPR			
1.5		2	3	2	3	2	3	2	3	2	3	2	3	2	3	2	3	2	3	2	3	2	3		
2.5		19	17	14.5	13.5							18.5	16.5	14	13							23	20		
4		26	23	19.5	18	20	19	15	14	25	22	18.5	17.5	19.5	18	14.5	13.5					31	28		
6		35	31	26	24	27	25	20	18.5	33	30	25	23	26	24	19.5	17.5					42	37		
10		45	40	34	31	35	32	26	24	42	38	32	29	33	31	25	23					54	48		
16		61	54	46	42	48	44	36	32	57	51	43	39	45	41	33	31					75	66		
25		81	73	61	56	64	58	48	43	76	68	57	52	60	55	44	41					100	88		
35		106	95	80	73	84	76	63	57	99	89	75	68	78	71	58	53					133	117		
50		131	117	99	89	103	94	77	70	121	109	92	83	96	87	71	65					164	144		
70		158	141	119	108	125	113	93	84	145	130	110	99	115	104	86	78					198	175		
95		200	179	151	136	158	142	118	107	183	164	139	125	145	131	108	98					253	222		
120		241	216	182	164	191	171	142	129	220	197	167	150	175	157	130	118					306	269		
150		278	249	210	188	220	197	164	149	253	227	192	172	201	180	150	135					354	312		
185		318	285	240	216	253	226	189	170	290	259	219	196	230	206	172	155					393	342		
240		362	324	273	245	288	256	215	194	329	295	248	223	262	233	195	176					449	384		
300		424	380	321	286	338	300	252	227	386	346	291	261	307	273	229	207					528	450		
400		486	435	367	328	387	344	289	261	442	396	334	298	352	313	263	237					603	514		
500																									
630																									

# 1 Protection of feeders

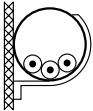
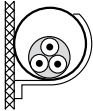
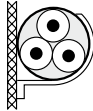
B1							B2							C							
																					
PVC		Al			PVC		Cu			Al			Cu			Al					
PVC		XLPE EPR		PVC		XLPE EPR		PVC		XLPE EPR		PVC		XLPE EPR		PVC					
2	3	2	3	2	3	2	3	2	3	2	3	2	3	2	3	2	3	2	3		
17.5	15.5					22	19.5	16.5	15					24	22	19.5	17.5				
24	21	25	22	18.5	16.5	30	26	23	20	23	21	17.5	15.5	33	30	27	24	26	24	21	18.5
32	28	33	29	25	22.0	40	35	30	27	31	28	24	21	45	40	36	32	35	32	28	25
41	36	43	38	32	28	51	44	38	34	40	35	30	27.0	58	52	46	41	45	41	36	32
57	50	59	52	44	39	69	60	52	46	54	48	41	36	80	71	63	57	62	57	49	44
76	68	79	71	60	53	91	80	69	62	72	64	54	48	107	96	85	76	84	76	66	59
101	89	105	93	79	70	119	105	90	80	94	84	71	62	138	119	112	96	101	90	83	73
125	110	130	116	97	86	146	128	111	99	115	103	86	77	171	147	138	119	126	112	103	90
151	134	157	140	118	104	175	154	133	118	138	124	104	92	209	179	168	144	154	136	125	110
192	171	200	179	150	133	221	194	168	149	175	156	131	116	269	229	213	184	198	174	160	140
232	207	242	217	181	161	265	233	201	179	210	188	157	139	328	278	258	223	241	211	195	170
269	239	281	251	210	186	305	268	232	206	242	216	181	160	382	322	299	259	280	245	226	197
300	262	307	267	234	204	334	300	258	225	261	240	201	176	441	371	344	299	324	283	261	227
341	296	351	300	266	230	384	340	294	255	300	272	230	199	506	424	392	341	371	323	298	259
400	346	412	351	312	269	459	398	344	297	358	318	269	232	599	500	461	403	439	382	352	305
458	394	471	402	358	306	532	455	394	339	415	364	308	265	693	576	530	464	508	440	406	351

1SDC010006F0201

# 1 Protection of feeders

**Table 8: Current carrying capacity of cables with PVC or EPR/XLPE insulation (method E-F-G)**

	Installation method	E								F							
	Cu		Al		Cu		Al		Cu		Al		Cu		Al		
Insulation	XLPE EPR	PVC	XLPE EPR	PVC	XLPE EPR	PVC	XLPE EPR	PVC	XLPE EPR	PVC	XLPE EPR	PVC	XLPE EPR	PVC	XLPE EPR	PVC	
S[mm <sup>2</sup> ]	Loaded conductors	2				3				2				3			
	1.5	26	22			23	18.5										
	2.5	36	30	28	23	32	25	24	19.5								
	4	49	40	38	31	42	34	32	26								
	6	63	51	49	39	54	43	42	33								
	10	86	70	67	54	75	60	58	46								
	16	115	94	91	73	100	80	77	61								
	25	149	119	108	89	127	101	97	78	161	131	121	98	135	110	103	84
	35	185	148	135	111	158	126	120	96	200	162	150	122	169	137	129	105
	50	225	180	164	135	192	153	146	117	242	196	184	149	207	167	159	128
	70	289	232	211	173	246	196	187	150	310	251	237	192	268	216	206	166
	95	352	282	257	210	298	238	227	183	377	304	289	235	328	264	253	203
	120	410	328	300	244	346	276	263	212	437	352	337	273	383	308	296	237
150	473	379	346	282	399	319	304	245	504	406	389	316	444	356	343	274	
185	542	434	397	322	456	364	347	280	575	463	447	363	510	409	395	315	
240	641	514	470	380	538	430	409	330	679	546	530	430	607	485	471	375	
300	741	593	543	439	621	497	471	381	783	629	613	497	703	561	547	434	
400									940	754	740	600	823	656	663	526	
500									1083	868	856	694	946	749	770	610	
630									1254	1005	996	808	1088	855	899	711	

# 1 Protection of feeders

				G							
XLPE EPR	PVC	XLPE EPR	PVC	XLPE EPR	PVC	XLPE EPR	PVC	XLPE EPR	PVC		
3				3H	3V	3H	3V	3H	3V	3H	3V
141	114	107	87	182	161	146	130	138	122	112	99
176	143	135	109	226	201	181	162	172	153	139	124
216	174	165	133	275	246	219	197	210	188	169	152
279	225	215	173	353	318	281	254	271	244	217	196
342	275	264	212	430	389	341	311	332	300	265	241
400	321	308	247	500	454	396	362	387	351	308	282
464	372	358	287	577	527	456	419	448	408	356	327
533	427	413	330	661	605	521	480	515	470	407	376
634	507	492	392	781	719	615	569	611	561	482	447
736	587	571	455	902	833	709	659	708	652	557	519
868	689	694	552	1085	1008	852	795	856	792	671	629
998	789	806	640	1253	1169	982	920	991	921	775	730
1151	905	942	746	1454	1362	1138	1070	1154	1077	900	852

1SDC010100R201

# 1 Protection of feeders

**Table 9: Current carrying capacity of cables with mineral insulation**

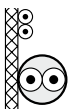
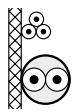
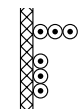
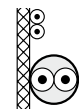
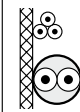
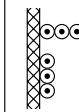
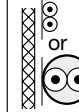
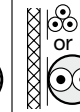
	Installation method	C								
		Metallic sheath temperature 70 °C			Metallic sheath temperature 105 °C			Metallic sheath temperature		
	Sheath	PVC covered or bare exposed to touch			Bare cable not exposed to touch			PVC covered or bare exposed to touch		
		Loaded conductors								
S[mm <sup>2</sup> ]	2		3	3	2	3	3	2	3	
500 V	1.5	23	19	21	28	24	27	25	21	
	2.5	31	26	29	38	33	36	33	28	
	4	40	35	38	51	44	47	44	37	
750 V	1.5	25	21	23	31	26	30	26	22	
	2.5	34	28	31	42	35	41	36	30	
	4	45	37	41	55	47	53	47	40	
	6	57	48	52	70	59	67	60	51	
	10	77	65	70	96	81	91	82	69	
	16	102	86	92	127	107	119	109	92	
	25	133	112	120	166	140	154	142	120	
	35	163	137	147	203	171	187	174	147	
	50	202	169	181	251	212	230	215	182	
	70	247	207	221	307	260	280	264	223	
	95	296	249	264	369	312	334	317	267	
	120	340	286	303	424	359	383	364	308	
	150	388	327	346	485	410	435	416	352	
185	440	371	392	550	465	492	472	399		
240	514	434	457	643	544	572	552	466		

Note 1 For single-core cables the sheaths of the cables of the circuit are connected together at both ends.

Note 2 For bare cables exposed to touch, values should be multiplied by 0.9.

Note 3  $D_e$  is the external diameter of the cable.

Note 4 For metallic sheath temperature 105 °C no correction for grouping need to be applied.

# 1 Protection of feeders

E or F				G			
70 °C	Metallic sheath temperature 105 °C			Metallic sheath temperature 70 °C		Metallic sheath temperature 105 °C	
	Bare cable not exposed to touch			PVC covered or bare exposed to touch		Bare cable not exposed to touch	
3	2	3	3	3	3	3	3
23	31	26	29	26	29	33	37
31	41	35	39	34	39	43	49
41	54	46	51	45	51	56	64
26	33	28	32	28	32	35	40
34	45	38	43	37	43	47	54
45	60	50	56	49	56	61	70
57	76	64	71	62	71	78	89
77	104	87	96	84	95	105	120
102	137	115	127	110	125	137	157
132	179	150	164	142	162	178	204
161	220	184	200	173	197	216	248
198	272	228	247	213	242	266	304
241	333	279	300	259	294	323	370
289	400	335	359	309	351	385	441
331	460	385	411	353	402	441	505
377	526	441	469	400	454	498	565
426	596	500	530	446	507	557	629
496	697	584	617	497	565	624	704

TSDC010007FC0201

# 1 Protection of feeders

## Installation in ground: choice of the cross section according to cable carrying capacity and type of installation

The current carrying capacity of a cable buried in the ground is calculated by using this formula:

$$I_z = I_0 k_1 k_2 k_3 = I_0 k_{\text{tot}}$$

where:

- $I_0$  is the current carrying capacity of the single conductor for installation in the ground at 20°C reference temperature;
- $k_1$  is the correction factor if the temperature of the ground is other than 20°C;
- $k_2$  is the correction factor for adjacent cables;
- $k_3$  is the correction factor if the soil thermal resistivity is different from the reference value, 2.5 Km/W.

### Correction factor $k_1$

The current carrying capacity of buried cables refers to a ground temperature of 20 °C. If the ground temperature is different, use the correction factor  $k_1$  shown in Table 10 according to the insulation material.

**Table 10: Correction factors for ambient ground temperatures other than 20 °C**

Ground temperature °C	Insulation	
	PVC	XLPE and EPR
10	1.10	1.07
15	1.05	1.04
25	0.95	0.96
30	0.89	0.93
35	0.84	0.89
40	0.77	0.85
45	0.71	0.80
50	0.63	0.76
55	0.55	0.71
60	0.45	0.65
65	–	0.60
70	–	0.53
75	–	0.46
80	–	0.38



# 1 Protection of feeders

## Correction factor $k_2$

The cable current carrying capacity is influenced by the presence of other cables installed nearby. The heat dissipation of a single cable is different from that of the same cable installed next to the other ones.

The correction factor  $k_2$  is obtained by the formula:

$$k_2 = k_2' \cdot k_2''$$

Tables 11, 12, and 13 show the factor  $k_2'$  values for single-core and multi-core cables that are laid directly in the ground or which are installed in buried ducts, according to their distance from other cables or the distance between the ducts.

**Table 11: Reduction factors for cables laid directly in the ground (installation method D2)**

Number of circuits	Cable to cable clearance				
	Nil (cables touching)	One cable diameter	0,125 m	0,25 m	0,5 m
2	0,75	0,80	0,85	0,90	0,90
3	0,65	0,70	0,75	0,80	0,85
4	0,60	0,60	0,70	0,75	0,80
5	0,55	0,55	0,65	0,70	0,80
6	0,50	0,55	0,60	0,70	0,80
7	0,45	0,51	0,59	0,67	0,76
8	0,43	0,48	0,57	0,65	0,75
9	0,41	0,46	0,55	0,63	0,74
12	0,36	0,42	0,51	0,59	0,71
16	0,32	0,38	0,47	0,56	0,68
20	0,29	0,35	0,44	0,53	0,66

Multi-core cables



Single-core cables



NOTE 1 Values given apply to an installation depth of 0,7 m and a soil thermal resistivity of 2,5 K·m/W. They are average values for the range of cable sizes and types quoted for Tables 8-15-16. The process of averaging, together with rounding off, can result in some cases in errors up to ±10 %. (Where more precise values are required they may be calculated by methods given in IEC 60287-2-1.)

NOTE 2 In case of a thermal resistivity lower than 2,5 K·m/W the correction factors can, in general, be increased and can be calculated by the methods given in IEC 60287-2-1.

NOTE 3 If a circuit consists of  $m$  parallel conductors per phase, then for determining the reduction factor, this circuit should be considered as  $m$  circuits.

# 1 Protection of feeders

**Table 12: Reduction factors for multi-core cables laid in single way ducts in the ground (installation method D1)**

Number of cables	Multi-core cables in single-way ducts			
	Duct to duct clearance			
	Nil (ducts touching)	0,25 m	0,5 m	1,0 m
2	0,85	0,90	0,95	0,95
3	0,75	0,85	0,90	0,95
4	0,70	0,80	0,85	0,90
5	0,65	0,80	0,85	0,90
6	0,60	0,80	0,80	0,90
7	0,57	0,76	0,80	0,88
8	0,54	0,74	0,78	0,88
9	0,52	0,73	0,77	0,87
10	0,49	0,72	0,76	0,86
11	0,47	0,70	0,75	0,86
12	0,45	0,69	0,74	0,85
13	0,44	0,68	0,73	0,85
14	0,42	0,68	0,72	0,84
15	0,41	0,67	0,72	0,84
16	0,39	0,66	0,71	0,83
17	0,38	0,65	0,70	0,83
18	0,37	0,65	0,70	0,83
19	0,35	0,64	0,69	0,82
20	0,34	0,63	0,68	0,82

Multi-core cables

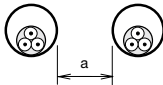

NOTE 1 Values given apply to an installation depth of 0,7 m and a soil thermal resistivity of 2,5 K·m/W. They are average values for the range of cable sizes and types quoted for Tables 8-15-16. The process of averaging, together with rounding off, can result in some cases in errors up to  $\pm 10\%$ . (Where more precise values are required they may be calculated by methods given in IEC 60287-2-1.)

NOTE 2 In case of a thermal resistivity lower than 2,5 K·m/W the corrections factors can, in general, be increased and can be calculated by the methods given in IEC 60287-2-1.

NOTE 3 If a circuit consists of m parallel conductors per phase, then for determining the reduction factor, this circuit should be considered as m circuits.

# 1 Protection of feeders

**Table 13: Reduction factors for single-core cables laid in single way ducts in the ground (installation method D1)**

Single-core cables in non-magnetic single-way ducts				
Number of single-core circuits of two or three cables	Duct to duct clearance			
	Nil (ducts touching)	0,25 m	0,5 m	1,0 m
2	0,80	0,90	0,90	0,95
3	0,70	0,80	0,85	0,90
4	0,65	0,75	0,80	0,90
5	0,60	0,70	0,80	0,90
6	0,60	0,70	0,80	0,90
7	0,53	0,66	0,76	0,87
8	0,50	0,63	0,74	0,87
9	0,47	0,61	0,73	0,86
10	0,45	0,59	0,72	0,85
11	0,43	0,57	0,70	0,85
12	0,41	0,56	0,69	0,84
13	0,39	0,54	0,68	0,84
14	0,37	0,53	0,68	0,83
15	0,35	0,52	0,67	0,83
16	0,34	0,51	0,66	0,83
17	0,33	0,50	0,65	0,82
18	0,31	0,49	0,65	0,82
19	0,30	0,48	0,64	0,82
20	0,29	0,47	0,63	0,81

Single-core cables



NOTE 1 Values given apply to an installation depth of 0,7 m and a soil thermal resistivity of 2,5 K·m/W. They are average values for the range of cable sizes and types quoted for Tables 8-15-16. The process of averaging, together with rounding off, can result in some cases in errors up to  $\pm 10\%$ . (Where more precise values are required they may be calculated by methods given in IEC 60287-2-1.)

NOTE 2 In case of a thermal resistivity lower than 2,5 K·m/W the corrections factors can, in general, be increased and can be calculated by the methods given in IEC 60287-2-1.

NOTE 3 If a circuit consists of m parallel conductors per phase, then for determining the reduction factor, this circuit should be considered asm circuits.

# 1 Protection of feeders

For correction factor  $k_2''$ :

- for cables laid directly in the ground or if there are not other conductors within the same duct, the value of  $k_2''$  is 1;
- if several conductors of similar sizes are present in the same duct (for the meaning of "group of similar conductors", see the paragraphs above),  $k_2''$  is obtained from the first row of Table 5;
- if the conductors are not of similar size, the correction factor is calculated by using this formula:

$$k_2'' = \frac{1}{\sqrt{n}}$$

where:

n is the number of circuits in the duct.

## Correction factor $k_3$

Soil thermal resistivity influences the heat dissipation of the cable. Soil with low thermal resistivity facilitates heat dissipation, whereas soil with high thermal resistivity limits heat dissipation. IEC 60364-5-52 states as reference value for the soil thermal resistivity 2.5 Km/W.

**Table 14: Correction factors for soil thermal resistivities other than 2.5 Km/W**

Thermal resistivity, K · m/W	0,5	0,7	1	1,5	2	2,5	3
Correction factor for cables in buried ducts	1,28	1,20	1,18	1,1	1,05	1	0,96
Correction factor for direct buried cables	1,88	1,62	1,5	1,28	1,12	1	0,90

NOTE 1 The correction factors given have been averaged over the range of conductor sizes and types of installation included in Tables 8-15-16. The overall accuracy of correction factors is within ±5 %.

NOTE 2 The correction factors are applicable to cables drawn into buried ducts; for cables laid direct in the ground the correction factors for thermal resistivities less than 2,5 K-m/W will be higher. Where more precise values are required they may be calculated by methods given in the IEC 60287 series.

NOTE 3 The correction factors are applicable to ducts buried at depths of up to 0,8 m.

NOTE 4 It is assumed that the soil properties are uniform. No allowance had been made for the possibility of moisture migration which can lead to a region of high thermal resistivity around the cable. If partial drying out of the soil is foreseen, the permissible current rating should be derived by the methods specified in the IEC 60287 series.

# 1 Protection of feeders

## To summarize:

Use this procedure to determine the cross section of the cable:

1. from Table 10, determine the correction factor  $k_1$  according to the insulation material and the ground temperature;
2. use Table 11, Table 12, Table 13 or the formula for groups of non-similar cables to determine the correction factor  $k_2$  according to the distance between cables or ducts;
3. from Table 14 determine factor  $k_3$  corresponding to the soil thermal resistivity;
4. calculate the value of the current  $I'_b$  by dividing the load current  $I_b$  (or the rated current of the protective device) by the product of the correction factors calculated:

$$I'_b = \frac{I_b}{k_1 k_2 k_3} = \frac{I_b}{k_{\text{tot}}}$$

5. from Tables 15-16, determine the cross section of the cable with  $I_0 \geq I'_b$ , according to the method of installation, the insulation and conductive material and the number of live conductors;
6. the actual cable current carrying capacity is calculated by.

$$I_z = I_0 k_1 k_2 k_3$$

**Table 15: Current carrying capacity of cables buried in the ground (installation method D1)**

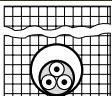
S[mm <sup>2</sup> ]	Loaded conductors	Installation method D1							
									
		Conductor Cu				Al			
		Insulation XLPE EPR		PVC		Insulation XLPE EPR		PVC	
		2	3	2	3	2	3	2	3
1,5	25	21	22	18					
2,5	33	28	29	24	26	22	22	18,5	
4	48	36	37	30	33	28	29	24	
6	53	44	46	38	42	35	36	30	
10	71	58	60	50	55	46	47	39	
16	91	75	78	64	71	59	61	50	
25	116	96	99	82	90	75	77	64	
35	139	115	119	98	108	90	93	77	
50	164	135	140	116	128	106	109	91	
70	203	167	173	143	158	130	135	112	
95	239	197	204	169	186	154	159	132	
120	271	223	231	192	211	174	180	150	
150	306	251	261	217	238	197	204	169	
185	343	281	292	243	267	220	228	190	
240	395	324	336	280	307	253	262	218	
300	496	365	379	316	346	286	296	247	

1SDCO10008F0201

# 1 Protection of feeders

**Table 16: Current carrying capacity of cables buried in the ground (installation method D2)**

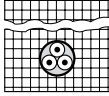
Installation method	D2									
										
Conductor	Cu					Al				
Insulation	XLPE EPR		PVC			XLPE EPR		PVC		
S[mm <sup>2</sup> ]	Loaded conductors		2	3	2	3	2	3	2	3
1.5	27	23	22	19						
2.5	35	30	28	24						
4	46	39	38	33						
6	58	49	48	41						
10	77	65	64	54						
16	100	74	83	70						76
25	129	107	110	92	98	82	82	69		
35	155	129	132	110	117	98	98	83		
50	183	153	156	130	139	117	117	99		
70	225	188	192	162	170	144	145	122		
95	270	226	230	193	204	172	173	148		
120	306	257	261	220	233	197	200	169		
150	343	287	293	246	261	220	224	189		
185	387	324	331	278	296	250	255	214		
240	448	375	382	320	343	290	298	250		
300	502	419	427	359	386	326	336	282		

TSDC010012F0201

# 1 Protection of feeders

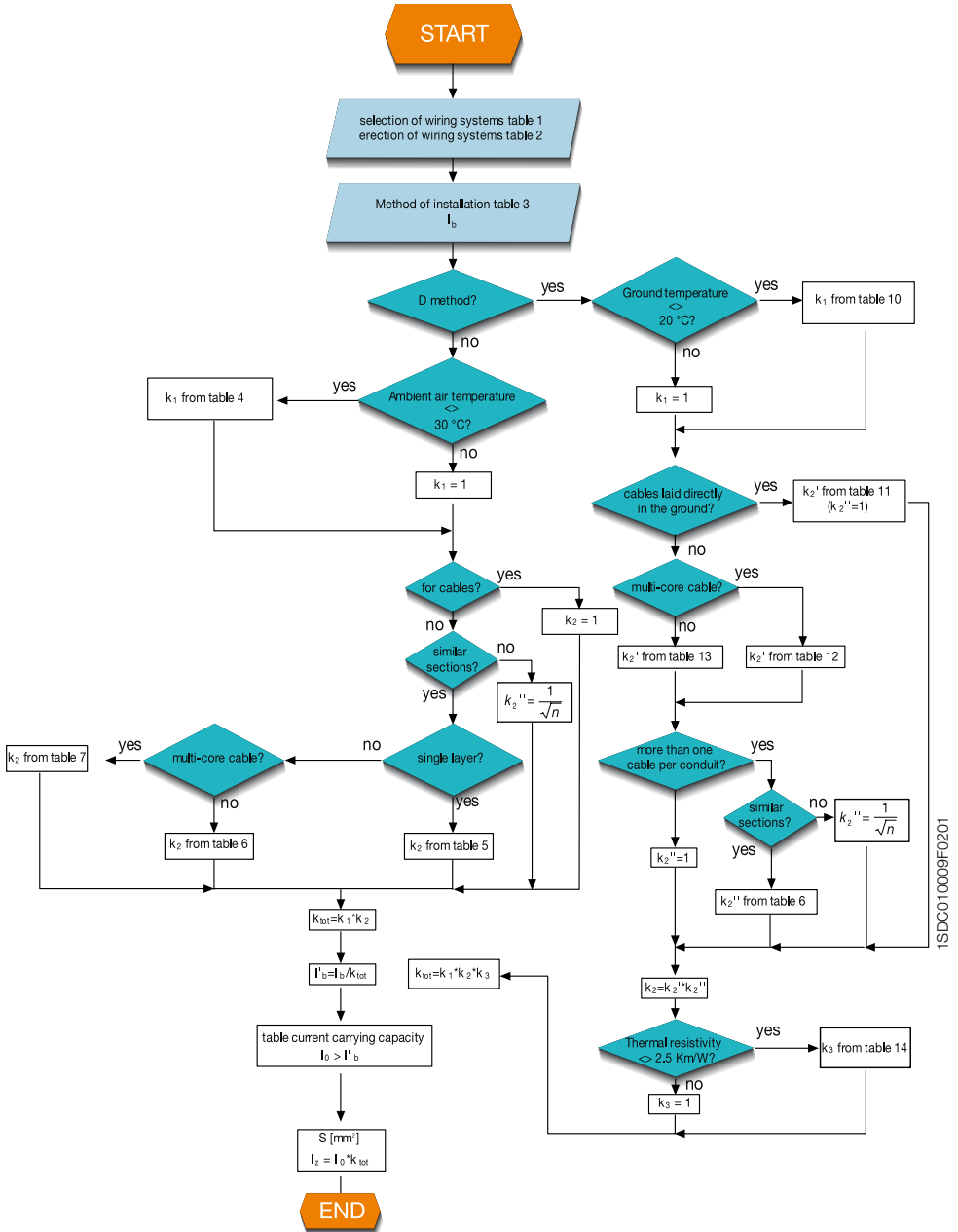

1SDC010009F0201

# 1 Protection of feeders

## Note on current carrying capacity tables and loaded conductors

Tables 8, 9, 15 and 16 provide the current carrying capacity of loaded conductors (current carrying conductors) under normal service conditions.

In single-phase circuits, the number of loaded conductors is two.

In balanced or slightly unbalanced three-phase circuits the number of loaded conductors is three, since the current in the neutral conductor is negligible.

In three-phase systems with high unbalance, where the neutral conductor in a multi-core cable carries current as a result of an unbalance in the phase currents the temperature rise due to the neutral current is offset by the reduction in the heat generated by one or more of the phase conductors. In this case the conductor size shall be chosen on the basis of the highest phase current. In all cases the neutral conductor shall have an adequate cross section.

## Effect of harmonic currents on balanced three-phase systems: reduction factors for harmonic currents in four-core and five-core cables with four cores carrying current

Where the neutral conductor carries current without a corresponding reduction in load of the phase conductors, the current flowing in the neutral conductor shall be taken into account in ascertaining the current-carrying capacity of the circuit.

This neutral current is due to the phase currents having a harmonic content which does not cancel in the neutral. The most significant harmonic which does not cancel in the neutral is usually the third harmonic. The magnitude of the neutral current due to the third harmonic may exceed the magnitude of the power frequency phase current. In such a case the neutral current will have a significant effect on the current-carrying capacity of the cables in the circuit.

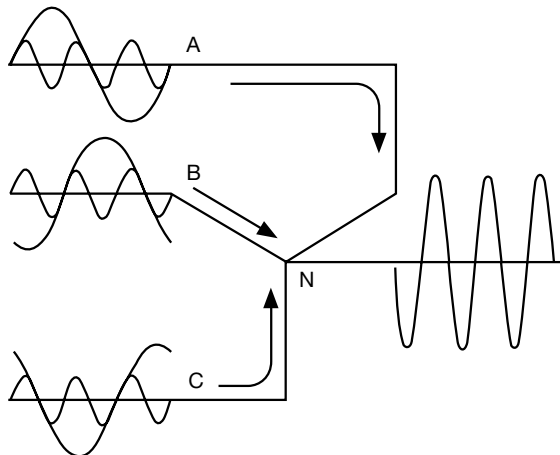



# 1 Protection of feeders

Equipment likely to cause significant harmonic currents are, for example, fluorescent lighting banks and dc power supplies such as those found in computers (for further information on harmonic disturbances see the IEC 61000).

The reduction factors given in Table 16 only apply in the balanced three-phase circuits (the current in the fourth conductor is due to harmonics only) to cables where the neutral conductor is within a four-core or five-core cable and is of the same material and cross-sectional area as the phase conductors. These reduction factors have been calculated based on third harmonic currents. If significant, i.e. more than 10 %, higher harmonics (e.g. 9th, 12th, etc.) are expected or there is an unbalance between phases of more than 50 %, then lower reduction factors may be applicable: these factors can be calculated only by taking into account the real shape of the current in the loaded phases.

Where the neutral current is expected to be higher than the phase current then the cable size should be selected on the basis of the neutral current.

Where the cable size selection is based on a neutral current which is not significantly higher than the phase current, it is necessary to reduce the tabulated current carrying capacity for three loaded conductors.

If the neutral current is more than 135 % of the phase current and the cable size is selected on the basis of the neutral current, then the three phase conductors will not be fully loaded. The reduction in heat generated by the phase conductors offsets the heat generated by the neutral conductor to the extent that it is not necessary to apply any reduction factor to the current carrying capacity for three loaded conductors.

**Table 17: Reduction factors for harmonic currents in four-core and five-core cables**

Third harmonic content of phase current	Reduction factor			
	Size selection is based on phase current	Current to take in account for the cable selection $I'_b$	Size selection is based on neutral current	Current to take in account for the cable selection $I'_b$
%				
0 ÷ 15	1	$I'_b = \frac{I_b}{k_{tot}}$	-	-
15 ÷ 33	0.86	$I'_b = \frac{I_b}{k_{tot} \cdot 0.86}$	-	-
33 ÷ 45	-	-	0.86	$I'_b = \frac{I_N}{0.86}$
> 45	-	-	1	$I'_b = I_N$

Where  $I_N$  is the current flowing in the neutral calculated as follows:  $I_N = \frac{I_b}{k_{tot}} \cdot 3 \cdot k_{III}$

$I_b$  is the load current;

$k_{tot}$  is the total correction factor;

$k_{III}$  is the third harmonic content of phase current;

# 1 Protection of feeders

## Example of cable dimensioning in a balanced three-phase circuit without harmonics

*Dimensioning of a cable with the following characteristics:*

- conductor material: : copper
- insulation material: : PVC
- type of cable: : multi-core
- installation: : cables bunched on horizontal perforated tray
- load current: : 100 A

*Installation conditions:*

- ambient temperature: : 40 °C
- adjacent circuits with
  - a) three-phase circuit consisting of 4 single-core cables, 4x50 mm<sup>2</sup>;
  - b) three-phase circuit consisting of one multi-core cable, 1x(3x50) mm<sup>2</sup>;
  - c) three-phase circuit consisting of 9 single-core (3 per phase) cables, 9x95 mm<sup>2</sup>;
  - d) single-phase circuit consisting of 2 single-core cables, 2x70 mm<sup>2</sup>.

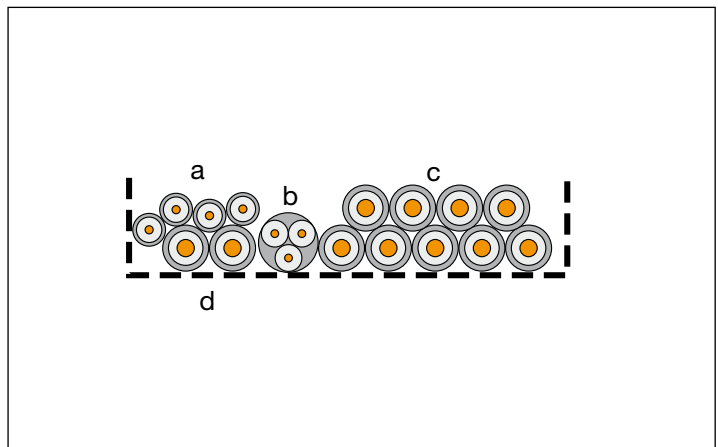

1SDCC10008F0001

# 1 Protection of feeders

## Procedure:

### *Type of installation*

In Table 3, it is possible to find the reference number of the installation and the method of installation to be used for the calculations. In this example, the reference number is 31, which corresponds to method E (multi-core cable on tray).

### *Correction factor of temperature $k_1$*

From Table 4, for a temperature of 40 °C and PVC insulation material,  $k_1 = 0.87$ .

$$k_1 = 0.87$$

### *Correction factor for adjacent cables $k_2$*

For the multi-core cables grouped on the perforated tray see Table 5.

As a first step, the number of circuits or multi-core cables present shall be determined; given that:

- each circuit a), b) and d) constitute a separate circuit;
  - circuit c) consists of three circuits, since it is composed by three cables in parallel per phase;
  - the cable to be dimensioned is a multi-core cable and therefore constitutes a single circuit;
- the total number of circuits is 7.

Referring to the row for the arrangement (cables bunched) and to the column for the number of circuits (7)

$$k_2 = 0.54$$

After  $k_1$  and  $k_2$  have been determined,  $I'_b$  is calculated by:

$$I'_b = \frac{I_b}{k_1 k_2} = \frac{100}{0.87 \cdot 0.54} = 212.85 \text{ A}$$

From Table 8, for a multi-core copper cable with PVC insulation, method of installation E, with three loaded conductors, a cross section with current carrying capacity of  $I_0 \geq I'_b = 212.85 \text{ A}$ , is obtained. A 95 mm<sup>2</sup> cross section cable can carry, under Standard reference conditions, 238 A.

The current carrying capacity, according to the actual conditions of installation, is  $I_z = 238 \cdot 0.87 \cdot 0.54 = 111.81 \text{ A}$

# 1 Protection of feeders

## Example of dimensioning a cable in a balanced three-phase circuit with a significant third-harmonic content

*Dimensioning of a cable with the following characteristics:*

- conductor material: : copper
- insulation material: : PVC
- type of cable: : multi-core
- installation: : layer on horizontal perforated tray
- load current: : 115 A

*Installation conditions:*

- ambient temperature: : 30 °C
- no adjacent circuits.

### Procedure:

*Type of installation*

On Table 3, it is possible to find the reference number of the installation and the method of installation to be used for the calculations. In this example, the reference number is 31, which corresponds to method E (multi-core cable on tray).

*Temperature correction factor  $k_1$*

From Table 4, for a temperature of 30 °C and PVC insulation material

$$k_1 = 1$$

*Correction factor for adjacent cables  $k_2$*

As there are no adjacent cables, so

$$k_2 = 1$$

After  $k_1$  and  $k_2$  have been determined,  $I'_b$  is calculated by:

$$I'_b = \frac{I_b}{k_1 k_2} = 115 \text{ A}$$

## 1 Protection of feeders

If no harmonics are present, from Table 8, for a multi-core copper cable with PVC insulation, method of installation E, with three loaded conductors, a cross section with current carrying capacity of  $I_b \geq I'_b = 115 \text{ A}$ , is obtained. A 35 mm<sup>2</sup> cross section cable can carry, under Standard reference conditions, 126 A. The current carrying capacity, according to the actual conditions of installation, is still 126 A, since the value of factors  $k_1$  and  $k_2$  is 1.

The third harmonic content is assumed to be 28%.

Table 16 shows that for a third harmonic content of 28% the cable must be dimensioned for the current that flows through the phase conductors, but a reduction factor of 0.86 must be applied. The current  $I'_b$  becomes:

$$I'_b = \frac{I_b}{k_1 \cdot k_2 \cdot 0.86} = \frac{115}{0.86} = 133.7 \text{ A}$$

From Table 8, a 50 mm<sup>2</sup> cable with carrying capacity of 153 A shall be selected.

If the third harmonic content is 40 %, Table 17 shows that the cable shall be dimensioned according to the current of the neutral conductor and a reduction factor of 0.86 must be applied.

The current in the neutral conductor is:

$$I_N = \frac{I_b}{k_{\text{tot}}} \cdot 3 \cdot k_{\text{III}} = 115 \cdot 3 \cdot 0.4 = 138 \text{ A}$$

and the value of current  $I'_b$  is:

$$I'_b = \frac{I_N}{0.86} = \frac{138}{0.86} = 160.5 \text{ A}$$

From Table 8, a 70 mm<sup>2</sup> cable with 196 A current carrying capacity shall be selected.

If the third harmonic content is 60 %, Table 16 shows that the cable shall be dimensioned according to the current of the neutral conductor, but a reduction factor of 1 must be applied.

The current in the neutral conductor is:

$$I_N = \frac{I_b}{k_{\text{tot}}} \cdot 3 \cdot k_{\text{III}} = 115 \cdot 3 \cdot 0.6 = 207 \text{ A}$$

and current  $I'_b$  is:

$$I'_b = I_N = 207 \text{ A}$$

From Table 8, a 95 mm<sup>2</sup> cable with current carrying capacity of 238 A must be selected.

# 1 Protection of feeders

## 1.2.2 Voltage drop

In an electrical installation it is important to evaluate voltage drops from the point of supply to the load.

The performance of a device may be impaired if supplied with a voltage different from its rated voltage. For example:

- **motors:** the torque is proportional to the square of the supply voltage; therefore, if the voltage drops, the starting torque shall also decrease, making it more difficult to start up motors; the maximum torque shall also decrease;
- **incandescent lamps:** the more the voltage drops the weaker the beam becomes and the light takes on a reddish tone;
- **discharge lamps:** in general, they are not very sensitive to small variations in voltage, but in certain cases, great variation may cause them to switch off;
- **electronic appliances:** they are very sensitive to variations in voltage and that is why they are fitted with stabilizers;
- **electromechanical devices:** the reference Standard states that devices such as contactors and auxiliary releases have a minimum voltage below which their performances cannot be guaranteed. For a contactor, for example, the holding of the contacts becomes unreliable below 85% of the rated voltage.

To limit these problems the Standards set the following limits:

- IEC 60364-5-52 “*Electrical installations of buildings. Selection and erection of electrical equipment - Wiring systems*” Annex G states that the voltage drop between the origin of an installation and any load point should not be greater than the values in Table 18 expressed with respect to the value of the nominal voltage of the installation.

**Table 18: Voltage drop**

Type of installation	Lighting %	Other uses %
A – Low voltage installations supplied directly from a public low voltage distribution system	3	5
B – Low voltage installation supplied from private LV supply <sup>a</sup>	6	8

<sup>a</sup> As far as possible, it is recommended that voltage drop within the final circuits do not exceed those indicated in installation type A.

When the main wiring systems of the installations are longer than 100 m, these voltage drops may be increased by 0,005 % per metre of wiring system beyond 100 m, without this supplement being greater than 0,5 %.

Voltage drop is determined from the demand by the current-using equipment, applying diversity factors where applicable, or from the values of the design current of the circuits.

NOTE 1 A greater voltage drop may be accepted

- for motor during starting periods,
- for other equipment with high inrush current,

provided that in both cases it is ensured that the voltage variations remains within the limits specified in the relevant equipment standard.

NOTE 2 The following temporary conditions are excluded:

- voltage transients;
- voltage variation due to abnormal operation.

# 1 Protection of feeders

- IEC 60204-1 "Safety of machinery – Electrical equipment of machines – General requirements" Clause 13.5 recommends that: "the voltage drop from the point of supply to the load shall not exceed 5% of the rated voltage under normal operating conditions".
- IEC 60364-7-714 "Electrical installations of buildings - Requirements for special installations or locations - External lighting installations" Clause 714.512 requires that "the voltage drop in normal service shall be compatible with the conditions arising from the starting current of the lamps".

## Voltage drop calculation

For an electrical conductor with impedance  $Z$ , the voltage drop is calculated by the following formula:

$$\Delta U = kZI_b = kI_b \frac{L}{n} (r \cos \varphi + x \sin \varphi) \text{ [V]} \quad (1)$$

where

- $k$  is a coefficient equal to:
  - 2 for single-phase and two-phase systems;
  - $\sqrt{3}$  for three-phase systems;
- $I_b$  [A] is the load current; if no information are available, the cable carrying capacity  $I_z$  shall be considered;
- $L$  [km] is the length of the conductor;
- $n$  is the number of conductors in parallel per phase;
- $r$  [ $\Omega$ /km] is the resistance of the single cable per kilometre;
- $x$  [ $\Omega$ /km] is the reactance of the single cable per kilometre;
- $\cos \varphi$  is the power factor of the load:  $\sin \varphi = \sqrt{1 - \cos^2 \varphi}$ .

Normally, the percentage value in relation to the rated value  $U_r$  is calculated by:

$$\Delta u\% = \frac{\Delta U}{U_r} 100 \quad (2)$$

Resistance and reactance values per unit of length are set out on the following table by cross-sectional area and cable formation, for 50 Hz; in case of 60 Hz, the reactance value shall be multiplied by 1.2.

# 1 Protection of feeders

**Table 1: Resistance and reactance per unit of length of copper cables**

S [mm <sup>2</sup> ]	single-core cable		two-core/three-core cable	
	r[Ω/km]	x[Ω/km]	r[Ω/km]	x[Ω/km]
	@ 80 [°C]		@ 80 [°C]	
1.5	14.8	0.168	15.1	0.118
2.5	8.91	0.156	9.08	0.109
4	5.57	0.143	5.68	0.101
6	3.71	0.135	3.78	0.0955
10	2.24	0.119	2.27	0.0861
16	1.41	0.112	1.43	0.0817
25	0.889	0.106	0.907	0.0813
35	0.641	0.101	0.654	0.0783
50	0.473	0.101	0.483	0.0779
70	0.328	0.0965	0.334	0.0751
95	0.236	0.0975	0.241	0.0762
120	0.188	0.0939	0.191	0.074
150	0.153	0.0928	0.157	0.0745
185	0.123	0.0908	0.125	0.0742
240	0.0943	0.0902	0.0966	0.0752
300	0.0761	0.0895	0.078	0.075

**Table 2: Resistance and reactance per unit of length of aluminium cables**

S [mm <sup>2</sup> ]	single-core cable		two-core/three-core cable	
	r[Ω/km]	x[Ω/km]	r[Ω/km]	x[Ω/km]
	@ 80 [°C]		@ 80 [°C]	
1.5	24.384	0.168	24.878	0.118
2.5	14.680	0.156	14.960	0.109
4	9.177	0.143	9.358	0.101
6	6.112	0.135	6.228	0.0955
10	3.691	0.119	3.740	0.0861
16	2.323	0.112	2.356	0.0817
25	1.465	0.106	1.494	0.0813
35	1.056	0.101	1.077	0.0783
50	0.779	0.101	0.796	0.0779
70	0.540	0.0965	0.550	0.0751
95	0.389	0.0975	0.397	0.0762
120	0.310	0.0939	0.315	0.074
150	0.252	0.0928	0.259	0.0745
185	0.203	0.0908	0.206	0.0742
240	0.155	0.0902	0.159	0.0752
300	0.125	0.0895	0.129	0.075



# 1 Protection of feeders

The following tables show the  $\Delta U_x$  [V/(A.km)] values by cross section and formation of the cable according to the most common  $\cos\varphi$  values.

**Table 3: Specific voltage drop at  $\cos\varphi = 1$  for copper cables**

S[mm <sup>2</sup> ]	$\cos\varphi = 1$			
	single-core cable		two-core cable	three-core cable
	single-phase	three-phase	single-phase	three-phase
1.5	29.60	25.63	30.20	26.15
2.5	17.82	15.43	18.16	15.73
4	11.14	9.65	11.36	9.84
6	7.42	6.43	7.56	6.55
10	4.48	3.88	4.54	3.93
16	2.82	2.44	2.86	2.48
25	1.78	1.54	1.81	1.57
35	1.28	1.11	1.31	1.13
50	0.95	0.82	0.97	0.84
70	0.66	0.57	0.67	0.58
95	0.47	0.41	0.48	0.42
120	0.38	0.33	0.38	0.33
150	0.31	0.27	0.31	0.27
185	0.25	0.21	0.25	0.22
240	0.19	0.16	0.19	0.17
300	0.15	0.13	0.16	0.14

**Table 4: Specific voltage drop at  $\cos\varphi = 0.9$  for copper cables**

S[mm <sup>2</sup> ]	$\cos\varphi = 0.9$			
	single-core cable		two-core cable	three-core cable
	single-phase	three-phase	single-phase	three-phase
1.5	26.79	23.20	27.28	23.63
2.5	16.17	14.01	16.44	14.24
4	10.15	8.79	10.31	8.93
6	6.80	5.89	6.89	5.96
10	4.14	3.58	4.16	3.60
16	2.64	2.28	2.65	2.29
25	1.69	1.47	1.70	1.48
35	1.24	1.08	1.25	1.08
50	0.94	0.81	0.94	0.81
70	0.67	0.58	0.67	0.58
95	0.51	0.44	0.50	0.43
120	0.42	0.36	0.41	0.35
150	0.36	0.31	0.35	0.30
185	0.30	0.26	0.29	0.25
240	0.25	0.22	0.24	0.21
300	0.22	0.19	0.21	0.18

# 1 Protection of feeders

**Table 5: Specific voltage drop at  $\cos\varphi = 0.85$  for copper cables**

S[mm <sup>2</sup> ]	$\cos\varphi = 0.85$			
	single-core cable		two-core cable	three-core cable
	single-phase	three-phase	single-phase	three-phase
1.5	25.34	21.94	25.79	22.34
2.5	15.31	13.26	15.55	13.47
4	9.62	8.33	9.76	8.45
6	6.45	5.59	6.53	5.65
10	3.93	3.41	3.95	3.42
16	2.51	2.18	2.52	2.18
25	1.62	1.41	1.63	1.41
35	1.20	1.04	1.19	1.03
50	0.91	0.79	0.90	0.78
70	0.66	0.57	0.65	0.56
95	0.50	0.44	0.49	0.42
120	0.42	0.36	0.40	0.35
150	0.36	0.31	0.35	0.30
185	0.30	0.26	0.29	0.25
240	0.26	0.22	0.24	0.21
300	0.22	0.19	0.21	0.18

**Table 6: Specific voltage drop at  $\cos\varphi = 0.8$  for copper cables**

S[mm <sup>2</sup> ]	$\cos\varphi = 0.8$			
	single-core cable		two-core cable	three-core cable
	single-phase	three-phase	single-phase	three-phase
1.5	23.88	20.68	24.30	21.05
2.5	14.44	12.51	14.66	12.69
4	9.08	7.87	9.21	7.98
6	6.10	5.28	6.16	5.34
10	3.73	3.23	3.74	3.23
16	2.39	2.07	2.39	2.07
25	1.55	1.34	1.55	1.34
35	1.15	0.99	1.14	0.99
50	0.88	0.76	0.87	0.75
70	0.64	0.55	0.62	0.54
95	0.49	0.43	0.48	0.41
120	0.41	0.36	0.39	0.34
150	0.36	0.31	0.34	0.29
185	0.31	0.26	0.29	0.25
240	0.26	0.22	0.24	0.21
300	0.23	0.20	0.21	0.19

# 1 Protection of feeders

**Table 7: Specific voltage drop at  $\cos\varphi=0.75$  for copper cables**

S[mm <sup>2</sup> ]	cos $\varphi$ = 0.75			
	single-core cable		two-core cable	three-core cable
	single-phase	three-phase	single-phase	three-phase
1.5	22.42	19.42	22.81	19.75
2.5	13.57	11.75	13.76	11.92
4	8.54	7.40	8.65	7.49
6	5.74	4.97	5.80	5.02
10	3.52	3.05	3.52	3.05
16	2.26	1.96	2.25	1.95
25	1.47	1.28	1.47	1.27
35	1.10	0.95	1.08	0.94
50	0.84	0.73	0.83	0.72
70	0.62	0.54	0.60	0.52
95	0.48	0.42	0.46	0.40
120	0.41	0.35	0.38	0.33
150	0.35	0.31	0.33	0.29
185	0.30	0.26	0.29	0.25
240	0.26	0.23	0.24	0.21
300	0.23	0.20	0.22	0.19

**Table 8: Specific voltage drop at  $\cos\varphi = 1$  for aluminium cables**

S[mm <sup>2</sup> ]	cos $\varphi$ = 1			
	single-core cable		two-core cable	three-core cable
	single-phase	three-phase	single-phase	three-phase
1.5	48.77	42.23	49.76	43.09
2.5	29.36	25.43	29.92	25.91
4	18.35	15.89	18.72	16.21
6	12.22	10.59	12.46	10.79
10	7.38	6.39	7.48	6.48
16	4.65	4.02	4.71	4.08
25	2.93	2.54	2.99	2.59
35	2.11	1.83	2.15	1.87
50	1.56	1.35	1.59	1.38
70	1.08	0.94	1.10	0.95
95	0.78	0.67	0.79	0.69
120	0.62	0.54	0.63	0.55
150	0.50	0.44	0.52	0.45
185	0.41	0.35	0.41	0.36
240	0.31	0.27	0.32	0.28
300	0.25	0.22	0.26	0.22

# 1 Protection of feeders

**Table 9: Specific voltage drop at  $\cos\varphi = 0.9$  for aluminium cables**

S[mm <sup>2</sup> ]	$\cos\varphi = 0.9$			
	single-core cable		two-core cable	three-core cable
	single-phase	three-phase	single-phase	three-phase
1.5	44.04	38.14	44.88	38.87
2.5	26.56	23.00	27.02	23.40
4	16.64	14.41	16.93	14.66
6	11.12	9.63	11.29	9.78
10	6.75	5.84	6.81	5.89
16	4.28	3.71	4.31	3.73
25	2.73	2.36	2.76	2.39
35	1.99	1.72	2.01	1.74
50	1.49	1.29	1.50	1.30
70	1.06	0.92	1.06	0.91
95	0.78	0.68	0.78	0.68
120	0.64	0.55	0.63	0.55
150	0.53	0.46	0.53	0.46
185	0.44	0.38	0.44	0.38
240	0.36	0.31	0.35	0.30
300	0.30	0.26	0.30	0.26

**Table 10: Specific voltage drop at  $\cos\varphi = 0.85$  for aluminium cables**

S[mm <sup>2</sup> ]	$\cos\varphi = 0.85$			
	single-core cable		two-core cable	three-core cable
	single-phase	three-phase	single-phase	three-phase
1.5	41.63	36.05	42.42	36.73
2.5	25.12	21.75	25.55	22.12
4	15.75	13.64	16.02	13.87
6	10.53	9.12	10.69	9.26
10	6.40	5.54	6.45	5.58
16	4.07	3.52	4.09	3.54
25	2.60	2.25	2.63	2.27
35	1.90	1.65	1.91	1.66
50	1.43	1.24	1.43	1.24
70	1.02	0.88	1.01	0.88
95	0.76	0.66	0.76	0.65
120	0.63	0.54	0.61	0.53
150	0.53	0.46	0.52	0.45
185	0.44	0.38	0.43	0.37
240	0.36	0.31	0.35	0.30
300	0.31	0.27	0.30	0.26

# 1 Protection of feeders

**Table 11: Specific voltage drop at  $\cos\varphi = 0.8$  for aluminium cables**

S[mm <sup>2</sup> ]	$\cos\varphi = 0.8$			
	single-core cable		two-core cable	three-core cable
	single-phase	three-phase	single-phase	three-phase
1.5	39.22	33.96	39.95	34.59
2.5	23.67	20.50	24.07	20.84
4	14.85	12.86	15.09	13.07
6	9.94	8.61	10.08	8.73
10	6.05	5.24	6.09	5.27
16	3.85	3.34	3.87	3.35
25	2.47	2.14	2.49	2.16
35	1.81	1.57	1.82	1.57
50	1.37	1.18	1.37	1.18
70	0.98	0.85	0.97	0.84
95	0.74	0.64	0.73	0.63
120	0.61	0.53	0.59	0.51
150	0.51	0.45	0.50	0.44
185	0.43	0.38	0.42	0.36
240	0.36	0.31	0.34	0.30
300	0.31	0.27	0.30	0.26

**Table 12: Specific voltage drop at  $\cos\varphi = 0.75$  for aluminium cables**

S[mm <sup>2</sup> ]	$\cos\varphi = 0.75$			
	single-core cable		two-core cable	three-core cable
	single-phase	three-phase	single-phase	three-phase
1.5	36.80	31.87	37.47	32.45
2.5	22.23	19.25	22.58	19.56
4	13.95	12.08	14.17	12.27
6	9.35	8.09	9.47	8.20
10	5.69	4.93	5.72	4.96
16	3.63	3.15	3.64	3.15
25	2.34	2.02	2.35	2.03
35	1.72	1.49	1.72	1.49
50	1.30	1.13	1.30	1.12
70	0.94	0.81	0.92	0.80
95	0.71	0.62	0.70	0.60
120	0.59	0.51	0.57	0.49
150	0.50	0.43	0.49	0.42
185	0.42	0.37	0.41	0.35
240	0.35	0.31	0.34	0.29
300	0.31	0.27	0.29	0.25

# 1 Protection of feeders

## Example 1

To calculate a voltage drop on a three-phase cable with the following specifications:

- rated voltage: 400 V;
- cable length: 25 m;
- cable formation: single-core copper cable, 3x50 mm<sup>2</sup>;
- load current  $I_b$ : 100 A;
- power factor  $\cos\varphi$ : 0.9.

From Table 4, for a 50 mm<sup>2</sup> single-core cable it is possible to read that a  $\Delta U_x$  voltage drop corresponds to 0.81 V/(A·km). By multiplying this value by the length in km and by the current in A, it results:

$$\Delta U = \Delta U_x \cdot I_b \cdot L = 0.81 \cdot 100 \cdot 0.025 = 2.03 \text{ V}$$

which corresponds to this percentage value:

$$\Delta u\% = \frac{\Delta U}{U_r} \cdot 100 = \frac{2.03}{400} \cdot 100 = 0.51\%$$

## Example 2

To calculate a voltage drop on a three-phase cable with the following specifications:

- rated voltage: 690 V;
- cable length: 50 m;
- cable formation: multi-core copper cable, 2x(3x10) mm<sup>2</sup>;
- load current  $I_b$ : 50 A;
- power factor  $\cos\varphi$ : 0.85.

From Table 5, for a multi-core 10 mm<sup>2</sup> cable it is possible to read that  $\Delta U_x$  voltage drop corresponds to 3.42 V/(A·km). By multiplying this value by the length in km and by the current in A, and by dividing it by the number of cables in parallel, it results:

$$\Delta U = \Delta U_x \cdot I_b \cdot \frac{L}{2} = 3.42 \cdot 50 \cdot \frac{0.05}{2} = 4.28 \text{ V}$$

which corresponds to this percentage value:

$$\Delta u\% = \frac{\Delta U}{U_r} \cdot 100 = \frac{4.28}{690} \cdot 100 = 0.62\%$$

# 1 Protection of feeders

## Method for defining the cross section of the conductor according to voltage drop in the case of long cables

In the case of long cables, or if particular design specifications impose low limits for maximum voltage drops, the verification using as reference the cross section calculated on the basis of thermal considerations (calculation according to chapter 1.2.1 "Current carrying capacity and methods of installation") may have a negative result.

To define the correct cross section, the maximum  $\Delta U_{x_{\max}}$  value calculated by using the formula:

$$\Delta U_{x_{\max}} = \frac{\Delta u\% \cdot U_r}{100 \cdot I_b \cdot L} \quad (3)$$

is compared with the corresponding values on Tables 4÷12 by choosing the smallest cross section with a  $\Delta U_x$  value lower than  $\Delta U_{x_{\max}}$ .

### Example:

Supply of a three-phase load with  $P_u = 35 \text{ kW}$  ( $U_r = 400 \text{ V}$ ,  $f_r = 50 \text{ Hz}$ ,  $\cos\varphi = 0.9$ ) with a 140 m cable installed on a perforated tray, consisting of a multi-core copper cable with EPR insulation.

Maximum permitted voltage drop 2%.

Load current  $I_b$  is:

$$I_b = \frac{P_u}{\sqrt{3} \cdot U_r \cdot \cos\varphi} = \frac{35000}{\sqrt{3} \cdot 400 \cdot 0.9} = 56 \text{ A}$$

The Table 8 of Chapter 1.2.1 shows  $S = 10 \text{ mm}^2$ .

From Table 4, for the multi-core  $10 \text{ mm}^2$  cable it is possible to read that the voltage drop per A and per km is  $3.60 \text{ V}/(\text{A} \cdot \text{km})$ . By multiplying this value by the length in km and by the current in A, it results:

$$\Delta U = 3.60 \cdot I_b \cdot L = 3.6 \cdot 56 \cdot 0.14 = 28.2 \text{ V}$$

which corresponds to this percentage value:

$$\Delta u\% = \frac{\Delta U}{U_r} \cdot 100 = \frac{28.2}{400} \cdot 100 = 7.05\%$$

This value is too high.

Formula (3) shows:

$$\Delta U_{x_{\max}} = \frac{\Delta u\% \cdot U_r}{100 \cdot I_b \cdot L} = \frac{2\% \cdot 400}{100 \cdot 56 \cdot 0.14} = 1.02 \text{ V}/(\text{A} \cdot \text{km})$$

# 1 Protection of feeders

From Table 4 a cross section of 50 mm<sup>2</sup> can be chosen.

For this cross section  $\Delta U_x = 0.81 < 1.02 \text{ V}/(\text{A}\cdot\text{km})$ .

By using this value it results:

$$\Delta U = \Delta U_x \cdot I_b \cdot L = 0.81 \cdot 56 \cdot 0.14 = 6.35 \text{ V}$$

This corresponds to a percentage value of:

$$\Delta u \% = \frac{\Delta U}{U_r} \cdot 100 = \frac{6.35}{400} \cdot 100 = 1.6\%$$

## 1.2.3 Joule-effect losses

Joule-effect losses are due to the electrical resistance of the cable.

The lost energy is dissipated in heat and contributes to the heating of the conductor and of the environment.

A first estimate of three-phase losses is:

$$P_j = \frac{3 \cdot r \cdot I_b^2 \cdot L}{1000} \text{ [W]}$$

whereas single-phase losses are:

$$P_j = \frac{2 \cdot r \cdot I_b^2 \cdot L}{1000} \text{ [W]}$$

where:

- $I_b$  is the load current [A];
- $r$  is the phase resistance per unit of length of the cable at 80 °C [ $\Omega/\text{km}$ ] (see Table 1);
- $L$  is the cable length [m].

**Table 1: Resistance values [ $\Omega/\text{km}$ ] of single-core and multi-core cables in copper and aluminium at 80 °C**

S [mm <sup>2</sup> ]	Single-core cable		Two-core/three-core cable	
	Cu	Al	Cu	Al
1.5	14.8	24.384	15.1	24.878
2.5	8.91	14.680	9.08	14.960
4	5.57	9.177	5.68	9.358
6	3.71	6.112	3.78	6.228
10	2.24	3.691	2.27	3.740
16	1.41	2.323	1.43	2.356
25	0.889	1.465	0.907	1.494
35	0.641	1.056	0.654	1.077
50	0.473	0.779	0.483	0.796
70	0.328	0.540	0.334	0.550
95	0.236	0.389	0.241	0.397
120	0.188	0.310	0.191	0.315
150	0.153	0.252	0.157	0.259
185	0.123	0.203	0.125	0.206
240	0.0943	0.155	0.0966	0.159
300	0.0761	0.125	0.078	0.129



# 1 Protection of feeders

## 1.3 Protection against overload

The Standard IEC 60364-4-43 “*Electrical installation of buildings - Protection against overcurrent*” specifies coordination between conductors and overload protective devices (normally placed at the beginning of the conductor to be protected) so that it shall satisfy the two following conditions:

$$I_b \leq I_n \leq I_z \quad (1)$$

$$I_2 \leq 1.45 \cdot I_z \quad (2)$$

Where:

- $I_b$  is the current for which the circuit is dimensioned;
- $I_z$  is the continuous current carrying capacity of the cable;
- $I_n$  is the rated current of the protective device; for adjustable protective releases, the rated current  $I_n$  is the set current;
- $I_2$  is the current ensuring effective operation in the conventional time of the protective device.

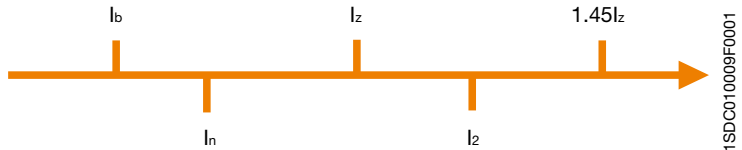

According to condition (1) to correctly choose the protective device, it is necessary to check that the circuit-breaker has a rated (or set) current that is:

- higher than the load current, to prevent unwanted tripping;
- lower than the current carrying capacity of the cable, to prevent cable overload.

The Standard allows an overload current that may be up to 45% greater than the current carrying capacity of the cable but only for a limited period.

The verification of condition (2) is not necessary in the case of circuit-breakers because the protective device is automatically tripped if:

- $I_2 = 1.3 \cdot I_n$  for circuit-breakers complying with IEC 60947-2 (circuit-breakers for industrial use);
- $I_2 = 1.45 \cdot I_n$  for circuit-breakers complying with IEC 60898 (circuit-breakers for household and similar installations).

Therefore, for circuit-breakers, if  $I_n \leq I_z$ , the formula  $I_2 \leq 1.45 \cdot I_z$  will also be verified.

When the protective device is a fuse, it is also essential to check formula (2) because IEC 60269-2-1 on “*Low-voltage fuses*” states that a  $1.6 \cdot I_n$  current must automatically melt the fuse. In this case, formula (2) becomes  $1.6 \cdot I_n \leq 1.45 \cdot I_z$  or  $I_n \leq 0.9 \cdot I_z$ .

# 1 Protection of feeders

**To summarize:** to carry out by a fuse protection against overload, the following must be achieved:

$$I_b \leq I_n \leq 0.9 \cdot I_z$$

and this means that the cable is not fully exploited.

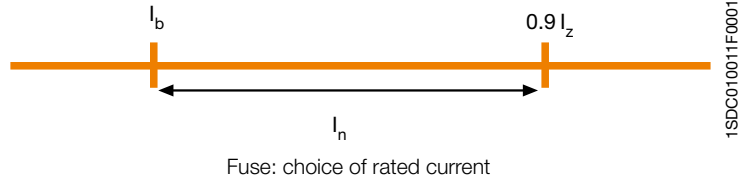
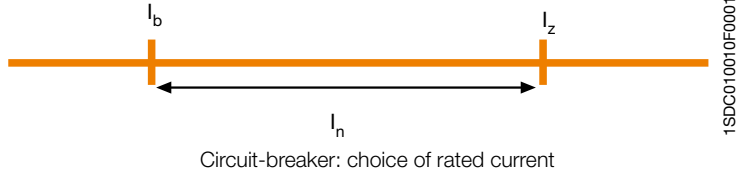

Where the use of a single conductor per phase is not feasible, and the currents in the parallel conductors are unequal, the design current and requirements for overload protection for each conductor shall be considered individually.

## Examples

### Example 1

*Load specifications*

$P_r = 120 \text{ kW}$ ;  $U_r = 400 \text{ V}$ ;  $\cos \varphi = 0.9$ ; three-phase load so  $I_b = 192.6 \text{ A}$

*Cable specifications*

$I_z = 239 \text{ A}$

*Protective device specifications*

XT3N 250 TMD  $I_n 200$ ; set current  $I_1 = 1 \times I_n = 200 \text{ A}$

# 1 Protection of feeders

## Example 2

*Load specifications*

$P_r = 70 \text{ kW}$ ;  $\cos\varphi = 0.9$ ;  $U_r = 400 \text{ V}$ ; three-phase load so  $I_b = 112 \text{ A}$

*Cable specifications*

$I_z = 134 \text{ A}$

*Protective device specifications*

XT2N 160 Ekip LSI  $I_n 160$ ; set current  $I1 = 0.8 \times I_n = 128 \text{ A}$

## Example 3

*Load specifications*

$P_r = 100 \text{ kW}$ ;  $\cos\varphi = 0.9$ ;  $U_r = 400 \text{ V}$ ; three-phase load so  $I_b = 160 \text{ A}$

*Cable specifications*

$I_z = 190 \text{ A}$

*Protective device specifications*

XT3N 250 TMD  $I_n 200$ ; set current  $I1 = 0.9 \times I_n = 180 \text{ A}$

## Example 4

*Load specifications*

$P_r = 50 \text{ kW}$ ;  $\cos\varphi = 0.9$ ;  $U_r = 230 \text{ V}$ ; single-phase load so  $I_b = 241 \text{ A}$

*Cable specifications*

$I_z = 262 \text{ A}$

*Protective device specifications*

XT4N 250 Ekip LSI  $I_n 250$ ; set current  $I1 = 0.98 \times I_n = 245 \text{ A}$

# 1 Protection of feeders

## 1.4 Protection against short-circuit

A cable is protected against short-circuit if the specific let-through energy of the protective device ( $I^2t$ ) is lower or equal to the withstood energy of the cable ( $k^2S^2$ ):

$$I^2t \leq k^2S^2 \quad (1)$$

where

- $I^2t$  is the specific let-through energy of the protective device which can be read on the curves supplied by the manufacturer (see Part 1, Chapter 2.4 “Specific let-through energy curves”) or from a direct calculation in the case of devices that are not limiting and delaying;
- $S$  is the cable cross section [ $\text{mm}^2$ ]; in the case of conductors in parallel it is the cross section of the single conductor;
- $k$  is a factor that depends on the cable insulating and conducting material. The values of the most common installations are shown in Table 1; for a more detailed calculation, see Annex C.

**Table 1: Values of k for phase conductor**

	Conductor insulation					
	PVC $\leq 300 \text{ mm}^2$	PVC $> 300 \text{ mm}^2$	EPR XLPE	Rubber 60 °C	Mineral	
					PVC	Bare
<b>Initial temperature °C</b>	70	70	90	60	70	105
<b>Final temperature °C</b>	160	140	250	200	160	250
<b>Material of conductor:</b>						
<b>Copper</b>	115	103	143	141	115	135/115 <sup>a</sup>
<b>Aluminium</b>	76	68	94	93	-	-
<b>tin-soldered joints in copper conductors</b>	115	-	-	-	-	-

<sup>a</sup> This value shall be used for bare cables exposed to touch.

NOTE 1 Other values of k are under consideration for:

- small conductors (particularly for cross section less than  $10 \text{ mm}^2$ );
- duration of short-circuit exceeding 5 s;
- other types of joints in conductors;
- bare conductors.

NOTE 2 The nominal current of the short-circuit protective device may be greater than the current carrying capacity of the cable.

NOTE 3 The above factors are based on IEC 60724.

1SDC010010F0201

# 1 Protection of feeders

Table 2 shows the maximum withstood energy for cables according to the cross section, the conductor material and the type of insulation, which are calculated by using the parameters of Table 1.

**Table 2: Maximum withstood energy for cables  $k^2 S^2$  [(kA)<sup>2</sup> s]**

		Cross section [mm <sup>2</sup> ]								
Cable		k	1.5	2.5	4	6	10	16	25	35
PVC	Cu	115	$2.98 \cdot 10^{-2}$	$8.27 \cdot 10^{-2}$	$2.12 \cdot 10^{-1}$	$4.76 \cdot 10^{-1}$	1.32	3.39	8.27	$1.62 \cdot 10^1$
	Al	76	$1.30 \cdot 10^{-2}$	$3.61 \cdot 10^{-2}$	$9.24 \cdot 10^{-2}$	$2.08 \cdot 10^{-1}$	$5.78 \cdot 10^{-1}$	1.48	3.61	7.08
EPR/XLPE	Cu	143	$4.60 \cdot 10^{-2}$	$1.28 \cdot 10^{-1}$	$3.27 \cdot 10^{-1}$	$7.36 \cdot 10^{-1}$	2.04	5.23	$1.28 \cdot 10^1$	$2.51 \cdot 10^1$
	Al	94	$1.99 \cdot 10^{-2}$	$5.52 \cdot 10^{-2}$	$1.41 \cdot 10^{-1}$	$3.18 \cdot 10^{-1}$	$8.84 \cdot 10^{-1}$	2.26	5.52	$1.08 \cdot 10^1$
Rubber	Cu	141	$4.47 \cdot 10^{-2}$	$1.24 \cdot 10^{-1}$	$3.18 \cdot 10^{-1}$	$7.16 \cdot 10^{-1}$	1.99	5.09	$1.24 \cdot 10^1$	$2.44 \cdot 10^1$
	Al	93	$1.95 \cdot 10^{-2}$	$5.41 \cdot 10^{-2}$	$1.38 \cdot 10^{-1}$	$3.11 \cdot 10^{-1}$	$8.65 \cdot 10^{-1}$	2.21	5.41	$1.06 \cdot 10^1$

		Cross section [mm <sup>2</sup> ]								
Cable		k	50	70	95	120	150	185	240	300
PVC	Cu	115	$3.31 \cdot 10^1$	$6.48 \cdot 10^1$	$1.19 \cdot 10^2$	$1.90 \cdot 10^2$	$2.98 \cdot 10^2$	$4.53 \cdot 10^2$	$7.62 \cdot 10^2$	$1.19 \cdot 10^3$
	Al	76	$1.44 \cdot 10^1$	$2.83 \cdot 10^1$	$5.21 \cdot 10^1$	$8.32 \cdot 10^1$	$1.30 \cdot 10^2$	$1.98 \cdot 10^2$	$3.33 \cdot 10^2$	$5.20 \cdot 10^2$
EPR/XLPE	Cu	143	$5.11 \cdot 10^1$	$1.00 \cdot 10^2$	$1.85 \cdot 10^2$	$2.94 \cdot 10^2$	$4.60 \cdot 10^2$	$7.00 \cdot 10^2$	$1.18 \cdot 10^3$	$1.84 \cdot 10^3$
	Al	94	$2.21 \cdot 10^1$	$4.33 \cdot 10^1$	$7.97 \cdot 10^1$	$1.27 \cdot 10^2$	$1.99 \cdot 10^2$	$3.02 \cdot 10^2$	$5.09 \cdot 10^2$	$7.95 \cdot 10^2$
G2	Cu	141	$4.97 \cdot 10^1$	$9.74 \cdot 10^1$	$1.79 \cdot 10^2$	$2.86 \cdot 10^2$	$4.47 \cdot 10^2$	$6.80 \cdot 10^2$	$1.15 \cdot 10^3$	$1.79 \cdot 10^3$
	Al	93	$2.16 \cdot 10^1$	$4.24 \cdot 10^1$	$7.81 \cdot 10^1$	$1.25 \cdot 10^2$	$1.95 \cdot 10^2$	$2.96 \cdot 10^2$	$4.98 \cdot 10^2$	$7.78 \cdot 10^2$

The formula (1) must be verified along the whole length of the cable. Due to the shape of the specific let-through energy curve of a circuit breaker, it is generally sufficient to verify formula (1) only for the maximum and minimum short-circuit current that may affect the cable. The maximum value is normally the value of the three-phase short-circuit current at the beginning of the line, while the minimum value is the value of the phase to neutral short-circuit current (phase to phase if the neutral conductor is not distributed) or phase to earth at the end of the cable.

# 1 Protection of feeders

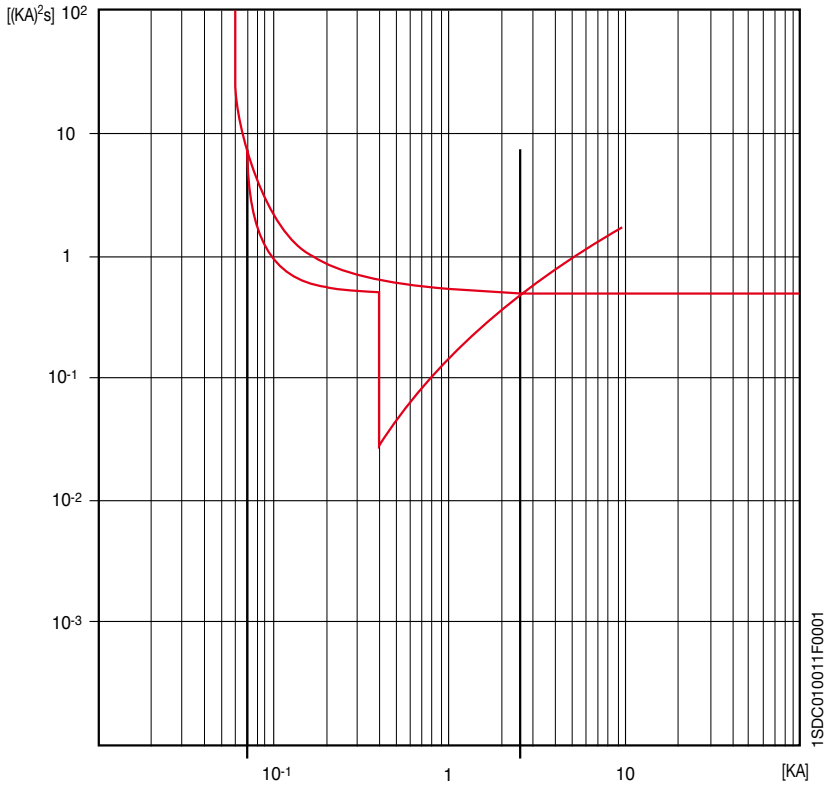

This verification can be simplified by comparing only the let-through energy value of the circuit-breaker at the maximum short-circuit current with the withstood energy of the cable and by ensuring that the circuit breaker trips instantaneously at the minimum short-circuit current: the threshold of the short-circuit protection (taking into consideration also the tolerances) shall therefore be lower than the minimum short-circuit current at the end of the conductor.

# 1 Protection of feeders

## Calculation of short-circuit current at end of the conductor

Minimum short-circuit current can be calculated by the following approximate formulas:

$$I_{kmin} = \frac{0.8 \cdot U_r \cdot k_{sec} \cdot k_{par}}{1.5 \cdot \rho \cdot \frac{2L}{S}} \quad \text{with non-distributed neutral conductor} \quad (2.1)$$

$$I_{kmin} = \frac{0.8 \cdot U_0 \cdot k_{sec} \cdot k_{par}}{1.5 \cdot \rho \cdot (1+m) \cdot \frac{L}{S}} \quad \text{with distributed neutral conductor} \quad (2.2)$$

where:

- $I_{kmin}$  is the minimum value of the prospective short-circuit current [kA];
- $U_r$  is the supply voltage [V];
- $U_0$  is the phase to earth supply voltage [V];
- $\rho$  is the resistivity at 20 °C of the material of the conductors in  $\Omega\text{mm}^2/\text{m}$  and is:
  - 0.018 for copper;
  - 0.027 for aluminium;
- $L$  is the length of the protected conductor [m];
- $S$  is the cross section of the conductor [ $\text{mm}^2$ ];
- $k_{sec}$  is the correction factor which takes into account the reactance of the cables with cross section larger than 95  $\text{mm}^2$ :

$S[\text{mm}^2]$	120	150	185	240	300
$k_{sec}$	0.9	0.85	0.80	0.75	0.72

# 1 Protection of feeders

- $k_{par}$  is the correcting coefficient for conductors in parallel:

number of parallel conductors	2	3	4	5
$k_{par}^*$	2	2.7	3	3.2

\* $k_{par} = 4(n-1)/n$  where:  $n$  = number of conductors in parallel per phase

- $m$  is the ratio between the resistances of the neutral conductor and the phase conductor (if they are made of the same material  $m$  is the ratio between the cross section of the phase conductor and the cross section of the neutral conductor).

After calculating the minimum short-circuit current, verify that

$$I_{kmin} > 1.2 \cdot I_3 \quad (3)$$

where:

- $I_3$  is the current that trips the magnetic protection of the circuit-breaker;
- 1.2 is the tolerance at the trip threshold.

## Example

Choice of CB1

System data:  
Rated voltage 415 V  
 $I_k = 30$  kA

Cable data:  
Insulated copper conductor in PVC  
Length = 150 m  
 $S = 50$  mm<sup>2</sup>  
 $I_z = 134$  A

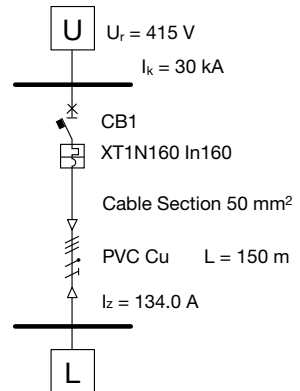

1SDC010011F0201



# 1 Protection of feeders

*Protection against short-circuit at the beginning of the conductor*

XT1N 160 In160 (breaking capacity 36 kA@415 V)

$I^2t$  (@30 kA) =  $7.5 \cdot 10^{-1}$  (kA)<sup>2</sup>s

$k^2S^2 = 115^2 \cdot 50^2 = 3.31 \cdot 10^1$  (kA)<sup>2</sup>s

The cable is therefore protected against short-circuit at the beginning of the conductor.

*Protection against short-circuit at end of the conductor*

The minimum short-circuit current at end of the conductor ( $k_{\text{sec}}=1$  and  $k_{\text{par}}=1$ ) is:

$$I_{\text{kmin}} = \frac{0.8 \cdot U \cdot k_{\text{sec}} \cdot k_{\text{par}}}{1.5 \cdot \rho \cdot \frac{2L}{S}} = 1.98 \text{ kA}$$

The magnetic threshold of the circuit breaker XT1N 160 In160 is set at 1600 A. If tolerance is 20%, the circuit breaker shall definitely trip if the values exceed 1920 A; the cable is therefore fully protected against short-circuit.

## Maximum protected length

The formula (3), when solved for the length, enables the maximum length protected by the protective device to be obtained for a precise instantaneous trip threshold. In Table 3, the maximum protected length can be identified for a given cross section of the cable and for the setting threshold of the instantaneous protection of the circuit breaker against short-circuit:

- three-phase system, 400 V rated voltage;
- non-distributed neutral;
- copper conductor with resistivity equal to  $0.018 \text{ } \Omega\text{mm}^2/\text{m}$ .

The values on the table below take into account the 20% tolerance coefficient for the magnetic trip value, the increase in cable resistivity due to heating caused by the short-circuit current and the reduction of voltage due to the fault.

The correction factors shown after the table must be applied if the system conditions are different from the reference conditions.

# 1 Protection of feeders

**Table 3: Maximum protected length**

$I_s$ [A]	section [mm <sup>2</sup> ]		4	6	10	16	25	35	50	70	95	120	150	185	240	300	
	1.5	2.5															
20	370	617															
30	246	412	658														
40	185	309	494	741													
50	148	247	395	593													
60	123	206	329	494													
70	105	176	282	423	705												
80	92	154	246	370	617												
90	82	137	219	329	549												
100	74	123	197	296	494	790											
120	61	102	164	246	412	658											
140	52	88	141	211	353	564											
150	49	82	131	197	329	527											
160	46	77	123	185	309	494	772										
180	41	68	109	164	274	439	686										
200	37	61	98	148	247	395	617										
220	33	56	89	134	224	359	561	786									
250	29	49	79	118	198	316	494	691									
280	26	44	70	105	176	282	441	617									
300	24	41	65	98	165	263	412	576									
320	23	38	61	92	154	247	386	540	772								
350	21	35	56	84	141	226	353	494	705								
380	19	32	52	78	130	208	325	455	650								
400	18	30	49	74	123	198	309	432	617								
420	17	29	47	70	118	188	294	412	588								
450	16	27	43	65	110	176	274	384	549	768							
480	15	25	41	61	103	165	257	360	514	720							
500	14	24	39	59	99	158	247	346	494	691							
520	14	23	38	57	95	152	237	332	475	665							
550	13	22	35	53	90	144	224	314	449	629							
580	12	21	34	51	85	136	213	298	426	596	809						
600	12	20	32	49	82	132	206	288	412	576	782						
620	11	19	31	47	80	127	199	279	398	558	757						
650	11	19	30	45	76	122	190	266	380	532	722						
680	10	18	29	43	73	116	182	254	363	508	690						
700	10	17	28	42	71	113	176	247	353	494	670	847					
750	16	26	39	66	105	165	230	329	461	626	790	840					
800	15	24	37	62	99	154	216	309	432	586	667	787					
850	14	23	34	58	93	145	203	290	407	552	627	741					
900	13	21	32	55	88	137	192	274	384	521	593	700					
950	13	20	31	52	83	130	182	260	364	494	561	663					
1000	12	19	29	49	79	123	173	247	346	469	533	630	731				
1250	15	23	40	63	99	138	198	277	375	427	504	585	711				
1500	13	19	33	53	82	115	165	230	313	356	420	487	593				
1600	12	18	31	49	77	108	154	216	293	333	394	457	556	667			
2000	14	25	40	62	86	123	173	235	267	315	365	444	533				
2500	11	20	32	49	69	99	138	188	213	252	292	356	427				
3000		16	26	41	58	82	115	156	178	210	244	296	356				
3200		15	25	39	54	77	108	147	167	197	228	278	333				
4000		12	20	31	43	62	86	117	133	157	183	222	267				
5000		10	16	25	35	49	69	94	107	126	146	178	213				
6300			13	20	27	39	55	74	85	100	116	141	169				
8000			10	15	22	31	43	59	67	79	91	111	133				
9600				13	18	26	36	49	56	66	76	93	111				
10000				12	17	25	35	47	53	63	73	89	107				
12000				10	14	21	29	39	44	52	61	74	89				
15000					12	16	23	31	36	42	49	59	71				
20000						12	17	23	27	31	37	44	53				
24000						10	14	20	22	26	30	37	44				
30000								12	16	20	25	30	40	49			

# 1 Protection of feeders

Correction factor for voltage other than 400 V:  $k_v$

Multiply the length value obtained from the table by the correction factor  $k_v$ :

$U_r$ [V] (three-phase value)	$k_v$
230 <sup>(1)</sup>	0.58
400	1
440	1.1
500	1.25
690	1.73

<sup>(1)</sup> 230 V single-phase is the equivalent of a three-phase 400 V system with distributed neutral and with the cross section of the phase conductor the same as the cross section area of the neutral conductor, so that  $k_v$  is 0.58.

Correction factor for distributed neutral:  $k_d$

Multiply the length value obtained from the table by the correction factor  $k_d$ :

$$k_d = \frac{2}{\sqrt{3}} \cdot \frac{1}{1 + \frac{S}{S_N}}$$

where

- $S$  is the phase cross section [mm<sup>2</sup>];
- $S_N$  is the neutral cross section [mm<sup>2</sup>].

In particular:

$$\text{if } S = S_N \rightarrow k_d \text{ is } 0.58;$$

$$\text{if } S = 2 \cdot S_N \rightarrow k_d \text{ is } 0.39.$$

Correction factor for aluminium conductors:  $k_f$

If the cable is in aluminium, multiply the length value obtained from the table above by the correction factor  $k_f = 0.67$ .

# 1 Protection of feeders

## To summarize:

On the table, for the cross section and magnetic trip threshold it is possible to read a maximum protected value  $L_0$ . This length shall then be multiplied, if necessary, by the correction factors in order to obtain a value that is compatible with the installation operating conditions:

$$L = L_0 k_v k_d k_r$$

### Example 1

Neutral not distributed

Rated voltage = 400 V

Protective device: XT2N 160 TMA In100

Magnetic threshold:  $I_3 = 1000$  A (max setting)

Phase cross section = Neutral cross section =  $70 \text{ mm}^2$

The table shows that at  $I_3 = 1000$  A, the  $70 \text{ mm}^2$  cable is protected up to 346 m.

### Example 2

Neutral distributed

Rated voltage = 400 V

Protective device: XT4N 250 TMA In200

Magnetic threshold:  $I_3 = 2000$  A (max setting)

Phase cross section =  $300 \text{ mm}^2$

Neutral cross section =  $150 \text{ mm}^2$

For  $I_3 = 2000$  A and  $S = 300 \text{ mm}^2$ , a protected length equivalent of  $L_0 = 533$  m is obtained.

By applying the correction factor  $k_d$  required when the neutral is distributed:

$$k_d = \frac{2}{\sqrt{3}} \cdot \frac{1}{1 + \frac{S}{S_N}} = \frac{2}{\sqrt{3}} \cdot \frac{1}{1 + \frac{300}{150}} = 0.39$$

$$L = L_0 \cdot 0.39 = 533 \cdot 0.39 = 207.9 \text{ m}$$

This is the maximum protected length with neutral distributed.

# 1 Protection of feeders

## 1.5 Neutral and protective conductors

### Neutral conductor

The neutral conductor is a conductor that is connected to the system neutral point (which generally but not necessarily coincides with the star centre of the secondary windings of the transformer or the windings of the generator); it is able to contribute to the transmission of electric power, thereby making available a voltage that is different from the phase to phase voltage. In certain cases and under specific conditions, the functions of neutral conductor and protective conductor can be combined in a single conductor (PEN).

### Protection and disconnection of the neutral conductor

If fault conditions arise, a voltage to earth may occur on the neutral conductor. This may be caused by a phase to neutral short-circuit and by the disconnection of the neutral conductor due to accidental breaking or to tripping of single-pole devices (fuses or single-pole circuit breakers).

If the neutral conductor only is disconnected in a four-conductor circuit, the supply voltage to the single-phase loads may be altered so that they are supplied by a voltage different from the  $U_0$  phase to neutral voltage (as shown in Fig. 1). Therefore, all the necessary measures to prevent this type of fault shall be taken, e.g. by not protecting the neutral conductor with single-pole devices.

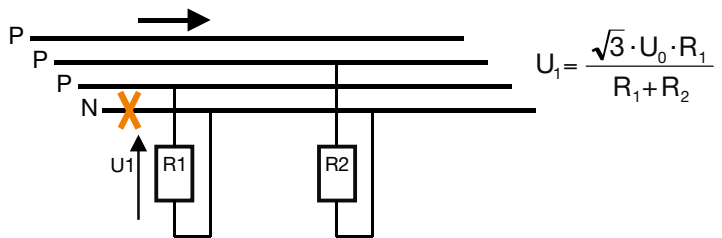

**Figure 1: Disconnection of the neutral conductor**

Moreover, in TN-C systems, voltage to earth arising on the neutral conductor constitutes a hazard for people; in fact, since this conductor is also a protective conductor, this voltage reaches the connected exposed conductive parts. For TN-C systems, the Standards specify minimum cross sections (see next clause) for the neutral conductor in order to prevent accidental breaking and they forbid the use of any device (single-pole or multi-pole) that could disconnect the PEN.

The need for protection on the neutral conductor and the possibility of disconnecting the circuit depend on the distribution system:

# 1 Protection of feeders

*TT or TN systems:*

- if the cross section of the neutral conductor is the same or larger than the cross section of the phase conductor, there is neither the need to detect overcurrents on the neutral conductor nor to use a breaking device (neutral conductor is not protected or disconnected); this requirement applies only if there are no harmonics that may, at any instant, cause r.m.s. current values on the neutral conductor higher than the maximum current detected on the phase conductors;
- if the cross section of the neutral conductor is less than the cross section of the phase conductor, overcurrents on the neutral conductor must be detected so as to have the phase conductors, but not necessarily the neutral conductor, disconnected (neutral conductor protected but not disconnected): in this case the overcurrents on the neutral conductor do not need to be detected if the following conditions are simultaneously fulfilled:
  1. the neutral conductor is protected against short-circuit by the protective device of the phase conductors;
  2. the maximum current that can flow through the neutral conductor during normal service is lower than the neutral current carrying capacity.

In TN-S systems, the neutral need not be disconnected if the supply conditions are such that the neutral conductor can be considered to be reliable at earth potential.

As already mentioned, in TN-C systems, the neutral conductor is also a protective conductor and cannot therefore be disconnected. Furthermore, if the neutral conductor is disconnected, the exposed conductive parts of the single-phase equipment could take the system rated voltage to earth.

In certain specific cases, the neutral conductor has to be disconnected to prevent currents circulating between parallel supply sources (see Figures 2 and 3).

**Figure 2: Three-phase alternative power supply with a 4-pole switch**

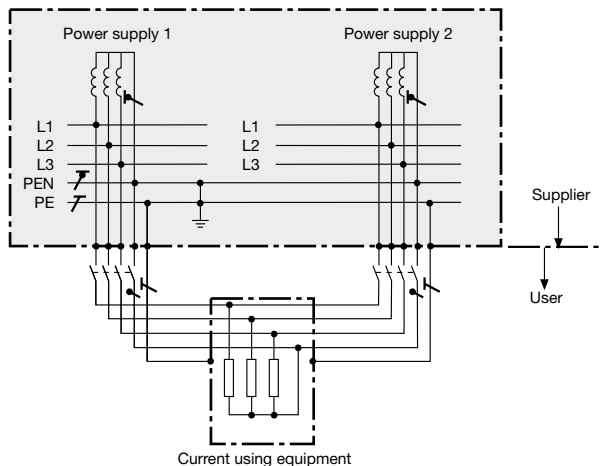

NOTE - This method prevents electromagnetic fields due to stray currents in the main supply system of an installation. The sum of the currents within one cable must be zero. This ensures that the neutral current will flow only in the neutral conductor of the respective switched on circuit. The 3rd harmonic (150 Hz) current of the line conductors will be added with the same phase angle to the neutral conductor current.

# 1 Protection of feeders

**Figure 3: Three-phase alternative power supply with non-suitable 3-pole switch**

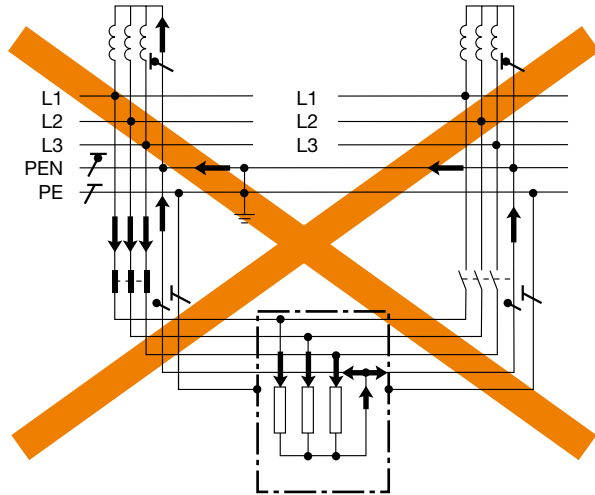

NOTE – A three-phase alternative power supply with a non-suitable 3-pole switch, due to unintentional circular stray currents generating electromagnetic fields.

1SDC010014F0001

## *IT system:*

The Standard advises against distributing the neutral conductor in IT systems. If the neutral conductor is distributed, the overcurrents must be detected on the neutral conductor of each circuit in order to disconnect all the live conductors on the corresponding circuit, including the neutral one (neutral conductor protected and disconnected).

Overcurrents do not need to be detected on the neutral conductor in any of the following cases:

- the neutral conductor is protected against short-circuit by a protective device fitted upstream;
- the circuit is protected by a residual current device with rated residual current lower than 0.15 times the current carrying capacity of the corresponding neutral conductor. This device must disconnect all the live conductors, the neutral conductor included.

For all distribution systems, whenever necessary, connection and disconnection of the neutral conductor, shall ensure that:

- the neutral conductor is not disconnected before the phase conductor;
- the neutral conductor is connected at the same moment or before the phase conductor.

# 1 Protection of feeders

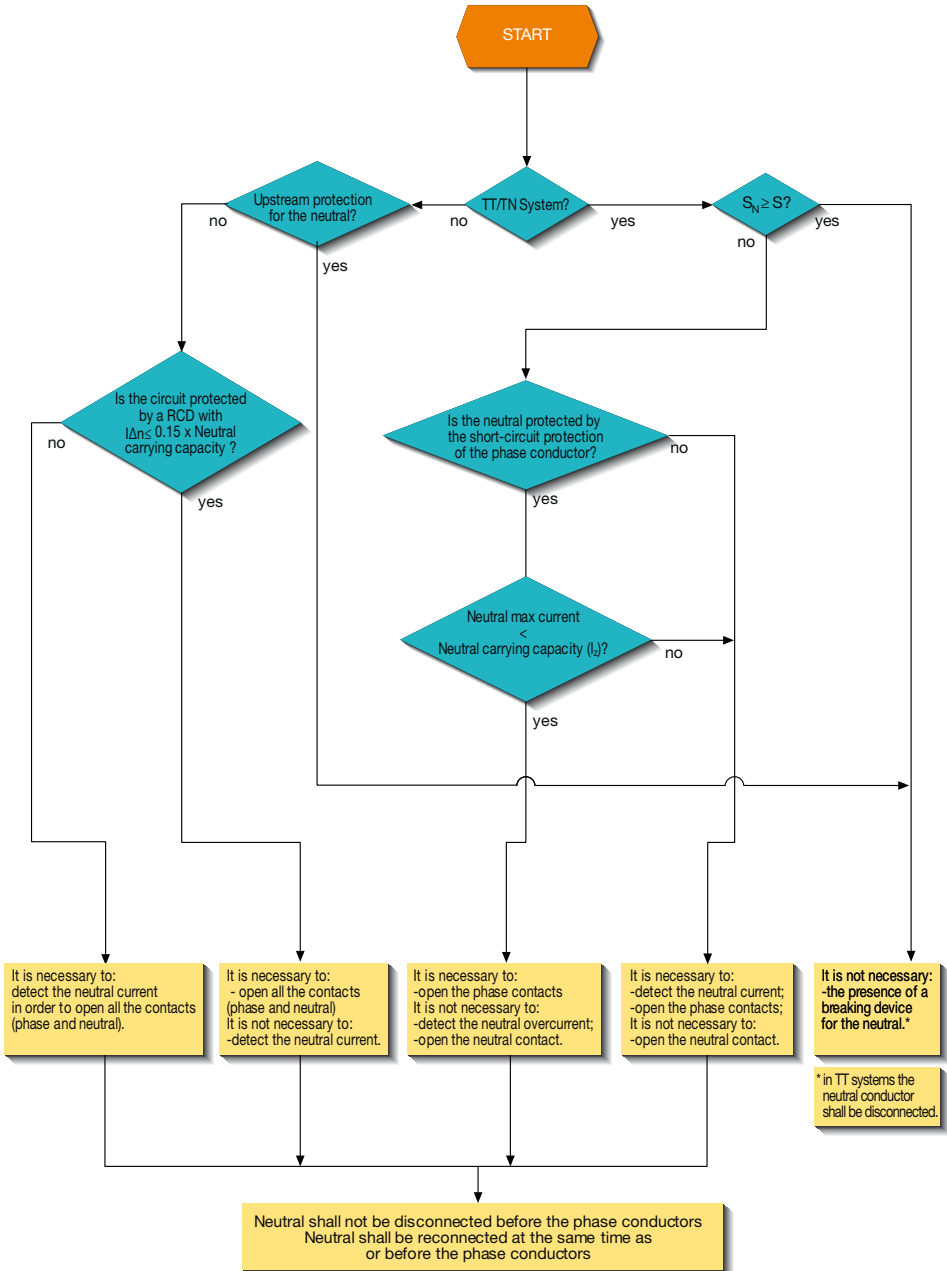

1SDC010013F0201

\* in TT systems the neutral conductor shall be disconnected.



# 1 Protection of feeders

## Determination of the minimum cross section of the neutral conductor

The neutral conductor, if any, shall have the same cross section as the line conductor:

- in single-phase, two-wire circuits whatever the section;
- in polyphase and single-phase three-wire circuits, when the size of the line conductors is less than or equal to 16 mm<sup>2</sup> in copper, or 25 mm<sup>2</sup> in aluminium.<sup>1</sup>

The cross section of the neutral conductor can be less than the cross section of the phase conductor when the cross section of the phase conductor is greater than 16 mm<sup>2</sup> with a copper cable, or 25 mm<sup>2</sup> with an aluminium cable, if both the following conditions are met:

- the cross section of the neutral conductor is at least 16 mm<sup>2</sup> for copper conductors and 25 mm<sup>2</sup> for aluminium conductors;
- there is no high harmonic distortion of the load current. If there is high harmonic distortion (the harmonic content is greater than 10%), as for example in equipment with discharge lamps, the cross section of the neutral conductor cannot be less than the cross section of the phase conductors.

**Table 1: Minimum cross sections of the neutral conductor**

	Phase cross section S [mm <sup>2</sup> ]	Min. neutral cross section S <sub>N</sub> [mm <sup>2</sup> ]
<b>Single-phase/two-phase circuits</b>		
Cu/Al	Any	S*
<b>Three-phase circuits</b>		
Cu	S ≤ 16	S*
	S > 16	16
<b>Three-phase circuits</b>		
Al	S ≤ 25	S*
	S > 25	25

\*for TN-C systems, the Standards specify a minimum cross section of 10 mm<sup>2</sup> for copper and 16 mm<sup>2</sup> for aluminium conductors

<sup>1</sup> The cross section of phase conductors shall be dimensioned in compliance with the instructions of the Chapter 1.2.1 "Current carrying capacity and methods of installation"

# 1 Protection of feeders

## Protective conductor

### Determination of the minimum cross sections

The minimum cross section of the protective conductor can be determined by using the following table:

**Table 2: Cross section of the protective conductor**

Cross section of line conductor S [mm <sup>2</sup> ]	Minimum cross section of the corresponding protective conductor [mm <sup>2</sup> ]	
	If the protective conductor is of the same material as the line conductor	If the protective conductor is not of the same material as the line conductor
S " 16	S	$\frac{k_1}{k_2} \cdot S$
16 < S " 35	16*	$\frac{k_1}{k_2} \cdot 16$
S > 35	$\frac{S^*}{2}$	$\frac{k_1}{k_2} \cdot \frac{S}{2}$
Where k <sub>1</sub> is the value of k for the line conductor, selected from Table 1 Chapter 1.4 according to the materials of the conductor and insulation; k <sub>2</sub> is the value of k for the protective conductor. * For a PEN conductor, the reduction of the cross section is permitted only in accordance with the rules for sizing of the neutral conductor.		

1SDC010014F0201

For a more accurate calculation and if the protective conductor is subjected to adiabatic heating from an initial known temperature to a final specified temperature (applicable for fault extinction time no longer than 5s), the minimum cross section of the protective conductor S<sub>PE</sub> can be obtained by using the following formula:

$$S_{PE} = \frac{\sqrt{I^2 t}}{k} \quad (1)$$

where:

- S<sub>PE</sub> is the cross section of the protective conductor [mm<sup>2</sup>];
- I is the r.m.s. current flowing through the protective conductor in the event of a fault with low impedance [A];
- t is the trip time of the protective device [s];

# 1 Protection of feeders

- $k$  is a constant which depends on the material of the protective conductor, on the type of insulation and on initial and final temperature. The most common values can be taken from Tables 3 and 4.

**Table 3: Values of  $k$  for insulated protective conductors not incorporated in cables and not bunched with other cables**

Conductor insulation	Temperature °C <sup>b</sup>		Material of conductor		
	Initial	Final	Copper	Aluminium	Steel
			Values for $k$		
70 °C PVC	30	160/140 <sup>a</sup>	143/133 <sup>a</sup>	95/88 <sup>a</sup>	52/49 <sup>a</sup>
90 °C PVC	30	143/133 <sup>a</sup>	143/133 <sup>a</sup>	95/88 <sup>a</sup>	52/49 <sup>a</sup>
90 °C thermosetting	30	250	176	116	64
60 °C rubber	30	200	159	105	58
85 °C rubber	30	220	168	110	60
Silicon rubber	30	350	201	133	73

<sup>a</sup> The lower value applies to PVC insulated conductors of cross section greater than 300 mm<sup>2</sup>.  
<sup>b</sup> Temperature limits for various types of insulation are given in IEC 60724.

1SDC010015F0201

**Table 4: Values of  $k$  for protective conductors as a core incorporated in a cable or bunched with other cables or insulated conductors**

Conductor insulation	Temperature °C <sup>b</sup>		Material of conductor		
	Initial	Final	Copper	Aluminium	Steel
			Values for $k$		
70 °C PVC	70	160/140 <sup>a</sup>	115/103 <sup>a</sup>	76/68 <sup>a</sup>	42/37 <sup>a</sup>
90 °C PVC	90	160/140 <sup>a</sup>	100/86 <sup>a</sup>	66/57 <sup>a</sup>	36/31 <sup>a</sup>
90 °C thermosetting	90	250	143	94	52
60 °C rubber	60	200	141	93	51
85 °C rubber	85	220	134	89	48
Silicon rubber	180	350	132	87	47

<sup>a</sup> The lower value applies to PVC insulated conductors of cross section greater than 300 mm<sup>2</sup>.  
<sup>b</sup> Temperature limits for various types of insulation are given in IEC 60724.

1SDC010015F0201

## 1 Protection of feeders

Further values of  $k$  can be taken from the Tables in Annex D, which provides the formula for accurate calculation of the value of  $k$ .

If Table 2 or formula (1) do not provide a standardized cross section, a larger standardized cross section shall be chosen.

Regardless of whether Table 2 or formula (1) are used, the cross section of the protective conductor, which is not part of the supply cable, shall be at least:

- 2.5 mm<sup>2</sup> Cu/16 mm<sup>2</sup> Al, if a mechanical protection is provided;
- 4 mm<sup>2</sup> Cu/16 mm<sup>2</sup> Al, if no mechanical protection is provided.

For current using equipment intended for permanent connection and with a protective conductor current exceeding 10 mA, reinforced protective conductors shall be designed as follows:

- either the protective conductor shall have a cross-sectional area of at least 10 mm<sup>2</sup> Cu or 16 mm<sup>2</sup> Al, through its total run;
- or a second protective conductor of at least the same cross-sectional area as required for protection against indirect contact shall be laid up to a point where the protective conductor has a cross-sectional area not less than 10 mm<sup>2</sup> Cu or 16 mm<sup>2</sup> Al. This requires that the appliance has a separate terminal for a second protective conductor.

When overcurrent protective devices are used for protection against electric shock, the protective conductor shall be incorporated in the same wiring system as the live conductors or be located in their immediate proximity.

---

# 1 Protection of feeders

---

## 1.6 Busbar trunking systems (BTSs)

In electrical installations for industrial environments, busbar trunking systems (BTSs) optimize the power distribution despite the inevitable modifications that are carried out (additions, displacements, replacement of loads) and to facilitate maintenance work and safety verifications.

They are mainly used for:

- supplying sources of light, safety and low power distribution;
- lighting lines (medium power);
- power supply and distribution (medium and large power);
- supplying moving equipment (bridge cranes).

Busbar trunking systems are subject to the following Standards:

- IEC 61439 – 1 “*Low-voltage switchgear and controlgear assemblies – Part 1: General rules*”
- IEC 60439 – 2 “*Low-voltage switchgear and controlgear assemblies – Part 2: Particular requirements for busbar trunking systems (busways)*”.

*BTSs consist of:*

- *conductors/busbars*;
- *coupling*: electrical and mechanical connecting elements for different elements;
- *straight elements*: base elements of the line for carrying energy from the source to the loads;
- *routing elements*: flexible joints for the creation of curves or overcoming obstacles, horizontal and vertical angles, tee joints and cross elements to create any type of route;
- *pull boxes*: elements that enable lamps or operating machines to be supplied directly with integrated protection (fuses or circuit breakers);
- *suspensions/accessories*: hanging and fixing elements for BTS and for any support required for special loads (lighting components, etc).

### Dimensioning of a BTS

To dimension a BTS, the load current must be determined using the following data:

*Power supply*

- General type of load supply:
  - single-phase
  - three-phase.
- Type of BTS supply:
  - from one end;
  - from both ends;
  - central power supply.
- Rated voltage
- Short-circuit current at the supply point
- Ambient temperature.

*Loads*

- Number, distribution, power and  $\cos\varphi$  and type of loads supplied by the same BTS

# 1 Protection of feeders

## BTS geometry

- Type of installation:
  - flat;
  - edge-on;
  - vertical.
- Length.

NOTE: BTSs shall be placed at a distance from the walls and the ceilings in such a way as to enable visual inspection of connections during assembly and to facilitate insertion of the branch units.

If possible, it is preferable to install the BTS edge-on so as to improve mechanical resistance and reduce any possible deposit of powder and polluting substances that might affect the level of internal insulation.

## Load current calculation for three-phase system

Load current  $I_b$  for a three-phase system is calculated by the following formula:

$$I_b = \frac{P_t \cdot b}{\sqrt{3} \cdot U_r \cdot \cos \varphi_m} \quad [\text{A}] \quad (1)$$

where:

- $P_t$  is the sum of the active power of all the installed loads [W];
- $b$  is the supply factor, which is:
  - 1 if the BTS is supplied from one side only;
  - 1/2 if the BTS is supplied from the centre or from both ends simultaneously;
- $U_r$  is the operating voltage [V];
- $\cos \varphi_m$  is the average power factor of the loads.

## Choice of BTS current carrying capacity

A BTS shall be chosen so that its current carrying capacity  $I_z$  complies with the following formula:

$$I_b \leq I_{z0} \cdot k_t = I_z \quad (2)$$

where:

- $I_{z0}$  is the current that the BTS can carry for an indefinite time at the reference temperature (40 °C);
- $I_b$  is the load current;
- $k_t$  is the correction factor for ambient temperature values other than the reference ambient temperature shown on Table 1.

**Table 1: Correction factor  $k_t$  for ambient temperature other than 40 °C**

Ambient Temperature [°C]	15	20	25	30	35	40	45	50
$k_t$	1.2	1.17	1.12	1.08	1.05	1	0.95	0.85

# 1 Protection of feeders

Note: the following tables show typical parameters of the BTS present on the market

**Table 2: Current carrying capacity  $I_{zo}$  of copper BTS**

Size	Generic type	Number of conductors	$I_{zo}$ [A]	$r_{ph}^*$ [mΩ/m]	$x_{ph}$ [mΩ/m]	$U_r$ [V]
25	25A 4 cond. Cu	4	25	6.964	1.144	400
25	25A 4 cond. Cu	4	25	6.876	1.400	400
25	25A 4+4 cond. Cu	4+4	25	6.876	1.400	400
40	40A 4 cond. Cu	4	40	3.556	0.792	400
40	40A 4 cond. Cu	4	40	3.516	1.580	400
40	40A 4+4 cond. Cu	4+4	40	3.516	1.580	400
40	40A 4 cond. Cu	4	40	2.173	0.290	400
63	63A 4 cond. Cu	4	63	1.648	0.637	400
100	100A 4 cond. Cu	4	100	0.790	0.366	400
160	160A 4 cond. Cu	4	160	0.574	0.247	400
160	160A 4 cond. Cu	4	160	0.335	0.314	500
160	160A 5 cond. Cu	5	160	0.335	0.314	500
250	250A 4 cond. Cu	4	250	0.285	0.205	1000
250	250A 5 cond. Cu	5	250	0.285	0.205	1000
250	250A 4 cond. Cu	4	250	0.194	0.205	500
250	250A 5 cond. Cu	5	250	0.194	0.205	500
315	315A 4 cond. Cu	4	315	0.216	0.188	1000
315	315A 5 cond. Cu	5	315	0.216	0.188	1000
350	350A 4 cond. Cu	4	350	0.142	0.188	500
350	350A 5 cond. Cu	5	350	0.142	0.188	500
400	400A 4 cond. Cu	4	400	0.115	0.129	1000
400	400A 5 cond. Cu	5	400	0.115	0.129	1000
500	500A 4 cond. Cu	4	500	0.092	0.129	500
500	500A 5 cond. Cu	5	500	0.092	0.129	500
630	630A 4 cond. Cu	4	630	0.073	0.122	1000
630	630A 5 cond. Cu	5	630	0.073	0.122	1000
700	700A 4 cond. Cu	4	700	0.077	0.122	500
700	700A 5 cond. Cu	5	700	0.077	0.122	500
700	700A 5 cond. Cu	5	700	0.077	0.122	500
700	700A 4 cond. Cu	4	700	0.077	0.122	500

# 1 Protection of feeders

Table 2

Size	Generic type	Number of conductors	$I_{z0}$ [A]	$r_{ph}^*$ [mΩ/m]	$x_{ph}$ [mΩ/m]	$U_i$ [V]
800	800A 4 cond. Cu	4	800	0.047	0.122	1000
800	800A 5 cond. Cu	5	800	0.047	0.122	1000
800	800A 4 cond. Cu	4	800	0.038	0.027	1000
800	800A 4 cond. Cu	4	800	0.072	0.122	500
800	800A 5 cond. Cu	5	800	0.072	0.122	500
1000	1000A 4 cond. Cu	4	1000	0.038	0.120	1000
1000	1000A 5 cond. Cu	5	1000	0.038	0.120	1000
1000	1000A 4 cond. Cu	4	1000	0.037	0.026	1000
1000	1000A 4 cond. Cu	4	1000	0.038	0.097	1000
1000	1000A 4 cond. Cu	4	1000	0.068	0.120	500
1000	1000A 5 cond. Cu	5	1000	0.068	0.120	500
1200	1200A 4 cond. Cu	4	1200	0.035	0.021	1000
1250	1250A 4 cond. Cu	4	1250	0.034	0.023	1000
1250	1250A 4 cond. Cu	4	1250	0.035	0.076	1000
1500	1500A 4 cond. Cu	4	1500	0.030	0.022	1000
1600	1600A 4 cond. Cu	4	1600	0.025	0.018	1000
1600	1600A 4 cond. Cu	4	1600	0.034	0.074	1000
2000	2000A 4 cond. Cu	4	2000	0.020	0.015	1000
2000	2000A 4 cond. Cu	4	2000	0.025	0.074	1000
2400	2400A 4 cond. Cu	4	2400	0.019	0.012	1000
2500	2500A 4 cond. Cu	4	2500	0.016	0.011	1000
2500	2500A 4 cond. Cu	4	2500	0.019	0.040	1000
3000	3000A 4 cond. Cu	4	3000	0.014	0.011	1000
3000	3000A 4 cond. Cu	4	3000	0.017	0.031	1000
3200	3200A 4 cond. Cu	4	3200	0.013	0.009	1000
3200	3200A 4 cond. Cu	4	3200	0.015	0.031	1000
4000	4000A 4 cond. Cu	4	4000	0.011	0.007	1000
4000	4000A 4 cond. Cu	4	4000	0.011	0.026	1000
5000	5000A 4 cond. Cu	4	5000	0.008	0.005	1000
5000	5000A 4 cond. Cu	4	5000	0.008	0.023	1000

\*phase resistance at  $I_{z0}$



# 1 Protection of feeders

**Table 3: Current carrying capacity  $I_{z0}$  of aluminium BTS**

Size	Generic type	Number of conductors	$I_{z0}$ [A]	$r_{ph}^*$ [mΩ/m]	$x_{ph}$ [mΩ/m]	$U_r$ [V]
160	160A 4 cond. Al	4	160	0.591	0.260	1000
160	160A 5 cond. Al	5	160	0.591	0.260	1000
160	160A 4 cond. Al	4	160	0.431	0.260	500
160	160A 5 cond. Al	5	160	0.431	0.260	500
250	250A 4 cond. Al	4	250	0.394	0.202	1000
250	250A 5 cond. Al	5	250	0.394	0.202	1000
250	250A 4 cond. Al	4	250	0.226	0.202	500
250	250A 5 cond. Al	5	250	0.226	0.202	500
315	315A 4 cond. Al	4	315	0.236	0.186	1000
315	315A 5 cond. Al	5	315	0.236	0.186	1000
315	315A 4 cond. Al	4	315	0.181	0.186	500
315	315A 5 cond. Al	5	315	0.181	0.186	500
400	400A 4 cond. Al	4	400	0.144	0.130	1000
400	400A 5 cond. Al	5	400	0.144	0.130	1000
400	400A 4 cond. Al	4	400	0.125	0.130	500
400	400A 5 cond. Al	5	400	0.125	0.130	500
500	500A 4 cond. Al	4	500	0.102	0.127	500
500	500A 5 cond. Al	5	500	0.102	0.127	500
630	630A 4 cond. Al	4	630	0.072	0.097	1000
630	630A 5 cond. Al	5	630	0.072	0.097	1000
630	630A 4 cond. Al	4	630	0.072	0.029	1000
630	630A 4 cond. Al	4	630	0.073	0.097	500
630	630A 5 cond. Al	5	630	0.073	0.097	500
800	800A 4 cond. Al	4	800	0.062	0.096	1000
800	800A 5 cond. Al	5	800	0.062	0.096	1000
800	800A 4 cond. Al	4	800	0.067	0.027	1000
800	800A 4 cond. Al	4	800	0.071	0.096	500
800	800A 5 cond. Al	5	800	0.071	0.096	500
1000	1000A 4 cond. Al	4	1000	0.062	0.023	1000
1000	1000A 4 cond. Al	4	1000	0.068	0.087	1000
1200	1200A 4 cond. Al	4	1200	0.054	0.023	1000
1250	1250A 4 cond. Al	4	1250	0.044	0.021	1000
1250	1250A 4 cond. Al	4	1250	0.044	0.066	1000
1500	1500A 4 cond. Al	4	1500	0.041	0.023	1000
1600	1600A 4 cond. Al	4	1600	0.035	0.017	1000
1600	1600A 4 cond. Al	4	1600	0.041	0.066	1000
2000	2000A 4 cond. Al	4	2000	0.029	0.016	1000
2000	2000A 4 cond. Al	4	2000	0.034	0.053	1000
2250	2250A 4 cond. Al	4	2250	0.032	0.049	1000
2400	2400A 4 cond. Al	4	2400	0.028	0.012	1000
2500	2500A 4 cond. Al	4	2500	0.022	0.011	1000
2500	2500A 4 cond. Al	4	2500	0.022	0.034	1000
3000	3000A 4 cond. Al	4	3000	0.020	0.011	1000
3200	3200A 4 cond. Al	4	3200	0.017	0.009	1000
3200	3200A 4 cond. Al	4	3200	0.020	0.034	1000
4000	4000A 4 cond. Al	4	4000	0.014	0.008	1000
4000	4000A 4 cond. Al	4	4000	0.017	0.024	1000
4500	4500A 4 cond. Al	4	4500	0.014	0.024	1000

\*phase resistance at  $I_{z0}$

# 1 Protection of feeders

## BTS protection

### Protection against overload

BTSs are protected against overload by using the same criterion as that used for the cables. The following formula shall be verified:

$$I_b \leq I_n \leq I_z \quad (3)$$

where:

- $I_b$  is the current for which the circuit is designed;
- $I_n$  is the rated current of the protective device; for adjustable protective devices, the rated current  $I_n$  is the set current;
- $I_z$  is the continuous current carrying capacity of the BTS.

NOTE - The protection against short-circuit does not need to be checked if MCBs up to 63 A are used whenever correctly dimensioned for overload protection. In such cases, in fact, protection against both thermal and electrodynamic effects is certainly adequate because of the energy and peak limitations offered by these protective devices.

### Protection against short-circuit

The BTS must be protected against thermal overload and electrodynamic effects due to the short-circuit current.

#### *Protection against thermal overload*

The following formula shall be fulfilled:

$$I^2 t_{CB} \leq I^2 t_{BTS} \quad (4)$$

where:

- $I^2 t_{CB}$  is the specific let-through energy of the circuit-breaker at the maximum short-circuit current value at the installation point. This can be extrapolated from the curves shown in Part 1 Chapter 1.4;
- $I^2 t_{BTS}$  is the withstood energy of the BTS and it is normally given by the manufacturer (see Tables 4 and 5).

#### *Protection against electrodynamic effects*

The following formula shall be fulfilled:

$$I_{kp\ CB} \leq I_{kp\ BTS} \quad (5)$$

where:

- $I_{kp\ CB}$  is the peak limited by the circuit-breaker at the maximum short-circuit current value at the installation point. This can be extrapolated from the limitation curves;
- $I_{kp\ BTS}$  is the maximum peak current value of the BTS (see Tables 4 and 5).

# 1 Protection of feeders

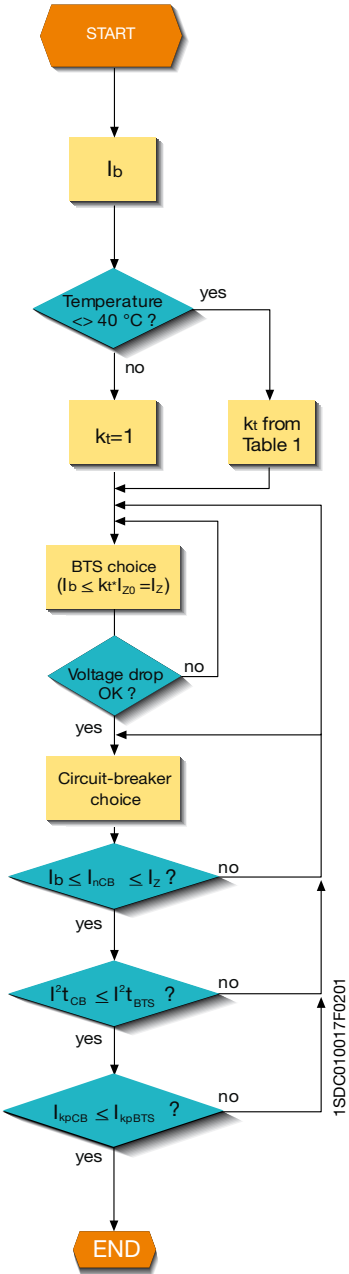

1SDC010017F0201

# 1 Protection of feeders

**Table 4: Values of the withstood energy and peak current of copper BTS**

Size	Generic type	$I_{th}^2t$ [(kA) <sup>2</sup> s]	$I_{N}^2t$ [(kA) <sup>2</sup> s]	$I_{PE}^2t$ [(kA) <sup>2</sup> s]	$I_{peakgh}$ [kA]	$I_{peakN}$ [kA]
25	25A 4 cond. Cu	0.48	0.48	0.48	10	10
25	25A 4 cond. Cu	0.64	0.64	0.64	10	10
25	25A 4+4 cond. Cu	0.64	0.64	0.64	10	10
40	40A 4 cond. Cu	0.73	0.73	0.73	10	10
40	40A 4 cond. Cu	1	1	1	10	10
40	40A 4+4 cond. Cu	1	1	1	10	10
40	40A 4 cond. Cu	7.29	7.29	7.29	10	10
63	63A 4 cond. Cu	7.29	7.29	7.29	10	10
100	100A 4 cond. Cu	20.25	20.25	20.25	10	10
160	160A 4 cond. Cu	30.25	30.25	30.25	10	10
160	160A 4 cond. Cu	100	60	60	17	10.2
160	160A 5 cond. Cu	100	100	100	17	10.2
160	160A 4 cond. Cu	100	100	100	17	10.2
250	250A 4 cond. Cu	312.5	187.5	187.5	52.5	31.5
250	250A 5 cond. Cu	312.5	312.5	312.5	52.5	31.5
250	250A 4 cond. Cu	169	101.4	101.4	26	15.6
250	250A 5 cond. Cu	169	169	169	26	15.6
250	250A 4 cond. Cu	169	169	169	26	15.6
315	315A 4 cond. Cu	312.5	187.5	187.5	52.5	31.5
315	315A 5 cond. Cu	312.5	312.5	312.5	52.5	31.5
350	350A 4 cond. Cu	169	101.4	101.4	26	15.6
350	350A 5 cond. Cu	169	169	169	26	15.6
350	350A 4 cond. Cu	169	169	169	26	15.6
400	400A 4 cond. Cu	900	540	540	63	37.8
400	400A 5 cond. Cu	900	900	900	63	37.8
500	500A 4 cond. Cu	756.25	453.75	453.75	58	34.8
500	500A 5 cond. Cu	756.25	756.25	756.25	58	34.8
500	500A 4 cond. Cu	756.25	756.25	756.25	58	34.8
630	630A 4 cond. Cu	1296	777.6	777.6	75.6	45.4
630	630A 5 cond. Cu	1296	1296	1296	75.6	45.4
700	700A 4 cond. Cu	756.25	453.75	453.75	58	34.8
700	700A 5 cond. Cu	756.25	756.25	756.25	58	34.8
700	700A 4 cond. Cu	756.25	756.25	756.25	58	34.8

# 1 Protection of feeders

Size	Generic type	$I_{th}^2t$ [(kA) <sup>2</sup> s]	$I_N^2t$ [(kA) <sup>2</sup> s]	$I_{PE}^2t$ [(kA) <sup>2</sup> s]	$I_{peakgh}$ [kA]	$I_{peakN}$ [kA]
800	800A 4 cond. Cu	1296	777.6	777.6	75.6	45.4
800	800A 5 cond. Cu	1296	1296	1296	75.6	45.4
800	800A 4 cond. Cu	3969	3969	2381.4	139	83.4
800	800A 4 cond. Cu	756.25	453.75	453.75	58	34.8
800	800A 5 cond. Cu	756.25	756.25	756.25	58	34.8
800	800A 4 cond. Cu	756.25	756.25	756.25	58	34.8
1000	1000A 4 cond. Cu	1296	777.6	777.6	75.6	45.4
1000	1000A 5 cond. Cu	1296	1296	1296	75.6	45.4
1000	1000A 4 cond. Cu	3969	3969	2381.4	139	83.4
1000	1000A 4 cond. Cu	1600	1600	960	84	50.4
1000	1000A 4 cond. Cu	1024	614.4	614.4	60	36
1000	1000A 5 cond. Cu	1024	1024	1024	60	36
1000	1000A 4 cond. Cu	1024	1024	1024	60	36
1200	1200A 4 cond. Cu	7744	7744	4646.4	194	116.4
1250	1250A 4 cond. Cu	7744	7744	4646.4	194	116.4
1250	1250A 4 cond. Cu	2500	2500	1500	105	63
1500	1500A 4 cond. Cu	7744	7744	4646.4	194	116.4
1600	1600A 4 cond. Cu	7744	7744	4646.4	194	116.4
1600	1600A 4 cond. Cu	2500	2500	1500	105	63
2000	2000A 4 cond. Cu	7744	7744	4646.4	194	116.4
2000	2000A 4 cond. Cu	3600	3600	2160	132	79.2
2400	2400A 4 cond. Cu	7744	7744	4646.4	194	116.4
2500	2500A 4 cond. Cu	7744	7744	4646.4	194	116.4
2500	2500A 4 cond. Cu	4900	4900	2940	154	92.4
3000	3000A 4 cond. Cu	30976	30976	18585.6	387	232.2
3000	3000A 4 cond. Cu	8100	8100	4860	198	118.8
3200	3200A 4 cond. Cu	30976	30976	18585.6	387	232.2
3200	3200A 4 cond. Cu	8100	8100	4860	198	118.8
4000	4000A 4 cond. Cu	30976	30976	18585.6	387	232.2
4000	4000A 4 cond. Cu	8100	8100	4860	198	118.8
5000	5000A 4 cond. Cu	30976	30976	18585.6	387	232.2
5000	5000A 4 cond. Cu	10000	10000	6000	220	132

# 1 Protection of feeders

**Table 5: Values of the withstood energy and peak current of aluminium BTS**

Size	Generic type	$I_{ph}^2 t$ [(kA) <sup>2</sup> s]	$I_N^2 t$ [(kA) <sup>2</sup> s]	$I_{PE}^2 t$ [(kA) <sup>2</sup> s]	$I_{peakph}$ [kA]	$I_{peakN}$ [kA]
160	160A 4 cond. Al	112.5	67.5	67.5	30	18
160	160A 5 cond. Al	112.5	112.5	112.5	30	18
160	160A 4 cond. Al	100	60	60	17	10.2
160	160A 5 cond. Al	100	100	100	17	10.2
160	160A 4 cond. Al	100	100	100	17	10.2
250	250A 4 cond. Al	312.5	187.5	187.5	52.5	31.5
250	250A 5 cond. Al	312.5	312.5	312.5	52.5	31.5
250	250A 4 cond. Al	169	101.4	101.4	26	15.6
250	250A 5 cond. Al	169	169	169	26	15.6
250	250A 4 cond. Al	169	169	169	26	15.6
315	315A 4 cond. Al	625	375	375	52.5	31.5
315	315A 5 cond. Al	625	625	625	52.5	31.5
315	315A 4 cond. Al	169	101.4	101.4	26	15.6
315	315A 5 cond. Al	169	169	169	26	15.6
315	315A 4 cond. Al	169	169	169	26	15.6
400	400A 4 cond. Al	900	540	540	63	37.8
400	400A 5 cond. Al	900	900	900	63	37.8
400	400A 4 cond. Al	625	375	375	52.5	31.5
400	400A 5 cond. Al	625	625	625	52.5	31.5
400	400A 4 cond. Al	625	625	625	52.5	31.5
500	500A 4 cond. Al	625	375	375	52.5	31.5
500	500A 5 cond. Al	625	625	625	52.5	31.5
500	500A 4 cond. Al	625	625	625	52.5	31.5
630	630A 4 cond. Al	1296	777.6	777.6	75.6	45.4
630	630A 5 cond. Al	1296	1296	1296	75.6	45.4
630	630A 4 cond. Al	1444	1444	866.4	80	48
630	630A 4 cond. Al	1024	614.4	614.4	67.5	40.5
630	630A 5 cond. Al	1024	1024	1024	67.5	40.5

# 1 Protection of feeders

Size	Generic type	$I_{ph}^{2t}$ [(kA) <sup>2</sup> s]	$I_N^{2t}$ [(kA) <sup>2</sup> s]	$I_{PE}^{2t}$ [(kA) <sup>2</sup> s]	$I_{peakph}$ [kA]	$I_{peakN}$ [kA]
630	630A 4 cond. Al	1024	1024	1024	67.5	40.5
800	800A 4 cond. Al	1296	777.6	777.6	75.6	45.4
800	800A 5 cond. Al	1296	1296	1296	75.6	45.4
800	800A 4 cond. Al	1764	1764	1058.4	88	52.8
800	800A 4 cond. Al	1024	614.4	614.4	67.5	40.5
800	800A 5 cond. Al	1024	1024	1024	67.5	40.5
800	800A 4 cond. Al	1024	1024	1024	67.5	40.5
1000	1000A 4 cond. Al	6400	6400	3840	176	105.6
1000	1000A 4 cond. Al	1600	1600	960	84	50.4
1200	1200A 4 cond. Al	6400	6400	3840	176	105.6
1250	1250A 4 cond. Al	6400	6400	3840	176	105.6
1250	1250A 4 cond. Al	2500	2500	1500	105	63
1500	1500A 4 cond. Al	6400	6400	3840	176	105.6
1600	1600A 4 cond. Al	6400	6400	3840	176	105.6
1600	1600A 4 cond. Al	2500	2500	1500	105	63
2000	2000A 4 cond. Al	6400	6400	3840	176	105.6
2000	2000A 4 cond. Al	3600	3600	2160	132	79.2
2250	2250A 4 cond. Al	4900	4900	2940	154	92.4
2400	2400A 4 cond. Al	25600	25600	15360	352	211.2
2500	2500A 4 cond. Al	25600	25600	15360	352	211.2
2500	2500A 4 cond. Al	8100	8100	4860	198	118.8
3000	3000A 4 cond. Al	25600	25600	15360	352	211.2
3200	3200A 4 cond. Al	25600	25600	15360	352	211.2
3200	3200A 4 cond. Al	8100	8100	4860	198	118.8
4000	4000A 4 cond. Al	25600	25600	15360	352	211.2
4000	4000A 4 cond. Al	8100	8100	4860	198	118.8
4500	4500A 4 cond. Al	10000	10000	6000	220	132

# 1 Protection of feeders

## Protection of the outgoing feeders

If the outgoing feeder, which generally consists of cable duct, is not already protected against short-circuit and overload by the device located upstream of the cable, the following measures shall be taken:

- *protection against short-circuit:*

there is no need to protect the feeder against the short-circuit if simultaneously:

- a. the length does not exceed 3 metres;
- b. the risk of short-circuit is minimized;
- c. there is no inflammable material nearby.

In explosive environments and environments with greater risk of fire, protection against short-circuit is always required;

- *protection against overload:*

the current carrying capacity of the feeder is generally lower than that of the BTS. It is therefore necessary to protect also the feeder against overload.

The protection device against overload can be placed inside the pull box or on the incoming panel.

In the latter case, protection against overload can also be provided by the circuit-breakers protecting the single outgoing feeder from the panel only if the sum of their rated currents is lower or equal to the current carrying capacity  $I_z$  of the outgoing feeder.

In locations with greater risk of fire, the overload protection device shall be installed at the outgoing point, i.e. inside the pull box.

## Voltage drop

If a BTS is particularly long, the value of the voltage drop must be verified.

For three-phase systems with a power factor ( $\cos\varphi_m$ ) not lower than 0.8, the voltage drop can be calculated by using the following simplified formula:

$$\Delta u = \frac{a \cdot \sqrt{3} \cdot I_b \cdot L \cdot (r_t \cdot \cos\varphi_m + x \cdot \sin\varphi_m)}{1000} \text{ [V]} \quad (6a)$$

For single-phase BTS the formula is:

$$\Delta u = \frac{a \cdot 2 \cdot I_b \cdot L \cdot (r_t \cdot \cos\varphi_m + x \cdot \sin\varphi_m)}{1000} \text{ [V]} \quad (6b)$$

where:

- $a$  is the current distribution factor, which depends on the circuit supply and the arrangement of the electric loads along the BTS, as shown in Table 6:



# 1 Protection of feeders

**Table 6: Current distribution factor**

Type of supply	Arrangement of loads	Current distribution factor
From one end only	Load concentrated at the end	1
	Evenly distributed load	0.5
From both ends	Evenly distributed load	0.25
	Load concentrated at the ends	0.25
Central	Load concentrated at the ends	0.25
	Evenly distributed load	0.125

- $I_b$  is the load current [A];
- $L$  is the BTS length [m];
- $r_t$  is the phase resistance per unit of length of BTS, measured under thermal steady-state conditions [ $m\Omega/m$ ];
- $x$  is the phase reactance per unit of length of BTS [ $m\Omega/m$ ];
- $\cos\varphi_m$  is average power factor of the loads.

Percentage voltage drop is obtained from:

$$\Delta u\% = \frac{\Delta u}{U_r} \cdot 100 \quad (7)$$

where  $U_r$  is rated voltage.

To reduce the voltage drop in very long BTS the power can be supplied at an intermediate position rather than at the end (see Table 6).

## Calculation of voltage drop for unevenly distributed loads

If the loads cannot be considered to be evenly distributed, the voltage drop can be calculated more accurately by using the formulas below.

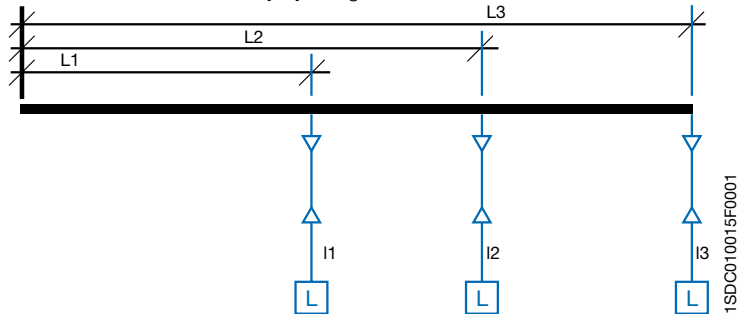

For the distribution of the three-phase loads shown in the figure, the voltage drop can be calculated by the following formula if the BTS has a constant cross section (as usual):

$$u = \sqrt{3}[r_t(I_1L_1 \cos\varphi_1 + I_2L_2 \cos\varphi_2 + I_3L_3 \cos\varphi_3) + x(I_1L_1 \sin\varphi_1 + I_2L_2 \sin\varphi_2 + I_3L_3 \sin\varphi_3)]$$

# 1 Protection of feeders

Generally speaking, this formula becomes:

$$U = \frac{\sqrt{3} \cdot r_t \cdot \sum I_i \cdot L_i \cdot \cos \varphi_{mi} + x \cdot \sum I_i \cdot L_i \cdot \sin \varphi_{mi}}{1000} \quad [\text{V}] \quad (8)$$

where:

- $r_t$  is the phase resistance per unit of length of BTS, measured under thermal steady-state conditions [ $\text{m}\Omega/\text{m}$ ];
- $x$  is the phase reactance per unit of length of BTS [ $\text{m}\Omega/\text{m}$ ];
- $\cos \varphi_{mi}$  is average power factor of the  $i$ -th load;
- $I_i$  is  $i$ -th load current [A];
- $L_i$  is the distance of the  $i$ -th load from the beginning of the BTS [m].

## Joule-effect losses

Joule-effect losses are due to the electrical resistance of the BTS.

The losses are dissipated in heat and contribute to the heating of the trunking and of the environment. Calculation of power losses is useful for correctly dimensioning the air-conditioning system for the building.

Three-phase losses are:

$$P_j = \frac{3 \cdot r_t \cdot I_b^2 \cdot L}{1000} \quad [\text{W}] \quad (9a)$$

while single-phase losses are:

$$P_j = \frac{2 \cdot r_t \cdot I_b^2 \cdot L}{1000} \quad [\text{W}] \quad (9b)$$

where:

- $I_b$  is the current used [A];
- $r_t$  is the phase resistance per unit of length of BTS measured under thermal steady-state conditions [ $\text{m}\Omega/\text{m}$ ];
- $L$  is the length of BTS [m].

For accurate calculations, losses must be assessed section by section on the basis of the currents flowing through them; e.g. in the case of distribution of loads shown in the previous figure:

	Length	Current	Losses
1° section	$L_1$	$I_1 + I_2 + I_3$	$P_1 = 3r_t L_1 (I_1 + I_2 + I_3)^2$
2° section	$L_2 - L_1$	$I_2 + I_3$	$P_2 = 3r_t (L_2 - L_1) (I_2 + I_3)^2$
3° section	$L_3 - L_2$	$I_3$	$P_3 = 3r_t (L_3 - L_2) (I_3)^2$
Total losses in BTS			$P_{\text{tot}} = P_1 + P_2 + P_3$

## 2 Protection of electrical equipment

### 2.1 Protection and switching of lighting circuits

#### Introduction

Upon supply of a lighting installation, for a brief period an initial current exceeding the rated current (corresponding to the power of the lamps) circulates on the network. This possible peak has a value of approximately 15÷20 times the rated current, and is present for a few milliseconds according to the type of lighting; there may also be an inrush current with a value of approximately 1.5÷3 times the rated current, lasting up to some minutes. The correct dimensioning of the switching and protection devices must take these problems into account.

Peak current diagram

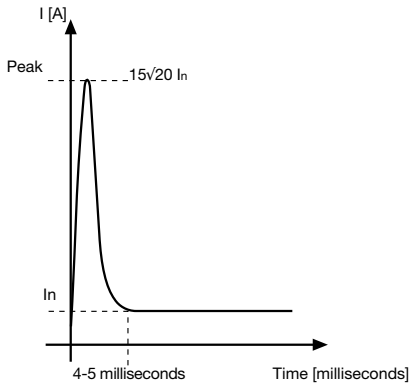

Inrush current diagram

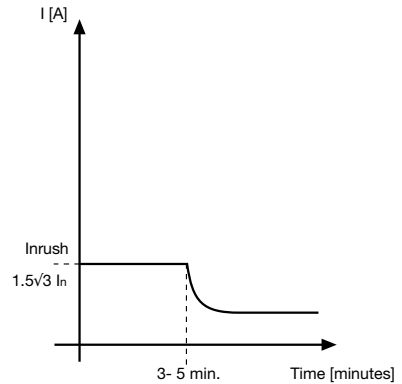

The most commonly used lamps are of the following types:

- incandescent;
- halogen;
- fluorescent;
- high intensity discharge: mercury vapour, metal halide and sodium vapour.

#### Incandescent lamps

Incandescent lamps are made up of a glass bulb containing a vacuum or inert gas and a tungsten filament. The current flows through this filament, heating it until light is emitted.

The electrical behaviour of these lamps involves a high peak current, equal to approximately 15 times the rated current; after a few milliseconds the current returns to the rated value. The peak is caused by the lamp filament which, initially cold, presents a very low electrical resistance. Subsequently, due to the very fast heating of the element, the resistance value increases considerably, causing the decrease in the current absorbed.

## 2 Protection of electrical equipment

### Halogen lamps

Halogen lamps are a special type of incandescent lamp in which the gas contained within the bulb prevents the vaporized material of the tungsten filament from depositing on the surface of the bulb and forces re-deposition on the filament. This phenomenon slows the deterioration of the filament, improves the quality of the light emitted and increases the life of the lamp.

The electrical behaviour of these lamps is the same as that of incandescent lamps.

### Fluorescent lamps

Fluorescent lamps are a so-called discharge light source. The light is produced by a discharge within a transparent enclosure (glass, quartz, etc. depending on the type of lamp) which contains mercury vapour at low pressure.

Once the discharge has started, the gas within the enclosure emits energy in the ultraviolet range which strikes the fluorescent material; in turn, this material transforms the ultraviolet radiation into radiation which has a wavelength within the visible spectrum. The colour of the light emitted depends upon the fluorescent material used.

The discharge is created by an appropriate peak in voltage, generated by a starter. Once the lamp has been switched on, the gas offers an ever lower resistance, and it is necessary to stabilize the intensity of the current, using a controller (reactor); this lowers the power factor to approximately 0.4÷0.6; normally a capacitor is added to increase the power factor to a value of more than 0.9

There are two types of controllers, magnetic (conventional) and electronic, which absorb from 10% to 20% of the rated power of the lamp. Electronic controllers offer specific advantages such as a saving in the energy absorbed, a lower dissipation of heat, and ensure a stable, flicker-free light. Some types of fluorescent lamps with electronic reactors do not need a starter.

*Compact fluorescent lamps* are made up of a folded tube and a plastic base which contains, in some cases, a conventional or electronic controller.

The value of the inrush current depends upon the presence of a power factor correction capacitor:

- non PFC lamps have inrush currents equal to approximately twice the rated current and a turn-on time of about ten seconds;
- in PFC lamps, the presence of the capacitor allows the reduction of the turn-on time to a few seconds, but requires a high peak current, determined by the charge of the capacitor, which can reach 20 times the rated current.

If the lamp is fitted with an electronic controller, the initial transient current may lead to peak currents equal to, at maximum, 10 times the rated current.

## 2 Protection of electrical equipment

### High intensity discharge lamps: mercury vapour, metal halide and sodium vapour

The functioning of high intensity discharge lamps is the same as that of fluorescent lamps with the difference that the discharge occurs in the presence of a gas at high pressure. In this case, the arc is able to vaporize the metallic elements contained in the gas, releasing energy in the form of radiation which is both ultraviolet and within the visible spectrum. The special type of bulb glass blocks the ultraviolet radiation and allows only the visible radiation to pass through. There are three main types of high intensity discharge lamps: mercury vapour, metal halide and sodium vapour. The colour characteristics and the efficiency of the lamp depend upon the different metallic elements present in the gas, which are struck by the arc.

High intensity discharge lamps require a suitably sized controller and a heating period which can last some minutes before the emission of the rated light output. A momentary loss of power makes the restarting of the system and the heating necessary.

Non PFC lamps have inrush currents of up to twice the rated current for approximately 5 minutes.

PFC lamps have a peak current equal to 20 times the rated current, and an inrush current of up to twice the rated current for approximately 5 minutes.

Lamp type		Peak current	Inrush current	Turn-on time
Incandescent lamps		$15I_n$	–	–
Halogen lamps		$15I_n$	–	–
Fluorescent lamp	Non PFC	–	$2I_n$	10 s
	PFC	$20I_n$	–	$1\div 6$ s
High intensity discharge lamps	Non PFC	–	$2I_n$	$2\div 8$ min
	PFC	$20I_n$	$2I_n$	$2\div 8$ min

### Protection and switching devices

IEC 60947-4-1 identifies two specific utilization categories for lamp control contactors:

- AC-5a switching of electric discharge lamps controls;
- AC-5b switching of incandescent lamps.

The documentation supplied by the manufacturer includes tables for contactor selection, according to the number of lamps to be controlled, and to their type.

## 2 Protection of electrical equipment

For the selection of a protection device the following verifications shall be carried out:

- the trip characteristic curve shall be above the turning-on characteristic curve of the lighting device to avoid unwanted trips; an approximate example is shown in Figure1;
- coordination shall exist with the contactor under short-circuit conditions (lighting installations are not generally characterized by overloads).

With reference to the above verification criteria, the following tables show the maximum number of lamps per phase which can be controlled by the combination of ABB circuit-breakers and contactors for some types of lamps, according to their power and absorbed current  $I_b^{(*)}$ , for three phase installations with a rated voltage of 400 V and a maximum short-circuit current of 15 kA.

(\*) For calculation see Annex B Calculation of load current  $I_b$

**Table 1: Incandescent and halogen lamps**

U <sub>r</sub> = 400 V		I <sub>k</sub> = 15 kA					
Incandescent/halogen lamps							
Circuit-breaker type		S200P D20	S200P D20	S200P D25	S200P D32	S200P D50	
Setting Ekip LS/I		----	----	----	----	----	
Contactor type		A26	A26	A26	A26	A30	
Rated Power [W]	Rated current I <sub>b</sub> [A]						
60	0.27	57	65	70	103	142	
100	0.45	34	38	42	62	85	
200	0.91	17	19	20	30	42	
300	1.37	11	12	13	20	28	
500	2.28	6	7	8	12	16	
1000	4.55	3	4	4	6	8	

## 2 Protection of electrical equipment

**Figure 1: Approximate diagram for the coordination of lamps with protection and switching devices**

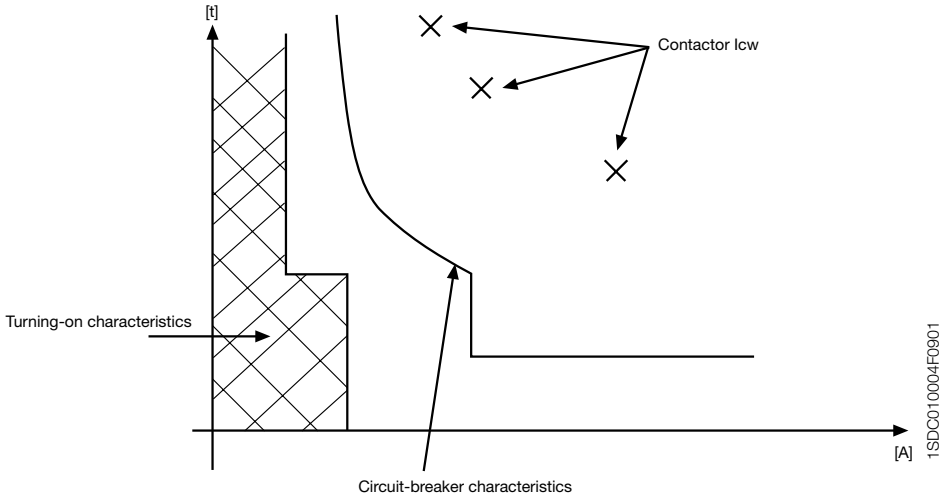

XT2N160 In63	XT2N160 In63	XT2N160 In100	XT2N160 In100	XT2N160 In100	XT2N160 In160
L= 0.68-12s S=8-0.1	L= 0.96-12s S=10-0.1	L= 0.68-12s S=8-0.1	L= 0.76-12s S=8-0.1	L= 0.96-12s S=10-0.1	L= 0.72-12s S=7-0.1
A40	A50	A63	A75	A95	A110
N° lamps per phase					
155	220	246	272	355	390
93	132	147	163	210	240
46	65	73	80	105	120
30	43	48	53	70	80
18	26	29	32	42	48
9	13	14	16	21	24

## 2 Protection of electrical equipment

**Table 2: Fluorescent lamps**

U <sub>r</sub> = 400 V		I <sub>k</sub> = 15 kA					
Fluorescent lamps non PFC							
Circuit-breaker type		S200P D16	S200P D20	S200P D20	S200P D32	S200P D40	
Setting Ekip LS/I							
Contactor type		A26	A26	A26	A26	A30	
Rated Power [W]	Rated current I <sub>b</sub> [A]						
20	0.38	40	44	50	73	100	
40	0.45	33	37	42	62	84	
65	0.7	21	24	27	40	54	
80	0.8	18	21	23	35	47	
100	1.15	13	14	16	24	33	
110	1.2	12	14	15	23	31	

U <sub>r</sub> = 400 V		I <sub>k</sub> = 15 kA			
Fluorescent lamps PFC					
Circuit-breaker type		S200P D25	S200P D25	S200P D32	
Setting Ekip LS/I		---	---	---	
Contactor type		A26	A26	A26	
Rated Power [W]	Rated current I <sub>b</sub> [A]	Capacitor [μF]			
20	0.18	5	83	94	105
40	0.26	5	58	65	75
65	0.42	7	35	40	45
80	0.52	7	28	32	36
100	0.65	16	23	26	29
110	0.7	18	21	24	27



## 2 Protection of electrical equipment

S200P D50	S200P D63	XT2N160 In100	XT2N160 In100	XT2N160 In100	XT2N160 In160
		L= 0.68-12s S=10-0.1	L= 0.76-12s S=10-0.1	L= 0.96-12s S=10-0.1	L= 0.68-12s S=10-0.1
A40	A50	A63	A75	A95	A110
N° lamps per phase					
110	157	173	192	250	278
93	133	145	162	210	234
60	85	94	104	135	150
52	75	82	91	118	132
36	52	57	63	82	92
35	50	55	60	79	88

1SDC010033F0201

S200P D40	S200P D63	XT2N160 In63	XT2N160 In63	XT2N160 In100	XT2N160 In100	XT2N160 In100
---	---	L= 0.68-12s S=8-0.1	L= 1-12s S=10-0.1	L= 0.68-12s S=10-0.1	L= 0.76-12s S=10-0.1	L= 0.96-12s S=10-0.1
A26	A30	A40	A50	A63	A75	A95
N° lamps per phase						
155	215	233	335	360	400	530
107	150	160	230	255	280	365
66	92	100	142	158	173	225
53	74	80	115	126	140	180
43	59	64	92	101	112	145
40	55	59	85	94	104	135

## 2 Protection of electrical equipment

**Table 3: High intensity discharge lamps**

U <sub>r</sub> = 400 V		I <sub>k</sub> = 15 kA					
Fluorescent lamps non PFC							
Circuit-breaker type		S200P D16	S200P D20	S200P D20	S200P D32	S200P D40	
Setting Ekip LS/I							
Contactor type		A26	A26	A26	A26	A30	
Rated Power [W]	Rated current I <sub>b</sub> [A]						
150	1.8	6	7	8	11	15	
250	3	4	4	5	7	9	
400	4.4	3	3	3	4	6	
600	6.2	1	2	2	3	4	
1000	10.3	-	1	1	2	3	

U <sub>r</sub> = 400 V		I <sub>k</sub> = 15 kA					
Fluorescent lamps PFC							
Circuit-breaker type		S200P D16	S200P D20	S200P D20	S200P D32	S200P D40	
Setting Ekip LS/I		---	---	---	---	---	
Contactor type		A26	A26	A26	A26	A30	
Rated Power [W]	Rated current I <sub>b</sub> [A]	Capacitor [μF]					
150	1	20	13	14	15	23	28
250	1.5	36	8	9	10	15	18
400	2.5	48	5	5	6	9	11
600	3.3	65	4	4	5	7	8
1000	6.2	100	-	-	-	4	4

## 2 Protection of electrical equipment

S200P D40	S200P D50	S200P D63	XT2N160 In100	XT2N160 In100	XT2N160 In160
			L=0.8-12s S=6.5-0.1s	L=1-12s S=8-0.1s	L=0.8-12s S=6.5-0.1s
A40	A50	A63	A75	A95	A110
N° lamps per phase					
17	23	26	29	38	41
10	14	16	17	23	25
7	9	10	12	15	17
5	7	8	8	11	12
3	4	5	5	6	7

S200P D40	XT2N160 In100	XT2N160 In100	XT2N160 In100	XT2N160 In160	XT2N160 In160
---	L= 0.8-12s S=6.5-0.1s	L= 0.88-12s S=6.5-0.1s	L= 1-12s S=6.5-0.1s	L= 0.84-12s S=4.5-0.1s	L=0.88-12s S=4.5-0.1s
A40	A50	A63	A75	A95	A110
N° lamps per phase					
30	50	58	63	81	88
20	33	38	42	54	59
12	20	23	25	32	36
9	15	17	19	24	27
5	8	9	10	13	14

### Example:

Switching and protection of a lighting system, supplied by a three phase network at 400 V 15 kA, made up of 55 incandescent lamps, of 200 W each, per phase.

In Table 1, on the row corresponding to 200 W, select the cell showing the number of controllable lamps immediately above the number of lamps per phase present in the installation. In the specific case, corresponding to the cell for 65 lamps per phase the following equipment are suggested:

- SACE Tmax XT2N160 In63 circuit-breaker with Ekip LS/I type electronic release, with protection L set at 0.96, t1 at 12s and protection S set at 10, t2 at 0.1s;
- A50 contactor.

## 2 Protection of electrical equipment

### 2.2 Protection and switching of generators

The need to guarantee an ever greater continuity of service has led to an increase in the use of emergency supply generators, either as an alternative to, or in parallel with the public utility supply network.

Typical configurations include:

- “Island supply” (independent functioning) of the priority loads in the case of a lack of energy supply through the public network;
- supply to the user installation in parallel with the public supply network.

Unlike the public supply network, which has a constant contribution, in case of a short-circuit, the current supplied by the generator is a function of the parameters of the machine itself, and decreases with time; it is possible to identify the following successive phases:

1. a subtransient phase: with a brief duration (10÷50 ms), characterized by the subtransient reactance  $X''_d$  (5÷20% of the rated impedance value), and by the subtransient time constant  $T''_d$  (5÷30 ms);
2. a transitory phase: may last up to some seconds (0.5÷2.5 s), and is characterized by the transitory reactance  $X'_d$  (15÷40% of the rated impedance value), and by the transitory time constant  $T'_d$  (0.03÷2.5 s);
3. a synchronous phase: may persist until the tripping of external protection, and is characterized by the synchronous reactance  $X_d$  (80÷300% of the rated impedance value).

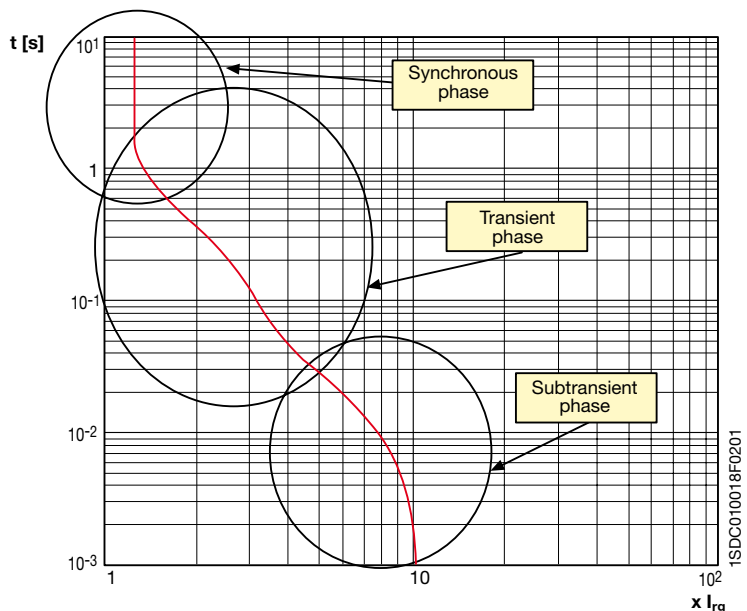

## 2 Protection of electrical equipment

As a first approximation, it can be estimated that the maximum value of the short-circuit current  $I_{kg}$  of a generator, with rated power  $S_{rg}$ , at the rated voltage of the installation  $U_r$ , is equal to:

$$I_{kg} = \frac{I_{rg} \cdot 100}{X_d^n \%}$$

where

$I_{rg}$  is the rated current of the generator:

$$I_{rg} = \frac{S_{rg}}{\sqrt{3} \cdot U_r}$$

The circuit-breaker for the protection of the generator shall be selected according to the following criteria:

- the set current higher than the rated current of the generator:  $I_1 \geq I_{rg}$ ;
- breaking capacity  $I_{cu}$  or  $I_{cs}$  higher than the maximum value of short-circuit current at the installation point:
  - in the case of a single generator:  $I_{cu}(I_{cs}) \geq I_{kg}$ ;
  - in the case of  $n$  identical generators in parallel:  $I_{cu}(I_{cs}) \geq I_{kg} \cdot (n-1)$ ;
  - in the case of operation in parallel with the network:  $I_{cu}(I_{cs}) \geq I_{kNet}$ , as the short-circuit contribution from the network is normally greater than the contribution from the generator;
- for circuit-breakers with thermomagnetic releases: low magnetic trip threshold:  $I_3 = 2.5/3 \cdot I_n$ ;
- for circuit-breakers with electronic releases:
  - trip threshold of the delayed short-circuit protection function (S), set between 1.5 and 4 times the rated current of the generator, in such a way as to "intercept" the decrement curve of the generator:  $I_2 = (1.5 \div 4) \cdot I_{rg}$ ; if the function S is not present, function I can be set at the indicated values  $I_3 = (1.5 \div 4) \cdot I_{rg}$ ;
  - trip threshold of the instantaneous short-circuit protection function ( $I_3$ ) set at a value greater than the rated short-circuit current of the generator, so as to achieve discrimination with the devices installed downstream, and to allow fast tripping in the event of a short-circuit upstream of the device (working in parallel with other generators or with the network):

$$I_3 \geq I_{kg}$$

## 2 Protection of electrical equipment

The following tables give ABB SACE suggestions for the protection and switching of generators; the tables refer to 400 V (Table 1), 440 V (Table 2), 500 V (Table 3) and 690 V (Table 4). Molded-case circuit-breakers can be equipped with both thermomagnetic (TMG) as well as electronic releases.

Table 1

400 V

$S_{ig}$ [kVA]	MCB	MCCB	ACB
4	S200 B6	XT1 160 XT2 160	
6	S200 B10		
7	S200 B13		
9			
11	S200 B16		
14	S200 B25		
17			
19			
21	S200 B32		
22			
28	S200 B50		
31			
35	S200 B63		
38			
42			
44	S280 B80		
48			
55	S280 B100		
69			
80			
87			
100			
111			
138			
159	XT3 250 XT4 250		
173			
180			
190	T4 320		
208			
218			
242	T5 400		
277			
308			
311	T5 630		
346			
381			
415			
436			
484	T6 800		
554			
692	T7 1000		
727			
865	T7 1250		
1107			
1730	T7 1600		
2180			
2214			
2250			
2500			
2800			
3150			
3500			
		E3 2500	
		E3 3200	
		E4 4000	
		E6 5000	
		E6 6300	

Table 2

440 V

$S_{ig}$ [kVA]	MCB	MCCB	ACB
4	S200 B6	XT1 160 XT2 160	
6	S200 B8		
7	S200 B10		
9	S200 B13		
11	S200 B16		
14	S200 B20		
17	S200 B25		
19			
21	S200 B32		
22			
28	S200 B40		
31			
35	S200 B50		
38			
42	S200 B63		
44			
48	S280 B80		
55			
69	S280 B100		
80			
87			
100			
111			
138			
159			
173	XT3 250 XT4 250		
180			
190			
208			
218			
242	T4 320		
277			
308			
311			
346			
381			
415			
436			
484			
554	T5 630		
692			
727			
865			
1107			
1730			
2180			
2214			
2250			
2500			
2800			
3150			
3500			
		T5 400	
		T5 630	X1 630
		T6 800	X1 800**
		T7 1000	X1 1000**
		T7 1250	X1 1250**
		T7 1600	X1 1600**
			E3 2500
			E3 3200
			E4 3600
			E4 4000
			E6 5000

\*\* also Emax CB type E1 can be used for this application

## 2 Protection of electrical equipment

Table 3

500 V

$S_{ig}$ [kVA]	MCB	MCCB	ACB
4			
6			
7			
9			
11			
14			
17			
19			
21			
22			
28			
31			
35			
38			
42		XT1 160 XT2 160	
44			
48			
55			
69			
80			
87			
100			
111			
138			
159			
173		XT3 250 XT4 250	
180			
190			
208			
218		T4 320	
242			
277			
308		T5 400	
311			
346			
381			
415		T5 630	X1 630
436			
484			
554		T6 800	X1 800**
692			
727		T7 1000	X1 1000**
865			
1107		T7 1600	X1 1600**
1730			E2 2000
2180			
2214			E3 3200
2250			
2500			
2800			E4 4000
3150			
3500			E6 5000

Table 4

690 V

$S_{ig}$ [kVA]	MCB	MCCB	ACB
4			
6			
7			
9			
11			
14			
17			
19			
21			
22			
28			
31			
35			
38			
42		XT1 160 XT2 160	
44			
48			
55			
69			
80			
87			
100			
111			
138			
159			
173			
180			
190			
208			
218		XT3 250 XT4 250	
242			
277			
308			
311		T4 320	
346			
381			
415		T5 400	
436			
484			
554		T5 630	X1 630
692			
727			
865		T6 800	X1 800**
1107		T7 1000	X1 1000**
1730		T7 1600	X1 1600**
2180			
2214			E2 2000
2250			
2500			E3 2500
2800			
3150			E3 3200
3500			

\*\* also Emax CB type E1 can be used for this application

1SDC010017F0001

## 2 Protection of electrical equipment

### Example:

Protection of a generator with  $S_{rg} = 100$  kVA, in a system with a rated voltage of 440 V.

The generator parameters are:

$$U_r = 440 \text{ V}$$

$$S_{rg} = 100 \text{ kVA}$$

$$f = 50 \text{ Hz}$$

$$I_{rg} = 131.2 \text{ A}$$

$$X_d' = 6.5 \% \text{ (subtransient reactance)}$$

$$X_d'' = 17.6 \% \text{ (transient reactance)}$$

$$X_{s1} = 230 \% \text{ (synchronous reactance)}$$

$$T_d' = 5.5 \text{ ms (subtransient time constant)}$$

$$T_d'' = 39.3 \text{ ms (transient time constant)}$$

From table 2, an SACE Tmax XT2N160 circuit-breaker is selected, with  $I_n = 160$  A, with electronic trip unit Ekip G LS/I. For correct protection of the generator, the following settings are selected:

function L: 0.84 – 3s, corresponding to 134.4 A, value greater than  $I_{rg}$   
function I: 1.5

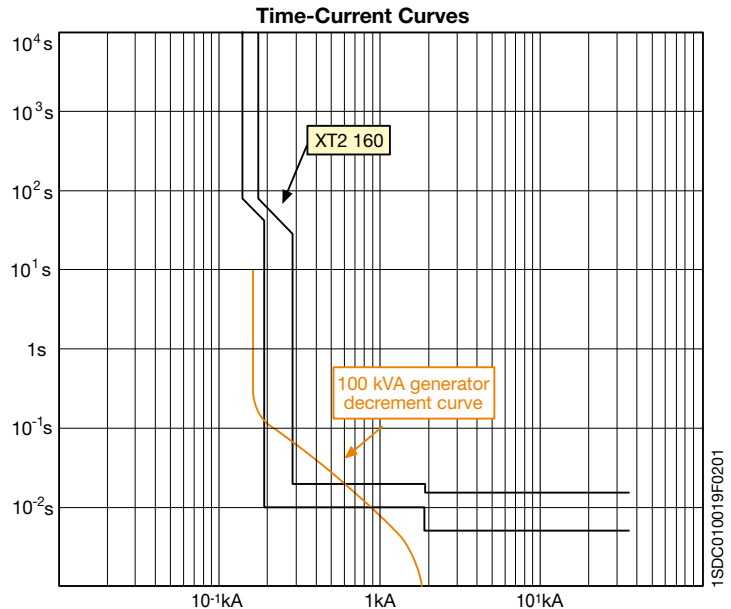



---

## 2 Protection of electrical equipment

---

### 2.3 Protection and switching of motors

#### Electromechanical starter

The starter is designed to:

- start motors;
- ensure continuous functioning of motors;
- disconnect motors from the supply line;
- guarantee protection of motors against working overloads.

The starter is typically made up of a switching device (contactor) and an overload protection device (thermal release).

The two devices must be coordinated with equipment capable of providing protection against short-circuit (typically a circuit-breaker with magnetic release only), which is not necessarily part of the starter.

The characteristics of the starter must comply with the international Standard IEC 60947-4-1, which defines the above as follows:

**Contactor:** a mechanical switching device having only one position of rest, operated otherwise than by hand, capable of making, carrying and breaking currents under normal circuit conditions including operating overload conditions.

**Thermal release:** thermal overload relay or release which operates in the case of overload and also in case of loss of phase.

**Circuit-breaker:** defined by IEC 60947-2 as a mechanical switching device, capable of making, carrying and breaking currents under normal circuit conditions and also making, carrying for a specified time and breaking currents under specified abnormal circuit conditions.

The main types of motor which can be operated and which determine the characteristics of the starter are defined by the following utilization categories:

**Table 1: Utilization categories and typical applications**

Current type	Utilization categories	Typical applications
Alternating Current ac	AC-2	Slip-ring motors: starting, switching off
	AC-3	Squirrel-cage motors: starting, switching off during running <sup>(1)</sup>
	AC-4	Squirrel-cage motors: starting, plugging, inching

<sup>(1)</sup> AC-3 categories may be used for occasionally inching or plugging for limited time periods such as machine set-up; during such limited time periods the number of such operations should not exceed five per minutes or more than ten in a 10 minutes period.

## 2 Protection of electrical equipment

The choice of the starting method and also, if necessary, of the type of motor to be used depends on the typical resistant torque of the load and on the short-circuit power of the motor supplying network.

With alternating current, the most commonly used motor types are as follows:

- asynchronous three-phase squirrel-cage motors (AC-3): the most widespread type due to the fact that they are of simple construction, economical and sturdy; they develop high torque with short acceleration times, but require elevated starting currents;
- slip-ring motors (AC-2): characterized by less demanding starting conditions, and have quite a high starting torque, even with a supply network of low power.

### Starting methods

The most common starting methods for asynchronous squirrel-cage motors are detailed below:

#### Direct starting

With direct starting, the DOL (Direct On Line) starter, with the closing of line contactor KL, the line voltage is applied to the motor terminals in a single operation. Hence a squirrel-cage motor develops a high starting torque with a relatively reduced acceleration time. This method is generally used with small and medium power motors which reach full working speed in a short time. These advantages are, however, accompanied by a series of drawbacks, including, for example:

- high current consumption and associated voltage drop which may cause damages to the other parts of the system connected to the network;
- violent acceleration which has negative effects on mechanical transmission components (belts, chains and mechanical joints), reducing working life.

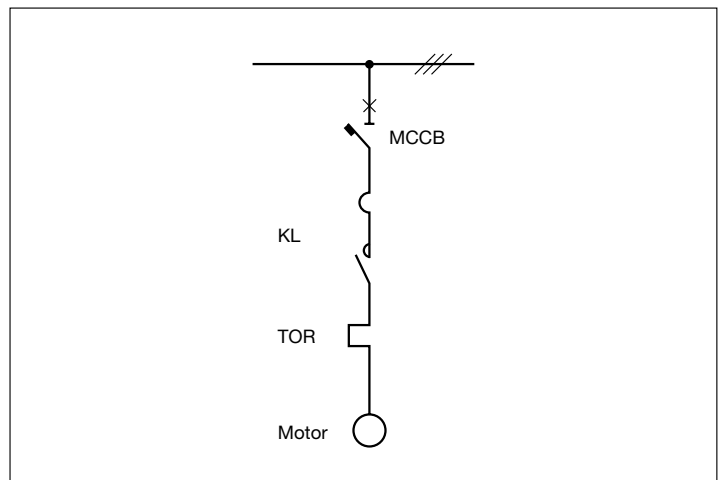

1SDC010018F0001

## 2 Protection of electrical equipment

Other types of starting for squirrel-cage motors are accomplished by reducing the supply voltage of the motor: this leads to a reduction in the starting current and of the motor torque, and an increase in the acceleration time.

### Star-Delta starter

The most common reduced voltage starter is the Star-Delta starter (Y- $\Delta$ ), in which:

- on starting, the stator windings are star-connected, thus achieving the reduction of peak inrush current;
- once the normal speed of the motor is nearly reached, the switchover to delta is carried out.

After the switchover, the current and the torque follow the progress of the curves associated with normal service connections (delta).

As can be easily checked, starting the motor with star-connection gives a voltage reduction of  $\sqrt{3}$ , and the current absorbed from the line is reduced by  $1/3$  compared with that absorbed with delta-connection.

The start-up torque, proportional to the square of the voltage, is reduced by 3 times, compared with the torque that the same motor would supply when delta-connected.

This method is generally applied to motors with power from 15 to 355 kW, but intended to start with a low initial resistant torque.

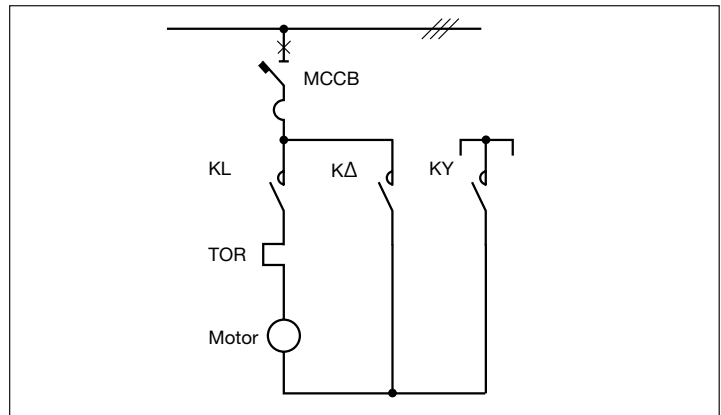

### Starting sequence

By pressing the start button, contactors KL and KY are closed. The timer starts to measure the start time with the motor connected in star. Once the set time has elapsed, the first contact of the timer opens the KY contactor and the second contact, delayed by approximately 50 ms, closes the K $\Delta$  contactor. With this new configuration, contactors KL and K $\Delta$  closed, the motor becomes delta-connected.

## 2 Protection of electrical equipment

The thermal release TOR, inserted in the delta circuit, can detect any 3<sup>rd</sup> harmonic currents, which may occur due to saturation of the magnetic pack and by adding to the fundamental current, overload the motor without involving the line.

With reference to the connection diagram, the equipment used for a Star/Delta starter must be able to carry the following currents:

$$\frac{I_r}{\sqrt{3}} \quad \text{KL line contactor and } K\Delta \text{ delta contactor}$$

$$\frac{I_r}{3} \quad \text{KY star contactor}$$

$$\frac{I_r}{\sqrt{3}} \quad \text{overload protection release}$$

where  $I_r$  is the rated current of the motor.

### Starting with autotransformers

Starting with autotransformers is the most functional of the methods used for reduced voltage starting, but is also the most expensive. The reduction of the supply voltage is achieved by using a fixed tap autotransformer or a more expensive multi tap autotransformer.

Applications can be found with squirrel-cage motors which generally have a power from 50 kW to several hundred kilowatts, and higher power double-cage motors.

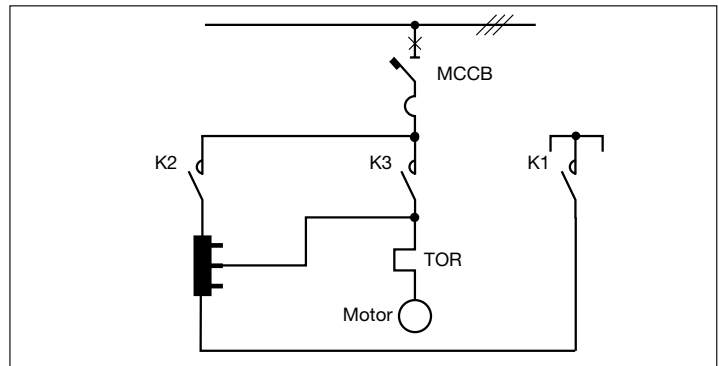

The autotransformer reduces the network voltage by the factor  $K$  ( $K=1.25 \div 1.8$ ), and as a consequence the start-up torque is reduced by  $K^2$  times compared with the value of the full rated voltage.

On starting, the motor is connected to the taps of the autotransformer and the contactors K2 and K1 are closed.

## 2 Protection of electrical equipment

Therefore, the motor starts at a reduced voltage, and when it has reached approximately 80% of its normal speed, contactor K1 is opened and main contactor K3 is closed. Subsequently, contactor K2 is opened, excluding the autotransformer so as to supply the full network voltage.

### Starting with inductive reactors or resistors

This type of starting is used for simple or double-cage rotors. The reduction of the supply voltage is achieved by the insertion of inductive reactors or resistors, in series to the stator. On start-up, the current is limited to 2.5÷3.5 times the rated value.

On starting, the motor is supplied via contactor K2; once the normal speed is reached, the reactors are short-circuited by the closing of contactor K1, and are then excluded by the opening of contactor K2.

It is possible to achieve exclusions by step of the resistors or reactors with time-delayed commands, even for motors with power greater than 100 kW.

The use of reactors notably reduces the power factor, while the use of resistors causes the dissipation of a high power (Joule effect), even if limited to the starting phase.

For a reduction  $K$  ( $0.6\div 0.8$ ) of the motor voltage, the torque is reduced by  $K^2$  times ( $0.36\div 0.64$ ).

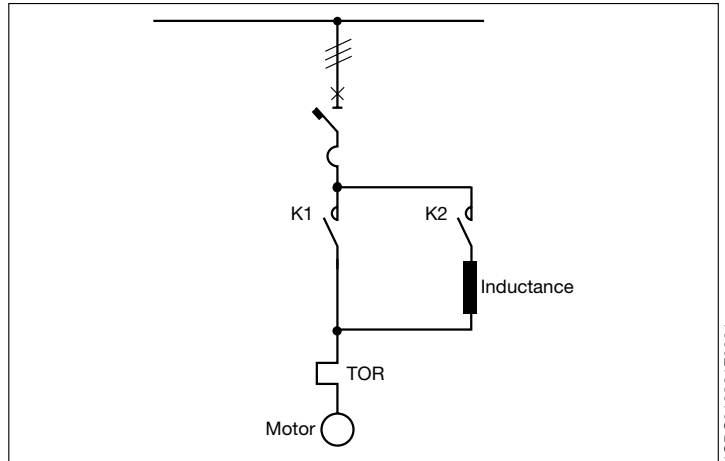

1SDC010021F0001

In compliance with the above mentioned Standard, starters can also be classified according to tripping time (trip classes), and according to the type of coordination achieved with the short-circuit protection device (Type 1 and Type 2).

## 2 Protection of electrical equipment

### Trip classes

The trip classes differentiate between the thermal releases according to their trip curve.

The trip classes are defined in the following table 2:

**Table 2: Trip class**

Trip Class	Tripping time in seconds ( $T_p$ )
10A	$2 < T_p \leq 10$
10	$4 < T_p \leq 10$
20	$6 < T_p \leq 20$
30	$9 < T_p \leq 30$

where  $T_p$  is the cold trip time of the thermal release at 7.2 times the set current value (for example: a release in class 10 at 7.2 times the set current value must not trip within 4 s, but must trip within 10 s).

It is normal procedure to associate class 10 with a normal start-up type, and class 30 with a heavy duty start-up type.

### Coordination type

#### Type 1

It is acceptable that in the case of short-circuit the contactor and the thermal release may be damaged. The starter may still not be able to function and must be inspected; if necessary, the contactor and/or the thermal release must be replaced, and the breaker release reset.

#### Type 2

In the case of short-circuit, the thermal release must not be damaged, while the welding of the contactor contacts is allowed, as they can easily be separated (with a screwdriver, for example), without any significant deformation.

In order to clearly determine a coordination type, and therefore the equipment necessary to achieve it, the following must be known:

- power of the motor in kW and type;
- rated system voltage;
- rated motor current;
- short-circuit current at installation point;
- starting type: DOL or Y/ $\Delta$  - normal or heavy duty – Type 1 or Type 2.

The requested devices shall be coordinated with each other in accordance with the prescriptions of the Standard.

For the most common voltages and short-circuit values (400 V - 440 V - 500 V - 690 V 35 kA - 50 kA) and for the most frequently used starting types, such as direct starting and Star/Delta starting, for asynchronous squirrel-cage motor (AC-3), ABB supplies solutions with:

- magnetic circuit-breaker - contactor - thermal release;
- thermomagnetic circuit-breaker - contactor;
- circuit-breaker with Ekip M LIU-LRIU or PR222MP electronic release - contactor.

## 2 Protection of electrical equipment

The following is an example of the type of tables available:

**Table 3: 400 V 35 kA DOL Normal Type 2  
(Tmax XT/T – Contactor – TOR/EOL)**

Motor		Moulded Case Circuit Breaker		Contactor	Overload Relay		
Rated Power [kW]	Rated Current [A]	Type	I <sub>3</sub> [A]	Type	Type	Current setting range [A]	
						min	max
0,37	1,1	XT2N160 MF 2	28	A9	TA25DU1.4	1	1,4
0,55	1,5	XT2N160 MF 2	28	A9	TA25DU1.8	1,3	1,8
0,75	1,9	XT2N160 MF 2	28	A9	TA25DU2.4	1,7	2,4
1,1	2,7	XT2N160 MF 4	56	A9	TA25DU4	2,8	4
1,5	3,6	XT2N160 MF 4	56	A16	TA25DU5	3,5	5
2,2	4,9	XT2N160 MF 8.5	120	A26	TA25DU6.5	4,5	6,5
3	6,5	XT2N160 MF 8.5	120	A26	TA25DU8.5	6	8,5
4	8,5	XT2N160 MF 12.5	175	A30	TA25DU11	7,5	11
5,5	11,5	XT2N160 MF 12.5	175	A30	TA25DU14	10	14
7,5	15,5	XT2N160 MA 20	210	A30	TA25DU19	13	19
11	22	XT2N160 MA 32	288	A30	TA42DU25	18	25
15	29	XT2N160 MA 52	392	A50	TA75DU42	29	42
18,5	35	XT2N160 MA 52	469	A50	TA75DU52	36	52
22	41	XT2N160 MA 52	547	A50	TA75DU52	36	52
30	55	XT2N160 MA 80	840	A63	TA75DU80	60	80
37	66	XT2N160 MA 80	960	A75	TA75DU80	60	80
45	80	XT2N160 MA 100	1200	A95	TA110DU110	80	110
55	97	XT3N250 MA 160	1440	A110	TA110DU110	80	110
75	132	XT3N250 MA 200	1800	A145	TA200DU175	130	175
90	160	XT3N250 MA 200	2400	A185	TA200DU200	150	200
110	195	T4N320 PR221-I In320	2720	A210	E320DU320	100	320
132	230	T5N400 PR221-I In400	3200	A260	E320DU320	100	320
160	280	T5N400 PR221-I In400	4000	A300	E320DU320	100	320
200	350	T5N630 PR221-I In630	5040	AF400	E500DU500	150	500
250	430	T6N630 PR221-I In630	6300	AF460	E500DU500	150	500
290	520	T6N800 PR221-I In800	7200	AF580	E800DU800	250	800
315	540	T6N800 PR221-I In800	8000	AF580	E800DU800	250	800
355	610	T6N800 PR221-I In800	8000	AF750	E800DU800	250	800

MA: magnetic only adjustable release

MF: fixed magnetic only release

## 2 Protection of electrical equipment

**Table 4: 400 V 50 kA DOL Normal Type 2  
(Tmax XT/T – Contactor – TOR/EOL)**

Motor		Moulded Case Circuit Breaker		Contactor	Overload Relay		
Rated Power [kW]	Rated Current [A]	Type	I <sub>3</sub> [A]	Type	Type	Current setting range [A]	
						min	max
0,37	1,1	XT2S160 MF 2	28	A9	TA25DU1.4	1	1,4
0,55	1,5	XT2S160 MF 2	28	A9	TA25DU1.8	1,3	1,8
0,75	1,9	XT2S160 MF 2	28	A9	TA25DU2.4	1,7	2,4
1,1	2,7	XT2S160 MF 4	56	A9	TA25DU4	2,8	4
1,5	3,6	XT2S160 MF 4	56	A16	TA25DU5	3,5	5
2,2	4,9	XT2S160 MF 8.5	120	A26	TA25DU6.5	4,5	6,5
3	6,5	XT2S160 MF 8.5	120	A26	TA25DU8.5	6	8,5
4	8,5	XT2S160 MF 12.5	175	A30	TA25DU11	7,5	11
5,5	11,5	XT2S160 MF 12.5	175	A30	TA25DU14	10	14
7,5	15,5	XT2S160 MA 20	210	A30	TA25DU19	13	19
11	22	XT2S160 MA 32	288	A30	TA42DU25	18	25
15	29	XT2S160 MA 52	392	A50	TA75DU42	29	42
18,5	35	XT2S160 MA 52	469	A50	TA75DU52	36	52
22	41	XT2S160 MA 52	547	A50	TA75DU52	36	52
30	55	XT2S160 MA 80	840	A63	TA75DU80	60	80
37	66	XT2S160 MA 80	960	A75	TA75DU80	60	80
45	80	XT2S160 MA 100	1200	A95	TA110DU110	80	110
55	97	XT3S250 MA 160	1440	A110	TA110DU110	80	110
75	132	XT3S250 MA 200	1800	A145	TA200DU175	130	175
90	160	XT3S250 MA 200	2400	A185	TA200DU200	150	200
110	195	T4S320 PR221-I In320	2720	A210	E320DU320	100	320
132	230	T5S400 PR221-I In400	3200	A260	E320DU320	100	320
160	280	T5S400 PR221-I In400	4000	A300	E320DU320	100	320
200	350	T5S630 PR221-I In630	5040	AF400	E500DU500	150	500
250	430	T6S630 PR221-I In630	6300	AF460	E500DU500	150	500
290	520	T6S800 PR221-I In800	7200	AF580	E800DU800	250	800
315	540	T6S800 PR221-I In800	8000	AF580	E800DU800	250	800
355	610	T6S800 PR221-I In800	8000	AF750	E800DU800	250	800

MA: magnetic only adjustable release

MF: fixed magnetic only release



## 2 Protection of electrical equipment

**Table 5: 400 V 70 kA DOL Normal Type 2  
(T<sub>max</sub> XT/T – Contactor – TOR/EOL)**

Motor		Moulded Case Circuit Breaker		Contactor	Overload Relay		
Rated Power [kW]	Rated Current [A]	Type	I <sub>3</sub> [A]	Type	Type	Current setting range [A]	
						min	max
0,37	1,1	XT2H160 MF 2	28	A9	TA25DU1.4	1	1,4
0,55	1,5	XT2H160 MF 2	28	A9	TA25DU1.8	1,3	1,8
0,75	1,9	XT2H160 MF 2	28	A9	TA25DU2.4	1,7	2,4
1,1	2,7	XT2H160 MF 4	56	A16	TA25DU4	2,8	4
1,5	3,6	XT2H160 MF 4	56	A26	TA25DU5	3,5	5
2,2	4,9	XT2H160 MF 8.5	120	A26	TA25DU6.5	4,5	6,5
3	6,5	XT2H160 MF 8.5	120	A26	TA25DU8.5	6	8,5
4	8,5	XT2H160 MF 12.5	175	A30	TA25DU11	7,5	11
5,5	11,5	XT2H160 MF 12.5	175	A50	TA25DU14	10	14
7,5	15,5	XT2H160 MA 20	210	A50	TA25DU19	13	19
11	22	XT2H160 MA 32	288	A50	TA42DU25	18	25
15	29	XT2H160 MA 52	392	A50	TA75DU42	29	42
18,5	35	XT2H160 MA 52	469	A50	TA75DU52	36	52
22	41	XT2H160 MA 52	547	A50	TA75DU52	36	52
30	55	XT2H160 MA 80	840	A63	TA75DU80	60	80
37	66	XT2H160 MA 80	960	A75	TA75DU80	60	80
45	80	XT2H160 MA 100	1200	A95	TA110DU110	80	110
55	97	XT4H250 Ekip-I In160	1360	A110	TA110DU110	80	110
75	132	XT4H250 Ekip-I In250	1875	A145	E200DU200	60	200
90	160	XT4H250 Ekip-I In250	2500	A185	E200DU200	60	200
110	195	T4H320 PR221-I In320	2720	A210	E320DU320	100	320
132	230	T5H400 PR221-I In400	3200	A260	E320DU320	100	320
160	280	T5H400 PR221-I In400	4000	A300	E320DU320	100	320
200	350	T5H630 PR221-I In630	5040	AF400	E500DU500	150	500
250	430	T6H630 PR221-I In630	6300	AF460	E500DU500	150	500
290	520	T6H800 PR221-I In800	7200	AF580	E800DU800	250	800
315	540	T6H800 PR221-I In800	8000	AF580	E800DU800	250	800
355	610	T6H800 PR221-I In800	8000	AF750	E800DU800	250	800

MA: magnetic only adjustable release

MF: fixed magnetic only release

## 2 Protection of electrical equipment

**Table 6: 400 V 80 kA DOL Normal Type 2  
(Tmax XT/T – Contactor – TOR/EOL)**

Motor		Moulded Case Circuit Breaker		Contactor	Overload Relay		
Rated Power [kW]	Rated Current [A]	Type	I <sub>3</sub> [A]	Type	Type	Current setting range [A]	
						min	max
0,37	1,1	XT2L160 MF 2	28	A9	TA25DU1.4	1	1,4
0,55	1,5	XT2L160 MF 2	28	A9	TA25DU1.8	1,3	1,8
0,75	1,9	XT2L160 MF 2	28	A9	TA25DU2.4	1,7	2,4
1,1	2,7	XT2L160 MF 4	56	A16	TA25DU4	2,8	4
1,5	3,6	XT2L160 MF 4	56	A26	TA25DU5	3,5	5
2,2	4,9	XT2L160 MF 8.5	120	A26	TA25DU6.5	4,5	6,5
3	6,5	XT2L160 MF 8.5	120	A26	TA25DU8.5	6	8,5
4	8,5	XT2L160 MF 12.5	175	A30	TA25DU11	7,5	11
5,5	11,5	XT2L160 MF 12.5	175	A50	TA25DU14	10	14
7,5	15,5	XT2L160 MA 20	210	A50	TA25DU19	13	19
11	22	XT2L160 MA 32	288	A50	TA42DU25	18	25
15	29	XT2L160 MA 52	392	A50	TA75DU42	29	42
18,5	35	XT2L160 MA 52	469	A50	TA75DU52	36	52
22	41	XT2L160 MA 52	547	A50	TA75DU52	36	52
30	55	XT2L160 MA 80	840	A63	TA75DU80	60	80
37	66	XT2L160 MA 80	960	A75	TA75DU80	60	80
45	80	XT2L160 MA 100	1200	A95	TA110DU110	80	110
55	97	XT4L250 Ekip-I In160	1360	A110	TA110DU110	80	110
75	132	XT4L250 Ekip-I In250	1875	A145	E200DU200	60	200
90	160	XT4L250 Ekip-I In250	2500	A185	E200DU200	60	200
110	195	T4L320 PR221-I In320	2720	A210	E320DU320	100	320
132	230	T5L400 PR221-I In400	3200	A260	E320DU320	100	320
160	280	T5L400 PR221-I In400	4000	A300	E320DU320	100	320
200	350	T5L630 PR221-I In630	5040	AF400	E500DU500	150	500
250	430	T6L630 PR221-I In630	6300	AF460	E500DU500	150	500
290	520	T6L800 PR221-I In800	7200	AF580	E800DU800	250	800
315	540	T6L800 PR221-I In800	8000	AF580	E800DU800	250	800
355	610	T6L800 PR221-I In800	8000	AF750	E800DU800	250	800

MA: magnetic only adjustable release

MF: fixed magnetic only release

## 2 Protection of electrical equipment

**Table 7: 400 V 35 kA DOL Normal Type 2  
(Tmax XT/T – Contactor – EOL)**

Motor		Moulded Case Circuit Breaker		Contactor	Overload Relay		
Rated Power [kW]	Rated Current [A]	Type	I <sub>3</sub> [A]	Type	Type	Current setting range [A]	
						min	max
0,37	1,1	XT2N160 MF 2	28	A9	E16DU2.7	0,9	2,7
0,55	1,5	XT2N160 MF 2	28	A9	E16DU2.7	0,9	2,7
0,75	1,9	XT2N160 MF 2	28	A9	E16DU2.7	0,9	2,7
1,1	2,7	XT2N160 MF 4	56	A9	E16DU6.3	2	6,3
1,5	3,6	XT2N160 MF 4	56	A16	E16DU6.3	2	6,3
2,2	4,9	XT2N160 MF 8.5	120	A26	E16DU6.3	2	6,3
3	6,5	XT2N160 MF 8.5	120	A26	E16DU18.9	5,7	18,9
4	8,5	XT2N160 MF 12.5	175	A30	E16DU18.9	5,7	18,9
5,5	11,5	XT2N160 MF 12.5	175	A30	E16DU18.9	5,7	18,9
7,5	15,5	XT2N160 MA 20	210	A30	E16DU18.9	5,7	18,9
11	22	XT2N160 MA 32	288	A30	E45DU45	15	45
15	29	XT2N160 MA 52	392	A50	E45DU45	15	45
18,5	35	XT2N160 MA 52	469	A50	E80DU80	27	80
22	41	XT2N160 MA 52	547	A50	E80DU80	27	80
30	55	XT2N160 MA 80	840	A63	E80DU80	27	80
37	66	XT2N160 MA 80	960	A75	E80DU80	27	80
45	80	XT2N160 MA 100	1200	A95	E140DU140	50	140
55	97	XT3N250 MA 160	1440	A110	E200DU200	60	200
75	132	XT3N250 MA 200	1800	A145	E200DU200	60	200
90	160	XT3N250 MA 200	2400	A185	E200DU200	60	200
110	195	T4N320 PR221-I In320	2720	A210	E320DU320	100	320
132	230	T5N400 PR221-I In400	3200	A260	E320DU320	100	320
160	280	T5N400 PR221-I In400	4000	A300	E320DU320	100	320
200	350	T5N630 PR221-I In630	5040	AF400	E500DU500	150	500
250	430	T6N630 PR221-I In630	6300	AF460	E500DU500	150	500
290	520	T6N800 PR221-I In800	7200	AF580	E800DU800	250	800
315	540	T6N800 PR221-I In800	8000	AF580	E800DU800	250	800
355	610	T6N800 PR221-I In800	8000	AF750	E800DU800	250	800

## 2 Protection of electrical equipment

**Table 8: 400 V 50 kA DOL Normal Type 2  
(Tmax XT/T – Contactor – EOL)**

Motor		Moulded Case Circuit Breaker		Contactor	Overload Relay		
Rated Power [kW]	Rated Current [A]	Type	I <sub>3</sub> [A]	Type	Type	Current setting range [A]	
						min	max
0,37	1,1	XT2S160 MF 2	28	A9	E16DU2.7	0,9	2,7
0,55	1,5	XT2S160 MF 2	28	A9	E16DU2.7	0,9	2,7
0,75	1,9	XT2S160 MF 2	28	A9	E16DU2.7	0,9	2,7
1,1	2,7	XT2S160 MF 4	56	A9	E16DU6.3	2	6,3
1,5	3,6	XT2S160 MF 4	56	A16	E16DU6.3	2	6,3
2,2	4,9	XT2S160 MF 8.5	120	A26	E16DU6.3	2	6,3
3	6,5	XT2S160 MF 8.5	120	A26	E16DU18.9	5,7	18,9
4	8,5	XT2S160 MF 12.5	175	A30	E16DU18.9	5,7	18,9
5,5	11,5	XT2S160 MF 12.5	175	A30	E16DU18.9	5,7	18,9
7,5	15,5	XT2S160 MA 20	210	A30	E16DU18.9	5,7	18,9
11	22	XT2S160 MA 32	288	A30	E45DU45	15	45
15	29	XT2S160 MA 52	392	A50	E45DU45	15	45
18,5	35	XT2S160 MA 52	469	A50	E80DU80	27	80
22	41	XT2S160 MA 52	547	A50	E80DU80	27	80
30	55	XT2S160 MA 80	840	A63	E80DU80	27	80
37	66	XT2S160 MA 80	960	A75	E80DU80	27	80
45	80	XT2S160 MA 100	1200	A95	E140DU140	50	140
55	97	XT3S250 MA 160	1440	A110	E200DU200	60	200
75	132	XT3S250 MA 200	1800	A145	E200DU200	60	200
90	160	XT3S250 MA 200	2400	A185	E200DU200	60	200
110	195	T4S320 PR221-I In320	2720	A210	E320DU320	100	320
132	230	T5S400 PR221-I In400	3200	A260	E320DU320	100	320
160	280	T5S400 PR221-I In400	4000	A300	E320DU320	100	320
200	350	T5S630 PR221-I In630	5040	AF400	E500DU500	150	500
250	430	T6S630 PR221-I In630	6300	AF460	E500DU500	150	500
290	520	T6S800 PR221-I In800	7200	AF580	E800DU800	250	800
315	540	T6S800 PR221-I In800	8000	AF580	E800DU800	250	800
355	610	T6S800 PR221-I In800	8000	AF750	E800DU800	250	800

## 2 Protection of electrical equipment

**Table 9: 400 V 70 kA DOL Normal Type 2  
(Tmax XT/T – Contactor – EOL)**

Motor		Moulded Case Circuit Breaker		Contactor	Overload Relay		
Rated Power [kW]	Rated Current [A]	Type	I <sub>3</sub> [A]	Type	Type	Current setting range [A]	
						min	max
0,37	1,1	XT2H160 MF 2	28	A9	E16DU2.7	0,9	2,7
0,55	1,5	XT2H160 MF 2	28	A9	E16DU2.7	0,9	2,7
0,75	1,9	XT2H160 MF 2	28	A9	E16DU2.7	0,9	2,7
1,1	2,7	XT2H160 MF 4	56	A16	E16DU6.3	2	6,3
1,5	3,6	XT2H160 MF 4	56	A26	E16DU6.3	2	6,3
2,2	4,9	XT2H160 MF 8.5	120	A26	E16DU6.3	2	6,3
3	6,5	XT2H160 MF 8.5	120	A26	E16DU18.9	5,7	18,9
4	8,5	XT2H160 MF 12.5	175	A30	E16DU18.9	5,7	18,9
5,5	11,5	XT2H160 MF 12.5	175	A50	E16DU18.9	5,7	18,9
7,5	15,5	XT2H160 MA 20	210	A50	E16DU18.9	5,7	18,9
11	22	XT2H160 MA 32	288	A50	E45DU45	15	45
15	29	XT2H160 MA 52	392	A50	E45DU45	15	45
18,5	35	XT2H160 MA 52	469	A50	E80DU80	27	80
22	41	XT2H160 MA 52	547	A50	E80DU80	27	80
30	55	XT2H160 MA 80	840	A63	E80DU80	27	80
37	66	XT2H160 MA 80	960	A75	E80DU80	27	80
45	80	XT2H160 MA 100	1200	A95	E140DU140	50	140
55	97	XT4H250 Ekip-I In160	1360	A110	E200DU200	60	200
75	132	XT4H250 Ekip-I In250	1875	A145	E200DU200	60	200
90	160	XT4H250 Ekip-I In250	2500	A185	E200DU200	60	200
110	195	T4H320 PR221-I In320	2720	A210	E320DU320	100	320
132	230	T5H400 PR221-I In400	3200	A260	E320DU320	100	320
160	280	T5H400 PR221-I In400	4000	A300	E320DU320	100	320
200	350	T5H630 PR221-I In630	5040	AF400	E500DU500	150	500
250	430	T6H630 PR221-I In630	6300	AF460	E500DU500	150	500
290	520	T6H800 PR221-I In800	7200	AF580	E800DU800	250	800
315	540	T6H800 PR221-I In800	8000	AF580	E800DU800	250	800
355	610	T6H800 PR221-I In800	8000	AF750	E800DU800	250	800

## 2 Protection of electrical equipment

**Table 10: 400 V 80 kA DOL Normal Type 2  
(Tmax XT/T – Contactor – EOL)**

Motor		Moulded Case Circuit Breaker		Contactor	Overload Relay		
Rated Power [kW]	Rated Current [A]	Type	I <sub>3</sub> [A]	Type	Type	Current setting range [A]	
						min	max
0,37	1,1	XT2L160 MF 2	28	A9	E16DU2.7	0,9	2,7
0,55	1,5	XT2L160 MF 2	28	A9	E16DU2.7	0,9	2,7
0,75	1,9	XT2L160 MF 2	28	A9	E16DU2.7	0,9	2,7
1,1	2,7	XT2L160 MF 4	56	A16	E16DU6.3	2	6,3
1,5	3,6	XT2L160 MF 4	56	A26	E16DU6.3	2	6,3
2,2	4,9	XT2L160 MF 8.5	120	A26	E16DU6.3	2	6,3
3	6,5	XT2L160 MF 8.5	120	A26	E16DU18.9	5,7	18,9
4	8,5	XT2L160 MF 12.5	175	A30	E16DU18.9	5,7	18,9
5,5	11,5	XT2L160 MF 12.5	175	A50	E16DU18.9	5,7	18,9
7,5	15,5	XT2L160 MA 20	210	A50	E16DU18.9	5,7	18,9
11	22	XT2L160 MA 32	288	A50	E45DU45	15	45
15	29	XT2L160 MA 52	392	A50	E45DU45	15	45
18,5	35	XT2L160 MA 52	469	A50	E80DU80	27	80
22	41	XT2L160 MA 52	547	A50	E80DU80	27	80
30	55	XT2L160 MA 80	840	A63	E80DU80	27	80
37	66	XT2L160 MA 80	960	A75	E80DU80	27	80
45	80	XT2L160 MA 100	1200	A95	E140DU140	50	140
55	97	XT4L250 Ekip-I In160	1360	A110	E200DU200	60	200
75	132	XT4L250 Ekip-I In250	1875	A145	E200DU200	60	200
90	160	XT4L250 Ekip-I In250	2500	A185	E200DU200	60	200
110	195	T4L320 PR221-I In320	2720	A210	E320DU320	100	320
132	230	T5L400 PR221-I In400	3200	A260	E320DU320	100	320
160	280	T5L400 PR221-I In400	4000	A300	E320DU320	100	320
200	350	T5L630 PR221-I In630	5040	AF400	E500DU500	150	500
250	430	T6L630 PR221-I In630	6300	AF460	E500DU500	150	500
290	520	T6L800 PR221-I In800	7200	AF580	E800DU800	250	800
315	540	T6L800 PR221-I In800	8000	AF580	E800DU800	250	800
355	610	T6L800 PR221-I In800	8000	AF750	E800DU800	250	800

## 2 Protection of electrical equipment

**Table 11: 440 V 50 kA DOL Normal Type 2  
(Tmax XT/T – Contactor – TOR/EOL)**

Motor		Moulded Case Circuit Breaker		Contactor	Overload Relay		
Rated Power [kW]	Rated Current [A]	Type	I <sub>3</sub> [A]	Type	Type	Current setting range [A]	
						min	max
0,37	1	XT2S160 MF 1	14	A9	TA25DU1.4	1	1,4
0,55	1,3	XT2S160 MF 2	28	A9	TA25DU1.8	1,3	1,8
0,75	1,7	XT2S160 MF 2	28	A9	TA25DU2.4	1,7	2,4
1,1	2,4	XT2S160 MF 4	56	A9	TA25DU3.1	2,2	3,1
1,5	3,2	XT2S160 MF 4	56	A16	TA25DU4	2,8	4
2,2	4,3	XT2S160 MF 8.5	120	A26	TA25DU5	3,5	5
3	5,7	XT2S160 MF 8.5	120	A26	TA25DU6.5	4,5	6,5
4	7,4	XT2S160 MF 8.5	120	A30	TA25DU11	7,5	11
5,5	10,1	XT2S160 MF 12	175	A30	TA25DU14	10	14
7,5	13,6	XT2S160 MA 20	180	A30	TA25DU19	13	19
11	19,3	XT2S160 MA 32	240	A30	TA42DU25	18	25
15	25,4	XT2S160 MA 32	336	A50	TA75DU32	22	32
18,5	30,7	XT2S160 MA 52	469	A50	TA75DU42	29	42
22	35,9	XT2S160 MA 52	547	A50	TA75DU52	36	52
30	48,2	XT2S160 MA 80	720	A63	TA75DU63	45	63
37	58	XT2S160 MA 80	840	A75	TA75DU80	60	80
45	70	XT2S160 MA 100	1050	A95	TA110DU90	65	90
55	85	XT4S250 Ekip-I In160	1200	A110	TA110DU110	80	110
75	116	XT4S250 Ekip-I In250	1750	A145	E200DU200	60	200
90	140	XT4S250 Ekip-I In250	2000	A185	E200DU200	60	200
110	171	XT4S250 Ekip-I In250	2500	A210	E320DU320	100	320
132	202	T5H400 PR221-I In320	3200	A260	E320DU320	100	320
160	245	T5H400 PR221-I In400	3600	A300	E320DU320	100	320
200	307	T5H630 PR221-I In630	4410	AF 400	E500DU500	150	500
250	377	T6H630 PR221-I In630	5355	AF 460	E500DU500	150	500
290	448	T6H630 PR221-I In630	6300	AF 580	E500DU500*	150	500
315	473	T6H800 PR221-I In800	7200	AF 580	E800DU800	250	800
355	535	T6H800 PR221-I In800	8000	AF 580	E800DU800	250	800

(\*) Connection kit not available. To use connection kit provide E800DU800

MA: magnetic only adjustable release

MF: fixed magnetic only release

## 2 Protection of electrical equipment

**Table 12: 440 V 65 kA DOL Normal Type 2  
(Tmax XT/T – Contactor – TOR/EOL)**

Motor		Moulded Case Circuit Breaker		Contactor	Overload Relay		
Rated Power [kW]	Rated Current [A]	Type	$I_3$ [A]	Type	Type	Current setting range [A]	
						min	max
0,37	1	XT2H160 MF 1	14	A9	TA25DU1.4	1	1,4
0,55	1,3	XT2H160 MF 2	28	A9	TA25DU1.8	1,3	1,8
0,75	1,7	XT2H160 MF 2	28	A9	TA25DU2.4	1,7	2,4
1,1	2,4	XT2H160 MF 4	56	A16	TA25DU3.1	2,2	3,1
1,5	3,2	XT2H160 MF 4	56	A16	TA25DU4	2,8	4
2,2	4,3	XT2H160 MF 8.5	120	A26	TA25DU5	3,5	5
3	5,7	XT2H160 MF 8.5	120	A30	TA25DU6.5	4,5	6,5
4	7,4	XT2H160 MF 8.5	120	A30	TA25DU11	7,5	11
5,5	10,1	XT2H160 MF 12.5	175	A30	TA25DU14	10	14
7,5	13,6	XT2H160 MA 20	180	A30	TA25DU19	13	19
11	19,3	XT2H160 MA 32	240	A50	TA42DU25	18	25
15	25,4	XT2H160 MA 32	336	A50	TA75DU32	22	32
18,5	30,7	XT2H160 MA 52	469	A50	TA75DU42	29	42
22	35,9	XT2H160 MA 52	547	A50	TA75DU52	36	52
30	48,2	XT2H160 MA 80	720	A63	TA75DU63	45	63
37	58	XT2H160 MA 80	840	A75	TA75DU80	60	80
45	70	XT2H160 MA 100	1050	A95	TA110DU90	65	90
55	85	XT4H250 Ekip-I In160	1200	A110	TA110DU110	80	110
75	116	XT4H250 Ekip-I In250	1750	A145	E200DU200	60	200
90	140	XT4H250 Ekip-I In250	2000	A185	E200DU200	60	200
110	171	XT4H250 Ekip-I In250	2500	A210	E320DU320	100	320
132	202	T5H400 PR221-I In320	3200	A260	E320DU320	100	320
160	245	T5H400 PR221-I In400	3600	A300	E320DU320	100	320
200	307	T5H630 PR221-I In630	4410	AF 400	E500DU500	150	500
250	377	T6L630 PR221-I In630	5355	AF 460	E500DU500	150	500
290	448	T6L630 PR221-I In630	6300	AF 580	E500DU500*	150	500
315	473	T6L800 PR221-I In800	7200	AF 580	E800DU800	250	800
355	535	T6L800 PR221-I In800	8000	AF 580	E800DU800	250	800

(\*) Connection kit not available. To use connection kit provide E800DU800

MA: magnetic only adjustable release

MF: fixed magnetic only release



## 2 Protection of electrical equipment

**Table 13: 440 V 50 kA DOL Normal Type 2  
(Tmax XT/T – Contactor – EOL)**

Motor		Moulded Case Circuit Breaker		Contactor	Overload Relay		
Rated Power [kW]	Rated Current [A]	Type	I <sub>3</sub> [A]	Type	Type	Current setting range [A]	
						min	max
0,37	1	XT2S160 MF 1	14	A9	E16DU2.7	0,9	2,7
0,55	1,3	XT2S160 MF 2	28	A9	E16DU2.7	0,9	2,7
0,75	1,7	XT2S160 MF 2	28	A9	E16DU2.7	0,9	2,7
1,1	2,4	XT2S160 MF 4	56	A9	E16DU2.7	0,9	2,7
1,5	3,2	XT2S160 MF 4	56	A16	E16DU6.3	2	6,3
2,2	4,3	XT2S160 MF 8.5	120	A26	E16DU6.3	2	6,3
3	5,7	XT2S160 MF 8.5	120	A26	E16DU6.3	2	6,3
4	7,4	XT2S160 MF 8.5	120	A30	E16DU18.9	5,7	18,9
5,5	10,1	XT2S160 MF 12	175	A30	E16DU18.9	5,7	18,9
7,5	13,6	XT2S160 MA 20	180	A30	E16DU18.9	5,7	18,9
11	19,3	XT2S160 MA 32	240	A30	E45DU45	15	45
15	25,4	XT2S160 MA 32	336	A50	E45DU45	15	45
18,5	30,7	XT2S160 MA 52	469	A50	E45DU45	15	45
22	35,9	XT2S160 MA 52	547	A50	E45DU45	15	45
30	48,2	XT2S160 MA 80	720	A63	E80DU80	27	80
37	58	XT2S160 MA 80	840	A75	E80DU80	27	80
45	70	XT2S160 MA 100	1050	A95	E140DU140	50	140
55	85	XT4S250 Ekip-I In160	1200	A110	E200DU200	60	200
75	116	XT4S250 Ekip-I In250	1750	A145	E200DU200	60	200
90	140	XT4S250 Ekip-I In250	2000	A185	E200DU200	60	200
110	171	XT4S250 Ekip-I In250	2500	A210	E320DU320	100	320
132	202	T5H400 PR221-I In320	3200	A260	E320DU320	100	320
160	245	T5H400 PR221-I In400	3600	A300	E320DU320	100	320
200	307	T5H630 PR221-I In630	4410	AF 400	E500DU500	150	500
250	377	T6H630 PR221-I In630	5355	AF 460	E500DU500	150	500
290	448	T6H630 PR221-I In630	7560	AF 580	E800DU800	250	800
315	473	T6H800 PR221-I In800	8000	AF 580	E800DU800	250	800
355	535	T6H800 PR221-I In800	9600	AF 580	E800DU800	250	800

## 2 Protection of electrical equipment

**Table 14: 440 V 65 kA DOL Normal Type 2  
(Tmax XT/T – Contactor – EOL)**

Motor		Moulded Case Circuit Breaker		Contactor	Overload Relay		
Rated Power [kW]	Rated Current [A]	Type	I <sub>3</sub> [A]	Type	Type	Current setting range [A]	
						min	max
0,37	1	XT2H160 MF 1	14	A9	E16DU2.7	0,9	2,7
0,55	1,3	XT2H160 MF 2	28	A9	E16DU2.7	0,9	2,7
0,75	1,7	XT2H160 MF 2	28	A9	E16DU2.7	0,9	2,7
1,1	2,4	XT2H160 MF 4	56	A16	E16DU2.7	0,9	2,7
1,5	3,2	XT2H160 MF 4	56	A16	E16DU6.3	2	6,3
2,2	4,3	XT2H160 MF 8.5	120	A26	E16DU6.3	2	6,3
3	5,7	XT2H160 MF 8.5	120	A30	E16DU6.3	2	6,3
4	7,4	XT2H160 MF 8.5	120	A30	E16DU18.9	5,7	18,9
5,5	10,1	XT2H160 MF 12.5	175	A30	E16DU18.9	5,7	18,9
7,5	13,6	XT2H160 MA 20	180	A30	E16DU18.9	5,7	18,9
11	19,3	XT2H160 MA 32	240	A50	E45DU45	15	45
15	25,4	XT2H160 MA 32	336	A50	E45DU45	15	45
18,5	30,7	XT2H160 MA 52	469	A50	E45DU45	15	45
22	35,9	XT2H160 MA 52	547	A50	E45DU45	15	45
30	48,2	XT2H160 MA 80	720	A63	E80DU80	27	80
37	58	XT2H160 MA 80	840	A75	E80DU80	27	80
45	70	XT2H160 MA 100	1050	A95	E140DU140	50	140
55	85	XT4H250 Ekip-I In160	1200	A110	E200DU200	60	200
75	116	XT4H250 Ekip-I In250	1750	A145	E200DU200	60	200
90	140	XT4H250 Ekip-I In250	2000	A185	E200DU200	60	200
110	171	XT4H250 Ekip-I In250	2500	A210	E320DU320	100	320
132	202	T5H400 PR221-I In320	3200	A260	E320DU320	100	320
160	245	T5H400 PR221-I In400	3600	A300	E320DU320	100	320
200	307	T5H630 PR221-I In630	4410	AF 400	E500DU500	150	500
250	377	T6L630 PR221-I In630	5355	AF 460	E500DU500	150	500
290	448	T6L630 PR221-I In630	6300	AF 580	E800DU800	250	800
315	473	T6L800 PR221-I In800	7200	AF 580	E800DU800	250	800
355	535	T6L800 PR221-I In800	8000	AF 580	E800DU800	250	800

## 2 Protection of electrical equipment

**Table 15: 500 V 50 kA DOL Normal Type 2  
(Tmax XT/T – Contactor – TOR/EOL)**

Motor		Moulded Case Circuit Breaker		Contactor	Overload Relay		
Rated Power [kW]	Rated Current [A]	Type	I <sub>3</sub> [A]	Type	Type	Current setting range [A]	
						min	max
0,37	0,88	XT2H160 MF 1	14	A9	TA25DU1.0	0,63	1
0,55	1,2	XT2H160 MF 2	28	A9	TA25DU1.4	1	1,4
0,75	1,5	XT2H160 MF 2	28	A9	TA25DU1.8	1,3	1,8
1,1	2,2	XT2H160 MF 4	56	A9	TA25DU3.1	2,2	3,1
1,5	2,8	XT2H160 MF 4	56	A16	TA25DU4	2,8	4
2,2	3,9	XT2H160 MF 8.5	120	A26	TA25DU5	3,5	5
3	5,2	XT2H160 MF 8.5	120	A26	TA25DU6.5	4,5	6,5
4	6,8	XT2H160 MF 8.5	120	A30	TA25DU8.5	6	8,5
5,5	9,2	XT2H160 MF 12.5	175	A30	TA25DU11	7,5	11
7,5	12,4	XT2H160 MF 12.5	163	A30	TA25DU14	10	14
11	17,6	XT2H160 MA 20	240	A30	TA25DU19	13	19
15	23	XT2H160 MA 32	336	A50	TA75DU25	18	25
18,5	28	XT2H160 MA 52	392	A50	TA75DU32	22	32
22	33	XT2H160 MA 52	469	A50	TA75DU42	29	42
30	44	XT2H160 MA 52	624	A63	TA75DU52	36	52
37	53	XT2H160 MA 80	840	A75	TA75DU63	45	63
45	64	XT2H160 MA 80	960	A95	TA80DU80	60	80
55	78	XT2H160 MA 100	1200	A110	TA110DU90	65	90
75	106	XT4H250 Ekip-I In160	1440	A145	E200DU200	60	200
90	128	XT4H250 Ekip-I In250	1875	A145	E200DU200	60	200
110	156	XT4H250 Ekip-I In250	2250	A185	E200DU200	60	200
132	184	T4H320 PR221-I In320	2720	A210	E320DU320	100	320
160	224	T5H400 PR221-I In400	3600	A260	E320DU320	100	320
200	280	T5H400 PR221-I In400	4000	A300	E320DU320	100	320
250	344	T5H630 PR221-I In630	4725	AF400	E500DU500	150	500
290	394	T6H630 PR221-I In630	5040	AF460	E500DU500	150	500
315	432	T6H630 PR221-I In630	6300	AF580	E500DU500*	150	500
355	488	T6H630 PR221-I In630	6300	AF580	E800DU800	250	800

(\*) Connection kit not available. To use connection kit provide E800DU800

## 2 Protection of electrical equipment

**Table 16: 500 V 50 kA DOL Normal Type 2  
(Tmax XT/T – Contactor – EOL)**

Motor		Moulded Case Circuit Breaker		Contactor	Overload Relay		
Rated Power [kW]	Rated Current [A]	Type	$I_3$ [A]	Type	Type	Current setting range [A]	
						min	max
0,37	0,88	XT2H160 MF 1	14	A9	E16DU2.7	0,9	2,7
0,55	1,2	XT2H160 MF 2	28	A9	E16DU2.7	0,9	2,7
0,75	1,5	XT2H160 MF 2	28	A9	E16DU2.7	0,9	2,7
1,1	2,2	XT2H160 MF 4	56	A9	E16DU2.7	0,9	2,7
1,5	2,8	XT2H160 MF 4	56	A16	E16DU6.3	2	6,3
2,2	3,9	XT2H160 MF 8.5	120	A26	E16DU6.3	2	6,3
3	5,2	XT2H160 MF 8.5	120	A26	E16DU6.3	2	6,3
4	6,8	XT2H160 MF 8.5	120	A30	E16DU18.9	5,7	18,9
5,5	9,2	XT2H160 MF 12.5	175	A30	E16DU18.9	5,7	18,9
7,5	12,4	XT2H160 MF 12.5	163	A50	E16DU18.9	5,7	18,9
11	17,6	XT2H160 MA 20	240	A50	E45DU45	15	45
15	23	XT2H160 MA 32	336	A50	E45DU45	15	45
18,5	28	XT2H160 MA 52	392	A50	E45DU45	15	45
22	33	XT2H160 MA 52	469	A50	E45DU45	15	45
30	44	XT2H160 MA 52	624	A63	E80DU80	27	80
37	53	XT2H160 MA 80	840	A75	E80DU80	27	80
45	64	XT2H160 MA 80	960	A95	E140DU140	50	140
55	78	XT2H160 MA 100	1200	A110	E200DU200	60	200
75	106	XT4H250 Ekip-I In160	1440	A145	E200DU200	60	200
90	128	XT4H250 Ekip-I In250	1875	A145	E200DU200	60	200
110	156	XT4H250 Ekip-I In250	2250	A185	E320DU320	100	320
132	184	T4H320 PR221-I In320	2720	A210	E320DU320	100	320
160	224	T5H400 PR221-I In400	3600	A260	E320DU320	100	320
200	280	T5H400 PR221-I In400	4000	A300	E500DU500	150	500
250	344	T5H630 PR221-I In630	4725	AF400	E500DU500	150	500
290	394	T6H630 PR221-I In630	5040	AF460	E800DU800	250	800
315	432	T6H630 PR221-I In630	6300	AF580	E800DU800	250	800
355	488	T6H630 PR221-I In630	6300	AF580	E800DU800	250	800

## 2 Protection of electrical equipment

**Table 17: 690 V 25 kA DOL Normal Type 2  
(Tmax XT – Contactor – TOR/EOL)**

Motor		Moulded Case Circuit Breaker		Contactor	KORC		Overload Relay		
Rated Power [kW]	Rated Current [A]	Type	I <sub>3</sub> [A]	Type	Type	Number of turns	Type	Current setting range [A]	
								min	max
0,37	0,64	XT2V160 MF 1	14	A9			TA25DU1	0,6	1
0,55	0,87	XT2V160 MF 1	14	A9			TA25DU1	0,6	1
0,75	1,1	XT2V160 MF 2	28	A9			TA25DU1.4	1	1,4
1,1	1,6	XT2V160 MF 2	28	A9			TA25DU1.8	1,3	1,8
1,5	2,1	XT2V160 MF 4	56	A9			TA25DU2.4	1,7	2,4
2,2	2,8	XT2V160 MF 4	56	A9			TA25DU3.1 *	2,2	3,1
3	3,8	XT2V160 MF 4	56	A9			TA25DU4 *	2,8	4
4	4,9	XT2V160 MF 8.5	120	A9			TA25DU5 *	3,5	5
5,5	6,7	XT2V160 MF 8.5	120	A9			TA25DU6.5	6	5
		XT4V250 EKIP-I In 100	150	A95	4L185R/4	13**	TA25DU2.4	6	5
7,5	8,9	XT4V250 EKIP-I In 100	150	A95	4L185R/4	10**	TA25DU2.4	7,9	11,1
11	12,8	XT4V250 EKIP-I In 100	200	A95	4L185R/4	7**	TA25DU2.4	11,2	15,9
15	17	XT4V250 EKIP-I In 100	250	A95	4L185R/4	7**	TA25DU3.1	15,2	20,5
18,5	21	XT4V250 EKIP-I In 100	300	A95	4L185R/4	6	TA25DU3.1	17,7	23,9
22	24	XT4V250 EKIP-I In 100	350	A95	4L185R/4	6	TA25DU4	21,6	30,8
30	32	XT4V250 EKIP-I In 100	450	A145	4L185R/4	6	TA25DU5	27	38,5
37	39	XT4V250 EKIP-I In 100	550	A145	4L185R/4	4	TA25DU4	32,4	46,3
45	47	XT4V250 EKIP-I In 100	700	A145	4L185R/4	4	TA25DU5	40,5	57,8
55	57	XT4V250 EKIP-I In 100	800	A145	4L185R/4	3	TA25DU5	54	77,1
75	77	XT4V250 EKIP-I In 160	1120	A145			E200DU200	65	200
90	93	XT4V250 EKIP-I In 160	1280	A145			E200DU200	65	200
110	113	XT4V250 EKIP-I In 250	1625	A145			E200DU200	65	200
132	134	XT4V250 EKIP-I In 250	2000	A185			E200DU200	65	200
160	162	XT4V250 EKIP-I In 250	2250	A185			E200DU200	65	200

(\*) Type 1 coordination

(\*\*) Cable cross section equal to 4 mm<sup>2</sup>

(\*\*\*) No mounting kit to contactor is available

MA: magnetic only adjustable release

MF: fixed magnetic only release

## 2 Protection of electrical equipment

**Table 18: 690 V 50 kA DOL Normal Type 2  
(Tmax T – Contactor – TOR/EOL)**

Motor		Moulded Case Circuit Breaker		Contactor	KORC		Overload Relay		
Rated Power [kW]	Rated Current [A]	Type	I <sub>3</sub> [A]	Type	Type	Number of turns	Type	Current setting range [A]	
								min	max
0,37	0,64	T2L160 MF1	13	A9			TA25DU1	0,6	1
0,55	0,87	T2L160 MF1	13	A9			TA25DU1	0,6	1
0,75	1,1	T2L160 MF 1.6	21	A9			TA25DU1.4	1	1,4
1,1	1,6	T2L160 MF 1.6	21	A9			TA25DU1.8	1,3	1,8
1,5	2,1	T2L160 MF 2.5	33	A9			TA25DU2.4;	1,7	2,4
2,2	2,8	T2L160 MF 3.2	42	A9			TA25DU3.1 *	2,2	3,1
3	3,8	T2L160 MF 4	52	A9			TA25DU4 *	2,8	4
4	4,9	T2L160 MF 5	65	A9			TA25DU5 *	3,5	5
5,5	6,7	T2L160 MF 6.5	84	A9			TA25DU6.5	4,5	6,5
		T4L250 PR221-I In 100	150	A95	4L185R/4	13**	TA25DU2.4	6	8,5
7,5	8,9	T4L250 PR221-I In 100	150	A95	4L185R/4	10**	TA25DU2.4	7,9	11,1
11	12,8	T4L250 PR221-I In 100	200	A95	4L185R/4	7**	TA25DU2.4	11,2	15,9
15	17	T4L250 PR221-I In 100	250	A95	4L185R/4	7**	TA25DU3.1	15,2	20,5
18,5	21	T4L250 PR221-I In 100	300	A95	4L185R/4	6	TA25DU3.1	17,7	23,9
22	24	T4L250 PR221-I In 100	350	A95	4L185R/4	6	TA25DU4	21,6	30,8
30	32	T4L250 PR221-I In 100	450	A145	4L185R/4	6	TA25DU5	27	38,5
37	39	T4L250 PR221-I In 100	550	A145	4L185R/4	4	TA25DU4	32,4	46,3
45	47	T4L250 PR221-I In 100	700	A145	4L185R/4	4	TA25DU5	40,5	57,8
55	57	T4L250 PR221-I In 100	800	A145	4L185R/4	3	TA25DU5	54	77,1
75	77	T4L250 PR221-I In 160	1120	A145			E200DU200	65	200
90	93	T4L250 PR221-I In 160	1280	A145			E200DU200	65	200
110	113	T4L250 PR221-I In 250	1625	A145			E200DU200	65	200
132	134	T4L250 PR221-I In 250	2000	A185			E200DU200	65	200
160	162	T4L250 PR221-I In 250	2250	A185			E200DU200	65	200
200	203	T5L400 PR221-I In 320	2720	A210			E320DU320	105	320
250	250	T5L400 PR221-I In 400	3400	A300			E320DU320	105	320
290	301	T5L630 PR221-I In 630	4410	AF400			E500DU500	150	500
315	313	T5L630 PR221-I In 630	4410	AF400			E500DU500	150	500
355	354	T5L630 PR221-I In 630	5355	AF580			E500DU500***	150	500

(\*) Type 1 coordination

(\*\*) Cable cross section equal to 4 mm<sup>2</sup>

(\*\*\*) No mounting kit to contactor is available

MA: magnetic only adjustable release

MF: fixed magnetic only release

## 2 Protection of electrical equipment

**Table 19: 400 V 35 kA DOL Heavy duty Type 2  
(Tmax XT/T – Contactor – TOR/EOL)**

Motor		Moulded Case Circuit Breaker		Contactor	Overload Relay			
Rated Power [kW]	Rated Current [A]	Type	$I_n$ [A]	Type	Type*	Turns on CT	Current setting range [A]	
							min	max
0,37	1,1	XT2N160 MF 2	28	A9	TA25DU1.4 ^		1	1,4
0,55	1,5	XT2N160 MF 2	28	A9	TA25DU1.8 ^		1,3	1,8
0,75	1,9	XT2N160 MF 2	28	A9	TA25DU2.4 ^		1,7	2,4
1,1	2,7	XT2N160 MF 4	56	A9	TA25DU4 ^		2,8	4
1,5	3,6	XT2N160 MF 4	56	A16	TA25DU5 ^		3,5	5
2,2	4,9	XT2N160 MF 8.5	120	A26	TA25DU6.5 ^		4,5	6,5
3	6,5	XT2N160 MF 8.5	120	A26	TA25DU8.5 ^		6	8,5
4	8,5	XT2N160 MF 12.5	175	A30	TA25DU11 ^		7,5	11
5,5	11,5	XT2N160 MF 12.5	175	A30	TA450SU60	4	10	15
7,5	15,5	XT2N160 MA 20	210	A30	TA450SU60	3	13	20
11	22	XT2N160 MA 32	288	A30	TA450SU60	2	20	30
15	29	XT2N160 MA 52	392	A50	TA450SU80	2	23	40
18,5	35	XT2N160 MA 52	469	A50	TA450SU80	2	23	40
22	41	XT2N160 MA 52	547	A50	TA450SU60		40	60
30	55	XT2N160 MA 80	840	A63	TA450SU80		55	80
37	66	XT2N160 MA 80	960	A95	TA450SU80		55	80
45	80	XT2N160 MA 100	1200	A110	TA450SU105		70	105
55	97	XT3N250 MA 160	1440	A145	TA450SU140		95	140
75	132	XT3N250 MA 200	1800	A185	TA450SU185		130	185
90	160	XT3N250 MA 200	2400	A210	TA450SU185		130	185
110	195	T4N320 PR221-I In320	2720	A260	E320DU320^		100	320
132	230	T5N400 PR221-I In400	3200	A300	E320DU320^		100	320
160	280	T5N400 PR221-I In400	4000	AF400	E500DU500^		150	500
200	350	T5N630 PR221-I In630	5040	AF460	E500DU500^		150	500
250	430	T6N630 PR221-I In630	6300	AF580	E500DU500**^		150	500
290	520	T6N800 PR221-I In800	7200	AF750	E800DU800		250	800
315	540	T6N800 PR221-I In800	8000	AF750	E800DU800^		250	800
355	610	T6N800 PR221-I In800	8000	AF750	E800DU800^		250	800

Comments:

(^) Provide by-pass contactor during motor start-up

(\*) Set EOL tripping characteristic to class 30 usable also for 415V

(\*\*) Connection kit not available. To use connection kit provide E800DU800

MA: magnetic only adjustable release

MF: fixed magnetic only release

## 2 Protection of electrical equipment

**Table 20: 400 V 50 kA DOL Heavy duty Type 2  
(Tmax XT/T – Contactor – TOR/EOL)**

Motor		Moulded Case Circuit Breaker		Contactor	Overload Relay			
Rated Power [kW]	Rated Current [A]	Type	I <sub>3</sub> [A]	Type	Type*	Turns on CT	Current setting range [A]	
							min	max
0,37	1,1	XT2S160 MF 2	28	A9	TA25DU1.4 ^		1	1,4
0,55	1,5	XT2S160 MF 2	28	A9	TA25DU1.8 ^		1,3	1,8
0,75	1,9	XT2S160 MF 2	28	A9	TA25DU2.4 ^		1,7	2,4
1,1	2,7	XT2S160 MF 4	56	A9	TA25DU4 ^		2,8	4
1,5	3,6	XT2S160 MF 4	56	A16	TA25DU5 ^		3,5	5
2,2	4,9	XT2S160 MF 8.5	120	A26	TA25DU6.5 ^		4,5	6,5
3	6,5	XT2S160 MF 8.5	120	A26	TA25DU8.5 ^		6	8,5
4	8,5	XT2S160 MF 12.5	175	A30	TA25DU11 ^		7,5	11
5,5	11,5	XT2S160 MF 12.5	175	A30	TA450SU60	4	10	15
7,5	15,5	XT2S160 MA 20	210	A30	TA450SU60	3	13	20
11	22	XT2S160 MA 32	288	A30	TA450SU60	2	20	30
15	29	XT2S160 MA 52	392	A50	TA450SU80	2	23	40
18,5	35	XT2S160 MA 52	469	A50	TA450SU80	2	23	40
22	41	XT2S160 MA 52	547	A50	TA450SU60		40	60
30	55	XT2S160 MA 80	840	A63	TA450SU80		55	80
37	66	XT2S160 MA 80	960	A95	TA450SU80		55	80
45	80	XT2S160 MA 100	1200	A110	TA450SU105		70	105
55	97	XT3S250 MA 160	1440	A145	TA450SU140		95	140
75	132	XT3S250 MA 200	1800	A185	TA450SU185		130	185
90	160	XT3S250 MA 200	2400	A210	TA450SU185		130	185
110	195	T4S320 PR221-I ln320	2720	A260	E320DU320		100	320
132	230	T5S400 PR221-I ln400	3200	A300	E320DU320		100	320
160	280	T5S400 PR221-I ln400	4000	AF400	E500DU500		150	500
200	350	T5S630 PR221-I ln630	5040	AF460	E500DU500		150	500
250	430	T6S630 PR221-I ln630	6300	AF580	E500DU500**		150	500
290	520	T6S800 PR221-I ln800	7200	AF750	E800DU800		250	800
315	540	T6S800 PR221-I ln800	8000	AF750	E800DU800		250	800
355	610	T6S800 PR221-I ln800	8000	AF750	E800DU800		250	800

Comments:

(^) Provide by-pass contactor during motor start-up

(\*) Set EOL tripping characteristic to class 30 usable also for 415V

(\*\*) Connection kit not available. To use connection kit provide E800DU800

MA: magnetic only adjustable release

MF: fixed magnetic only release



## 2 Protection of electrical equipment

**Table 21: 440 V 50 kA DOL Heavy duty Type 2  
(Tmax XT/T – Contactor – TOR)**

Motor		Moulded Case Circuit Breaker		Contactor	Overload Relay			
Rated Power [kW]	Rated Current [A]	Type	I <sub>3</sub> [A]	Type	Type*	Turns on CT	Current setting range [A]	
							min	max
0,37	1	XT2S160 MF 1	14	A9	TA25DU1,4 ^		1	1,4
0,55	1,3	XT2S160 MF 2	28	A9	TA25DU1,8 ^		1,3	1,8
0,75	1,7	XT2S160 MF 2	28	A9	TA25DU2,4 ^		1,7	2,4
1,1	2,2	XT2S160 MF 4	56	A9	TA25DU3,1 ^		2,2	3,1
1,5	3,2	XT2S160 MF 4	56	A16	TA25DU4 ^		2,8	4
2,2	4,3	XT2S160 MF 8.5	120	A26	TA25DU5 ^		3,5	5
3	5,7	XT2S160 MF 8.5	120	A26	TA25DU6,5 ^		4,5	5
4	7,4	XT2S160 MF 8.5	120	A30	TA25DU11 ^		7,5	11
5,5	10,1	XT2S160 MF 12.5	175	A30	TA25DU14 ^		10	14
7,5	13,6	XT2S160 MA 20	180	A30	TA450SU60	4	10	15
11	19,3	XT2S160 MA 32	240	A30	TA450SU80	3	18	27
15	25,4	XT2S160 MA 32	336	A50	TA450SU60	2	20	30
18,5	30,7	XT2S160 MA 52	469	A50	TA450SU80	2	28	40
22	35,9	XT2S160 MA 52	547	A50	TA450SU80	2	28	40
30	48,2	XT2S160 MA 80	720	A63	TA450SU60		40	60
37	58	XT2S160 MA 80	840	A95	TA450SU80		55	80
45	70	XT2S160 MA 100	1050	A110	TA450SU105		70	105
55	85	XT4S250 Ekip-I ln160	1200	A145	E200DU200		60	200
75	116	XT4S250 Ekip-I ln250	1750	A185	E200DU200		60	200
90	140	XT4S250 Ekip-I ln250	2000	A210	E320DU320		100	320
110	171	XT4S250 Ekip-I ln250	2500	A260	E320DU320		100	320
132	202	T5H400 PR221-I ln320	3200	A300	E320DU320		100	320
160	245	T5H400 PR221-I ln400	3600	AF400	E500DU500		150	500
200	307	T5H630 PR221-I ln630	4410	AF460	E500DU500		150	500
250	377	T6H630 PR221-I ln630	5355	AF580	E500DU500***		150	500
290	448	T6H630 PR221-I ln630	6300	AF750	E500DU500***		150	500
315	473	T6H800 PR221-I ln800	7200	AF750	E800DU800		250	800
355	535	T6H800 PR221-I ln800	8000	AF750	E800DU800		250	800

(^) Provide by-pass contactor during motor start-up

(x) Set EOL tripping characteristic to class 30

(\*\*\*) Connection kit not available. To use connection kit provide E800DU800 (x)

## 2 Protection of electrical equipment

**Table 22: 440 V 65 kA DOL Heavy duty Type 2  
(Tmax XT/T – Contactor – TOR/EOL)**

Motor		Moulded Case Circuit Breaker		Contactor	Overload Relay			
Rated Power [kW]	Rated Current [A]	Type	I <sub>3</sub> [A]	Type	Type*	Turns on CT	Current setting range [A]	
							min	max
0,37	1	XT2H160 MF 1	14	A9	TA25DU1,4 ^		1	1,4
0,55	1,3	XT2H160 MF 2	28	A9	TA25DU1,8 ^		1,3	1,8
0,75	1,7	XT2H160 MF 2	28	A9	TA25DU2,4 ^		1,7	2,4
1,1	2,4	XT2H160 MF 4	56	A9	TA25DU3,1 ^		2,2	3,1
1,5	3,2	XT2H160 MF 4	56	A16	TA25DU4 ^		2,8	4
2,2	4,3	XT2H160 MF 8.5	120	A26	TA25DU5 ^		3,5	5
3	5,7	XT2H160 MF 8.5	120	A26	TA25DU6,5 ^		4,5	6,5
4	7,4	XT2H160 MF 8.5	120	A30	TA25DU11 ^		7,5	11
5,5	10,1	XT2H160 MF 12.5	175	A30	TA25DU14 ^		10	14
7,5	13,6	XT2H160 MA 20	180	A30	TA450SU60	4	10	15
11	19,3	XT2H160 MA 32	240	A30	TA450SU80	3	18	27
15	25,4	XT2H160 MA 32	336	A50	TA450SU60	2	20	30
18,5	30,7	XT2H160 MA 52	469	A50	TA450SU80	2	28	40
22	35,9	XT2H160 MA 52	547	A50	TA450SU80	2	28	40
30	48,2	XT2H160 MA 80	720	A63	TA450SU60		40	60
37	58	XT2H160 MA 80	840	A95	TA450SU80		55	80
45	70	XT2H160 MA 100	1050	A110	TA450SU105		70	105
55	85	XT4H250 Ekip-I In160	1200	A145	E200DU200		60	200
75	116	XT4H250 Ekip-I In250	1750	A185	E200DU200		60	200
90	140	XT4H250 Ekip-I In250	2000	A210	E320DU320		100	320
110	171	XT4H250 Ekip-I In250	2500	A260	E320DU320		100	320
132	202	T5H400 PR221-I In320	3200	A300	E320DU320		100	320
160	245	T5H400 PR221-I In400	3600	AF400	E500DU500		150	500
200	307	T5H630 PR221-I In630	4410	AF460	E500DU500		150	500
250	377	T6H630 PR221-I In630	5355	AF580	E500DU500***		150	500
290	448	T6H630 PR221-I In630	6300	AF750	E500DU500***		150	500
315	473	T6H800 PR221-I In800	7200	AF750	E800DU800		250	800
355	535	T6H800 PR221-I In800	8000	AF750	E800DU800		250	800

(^) Provide by-pass contactor during motor start-up

(x) Set EOL tripping characteristic to class 30

(\*\*) Connection kit not available. To use connection kit provide E800DU800 (x)

## 2 Protection of electrical equipment

**Table 23: 500 V 50 kA DOL Heavy duty Type 2  
(Tmax XT/T – Contactor – TOR/EOL)**

Motor		Moulded Case Circuit Breaker		Contactor	Overload Relay			
Rated Power [kW]	Rated Current [A]	Type	I <sub>3</sub> [A]	Type	Type*	Turns on CT	Current setting range [A]	
							min	max
0,37	0,88	XT2H160 MF 1	14	A9	TA25DU1.0 ^		0,63	1
0,55	1,2	XT2H160 MF 2	28	A9	TA25DU1.4 ^		1	1,4
0,75	1,5	XT2H160 MF 2	28	A9	TA25DU1.8 ^		1,3	1,8
1,1	2,2	XT2H160 MF 4	56	A9	TA25DU3.1 ^		2,2	3,1
1,5	2,8	XT2H160 MF 4	56	A16	TA25DU4 ^		2,8	4
2,2	3,9	XT2H160 MF 4	56	A26	TA25DU5 ^		3,5	5
3	5,2	XT2H160 MF 8.5	120	A26	TA25DU6.5 ^		4,5	6,5
4	6,8	XT2H160 MF 8.5	120	A30	TA25DU8.5 ^		6	8,5
5,5	9,2	XT2H160 MF 12.5	175	A30	TA25DU11 ^		7,5	11
7,5	12,4	XT2H160 MF 12.5	175	A30	TA450SU60	4	10	15
11	17,6	XT2H160 MA 20	240	A30	TA450SU60	3	13	20
15	23	XT2H160 MA 32	336	A50	TA450SU60	2	20	30
18,5	28	XT2H160 MA 52	392	A50	TA450SU80	2	27,5	40
22	33	XT2H160 MA 52	469	A50	TA450SU80	2	27,5	40
30	44	XT2H160 MA 52	624	A63	TA450SU60		40	80
37	53	XT2H160 MA 80	840	A75	TA450SU60		40	80
45	64	XT2H160 MA 80	960	A95	TA450SU80		55	80
55	78	XT2H160 MA 100	1200	A145	TA450SU105		70	105
75	106	XT4H250 Ekip-I ln160	1440	A145	E200DU200		60	200
90	128	XT4H250 Ekip-I ln250	1875	A185	E200DU200		60	200
110	156	XT4H250 Ekip-I ln250	2125	A210	E320DU320		100	320
132	184	T4H320 PR221-I ln320	2720	A260	E320DU320		100	320
160	224	T5H400 PR221-I ln400	3200	A300	E320DU320		100	320
200	280	T5H400 PR221-I ln400	3600	AF400	E500DU500		150	500
250	344	T5H630 PR221-I ln630	4725	AF460	E500DU500		150	500
290	394	T6L630 PR221-I ln630	5040	AF580	E500DU500***		150	500
315	432	T6L630 PR221-I ln630	6300	AF750	E500DU500***		150	500
355	488	T6L630 PR221-I ln630	6300	AF750	E500DU500***		150	500

(^) Provide by-pass contactor during motor start-up

(x) Set EOL tripping characteristic to class 30

(\*\*\*) Connection kit not available. To use connection kit provide E800DU800 (x)

## 2 Protection of electrical equipment

**Table 24: 690 V 25 kA DOL Heavy duty Type 2  
(Tmax T – Contactor – TOR)**

Motor		Moulded Case Circuit Breaker		Contactor	Overload Relay			
Rated Power [kW]	Rated Current [A]	Type	I <sub>3</sub> [A]	Type	Type*	Turns on CT	Current setting range [A]	
							min	max
0,37	0,64	XT2V160 MF1	14	A9	TA25DU0.63 ^		0,4	0,63
0,55	0,87	XT2V160 MF1	14	A9	TA25DU1 ^		0,63	1
0,75	1,1	XT2V160 MF 2	28	A9	TA25DU1.4 ^		1	1,4
1,1	1,6	XT2V160 MF 2	28	A9	TA25D1.8 ^		1,3	1,8
1,5	2,1	XT2V160 MF 4	56	A9	TA25DU2.4 ^		1,7	2,4
2,2	2,8	XT2V160 MF 4	56	A9	TA25DU3.1 ^		2,2	3,1
3	3,8	XT2V160 MF 4	56	A9	TA25DU4 ^		2,8	4
4	4,9	XT2V160 MF 8.5	120	A9	TA25DU5 ^		3,5	5
5,5	6,7	XT2V160 MF 8.5	120	A9	TA25DU6.5 ^		4,5	6,5
		XT4V250 EKIP-I In 100	150	A95	TA450SU60	7(+)	5,7	8,6
7,5	8,9	XT4V250 EKIP-I In 100	150	A95	TA450SU60	5(+)	8	12
11	12,8	XT4V250 EKIP-I In 100	200	A95	TA450SU60	4(+)	10	15
15	17	XT4V250 EKIP-I In 100	250	A95	TA450SU60	3(+)	10	20
18,5	21	XT4V250 EKIP-I In 100	300	A95	TA450SU60	3	18	27
22	24	XT4V250 EKIP-I In 100	350	A95	TA450SU60	2	20	30
30	32	XT4V250 EKIP-I In 100	450	A145	TA450SU80	2	27,5	40
37	39	XT4V250 EKIP-I In 100	550	A145	TA450SU60		40	60
45	47	XT4V250 EKIP-I In 100	700	A145	TA450SU60		40	60
55	57	XT4V250 EKIP-I In 100	800	A145	TA450SU80		55	80
75	77	XT4V250 EKIP-I In 160	1120	A145	TA450SU105		70	105
90	93	XT4V250 EKIP-I In 160	1280	A145	TA450SU105		70	105
110	113	XT4V250 EKIP-I In 250	1625	A185	TA450SU140		95	140
132	134	XT4V250 EKIP-I In 250	2000	A210	E320DU320		105	320
160	162	XT4V250 EKIP-I In 250	2250	A210	E320DU320		105	320

(^) Provide by-pass contactor during motor start-up

(x) Set EOL tripping characteristic to class 30

(\*\*\*) Connection kit not available. To use connection kit provide E800DU800 (x)

(+) size wire 4mm

## 2 Protection of electrical equipment

**Table 25: 690 V 50 kA DOL Heavy duty Type 2  
(Tmax T – Contactor – TOR)**

Motor		Moulded Case Circuit Breaker		Contactor	Overload Relay			
Rated Power [kW]	Rated Current [A]	Type	I <sub>3</sub> [A]	Type	Type*	Turns on CT	Current setting range [A]	
							min	max
0,37	0,64	T2L160 MF1	13	A9	TA25DU0.63 ^		0,4	0,63
0,55	0,87	T2L160 MF1	13	A9	TA25DU1 ^		0,63	1
0,75	1,1	T2L160 MF 1.6	21	A9	TA25DU1.4 ^		1	1,4
1,1	1,6	T2L160 MF 1.6	21	A9	TA25D1.8 ^		1,3	1,8
1,5	2,1	T2L160 MF 2.5	33	A9	TA25DU2.4 ^		1,7	2,4
2,2	2,8	T2L160 MF 3.2	42	A9	TA25DU3.1 ^		2,2	3,1
3	3,8	T2L160 MF 4	52	A9	TA25DU4 ^		2,8	4
4	4,9	T2L160 MF 5	65	A9	TA25DU5 ^		3,5	5
5,5	6,7	T2L160 MF 6.5	84	A9	TA25DU6.5 ^		4,5	6,5
		T4L250 PR221-I In 100	150	A95	TA450SU60	7(+)	5,7	8,6
7,5	8,9	T4L250 PR221-I In 100	150	A95	TA450SU60	5(+)	8	12
11	12,8	T4L250 PR221-I In 100	200	A95	TA450SU60	4(+)	10	15
15	17	T4L250 PR221-I In 100	250	A95	TA450SU60	3(+)	13	20
18,5	21	T4L250 PR221-I In 100	300	A95	TA450SU60	3	18	27
22	24	T4L250 PR221-I In 100	350	A95	TA450SU60	2	20	30
30	32	T4L250 PR221-I In 100	450	A145	TA450SU80	2	27,5	40
37	39	T4L250 PR221-I In 100	550	A145	TA450SU60		40	60
45	47	T4L250 PR221-I In 100	700	A145	TA450SU60		40	60
55	57	T4L250 PR221-I In 100	800	A145	TA450SU80		55	80
75	77	T4L250 PR221-I In 160	1120	A145	TA450SU105		70	105
90	93	T4L250 PR221-I In 160	1280	A145	TA450SU105		70	105
110	113	T4L250 PR221-I In 250	1625	A185	TA450SU140		95	140
132	134	T4L250 PR221-I In 250	2000	A210	E320DU320		105	320
160	162	T4L250 PR221-I In 250	2250	A210	E320DU320		105	320
200	203	T5L400 PR221-I In 320	2720	A260	E320DU320		105	320
250	250	T5L400 PR221-I In 400	3400	AF400	E500DU500		150	500
290	301	T5L630 PR221-I In 630	4410	AF400	E500DU500		150	500
315	313	T5L630 PR221-I In 630	4410	AF460	E500DU500		150	500
355	354	T5L630 PR221-I In 630	5355	AF580	E500DU500***		150	500

(^) Provide by-pass contactor during motor start-up

(x) Set EOL tripping characteristic to class 30

(\*\*\*) Connection kit not available. To use connection kit provide E800DU800 (x)

(+) size wire 4mm

## 2 Protection of electrical equipment

**Table 26: 400 V 35 kA Y/Δ Normal Type 2  
(Tmax XT/T – Contactor – TOR/EOL)**

Motor		Moulded Case Circuit Breaker		Contactor			Overload Relay	
Rated Power [kW]	Rated Current [A]	Type	I <sub>3</sub> [A]	Line Type	Delta Type	Star Type	Type	Current setting range [A]
18,5	35	XT2N160 MA52	469	A50	A50	A26	TA75DU25	18-25
22	41	XT2N160 MA52	547	A50	A50	A26	TA75DU32	22-32
30	55	XT2N160 MA80	720	A63	A63	A30	TA75DU42	29-42
37	66	XT2N160 MA80	840	A75	A75	A30	TA75DU52	36-52
45	80	XT2N160 MA100	1050	A75	A75	A30	TA75DU63	45 - 63
55	97	XT2N160 MA100	1200	A75	A75	A40	TA75DU63	45 - 63
75	132	XT3N250 MA160	1700	A95	A95	A75	TA110DU90	66 - 90
90	160	XT3N250 MA200	2000	A110	A110	A95	TA110DU110	80 - 110
110	195	XT4N250 MA200	2400	A145	A145	A95	TA200DU135	100 - 135
132	230	T4N320 PR221-I In320	2880	A145	A145	A110	E200DU200	60 - 200
160	280	T5N400 PR221-I In400	3600	A185	A185	A145	E200DU200	60 - 200
200	350	T5N630 PR221-I In630	4410	A210	A210	A185	E320DU320	100 - 320
250	430	T5N630 PR221-I In630	5670	A260	A260	A210	E320DU320	100 - 320
290	520	T6N630 PR221-I In630	6300	AF400	AF400	A260	E500DU500	150 - 500
315	540	T6N800 PR221-I In800	7200	AF400	AF400	A260	E500DU500	150 - 500
355	610	T6N800 PR221-I In800	8000	AF400	AF400	A260	E500DU500	150 - 500

**Table 27: 400 V 50 kA Y/Δ Normal Type 2  
(Tmax XT/T – Contactor – TOR/EOL)**

Motor		Moulded Case Circuit Breaker		Contactor			Overload Relay	
Rated Power [kW]	Rated Current [A]	Type	I <sub>3</sub> [A]	Line Type	Delta Type	Star Type	Type	Current setting range [A]
18,5	35	XT2S160 MA52	469	A50	A50	A26	TA75DU25	18-25
22	41	XT2S160 MA52	547	A50	A50	A26	TA75DU32	22-32
30	55	XT2S160 MA80	720	A63	A63	A30	TA75DU42	29-42
37	66	XT2S160 MA80	840	A75	A75	A30	TA75DU52	36-52
45	80	XT2S160 MA100	1050	A75	A75	A30	TA75DU63	45 - 63
55	97	XT2S160 MA100	1200	A75	A75	A40	TA75DU63	45 - 63
75	132	XT3S250 MA160	1700	A95	A95	A75	TA110DU90	66 - 90
90	160	XT3S250 MA200	2000	A110	A110	A95	TA110DU110	80 - 110
110	195	XT3S250 MA200	2400	A145	A145	A95	TA200DU135	100 - 135
132	230	T4S320 PR221-I In320	2880	A145	A145	A110	E200DU200	60 - 200
160	280	T5S400 PR221-I In400	3600	A185	A185	A145	E200DU200	60 - 200
200	350	T5S630 PR221-I In630	4410	A210	A210	A185	E320DU320	100 - 320
250	430	T5S630 PR221-I In630	5670	A260	A260	A210	E320DU320	100 - 320
290	520	T6S630 PR221-I In630	6300	AF400	AF400	A260	E500DU500	150 - 500
315	540	T6S800 PR221-I In800	7200	AF400	AF400	A260	E500DU500	150 - 500
355	610	T6S800 PR221-I In800	8000	AF400	AF400	A260	E500DU500	150 - 500

## 2 Protection of electrical equipment

**Table 28: 440 V 50 kA Y/Δ Normal Type 2  
(Tmax XT/T – Contactor – TOR/EOL)**

Motor		Moulded Case Circuit Breaker		Contactor			Overload Relay	
Rated Power [kW]	Rated Current [A]	Type	I <sub>3</sub> [A]	Line Type	Delta Type	Star Type	Type	Current setting range [A]
18,5	30,7	XT2S160 MA52	392	A50	A50	A16	TA75DU25	18-25
22	35,9	XT2S160 MA52	469	A50	A50	A26	TA75DU25	18-25
30	48,2	XT2S160 MA80	720	A63	A63	A26	TA75DU42	29-42
37	58	XT2S160 MA80	840	A75	A75	A30	TA75DU42	29-42
45	70	XT2S160 MA80	960	A75	A75	A30	TA75DU52	36-52
55	85	XT2S160 MA100	1150	A75	A75	A40	TA75DU63	45-63
75	116	XT4S250 Ekip-I In250	1625	A95	A95	A75	TA80DU80	60-80
90	140	XT4S250 Ekip-I In250	1875	A95	A95	A75	TA110DU110	80-110
110	171	XT4S250 Ekip-I In250	2250	A145	A145	A95	E200DU200	60-200
132	202	T4H320 PR221-I In320	2720	A145	A145	A110	E200DU200	60-200
160	245	T5H400 PR221-I In400	3200	A185	A185	A145	E200DU200	60-200
200	307	T5H630 PR221-I In630	4095	A210	A210	A185	E320DU320	100-320
250	377	T5H630 PR221-I In630	5040	A260	A260	A210	E320DU320	100-320
290	448	T6H630 PR221-I In630	5670	AF400	AF400	A260	E500DU500	150 - 500
315	473	T6H630 PR221-I In630	6300	AF400	AF400	A260	E500DU500	150 - 500
355	535	T6H800 PR221-I In800	7200	AF400	AF400	A260	E500DU500	150 - 500

**Table 29: 440 V 65 kA Y/Δ Normal Type 2  
(Tmax XT/T – Contactor – TOR/EOL)**

Motor		Moulded Case Circuit Breaker		Contactor			Overload Relay	
Rated Power [kW]	Rated Current [A]	Type	I <sub>3</sub> [A]	Line Type	Delta Type	Star Type	Type	Current setting range [A]
18,5	30,7	XT2H160 MA52	392	A50	A50	A16	TA75DU25	18-25
22	35,9	XT2H160 MA52	469	A50	A50	A26	TA75DU25	18-25
30	48,2	XT2H160 MA80	720	A63	A63	A26	TA75DU42	29-42
37	58	XT2H160 MA80	840	A75	A75	A30	TA75DU42	29-42
45	70	XT2H160 MA80	960	A75	A75	A30	TA75DU52	36-52
55	85	XT2H160 MA100	1150	A75	A75	A40	TA75DU63	45-63
75	116	XT4H250 Ekip-I In250	1625	A95	A95	A75	TA80DU80	60-80
90	140	XT4H250 Ekip-I In250	1875	A95	A95	A75	TA110DU110	80-110
110	171	XT4H250 Ekip-I In250	2250	A145	A145	A95	E200DU200	60-200
132	202	T4H320 PR221-I In320	2720	A145	A145	A110	E200DU200	60-200
160	245	T5H400 PR221-I In400	3200	A185	A185	A145	E200DU200	60-200
200	307	T5H630 PR221-I In630	4095	A210	A210	A185	E320DU320	100-320
250	377	T5H630 PR221-I In630	5040	A260	A260	A210	E320DU320	100-320
290	448	T6H630 PR221-I In630	5670	AF400	AF400	A260	E500DU500	150 - 500
315	473	T6H630 PR221-I In630	6300	AF400	AF400	A260	E500DU500	150 - 500
355	535	T6H800 PR221-I In800	7200	AF400	AF400	A260	E500DU500	150 - 500

## 2 Protection of electrical equipment

**Table 30: 500 V 50 kA Y/Δ Normal Type 2  
(Tmax XT/T – Contactor – TOR/EOL)**

Motor		Moulded Case Circuit Breaker		Contactor			Overload Relay	
Rated Power [kW]	Rated Current [A]	Type	I <sub>3</sub> [A]	Line Type	Delta Type	Star Type	Type	Current setting range [A]
22	33	XT2H160 MA52	430	A50	A50	A16	TA75DU25	18-25
30	44	XT2H160 MA52	547	A63	A63	A26	TA75DU32	22-32
37	53	XT2H160 MA80	720	A75	A75	A30	TA75DU42	29-42
45	64	XT2H160 MA80	840	A75	A75	A30	TA75DU52	36-52
55	78	XT2H160 MA100	1050	A75	A75	A30	TA75DU52	36-52
75	106	XT4H250 Ekip-I In250	1375	A95	A95	A50	TA80DU80	60-80
90	128	XT4H250 Ekip-I In250	1750	A95	A95	A75	TA110DU90	65-90
110	156	XT4H250 Ekip-I In250	2000	A110	A110	A95	TA110DU110	80-110
132	184	T4H320 PR221-I In320	2560	A145	A145	A95	E200DU200	60-200
160	224	T4H320 PR221-I In320	2880	A145	A145	A110	E200DU200	60-200
200	280	T5H400 PR221-I In400	3400	A210	A210	A145	E320DU320	100-320
250	344	T5H630 PR221-I In630	4410	A210	A210	A185	E320DU320	100-320
290	394	T5H630 PR221-I In630	5040	A260	A260	A210	E320DU320	100-320
315	432	T6L630 PR221-I In630	5760	AF400	AF400	A210	E500DU500	150 - 500
355	488	T6L630 PR221-I In630	6300	AF400	AF400	A260	E500DU500	150 - 500

**Table 31: 690 V 25 kA Y/Δ Normal Type 2  
(Tmax XT – Contactor – TOR/EOL)**

Motor		Moulded Case Circuit Breaker		Contactor			KORC		Overload Relay	
Rated Power [kW]	Rated Current [A]	Type	I <sub>3</sub> [A]	Line Type	Delta Type	Star Type	Type	N° of turns	Type	Current setting range [A]
5,5	6.7*	XT4V250 Ekip-I In100	150	A95	A95	A26	185R/4**	13	TA25DU2.4**	6-8.5
7,5	8.9*	XT4V250 Ekip-I In100	150	A95	A95	A26	185R/4**	10	TA25DU2.4**	7.9-11.1
11	12.8*	XT4V250 Ekip-I In100	200	A95	A95	A26	185R/4**	7	TA25DU2.4**	11.2-15.9
15	17*	XT4V250 Ekip-I In100	250	A95	A95	A26	185R/4**	7	TA25DU3.1**	15.2-20.5
18,5	21	XT4V250 Ekip-I In100	300	A95	A95	A30	185R/4**	6	TA25DU3.1**	17.7-23.9
22	24	XT4V250 Ekip-I In100	350	A95	A95	A30	185R/4**	6	TA25DU4**	21.6-30.8
30	32	XT4V250 Ekip-I In100	450	A145	A145	A30	185R/4**	6	TA25DU5**	27-38.5
37	39	XT4V250 Ekip-I In100	550	A145	A145	A30			TA75DU52**	36-52
45	47	XT4V250 Ekip-I In100	650	A145	A145	A30			TA75DU52**	36 - 52
55	57	XT4V250 Ekip-I In100	800	A145	A145	A40			TA75DU52**	36-52
75	77	XT4V250 Ekip-I In160	1120	A145	A145	A50			TA75DU52	36 - 52
90	93	XT4V250 Ekip-I In160	1280	A145	A145	A75			TA75DU63	45-63
110	113	XT4V250 Ekip-I In160	1600	A145	A145	A75			TA75DU80	60-80
132	134	XT4V250 Ekip-I In250	1875	A145	A145	A95			TA200DU110	80-110
160	162	XT4V250 Ekip-I In250	2125	A145	A145	A110			TA200DU110	80-110

Comments:

\*size wire 4mm

\*\*connect TOL at line-delta supply side



## 2 Protection of electrical equipment

**Table 32: 690 V 50 kA Y/ $\Delta$  Normal Type 2  
(Tmax T – Contactor – TOR/EOL)**

Motor		Moulded Case Circuit Breaker		Contactor			KORC		Overload Relay	
Rated Power [kW]	Rated Current [A]	Type	I <sub>3</sub> [A]	Line Type	Delta Type	Star Type	Type	N° of turns	Type	Current setting range [A]
5,5	6.7*	T4L250 PR221-I ln100	150	A95	A95	A26	4L185R/4**	13	TA25DU2.4**	6-8.5
7,5	8.9*	T4L250 PR221-I ln100	150	A95	A95	A26	4L185R/4**	10	TA25DU2.4**	7.9-11.1
11	12.8*	T4L250 PR221-I ln100	200	A95	A95	A26	4L185R/4**	7	TA25DU2.4**	11.2-15.9
15	17*	T4L250 PR221-I ln100	250	A95	A95	A26	4L185R/4**	7	TA25DU3.1**	15.2-20.5
18,5	21	T4L250 PR221-I ln100	300	A95	A95	A30	4L185R/4**	6	TA25DU3.1**	17.7-23.9
22	24	T4L250 PR221-I ln100	350	A95	A95	A30	4L185R/4**	6	TA25DU4**	21.6-30.8
30	32	T4L250 PR221-I ln100	450	A145	A145	A30	4L185R/4**	6	TA25DU5**	27-38.5
37	39	T4L250 PR221-I ln100	550	A145	A145	A30			TA75DU52**	36-52
45	47	T4L250 PR221-I ln100	650	A145	A145	A30			TA75DU52**	36 - 52
55	57	T4L250 PR221-I ln100	800	A145	A145	A40			TA75DU52**	36-52
75	77	T4L250 PR221-I ln160	1120	A145	A145	A50			TA75DU52	36 - 52
90	93	T4L250 PR221-I ln160	1280	A145	A145	A75			TA75DU63	45-63
110	113	T4L250 PR221-I ln160	1600	A145	A145	A75			TA75DU80	60-80
132	134	T4L250 PR221-I ln250	1875	A145	A145	A95			TA200DU110	80-110
160	162	T4L250 PR221-I ln250	2125	A145	A145	A110			TA200DU110	80-110
200	203	T4L320 PR221-I ln320	2720	A185	A185	A110			TA200DU135	100-135
250	250	T5L400 PR221-I ln400	3200	AF400	AF400	A145			E500DU500	150-500
290	301	T5L400 PR221-I ln400	4000	AF400	AF400	A145			E500DU500	150-500
315	313	T5L630 PR221-I ln630	4410	AF400	AF400	A185			E500DU500	150-500
355	354	T5L630 PR221-I ln630	5040	AF400	AF400	A210			E500DU500	150-500
400	420	T5L630 PR221-I ln630	5670	AF460	AF460	A210			E500DU500	150-500
450	470	T5L630 PR221-I ln630	6300	AF460	AF460	A260			E500DU500	150-500

Comments:

\*size wire 4mm

\*\*connect TOL at line-delta supply side

## 2 Protection of electrical equipment

**Table 33: 400 V 35 kA DOL Normal and Heavy duty Type 2  
(Tmax XT/T with Ekip M/PR222MP – Contactor)**

Motor		Moulded Case Circuit Breaker			Contactor	Allowed setting current [A]
Rated Power [kW]	Rated Current [A]	Type***	Inverse time tripping current* [A]	I <sub>3</sub> [A]	Type	
7,5	15,5	XT2N160 Ekip M-LIU In25	10-25	150	A63	25
11	22	XT2N160 Ekip M-LIU In25	10-25	225	A63	25
15	29	XT2N160 Ekip M-LIU In63	25-63	378	A75	50
18,5	35	XT2N160 Ekip M-LIU In63	25-63	378	A75	50
22	41	XT2N160 Ekip M-LIU In63	25-63	441	A75	50
30	55	XT4N250 Ekip M-LIU In100	40-100	600	A95	95
37	66	XT4N250 Ekip M-LIU In100	40-100	700	A95	95
45	80	XT4N250 Ekip M-LIU In100	40-100	800	A95	95
55	97	XT4N250 Ekip M-LIU In160	64-160	960	A145	145
75	132	XT4N250 Ekip M-LIU In160	64-160	1280	A145	145
90	160	T4N250 PR222 MP In200	80-200	1600	A185	185
110	195	T5N400 PR222 MP In320	128-320	1920	A210	210
132	230	T5N400 PR222 MP In320	128-320	2240	A260	260
160	280	T5N400 PR222 MP In320	128-320	2560	AF400**	320
200	350	T5N400 PR222 MP In400	160-400	3200	AF400	400
250	430	T6N800 PR222 MP In630	252-630	5040	AF460	460
290	520	T6N800 PR222 MP In630	252-630	5670	AF580	580
315	540	T6N800 PR222 MP In630	252-630	5670	AF580	580
355	610	T6N800 PR222 MP In630	252-630	5670	AF750	630

Comments:

\* For Heavy start, select the class 30 on the EKIP M or MP release

\*\* In event of normal start, choose AF300

\*\*\* EKIP M-LIU also available in M-LRIU version

## 2 Protection of electrical equipment

**Table 34: 400 V 50 kA DOL Normal and Heavy duty Type 2  
(Tmax XT/T with Ekip M/PR222MP – Contactor)**

Motor		Moulded Case Circuit Breaker			Contactor	Allowed setting current [A]
Rated Power [kW]	Rated Current [A]	Type***	Inverse time tripping current* [A]	I <sub>3</sub> [A]	Type	
7,5	15,5	XT2S160 Ekip M-LIU In25	10-25	150	A63	25
11	22	XT2S160 Ekip M-LIU In25	10-25	225	A63	25
15	29	XT2S160 Ekip M-LIU In63	25-63	378	A75	50
18,5	35	XT2S160 Ekip M-LIU In63	25-63	378	A75	50
22	41	XT2S160 Ekip M-LIU In63	25-63	441	A75	50
30	55	XT4S250 Ekip M-LIU In100	40-100	600	A95	95
37	66	XT4S250 Ekip M-LIU In100	40-100	700	A95	95
45	80	XT4S250 Ekip M-LIU In100	40-100	800	A95	95
55	97	XT4S250 Ekip M-LIU In160	64-160	960	A145	145
75	132	XT4S250 Ekip M-LIU In160	64-160	1280	A145	145
90	160	T4S250 PR222 MP In200	80-200	1600	A185	185
110	195	T5S400 PR222 MP In320	128-320	1920	A210	210
132	230	T5S400 PR222 MP In320	128-320	2240	A260	260
160	280	T5S400 PR222 MP In320	128-320	2560	AF400**	320
200	350	T5S400 PR222 MP In400	160-400	3200	AF400	400
250	430	T6S800 PR222 MP In630	252-630	5040	AF460	460
290	520	T6S800 PR222 MP In630	252-630	5670	AF580	580
315	540	T6S800 PR222 MP In630	252-630	5670	AF580	580
355	610	T6S800 PR222 MP In630	252-630	5670	AF750	630

Comments:

\* For Heavy start, select the class 30 on the EKIP M or MP release

\*\* In event of normal start, choose AF300

\*\*\* EKIP M-LIU also available in M-LRIU version

## 2 Protection of electrical equipment

**Table 35: 440 V 50 kA DOL Normal and Heavy duty Type 2  
(Tmax XT/T with Ekip M/PR222MP – Contactor)**

Motor		Moulded Case Circuit Breaker			Contactor	Allowed setting current [A]
Rated Power [kW]	Rated Current [A]	Type***	Inverse time tripping current* [A]	I <sub>3</sub> [A]	Type	
7,5	13,6	XT2S160 Ekip M-LIU In25	10-25	150	A63	25
11	19,3	XT2S160 Ekip M-LIU In25	10-25	225	A63	25
15	25,4	XT2S160 Ekip M-LIU In63	25-63	378	A75	63
18,5	30,7	XT2S160 Ekip M-LIU In63	25-63	378	A75	63
22	35,9	XT2S160 Ekip M-LIU In63	25-63	378	A75	63
30	48,2	XT4S250 Ekip M-LIU In100	40-100	600	A95	93
37	58	XT4S250 Ekip M-LIU In100	40-100	600	A95	93
45	70	XT4S250 Ekip M-LIU In100	40-100	700	A95	93
55	85	XT4S250 Ekip M-LIU In160	64-160	960	A145	145
75	116	XT4S250 Ekip M-LIU In160	64-160	1120	A145	145
90	140	T4H250 PR222 MP In200	80-200	1400	A185	185
110	171	T5H400 PR222 MP In320	128-320	1920	A210	210
132	202	T5H400 PR222 MP In320	128-320	2240	A260	240
160	245	T5H400 PR222 MP In320	128-320	2560	AF400**	320
200	307	T5H400 PR222 MP In400	160-400	3200	AF400	400
250	377	T6H800 PR222 MP In630	252-630	4410	AF460	460
290	448	T6H800 PR222 MP In630	252-630	5040	AF460	460
315	473	T6H800 PR222 MP In630	252-630	5040	AF580	580
355	535	T6H800 PR222 MP In630	252-630	5670	AF580	580

Comments:

\* For Heavy start, select the class 30 on the EKIP M or MP release

\*\* In event of normal start, choose AF300

\*\*\* EKIP M-LIU also available in M-LRIU version

**Table 36: 690 V 25 kA DOL Normal and Heavy duty Type 2  
(Tmax T with Ekip M – Contactor)**

Motor		Moulded Case Circuit Breaker			Contactor	Allowed setting current [A]
Rated Power [kW]	Rated Current [A]	Type	Inverse time tripping current* [A]	I <sub>3</sub> [A]	Type	
11	12,8	XT2V160 EKIP M-LIU In25	10-25	150	A63	25
15	17	XT2V160 EKIP M-LIU In25	10-25	175	A63	25
18,5	21	XT2V160 EKIP M-LIU In25	10-25	225	A75	25
22	24	XT2V160 EKIP M-LIU In63	25-63	250	A75	63
30	32	XT2V160 EKIP M-LIU In63	25-63	378	A95	63
37	39	XT2V250 EKIP M-LIU In63	25-63	378	A95	63
45	47	XT2V250 EKIP M-LIU In63	25-63	504	A145	63
55	57	XT4V250 EKIP M-LIU In63	25-63	567	A145	63
75	77	XT4V250 EKIP M-LIU In100	40-100	800	A145	100
90	93	XT4V250 EKIP M-LIU In160	64-160	960	A145	120
110	113	XT4V250 EKIP M-LIU In160	64-160	1120	A145	120
132	134	XT4V250 EKIP M-LIU In160	64-160	1440	A185	160

Comments:

\* For Heavy start, select the class 30 on the MP release

## 2 Protection of electrical equipment

**Table 37: 500 V 50 kA DOL Normal and Heavy duty Type 2  
(Tmax XT/T with Ekip M/PR222MP – Contactor)**

Motor		Moulded Case Circuit Breaker			Contactor	Allowed setting current [A]
Rated Power [kW]	Rated Current [A]	Type***	Inverse time tripping current* [A]	I <sub>3</sub> [A]	Type	
7,5	12,4	XT2H160 Ekip M-LIU In25	10-25	150	A63	25
11	17,6	XT2H160 Ekip M-LIU In25	10-25	175	A63	25
15	23	XT2H160 Ekip M-LIU In25	10-25	250	A75	25
18,5	28	XT2H160 Ekip M-LIU In63	25-63	378	A75	63
22	33	XT2H160 Ekip M-LIU In63	25-63	378	A75	63
30	44	XT4H250 Ekip M-LIU In63	25-63	441	A95	63
37	53	XT4H250 Ekip M-LIU In63	25-63	567	A95	63
45	64	XT4H250 Ekip M-LIU In100	40-100	630	A145	100
55	78	XT4H250 Ekip M-LIU In100	40-100	800	A145	100
75	106	XT4H250 Ekip M-LIU In160	64-160	1120	A145	145
90	128	XT4H250 Ekip M-LIU In160	64-160	1280	A145	145
110	156	T4H250 PR222 MP In200	80-200	1600	A185	170
132	184	T5H400 PR222 MP In320	128-320	1920	A210	210
160	224	T5H400 PR222 MP In320	128-320	2240	A260	240
200	280	T5H400 PR222 MP In400	160-400	2800	AF400**	400
250	344	T5H400 PR222 MP In400	160-400	3200	AF400	400
290	394	T6H800 PR222 MP In630	252-630	5040	AF460	460
315	432	T6H800 PR222 MP In630	252-630	5040	AF460	460
355	488	T6H800 PR222 MP In630	252-630	5670	AF580	580

Comments:

\* For Heavy start, select the class 30 on the EKIP M or MP release

\*\* In event of normal start, choose AF300

\*\*\* EKIP M-LIU also available in M-LRIU version

**Table 38: 690 V 50 kA DOL Normal and Heavy duty Type 2  
(Tmax T with PR222MP – Contactor)**

Motor		Moulded Case Circuit Breaker			Contactor	Allowed setting current [A]
Rated Power [kW]	Rated Current [A]	Type	Inverse time tripping current* [A]	I <sub>3</sub> [A]	Type	
45	47	T4L250 PR222MP In 100	40-100	600	A145	100
55	57	T4L250 PR222MP In 100	40-100	600	A145	100
75	77	T4L250 PR222MP In 100	40-100	800	A145	100
90	93	T4L250 PR222MP In 160	64-160	960	A145	120
110	113	T4L250 PR222MP In 160	64-160	1120	A145	120
132	134	T4L250 PR222MP In 160	64-160	1440	A185	160
160	162	T4L250 PR222MP In 200	80-200	1600	A185	170
200	203	T5L400 PR222MP In320	128-320	1920	A210	210
250	250	T5L400 PR222MP In320	128-320	2240	AF300	280
290	301	T5L400 PR222MP In400	160-400	2800	AF400	350
315	313	T5L400 PR222MP In400	160-400	3200	AF400	350

Comments:

\* For Heavy start, select the class 30 on the MP release

## 2 Protection of electrical equipment

### Example:

For a DOL Normal starting Type 2, of a three phase asynchronous squirrel-cage motor with the following data:

rated voltage  $U_r = 400$  V

short-circuit current  $I_k = 50$  kA

rated motor power  $P_e = 22$  kW

from Table 4, on the relevant row, the following information can be found:

- $I_r$  (rated current): 41 A;
- short-circuit protection device: circuit-breaker XT2S160 MA52;
- magnetic trip threshold:  $I_3 = 547$  A;
- contactor: A50;
- thermal release TA75 DU52, setting range 36÷52 A

For a Y/Δ Normal starting Type 2, of a three phase asynchronous squirrel-cage motor with the following data:

rated voltage  $U_r = 400$  V

short-circuit current  $I_k = 50$  kA

rated motor power  $P_e = 200$  kW

from Table 27, on the relevant row, the following information can be found:

- $I_r$  (rated current): 350 A;
- short-circuit protection device: circuit-breaker T5S630 PR221-I In630;
- magnetic trip threshold:  $I_3 = 4410$  A;
- line contactor: A210;
- delta contactor: A210;
- star contactor: A185;
- thermal release E320DU320, setting range 100÷320 A (to be set at  $\frac{I_r}{\sqrt{3}} = 202$  A).

For a DOL heavy-duty starting Type 2 with Ekip protection of a three phase asynchronous squirrel-cage motor with the following data:

rated voltage  $U_r = 400$  V

short-circuit current  $I_k = 50$  kA

rated motor power  $P_e = 55$  kW

from Table 34, on the relevant row, the following information can be found:

- $I_r$  (rated current): 97 A;
- short-circuit protection device: circuit breaker XT4S250 Ekip M LIU (or Ekip M LRIU)\* In160;
- magnetic trip threshold:  $I_3 = 960$  A;
- contactor: A145.

\* for heavy-duty start set the electronic release tripping class to class 30

## 2 Protection of electrical equipment

### 2.4 Protection and switching of transformers

#### General aspects

Transformers are used to achieve a change in the supply voltage, for both medium and low voltage supplies.

The choice of the protection devices must take into account transient insertion phenomena, during which the current may reach values higher than the rated full load current; the phenomenon decays in a few seconds.

The curve which represents these transient phenomena in the time-current diagram, termed "inrush current  $I_0$ ", depends on the size of the transformer and can be evaluated with the following formula (the short-circuit power of the network is assumed to be equal to infinity)

$$I_0 = \frac{K \cdot I_{r1} \cdot e^{(-t/\tau)}}{\sqrt{2}}$$

where:

K ratio between the maximum peak inrush current value ( $I_0$ ) and the rated current of the transformer ( $I_{r1}$ ): ( $K = I_0 / I_{r1}$ );

$\tau$  time constant of the inrush current;

$I_{r1}$  rated current of the primary;

t time.

The table below shows the indicative values for t and K parameters referred to rated power  $S_r$  for oil transformers.

$S_r$ [kVA]	50	100	160	250	400	630	1000	1600	2000
$K = I_0 / I_{r1}$	15	14	12	12	12	11	10	9	8
$\tau$ [s]	0.10	0.15	0.20	0.22	0.25	0.30	0.35	0.40	0.45

Further to the above consideration, the following diagram shows the inrush current curve for a 20/0.4kV of 400kVA transformer. This transformer has an inrush current during the very first moments equal to about 8 times the rated current; this transient phenomenon stops after a few tenths of a second.

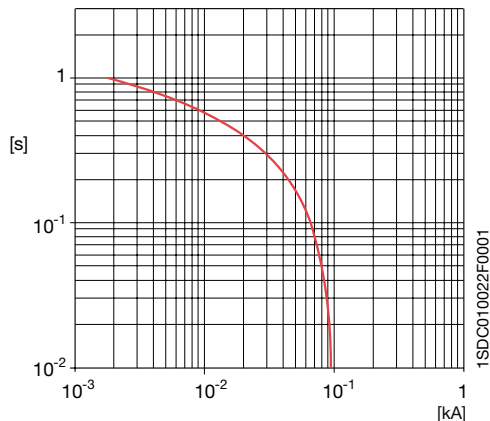

## 2 Protection of electrical equipment

The transformer protection devices must also guarantee that the transformer cannot operate above the point of maximum thermal overload under short-circuit conditions; this point is defined on the time-current diagram by the value of short-circuit current which can pass through the transformer and by a time equal to 2 s, as stated by Standard IEC 60076-5. The short-circuit current ( $I_k$ ) flowing for a fault with low impedance at the LV terminals of the transformer is calculated by using the following formula:

$$I_k = \frac{U_r}{\sqrt{3} \cdot (Z_{Net} + Z_t)} \quad [\text{A}] \quad (1)$$

where:

- $U_r$  is the rated voltage of the transformer [V];
- $Z_{Net}$  is the short-circuit impedance of the network [ $\Omega$ ];
- $Z_t$  is the short-circuit impedance of the transformer; from the rated power of the transformer ( $S_r$  [VA]) and the percentage short-circuit voltage ( $u_k\%$ ) it is equal to:

$$Z_t = \frac{u_k\% \cdot U_r^2}{100 \cdot S_r} \quad [\Omega] \quad (2)$$

Considering the upstream short-circuit power of the network to be infinite ( $Z_{Net}=0$ ), formula (1) becomes:

$$I_k = \frac{U_r}{\sqrt{3} \cdot (Z_t)} = \frac{U_r}{\sqrt{3} \cdot \left( \frac{u_k\% \cdot U_r^2}{100 \cdot S_r} \right)} = \frac{100 S_r}{\sqrt{3} \cdot u_k\% \cdot U_r} \quad [\text{A}] \quad (3)$$

The diagram below shows the inrush current curve for a 20/0.4 kV of 400 kVA transformer ( $u_k\% = 4\%$ ) and the point referred to the thermal ability to withstand the short-circuit current ( $I_k$ ; 2 sec.).

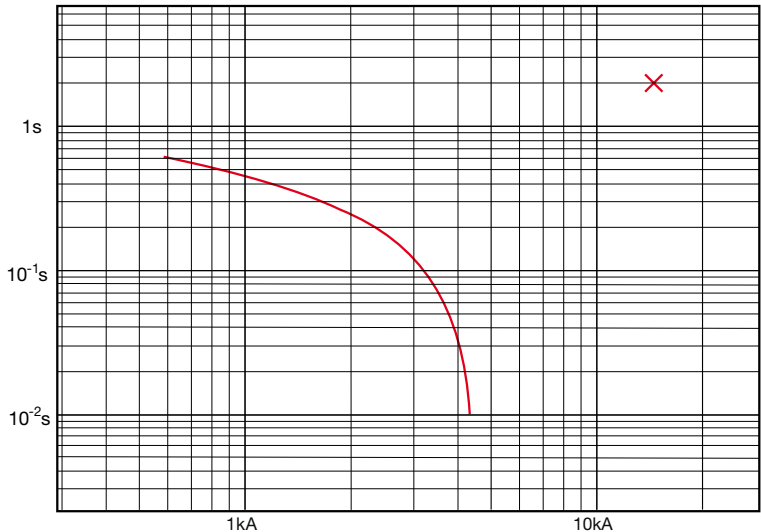



## 2 Protection of electrical equipment

In summary: for the correct protection of the transformer and to avoid unwanted trips, the trip curve of the protection device must be above the inrush current curve and below the thermal overload point under short circuit conditions.

### Choice of the circuit-breakers on the primary of a LV/LV transformer

These types of transformer are mainly used to supply control and switch auxiliary circuits, since they are often supplied at lower voltages in comparison with those for power distribution; another application example can be represented by the need of changing the neutral system according to the installation requirements.

As regards choice and settings of the circuit-breaker on the supply side of the primary, it is necessary to take into consideration both the “inrush current” phenomenon as well as the transformer maximum short-time thermal load capability, as described in the previous pages.

The following figure shows the possible positioning of the trip curve of a circuit-breaker on the primary of a 250kVA transformer at 690/400 with  $u_k=4\%$ .

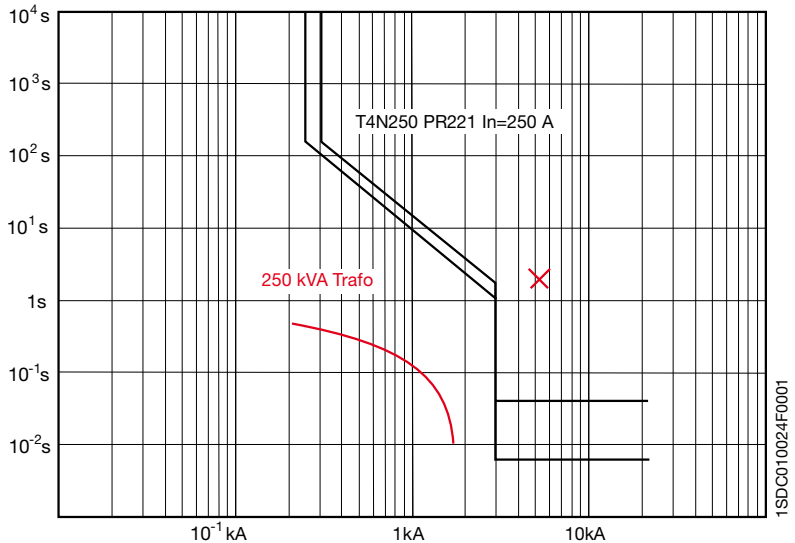

The following pages include some tables reporting - with reference to the rated voltage of the primary winding - the circuit-breaker suitable for the application.

As regards the circuit-breaker version, it is necessary to use one apparatus with  $I_{cu}$  value higher than the short-circuit current at the circuit-breaker installation point.

It is necessary to set properly the suggested circuit-breaker in order to obtain transformer protection as in the figure of the example of above, by paying particular attention to the indications reported in the previous pages.

## 2 Protection of electrical equipment

**V1n=400**

Transformer		ABB SACE Circuit-breaker			
$S_r$ [kVA]	Trafo $I_r$ [A]	Circuit-breaker with thermomagnetic release		Circuit-breaker with electronic release	
		Type	$I_n$ [A]	Type	$I_n$ [A]
1 x 63	91	XT1B-C-N-S-H	125	XT2N-S-H-L-V	160
1 x 100	144	XT3N-S	200	XT4N-S-H-L-V	250
1 x 125	180	XT3N-S	250	XT4N-S-H-L-V	250
1 x 160	231	XT4N-S-H-L-V	250	XT4N-S-H-L-V	250
1 x 200	289	T5N-S-H-L-V	320	T5N-S-H-L-V	400
1 x 250	361	T5N-S-H-L-V	400	T5N-S-H-L-V	400
1 x 315	455	T5N-S-H-L-V	500	T5N-S-H-L-V	630
1 x 400	577	T6N-S-H-L	630	T6N-S-H-L-V	630
1 x 500	722	T6N-S-H-L	800	T6N-S-H-L	800
1 x 630	909	-	-	T7S-H-L-V/ X1B-N	1000
1 x 800	1155	-	-	T7S-H-L-V/ X1B-N	1250
1 x 1000	1443	-	-	T7S-H-L / X1B-N	1600
1 x 1250	1804	-	-	E2B-N-S	2000
1 x 1600	2309	-	-	E3N-S-H-V	2500
1 x 2000	2887	-	-	E3N-S-H-V	3200

**V1n=440**

Transformer		ABB SACE Circuit-breaker			
$S_r$ [kVA]	Trafo $I_r$ [A]	Circuit-breaker with thermomagnetic release		Circuit-breaker with electronic release	
		Type	$I_n$ [A]	Type	$I_n$ [A]
1 x 63	83	XT1B-C-N-S-H	125	XT2N-S-H-L-V	160
1 x 100	131	XT3N-S	200	XT4N-S-H-L-V	250
1 x 125	164	XT3N-S	200	XT4N-S-H-L-V	250
1 x 160	210	XT4N-S-H-L-V	250	XT4N-S-H-L-V	250
1 x 200	262	T5N-S-H-L-V	320	T5N-S-H-L-V	400
1 x 250	328	T5N-S-H-L-V	400	T5N-S-H-L-V	400
1 x 315	413	T5N-S-H-L-V	500	T5N-S-H-L-V	630
1 x 400	526	T6N-S-H-L	630	T6N-S-H-L	630
1 x 500	656	T6N-S-H-L	800	T6N-S-H-L	800
1 x 630	827	-	-	T7S-H-L-V-X1B-N	1000
1 x 800	1050	-	-	T7S-H-L-V/ X1B-N	1250
1 x 1000	1312	-	-	T7S-H-L / X1B-N	1600
1 x 1250	1640	-	-	E2B-N-S	2000
1 x 1600	2099	-	-	E3N-S-H-V	2500
1 x 2000	2624	-	-	E3N-S-H-V	3200

## 2 Protection of electrical equipment

Vn=690

Transformer		ABB SACE Circuit-breaker			
S <sub>r</sub> [kVA]	Trafo I <sub>r</sub> [A]	Circuit-breaker with thermomagnetic release		Circuit-breaker with electronic release	
		Type	In [A]	Type	In [A]
1 x 63	53	XT1B-C-N-S-H	80	XT2N-S-H-L-V	80
1 x 100	84	XT1B-C-N-S-H	125	XT2N-S-H-L-V	160
1 x 125	105	XT1B-C-N-S-H	125	XT2N-S-H-L-V	160
1 x 160	134	XT1B-C-N-S-H	160	XT2N-S-H-L-V	160
1 x 200	168	XT3N-S	200	XT4N-S-H-L-V	250
1 x 250	209	XT4N-S-H-L-V	250	XT4N-S-H-L-V	250
1 x 315	264	T5N-S-H-L-V	320	T5N-S-H-L-V	400
1 x 400	335	T5N-S-H-L-V	400	T5N-S-H-L-V	400
1 x 500	419	T5N-S-H-L-V	500	T5N-S-H-L-V	630
1 x 630	528	T6N-S-H-L	630	T6N-S-H-L	800
1 x 800	670	T6N-S-H-L	800	T6N-S-H-L	800
1 x 1000	838	-	-	T7S-H-L-V/ X1B-N	1000
1 x 1250	1047	-	-	T7S-H-L-V/ X1B-N	1250
1 x 1600	1340	-	-	T7S-H-L / X1B-N	1600
1 x 2000	1676	-	-	E2B-N-S	2000

### Criteria for the selection of protection devices

For the protection on the LV side of MV/LV transformers, the selection of a circuit-breaker shall take into account:

- the rated current on LV side of the protected transformer (this value is the reference value for the rated current of the circuit-breaker and the setting of the protections);
- the maximum short-circuit current at the point of installation (this value determines the minimum breaking capacity ( $I_{cu}/I_{cs}$ ) of the protection device).

#### MV/LV unit with single transformer

The rated current on the LV side of the transformer ( $I_r$ ) is determined by the following formula:

$$I_r = \frac{1000 \cdot S_r}{\sqrt{3} \cdot U_{r20}} \quad [\text{A}] \quad (4)$$

where:

- $S_r$  is the rated power of the transformer [kVA];
- $U_{r20}$  is the rated LV no-load voltage of the transformer [V].

## 2 Protection of electrical equipment

The full voltage three-phase short-circuit current ( $I_k$ ), at the LV terminals of the transformer, can be expressed as (assuming that the short-circuit power of the network is infinite):

$$I_k = \frac{100 \cdot I_r}{u_k \%} \quad [\text{A}] \quad (5)$$

where:

$u_k \%$  is the short-circuit voltage of the transformer, in %.

The protection circuit-breaker must have: <sup>(1)</sup>

$$I_n \geq I_r;$$

$$I_{cu} (I_{cs}) \geq I_k.$$

If the short-circuit power of the upstream network is not infinite and cable or busbar connections are present, it is possible to obtain a more precise value for  $I_k$  by using formula (1), where  $Z_{\text{Net}}$  is the sum of the impedance of the network and of the impedance of the connection.

### *MV/LV substation with more than one transformer in parallel*

For the calculation of the rated current of the transformer, the above applies (formula 4).

The breaking capacity of each protection circuit-breaker on the LV side shall be higher than the short-circuit current equivalent to the short-circuit current of each equal transformer multiplied by the number of them minus one.

As can be seen from the diagram below, in the case of a fault downstream of a transformer circuit-breaker (circuit-breaker A), the short-circuit current that flows through the circuit-breaker is equal to the contribution of a single transformer. In the case of a fault upstream of the same circuit-breaker, the short-circuit current that flows is equal to the contribution of the other two transformers in parallel.

<sup>(1)</sup> To carry out correct protection against overload it is advisable to use thermometric equipment or other protection devices able to monitor temperature inside transformers.

## 2 Protection of electrical equipment

For a correct dimensioning, a circuit-breaker with a breaking capacity higher than twice the short-circuit current of one of the transformers must be chosen (assuming that all the transformers are equal and the loads are passive).

The circuit-breakers positioned on the outgoing feeders (circuit-breakers B) shall have a breaking capacity higher than the sum of the short-circuit currents of the three transformers, according to the hypothesis that the upstream network short-circuit power is 750 MVA and the loads are passive.

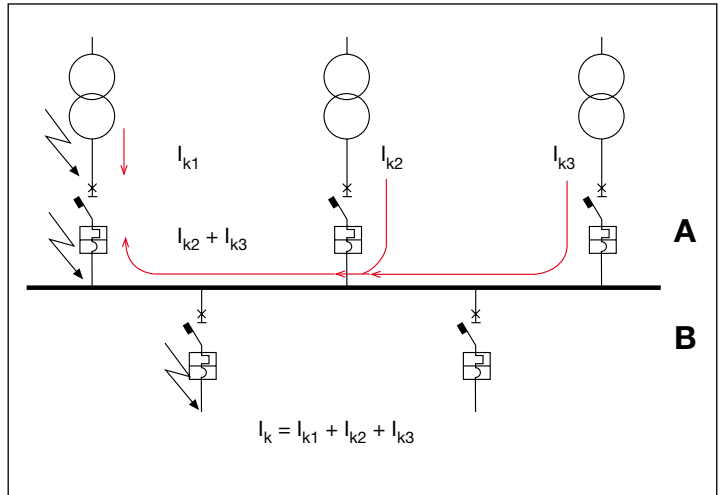

## 2 Protection of electrical equipment

### Selection of the circuit-breaker

The following tables show some possible choices of ABB SACE circuit-breakers, according to the characteristics of the transformer to be protected.

**Table 1: Protection and switching of 230 V transformers**

Transformer			Circuit-breaker "A" (LV side)												
S <sub>T</sub>	u <sub>k</sub>	Trafo I <sub>r</sub>	Busbar I <sub>b</sub>	Trafo feeder I <sub>k</sub>	ABB SACE Circuit-breaker	Release		Busbar I <sub>k</sub>							
						size I <sub>n</sub> [A]	minimum setting		[kA]	32 A	63 A	125 A	160 A	250 A	400 A
1 x 63	4	158	158	3.9	XT1B160*	160	1	3.9	S200	XT1B160					
2 x 63		158	316	3.9	XT1B160*	160	1	7.9	S200	XT1B160	XT3N250				
1 x 100	4	251	251	6.3	T4N320	320	0.79	6.3	S200	XT1B160					
2 x 100		251	502	6.2	T4N320	320	0.79	12.5	S200	XT1B160	XT3N250	T5N400			
1 x 125	4	314	314	7.8	T5N400	400	0.79	7.8	S200	XT1B160	XT3N250				
2 x 125		314	628	7.8	T5N400	400	0.79	15.6	S200	XT1B160	XT3N250	T5N400			
1 x 160	4	402	402	10.0	T5N630	630	0.64	10.0	S200	XT1B160	XT3N250				
2 x 160		402	803	9.9	T5N630	630	0.64	19.9	S200	XT1B160	XT3N250	T5N400			
1 x 200	4	502	502	12.5	T5N630	630	0.8	12.5	S200	XT1B160	XT3N250	T5N400			
2 x 200		502	1004	12.4	T5N630	630	0.8	24.8		XT1B160	XT3N250	T5N400			
1 x 250	4	628	628	15.6	T5N630	630	1	15.6	S200	XT1B160	XT3N250	T5N400			
2 x 250		628	1255	15.4	T5N630	630	1	30.9		XT1C160	XT3N250	T5N400			
1 x 315	4	791	791	19.6	T6N800	800	1	19.6		XT1B160	XT3N250	T5N400			
2 x 315		791	1581	19.4	T6N800	800	1	38.7		XT1C160	XT3N250	T5N400			
1 x 400	4	1004	1004	24.8	T7S1250/X1B1250**	1250	0.81	24.8		XT1B160	XT3N250	T5N400			
2 x 400		1004	2008	24.5	T7S1250/X1B1250**	1250	0.81	48.9		XT1N160	XT3N250	T5N400			
1 x 500	4	1255	1255	30.9	T7S1600/X1B1600**	1600	0.79	30.9		XT1C160	XT3N250	T5N400			
2 x 500		1255	2510	30.4	T7S1600/X1B1600**	1600	0.79	60.7		XT1N160	XT3S250	T5N400			
1 x 630	4	1581	1581	38.7	T7S1600/X1B1600**	1600	1	38.7		XT1C160	XT3N250	T5N400			
2 x 630		1581	3163	37.9	T7S1600/X1B1600**	1600	1	75.9		XT1S160	XT3S250	T5S400			
3 x 630	5	1581	4744	74.4	T7S1600/E2S1600	1600	1	111.6		XT2L160	XT4L250	T5L400			
1 x 800		2008	2008	39.3	E3N2500	2500	0.81	39.3		XT1C160	XT3N250	T5N400			
2 x 800	5	2008	4016	38.5	E3N2500	2500	0.81	77.0		XT1S160	XT3S250	T5S400			
3 x 800		2008	6025	75.5	E3H2500	2500	0.81	113.2		XT2L160	XT4L250	T5L400			
1 x 1000	5	2510	2510	48.9	E3N3200	3200	0.79	48.9		XT1N160	XT3N250	T5N400			
2 x 1000		2510	5020	47.7	E3N3200	3200	0.79	95.3		XT1H160	XT4H250	T5H400			
3 x 1000	5	2510	7531	93.0	E3H3200	3200	0.79	139.5		XT2L160	XT4L250	T5L400			
1 x 1250		3138	3138	60.7	E3N3200	3200	1	60.7		XT1N160	XT3S250	T5N400			
2 x 1250	5	3138	6276	58.8	E3N3200	3200	1	117.7		XT2L160	XT4L250	T5L400			
3 x 1250		3138	9413	114.1	E4V3200	3200	1	171.2		XT2V160	XT4V250	T5L400			

\* also Tmax series CBs equipped with electronic releases can be used for this application

\*\* Emox type E1 can be used for this application

## 2 Protection of electrical equipment

Circuit-breaker "B" (Feeder circuit-breaker)								
Feeder circuit-breaker type and rated current								
630 A	800 A	1000 A	1250 A	1600 A	2000 A	2500 A	3200 A	4000 A
T5N630								
T5N630								
T5N630	T6N800/X1B800							
T5N630	T6N800/X1B800	T7S1000/X1B1000	T7S1250/X1B1250					
T5N630	T6N800/X1B800							
T5N630	T6N800/X1N800	T7S1000/X1N1000	T7S1250/X1N1250	T7S1600/X1N1600				
T5N630	T6N800/X1B800							
T5N630	T6N800/X1N800	T7S1000/X1N1000	T7S1250/X1N1250	T7S1600/X1N1600	E2N2000			
T5N630	T6N800/X1B800	T7S1000/X1B1000	T7S1250/X1B1250					
T5S630	T6S800/E2S800	T7S1000/E2S1000	T7S1250/E2S1250	T7S1600/E2S1600	E2S2000	E3H2500		
T5L630	T6L800/E3V800	T7L1000/E3V1250	T7L1250/E3V1250	T7L1600/E3V1600	E3V2000	E3V2500	E3V3200	
T5N630	T6N800/X1B800	T7S1000/X1B1000	T7S1250/X1B1250	T7S1600/X1B1600				
T5S630	T6L800/E2S800	T7S1000/E2S1000	T7S1250/E2S1250	T7S1600/E2S1600	E2S2000	E3H2500	E3H3200	
T5L630	T6L800/E3V800	T7L1000/E3V1250	T7L1250/E3V1250	T7L1600/E3V1600	E3V2000	E3V2500	E4V3200	E4V4000
T5N630	T6N800/X1N800	T7S1000/X1N1000	T7S1250/X1N1250	T7S1600/X1N1600	E2N2000			
T5H630	T6H800/E3H800	T7H1000/E3H1000	T7H1250/E3H1250	T7H1600/E3H1600	E3H2000	E3H2500	E3H3200	E4H4000
T5L630	T6L800	T7L1000	T7L1250	T7L1600				
T5N630	T6N800/X1N800	T7S1000/X1N1000	T7S1250/X1N1250	T7S1600/X1N1600	E2N2000	E3N2500		
T5L630	T6L800/E3V800	T7L1000/E3V1250	T7L1250/E3V1250	T7L1600/E3V1600	E3V2000	E3V2500	E3V3200	E4V4000
T5L630	T6L800	T7L1000	T7L1250	T7L1600				

1SDC010035F0201

## 2 Protection of electrical equipment

**Table 2: Protection and switching of 400 V transformers**

Transformer				Circuit-breaker "A" (LV side)				Busbar I <sub>k</sub>						
S <sub>r</sub>	u <sub>k</sub>	Trafo I <sub>r</sub>	Busbar I <sub>b</sub>	Trafo feeder I <sub>k</sub>	ABB SACE Circuit-breaker	Release		[kA]	32 A	63 A	125 A	160 A	250 A	400 A
						size In [A]	minimum setting							
1 x 63	4	91	91	2.2	XT1B*	100	0.92	2.2	S200					
2 x 63		91	182	2.2	XT1B*	100	0.92	4.4	S200	XT1B160				
1 x 100	4	144	144	3.6	XT1B*	160	0.91	3.6	S200	XT1B160				
2 x 100		144	288	3.6	XT1B*	160	0.91	7.2	S200	XT1B160				
1 x 125	4	180	180	4.5	XT3N250*	200	0.73	4.5	S200	XT1B160				
2 x 125		180	360	4.4	XT3N250*	200	0.73	8.8	S200	XT1B160				
1 x 160	4	231	231	5.7	XT3N250*	250	0.93	5.7	S200	XT1B160				
2 x 160		231	462	5.7	XT3N250*	250	0.93	11.4	S200M	XT1B160			XT3N250	
1 x 200	4	289	289	7.2	T4N320	320	0.91	7.2	S200	XT1B160			XT3N250	
2 x 200		289	578	7.1	T4N320	320	0.91	14.2	S200M	XT1B160			XT3N250	T5N400
1 x 250	4	361	361	8.9	T5N400	400	0.91	8.9	S200	XT1B160			XT3N250	
2 x 250		361	722	8.8	T5N400	400	0.91	17.6		XT1B160			XT3N250	T5N400
1 x 315	4	455	455	11.2	T5N630	630	0.73	11.2	S200M	XT1B160			XT3N250	T5N400
2 x 315		455	910	11.1	T5N630	630	0.73	22.2		XT1C160			XT3N250	T5N400
1 x 400	4	577	577	14.2	T5N630	630	0.92	14.2	S200M	XT1B160			XT3N250	T5N400
2 x 400		577	1154	14	T5N630	630	0.92	28		XT1N160			XT3N250	T5N400
1 x 500	4	722	722	17.7	T6N800	800	0.91	17.7	XT1B160				XT3N250	T5N400
2 x 500		722	1444	17.5	T6N800	800	0.91	35.9		XT1N160			XT3N250	T5N400
1 x 630	4	909	909	22.3	T7S1000/X1B1000**	1000	0.91	22.3	XT1C160				XT3N250	T5N400
2 x 630		909	1818	21.8	T7S1000/X1B1000**	1000	0.91	43.6		XT1S160			XT3S250	T5S400
3 x 630	5	909	2727	42.8	T7S1000/X1N1000**	1000	0.91	64.2		XT1H160			XT4H250	T5H400
1 x 800		1155	1155	22.6	T7S1250/X1B1250**	1250	0.93	22.6		XT1C160			XT3N250	T5N400
2 x 800	5	1155	2310	22.1	T7S1250/X1B1250**	1250	0.93	44.3		XT1S160			XT3S250	T5S400
3 x 800		1155	3465	43.4	T7S1250/X1N1250**	1250	0.93	65		XT1H160			XT4H250	T5H400
1 x 1000	5	1443	1443	28.1	T7S1600/X1B1600**	1600	0.91	28.1		XT1N160			XT3N250	T5N400
2 x 1000		1443	2886	27.4	T7S1600/X1B1600**	1600	0.91	54.8		XT1H160			XT4H250	T5H400
3 x 1000	5	1443	4329	53.5	T7H1600/E2N1600	1600	0.91	80.2		XT2L160			XT4L250	T5L400
1 x 1250		1804	1804	34.9	E2B2000	2000	0.91	34.9		XT1N160			XT3N250	T5N400
2 x 1250	5	1804	3608	33.8	E2B2000	2000	0.91	67.7		XT1H160			XT4H250	T5H400
3 x 1250		1804	5412	65.6	E2S2000	2000	0.91	98.4		XT2L160			XT4L250	T5L400
1 x 1600	6.25	2309	2309	35.7	E3N2500	2500	0.93	35.7		XT1N160			XT3N250	T5N400
2 x 1600		2309	4618	34.6	E3N2500	2500	0.93	69.2		XT1H160			XT4H250	T5H400
3 x 1600	6.25	2309	6927	67	E3S2500	2500	0.93	100.6		XT2L160			XT4L250	T5L400
1 x 2000		2887	2887	44.3	E3N3200	3200	0.91	44.3		XT1S160			XT3S250	T5S400
2 x 2000	6.25	2887	5774	42.6	E3N3200	3200	0.91	85.1		XT2L160			XT4L250	T5L400
3 x 2000		2887	8661	81.9	E3H3200	3200	0.91	122.8		XT2V160			XT4V250	T5V400
1 x 2500	6.25	3608	3608	54.8	E4S4000	4000	0.91	54.8		XT1H160			XT4H250	T5H400
1 x 3125	6.25	4510	4510	67.7	E6H5000	5000	0.91	67.7		XT1H160			XT4H250	T5H400

\* also Tmax series CBs equipped with electronic releases can be used for this application

\*\* Emax type E1 can be used for this application



## 2 Protection of electrical equipment

Circuit-breaker "B" (Feeder circuit-breaker)								
Feeder circuit-breaker type and rated current								
630 A	800 A	1000 A	1250 A	1600 A	2000 A	2500 A	3200 A	4000 A
T5N630								
T5N630								
T5N630								
T5N630	T6N800/X1B800							
T5N630	T6N800/X1B800							
T5S630	T6S800/X1N800	T7S1000/X1N1000	T7S1250/X1N1250					
T5H630	T6H800/X1N800	T7H1000/X1N1000	T7H1250/X1N1250	T7H1600/X1N1600				
T5N630	T6N800/X1B800	T7S1000/X1B1000						
T5S630	T6S800/X1N800	T7S100/X1N1000	T7S1250/X1N1250	T7S1600/X1N1600				
T5H630	T6H800/X1N800	T7H1000/X1N1000	T7H1250/X1N1250	T7H1600/X1N1600	E2N2000	E3N2500		
T5N630	T6N800/X1B800	T7S100/X1B1000	T7S1250/X1B1250					
T5H400	T6H800/X1N800	T7H1000/X1N1000	T7H1250/X1N1250	T7H1600/X1N1600	E2N2000			
T5L630	T6L800/E2S800	T7L1000/E2S1000	T7L1250/E2S1250	T7L1600/E2S1600	E2S2000	E3H2500	E3H3200	
T5N630	T6N800/X1B800	T7S1000/X1B1000	T7S1250/X1B1250	T7S1600/X1B1600				
T5H630	T6H800/E2S800	T7H1000/E2S1000	T7H1250/E2S1250	T7H1600/E2S1600	E2S2000	E3S2500	E3S3200	
T5L630	T6L800/E3H800	T7L1000/E3H1000	T7L1250/E3H1250	T7L1600/E3H1600	E3H2000	E3H2500	E3H3200	E4H4000
T5N630	T6N800/X1B800	T7S1000/X1B1000	T7S1250/X1B1250	T7S1600/X1B1600				
T5H630	T6H800/E2S800	T7H1000/E2S1000	T7H1250/E2S1250	T7H1600/E2S1600	E2S2000	E3S2500	E3S3200	E4S4000
T5L630	T7L800/E3V800	T7L1000/E3V1250	T7L1250/E3V1250	T7L1600/E3V1600	E3V2000	E3V2500	E3V3200	E4V4000
T5S630	T6S800/X1N800	T7S1000/X1N1000	T7S1250/X1N1250	T7S1600/X1N1600	E2N2000			
T5L630	T6L800/E3H800	T7L1000/E3H1000	T7L1250/E3H1250	T7L1600/E3H1600	E3H2000	E3H2500	E3H3200	E4H4000
T5V630	T7V800/E3V800	T7V1000/E3V1000	T7V1250/E3V1250	E3V1600	E3V2000	E3V2500	E3V3200	E4V4000
T5H630	T6H800/X1N800	T7H1000/X1N1000	T7H1250/X1N1250	T7H1600/X1N1600	E2N2000	E3N2500	E3N3200	
T5H630	T6H800/E2S800	T7H1000/E2S1000	T7H1250/E2S1250	T7H1600/E2S1600	E2S2000	E3S2500	E3S3200	E4S4000

1SDC010036F0201

## 2 Protection of electrical equipment

**Table 3: Protection and switching of 440 V transformers**

Transformer				Circuit-breaker "A" (LV side)					Busbar I <sub>k</sub>					
S <sub>r</sub>	u <sub>k</sub>	Trafo I <sub>r</sub>	Busbar I <sub>b</sub>	Trafo feeder I <sub>k</sub>	ABB SACE Circuit-breaker	Release		Busbar I <sub>k</sub>	32 A	63 A	125 A	160 A	250 A	400 A
						size I <sub>n</sub> [A]	minimum setting							
1 x 63	4	83	83	2.1	XT1B160*	100	0.83	2.1	S200					
2 x 63		83	165	2.1	XT1B160*	100	0.83	4.1	S200	XT1B160				
1 x 100		131	131	3.3	XT1B160*	160	0.82	3.3	S200					
2 x 100		131	262	3.3	XT1B160*	160	0.82	6.5		XT1B160				
1 x 125	4	164	164	4.1	XT3N250*	200	0.82	4.1	S200	XT1B160				
2 x 125		164	328	4.1	XT3N250*	200	0.82	8.1		XT1B160			XT3N250	
1 x 160		210	210	5.2	XT3N250*	250	0.84	5.2	S200	XT1B160				
2 x 160		210	420	5.2	XT3N250*	250	0.84	10.4		XT1B160			XT3N250	
1 x 200	4	262	262	6.5	T4N320	320	0.82	6.5		XT1B160				
2 x 200		262	525	6.5	T4N320	320	0.82	12.9		XT1B160			XT3N250	T5N400
1 x 250		328	328	8.1	T5N400	400	0.82	8.1		XT1B160			XT3N250	
2 x 250		328	656	8.1	T5N400	400	0.82	16.1		XT1C160			XT3N250	T5N400
1 x 315	4	413	413	10.2	T5N630	630	0.66	10.2		XT1B160			XT3N250	
2 x 315		413	827	10.1	T5N630	630	0.66	20.2		XT1C160			XT3N250	T5N400
1 x 400		525	525	12.9	T5N630	630	0.83	12.9		XT1B160			XT3N250	T5N400
2 x 400		525	1050	12.8	T5N630	630	0.83	25.6		XT1N160			XT3S250	T5N400
1 x 500	4	656	656	16.1	T6N800	800	0.82	16.1		XT1C160			XT3N250	T5N400
2 x 500		656	1312	15.9	T6N800	800	0.82	31.7		XT1N160			XT3S250	T5S400
1 x 630		827	827	20.2	T7S1000/X1B1000**	1000	0.83	20.2		XT1C160			XT3N250	T5N400
2 x 630		827	1653	19.8	T7S1000/X1B1000**	1000	0.83	39.7		XT1S160			XT3S250	T5S400
3 x 630	5	827	2480	38.9	T7S1000/X1B1000**	1000	0.83	58.3		XT1H160			XT4H250	T5H400
1 x 800		1050	1050	20.6	T7S1250/X1B1250**	1250	0.84	20.6		XT1C160			XT3N250	T5N400
2 x 800		1050	2099	20.1	T7S1250/X1B1250**	1250	0.84	40.3		XT1S160			XT4S250	T5H400
3 x 800		1050	3149	39.5	T7S1250/X1B1250**	1250	0.84	59.2		XT1H160			XT4H250	T5H400
1 x 1000	5	1312	1312	25.6	T7S1600/X1B1600**	1600	0.82	25.6		XT1N160			XT3S250	T5N400
2 x 1000		1312	2624	24.9	T7S1600/X1B1600**	1600	0.82	49.8		XT1S160			XT4S250	T5H400
3 x 1000		1312	3936	48.6	T7H1600/X1N1600**	1600	0.82	72.9		XT2L160			XT4L250	T5L400
1 x 1250		1640	1640	31.7	E2B2000	2000	0.82	31.7		XT1N160			XT3S250	T5S400
2 x 1250	5	1640	3280	30.8	E2B2000	2000	0.82	61.5		XT1H160			XT4H250	T5H400
3 x 1250		1640	4921	59.6	E2N2000	2000	0.82	89.5		XT2L160			XT4L250	T5L400
1 x 1600		2099	2099	32.5	E3N2500	2500	0.84	32.5		XT1N160			XT3S250	T5S400
2 x 1600		2099	4199	31.4	E3N2500	2500	0.84	62.9		XT1H160			XT4H250	T5H400
3 x 1600	6.25	2099	6298	60.9	E3N2500	2500	0.84	91.4		XT2L160			XT4L250	T5L400
1 x 2000		2624	2624	40.3	E3N3200	3200	0.82	40.3		XT1S160			XT4S250	T5H400
2 x 2000		2624	5249	38.7	E3N3200	3200	0.82	77.4		XT2L160			XT4L250	T5L400
3 x 2000		2624	7873	74.4	E3S3200	3200	0.82	111.7		XT2V160			XT4V250	T5V400
1 x 2500	6.25	3280	3280	49.8	E4S4000	4000	0.82	49.8		XT1S160			XT4S250	T5H400
1 x 3125	6.25	4100	4100	61.5	E6H5000	5000	0.82	61.5		XT1H160			XT4H250	T5H400

\* also Tmax series CBs equipped with electronic releases can be used for this application

\*\* Emax type E1 can be used for this application

## 2 Protection of electrical equipment

Circuit-breaker "B" (Feeder circuit-breaker)								
Feeder circuit-breaker type and rated current								
630 A	800 A	1000 A	1250 A	1600 A	2000 A	2500 A	3200 A	4000 A
T5N630								
T5N630								
T5S630	T6S800/X1B800							
T5S630	T6S800/X1B800	T7S1000/X1B1000	T7S1250/X1B1250					
T5H630	T6L800/X1N800	T7H1000/X1N1000	T7H1250/X1N1250	T7H1600/X1N1600	E2N2000			
T5N630	T6N800/X1B800							
T5H630	T6S800/X1B800	T7S1000/X1B1000	T7S1250/X1B1250	T7S1600/X1B1600				
T5H630	T6L800/X1N800	T7H1000/X1N1000	T7H1250/X1N1250	T7H1600/X1N1600	E2N2000	E3N2500	E3N3200	E4S4000
T5N630	T6N800/X1B800							
T5H630	T6H800/E1N800	T7S1000/X1N1000	T7S1250/X1N1250	T7S1600/X1N1600	E2N2000			
T5L630	T6L800/E2S800	T7L1000/E2S1000	T7L1250/E2S1250	T7L1600/E2S1600	E3S2000	E3S2500	E3S3200	
T5S630	T6S800/X1B800	T7S1000/X1B1000	T7S1250/X1B1250					
T5H630	T6L800/X1N800	T7H1000/X1N1000	T7H1250/XN1250	T7H1600/X1N1600	E2N2000	E3N2500		
T5L630	T7L800/E3H800	T7L1000/E3H1000	T7L1250/E3H1250	T7L1600/E3H1600	E3H2000	E3H2500	E3H3200	E4H4000
T5S630	T6S800/X1B800	T7S1000/X1B1000	T7S1250/X1B1250	T7S1600/X1B1600				
T5H630	T6L800/X1N800	T7H1000/X1N1000	T7H1250/X1N1250	T7H1600/X1N1600	E2N2000	E3N2500	E3N3200	
T5L630	T7L800/E3H800	T7L1000/E3H1000	T7L1250/E3H1250	T7L1600/E3H1600	E3H2000	E3H2500	E3H3200	E4H4000
T5H630	T6S800/X1B800	T7S1000/X1B1000	T7S1250/X1B1250	T7S1600/X1B1600	E2B2000			
T5L630	T6L800/E2S800	T7L1000/E2S1000	T7L1250/E2S1250	T7L1600/E2S1600	E3H2000	E3H2500	E3H3200	E4H4000
T5V630	T7V800/E3V800	T7V1000/E3V1000	T7V1250/E3V1250	E3V1600	E3V2000	E3V2500	E3V3200	E4V4000
T5H630	T6H800/X1N800	T7S1000/X1N1000	T7S1250/X1N1250	T7S1600/X1N1600	E2N2000	E3N2500		
T5H630	T6L800/X1N800	T7H1000/X1N1000	T7H1250/X1N1250	T7H1600/X1N1600	E2N2000	E3N2500	E3N3200	

1SD0010037F0201

## 2 Protection of electrical equipment

**Table 4: Protection and switching of 690 V transformers**

Transformer				Circuit-breaker "A" (LV side)				Release						
S <sub>r</sub>	u <sub>k</sub>	Trafo I <sub>r</sub>	Busbar I <sub>b</sub>	Trafo feeder I <sub>k</sub>	ABB SACE Circuit-breaker	Release		Busbar I <sub>k</sub>	32 A	63 A	125 A	160 A	250 A	400 A
						size In [A]	minimum setting							
[kVA]	[%]	[A]	[A]	[kA]				[kA]						
1 x 63	4	53	53	1.3	XT1B*	63	0.84	1.3	XT1B160					
2 x 63		53	105	1.3	XT1B*	63	0.84	2.6	XT1B160					
1 x 100		84	84	2.1	XT1B*	100	0.84	2.1	XT1B160					
2 x 100		84	167	2.1	XT1B*	100	0.84	4.2	XT1N160					
1 x 125	4	105	105	2.6	XT1B*	125	0.84	2.6	XT1B160					
2 x 125		105	209	2.6	XT1B*	125	0.84	5.2	XT1N160					
1 x 160		134	134	3.3	XT1C*	160	0.84	3.3	XT1C160					
2 x 160		134	268	3.3	XT1C*	160	0.84	6.6	XT1S160					
1 x 200	4	167	167	4.2	XT3N250*	200	0.84	4.2	XT1N160					
2 x 200		167	335	4.1	XT3N250*	200	0.84	8.3	XT1H160			XT4N250		
1 x 250		209	209	5.2	XT3S250*	250	0.84	5.2	XT1N160					
2 x 250		209	418	5.1	XT3S250*	250	0.84	10.3	XT2S160			XT4S250		
1 x 315	4	264	264	6.5	T4N320	320	0.82	6.5	XT1S160					
2 x 315		264	527	6.5	T4N320	320	0.82	12.9	XT2H160			XT4H250	T5N400	
1 x 400		335	335	8.3	T5N400	400	0.84	8.3	XT1H160			XT4N250		
2 x 400		335	669	8.2	T5N400	400	0.84	16.3	XT2L160			XT4L250	T5N400	
1 x 500	4	418	418	10.3	T5N630	630	0.66	10.3	XT2S160			XT4S250		
2 x 500		418	837	10.1	T5N630	630	0.66	20.2	XT4V250			XT4V250	T5S400	
1 x 630		527	527	12.9	T5N630	630	0.84	12.9	XT2H160			XT4H250	T5N400	
2 x 630		527	1054	12.6	T5N630	630	0.84	25.3	T4H250***			T4H250***	T5H400	
3 x 630	5	527	1581	24.8	T5S630	630	0.84	37.2	T4H250***			T4H250***	T5H400	
1 x 800		669	669	13.1	T6N800	800	0.84	13.1	XT2H160			XT4H250	T5N400	
2 x 800		669	1339	12.8	T6N800	800	0.84	25.7	T4H250***			T4H250***	T5H400	
3 x 800		669	2008	25.2	T6L800	800	0.84	37.7	T4H250***			T4H250***	T5H400	
1 x 1000	5	837	837	16.3	T7S1000/X1B1000**	1000	0.84	16.3	XT2L160			XT4L250	T5N400	
2 x 1000		837	1673	15.9	T7S1000/X1B1000**	1000	0.84	31.8	T4H250***			T4H250***	T5H400	
3 x 1000		837	2510	31.0	T7H1000/X1B1000**	1000	0.84	46.5	T4L250***			T4L250***	T5L400	
1 x 1250		1046	1046	20.2	T7S1250/X1B1250**	1250	0.84	20.2	XT4V250			XT4V250	T5S400	
2 x 1250	5	1046	2092	19.6	T7S1250/X1B1250**	1250	0.84	39.2	T4H250***			T4H250***	T5H400	
3 x 1250		1046	3138	38.0	T7H1250/X1B1250**	1250	0.84	57.1	T4L250***			T4L250***	T5L400	
1 x 1600		1339	1339	20.7	T7S1600/X1B1600**	1600	0.84	20.7	XT4V250			XT4V250	T5S400	
2 x 1600		1339	2678	20.1	T7S1600/X1B1600**	1600	0.84	40.1	T4L250***			T4L250***	T5L400	
3 x 1600	6.25	1339	4016	38.9	T7H1600/X1B1600**	1600	0.84	58.3	T4L250***			T4L250***	T5L400	
1 x 2000		1673	1673	25.7	E2B2000	2000	0.84	25.7	T4H250***			T4H250***	T5H400	
2 x 2000		1673	3347	24.7	E2B2000	2000	0.84	49.3	T4L250***			T4L250***	T5L400	
3 x 2000		1673	5020	47.5	E2N2000	2000	0.84	71.2	T4V250***			T4V250***	T5V400	
1 x 2500	6.25	2092	2092	31.8	E3N2500	2500	0.84	31.8	T4H250***			T4H250***	T5H400	
1 x 3125	6.25	2615	2615	39.2	E3N3200	3200	0.82	39.2	T4H250***			T4H250***	T5H400	

\* also Tmax series CBs equipped with electronic releases can be used for this application

\*\* Emax type E1 can be used for this application

\*\*\* For XT4V with I<sub>cu</sub> = 90kA at 690V, please ask ABB SACE

# 2 Protection of electrical equipment

Circuit-breaker "B" (Feeder circuit-breaker)								
Feeder circuit-breaker type and rated current								
630 A	800 A	1000 A	1250 A	1600 A	2000 A	2500 A	3200 A	4000 A
T5S630								
T5H630								
T5H630	T7H800/X1B800	T7H1000/X1B1000	T7H1250/X1B1250					
T5H630								
T5H630	T6L800/X1B800							
T5H630	T7H800/X1N800	T7H1000/X1N1000	T7H1250/X1N1250	T7H1600/X1N1600				
T5N630								
T5H630	T7H800/X1B800	T7H1000/X1B1000	T7H1250/X1B1250					
T5L630	T7L800/X1N800	T7L1000/X1N1000	T7L1250/X1N1250	T7L1600/X1N1600	E2N2000			
T5S630	T6S800/X1B800							
T5H630	T7H800/X1B800	T7H1000/X1B1000	T7H1250/X1B1250	T7H1600/X1N1600				
T5L630	T7V800/E2S800	T7V1000/E2S1000	T7V1250/ES21250	E2S1600	E2S2000			
T5S630	T6S800/X1B800	T7S1000/X1B1000						
T5L630	T7H800/X1B800	T7H1000/X1B1000	T7H1250/X1B1250	T7H1600/X1B1600	E2B2000			
T5L630	T7V800/E2S800	T7V1000/X1B1000	T7V1250/ES21250	E2S1600	E2S2000	E3N2500	E3N3200	
T5H630	T6L800/X1N800	T7S1000/E2S1000	T7S1250/X1N1250					
T5L630	T7L800/X1N800	T7L1000/X1N1000	T7L1250/X1N1250	T7L1600/X1N1600	E2N2000	E3N2500		
T5V630	E3S1000		E3S1250	E3S1600	E3S2000	E3S2500	E3S3200	E4S4000
T5H630	T7H800/X1B800	T7H1000/X1B1000	T7H1250/X1B1250	T7H1600/X1B1600				
T5H630	T7H800/X1B800	T7H1000/X1B1000	T7H1250/X1B1250	T7H1600/X1B1600	E2B2000			

1SDC010038F0201

## 2 Protection of electrical equipment

### NOTE

The tables refer to the previously specified conditions; the information for the selection of circuit-breakers is supplied only with regard to the current in use and the prospective short-circuit current. For a correct selection, other factors such as selectivity, back-up protection, the decision to use limiting circuit-breakers etc. must also be considered. Therefore, it is essential that the design engineers carry out precise checks.

It must also be noted that the short-circuit currents given are determined using the hypothesis of 750 MVA power upstream of the transformers, disregarding the impedances of the busbars or the connections to the circuit-breakers.

### Example:

Supposing the need to size breakers A1/A2/A3, on the LV side of the three transformers of 630 kVA 20/0.4 kV with  $u_k\%$  equal to 4% and outgoing feeder circuit-breakers B1/B2/B3 of 63-400-800 A:

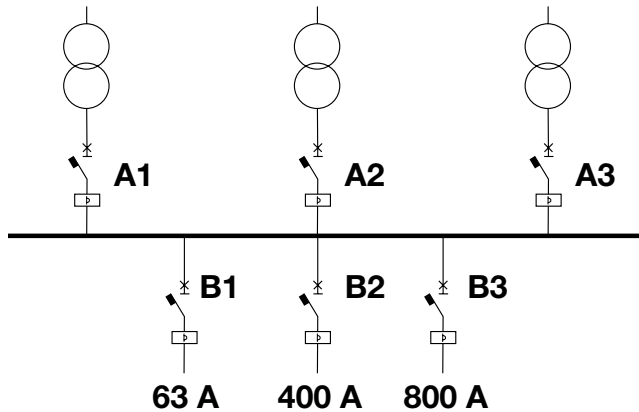

1SDC010026F0001

## 2 Protection of electrical equipment

From Table 2, corresponding to the row relevant to 3x630 kVA transformers, it can be read that:

### Level A circuit-breakers (LV side of transformer)

- trafo  $I_r$  (909 A) is the current that flows through the transformer circuit-breakers;
- busbar  $I_b$  (2727 A) is the maximum current that the transformers can supply;
- trafo feeder  $I_k$  (42.8 kA) is the value of the short-circuit current to consider for the choice of the breaking capacity of each of the transformer circuit-breakers;
- T7S1000 or X1N1000 is the size of the transformer circuit-breaker;
- $I_n$  (1000 A) is the rated current of the transformer circuit-breaker (electronic release chosen by the user);
- the minimum value 0.91 indicate the minimum settings of the L function of the electronic releases for CBs T7S1000 and X1N1000.

### Level B circuit-breakers (outgoing feeder)

- busbar  $I_k$  (64.2 kA) is the short-circuit current due to the contribution of all three transformers;
- corresponding to 63 A, read circuit-breaker B1 Tmax XT1H160;
- corresponding to 400 A, read circuit-breaker B2 Tmax T5H400;
- corresponding to 800 A, read circuit-breaker B3 Tmax T6H800 or Emax X1N800.

The choice made does not take into account discrimination/back-up requirements. Refer to the relevant chapters for selections appropriate to the various cases.

---

## 3 Power factor correction

---

### 3.1 General aspects

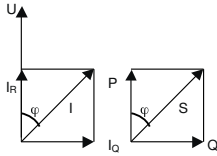

In alternating current circuits, the current absorbed by the user can be represented by two components:

- the active component  $I_R$ , in phase with the supply voltage, is directly correlated to the output (and therefore to the part of electrical energy transformed into energy of a different type, usually electrical with different characteristics, mechanical, light and/or thermal);
- the reactive component  $I_Q$ , in quadrature to the voltage, is used to produce the flow necessary for the conversion of powers through the electric or magnetic field. Without this, there could be no flow of power, such as in the core of a transformer or in the air gap of a motor.

In the most common case, in the presence of ohmic-inductive type loads, the total current ( $I$ ) lags in comparison with the active component  $I_R$ .

In an electrical installation, it is necessary to generate and transmit, other than the active power  $P$ , a certain reactive power  $Q$ , which is essential for the conversion of electrical energy, but not available to the user. The complex of the power generated and transmitted constitutes the apparent power  $S$ .

Power factor ( $\cos\varphi$ ) is defined as the ratio between the active component  $I_R$  and the total value of the current  $I$ ;  $\varphi$  is the phase shifting between the voltage  $U$  and the current  $I$ .

It results:

$$\cos\varphi = \frac{I_R}{I} = \frac{P}{S} \quad (1)$$

The reactive demand factor ( $\tan\varphi$ ) is the relationship between the reactive power and the active power:

$$\tan\varphi = \frac{Q}{P} \quad (2)$$



### 3 Power factor correction

Table 1 shows some typical power factors:

**Table 1: Typical power factor**

Load	$\cos\varphi$	$\tan\varphi$
	power factor	reactive demand factor
Transformers (no load condition)	0.1÷0.15	9.9÷6.6
Motor (full load)	0.7÷0.85	1.0÷0.62
Motor (no load)	0.15	6.6
Metal working apparatuses:		
- Arc welding	0.35÷0.6	2.7÷1.3
- Arc welding compensated	0.7÷0.8	1.0÷0.75
- Resistance welding:	0.4÷0.6	2.3÷1.3
- Arc melting furnace	0.75÷0.9	0.9÷0.5
Fluorescent lamps		
- compensated	0.9	0.5
- uncompensated	0.4÷0.6	2.3÷1.3
Mercury vapour lamps	0.5	1.7
Sodium vapour lamp	0.65÷0.75	1.2÷0.9
AC DC converters	0.6÷0.95	1.3÷0.3
DC drives	0.4÷0.75	2.3÷0.9
AC drives	0.95÷0.97	0.33÷0.25
Resistive load	1	0

The power factor correction is the action increasing the power factor in a specific section of the installation by locally supplying the necessary reactive power, so as to reduce the current value to the equivalent of the power required, and therefore the total power absorbed from the upstream side. Thus, the supply lines, the generator and the transformers can be sized for a lower apparent power value required by the load.

In detail, as shown by Figure 1 and Figure 2, increasing the power factor of the load:

- decreases the relative voltage drop  $u_{rp}$  per unit of active power transmitted;
- increases the transmittable active power and decreases the losses, the other dimensioning parameters remaining equal.

### 3 Power factor correction

**Figure 1: Relative voltage drop**

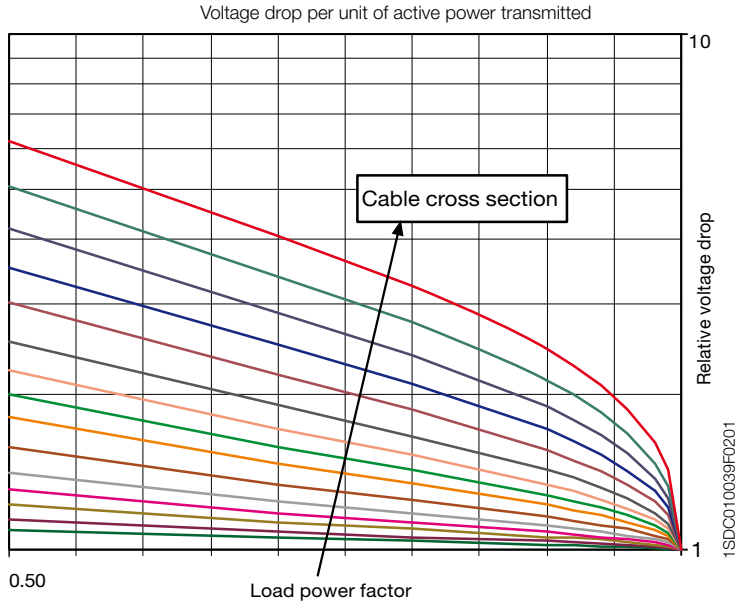

**Figure 2: Transmittable active power**

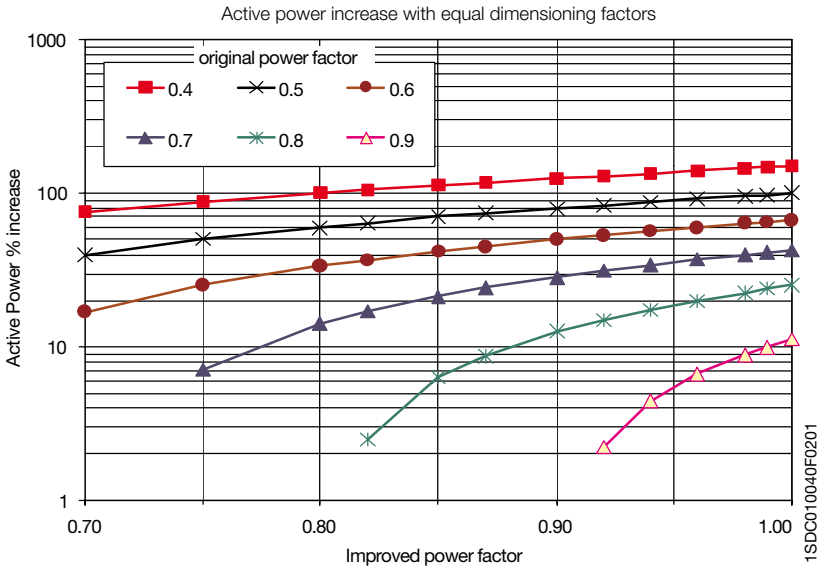

### 3 Power factor correction

The distribution authority is responsible for the production and transmission of the reactive power required by the user installations, and therefore has a series of further inconveniences which can be summarized as:

- oversizing of the conductors and of the components of the transmission lines;
- higher Joule-effect losses and higher voltage drops in the components and lines.

The same inconveniences are present in the distribution installation of the final user. The power factor is an excellent index of the size of the added costs and is therefore used by the distribution authority to define the purchase price of the energy for the final user.

The ideal situation would be to have a  $\cos\varphi$  slightly higher than the set reference so as to avoid payment of legal penalties, and at the same time not to risk having, with a  $\cos\varphi$  too close to the unit, a leading power factor when the power factor corrected device is working with a low load.

The distribution authority generally does not allow others to supply reactive power to the network, also due to the possibility of unexpected overvoltages.

In the case of a sinusoidal waveform, the reactive power necessary to pass from one power factor  $\cos\varphi_1$  to a power factor  $\cos\varphi_2$  is given by the formula:

$$Q_c = Q_2 - Q_1 = P \cdot (\tan\varphi_1 - \tan\varphi_2) \quad (3)$$

where:

P is the active power;

$Q_1, \varphi_1$  are the reactive power and the phase shifting before power factor correction;

$Q_2, \varphi_2$  are the reactive power and the phase shifting after power factor correction;

$Q_c$  is the reactive power for the power factor correction.

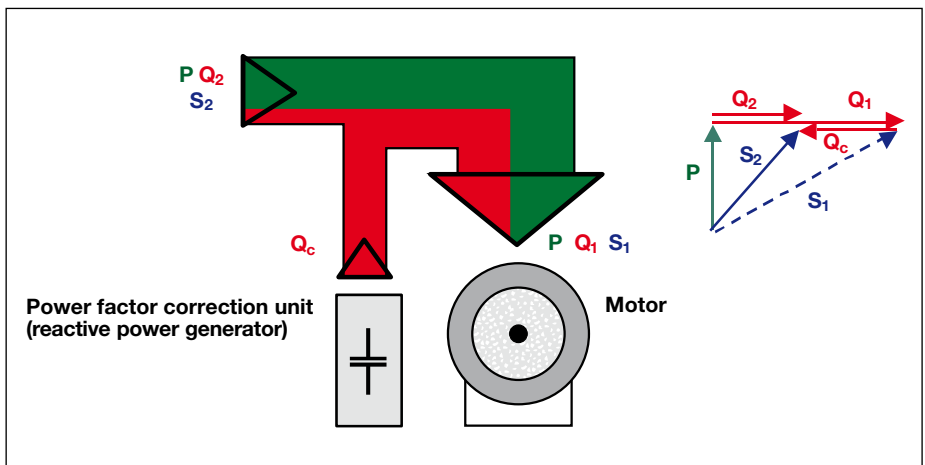

### 3 Power factor correction

Table 2 shows the value of the relationship

$$K_c = \frac{Q_c}{P} = \tan\varphi_1 - \tan\varphi_2 \quad (4)$$

for different values of the power factor before and after the correction.

**Table 2: Factor  $K_c$**

$K_c$	$\cos\varphi_2$													
$\cos\varphi_1$	0.80	0.85	0.90	0.91	0.92	0.93	0.94	0.95	0.96	0.97	0.98	0.99	1	
0.60	0.583	0.714	0.849	0.878	0.907	0.938	0.970	1.005	1.042	1.083	1.130	1.191	1.333	
0.61	0.549	0.679	0.815	0.843	0.873	0.904	0.936	0.970	1.007	1.048	1.096	1.157	1.299	
0.62	0.515	0.646	0.781	0.810	0.839	0.870	0.903	0.937	0.974	1.015	1.062	1.123	1.265	
0.63	0.483	0.613	0.748	0.777	0.807	0.837	0.870	0.904	0.941	0.982	1.030	1.090	1.233	
0.64	0.451	0.581	0.716	0.745	0.775	0.805	0.838	0.872	0.909	0.950	0.998	1.058	1.201	
0.65	0.419	0.549	0.685	0.714	0.743	0.774	0.806	0.840	0.877	0.919	0.966	1.027	1.169	
0.66	0.388	0.519	0.654	0.683	0.712	0.743	0.775	0.810	0.847	0.888	0.935	0.996	1.138	
0.67	0.358	0.488	0.624	0.652	0.682	0.713	0.745	0.779	0.816	0.857	0.905	0.966	1.108	
0.68	0.328	0.459	0.594	0.623	0.652	0.683	0.715	0.750	0.787	0.828	0.875	0.936	1.078	
0.69	0.299	0.429	0.565	0.593	0.623	0.654	0.686	0.720	0.757	0.798	0.846	0.907	1.049	
0.70	0.270	0.400	0.536	0.565	0.594	0.625	0.657	0.692	0.729	0.770	0.817	0.878	1.020	
0.71	0.242	0.372	0.508	0.536	0.566	0.597	0.629	0.663	0.700	0.741	0.789	0.849	0.992	
0.72	0.214	0.344	0.480	0.508	0.538	0.569	0.601	0.635	0.672	0.713	0.761	0.821	0.964	
0.73	0.186	0.316	0.452	0.481	0.510	0.541	0.573	0.608	0.645	0.686	0.733	0.794	0.936	
0.74	0.159	0.289	0.425	0.453	0.483	0.514	0.546	0.580	0.617	0.658	0.706	0.766	0.909	
0.75	0.132	0.262	0.398	0.426	0.456	0.487	0.519	0.553	0.590	0.631	0.679	0.739	0.882	
0.76	0.105	0.235	0.371	0.400	0.429	0.460	0.492	0.526	0.563	0.605	0.652	0.713	0.855	
0.77	0.079	0.209	0.344	0.373	0.403	0.433	0.466	0.500	0.537	0.578	0.626	0.686	0.829	
0.78	0.052	0.183	0.318	0.347	0.376	0.407	0.439	0.474	0.511	0.552	0.599	0.660	0.802	
0.79	0.026	0.156	0.292	0.320	0.350	0.381	0.413	0.447	0.484	0.525	0.573	0.634	0.776	
0.80		0.130	0.266	0.294	0.324	0.355	0.387	0.421	0.458	0.499	0.547	0.608	0.750	
0.81		0.104	0.240	0.268	0.298	0.329	0.361	0.395	0.432	0.473	0.521	0.581	0.724	
0.82		0.078	0.214	0.242	0.272	0.303	0.335	0.369	0.406	0.447	0.495	0.556	0.698	
0.83		0.052	0.188	0.216	0.246	0.277	0.309	0.343	0.380	0.421	0.469	0.530	0.672	
0.84		0.026	0.162	0.190	0.220	0.251	0.283	0.317	0.354	0.395	0.443	0.503	0.646	
0.85			0.135	0.164	0.194	0.225	0.257	0.291	0.328	0.369	0.417	0.477	0.620	
0.86			0.109	0.138	0.167	0.198	0.230	0.265	0.302	0.343	0.390	0.451	0.593	
0.87			0.082	0.111	0.141	0.172	0.204	0.238	0.275	0.316	0.364	0.424	0.567	
0.88			0.055	0.084	0.114	0.145	0.177	0.211	0.248	0.289	0.337	0.397	0.540	
0.89			0.028	0.057	0.086	0.117	0.149	0.184	0.221	0.262	0.309	0.370	0.512	
0.90				0.029	0.058	0.089	0.121	0.156	0.193	0.234	0.281	0.342	0.484	

## 3 Power factor correction

### Example

Supposing the need to change from 0.8 to 0.93 the power factor of a three-phase installation ( $U_n = 400 \text{ V}$ ) which absorbs an average power of 300 kW. From Table 2, at the intersection of the column corresponding to the final power factor (0.93), and the row corresponding to the starting power factor (0.8), the value of  $K_c$  (0.355) can be read. The reactive power  $Q_c$  which must be generated locally shall be:

$$Q_c = K_c \cdot P = 0.355 \cdot 300 = 106.5 \text{ Kvar}$$

Due to the effect of power factor correction, the current absorbed decreases from 540 A to 460 A (a reduction of approximately 15%).

### Characteristics of power factor correction capacitor banks

The most economical means of increasing the power factor, especially for an installation which already exists, is installing capacitors.

Capacitors have the following advantages:

- low cost compared with synchronous compensators and electronic power converters;
- ease of installation and maintenance;
- reduced losses (less than 0.5 W/kvar in low voltage);
- the possibility of covering a wide range of powers and different load profiles, simply supplying in parallel different combinations of components, each with a relatively small power.

The disadvantages are sensitivity to overvoltages and to the presence of non-linear loads.

The Standards applicable to power factor correction capacitors are as follows:

- IEC 60831-1 *“Shunt power capacitors of the self-healing type for a.c. systems having a rated voltage up to and including 1000 V - Part 1: General - Performance, testing and rating - Safety requirements - Guide for installation and operation”*;
- IEC 60931-1 *“Shunt power capacitors of the non-self-healing type for a.c. systems having a rated voltage up to and including 1000 V - Part 1: General - Performance, testing and rating - Safety requirements - Guide for installation and operation”*.

## 3 Power factor correction

The characteristics of a capacitor, given on its nameplate, are:

- rated voltage  $U_r$ , which the capacitor must withstand indefinitely;
- rated frequency  $f_r$  (usually equal to that of the network);
- rated power  $Q_c$ , generally expressed in kvar (reactive power of the capacitor bank).

From this data it is possible to find the size characteristics of the capacitors by using the following formulae (5):

	Single-phase connection	Three-phase star-connection	Three-phase delta-connection
Capacity of the capacitor bank	$C = \frac{Q_c}{2 \pi f_r \cdot U_r^2}$	$C = \frac{Q_c}{2 \pi f_r \cdot U_r^2}$	$C = \frac{Q_c}{2 \pi f_r \cdot U_r^2 \cdot 3}$
Rated current of the components	$I_{rc} = 2 \pi f_r \cdot C \cdot U_r$	$I_{rc} = 2 \pi f_r \cdot C \cdot U_r / \sqrt{3}$	$I_{rc} = 2 \pi f_r \cdot C \cdot U_r$
Line current	$I_l = I_{rc}$	$I_l = I_{rc}$	$I_l = I_{rc} \cdot \sqrt{3}$

1SDC010005F0301

$U_r$  = line voltage system

In a three-phase system, to supply the same reactive power, the star connection requires a capacitor with a capacitance three times higher than the delta-connected capacitor.

In addition, the capacitor with the star connection results to be subjected to a voltage  $\sqrt{3}$  lower and flows through by a current  $\sqrt{3}$  higher than a capacitor inserted and delta connected.

Capacitors are generally supplied with connected discharge resistance, calculated so as to reduce the residual voltage at the terminals to 75 V in 3 minutes, as stated in the reference Standard.

## 3.2 Power factor correction method

### Single PFC

Single or individual power factor correction is carried out by connecting a capacitor of the correct value directly to the terminals of the device which absorbs reactive power.

Installation is simple and economical: capacitors and load can use the same overload and short-circuit protection, and are connected and disconnected simultaneously.

The adjustment of  $\cos\varphi$  is systematic and automatic with benefit not only to the energy distribution authority, but also to the whole internal distribution system of the user.

This type of power factor correction is advisable in the case of large users with constant load and power factor and long connection times.

Individual PFC is usually applied to motors and fluorescent lamps. The capacitor units or small lighting capacitors are connected directly to loads.

## 3 Power factor correction

### Individual PFC of motors

The usual connection diagrams are shown in the following figure:

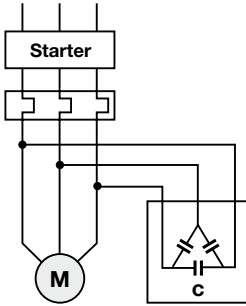

Diagram 1

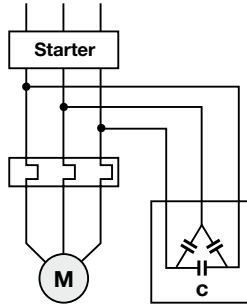

Diagram 2

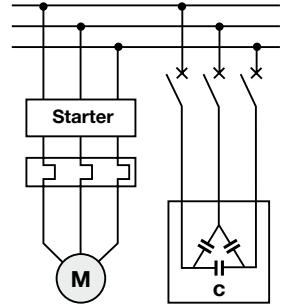

Diagram 3

In the case of direct connection (diagrams 1 and 2) there is a risk that after disconnection of the supply, the motor will continue to rotate (residual kinetic energy) and self-excite with the reactive energy supplied by the capacitor bank, acting as an asynchronous generator. In this case, the voltage is maintained on the load side of the switching and control device, with the risk of dangerous overvoltages of up to twice the rated voltage value.

However, in the case of diagram 3, to avoid the risk detailed above, the normal procedure is to connect the PFC bank to the motor only when it is running, and to disconnect it before the disconnection of the motor supply.

As a general rule, for a motor with power  $P_r$ , it is advisable to use a PFC with reactive power  $Q_c$  below 90% of the reactive power absorbed by the no-load motor  $Q_0$ , at rated voltage  $U_r$ , to avoid a leading power factor.

Considering that under no-load conditions, the current absorbed  $I_0$  [A] is solely reactive, if the voltage is expressed in volts, it results:

$$Q_c = 0.9 \cdot Q_0 = 0.9 \cdot \frac{\sqrt{3} \cdot U_r \cdot I_0}{1000} \text{ [kvar]} \quad (6)$$

The current  $I_0$  is generally given in the documentation supplied by the manufacturer of the motor.

### 3 Power factor correction

Table 3 shows the values of reactive power for power factor correction of some ABB motors, according to the power and the number of poles.

**Table 3: Reactive power for power factor motor correction**

$P_r$ [kW]	$Q_c$ [kvar]	Before PFC		After PFC	
		$\cos\varphi_r$	$I_r$ [A]	$\cos\varphi_2$	$I_2$ [A]
<b>400V / 50 Hz / 2 poles / 3000 r/min</b>					
7.5	2.5	0.89	13.9	0.98	12.7
11	2.5	0.88	20	0.95	18.6
15	5	0.9	26.5	0.98	24.2
18.5	5	0.91	32	0.98	29.7
22	5	0.89	38.5	0.96	35.8
30	10	0.88	53	0.97	47.9
37	10	0.89	64	0.97	58.8
45	12.5	0.88	79	0.96	72.2
55	15	0.89	95	0.97	87.3
75	15	0.88	131	0.94	122.2
90	15	0.9	152	0.95	143.9
110	20	0.86	194	0.92	181.0
132	30	0.88	228	0.95	210.9
160	30	0.89	269	0.95	252.2
200	30	0.9	334	0.95	317.5
250	40	0.92	410	0.96	391.0
315	50	0.92	510	0.96	486.3
<b>400V / 50 Hz / 4 poles / 1500 r/min</b>					
7.5	2.5	0.86	14.2	0.96	12.7
11	5	0.81	21.5	0.96	18.2
15	5	0.84	28.5	0.95	25.3
18.5	7.5	0.84	35	0.96	30.5
22	10	0.83	41	0.97	35.1
30	15	0.83	56	0.98	47.5
37	15	0.84	68	0.97	59.1
45	20	0.83	83	0.97	71.1
55	20	0.86	98	0.97	86.9
75	20	0.86	135	0.95	122.8
90	20	0.87	158	0.94	145.9
110	30	0.87	192	0.96	174.8
132	40	0.87	232	0.96	209.6
160	40	0.86	282	0.94	257.4
200	50	0.86	351	0.94	320.2
250	50	0.87	430	0.94	399.4
315	60	0.87	545	0.93	507.9



### 3 Power factor correction

P [kW]	Q <sub>c</sub> [kvar]	Before PFC		After PFC	
		cosφ <sub>r</sub>	I <sub>r</sub> [A]	cosφ <sub>2</sub>	I <sub>2</sub> [A]
<b>400V / 50 Hz / 6 poles / 1000 r/min</b>					
7.5	5	0.79	15.4	0.98	12.4
11	5	0.78	23	0.93	19.3
15	7.5	0.78	31	0.94	25.7
18.5	7.5	0.81	36	0.94	30.9
22	10	0.81	43	0.96	36.5
30	10	0.83	56	0.94	49.4
37	12.5	0.83	69	0.94	60.8
45	15	0.84	82	0.95	72.6
55	20	0.84	101	0.96	88.7
75	25	0.82	141	0.93	123.9
90	30	0.84	163	0.95	144.2
110	35	0.83	202	0.94	178.8
132	45	0.83	240	0.95	210.8
160	50	0.85	280	0.95	249.6
200	60	0.85	355	0.95	318.0
250	70	0.84	450	0.94	404.2
315	75	0.84	565	0.92	514.4
<b>400V / 50 Hz / 8 poles / 750 r/min</b>					
7.5	5	0.7	18.1	0.91	13.9
11	7.5	0.76	23.5	0.97	18.4
15	7.5	0.82	29	0.97	24.5
18.5	7.5	0.79	37	0.93	31.5
22	10	0.77	45	0.92	37.5
30	12.5	0.79	59	0.93	50.0
37	15	0.78	74	0.92	62.8
45	20	0.78	90	0.93	75.4
55	20	0.81	104	0.93	90.2
75	30	0.82	140	0.95	120.6
90	30	0.82	167	0.93	146.6
110	35	0.83	202	0.94	178.8
132	50	0.8	250	0.93	214.6

## 3 Power factor correction

### Example

For a three-phase asynchronous motor, 110 kW (400 V - 50 Hz - 4 poles), the PFC power suggested in the table is 30 kvar.

### Individual power factor correction of three-phase transformers

A transformer is an electrical device of primary importance which, due to the system requirements, is often constantly in service.

In particular, in installations constituted by several transformer substations, it is advisable to carry out power factor correction directly at the transformer.

In general, the PFC power ( $Q_c$ ) for a transformer with rated power  $S_r$  [kVA] should not exceed the reactive power required under minimum reference load conditions.

Reading the data from the transformer nameplate, the percentage value of the no-load current  $i_0\%$ , the percentage value of the short-circuit voltage  $u_k\%$ , the iron losses  $P_{fe}$  and the copper losses  $P_{cu}$  [kW], the PFC power required is approximately:

$$Q_c = \sqrt{\left(\frac{i_0\%}{100} \cdot S_r\right)^2 - P_{fe}^2} + K_L^2 \cdot \sqrt{\left(\frac{u_k\%}{100} \cdot S_r\right)^2 - P_{cu}^2} = \left(\frac{i_0\%}{100} \cdot S_r\right) + K_L^2 \cdot \left(\frac{u_k\%}{100} \cdot S_r\right) \quad [\text{kvar}] \quad (7)$$

where  $K_L$  is the load factor, defined as the relationship between the minimum reference load and the rated power of the transformer.

### Example

Supposing the need for PFC of a 630 kVA oil-distribution transformer which supplies a load which is less than 60% of its rated power.

From the data on the transformer nameplate:

$$i_0\% = 1.8\%$$

$$u_k\% = 4\%$$

$$P_{cu} = 8.9 \text{ kW}$$

$$P_{fe} = 1.2 \text{ kW}$$

The PFC power of the capacitor bank connected to the transformer is:

$$Q_c = \sqrt{\left(\frac{1.8\%}{100} \cdot 630\right)^2 - 1.2^2} + 0.6^2 \cdot \sqrt{\left(\frac{4\%}{100} \cdot 630\right)^2 - 8.9^2} = 19.8 \text{ kvar}$$

while, when using the simplified formula, the result is:

$$Q_c = \left(\frac{1.8\%}{100} \cdot 630\right) + 0.6^2 \cdot \left(\frac{4\%}{100} \cdot 630\right) = 20.4 \text{ kvar}$$

### 3 Power factor correction

Table 4 shows the reactive power of the capacitor bank  $Q_c$  [kvar] to be connected on the secondary side of an ABB transformer, according to the different minimum estimated load levels.

**Table 4: PFC reactive power for ABB transformers**

$S_r$ [kVA]	$u_k$ % [%]	$i_o$ % [%]	$P_{fe}$ [kW]	$Q_c$ [kvar]		load factor $K_L$				
				$P_{cu}$ [kW]		0	0.25	0.5	0.75	1
<b>Oil Distribution Transformer MV-LV</b>										
50	4	2.9	0.25	1.35	1.4	1.5	1.8	2.3	2.9	
100	4	2.5	0.35	2.30	2.5	2.7	3.3	4.3	5.7	
160	4	2.3	0.48	3.20	3.6	4	5	6.8	9.2	
200	4	2.2	0.55	3.80	4.4	4.8	6.1	8.3	11	
250	4	2.1	0.61	4.50	5.2	5.8	7.4	10	14	
315	4	2	0.72	5.40	6.3	7	9.1	13	18	
400	4	1.9	0.85	6.50	7.6	8.5	11	16	22	
500	4	1.9	1.00	7.40	9.4	11	14	20	28	
630	4	1.8	1.20	8.90	11	13	17	25	35	
800	6	1.7	1.45	10.60	14	16	25	40	60	
1000	6	1.6	1.75	13.00	16	20	31	49	74	
1250	6	1.6	2.10	16.00	20	24	38	61	93	
1600	6	1.5	2.80	18.00	24	30	47	77	118	
2000	6	1.2	3.20	21.50	24	31	53	90	142	
2500	6	1.1	3.70	24.00	27	37	64	111	175	
3150	7	1.1	4.00	33.00	34	48	89	157	252	
4000	7	1.4	4.80	38.00	56	73	125	212	333	
<b>Cast Resin Distribution Transformer MV-LV</b>										
100	6	2.3	0.50	1.70	2.2	2.6	3.7	5.5	8	
160	6	2	0.65	2.40	3.1	3.7	5.5	8.4	12	
200	6	1.9	0.85	2.90	3.7	4.4	6.6	10	15	
250	6	1.8	0.95	3.30	4.4	5.3	8.1	13	19	
315	6	1.7	1.05	4.20	5.3	6.4	9.9	16	24	
400	6	1.5	1.20	4.80	5.9	7.3	12	19	29	
500	6	1.4	1.45	5.80	6.8	8.7	14	23	36	
630	6	1.3	1.60	7.00	8	10	17	29	45	
800	6	1.1	1.94	8.20	8.6	12	20	35	56	
1000	6	1	2.25	9.80	9.7	13	25	43	69	
1250	6	0.9	3.30	13.00	11	15	29	52	85	
1600	6	0.9	4.00	14.50	14	20	38	67	109	
2000	6	0.8	4.60	15.50	15	23	45	82	134	
2500	6	0.7	5.20	17.50	17	26	54	101	166	
3150	8	0.6	6.00	19.00	18	34	81	159	269	

#### Example

For a 630 kVA oil-distribution transformer with a load factor of 0.5, the necessary PFC power is 17 kvar.

## 3 Power factor correction

### PFC in groups

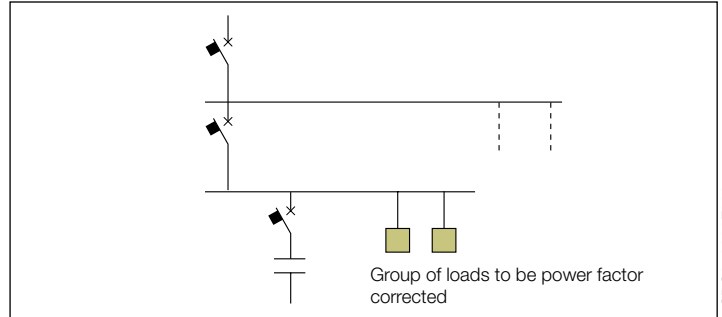

1SDC010029P0001

This consists of local power factor correction of groups of loads with similar functioning characteristics by installing a dedicated capacitor bank. This method achieves a compromise between the economical solution and the correct operation of the installation, since only the line downstream of the installation point of the capacitor bank is not correctly exploited.

### Centralized PFC

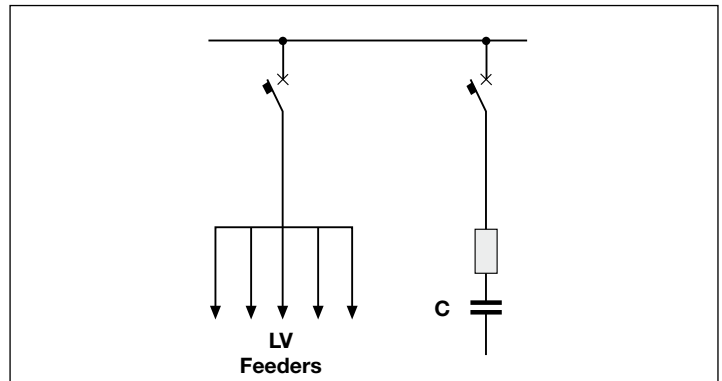

1SDC010030F0001

The daily load profile is of fundamental importance for the choice of the most suitable type of power factor correction.

In installations, in which not all loads function simultaneously and/or in which some loads are connected for only a few hours a day, the solution of using single PFC becomes unsuitable as many of the capacitors installed could stay idle for long periods.

In the case of installations with many loads occasionally functioning, thus having a high installed power and a quite low average power absorption by the loads which function simultaneously, the use of a single PFC system at the installation origin ensures a remarkable decrease in the total power of the capacitors to be installed.

### 3 Power factor correction

Centralized PFC normally uses automatic units with capacitor banks divided into several steps, directly installed in the main distribution switchboards; the use of a permanently connected capacitor bank is only possible if the absorption of reactive energy is fairly regular throughout the day. The main disadvantage of centralized PFC is that the distribution lines of the installation, downstream of the PFC device, must be dimensioned taking into account the full reactive power required by the loads.

#### 3.3 Circuit-breakers for the protection and switching of capacitor banks

The circuit-breakers for the protection and switching of capacitor banks in LV shall:

1. withstand the transient currents which occur when connecting and disconnecting the banks. In particular, the instantaneous magnetic and electronic releases shall not trip due to these peak currents;
2. withstand the periodic or permanent overcurrents due to the voltage harmonics and to the tolerance (+15%) of the rated value of capacity;
3. perform a high number of no-load and on-load operations, also with high frequency;
4. be coordinated with any external device (contactors).

Furthermore, the making and breaking capacity of the circuit-breaker must be adequate to the short-circuit current values of the installation.

Standards IEC 60831-1 and 60931-1 state that:

- the capacitors shall normally function with an effective current value up to 130% of their rated current  $I_{rc}$  (due to the possible presence of voltage harmonics in the network);
- a tolerance of 10% on the capacitance for banks up to 100 kvar and of 5% for banks exceeding 100 kvar is admitted.

The maximum current which can be absorbed by the capacitor bank  $I_{cmax}$  is:

$$Q_c \leq 100 \text{ kvar} \longrightarrow I_{cmax} = 1.3 \cdot 1.1 \cdot \frac{Q_c}{\sqrt{3} \cdot U_n} = 1.43 \cdot I_{cn} \quad (8)$$

$$Q_c > 100 \text{ kvar} \longrightarrow I_{cmax} = 1.3 \cdot 1.05 \cdot \frac{Q_c}{\sqrt{3} \cdot U_n} = 1.365 \cdot I_{cn}$$

Therefore:

- the rated current of the circuit-breaker shall be greater than  $1.5 \cdot I_{rc}$ ;
- the overload protection setting shall be equal to  $1.5 \cdot I_{rc}$ .

The connection of a capacitor bank, similar to a closing operation under short-circuit conditions, associated with transient currents with high frequency (1÷15 kHz), of short duration (1÷3 ms), with high peak ( $25 \div 200 I_{rc}$ ).

Therefore:

- the circuit-breaker shall have an adequate making capacity;
- the setting of the instantaneous short-circuit protection must not cause unwanted trips.

### 3 Power factor correction

The second condition is generally respected:

- for thermomagnetic releases, the magnetic protection shall be set at a value not less than  $10 \cdot I_{cmax}$

$$Q_c \leq 100 \text{ kvar} \rightarrow I_g \geq 10 \cdot I_{cmax} = 14.3 \cdot I_{rc} = 14.3 \cdot \frac{Q_c}{\sqrt{3} \cdot U_n} \quad (9)$$

$$Q_c > 100 \text{ kvar} \rightarrow I_g \geq 10 \cdot I_{cmax} = 13.65 \cdot I_{rc} = 13.65 \cdot \frac{Q_c}{\sqrt{3} \cdot U_n}$$

- for electronic releases, the instantaneous short-circuit protection shall be deactivated ( $I_g = \text{OFF}$ ).

Hereunder, the selection tables for circuit-breakers: for the definition of the version according to the required breaking capacity, refer to Part 1, Chapter 2.1 “General characteristics”.

The following symbols are used in the tables (they refer to maximum values):

- $Q_c$  = power of the capacitor bank which can be connected [kvar] with reference to the indicated voltage and 50 Hz frequency;
- $I_{cn}$  = rated current of the connected capacitor bank [A];
- $I_{cmax}$  = maximum rated current of the connected capacitor bank [A];

It is necessary to install limiting inductances in order to reduce the inrush current.

**Table 5: Coordination type 2 circuit breaker-contactor for the switching of capacitor banks at 400 V, 50 kA**

Qc [kvar]	Icn [A]	Icmax [A]	MCCBs	Contactor
10	14	21	XT2S 160 TMD In=25	A30
15	22	31	XT2S 160 TMD In=40	A/AF50
20	29	41	XT2S 160 TMD In=50	A/AF50
30	43	62	XT2S 160 TMD In=80	A/AF63
40	58	83	XT2S 160 TMD In=100	A/AF63
50	72	103	XT2S 160 TMD In=125	A/AF95
60	87	124	XT2S 160 TMD In=160	A/AF95
70	101	144	XT2S 160 TMD In=160*	A/AF110
80	115	165	XT3S TMD TMD In=200	A/AF145
90	130	186	XT3S TMD TMD In=200	A/AF145
110	159	217	XT3S TMD TMD In=250	A/AF185
130	188	256	T4S320 PR221LI In=320	A/AF210
150	217	296	T4S320 PR221LI In=320	A/AF260
180	260	355	T5S400 PR221LI In=400	AF400
200	289	394	T5S400 PR221LI In=400	AF400
250	361	493	T6S630 PR221LI In=630	AF580
280	404	552	T6S630 PR221LI In=630	AF580
300	433	591	T6S630 PR221LI In=630	AF750

\* For plug-in version reduce the power of the capacitor bank by 10%

### 3 Power factor correction

**Table 6: Coordination type 2 circuit breaker-contactor for the switching of capacitor banks at 440 V, 50 kA**

Qc [kvar]	Icn [A]	Icmax [A]	MCCBs	Contactor
10	13	19	XT2S 160 TMD In=25	A/AF50
15	20	28	XT2S 160 TMD In=32	A/AF50
20	26	38	XT2S 160 TMD In=40	A/AF50
30	39	56	XT2S 160 TMD In=63	A/AF63
40	52	75	XT2S 160 TMD In=100	A/AF95
50	66	94	XT2S 160 TMD In=125	A/AF95
60	79	113	XT2S 160 TMD In=125	A/AF95
70	92	131	XT2S 160 TMD In=160	A/AF110
80	105	150	XT2S 160 TMD In=160*	A/AF145
90	118	169	XT4S Ekip LS/I In=250	A/AF145
110	144	197	XT4S Ekip LS/I In=250	A/AF185
130	171	233	XT4S Ekip LS/I In=250	A/AF210
150	197	269	T4H320 PR221LI In=320	A/AF260
180	236	322	T5H400 PR221LI In=400	A/AF300
200	262	358	T5H400 PR221LI In=400	AF400
250	328	448	T6H630 PR221LI In=630	AF460
280	367	502	T6H630 PR221LI In=630	AF580
300	394	537	T6H630 PR221LI In=630	AF580
350	459	627	T6H800 PR221LI In=800	AF750
400	525	716	T6H800 PR221LI In=800	AF750

\* For plug-in version reduce the power of the capacitor bank by 10%

**Table 7: Coordination type 2 circuit breaker-contactor for the switching of capacitor banks at 500 V, 50 kA**

Qc [kvar]	Icn [A]	Icmax [A]	MCCBs	Contactor
10	12	17	XT2H 160 TMD In=20	A/AF50
15	17	25	XT2H 160 TMD In=32	A/AF50
20	23	33	XT2H 160 TMD In=40	A/AF50
30	35	50	XT2H 160 TMD In=63	A/AF63
40	46	66	XT2H 160 TMD In=80	A/AF75
50	58	83	XT2H 160 TMD In=100	A/AF95
60	69	99	XT2H 160 TMD In=125	A/AF95
70	81	116	XT2H 160 TMD In=125	A/AF95
80	92	132	XT2H 160 TMD In=160	A/AF110
90	104	149	XT2H 160 TMD In=160*	A/AF145
110	127	173	XT4H Ekip LS/I In=250	A/AF145
130	150	205	XT4H Ekip LS/I In=250	A/AF185
150	173	236	XT4H Ekip LS/I In=250	A/AF210
180	208	284	T4H320 PR221LI In=320	A/AF260
200	231	315	T5H400 PR221LI In=400	A/AF300
250	289	394	T5H400 PR221LI In=400	AF400
280	323	441	T6H630 PR221LI In=630	AF460
300	346	473	T6H630 PR221LI In=630	AF460
350	404	552	T6H630 PR221LI In=630	AF580
400	462	630	T6H800 PR221LI In=800	AF750

\* For plug-in version reduce the power of the capacitor bank by 10%

### 3 Power factor correction

**Table 8: Coordination type 2 circuit breaker-contactor for the switching of capacitor banks at 690 V, 10 kA**

<b>Qc</b> [kvar]	<b>I<sub>cn</sub></b> [A]	<b>I<sub>cmax</sub></b> [A]	<b>MCCBs</b>	<b>Contactor</b>
10	8	12	XT2N 160 TMD I <sub>n</sub> =16	A/AF50
15	13	18	XT2N 160 TMD I <sub>n</sub> =20	A/AF50
20	17	24	XT2N 160 TMD I <sub>n</sub> =25	A/AF50
30	25	36	XT2N 160 TMD I <sub>n</sub> =40	A/AF50
40	33	48	XT2N 160 TMD I <sub>n</sub> =50	A/AF63
50	42	60	XT2N 160 TMD I <sub>n</sub> =63	A/AF63
60	50	72	XT2N 160 TMD I <sub>n</sub> =80	A/AF75
70	59	84	XT2N 160 TMD I <sub>n</sub> =100	A/AF95
80	67	96	XT2N 160 TMD I <sub>n</sub> =100	A/AF95
90	75	108	XT2N 160 TMD I <sub>n</sub> =125	A/AF110
110	92	126	XT2N 160 TMD I <sub>n</sub> =160	A/AF145
130	109	148	XT2N 160 TMD I <sub>n</sub> =160*	A/AF185
150	126	171	XT4N Ekip LS/I I <sub>n</sub> =250	A/AF210
180	151	206	XT4N Ekip LS/I I <sub>n</sub> =250	A/AF260
200	167	228	XT4N Ekip LS/I I <sub>n</sub> =250	A/AF260
250	209	286	T4N320 PR221LI I <sub>n</sub> =320	AF400
280	234	320	T5N400 PR221LI I <sub>n</sub> =400	AF400
300	251	343	T5N400 PR221LI I <sub>n</sub> =400	AF400
350	293	400	T6N630 PR221LI I <sub>n</sub> =630	AF460
400	335	457	T6N630 PR221LI I <sub>n</sub> =630	AF580

\* For plug-in version reduce the power of the capacitor bank by 10%



## 3 Power factor correction

In the following table regarding the switching and protection of capacitors by means of air circuit-breakers, the following symbols are used:

- $N_{\text{mech}}$  = number of mechanical operations;
- $f_{\text{mech}}$  = frequency of mechanical operations [op/h];
- $N_{\text{el}}$  = number of electrical operations with reference to a voltage of 440 V;
- $f_{\text{el}}$  = frequency of electrical operations [op/h].

**Table 9: Selection table for SACE Emax air circuit-breakers**

Circuit-breaker	$I_{\text{CBn}}$ [A]	$I_{\text{cn}}$ [A]	$Q_c$ [kvar]				$N_{\text{mech}}$	$f_{\text{mech}}$ [op/h]	$N_{\text{el}}$	$f_{\text{el}}$ [op/h]
			400 V	440 V	500 V	690 V				
X1 B-N	630	421	291	320	364	502	12500	60	6000	30
X1 B-N	800	533	369	406	461	637	12500	60	6000	30
X1 B-N	1000	666	461	507	576	795	12500	60	4000	30
X1 B-N	1250	834	578	636	722	997	12500	60	4000	30
X1 B-N	1600	1067	739	813	924	1275	12500	60	3000	30
E1 B-N	800	533	369	406	461	637	25000	60	10000	30
E1 B-N	1000	666	461	507	576	795	25000	60	10000	30
E1 B-N	1250	834	578	636	722	997	25000	60	10000	30
E1 B-N	1600	1067	739	813	924	1275	25000	60	10000	30
E2 B-N-S	800	533	369	406	461	637	25000	60	15000	30
E2 B-N-S	1000	666	461	507	576	795	25000	60	15000	30
E2 B-N-S	1250	834	578	636	722	997	25000	60	15000	30
E2 B-N-S	1600	1067	739	813	924	1275	25000	60	12000	30
E2 B-N-S	2000	1334	924	1017	1155	1594	25000	60	10000	30
E3 N-S-H-V	800	533	369	406	461	637	20000	60	12000	20
E3 N-S-H-V	1000	666	461	507	576	795	20000	60	12000	20
E3 N-S-H-V	1250	834	578	636	722	997	20000	60	12000	20
E3 N-S-H-V	1600	1067	739	813	924	1275	20000	60	10000	20
E3 N-S-H-V	2000	1334	924	1017	1155	1594	20000	60	9000	20
E3 N-S-H-V	2500	1667	1155	1270	1444	1992	20000	60	8000	20
E3 N-S-H-V	3200	2134	1478	1626	1848	2550	20000	60	6000	20
E4 S-H-V	3200	2134	1478	1626	1848	2550	15000	60	7000	10
E6 H-V	3200	2134	1478	1626	1848	2550	12000	60	5000	10

---

## 4 Protection of human beings

---

### 4.1 General aspects: effects of current on human beings

Danger to persons due to contact with live parts is caused by the flow of the current through the human body. The effects are:

- **tetanzation:** the muscles affected by the current flow involuntary contract and letting go of gripped conductive parts is difficult. Note: very high currents do not usually induce muscular tetanzation because, when the body touches such currents, the muscular contraction is so sustained that the involuntary muscle movements generally throw the subject away from the conductive part;
- **breathing arrest:** if the current flows through the muscles controlling the lungs, the involuntary contraction of these muscles alters the normal respiratory process and the subject may die due to suffocation or suffer the consequences of traumas caused by asphyxia;
- **ventricular fibrillation:** the most dangerous effect is due to the superposition of the external currents with the physiological ones which, by generating uncontrolled contractions, induce alterations of the cardiac cycle. This anomaly may become an irreversible phenomenon since it persists even when the stimulus has ceased;
- **burns:** they are due to the heating deriving, by Joule effect, from the current passing through the human body.

The Standard IEC 60479-1 "*Effects of current on human being and livestock*" is a guide about the effects of current passing through the human body to be used for the definition of electrical safety requirements. This Standard shows, on a time-current diagram, four zones to which the physiological effects of alternating current (15 ÷ 100 Hz) passing through the human body have been related.

## 4 Protection of human beings

**Figure 1: Time-current zones of the effects of alternating current on the human body**

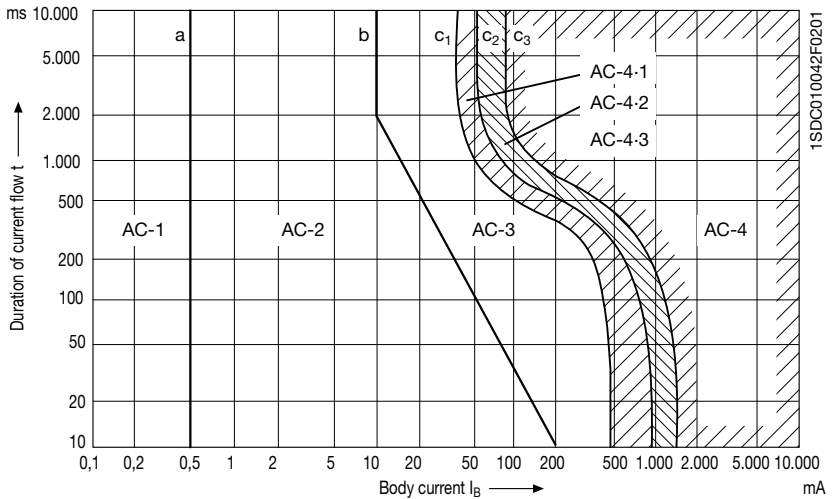

Zone designation	Zone limits	Physiological effects
AC-1	Up to 0.5 mA line a	Usually no reaction.
AC-2	0.5 mA up to line b*	Usually no harmful physiological effects.
AC-3	Line b up to curve c <sub>1</sub>	Usually no organic damage to be expected. Likelihood of cramplike muscular contractions and difficulty in breathing for durations of current-flow longer than 2 s. Reversible disturbances of formation and conduction of impulses in the heart, including atrial fibrillation and transient cardiac arrest without ventricular fibrillation increasing with current magnitude and time.
AC-4	Above curve c <sub>1</sub>	Increasing with magnitude and time, dangerous pathophysiological effects such as cardiac arrest, breathing arrest and severe burns may occur in addition to the effects of zone 3.
AC-4.1	c <sub>1</sub> - c <sub>2</sub>	Probability of ventricular fibrillation increasing up to about 5%.
AC-4.2	c <sub>2</sub> - c <sub>3</sub>	Probability of ventricular fibrillation up to about 50%.
AC-4.3	Beyond curve c <sub>3</sub>	Probability of ventricular fibrillation above 50%.

\* For durations of current-flow below 10 ms, the limit for the body current for line b remains constant at a value of 200 mA.

This Standard gives also a related figure for direct current.

By applying Ohm's law it is possible to define the safety curve for the allowable voltages, once the human body impedance has been calculated. The electrical impedance of the human body depends on many factors. The above mentioned Standard gives different values of impedance as a function of the touch voltage and of the current path.

# 4 Protection of human beings

## 4.2 Distribution systems

The earth fault modalities and the consequences caused by contact with live parts, are strictly related to the neutral conductor arrangement and to the connections of the exposed conductive parts.

For a correct choice of the protective device, it is necessary to know which is the distribution system of the plant.

IEC 60364-1 classifies the distribution systems with two letters.

The first letter represents the relationship of the power system to earth:

- T: direct connection of one point to earth, in alternating current systems, generally the neutral point;
- I: all live parts isolated from earth, or one point, in alternating current systems, generally the neutral point, connected to earth through an impedance.

The second letter represents the relationship of the exposed conductive parts of the installation to earth:

- T: direct electrical connection of the exposed conductive parts to earth;
- N: direct electrical connection of the exposed conductive parts to the earthed point of the power system.

Subsequent letters, if any, represent the arrangement of neutral and protective conductors:

- S: protective function is provided by a conductor separate from the neutral conductor;
- C: neutral and protective functions combined as a single conductor (PEN conductor).

Three types of distribution system are considered:

### TT System

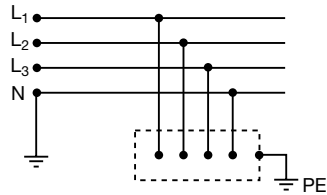

### TN System

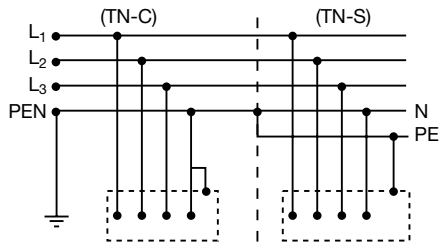

1SDC010032F0001

1SDC010032F0001

## 4 Protection of human beings

### IT System

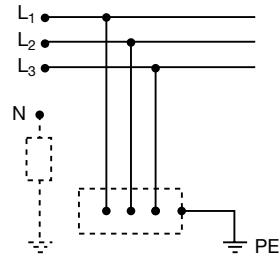

In **TT** systems, the neutral conductor and the exposed conductive parts are connected to earth electrodes electrically independent; the fault current flows towards the power supply neutral point through earth (Figure 1):

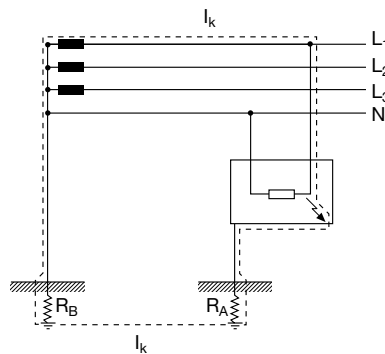

In **TT** installations, the neutral conductor is connected to the supply star center, it is usually distributed and has the function of making the phase voltage (e.g. 230 V) available, useful for single-phase load supply. The exposed conductive parts, on the contrary, singularly or collectively, are locally connected to earth. **TT** systems are generally used for civil installations.

**TN** systems are typically used when the power supply is distributed to loads having their own electrical substation. The neutral conductor is directly earthed in the substation; the exposed conductive parts are connected to the same earthing point of the neutral conductor, and can be locally earthed.

Three types of TN system are considered according to the arrangement of neutral and protective conductors:

1. TN-C neutral and protective functions are combined in a single conductor (PEN conductor);
2. TN-S neutral and protective conductors are always separated;
3. TN-C-S neutral and protective functions are combined in a single conductor in a part of the system (PEN) and are separated in another part (PE + N).

## 4 Protection of human beings

In **TN** systems, the fault current flows towards the power supply neutral point through a solid metallic connection, practically without involving the earth electrode (Figure 2).

**Figure 2: Earth fault in TN systems**

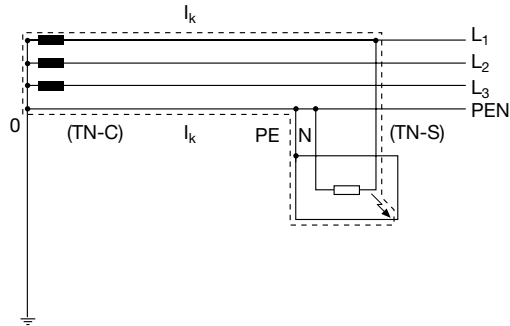

1SDC010036F0001

**IT** systems have no live parts directly connected to earth, but they can be earthed through a sufficiently high impedance. Exposed conductive parts shall be earthed individually, in groups or collectively to an independent earthing electrode.

The earth fault current flows towards the power supply neutral point through the earthing electrode and the line conductor capacitance (Figure 3).

**Figure 3: Earth fault in IT systems**

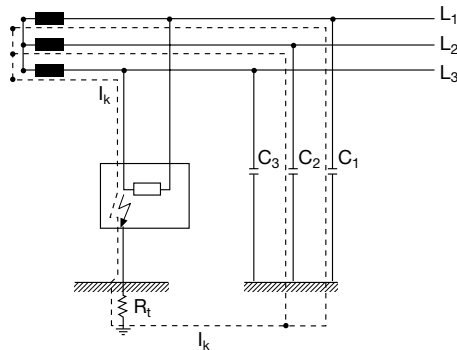

1SDC010037F0001

These distribution systems are used for particular plants, where the continuity of supply is a fundamental requirement, where the absence of the supply can cause hazards to people or considerable economical losses, or where a low value of a first earth fault is required. In these cases, an insulation monitoring device shall be provided for optical or acoustic signalling of possible earth faults, or failure of the supplied equipment.

---

## 4 Protection of human beings

---

### 4.3 Protection against both direct and indirect contact

Contacts of a person with live parts can be divided in two categories:

- direct contacts;
- indirect contacts.

A direct contact occurs when a part of the human body touches a part of the plant, usually live (bare conductors, terminals, etc.).

A contact is indirect when a part of the human body touches an exposed conductive parts, usually not live, but with voltage presence due to a failure or wear of the insulating materials.

The measures of protection against **direct contact** are:

- insulation of live parts with an insulating material which can only be removed by destruction (e.g. cable insulation);
- barriers or enclosures: live parts shall be inside enclosures or behind barriers providing at least the degree of protection IPXXB or IP2X; for horizontal surfaces the degree of protection shall be of at least IPXXD or IP4X (for the meaning of the degree of protection codes please refer to Part 1, Chapter 5.1 "Electrical switchboards");
- obstacles: the interposition of an obstacle between the live parts and the operator prevents unintentional contacts only, but not an intentional contact by the removal of the obstacle without particular tools;
- placing out of reach: simultaneously accessible parts at different potentials shall not be within arm's reach.

An additional protection against direct contact can be obtained by using residual current devices with a rated operating residual current not exceeding 30 mA. It must be remembered that the use of a residual current device as a mean of protection against direct contacts does not obviate the need to apply one of the above specified measures of protection.

The measures of protection against **indirect contact** are:

- automatic disconnection of the supply: a protective device shall automatically disconnect the supply to the circuit so that the touch voltage on the exposed conductive part does not persist for a time sufficient to cause a risk of harmful physiological effect for human beings;
- supplementary insulation or reinforced insulation, e.g. by the use of Class II components;

## 4 Protection of human beings

- non-conducting locations: locations with a particular resistance value of insulating floors and walls ( $\geq 50 \text{ k}\Omega$  for  $U_r \leq 500 \text{ V}$ ;  $\geq 100 \text{ k}\Omega$  for  $U_r > 500 \text{ V}$ ) and without protective conductors inside;
- electrical separation, e.g. by using an isolating transformer to supply the circuit;
- earth-free local equipotential bonding: locations where the exposed conductive parts are connected together but not earthed.

Finally, the following measures provide combined protection against both direct and indirect contact:

- SELV (Safety Extra Low Voltage) system and PELV (Protective Extra Low Voltage) system;
- FELV (Functional Extra Low Voltage) system.

The protection against both direct and indirect contact is ensured if the requirements stated in 411 from IEC 60364-4-41 are fulfilled; particularly:

- the rated voltage shall not exceeds 50 V ac r.m.s. and 120 V ripple-free dc;
- the supply shall be a SELV or PELV source;
- all the installation conditions provided for such types of electrical circuits shall be fulfilled.

A SELV circuit has the following characteristics:

- 1) it is supplied by an independent source or by a safety source. Independent sources are batteries or diesel-driven generators. Safety sources are supplies obtained through an isolating transformer;
- 2) there are no earthed points. The earthing of both the exposed conductive parts as well as of the live parts of a SELV circuit is forbidden;
- 3) it shall be separated from other electrical systems. The separation of a SELV system from other circuits shall be guaranteed for all the components; for this purpose, the conductors of the SELV circuit may be contained in multi-conductor cables or may be provided with an additional insulating sheath.

A PELV circuit has the same prescription of a SELV system, except for the prohibition of earthed points; in fact in PELV circuits, at least one point is always earthed.



## 4 Protection of human beings

FELV circuits are used when for functional reasons the requirements for SELV or PELV circuits cannot be fulfilled; they require compliance with the following rules:

- a) protection against direct contact shall be provided by either:
  - barriers or enclosures with degree of protection in accordance with what stated above (measures of protection against direct contact);
  - insulation corresponding to the minimum test voltage specified for the primary circuit. If this test is not passed, the insulation of accessible non-conductive parts of the equipment shall be reinforced during erection so that it can withstand a test voltage of 1500 V ac r.m.s. for 1 min.;
- b) protection against indirect contact shall be provided by:
  - connection of the exposed conductive parts of the equipment of the FELV circuit to the protective conductor of the primary circuit, provided that the latter is subject to one of the measures of protection against direct contact;
  - connection of a live conductor of the FELV circuit to the protective conductor of the primary circuit provided that an automatic disconnection of the supply is applied as measure of protection;
- c) plugs of FELV systems shall not be able to enter socket-outlets of other voltage systems, and plugs of other voltage systems shall not be able to enter socket-outlets of FELV systems.

Figure 1 shows the main features of SELV, PELV and FELV systems.

**Figure 1: SELV, PELV, FELV systems**

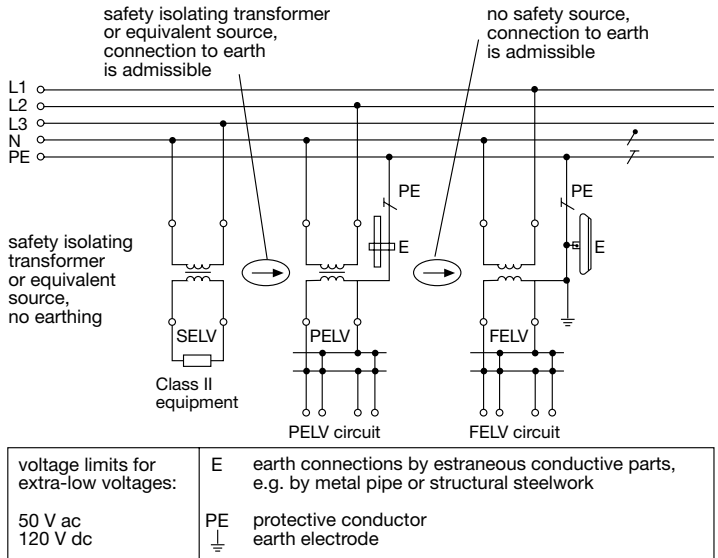

Note 1: Overcurrent protective devices are not shown in this figure.

## 4 Protection of human beings

### 4.4 TT System

An earth fault in a TT system involves the circuit represented in Figure 1:

**Figure 1: Earth fault in TT system**

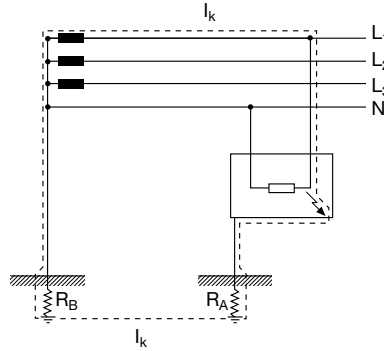

The fault current flows through the secondary winding of the transformer, the line conductor, the fault resistance, the protective conductor, and the earth electrode resistances ( $R_A$ , of the user's plant, and  $R_B$ , of the neutral).

According to IEC 60364-4 prescriptions, the protective devices must be coordinated with the earthing arrangement in order to rapidly disconnect the supply if the touch voltage reaches harmful values for the human body.

Before describing such prescriptions, it is useful to know the different circuit types described in the above mentioned Standard; in particular, in a plant, the circuits can be divided into:

- final circuit: it is a circuit which usually supplies equipment (for example an aspirator, a bridge crane, etc.)
- distribution circuit: it is a circuit which supplies a distribution board to which other final circuits are connected.

In a TT system, to achieve a correct protection against indirect contact through the automatic disconnection of the circuit, it is necessary to respect one of the following conditions (in compliance with IEC 60364-4):

#### *Protection by means of residual current devices*

By assuming 50V as limit voltage (standard environments), to achieve protection against indirect contact by means of residual current devices it is necessary to satisfy the following condition:

$$R_A \cdot I_{An} \leq 50V \quad \text{then: } R_A \leq \frac{50V}{I_{An}}$$

where:

$R_A$  is the total resistance (in ohm) of the earth electrode and of the protective conductor of the exposed-conductive-parts<sup>1</sup>;

$I_{An}$  is the rated residual operating current of the residual current circuit-breaker.

<sup>1</sup> The resistance of the earth electrode is in series with that of the protective conductor, which is negligible if compared with the resistance  $R_A$ ; as a consequence, in the formula it is possible to take into consideration only the resistance of the earth electrode of the user's plant.

## 4 Protection of human beings

As regards the disconnection times, the Standard distinguishes two possibilities;

- final circuits with rated currents not exceeding 32A: in this case it is necessary that the above mentioned condition with the times shown in Table 1 (values referred to fault currents significantly higher than the rated residual current of the residual current circuit-breakers typically  $5 \cdot I_{\Delta n}$ ) is fulfilled;
- distribution circuit or final circuit with rated currents exceeding 32A: in this case it is necessary that the above mentioned condition is fulfilled with a time not exceeding 1 s (conventional time).

**Table 1: Maximum disconnection times for final circuits not exceeding 32A**

System	50V < U <sub>0</sub> ≤ 120V s		130V < U <sub>0</sub> ≤ 230V s		230V < U <sub>0</sub> ≤ 400V s		U <sub>0</sub> > 400V s	
	a.c.	d.c.	a.c.	d.c.	a.c.	d.c.	a.c.	d.c.
TT	0.3	Note 1	0.2	0.4	0.07	0.2	0.04	0.1

U<sub>0</sub> is the nominal a.c. or d.c. line to earth voltage.

Where in TT systems the disconnection is achieved by an overcurrent protective device and the protective equipotential bonding is connected with all extraneous-conductive-parts within the installation, the maximum disconnection times applicable to TN systems may be used.

NOTE 1 Disconnection may be required for reasons other than protection against electric shock.

NOTE 2 Where compliance with the above mentioned requirement is provided by an RCD, the disconnecting times in accordance with the table above relate to prospective residual currents significantly higher than the rated residual operating current of the RCD (typically  $5 \cdot I_{\Delta n}$ ).

From the above, it is evident that the value of the resistance R<sub>A</sub> of the earthing arrangement results to be different by using residual current circuit-breakers with different sensitivity, since the current quantity at the denominator in the above mentioned relationship is different. In fact, by using a residual current device with 30mA sensitivity, an earthing resistance value lower than

$$R_A \leq \frac{50}{0.03} = 1666.6\Omega$$

shall be obtained, whereas with a less sensitive residual current device (for example with 300mA sensitivity) an earthing resistance value lower than:

$$R_A \leq \frac{50}{0.3} = 166.6\Omega$$

shall be obtained.

## 4 Protection of human beings

As shown in the example, thanks to a more sensitive residual current device, from a practical point of view it will be easier to realize an earthing system coordinated with the characteristics of the device itself.

The Table 2 shows the maximum values of earth resistance which can be obtained with residual current devices and making reference to a common environment (50V):

**Table 2: Earth resistance values**

$I_{An}$ [A]	$R_A$ [Ω]
0.01	5000
0.03	1666
0.1	500
0.3	166
0.5	100
3	16
10	5
30	1.6

## 4 Protection of human beings

### *Protection by means of overcurrent protective devices*

The choice of the automatic device for the protection against phase-to-earth faults and indirect contact shall be carried out by coordinating properly the disconnection times with the impedance of the fault loop.

As a consequence, it is necessary to fulfill the following condition:

$$Z_s \cdot I_a \leq U_0$$

where:

$Z_s$  is the impedance (in ohms) of the fault loop comprising

- the source;
- the line conductor up to the point of the fault;
- the protective conductor of the exposed-conductive-parts;
- the earthing conductor;
- the earth electrode of the installation;
- the earth electrode of the source;

$I_a$  is the disconnection current in the times shown in Table 1 for final circuits with currents not exceeding 32A or within 1 second for distribution circuits and for final circuits with currents exceeding 32A;

$U_0$  is the nominal a.c. r.m.s. voltage to earth (V).

The choice of the automatic device shall be made by coordinating properly the disconnection times with the impedance of the fault loop.

The relationship  $Z_s \cdot I_a \leq U_0$  may be expressed as :

$$I_a \leq \frac{U_0}{Z_s} = I_{kL\text{-to earth}}$$

where  $I_{kL\text{-to earth}}$  is the phase-to-earth fault current. Therefore, it is possible to state that the protection against indirect contact is verified when the tripping current  $I_a$  of the protective device (within the times shown in Table 1 or within 1s) is lower than the phase-to-earth fault current  $I_{kL\text{-to earth}}$  at the exposed-conductive-part to be protected.

It is to underline that in TT distribution systems the use of a residual current device allows to have an earthing arrangement with an earth resistance value which can be easily obtained, whereas the use of automatic circuit-breakers is possible only in case of low earth resistance values  $R_A$  (very difficult to be obtained in practice); besides, in such circumstances, it could be very difficult to calculate the impedance of the fault loop ( $Z_s$ ), because the earthing resistance of the neutral cannot be considered negligible (in fact it could reach values of the same quantity of the earth resistance).

# 4 Protection of human beings

## 4.5 TN System

An earth fault in a TN system involves the circuit represented in Figure 2:

**Figure 2=: Earth fault in TN system**

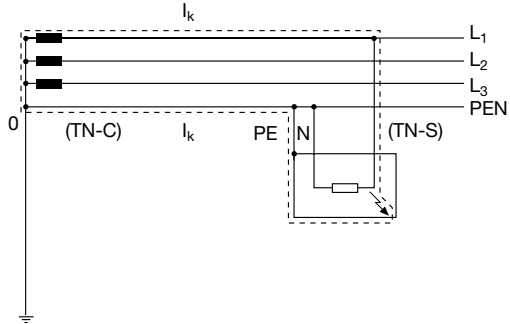

1SDC010036F0001

The fault loop does not affect the earthing system and is basically formed by the connection in series of the phase conductor and of the protective conductor. To provide a protection with automatic disconnection of the circuit, according to IEC 60364-4 prescriptions, the following condition shall be fulfilled:

$$Z_s \cdot I_a \leq U_0$$

where:

$Z_s$  is the impedance of the fault loop comprising the source, the live conductor up to the point of the fault and the protective conductor between the point of the fault and the source [ $\Omega$ ];

$U_0$  is the nominal ac r.m.s. voltage to earth [V];

$I_a$  is the disconnection current in amperes of the protective device within the times defined in Table 3 as a function of the rated voltage  $U_0$  for final circuits with currents not exceeding 32A or within 5 seconds for distribution circuits and for final circuits with current exceeding 32A (for a description of the circuit typologies reference shall be made to the indications given for TT systems).

**Table 3: Maximum disconnecting times for TN system**

System	50V < $U_0$ ≤ 120V <sub>s</sub>		120V < $U_0$ ≤ 230V <sub>s</sub>		230V < $U_0$ ≤ 400V <sub>s</sub>		$U_0$ > 400V <sub>s</sub>	
	a.c.	d.c.	a.c.	d.c.	a.c.	d.c.	a.c.	d.c.
TN	0.8	Note 1	0.4	5	0.2	0.4	0.1	0.1

NOTE 1 Disconnection may be required for reasons other than protection against electric shock.

NOTE 2 Where compliance with the above mentioned requirement is provided by an RCD, the disconnecting times in accordance with the table above relate to prospective residual currents significantly higher than the rated residual operating current of the RCD (typically 5· $I_{RD}$ ).

## 4 Protection of human beings

The choice of the automatic device for the protection against phase-PE faults and against indirect contact shall be carried out by coordinating properly the disconnection times with the impedance of the fault loop.

In TN systems a bolted fault phase-PE on the LV side usually generates a current similar to that of a short-circuit and the earth fault current flowing through the line conductor (or conductors) and the protective conductor does not absolutely affect the earthing arrangement.

The relationship  $Z_s \cdot I_a \leq U_0$  may be expressed as:

$$I_a \leq \frac{U_0}{Z_s} = I_{kLPE}$$

where  $I_{kLPE}$  is the phase-PE fault current. Therefore, it is possible to state that the protection against indirect contact is verified when the tripping current  $I_a$  of the protective device (within the times shown in Table 3 or within 5s) is lower than the phase-PE fault current  $I_{kLPE}$  at the exposed-conductive-part to be protected.

In TN systems the following devices are used for protection against indirect contact:

- circuit-breakers with thermomagnetic releases;
- circuit-breakers with electronic releases;
- residual current devices (TN-S only).

Finally, it is important to highlight the fact that the residual current devices cannot be used in TN-C system, since the neutral and protective functions are provided by a unique conductor: this configuration prevents the residual current device from working.

## 4 Protection of human beings

### 4.6 IT System

As represented in Figure 3, the earth fault current in an IT system flows through the line conductor capacitance to the power supply neutral point. For this reason, the first earth fault is characterized by such an extremely low current value to prevent the overcurrent protections from disconnecting; the deriving touch voltage is very low.

**Figure3: Earth fault in IT system**

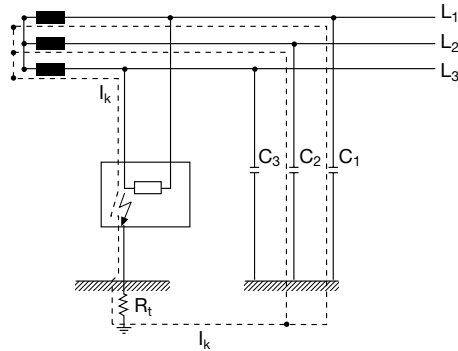

According to IEC 60364-4, the automatic disconnection of the circuit in case of the first earth fault is not necessary only if the following condition is fulfilled:

$$R_A \cdot I_d \leq 50 \text{ Va.c.}$$

$$R_A \cdot I_d \leq 120 \text{ Vd.c.}$$

where:

$R_A$  is the sum of the resistance, in ohms, of the earth electrode and protective conductor for exposed-conductive- parts;

$I_d$  is the fault current, in amperes, of the first fault<sup>2</sup> of negligible impedance between a line conductor and an exposed-conductive-part; such value takes account of the leakage currents and of the total earthing impedance of the electrical installation.

If this condition is fulfilled, after the fault, the touch voltage on the exposed-conductive-part will be than 50 V (in alternating current), which is tolerable by the human body for an indefinite time.

In IT system installations, an insulation monitoring device shall be provided to indicate the presence of an anomalous condition after the occurrence of a fault. An insulation monitoring device complying with Std. IEC 61557-8 is a device constantly monitoring the insulation of an electrical installation.

It is aimed at signaling any remarkable reduction of the insulation level of an installation in order to find the cause of this reduction before a second fault occurs, thus preventing disconnection of the power supply.

<sup>2</sup> This is referred to by the Standard as first fault to earth; the occurrence of two simultaneous faults on two different phases is called double fault to earth.



## 4 Protection of human beings

indicate the occurrence of a first earth fault; in the event of a second fault, the supply shall be disconnected according to the following modalities:

- a) where exposed conductive parts are earthed in groups or individually, the conditions for protection are the same as for TT systems:  
where the exposed-conductive-parts are earthed in groups or individually, the following condition shall be fulfilled:

$$R_A \cdot I_a \leq 50V$$

where:

$R_A$  is the sum of the resistance of the earth electrode and of the protective conductor for the exposed-conductive-parts;

$I_a$  is the current causing automatic disconnection of the protective device in a time complying with that for TT systems;

- b) where exposed conductive parts are interconnected by a protective conductor collectively earthed, the conditions of a TN system apply; in particular, the following conditions shall be fulfilled:

if the neutral is not distributed:

$$Z_s \leq \frac{U}{2 \cdot I_a}$$

if the neutral is distributed:

$$Z's \leq \frac{U_0}{2 \cdot I_a}$$

where:

$U_0$  is the nominal voltage between line conductor and neutral conductor;

$U$  is the nominal voltage between line conductors;

$Z_s$  is the impedance of the fault loop comprising the line conductor and the protective conductor of the circuit;

$Z's$  is the impedance of the fault loop comprising the neutral conductor and the protective conductor of the circuit;

$I_a$  is the current causing operation of the protective device within the time required for TN systems.

The Standard suggests not to distribute the neutral conductor in IT systems. One of the reasons is the real difficulty in fulfilling the condition prescribed for the impedance of the double fault loop  $Z's$ . As a matter of fact, in the presence of a neutral conductor distributed, the impedance must be 58% smaller than the impedance  $Z_s$ , which is verified in the event of a double fault between the phases; in this way, it becomes evident that there is a greater difficulty in the co-ordination with the automatic disconnection device which must trip to provide protection against indirect contact.

Moreover, above all for quite complex industrial installations, the presence of the neutral distributed may involve the risk of an accidental connection of it at any point to earth, thus eliminating the advantages offered by IT systems.

The residual current device threshold shall be carefully chosen in order to avoid unwanted tripping, due also to the particular path followed by the first fault current through the line conductor capacitance to the power supply neutral point (instead of the faulted line, another sound line with higher capacitance could be affected by a higher fault current value).

## 4 Protection of human beings

### 4.7 Residual current devices (RCDs)

#### Generalities on residual current circuit-breakers

The operating principle of the residual current release is basically the detection of an earth fault current, by means of a toroid transformer which embraces all the live conductors, included the neutral if distributed.

**Figure 1: Operating principle of the residual current device**

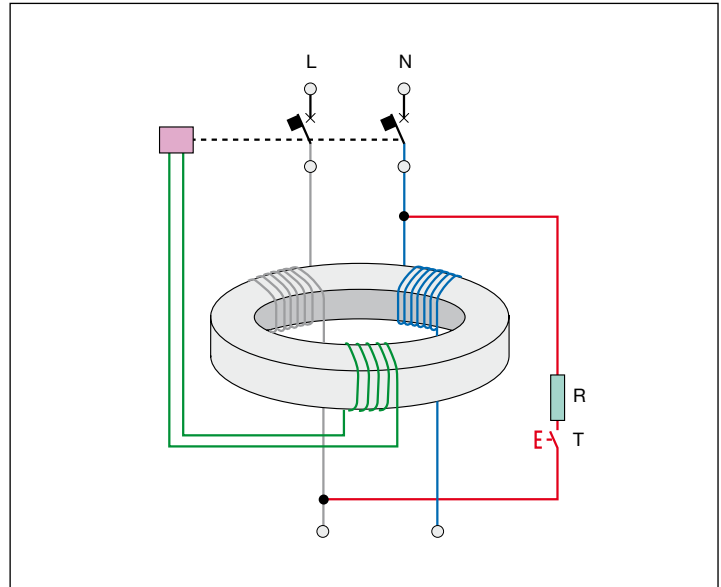

In absence of an earth fault, the vectorial sum of the currents  $I_{\Delta}$  is equal to zero; in case of an earth fault if the  $I_{\Delta}$  value exceeds the rated residual operating current  $I_{\Delta n}$ , the circuit at the secondary side of the toroid sends a command signal to a dedicated opening coil causing the tripping of the circuit-breaker.

A first classification of RCDs can be made according to the type of the fault current they can detect:

- AC type: the tripping is ensured for residual sinusoidal alternating currents, whether suddenly applied or slowly rising;
- A type: tripping is ensured for residual sinusoidal alternating currents and residual pulsating direct currents, whether suddenly applied or slowly rising;
- B type: tripping is ensured for residual direct currents, for residual sinusoidal alternating currents and residual pulsating direct currents, whether suddenly applied or slowly rising.

Another classification referred to the operating time delay is:

- undelayed type;
- time delayed S-type.

## 4 Protection of human beings

RCDs can be coupled, or not, with other devices; it is possible to distinguish among:

- pure residual current circuit-breakers (RCCBs): they have only the residual current release and can protect only against earth fault. They must be coupled with thermomagnetic circuit-breakers or fuses, for the protection against thermal and dynamical stresses;
- residual current circuit-breakers with overcurrent protection (RCBOs): they are the combination of a thermomagnetic circuit-breaker and a RCD; for this reason, they provide the protection against both overcurrents as well as earth fault current;
- residual current circuit-breakers with external toroid: they are used in industrial plants with high currents. They are composed by a release connected to an external toroid with a winding for the detection of the residual current; in case of earth fault, a signal commands the opening mechanism of a circuit-breaker or a line contactor.

Given  $I_{\Delta n}$  the operating residual current, a very important parameter for residual current devices is the residual non-operating current, which represents the maximum value of the residual current which does not cause the circuit-breaker trip; it is equal to  $0.5 I_{\Delta n}$ . Therefore, it is possible to conclude that:

- for  $I_{\Delta} < 0.5 \cdot I_{\Delta n}$  the RCD shall not operate;
- for  $0.5 \cdot I_{\Delta n} < I_{\Delta} < I_{\Delta n}$  the RCD could operate;
- for  $I_{\Delta} > I_{\Delta n}$  the RCD shall operate.

For the choice of the rated operating residual current, it is necessary to consider, in addition to the coordination with the earthing system, also the whole of the leakage currents in the plant; their vectorial sums on each phase shall not be greater than  $0.5 \cdot I_{\Delta n}$  in order to avoid unwanted tripping.

### Discrimination between RCDs

The Standard IEC 60364-5-53 states that discrimination between residual current protective devices installed in series may be required for service reasons, particularly when safety is involved, to provide continuity of supply to the parts of the installation not involved by the fault, if any. This discrimination can be achieved by selecting and installing RCDs in order to provide the disconnection from the supply by the RCD closest to the fault.

There are two types of discrimination between RCDs:

- horizontal discrimination: it provides the protection of each line by using a dedicated residual current circuit-breaker; in this way, in case of earth fault, only the faulted line is disconnected, since the other RCDs do not detect any fault current. However, it is necessary to provide protective measures against indirect contacts in the part of the switchboard and of the plant upstream the RCD;
- vertical discrimination: it is realized by using RCDs connected in series.

**Figure 2: Horizontal discrimination between RCDs**

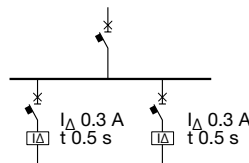

## 4 Protection of human beings

**Figure 3: Vertical discrimination between RCDs**

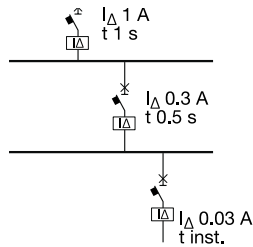

According to IEC 60364-5-53, to ensure discrimination between two residual current protective devices in series, these devices shall satisfy both the following conditions:

- the non-actuating time-current characteristic of the residual current protective device located on the supply side (upstream) shall lie above the total operating time-current characteristic of the residual current protective device located on the load side (downstream);
- the rated residual operating current on the device located on the supply side shall be higher than that of the residual current protective device located on the load side.

**The non-actuating time-current characteristic** is the curve reporting the maximum time value during which a residual current greater than the residual non-operating current (equal to  $0.5 \cdot I_{\Delta n}$ ) involves the residual current circuit-breaker without causing the tripping.

As a conclusion, discrimination between two RCDs connected in series can be achieved:

- for S type residual current circuit-breakers, located on the supply side, (complying with IEC 61008-1 and IEC 61009), time-delayed type, by choosing general type circuit-breakers located downstream with  $I_{\Delta n}$  equal to one third of  $I_{\Delta n}$  of the upstream ones;
- for electronic residual current releases by choosing the upstream device with time and current thresholds directly greater than the downstream device, keeping carefully into consideration the tolerances.

For the protection against indirect contacts in distribution circuits in TT system, the maximum disconnecting time at  $I_{\Delta n}$  shall not exceed 1 s (IEC 60364-4-41, par. 411.3.2.4)

## 4 Protection of human beings

### 4.8 Maximum protected length for the protection of human beings

As described in the previous chapters, the Standards give indications about the maximum disconnecting time for the protective devices, in order to avoid pathophysiological effects for people touching live parts.

For the protection against indirect contact, it shall be verified that the circuit-breaker trips within a time lower than the maximum time stated by the Standard; this verification is carried out by comparing the minimum short-circuit current of the exposed conductive part to be protected with the operating current corresponding to the time stated by the Standard.

The minimum short-circuit current occurs when there is a short-circuit between the phase and the protective conductors at the farthest point on the protected conductor.

For the calculation of the minimum short-circuit current, an approximate method can be used, assuming that:

- a 50 % increasing of the conductors resistance, with respect to the 20 °C value, is accepted, due to the overheating caused by the short-circuit current;
- a 80 % reduction of the supply voltage is considered as effect of the short-circuit current;
- the conductor reactance is considered only for cross sections larger than 95 mm<sup>2</sup>.

The formula below is obtained by applying Ohm's law between the protective device and the fault point.

*Legend of the symbols and constants of the formula:*

- 0.8 is the coefficient representing the reduction of the voltage;
- 1.5 is the coefficient representing the increasing in the resistance;
- $U_r$  is the rated voltage between phases;
- $U_g$  is the rated voltage between phase and ground;
- $S$  is the phase conductor cross section;
- $S_N$  is the neutral conductor cross section;
- $S_{PE}$  is the protection conductor cross section;
- $\rho$  is the conductor resistivity at 20 °C;
- $L$  is the length of the cable;

$$m = \frac{S \cdot n}{S_{PE}}$$

(single phase conductor cross section  $S$  multiplied by  $n$ , number of conductors in parallel) and the protective conductor cross section  $S_{PE}$  assuming they are made of the same conductor material;

$$m_1 = \frac{S_N \cdot n}{S_{PE}}$$

section (single neutral conductor cross section  $S_N$  multiplied by  $n$ , number of conductors in parallel) and the protective conductor cross section  $S_{PE}$  assuming they are made of the same conductor material;

- $k_1$  is the correction factor which takes into account the reactance of cables with cross section larger than 95 mm<sup>2</sup>, obtainable from the following table:

Phase conductor cross section [mm <sup>2</sup> ]	120	150	185	240	300
$k_1$	0.90	0.85	0.80	0.75	0.72

## 4 Protection of human beings

- $k_2$  is the correction factor for conductors in parallel, obtainable by the following formula:

$$k_2 = 4 \frac{n-1}{n}$$

- where  $n$  is the number of conductor in parallel per phase;
- 1.2 is the magnetic threshold tolerance allowed by the Standard.

### TN system

The formula for the evaluation of the minimum short circuit current is:

$$I_{k\min} = \frac{0.8 \cdot U_0 \cdot S}{1.5 \cdot 1.2 \cdot \rho \cdot (1+m) \cdot L} \cdot k_1 \cdot k_2$$

and consequently:

$$L = \frac{0.8 \cdot U_0 \cdot S}{1.5 \cdot 1.2 \cdot \rho \cdot (1+m) \cdot I_{k\min}} \cdot k_1 \cdot k_2$$

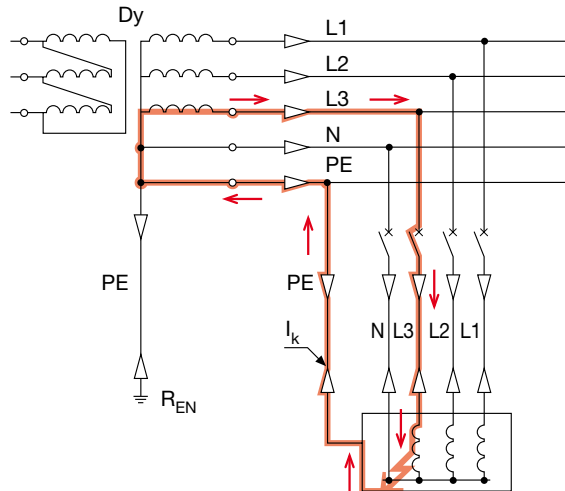

1SDC010043F0001

### IT system

The formulas below are valid when a second fault turns the IT system into a TN system.

It is necessary to separately examine installations with neutral not distributed and neutral distributed.

## 4 Protection of human beings

### Neutral not distributed

When a second fault occurs, the formula becomes:

$$I_{k\min} = \frac{0.8 \cdot U_r \cdot S}{2 \cdot 1.5 \cdot 1.2 \cdot \rho \cdot (1+m) \cdot L} \cdot k_1 \cdot k_2$$

and consequently:

$$L = \frac{0.8 \cdot U_r \cdot S}{2 \cdot 1.5 \cdot 1.2 \cdot \rho \cdot (1+m) \cdot I_{k\min}} \cdot k_1 \cdot k_2$$

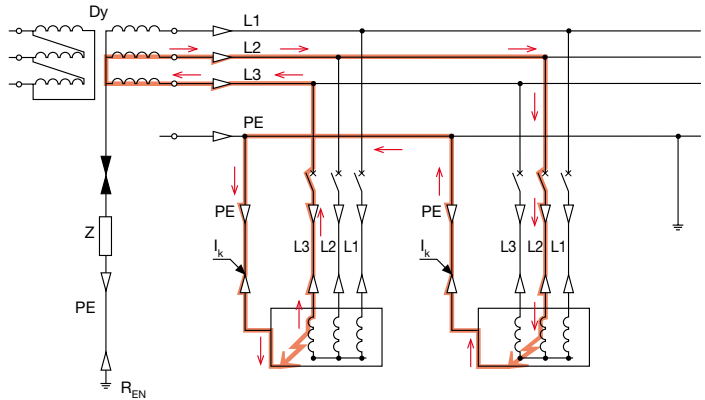

### Neutral distributed

Case A: three-phase circuits in IT system with neutral distributed

The formula is:

$$I_{k\min} = \frac{0.8 \cdot U_0 \cdot S}{2 \cdot 1.5 \cdot 1.2 \cdot \rho \cdot (1+m) \cdot L} \cdot k_1 \cdot k_2$$

and consequently:

$$L = \frac{0.8 \cdot U_0 \cdot S}{2 \cdot 1.5 \cdot 1.2 \cdot \rho \cdot (1+m) \cdot I_{k\min}} \cdot k_1 \cdot k_2$$

Case B: three-phase + neutral circuits in IT system with neutral distributed

The formula is:

$$I_{k\min} = \frac{0.8 \cdot U_0 \cdot S_N}{2 \cdot 1.5 \cdot 1.2 \cdot \rho \cdot (1+m_1) \cdot L} \cdot k_1 \cdot k_2$$

and consequently:

$$L = \frac{0.8 \cdot U_0 \cdot S_N}{2 \cdot 1.5 \cdot 1.2 \cdot \rho \cdot (1+m_1) \cdot I_{k\min}} \cdot k_1 \cdot k_2$$

## 4 Protection of human beings

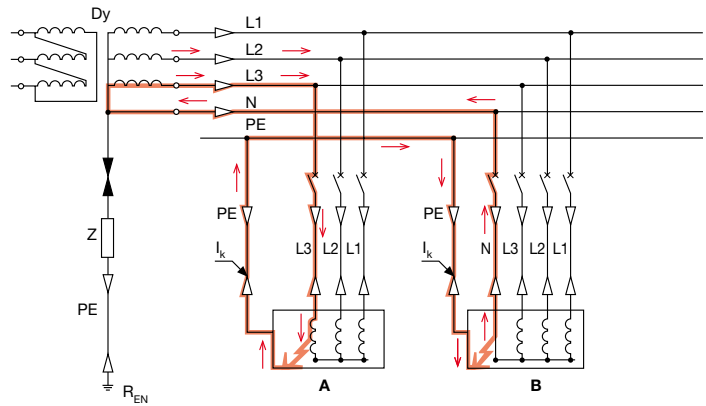

1SDC010045F0001

### Note for the use of the tables

The tables showing the maximum protected length (MPL) have been defined considering the following conditions:

- one cable per phase;
- rated voltage equal to 400 V (three-phase system);
- copper cables;
- neutral not distributed, for IT system only;
- protective conductor cross section according to Table 1:

**Table 1: Protective conductor cross section**

Phase conductor cross section S [mm <sup>2</sup> ]	Protective conductor cross section S <sub>PE</sub> [mm <sup>2</sup> ]
$S \leq 16$	S
$16 < S \leq 35$	16
$S > 35$	S/2

Note: phase and protective conductors having the same isolation and conductive materials

Whenever the S function (delayed short-circuit) of electronic releases is used for the definition of the maximum protected length, it is necessary to verify that the tripping time is lower than the time value reported in Chapter 4.5 Table 1 for TN systems and in Chapter 4.6 Table 1 for IT systems.

For conditions different from the reference ones, the following correction factors shall be applied.



## 4 Protection of human beings

### Correction factors

**Correction factor for cable in parallel per phase:** the value of the maximum protected length read in Table 2 (TN system) or Table 3 (IT system) shall be multiplied by the following factor:

n	2	3	4	5	6	7	8
$k_p$	2	2.7	3	3.2	3.3	3.4	3.5

n is the number of conductors in parallel per phase

**Correction factor for three-phase voltage different from 400 V:** the value of the maximum protected length read in Table 2 (TN system) or Table 3 (IT system) shall be multiplied by the following factor:

voltage [V]	230	400	440	500	690
$k_v$	0.58	1	1.1	1.25	1.73

For 230 V single-phase systems, no correction factor is necessary.

**Correction factor for aluminium cables:** the value of the maximum protected length read in Table 2 (TN system) or Table 3 (IT system) shall be multiplied by the following factor:

$k_{Al}$	0.64
----------	------

**Correction factor for protective conductor cross section  $S_{PE}$  different from the cross sections stated in Table 1:** the value of the maximum protected length shall be multiplied by the coefficient corresponding to the phase conductor cross section and to the ratio between the protective conductor (PE) and the phase cross sections:

$S_{PE}/S$	0.5	0.55	0.6	0.66	0.75	0.87	1	1.25	1.5	2
S	$k_{PE}$									
$\leq 16 \text{ mm}^2$	0.67	0.71	0.75	0.80	0.86	0.93	1.00	1.11	1.20	1.33
25 mm <sup>2</sup>	0.85	0.91	0.96	1.02	1.10	1.19	1.28	1.42	1.54	1.71
35 mm <sup>2</sup>	1.06	1.13	1.20	1.27	1.37	1.48	1.59	1.77	1.91	2.13
>35 mm <sup>2</sup>	1.00	1.06	1.13	1.2	1.29	1.39	1.5	1.67	1.8	2.00

**Correction factor for neutral distributed in IT systems (for Table 3 only):** the value of the maximum protected length shall be multiplied by 0.58.

---

## 5 Photovoltaic plants

---

### 5.1 Operating principle

A photovoltaic (PV) plant transforms directly and instantaneously solar energy into electrical energy without using any fuels. As a matter of fact, the photovoltaic (PV) technology exploits the photoelectric effect, through which some semiconductors suitably “doped” generate electricity when exposed to solar radiation.

The main advantages of photovoltaic (PV) plants can be summarized as follows:

- distributed generation where needed;
- no emission of polluting materials;
- saving of fossil fuels;
- reliability of the plants since they do not have moving parts (useful life usually over 20 years);
- reduced operating and maintenance costs;
- system modularity (to increase the plant power it is sufficient to raise the number of panels) according to the real requirements of users.

However, the initial cost for the development of a PV plant is quite high due to a market which has not reached its full maturity from a technical and economical point of view. Moreover the generation of power is erratic due to the variability of the solar energy source.

The annual electrical power output of a PV plant depends on different factors. Among them:

- solar radiation incident on the installation site;
- inclination and orientation of the panels;
- presence or not of shading;
- technical performances of the plant components (mainly modules and inverters).

The main applications of PV plants are:

1. installations (with storage systems) for users isolated from the grid;
2. installations for users connected to the LV grid;
3. solar PV power plants, usually connected to the MV grid.

Feed-in Tariff incentives are granted only for the applications of type 2 and 3, in plants with rated power not lower than 1 kW.

A PV plant is essentially constituted by a generator (PV panels), by a supporting frame to mount the panels on the ground, on a building or on any building structure, by a system for power control and conditioning, by a possible energy storage system, by electrical switchboards and switchgear assemblies housing the switching and protection equipment and by the connection cables.

---

# 5 Photovoltaic plants

---

## 5.2 Main components of a photovoltaic plants

---

### 5.2.1 Photovoltaic generator

The elementary component of a PV generator is the photovoltaic cell where the conversion of the solar radiation into electric current is carried out.

The cell is constituted by a thin layer of semiconductor material, generally silicon properly treated, with a thickness of about 0.3 mm and a surface from 100 to 225 cm<sup>2</sup>.

Silicon, which has four valence electrons (tetravalent), is “doped” by adding trivalent atoms (e.g. boron – P doping) on one “layer” and quantities of pentavalent atoms (e.g. phosphorus – N doping) on the other one. The p-type region has an excess of holes, whereas the n-type region has an excess of electrons.

In the contact area between the two layers differently doped (P-N junction), the electrons tend to move from the electron rich half (N) to the electron poor half (P), thus generating an accumulation of negative charge in the P region. A dual phenomenon occurs for the electron holes, with an accumulation of positive charge in the region N. Therefore an electric field is created across the junction and it opposes the further diffusion of electric charges.

By applying a voltage from the outside, the junction allows the current to flow in one direction only (diode functioning).

When the cell is exposed to light, due to the photovoltaic effect <sup>1</sup>, some electron-hole couples arise both in the N region as well as in the P region.

The internal electric field allows the excess electrons (derived from the absorption of the photons from part of the material) to be separated from the holes and pushes them in opposite directions in relation one to another. As a consequence, once the electrons have passed the depletion region they cannot move back since the field prevents them from flowing in the reverse direction.

By connecting the junction with an external conductor, a closed circuit is obtained, in which the current flows from the layer N, having higher potential, to the layer P, having lower potential, as long as the cell is illuminated.

The silicon region which contributes to supply the current is the area surrounding the P-N junction; the electric charges form in the far off areas, but there is not the electric field which makes them move and therefore they recombine.

As a consequence it is important that the PV cell has a great surface: the greater the surface, the higher the generated current.

<sup>1</sup> The photovoltaic effect occurs when an electron in the valence band of a material (generally a semiconductor) is promoted to the conduction band due to the absorption of one sufficiently energetic photon (quantum of electromagnetic radiation) incident on the material. In fact, in the semiconductor materials, as for insulating materials, the valence electrons cannot move freely, but comparing semiconductor with insulating materials the energy gap between the valence band and the conduction band (typical of conducting materials) is small, so that the electrons can easily move to the conduction band when they receive energy from the outside. Such energy can be supplied by the luminous radiation, hence the photovoltaic effect.

## 5 Photovoltaic plants

Figure 1 represents the photovoltaic effect and the energy balance showing the considerable percentage of incident solar energy which is not converted into electric energy.

### Photovoltaic effect

- 1 Separation of the charge
- 2 Recombination
- 3 Transmission
- 4 Reflection and shading of the front contacts

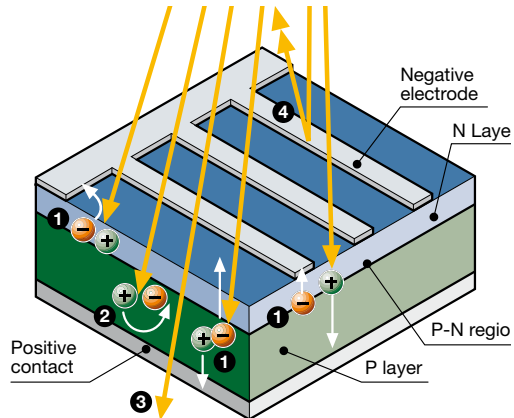

### 100% of the incident solar energy

- 3% reflection losses and shading of the front contacts
- 23% photons with high wavelength, with insufficient energy to free electrons; heat is generated
- 32% photons with short wavelength, with excess energy (transmission)
- 8.5% recombination of the free charge carriers
- 20% electric gradient in the cell, above all in the transition regions
- 0.5% resistance in series, representing the conduction losses
- = 13% usable electric energy

Under standard operating conditions (1W/m<sup>2</sup> irradiance at a temperature of 25°C) a PV cell generates a current of about 3A with a voltage of 0.5V and a peak power equal to 1.5-1.7Wp.

On the market there are photovoltaic modules for sale constituted by an assembly of cells.

The most common ones comprise 36 cells in 4 parallel row connected in series, with an area ranging from 0.5 to 1m<sup>2</sup>.

Several modules mechanically and electrically connected form a panel, that is a common structure which can be anchored to the ground or to a building.

Several panels electrically connected in series constitute an array and several arrays, electrically connected in parallel to generate the required power, constitute the generator or photovoltaic field.

## 5 Photovoltaic plants

### 5.2.2 Inverter

The power conditioning and control system is constituted by an inverter that converts direct current to alternating current and controls the quality of the output power to be delivered to the grid, also by means of an L-C filter inside the inverter itself.

The transistors, used as static switches, are controlled by an opening-closing signal which, in the simplest mode, would result in an output square waveform.

#### Principle scheme of a single-phase inverter

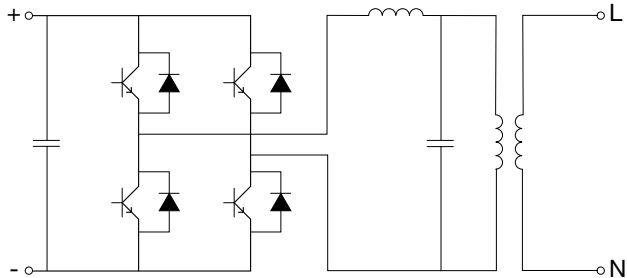

To obtain a waveform as sinusoidal as possible, a more sophisticated technique – Pulse Width Modulation (PWM) – is used; PWM technique allows a regulation to be achieved on the frequency as well as on the r.m.s. value of the output waveform.

The power delivered by a PV generator depends on the point where it operates. In order to maximize the energy supply by the plant, the generator shall adapt to the load, so that the operating point always corresponds to the maximum power point. To this purpose, inside the inverter a controlled chopper called Maximum Power Point Tracker (MPPT) is used; the MPPT calculates instant by instant the pair of values “voltage-current” of the generator at which the maximum available power is produced.

The MPPT systems commercially used identify the maximum power point on the characteristic curve of the generator by causing, at regular intervals, small variations of loads which determine deviations of the voltage-current values and evaluating if the new product  $I \times V$  is higher or lower than the previous one. In case of a rise, the load conditions are kept varying in the considered direction. In the other case, the conditions are modified in the opposite direction.

Due to the characteristics of the required performances the inverters for stand-alone plants and for grid-connected plants shall have different characteristics:

- in the stand-alone plants the inverters shall be able to supply a voltage AC side. as constant as possible at the varying of the production of the generator and of the load demand;
- in the grid-connected plants the inverters shall reproduce, as exactly as possible, the network voltage and at the same time try to optimize and maximize the energy output of the PV panels.

---

## 5 Photovoltaic plants

---

### 5.3 Typologies of photovoltaic plants

---

#### 5.3.1 Stand-alone plants

Stand-alone plants are plants which are not connected to the grid and consist of PV panels and of a storage system which guarantees electric energy supply also when lighting is poor or when it is dark. Since the current delivered by the PV generator is DC power, if the user plant needs AC current an inverter becomes necessary. Such plants are advantageous from a technical and financial point of view whenever the electric network is not present or whenever it is not easy to reach, by replacing motor generator sets.

Besides, in a stand-alone configuration, the PV field is over-dimensioned so that, during the insolation hours, both the load supply as well as the recharge of the storing batteries can be guaranteed with a certain safety margin to take into account the days of poor insolation.

At present the most common applications are used to supply:

- pumping water equipment;
- radio repeaters, weather or seismic observation and data transmission stations;
- lightning systems;
- systems of signs for roads, harbors and airports;
- service supply in campers;
- advertising installations;
- refuges at high altitudes.

---

#### 5.3.2 Grid-connected plants

Permanently grid-connected plants draw power from the grid during the hours when the PV generator cannot produce the energy necessary to satisfy the needs of the consumer.

On the contrary, if the PV system produces excess electric power, the surplus is put into the grid, which therefore can operate as a big accumulator: as a consequence, grid-connected systems don't need accumulator banks.

These plants offer the advantage of distributed - instead of centralized - generation: in fact the energy produced near the consumption area has a value higher than that produced in traditional large power plants, because the transmission losses are limited and the expenses of the big transport and dispatch electric systems are reduced. In addition, the energy production in the insolation hours allows the requirements to the grid to be reduced during the day, that is when the demand is higher.

## 5 Photovoltaic plants

### 5.4 Earthing and protection against indirect contact

The concept of earthing applied to a photovoltaic (PV) system may involve both the exposed conductive parts (e.g. metal frame of the panels) as well as the generation power system (live parts of the PV system e.g. the cells).

A PV system can be earthed only if it is galvanically separated (e.g. by means of a transformer) from the electrical network by means of a transformer. A PV insulated system could seem apparently safer for the people touching a live part; as a matter of fact, the insulation resistance to earth of the live parts is not infinite and then person is passed through by a current returning through such resistance. This current rises when the voltage to earth of the plant and the plant size increase since the insulation resistance to earth decreases. Besides, the physiological decay of the insulators, due to the passage of time and the presence of humidity, reduces the insulation resistance itself. Consequently, in very big plants, the current passing through a person in touch with the live part may cause electrocution and therefore the advantage over the earthed systems is present only in case of small plants.

#### 5.4.1 Plants with transformer

In the plants with transformer, in addition to the analysis of the PV system either insulated or earthed, for the protection against indirect contacts it is necessary to make a difference between the exposed conductive parts upstream and downstream the transformer<sup>2</sup>.

##### 5.4.1.1 Exposed conductive parts on the load side of the transformer

###### Plant with IT system

In this type of plant the live parts result insulated from earth, whereas the exposed conductive parts are earthed<sup>3</sup> (Figure 2).

Figure 2

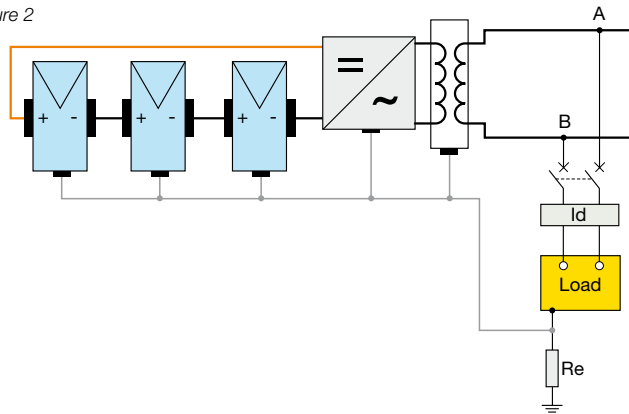

<sup>2</sup> In this case upstream and downstream are referred to the direction of the electric power produced by the PV plant.

<sup>3</sup> For safety reasons the earthing system of the PV plant results to be in common with the consumer's one.

## 5 Photovoltaic plants

In this case the earthing resistance  $R_e$  of the exposed conductive parts shall meet the condition (CEI 64-8):

$$R_e \leq \frac{120}{I_d} \quad (1)$$

where  $I_d$  is the current of first fault to earth, which is not known in advance, but which is generally very low in small-sized plants.

As a consequence, the earthing resistance  $R_e$  of the consumer plant, which is defined for a fault in the network, usually satisfies only the relation (1).

In case of a double earth fault, since the PV generator is a current generator, the voltage of the interconnected exposed conductive parts shall be lower than:

$$I_{sc} \cdot R_{eqp} \leq 120V \quad (2)$$

where  $I_{sc}$  is the short-circuit current of the cells involved, whereas  $R_{eqp}$  is the resistance of the conductor interconnecting the exposed conductive parts affected by fault. For instance, if  $R_{eqp} = 1\Omega$  (value approximated by excess), the relation (2) is fulfilled for  $I_{sc}$  not exceeding 120A, which is usual in small-sized plants; therefore the effective touch voltage in case of a second earth fault does not result hazardous.

On the contrary, in large-sized plants it is necessary to reduce to acceptable limits the chance that a second earth fault occurs, by eliminating the first earth fault detected by the insulation controller (either inside the inverter or external).

### Plant with TN system

In this type of plant the live parts and the exposed conductive parts are connected to the same earthing system (earthing system of the consumer's plant). Thus a TN system on the DC side is obtained (Figure 3).

Figure 3

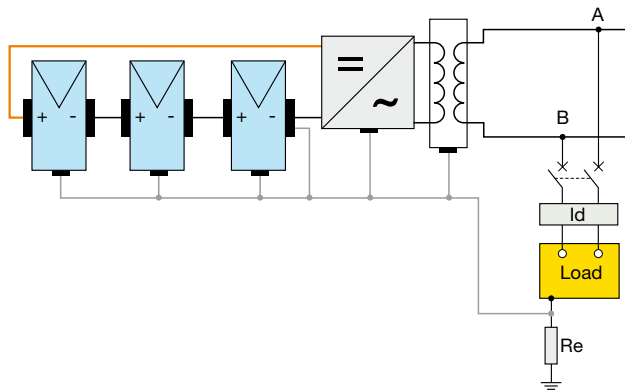



## 5 Photovoltaic plants

In the presence of an earth fault, a short-circuit occurs as in the usual TN systems, but such current cannot be detected by the maximum current devices since the characteristic of the PV plants is the generation of fault currents with values not much higher than the rated current.

Therefore, as regards the dangerousness of this fault, the considerations made in the previous paragraph<sup>4</sup> on the second fault for an IT system are valid.

<sup>4</sup> The Std. IEC 60364-7 recommends that the whole installation on the DC side (switchboards, cables, and terminal boards) is erected by use of class II devices or equivalent insulation.

### 5.4.1.2 Exposed conductive parts on the supply side of the transformer

Take into consideration the network-consumer system of TT type.

The exposed conductive parts belonging to the consumer's plant protected by a residual current circuit-breakers positioned at the beginning of the consumer's plant (Figure 4), result protected both towards the network as well as towards the PV generator.

Figure 4

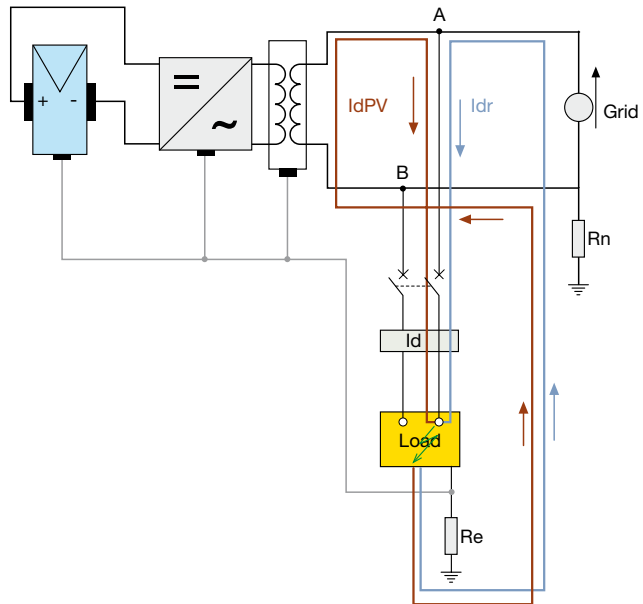

There must not be an exposed conductive part between the parallel point A-B and the network because in such case the normative requirement that all the exposed conductive parts of a consumer's plant in a TT system must be protected by a residual current circuit-breaker.

## 5 Photovoltaic plants

As regards the exposed conductive parts upstream the parallel point A-B, such as for instance the exposed conductive part of the transformer or of the inverter when the transformer is incorporated, a residual current device<sup>5</sup> shall be interposed as Figure 5 shows; this residual current device detects the leakage currents coming both from the network as well as from the PV generator. When the residual current device trips due to an earth fault current, the inverter goes in stand by due to lack of network voltage.

Figure 5

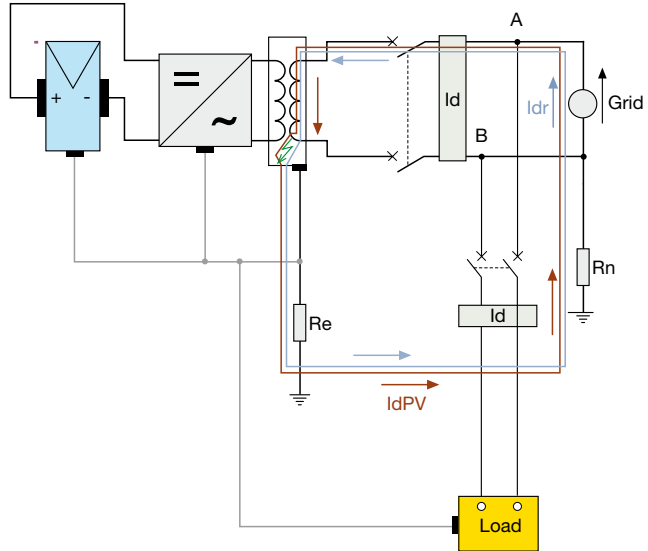

<sup>5</sup> The rated residual current shall be coordinated with the earth resistance  $R_e$ , in compliance with the usual relation of the TT systems:  $R_e \leq \frac{50}{I_{dn}}$

## 5 Photovoltaic plants

On the contrary, if the network-consumer system is type TN, for both the supply possibilities, either from the network or from the PV generator, residual current circuit-breakers are not needed provided that the fault current on the AC side causes the tripping of the overcurrent devices by the times prescribed in the Std. (Figure 6).

Figure 6

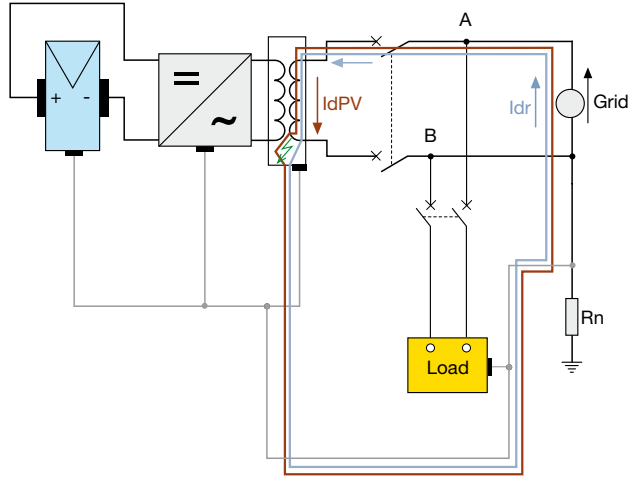

### 5.4.2 Plants without transformer

In case of absence of the separation transformer between the PV installation and the network, the PV installation itself shall be insulated from earth in its active parts becoming an extension of the supply network, generally with a point connected to earth (TT or TN system).

As regards the exposed conductive parts of the consumer's plant and upstream the parallel point A-B, from a conceptual point of view, what described in clause 6.4.1.2 is still valid.

On the DC side an earth fault on the exposed conductive parts determines the tripping of the residual current circuit-breaker positioned downstream the inverter (Figure 7). After the tripping of the residual current device, the inverter goes in stand by due to the lack of network voltage, but the fault is supplied by the PV generator. Since the PV system is type IT, the considerations made in clause 6.4.1.1.1 are valid.

## 5 Photovoltaic plants

For earth faults on the DC side and on the exposed conductive parts upstream the parallel point A-B, the residual current circuit-breaker on the load side of the inverter is passed through by a residual current which is not alternating. Therefore such device must be of type B<sup>6</sup>, unless the inverter is by construction such as not to inject DC earth fault currents (IEC 60364-7)<sup>7</sup>.

Figure 7

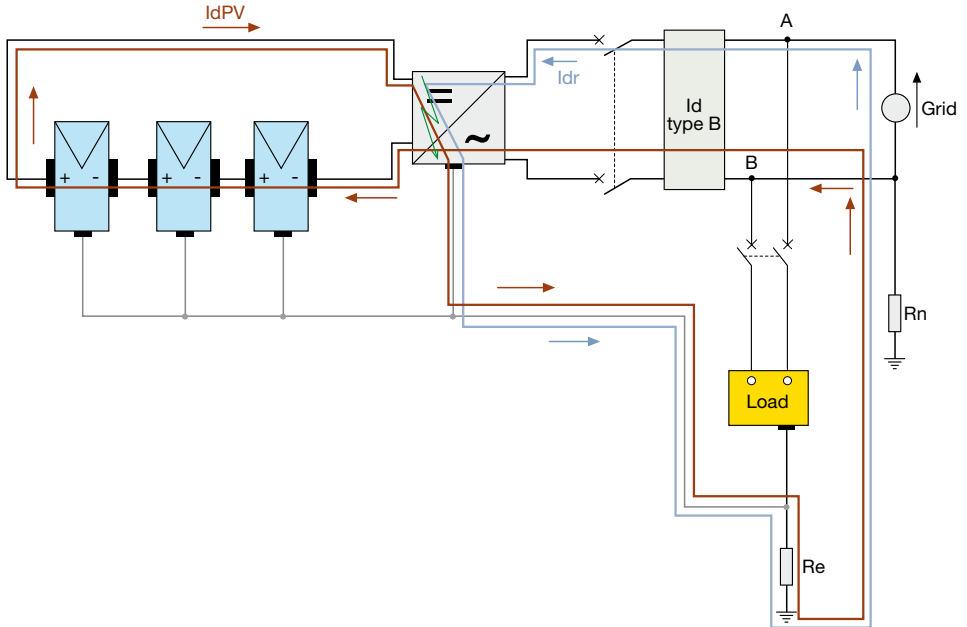

<sup>6</sup> The residual current device of type B detects the following typologies of earth fault currents:

- alternating (also at frequency exceeding the network one, e.g. up to 1000 Hz);
- pulsating unidirectional;
- direct.

<sup>7</sup> The Std. CEI EN 62040-1 prescribes that the protection of the UPS (including an inverter) against earth faults is realized by using residual current devices type B (for three-phase UPS) and type A (for single-phase UPS), whenever an earth fault current with DC components may be possible according to the UPS design.

---

# 5 Photovoltaic plants

---

## 5.5 Protection against overcurrents and overvoltages

When defining the layout of a photovoltaic plant it is necessary to provide, where needed, for the protection of the different sections of the plant against overcurrents and overvoltages of atmospheric origin.

Here are given, at first, the conditions for the protection against overcurrents in the PV plant on the supply (DC side) and on the load side of the inverter (AC side), then the methods for the protection of the plant against any damage caused by possible direct or indirect fulmination<sup>8</sup>.

### 5.5.1 Protection against overcurrents on DC side

#### 5.5.1.1 Cable protections

From the point of view of the protection against overloads, it is not necessary to protect the cables (CEI 64-8/7) if they are chosen with a current carrying capacity not lower than the maximum current which might affect them ( $1.25 I_{sc}$ )<sup>9</sup>.

<sup>9</sup>  $I_{sc}$  is the short-circuit current in the module under standard test conditions and the twenty-five per cent rise takes the insolation values exceeding  $1\text{ kW/m}^2$  into account.

As regards the short-circuit, the cables on the DC side are affected by such overcurrent in case of:

- fault between the polarity of the PV system;
- fault to earth in the earthed systems;
- double fault to earth in the earth-insulated systems.

A short-circuit on a cable for the connection string to subfield switchboard (fault 1 of Figure 8) is supplied simultaneously upstream of the load side of the string under consideration ( $I_{cc1} = 1.25 \cdot I_{sc}$ ) downstream of the other  $x-1$  strings connected to the same inverter ( $I_{cc2} = (x-1) \cdot 1.25 \cdot I_{sc}$ ).

If the PV plant is small-sized with two strings only ( $x=2$ ), it results that  $I_{cc2} = 1.25 \cdot I_{sc} = I_{cc1}$  and therefore it is not necessary to protect the string cables against short-circuit. On the contrary, when three or more strings ( $x \geq 3$ ) are connected to the inverter, the current  $I_{cc2}$  is higher than the service current and therefore the cables must be protected against the short-circuit when their current carrying capacity is lower than  $I_{cc2}$ , that is  $I_z < (x-1) \cdot 1.25 \cdot I_{sc}$ .

A short-circuit between a subfield switchboard and the inverter switchboard (fault 2 of the Figure 8) is supplied upstream by the  $y$  strings in parallel of the subfield ( $I_{cc3}$ ) and downstream by the remaining  $(x-y)$  strings relevant to the same inverter switchboard.

The short-circuit current  $I_{cc3} = y \cdot 1.25 \cdot I_{sc}$  coincides with the service current of the circuit between the subfield switchboard and inverter, whereas the current  $I_{cc4} = (x-y) \cdot 1.25 \cdot I_{sc}$  is higher than the service current if  $x-y > y \Rightarrow x > 2y$ .

In this case it is necessary to protect the cable against the short-circuit if its current carrying capacity is lower than  $I_{cc4}$ , that is  $I_z < (x-y) \cdot 1.25 \cdot I_{sc}$ .

<sup>8</sup> As regards the power factor correction of a user plant in the presence of a PV plant see Annex E of the QT8 "Power factor correction and harmonic filtering in electrical plants".

## 5 Photovoltaic plants

Figure 8

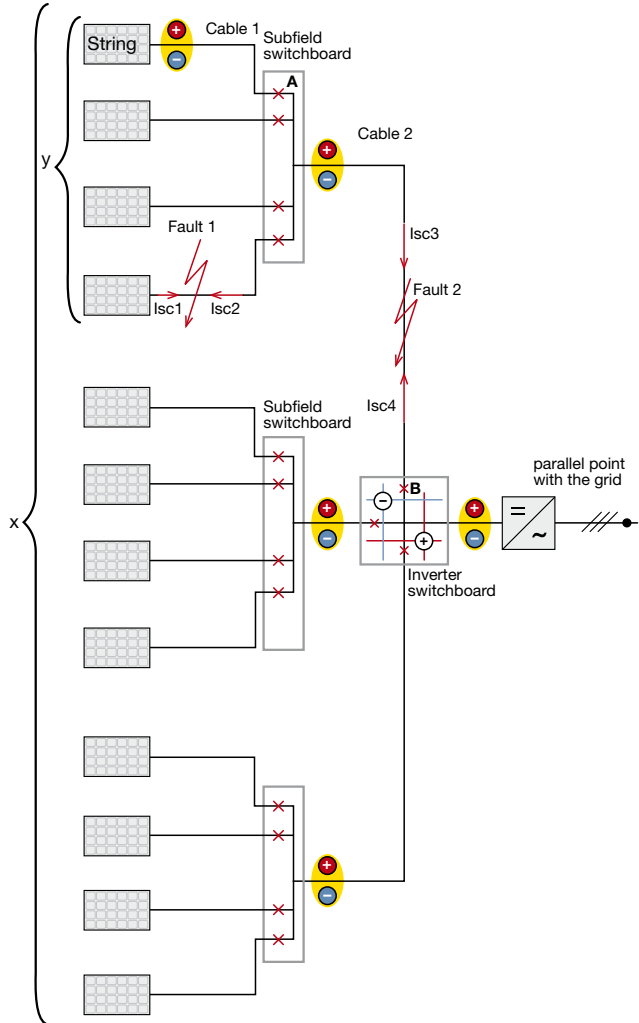

“A” represents the protective device in the subfield switchboard for the protection of the “cable 1” connecting the string to the switchboard itself.

“B” represents the protection device installed in the inverter switchboard to protect the “cable 2” for the connection between the inverter and the subfield switchboard.

“y” number of strings connected to the same subfield switchboard.

“x” total number of strings connected to the same inverter.

## 5 Photovoltaic plants

### 5.5.1.2 Protection of the strings against reverse current

Due to shading or fault a string becomes passive, absorbing and dissipating the electric power generated by the other strings connected in parallel to the same inverter through a current which flows through the string under consideration in a reverse direction with respect to that of standard operation, with possible damages to the modules. These are able to withstand a reverse current ranging from 2.5 and 3  $I_{sc}$  (IEC TS 62257-7-1).

Since with  $x$  strings in parallel connected to the same inverter the highest reverse current is equal to  $I_{inv} = (x-1) \cdot 1.25 \cdot I_{sc}$ , it is not necessary to protect the strings  $I_{inv} \leq 2.5 \cdot I_{sc}$  if that is  $(x-1) \cdot 1.25 \leq 2.5 \Rightarrow x \leq 3^{10}$ .

### 5.5.1.3 Behaviour of the inverter

The contribution to the short-circuit on the DC side of the inverter may come from the grid and from the discharge of the capacitors inside the inverter.

The grid current is due to the recirculating diodes of the bridge inverter which in this case act as a bridge rectifier. Such current is limited by the impedances of the transformer and of the inductors belonging to the output circuit and by the protection fuses of the inverter on the AC side chosen so that they can limit the thermal effects of possible internal faults on the semiconductors.

As a consequence the  $I^2t$  passing through will be normally reduced. Indicatively a final current value (internal capacitors completely discharged) of  $10I_n$  can be an upper limit value. This current is present in case of inverter with galvanic insulation at 50Hz, while it is null in case of inverter without transformer.

In fact these inverters usually have an input DC/DC converter so that the operation on a wide voltage range of the PV generator is guaranteed; this converter, due to its constructive typology, includes at least one blocking diodes which prevents the contribution of the grid current to the short-circuit.

The discharge current of the capacitors is limited by the cables between inverter and fault and exhausts itself with exponential trend: the lowest the impedance of the cable stretch, the highest the initial current, but the lowest the time constant of the discharge. The energy which flows is limited to that one initially stored in the capacitors. Moreover, if a blocking diode or other similar device is in series with one of the two poles, this contribution to the short-circuit is null.

In each case, the short-circuit on the DC side causes a drop of the direct voltage, the inverter certainly shuts down and probably is disconnected from the grid. Normally the shut down times of the inverter are of the order of some milliseconds, while the disconnection times may be of the order of some dozens of milliseconds. In the interval between the shut down and the disconnection, the grid might cause the above mentioned effect, while the internal capacitors, if involved, participate up to their complete discharge.

<sup>10</sup> The blocking diodes can be used, but they do not replace the protections against overcurrent (IEC TS 62257-7-1), since it is taken into consideration the possibility that the blocking diode does not work properly and is short-circuited. Moreover the diodes introduce a loss of power due to the voltage drop on the junction, a loss which can be reduced by using Schottky diodes with 0.4V drop instead of 0.7V of conventional diodes. However the rated reverse voltage of the diodes shall be  $\geq 2 U_{oc}$  and the rated current  $\geq 1.25 I_{sc}$  (CEI Guide 82-25).

## 5 Photovoltaic plants

However, the influences of both the grid and the internal capacitors on the short-circuit have only a transient nature and they are not such as to affect the sizing of the protection, switching and disconnection devices position on the DC side.

### 5.5.1.4 Choice of the protective devices

As regards the protection against the short-circuits on the DC side, the devices shall be obviously suitable for DC use and have a rated service voltage  $U_e$  equal or higher than the maximum voltage of the PV generator which is equal to  $1.2 U_{oc}$ <sup>11</sup> (IEC TS 62257-7-1).

Moreover the protection devices shall be positioned at the end of the circuit to be protected, proceeding from the strings towards the inverter, that is in the various subfield switchboards and inverter switchboards since the short-circuit currents come from the other strings, that is from the load side and not from the supply side (IEC TS 62257-7-1).

In order to avoid unwanted tripping under standard operation conditions, the protective devices positioned in the subfield switchboards (device A in the Figure 8) shall have a rated current  $I_n$ <sup>12</sup>:

$$I_n \geq 1.25 \cdot I_{sc} \quad (3)$$

These devices shall protect:

- every single string against the reverse current;
- the connection cable<sup>13</sup> string to subswitchboard (cable 1 of Figure 6.7) if the latter has a current carrying capacity lower than the maximum short-circuit current of the other x-1 strings connected to the same inverter switchboard<sup>14</sup>, i.e. if:

$$I_z < I_{cc2} = (x - 1) \cdot 1.25 \cdot I_{sc} \quad (4)$$

To the purpose of protection for the string, the rated current of the protective device (either thermomagnetic circuit-breaker or fuse) must not exceed that one declared by the manufacturer for the panel protection (clause 6.5.1.2); if no indications are given by the manufacturer, the following is assumed (IEC TS 62257-7-1):

$$1.25 \cdot I_{sc} \leq I_n \leq 2 \cdot I_{sc} \quad (5)$$

<sup>11</sup>  $U_{oc}$  is the no load voltage coming out of the strings.

<sup>12</sup> For thermomagnetic circuit-breakers the [6.1] becomes  $I_n \geq 1.25 \cdot I_{sc}$  while for magnetic only circuit-breakers  $I_n \geq 1.25 \cdot I_{sc}$  so that their overheating can be avoided.

<sup>13</sup> Protection against short-circuit only since  $I_z \geq 1.25 \cdot I_{sc}$ .

<sup>14</sup> The short-circuit  $I_{cc1} = 1.25 \cdot I_{sc}$  (Figure 6.1) is unimportant because the string cable has a current carrying capacity not lower than  $1.25 \cdot I_{sc}$ .



## 5 Photovoltaic plants

To the purpose of protection for the connection cable, the protective device must be chosen so that the following relation is satisfied for each value of short-circuit (IEC 60364)<sup>15</sup> up to a maximum of  $(x-1) \cdot 1.25 \cdot I_{sc}$ :

$$I^2 t \leq K^2 S^2 \quad (6)$$

The breaking capacity of the device must not be lower than the short-circuit current of the other  $n-1$  strings, that is:

$$I_{cu} \geq (x-1) \cdot 1.25 \cdot I_{sc} \quad (7)$$

The devices in the inverter switchboard must protect against the short-circuit the connection cables subfield switchboard-inverter switchboard when these cables have a current carrying capacity lower than  $I_{cc4} = (x-y) \cdot 1.25 \cdot I_{sc}$  (Figure 8). In this case these devices shall satisfy the relations (3) and (6), while their current carrying capacity shall not be lower than the short-circuit current of the other  $n-m$  strings, that is:

$$I_{cu} \geq (x-y) \cdot 1.25 \cdot I_{sc} \quad (8)$$

In short, the cable for the connection inverter switchboard to inverter must not be protected if its current carrying capacity is chosen at least equal to (CEI 64-8/7):

$$I_{cu} \geq (x-y) \cdot 1.25 \cdot I_{sc} \quad (9)$$

<sup>15</sup> For the magnetic only circuit-breaker it is necessary, if possible, to set  $I_3$  at a value equal to the value  $I_z$  of the cable in order to determine the tripping of the device when the short circuit current exceeds the current carrying capacity of the protected cable. Besides, it is possible to use a magnetic only circuit-breaker if the number of strings connected to the same inverter is maximum 3; otherwise for the protection of the string it is necessary to use a thermomagnetic circuit-breaker chosen according to (5).

<sup>16</sup> The short-circuit current  $I_{sc3} = y \cdot 1.25 \cdot I_{sc}$  (Figure 8) is unimportant since the string cable has a current carrying capacity not lower than  $y \cdot 1.25 \cdot I_{sc}$ .

## 5 Photovoltaic plants

### 5.5.2 Protection against overcurrents on AC side

Since the cable connecting the inverter to the point of connection with the grid is usually dimensioned to obtain a current carrying capacity higher than the maximum current which the inverter can deliver, a protection against overload is not needed. However the cable must be protected against a short circuit supplied by the grid<sup>17</sup> through a protective device positioned near the point of connection with the grid.

To protect such cable the main circuit-breaker of the consumer plant can be used if the specific let-through energy is withstood by the cable. However, the trip of the main circuit-breaker put all the consumer plant out of service. In the multi-inverter plants, (Figure 9) the presence of one protection for each line allows, in case of fault on an inverter, the functioning of the other ones, provided that the circuit-breakers on each line are selective with the main circuit-breaker.

Figure 9

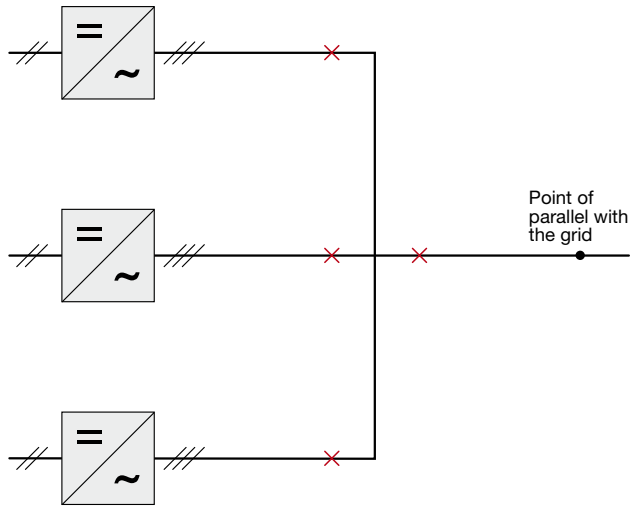

<sup>17</sup> Generally, the inverter limits the output current to a value which is the double of its rated current and goes in stand-by in few tenths of seconds due to the trip of the internal protection. As a consequence, the contribution of the inverter to the short-circuit current is negligible in comparison with the contribution of the grid.

## 5 Photovoltaic plants

### 5.5.3 Choice of the switching and disconnecting devices

The installation of a disconnecting device on each string is suitable in order to allow verification or maintenance interventions on the string without putting out of service other parts of the PV plant (CEI Guide 82-25 II ed.)<sup>18</sup>.

The disconnection of the inverter must be possible both on the DC side as well as on the AC side so that maintenance is allowed by excluding both the supply sources (grid and PV generator) (CEI 64-8/7).

On the DC side of the inverter a disconnecting device shall be installed which can be switched under load, such as a switch-disconnector. On the AC side a general disconnecting device shall be provided.

The protective device installed in the point of connection with the grid can be used; if this device is not close to the inverter, it is advisable to position a disconnecting device immediately on the load side of the inverter.

### 5.5.4 Protection against overvoltages

The PV installations, since they usually are outside the buildings, may be subject to overvoltages of atmospheric origin, both direct (lightning striking the structure) as well as indirect (lightning falling near to the structure of the building or affecting the energy or signaling lines entering the structure) through resistive or inductive coupling. The resistive coupling occurs when lightning strikes the electrical line entering the building. The lightning current, through the characteristic impedance of the line, originates an overvoltage which may exceed the impulse withstand voltage of the equipment, with consequent damaging and fire hazard.

The inductive coupling occurs because the lightning current is impulsive and therefore it generates in the surrounding space an electromagnetic field highly variable.

As a consequence, the variation in the magnetic field generates some overvoltages induced on the electric circuits nearby. In addition to the overvoltages of atmospheric origin, the PV plant may be exposed to internal switching overvoltages.

#### 5.5.4.1 Direct lightning

##### Building without LPS<sup>19</sup>

Generally, the erection of a PV plant does not change the outline of a building and therefore the frequency of the fulminations; therefore no specific measures against the risk of fulmination are necessary (CEI Guide 82-25, II ed.).

On the contrary, in case the PV installation changes significantly the outline of the building, it is necessary to reconsider the frequency of fulminations on it and consequently to take into consideration the necessity of realizing an LPS (CEI Guide 82-25 II ed.).

<sup>18</sup> When an automatic circuit-breaker is used the switching and disconnecting function is already included.

<sup>19</sup> Lightning Protection System: it is constituted by the protective systems both external (detectors, lightning conductors and ground electrodes) as well as internal (protective measures in order to reduce the electromagnetic effects of the lightning current entering the structure to be protected).

## 5 Photovoltaic plants

### Building with LPS

In case of presence of a protection system against atmospheric discharges<sup>20</sup>, if the PV plant does not alter the outline of the building and if the minimum distance  $d$  between the PV plant and the LPS plant is higher than the safety distances (EN 62305-3) other additional measures for the protection of the new plant (CEI Guide 82-25 II ed.) are not required.

On the contrary, if the PV plant does not alter the outline of the building, but the minimum distance  $d$  is lower than the distance  $s$  it is appropriate to extend the LPS plant and connect it to the metal structures of the PV installation (CEI Guide 82-25, II ed.).

Finally, if the PV plant alters the outline of the building a new risk evaluation and/or a modification of the LPS are necessary (CEI Guide 82-25, II ed.).

### PV plant on the ground

If a PV plant is erected on the ground there is no fire risk due to direct fulfilmination and the only hazard for human beings is represented by the step and touch voltages.

When the surface resistivity exceeds  $5 \text{ k}\Omega\text{m}$  (e.g. rocky asphalted ground, at least 5 cm thickness or laid with gravel for minimum 15 cm), it is not necessary to take any particular measure since the touch and step voltage values are negligible (CEI 81-10). Instead, if the ground resistivity were equal to or lower than  $5 \text{ k}\Omega\text{m}$ , it would be necessary to verify theoretically whether some protective measures against the step and touch voltages are necessary; however, in this case, the probability of lightning strikes is very small and therefore the problem occurs only with very large plants.

### Indirect lightning

Also in case lightning does not strike directly the structure of the PV plant, it is necessary to take some measures to minimize the overvoltages caused by any likely indirect strike of lightning:

- shielding of the circuits in order to reduce the magnetic field inside the enclosure with a consequent reduction of the induced overvoltages<sup>21</sup>;
- reduction of the area of the turn of the induced circuit obtained by connecting suitably the modules one to the other, by twisting the conductors together and bringing the live conductor as much as possible near to the PE.

<sup>20</sup> It is advisable that the protection grounding plant is connected to that for the protection against lightning.

<sup>21</sup> The shielding effect of a metal enclosure originates thanks to the currents induced in the enclosure itself; they create a magnetic field which by Lenz's law opposes the cause generating them, that is the magnetic field of the lightning current; the higher the currents induced in the shield (i.e. the higher its conductance), the better the shielding effect.

## 5 Photovoltaic plants

The overvoltages, even if limited, which may be generated must be discharged to ground by means of SPD (Surge Protective Device) to protect the equipment. In fact, SPDs are devices with impedance variable according to the voltage applied: at the rated voltage of the plant they have a very high impedance, whereas in the presence of an overvoltage they reduce their impedance, deriving the current associated to the overvoltage and keeping the latter within a determined range of values. According to their operation modalities SPDs can be divided into:

- switching SPDs, such as spinterometers or controlled diodes, when the voltage exceeds a defined value, reduce instantaneously their impedance and consequently the voltage at their ends;
- limitation SPDs, such as varistors or Zener diodes, have an impedance which decreases gradually at the increase of the voltage at their ends;
- combined SPDs which comprise the two above mentioned devices connected in series or in parallel.

### Protection on DC side

For the protection on the DC side it is advisable to use varistors SPDs or combined SPDs. Inverters usually have an internal protection against overvoltages, but if SPDs are added to the inverter terminals, its protection is improved and at the same time it is possible to avoid that the tripping of the internal protections put out of service the inverter, thus causing suspension of energy production and making necessary the intervention of skilled personnel. These SPDs should have the following characteristics:

- Type 2
- Maximum rated service voltage  $U_e > 1.25 U_{oc}$
- Protection level  $U_p \leq U_{inv}$ <sup>22</sup>
- Nominal discharge current  $I_n \geq 5 \text{ kA}$
- Thermal protection with the capability of extinguishing the short-circuit current at the end of life and coordination with suitable back-up protection.

Since the modules of the strings generally have an impulse withstand voltage higher than that of the inverter, the SPDs installed to protect the inverter generally allow the protection of the modules too, provided that the distance between modules and inverter is shorter than 10 m<sup>23</sup>.

<sup>22</sup>  $U_{inv}$  is the impulse withstand voltage of the inverter DC side.

<sup>23</sup> The SPD shall be installed on the supply side (direction of the energy of the PV generator) of the disconnecting device of the inverter so that it protects the modules also when the disconnecting device is open.

## 5 Photovoltaic plants

### Protection on AC side

A PV plant connected to the grid is subject also to the overvoltages coming from the line itself. If a separation transformer is present, with earthed metal shield, the inverter is protected against the overvoltages of the transformer itself. If the transformer is not present or in case of a transformer without shield, it is necessary to install a suitable SPD immediately downstream the inverter.

This SPDs should have the following characteristics:

- Type 2
- Maximum rated service voltage  $U_e > 1.1 U_o^{24}$
- Protection level  $U_p \leq U_{inv}^{25}$
- Nominal discharge current  $I_n \geq 5 \text{ kA}$
- Thermal protection with the capability of extinguishing the short-circuit current at the end of life and coordination with suitable back-up protection.

If the risk analysis for the building prescribes the installation of an outside LPS, it is necessary to position an SPD for the protection against direct lightning at the power delivery point. Such SPD should have the following characteristics:

- Type 1
- Maximum rated service voltage  $U_e > 1.1 U_o$
- Protection level  $U_p \leq U_{inv}$
- Impulse current  $I_{imp} \geq 25 \text{ kA}$  for each pole
- Extinction of the follow-up current  $I_f$  exceeding the short-circuit current at the installation point and coordination with a suitable back-up protection.

<sup>24</sup>  $U_o$  is the voltage to earth for TT and TN systems; in case of an IT system it is  $U_e > 1.73 U_o$ .

<sup>25</sup>  $U_{inv}$  is the impulse withstand voltage of the inverter on the AC side.

# 6 Calculation of short-circuit current

## 6.1 General aspects

A short-circuit is a fault of negligible impedance between live conductors having a difference in potential under normal operating conditions.

## 6.2 Fault typologies

In a three-phase circuit the following types of fault may occur:

- three-phase fault;
- two-phase fault;
- phase to neutral fault;
- phase to PE fault.

In the formulas, the following symbols are used:

- $I_k$  short-circuit current;
- $U_r$  rated voltage;
- $Z_L$  phase conductor impedance;
- $Z_N$  neutral conductor impedance;
- $Z_{PE}$  protective conductor impedance.

The following table briefly shows the type of fault and the relationships between the value of the short-circuit current for a symmetrical fault (three phase) and the short-circuit current for asymmetrical faults (two phase and single phase) in case of faults far from generators.

### Three-phase fault

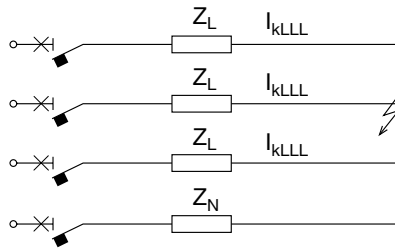

$$I_{kLLL} = \frac{U_r}{\sqrt{3}Z_L}$$

$$Z_L = \sqrt{R_L^2 + X_L^2}$$

### Two-phase fault

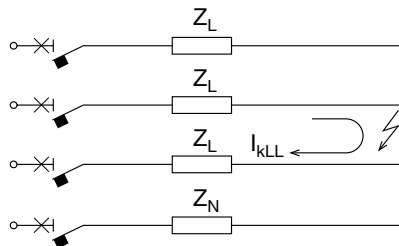

$$I_{kLL} = \frac{U_r}{2Z_L} = \frac{\sqrt{3}}{2} I_{kLLL} = 0.87 I_{kLLL}$$

## 6 Calculation of short-circuit current

### Phase to neutral fault

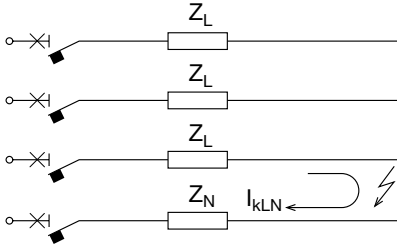

$$I_{kLN} = \frac{U_r}{\sqrt{3}(Z_L + Z_N)}$$

If  $Z_L = Z_N$  (cross section of neutral conductor equal to the phase conductor one):

$$I_{kLN} = \frac{U_r}{\sqrt{3}(Z_L + Z_N)} = \frac{U_r}{\sqrt{3}(2Z_L)} = 0.5I_{kLLL}$$

If  $Z_N = 2Z_L$  (cross section of neutral conductor half the phase conductor one):

$$I_{kLN} = \frac{U_r}{\sqrt{3}(Z_L + Z_N)} = \frac{U_r}{\sqrt{3}(3Z_L)} = 0.33I_{kLLL}$$

If  $Z_N = 0$  limit condition:

$$I_{kLN} = \frac{U_r}{\sqrt{3}(Z_L + Z_N)} = \frac{U_r}{\sqrt{3}(Z_L)} = I_{kLLL}$$

### Phase to PE fault

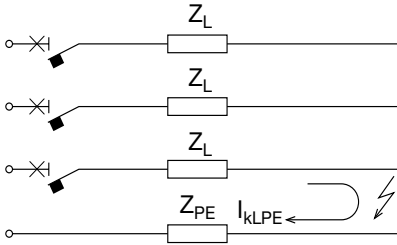

$$I_{kLPE} = \frac{U_r}{\sqrt{3}(Z_L + Z_{PE})}$$

If  $Z_L = Z_{PE}$  (cross section of protective conductor equal to the phase conductor one):

$$I_{kLPE} = \frac{U_r}{\sqrt{3}(Z_L + Z_{PE})} = \frac{U_r}{\sqrt{3}(2Z_L)} = 0.5I_{kLLL}$$

If  $Z_{PE} = 2Z_L$  (cross section of protective conductor half to the phase conductor one):

$$I_{kLPE} = \frac{U_r}{\sqrt{3}(Z_L + Z_{PE})} = \frac{U_r}{\sqrt{3}(3Z_L)} = 0.33I_{kLLL}$$

If  $Z_{PE} = 0$  limit condition:

$$I_{kLPE} = \frac{U_r}{\sqrt{3}(Z_L + Z_{PE})} = \frac{U_r}{\sqrt{3}(Z_L)} = I_{kLLL}$$

The following table allows the approximate value of a short-circuit current to be found quickly.

Note	Three-phase short-circuit	Two-phase short-circuit	Phase to neutral short-circuit	Phase to PE short-circuit (TN system)
$I_{kLLL}$	-	$I_{kLL} = 0.87I_{kLLL}$	$I_{kLN} = 0.5I_{kLLL} (Z_L = Z_N)$ $I_{kLN} = 0.33I_{kLLL} (Z_L = 0.5Z_N)$ $I_{kLN} = I_{kLLL} (Z_N = 0)$	$I_{kLPE} = 0.5I_{kLLL} (Z_L = Z_{PE})$ $I_{kLPE} = 0.33I_{kLLL} (Z_L = 0.5Z_{PE})$ $I_{kLPE} = I_{kLLL} (Z_{PE} = 0)$
$I_{kLL}$	$I_{kLLL} = 1.16I_{kLL}$	-	$I_{kLN} = 0.58I_{kLL} (Z_L = Z_N)$ $I_{kLN} = 0.38I_{kLL} (Z_L = 0.5Z_N)$ $I_{kLN} = 1.16I_{kLL} (Z_N = 0)$	$I_{kLPE} = 0.58I_{kLL} (Z_L = Z_{PE})$ $I_{kLPE} = 0.38I_{kLL} (Z_L = 0.5Z_{PE})$ $I_{kLPE} = 1.16I_{kLL} (Z_{PE} = 0)$
$I_{kLN}$	$I_{kLLL} = 2I_{kLN} (Z_L = Z_N)$ $I_{kLLL} = 3I_{kLN} (Z_L = 0.5Z_N)$ $I_{kLLL} = I_{kLN} (Z_N = 0)$	$I_{kLL} = 1.73I_{kLN} (Z_L = Z_N)$ $I_{kLL} = 2.6I_{kLN} (Z_L = 0.5Z_N)$ $I_{kLL} = 0.87I_{kLN} (Z_N = 0)$	-	



---

## 6 Calculation of short-circuit current

---

### 6.3 Determination of the short-circuit current: “short-circuit power method”

The short-circuit current can be determined by using the “short-circuit power method”. This method allows the determination of the approximate short-circuit current at a point in an installation in a simple way; the resultant value is generally acceptable. However, this method is not conservative and gives more accurate values, the more similar the power factors of the considered components are (network, generators, transformers, motors and large section cables etc.). The “short-circuit power method” calculates the short-circuit current  $I_k$  based on the formula:

$$\text{Three-phase short-circuit} \quad I_k = \frac{S_k}{\sqrt{3} \cdot U_r}$$

$$\text{Two-phase short-circuit} \quad I_k = \frac{S_k}{2 \cdot U_r}$$

where:

- $S_k$  is the short-circuit apparent power seen at the point of the fault;
- $U_r$  is the rated voltage.

To determine the short-circuit apparent power  $S_k$ , all the elements of the network shall be taken into account, which may be:

- elements which contribute to the short-circuit current:  
network, generators, motors;
- elements which limit the value of the short-circuit current:  
conductors and transformers.

The procedure for the calculation of the short-circuit current involves the following steps:

1. calculation of the short-circuit power for the different elements of the installation;
2. calculation of the short-circuit power at the fault point;
3. calculation of the short-circuit current.

---

#### 6.3.1 Calculation of the short-circuit power for the different elements of the installation

The short-circuit apparent power  $S_k$  shall be determined for all the components which are part of the installation:

##### Network

An electrical network is considered to include everything upstream of the point of energy supply.

## 6 Calculation of short-circuit current

Generally, the energy distribution authority supplies the short-circuit apparent power ( $S_{\text{knet}}$ ) value at the point of energy supply. However, if the value of the short-circuit current  $I_{\text{knet}}$  is known, the value of the power can be obtained by using, for three-phase systems, the following formula:

$$S_{\text{knet}} = \sqrt{3}U_r I_{\text{knet}}$$

where  $U_r$  is the rated voltage at the point of energy supply.

If the aforementioned data are not available, the values for  $S_{\text{knet}}$  given in the following table can be taken as reference values:

Net voltage $U_r$ [kV]	Short-circuit power $S_{\text{knet}}$ [MVA]
Up to 20	500
Up to 32	750
Up to 63	1000

### Generator

The short-circuit power is obtained from:

$$S_{\text{kgen}} = \frac{S_r \cdot 100}{X_{d\%}^2}$$

where  $X_{d\%}^2$  is the percentage value of the subtransient reactance ( $X_d''$ ) or of the transient reactance ( $X_d'$ ) or of the synchronous reactance ( $X_d$ ), according to the instant in which the value of the short-circuit power is to be evaluated.

In general, the reactances are expressed in percentages of the rated impedance of the generator ( $Z_d$ ) given by:

$$Z_d = \frac{U_r^2}{S_r}$$

where  $U_r$  and  $S_r$  are the rated voltage and power of the generator.

Typical values can be:

- $X_d''$  from 10 % to 20 %;
- $X_d'$  from 15 % to 40 %;
- $X_d$  from 80 % to 300 %.

Normally, the worst case is considered, that being the subtransient reactance.

The following table gives the approximate values of the short-circuit power of generators ( $X_d'' = 12.5\%$ ):

$S_r$ [kVA]	50	63	125	160	200	250	320	400	500	630	800	1000	1250	1600	2000	2500	3200	4000
$S_{\text{kgen}}$ [MVA]	0.4	0.5	1.0	1.3	1.6	2.0	2.6	3.2	4.0	5.0	6.4	8.0	10.0	12.8	16.0	20.0	25.6	32.0

## 6 Calculation of short-circuit current

### Asynchronous three-phase motors

Under short-circuit conditions, electric motors contribute to the fault for a brief period (5-6 periods).

The power can be calculated according to the short-circuit current of the motor ( $I_k$ ), by using the following expression:

$$S_{k\text{mot}} = \sqrt{3} \cdot U_r \cdot I_k$$

Typical values are:

$$S_{k\text{mot}} = 5 \div 7 S_{\text{mot}}$$

( $I_k$  is about  $5 \div 7 I_{\text{mot}}$ : 5 for motors of small size, and 7 for larger motors).

### Transformers

The short-circuit power of a transformer ( $S_{k\text{trafo}}$ ) can be calculated by using the following formula:

$$S_{k\text{trafo}} = \frac{100}{u_k \%} \cdot S_r$$

The following table gives the approximate values of the short-circuit power of transformers:

$S_r$ [kVA]	50	63	125	160	200	250	320	400	500	630	800	1000	1250	1600	2000	2500	3200	4000
$u_k$ %	4	4	4	4	4	4	4	4	4	4	5	5	5	6	6	6	6	6
$S_{k\text{trafo}}$ [MVA]	1.3	1.6	3.1	4	5	6.3	8	10	12.5	15.8	16	20	25	26.7	33.3			

### Cables

A good approximation of the short-circuit power of cables is:

$$S_{k\text{cable}} = \frac{U_r^2}{Z_c}$$

where the impedance of the cable ( $Z_c$ ) is:

$$Z_c = \sqrt{R_c^2 + X_c^2}$$

The following table gives the approximate values of the short-circuit power of cables, at 50 and 60 Hz, according to the supply voltage (cable length = 10 m):

## 6 Calculation of short-circuit current

S [mm <sup>2</sup> ]	230 [V]	400 [V]	440 [V]	500 [V]	690 [V]	230 [V]	400 [V]	440 [V]	500 [V]	690 [V]
	S <sub>kcable</sub> [MVA] @50 Hz					S <sub>kcable</sub> [MVA] @60 Hz				
1.5	0.44	1.32	1.60	2.07	3.94	0.44	1.32	1.60	2.07	3.94
2.5	0.73	2.20	2.66	3.44	6.55	0.73	2.20	2.66	3.44	6.55
4	1.16	3.52	4.26	5.50	10.47	1.16	3.52	4.26	5.50	10.47
6	1.75	5.29	6.40	8.26	15.74	1.75	5.29	6.40	8.26	15.73
10	2.9	8.8	10.6	13.8	26.2	2.9	8.8	10.6	13.7	26.2
16	4.6	14.0	16.9	21.8	41.5	4.6	13.9	16.9	21.8	41.5
25	7.2	21.9	26.5	34.2	65.2	7.2	21.9	26.4	34.1	65.0
35	10.0	30.2	36.6	47.3	90.0	10.0	30.1	36.4	47.0	89.6
50	13.4	40.6	49.1	63.4	120.8	13.3	40.2	48.7	62.9	119.8
70	19.1	57.6	69.8	90.1	171.5	18.8	56.7	68.7	88.7	168.8
95	25.5	77.2	93.4	120.6	229.7	24.8	75.0	90.7	117.2	223.1
120	31.2	94.2	114.0	147.3	280.4	29.9	90.5	109.5	141.5	269.4
150	36.2	109.6	132.6	171.2	326.0	34.3	103.8	125.6	162.2	308.8
185	42.5	128.5	155.5	200.8	382.3	39.5	119.5	144.6	186.7	355.6
240	49.1	148.4	179.5	231.8	441.5	44.5	134.7	163.0	210.4	400.7
300	54.2	164.0	198.4	256.2	488.0	48.3	146.1	176.8	228.3	434.7

With  $n$  cables in parallel, it is necessary to multiply the value given in the table by  $n$ . If the length of the cable ( $L_{act}$ ) is other than 10 m, it is necessary to multiply the value given in the table by the following coefficient:

$$\frac{10}{L_{act}}$$

### 6.3.2 Calculation of the short-circuit power at the fault point

The rule for the determination of the short-circuit power at a point in the installation, according to the short-circuit power of the various elements of the circuit, is analogue to that relevant to the calculation of the equivalent admittance. In particular:

- the power of elements in series is equal to the inverse of the sum of the inverses of the single powers (as for the parallel of impedances);

$$S_k = \frac{1}{\sum \frac{1}{S_i}}$$

- the short-circuit power of elements in parallel is equal to the sum of the single short-circuit powers (as for the series of impedances).

$$S_k = \sum S_i$$

The elements of the circuit are considered to be in series or parallel, seeing the circuit from the fault point.

In the case of different branches in parallel, the distribution of the current between the different branches shall be calculated once the short-circuit current at the fault point has been calculated. This must be done to ensure the correct choice of protection devices installed in the branches.

## 6 Calculation of short-circuit current

### 6.3.3 Calculation of the short-circuit current

To determine the short-circuit current in an installation, both the fault point as well as the configuration of the system which maximize the short-circuit current involving the device shall be considered. If appropriate, the contribution of the motors shall be taken into account.

For example, in the case detailed below, for circuit-breaker CB1, the worst condition occurs when the fault is right upstream of the circuit-breaker itself. To determine the breaking capacity of the circuit-breaker, the contribution of two transformers in parallel must be considered.

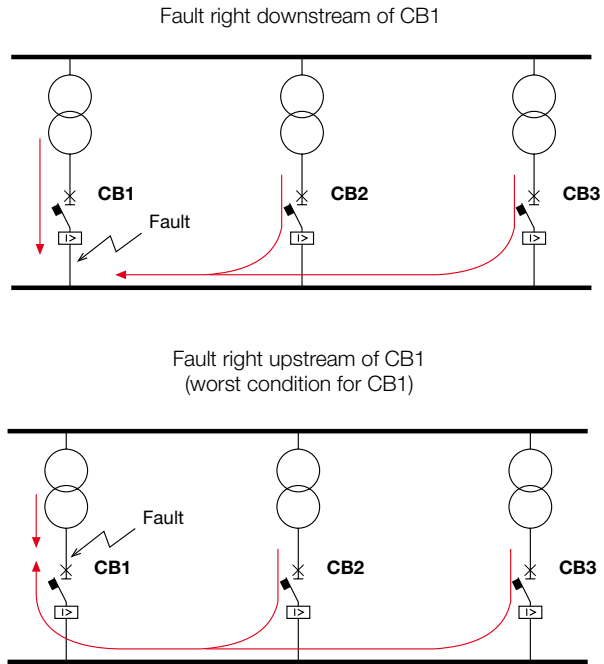

Once the short-circuit power equivalent at the fault point has been determined, the short-circuit current can be calculated by using the following formula:

Three-phase short-circuit 
$$I_k = \frac{S_k}{\sqrt{3} \cdot U_r}$$

Two-phase short-circuit 
$$I_k = \frac{S_k}{2 \cdot U_r}$$

## 6 Calculation of short-circuit current

As a first approximation, by using the following graph, it is possible to evaluate the three-phase short-circuit current downstream of an object with short-circuit power ( $S_{kEL}$ ) known; corresponding to this value, knowing the short-circuit power upstream of the object ( $S_{kUP}$ ), the value of  $I_k$  can be read on the y-axis, expressed in kA, at 400 V.

**Figure 1: Chart for the calculation of the three-phase short-circuit current at 400 V**

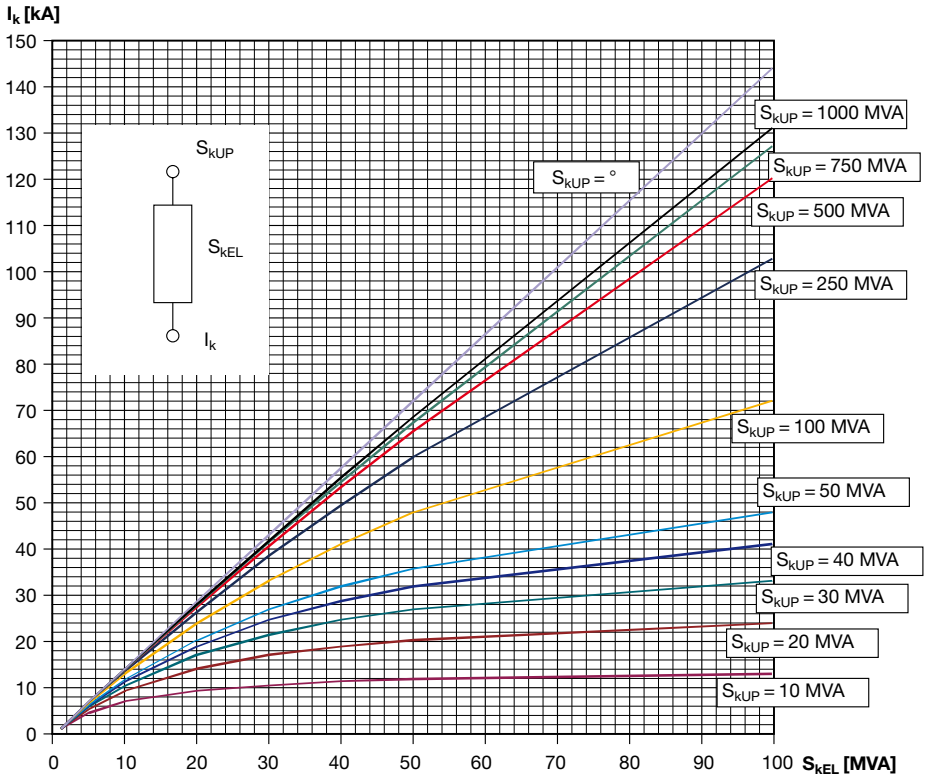

1SDCC10052F0001

## 6 Calculation of short-circuit current

### 6.3.4 Examples

The following examples demonstrate the calculation of the short-circuit current in some different types of installation.

#### Example 1

Upstream network:  $U_r = 20000 \text{ V}$   
 $S_{knet} = 500 \text{ MVA}$

Transformer:  $S_r = 1600 \text{ kVA}$   
 $u_k\% = 6\%$   
 $U_{1r} / U_{2r} = 20000/400$

Motor:  $P_r = 220 \text{ kW}$   
 $I_{kmot} / I_r = 6.6$   
 $\cos\varphi_r = 0.9$   
 $\eta = 0.917$

Generic load:  $I_{rL} = 1443.4 \text{ A}$   
 $\cos\varphi_r = 0.9$

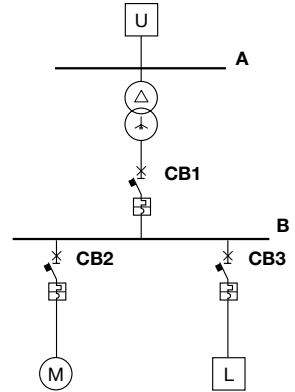

1SDC010063F0001

#### Calculation of the short-circuit power of different elements

Network:  $S_{knet} = 500 \text{ MVA}$

Transformer:  $S_{ktrafo} = \frac{100}{u_k\%} \cdot S_r = 26.7 \text{ MVA}$

Motor:  $S_{rmot} = \frac{P_r}{\eta \cdot \cos\varphi_r} = 267 \text{ kVA}$

$S_{kmot} = 6.6 \cdot S_{rmot} = 1.76 \text{ MVA}$  for the first 5-6 periods (at 50 Hz about 100 ms)

#### Calculation of the short-circuit current for the selection of circuit-breakers

##### Selection of CB1

For circuit-breaker CB1, the worst condition arises when the fault occurs right downstream of the circuit-breaker itself. In the case of a fault right upstream, the circuit-breaker would be involved only by the fault current flowing from the motor, which is remarkably smaller than the network contribution.

## 6 Calculation of short-circuit current

The circuit, seen from the fault point, is represented by the series of the network with the transformer. According to the previous rules, the short-circuit power is determined by using the following formula:

$$S_{kCB1} = \frac{S_{knet} \cdot S_{ktrafo}}{S_{knet} + S_{ktrafo}} = 25.35 \text{ MVA}$$

the maximum fault current is:

$$I_{kCB1} = \frac{S_{kCB1}}{\sqrt{3} \cdot U_r} = 36.6 \text{ kA}$$

The transformer LV side rated current is equal to 2309 A; therefore the circuit-breaker to select is an Emax E3N 2500.

Using the chart shown in Figure 1, it is possible to find  $I_{kCB1}$  from the curve with  $S_{kUP} = S_{knet} = 500 \text{ MVA}$  corresponding to  $S_{kEL} = S_{ktrafo} = 26.7 \text{ MVA}$ :

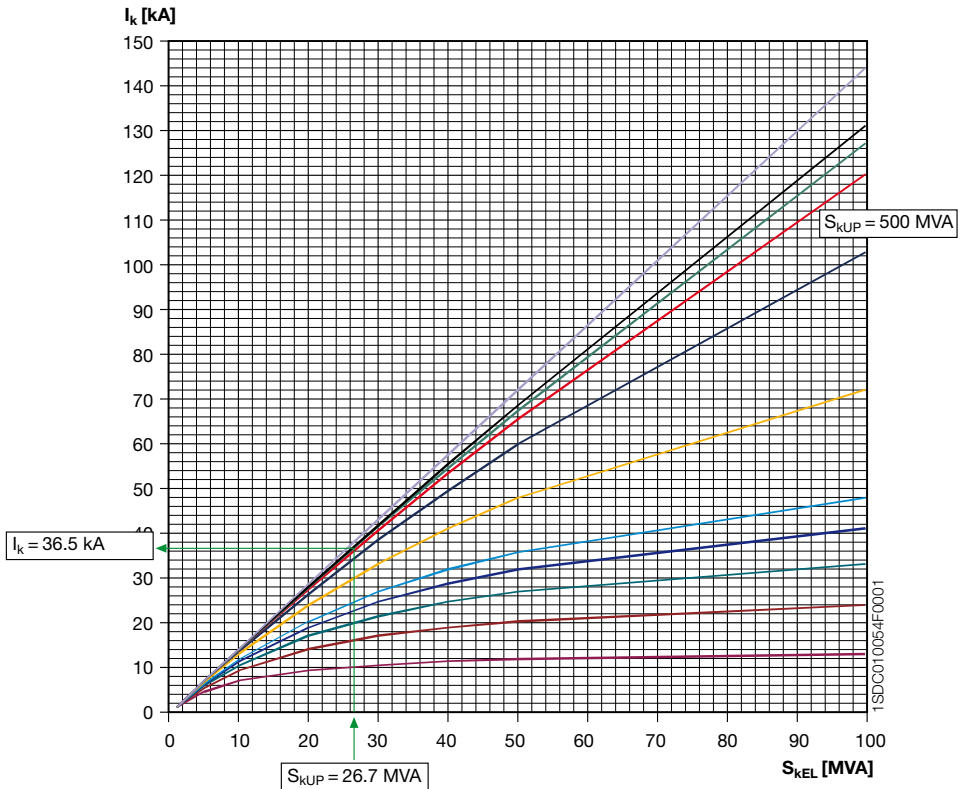



## 6 Calculation of short-circuit current

### Selection of CB2

For circuit-breaker CB2, the worst condition arises when the fault occurs right downstream of the circuit-breaker itself. The circuit, seen from the fault point, is represented by the series of the network with the transformer. The short-circuit current is the same used for CB1.

$$I_{kCB1} = \frac{S_{kCB1}}{\sqrt{3} \cdot U_r} = 36.6 \text{ kA}$$

The rated current of the motor is equal to 385 A; the circuit-breaker to select is a Tmax T5H 400.

### Selection of CB3

For CB3 too, the worst condition arises when the fault occurs right downstream of the circuit-breaker itself.

The circuit, seen from the fault point, is represented by two branches in parallel: the motor and the series of the network and transformer. According to the previous rules, the short-circuit power is determined by using the following formula:

Motor // (Network + Transformer)

$$S_{kCB3} = S_{kmot} + \frac{1}{\frac{1}{S_{knet}} + \frac{1}{S_{ktrafo}}} = 27.11 \text{ MVA}$$

$$I_{kCB3} = \frac{S_{kCB3}}{\sqrt{3} \cdot U_r} = 39.13 \text{ kA}$$

The rated current of the load L is equal to 1443 A; the circuit-breaker to select is a Tmax T7S1600 or an Emax X1B1600.

### Example 2

The circuit shown in the diagram is constituted by the supply, two transformers in parallel and three loads.

Upstream network:  $U_{r1} = 20000 \text{ V}$   
 $S_{knet} = 500 \text{ MVA}$

Transformers 1 and 2:  $S_r = 1600 \text{ kVA}$   
 $u_k\% = 6\%$   
 $U_{1r}/U_{2r} = 20000/400$

Load L1:  $S_r = 1500 \text{ kVA}$ ;  $\cos\varphi = 0.9$ ;

Load L2:  $S_r = 1000 \text{ kVA}$ ;  $\cos\varphi = 0.9$ ;

Load L3:  $S_r = 50 \text{ kVA}$ ;  $\cos\varphi = 0.9$ .

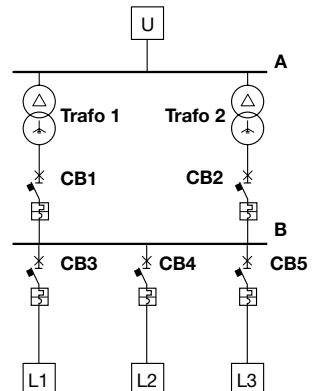

## 6 Calculation of short-circuit current

Calculation of the short-circuit powers of different elements:

Network  $S_{\text{knet}} = 500 \text{ MVA}$

Transformers 1 and 2  $S_{\text{ktrafo}} = \frac{S_r}{u_k \%} \cdot 100 = 26.7 \text{ MVA}$

### Selection of CB1 (CB2)

For circuit-breaker CB1 (CB2) the worst condition arises when the fault occurs right downstream of the circuit-breaker itself. According to the previous rules, the circuit seen from the fault point, is equivalent to the parallel of the two transformers in series with the network: Network + (Trafo 1 // Trafo 2).

The short-circuit current obtained in this way corresponds to the short-circuit current at the busbar. This current, given the symmetry of the circuit, is distributed equally between the two branches (half each). The current which flows through CB1 (CB2) is therefore equal to half of that at the busbar.

$$S_{\text{kbusbar}} = \frac{S_{\text{knet}} \cdot (S_{\text{rtrafo1}} + S_{\text{ktrafo2}})}{S_{\text{knet}} + (S_{\text{ktrafo1}} + S_{\text{ktrafo2}})} = 48.2 \text{ MVA}$$

$$I_{\text{kbusbar}} = \frac{S_{\text{kbusbar}}}{\sqrt{3} \cdot U_r} = 69.56 \text{ kA}$$

$$I_{\text{kCB1(2)}} = \frac{I_{\text{kbusbar}}}{2} = 34.78 \text{ kA}$$

The circuit-breakers CB1(CB2) to select, with reference to the rated current of the transformers, are Emax E3N 2500.

### Selection of CB3-CB4-CB5

For these circuit-breakers the worst condition arises when the fault occurs right downstream of the circuit-breakers themselves. Therefore, the short-circuit current to be taken into account is that at the busbar:

$$I_{\text{kCB3}} = I_{\text{kbusbar}} = 69.56 \text{ kA}$$

The circuit-breakers to select, with reference to the current of the loads, are:

CB3: Emax E3S 2500

CB4: Emax E2S 1600

CB5: Tmax T2H 160

## 6 Calculation of short-circuit current

### 6.4 Determination of the short-circuit current $I_k$ downstream of a cable as a function of the upstream one

The table below allows the determination, in a conservative way, of the three-phase short-circuit current at a point in a 400 V network downstream of a single pole copper cable at a temperature of 20 °C. Known values:

- the three-phase short-circuit current upstream of the cable;
- the length and cross section of the cable.

Cable section [mm <sup>2</sup> ]	Length [m]															
	0.9	1	1.2	1.5	1.8	2.3	2.9	3.5	4.1	4.7	5.8	7	9.4	12	16	24
1.5																
2.5																
4																
6																
10																
16																
25																
35																
50																
70																
95																
120																
150																
185																
240																
300																
2x120																
2x150																
2x185																
3x120																
3x150																
3x185																

$I_k$ upstream [kA]	$I_k$ downstream [kA]																								
100	96	92	89	85	82	78	71	65	60	50	43	36	31	27	24	20	17	13	11	7.8	5.6	3.7	2.7	2.0	1.3
90	86	83	81	78	76	72	67	61	57	48	42	35	31	27	24	20	17	13	11	7.8	5.6	3.7	2.7	2.0	1.3
80	77	75	73	71	69	66	62	57	53	46	40	34	30	27	24	20	17	13	10	7.7	5.5	3.7	2.7	2.0	1.3
70	68	66	65	63	62	60	56	53	49	43	38	33	29	26	23	19	16	13	10	7.6	5.5	3.7	2.7	2.0	1.3
60	58	57	56	55	54	53	50	47	45	40	36	31	28	25	23	19	16	12	10	7.5	5.4	3.7	2.7	2.0	1.3
50	49	48	47	46	45	44	43	41	39	35	32	29	26	23	21	18	15	12	10	7.3	5.3	3.6	2.6	2.0	1.3
40	39	39	38	38	37	37	35	34	33	31	28	26	24	22	20	17	15	12	10	7.1	5.2	3.6	2.6	2.0	1.3
35	34	34	34	33	33	32	32	31	30	28	26	24	22	20	19	16	14	11	10	7.1	5.1	3.5	2.6	2.0	1.3
30	30	29	29	28	28	28	27	26	25	23	22	20	19	18	16	14	11	9.3	7.0	5.0	3.5	2.6	1.9	1.3	
25	25	24	24	24	24	24	23	23	22	21	21	19	18	17	16	14	13	11	9.0	6.8	5.0	3.4	2.6	1.9	1.3
20	20	20	20	19	19	19	19	18	18	18	17	16	15	15	14	13	12	10	8.4	6.5	4.8	3.3	2.5	1.9	1.3
15	15	15	15	15	14	14	14	14	14	14	13	13	12	12	12	11	10	8.7	7.6	6.1	4.6	3.2	2.5	1.9	1.3
12	12	12	12	12	12	12	12	11	11	11	11	11	10	10	10	9.3	8.8	7.8	7.0	5.7	4.4	3.1	2.4	1.9	1.3
10	10	10	10	10	10	10	10	9.5	9.4	9.2	9.0	8.8	8.5	8.3	8.1	7.7	7.3	6.5	5.9	5.0	3.9	2.9	2.3	1.8	1.2
8.0	8.0	7.9	7.9	7.9	7.8	7.8	7.7	7.7	7.6	7.5	7.4	7.2	7.1	6.9	6.8	6.5	6.2	5.7	5.2	4.5	3.7	2.8	2.2	1.7	1.2
6.0	6.0	5.9	5.9	5.9	5.9	5.8	5.8	5.8	5.7	5.6	5.5	5.4	5.3	5.2	5.1	4.9	4.8	4.4	4.1	3.6	3.1	2.4	2.0	1.6	1.1
3.0	3.0	3.0	3.0	3.0	3.0	3.0	2.9	2.9	2.9	2.9	2.9	2.8	2.8	2.8	2.7	2.7	2.6	2.5	2.4	2.2	2.0	1.7	1.4	1.2	0.9

## 6 Calculation of short-circuit current

### Note:

- In the case of the  $I_k$  upstream and the length of the cable not being included in the table, it is necessary to consider:
  - the value right above  $I_k$  upstream;
  - the value right below for the cable length.

These approximations allow calculations which favour safety.

- In the case of cables in parallel not present in the table, the length must be divided by the number of cables in parallel.

### Example

Data

Rated voltage = 400 V

Cable section = 120 mm<sup>2</sup>

Conductor = copper

Length = 29 m

Upstream short-circuit current = 32 kA

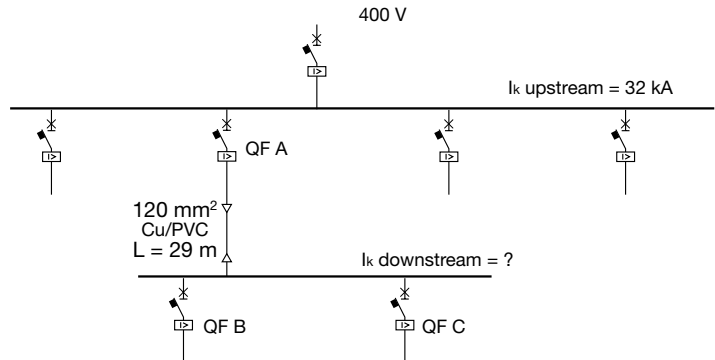

1SDC010056F0001

### Procedure

In the row corresponding to the cable cross section 120 mm<sup>2</sup>, it is possible to find the column for a length equal to 29 m or right below (in this case 24). In the column of upstream short-circuit current it is possible to identify the row with a value of 32 kA or right above (in this case 35). From the intersection of this last row with the previously identified column, the value of the downstream short-circuit current can be read as being equal to 26 kA.

# 6 Calculation of short-circuit current

## 6.5 Algebra of sequences

### 6.5.1 General aspects

It is possible to study a symmetrical, balanced three-phase network in quite a simple way by reducing the three-phase network to a single-phase one having the same value of rated voltage as the three-phase system line-to-neutral voltage.

Asymmetric networks cannot be reduced to the study of a single-phase network just because of this unbalance. In this case, being impossible any simplification, it is necessary to proceed according to the analysis methods typical for the solution of electrical systems.

The modelling technique allowing the calculation of an asymmetric and unbalanced network by converting it to a set of three balanced networks that each can be represented by a single-phase equivalent circuit easily solvable is the method of symmetrical components.

This method derives from mathematical considerations according to which any set of three phasors<sup>1</sup> can be divided into three sets of phasors with the following characteristics:

- a balanced set, called *positive sequence*, formed by three phasors of equal magnitude shifted by  $120^\circ$  and having the same phase sequence as the original system
- a balanced set, called *negative sequence*, formed by three phasors of equal magnitude shifted by  $120^\circ$  and having inverse phase sequence to that of the original system
- a *zero sequence* set formed by three phasors of equal magnitude in phase.

Figure 1

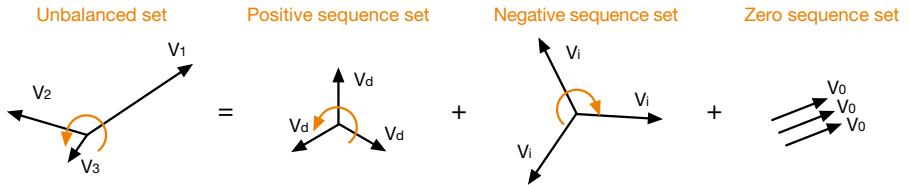

<sup>1</sup> The phasor is a vectorial representation of magnitude which varies in time. A signal of type  $v(t) = \sqrt{2} \cdot V \cdot \cos(\omega \cdot t + \varphi)$  is represented by the phasor  $\vec{v} = V \cdot e^{i\varphi}$

## 6 Calculation of short-circuit current

### 6.5.2 Positive, negative and zero sequence systems

The following relationships\* represent the link between the quantities of the three-phase balanced network and the positive, negative and zero sequence systems:

$$\begin{array}{llll}
 \bar{V}_0 = \frac{1}{3} (\bar{V}_1 + \bar{V}_2 + \bar{V}_3) & \bar{I}_0 = \frac{1}{3} (\bar{I}_1 + \bar{I}_2 + \bar{I}_3) & \bar{V}_1 = \bar{V}_0 + \bar{V}_d + \bar{V}_i & \bar{I}_1 = \bar{I}_0 + \bar{I}_d + \bar{I}_i \\
 \bar{V}_d = \frac{1}{3} (\bar{V}_1 + \alpha \cdot \bar{V}_2 + \alpha^2 \cdot \bar{V}_3) & \bar{I}_d = \frac{1}{3} (\bar{I}_1 + \alpha \cdot \bar{I}_2 + \alpha^2 \cdot \bar{I}_3) & \bar{V}_2 = \bar{V}_0 + \alpha^2 \cdot \bar{V}_d + \alpha \cdot \bar{V}_i & \bar{I}_2 = \bar{I}_0 + \alpha^2 \cdot \bar{I}_d + \alpha \cdot \bar{I}_i \\
 \bar{V}_i = \frac{1}{3} (\bar{V}_1 + \alpha^2 \cdot \bar{V}_2 + \alpha \cdot \bar{V}_3) & \bar{I}_i = \frac{1}{3} (\bar{I}_1 + \alpha^2 \cdot \bar{I}_2 + \alpha \cdot \bar{I}_3) & \bar{V}_3 = \bar{V}_0 + \alpha \cdot \bar{V}_d + \alpha^2 \cdot \bar{V}_i & \bar{I}_3 = \bar{I}_0 + \alpha \cdot \bar{I}_d + \alpha^2 \cdot \bar{I}_i
 \end{array}$$

\* In the formulas, the subscripts relevant to positive-sequence, negative-sequence and zero-sequence components are indicated by "d", "i" and "0" respectively.

The complex constant  $\alpha = -\frac{1}{2} + j\frac{\sqrt{3}}{2}$  is a versor which, multiplied by a vector, rotates the vector by  $120^\circ$  in a positive direction (counterclockwise).

The complex constant  $\alpha^2 = -\frac{1}{2} - j\frac{\sqrt{3}}{2}$  operates a  $-120^\circ$  rotation.

Some useful properties of this set of three vectors are:

$$\begin{array}{l}
 1 + \alpha + \alpha^2 = 0 \\
 |\alpha^2 - \alpha| = \sqrt{3}
 \end{array}$$

Figure 2

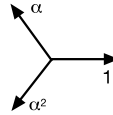

Therefore, it is possible to state that a real three-phase network may be replaced by three single-phase networks related to the three positive, negative and zero sequences, by substituting each component with the corresponding equivalent circuit. If generators can be considered symmetrical as it occurs in plant practice, by considering as a positive sequence set the one they generate, the three single-phase networks are defined by the following circuits and equations:

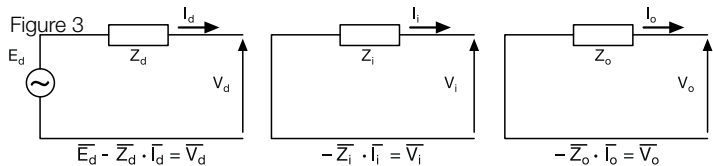

Where:

- $E_d$  is the line-to-neutral voltage ( $E_d = \frac{U_r}{\sqrt{3}}$ ) of the section upstream the fault
- $Z$  is the system impedance upstream the fault location
- $I$  is the fault current
- $V$  is the voltage measured at the fault location.

## 6 Calculation of short-circuit current

### 6.5.3 Calculation of short-circuit current with the algebra of sequences

Without going into the details of a theoretical treatment, it is possible to show the procedure to simplify and resolve the electrical network under a pre-established fault condition through an example.

#### Isolated line-to-line fault

The diagram showing this fault typology and the link between currents and voltages, may be represented as follows:

Figure 4

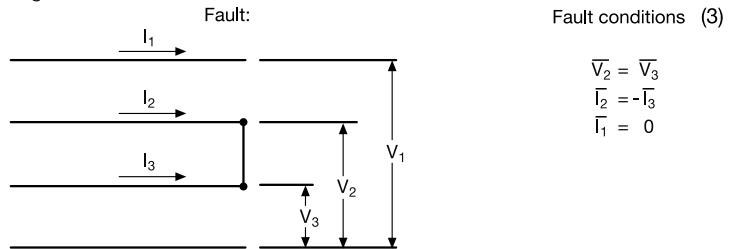

By using the given fault conditions and the formula 1), it follows that:

$$\begin{aligned} V_d &= V_i \\ I_d &= -I_i \end{aligned} \quad (4)$$

$I_o = 0$  therefore  $V_o = 0$

These relationships applied to the three sequence circuits of Figure 3 allow the definition of the sequence network equivalent to the three-phase network under study and representing the initial fault condition. This network may be represented as follows:

Figure 5

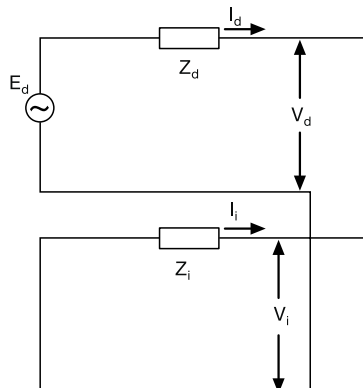

## 6 Calculation of short-circuit current

By solving this simple network (constituted by series-connected elements) in relation to the current  $\bar{I}_d$ , the following is obtained:

$$\bar{I}_d = \frac{\bar{E}_d}{\bar{Z}_d + \bar{Z}_i} \quad 5)$$

By using formulas 2) referred to the current, and formulas 4), it follows that:

$$\bar{I}_2 = (\alpha^2 - \alpha) \cdot \bar{I}_d \quad \bar{I}_3 = (\alpha - \alpha^2) \cdot \bar{I}_d$$

Since  $|\alpha^2 - \alpha|$  results to be equal to  $\sqrt{3}$ , the value of the line-to-line short-circuit current in the two phases affected by the fault can be expressed as follows:

$$|\bar{I}_2| = |\bar{I}_3| = |\bar{I}_{k2}| = \sqrt{3} \cdot \left| \frac{\bar{E}_d}{\bar{Z}_d + \bar{Z}_i} \right|$$

Using formulas 2) referred to the voltage, and formulas 4) previously found, the following is obtained:

$$\bar{V}_1 = 2 \cdot \bar{V}_i \quad 6) \text{ for the phase not affected by the fault}$$

$$\bar{V}_2 = \bar{V}_3 = (\alpha^2 + \alpha) \cdot \bar{V}_d = -\bar{V}_d \quad 7) \text{ for the phases affected by the fault}$$

Through the negative sequence circuit, relation 6) can be written as  $\bar{V}_1 = -2 \cdot \bar{Z}_i \cdot \bar{I}_i$ .

Further to the above, and since  $\bar{I}_d = -\bar{I}_i$ , the phase not affected by the fault shall be:

$$\bar{V}_1 = \frac{2 \cdot \bar{Z}_i}{\bar{Z}_d + \bar{Z}_i} \cdot \bar{E}_d$$

For the phases affected by the fault, being  $\bar{V}_d = \bar{V}_i = \frac{\bar{V}_1}{2}$ , it results:

$$\bar{V}_2 = \bar{V}_3 = -\frac{\bar{V}_1}{2} = -\frac{\bar{Z}_i \cdot \bar{E}_d}{\bar{Z}_d + \bar{Z}_i}$$

Making reference to the previous example, it is possible to analyse all fault typologies and to express the fault currents and voltages as a function of the impedances of the sequence components.



## 6 Calculation of short-circuit current

A summary is given in Table 1 below:

Type of fault	Fault conditions:	Current	Voltage on phases
Three-phase short-circuit 	$\bar{V}_1 = \bar{V}_2 = \bar{V}_3$ $\bar{I}_1 + \bar{I}_2 + \bar{I}_3 = 0$	$ \bar{I}_{k3}  =  \bar{I}_1  = \frac{U_n}{\sqrt{3} \cdot  \bar{Z}_d }$	$\bar{V}_1 = \bar{V}_2 = \bar{V}_3 = 0$
Line-to-line short-circuit 	$\bar{V}_2 = \bar{V}_3$ $\bar{I}_2 = -\bar{I}_3$	$ \bar{I}_{k2}  =  \bar{I}_2  = \frac{U_n}{ \bar{Z}_d + \bar{Z}_1 }$	$ \bar{V}_1  = \frac{2}{\sqrt{3}} \cdot U_n \cdot \left  \frac{\bar{Z}_1}{\bar{Z}_d + \bar{Z}_1} \right $ $ \bar{V}_2  =  \bar{V}_3  = \frac{U_n}{\sqrt{3}} \cdot \left  \frac{\bar{Z}_1}{\bar{Z}_d + \bar{Z}_1} \right $
Line-to-line short-circuit with earth connection 	$\bar{V}_2 = \bar{V}_3 = 0$ $\bar{I}_1 = 0$	$ \bar{I}_2  = U_n \cdot \left  \frac{(1+\alpha) \cdot \bar{Z}_1 + \bar{Z}_0}{\bar{Z}_d \cdot \bar{Z}_1 + \bar{Z}_1 \cdot \bar{Z}_0 + \bar{Z}_0 \cdot \bar{Z}_d} \right $ $ \bar{I}_3  = U_n \cdot \left  \frac{(1+\alpha) \cdot \bar{Z}_1 + \bar{Z}_0}{\bar{Z}_d \cdot \bar{Z}_1 + \bar{Z}_1 \cdot \bar{Z}_0 + \bar{Z}_0 \cdot \bar{Z}_d} \right $ $ \bar{I}_{\text{ground}}  =  \bar{I}_2 + \bar{I}_3  = U_n \cdot \left  \frac{\bar{Z}_1}{\bar{Z}_d \cdot \bar{Z}_1 + \bar{Z}_1 \cdot \bar{Z}_0 + \bar{Z}_0 \cdot \bar{Z}_d} \right $	$\bar{V}_2 = \bar{V}_3 = 0$ $ \bar{V}_1  = \sqrt{3} \cdot U_n \cdot \left  \frac{\bar{Z}_1 \cdot \bar{Z}_0}{\bar{Z}_d \cdot \bar{Z}_1 + \bar{Z}_1 \cdot \bar{Z}_0 + \bar{Z}_0 \cdot \bar{Z}_d} \right $
Single line short-circuit 	$\bar{V}_1 = 0$ $\bar{I}_2 = \bar{I}_3 = 0$	$ \bar{I}_{k1}  =  \bar{I}_1  = \frac{\sqrt{3} \cdot U_n}{ \bar{Z}_d + \bar{Z}_1 + \bar{Z}_0 }$	$\bar{V}_1 = 0$ $ \bar{V}_2  = U_n \cdot \left  \frac{\bar{Z}_1 - \alpha \cdot \bar{Z}_0}{\bar{Z}_d + \bar{Z}_1 + \bar{Z}_0} \right $ $ \bar{V}_3  = U_n \cdot \left  \frac{-\alpha \cdot \bar{Z}_1 + \bar{Z}_0}{\bar{Z}_d + \bar{Z}_1 + \bar{Z}_0} \right $

## 6 Calculation of short-circuit current

### 6.5.4 Positive, negative and zero sequence short-circuit impedances of electrical equipment

Each component of an electrical network (utility – transformer – generator – cable) may be represented by a positive, negative and zero sequence impedance value.

#### Utility

By utility it is meant the distribution supply network (usually MV) from which the plant is fed. It is characterized by positive and negative sequence elements, whereas the zero sequence impedance is not taken into consideration since the delta-connected windings of the primary circuit of the transformer impede the zero sequence current. As regards the existing impedances, it can be written:

$$Z_d = Z_i = Z_{NET} \frac{U_r}{\sqrt{3} \cdot I_{k3}}$$

#### Transformer

It is characterized by positive and negative sequence elements; besides, as a function of the connection of the windings and of the distribution system on the LV side, the zero sequence component may be present too.

Thus, it is possible to say that:

$$Z_d = Z_i = Z_T = \frac{uk \%}{100} \cdot \frac{U_r^2}{S_r}$$

whereas the zero sequence component can be expressed as:

$Z_o = Z_T$  when the flow of zero sequence currents in the two windings is possible

$Z_o = \infty$  when the flow of zero sequence currents in the two windings is impossible

#### Cable

It is characterized by positive, negative and zero sequence elements which vary as a function of the return path of the short-circuit current.

As regards the positive and negative sequence components, it is possible to say that:

$$Z_d = Z_i = Z_C = R_C + j X_C$$

To evaluate the zero sequence impedance, it is necessary to know the return path of the current:

$$Z_o = Z_C + j3 \cdot Z_{nC} = (R_C + 3 \cdot R_{nC}) + j(X_C + 3 \cdot X_{nC})$$

Return through the neutral wire (phase-to-neutral fault)

$$Z_o = Z_C + j3 \cdot Z_{PEc} = (R_C + 3 \cdot R_{PEc}) + j(X_C + 3 \cdot X_{PEc})$$

Return through PE (phase-to-PE conductor fault in TN-S system)

$$Z_o = Z_{EC} + j3 \cdot Z_{EC} = (R_C + 3 \cdot R_{EC}) + j(X_C + 3 \cdot X_{EC})$$

Return through ground (phase-to-ground fault in TT system)

where:

- $Z_C$ ,  $R_C$  and  $X_C$  refer to the line conductor
- $Z_{nC}$ ,  $R_{nC}$  and  $X_{nC}$  refer to the neutral conductor
- $Z_{PEc}$ ,  $R_{PEc}$  and  $X_{PEc}$  refer to the protection conductor PE
- $Z_{EC}$ ,  $R_{EC}$  and  $X_{EC}$  refer to the ground.

## 6 Calculation of short-circuit current

### Synchronous generators

Generally speaking, positive, negative and zero sequence reactances of synchronous generators (and also of rotating machines) have different values.

For the positive sequence, only the sub transient reactance  $X_d''$  is used, since, in this case, the calculation of the fault current gives the highest value.

The negative sequence reactance is very variable, ranging between the values of  $X_d''$  and  $X_q''$ . In the initial instants of the short-circuit,  $X_d''$  and  $X_q''$  do not differ very much and therefore we may consider  $X_i = X_d''$ . On the contrary if  $X_d''$  and  $X_q''$  are remarkably different, it is possible to use a value equal to the average value of the two reactances; it follows that:

$$X_i = \frac{X_d'' + X_q''}{2}$$

The zero sequence reactance is very variable too and results to be lower than the other two above mentioned reactances. For this reactance, a value equal to 0.1 to 0.7 times the negative or positive sequence reactances may be assumed and can be calculated as follows:

$$X_o = \frac{x_o\%}{100} \cdot \frac{U_r^2}{S_r}$$

where  $x_o\%$  is a typical parameter of the machine. Besides, the zero sequence component results to be influenced also by the grounding modality of the generator through the introduction of the parameters  $R_G$  and  $X_G$ , which represent, respectively, the grounding resistance and the reactance of the generator. If the star point of the generator is inaccessible or anyway non-earthed, the grounding impedance is  $\infty$ .

To summarize, the following expressions are to be considered for the sequence impedances:

$$Z_d = (R_a + j \cdot X_d'')$$

$$Z_i = (R_a + j \cdot X_i'')$$

$$Z_o = R_a + 3 \cdot R_G + j \cdot (X_o + 3 \cdot X_G)$$

where  $R_a$  is the stator resistance defined as  $R_a = \frac{X_d''}{2 \cdot \pi \cdot f \cdot T_a}$ , with  $T_a$  as stator time constant.

## 6 Calculation of short-circuit current

### Loads

If the load is passive, the impedance shall be considered as infinite.

If the load is not passive, as it could be for an asynchronous motor, it is possible to consider the machine represented by the impedance  $Z_M$  for the positive and negative sequence, whereas for the zero sequence the value  $Z_{0M}$  must be given by the manufacturer. Besides, if the motors are not earthed, the zero sequence impedance shall be  $\infty$ .

Therefore:

$$Z_d = Z_i = Z_M = (R_M + j \cdot X_M)$$

with  $Z_M$  equal to

$$Z_M = \frac{U_r^2}{\frac{I_{LR}}{I_r} \cdot S_r}$$

where:

$I_{LR}$  is the current value when the rotor is blocked by the motor

$I_r$  is the rated current of the motor

$S_r = \frac{P_r}{(\eta \cdot \cos\varphi_r)}$  is the rated apparent power of the motor

The ratio  $\frac{R_M}{X_M}$  is often known; for LV motors, this ratio can be considered equal

to 0.42 with  $X_M = \frac{Z_M}{\sqrt{1 + \left(\frac{R_M}{X_M}\right)^2}}$ , from which  $X_M = 0.922 \cdot Z_M$  can be determined.

## 6 Calculation of short-circuit current

### 6.5.5 Formulas for the calculation of the fault currents as a function of the electrical parameters of the plant

Through Table 1 and through the formulas given for the sequence impedances expressed as a function of the electrical parameters of the plant components, it is possible to calculate the different short-circuit currents.

In the following example, a network with a MV/LV transformer with delta primary winding and secondary winding with grounded star point is taken into consideration and a line-to-line fault is assumed downstream the cable distribution line.

Figure 6

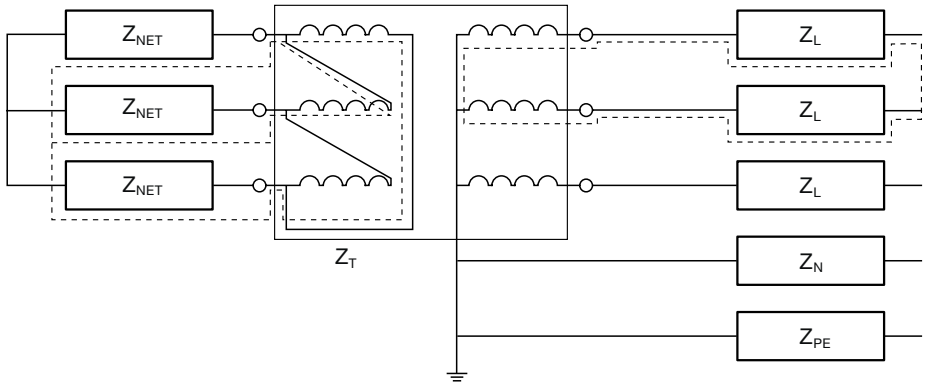

Applying the algebra of sequences:

$$I_{k2} = \frac{\sqrt{3} \cdot E_d}{(Z_d + Z_i)}$$

the impedances relevant to the positive and negative sequences under examination are:

$$Z_d = Z_i = Z_{NET} + Z_T + Z_L$$

considering that  $E_d = \frac{U_r}{\sqrt{3}}$ , the following is obtained:

$$I_{k2} = \frac{\sqrt{3} \cdot E_d}{(Z_d + Z_i)} = \frac{U_r}{2 \cdot (Z_{NET} + Z_T + Z_L)}$$

where:

$U_r$  is the rated voltage on the LV side

$Z_T$  is the impedance of the transformer

$Z_L$  is the impedance of the phase conductor

$Z_{NET}$  is the impedance of the upstream network.

By making reference to the previous example, it is possible to obtain Table 2 below, which gives the expressions for the short-circuit currents according to the different typologies of fault.

## 6 Calculation of short-circuit current

Table 2

Three-phase  
fault  
 $I_{k3}$

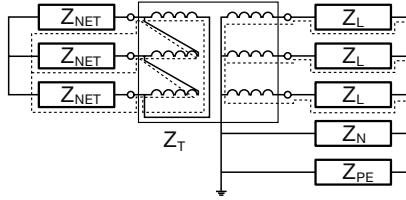

$$I_{k3} = \frac{U_r}{\sqrt{3} \cdot (Z_{NET} + Z_T + Z_L)}$$

Line-to-line  
fault  
 $I_{k2}$

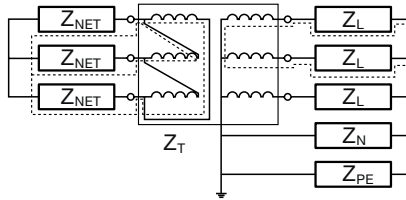

$$I_{k2} = \frac{U_r}{2 \cdot (Z_{NET} + Z_T + Z_L)}$$

Single-phase  
fault  
 $I_{k1}$  (line-to-neutral or  
line-to-PE)

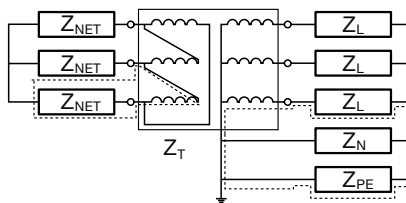

$$I_{k1} = \frac{U_r}{\sqrt{3} \cdot \left( \frac{2}{3} \cdot Z_{NET} + Z_T + Z_L + Z_{PE} \right)}$$

$$I_{k1} = \frac{U_r}{\sqrt{3} \cdot \left( \frac{2}{3} \cdot Z_{NET} + Z_T + Z_L + Z_N \right)}$$

Where:

$U_r$  is the rated voltage on the LV side

$Z_T$  is the impedance of the transformer

$Z_L$  is the impedance of the phase conductor

$Z_{NET}$  is the impedance of the upstream network

$Z_{PE}$  is the impedance of the protection conductor (PE)

$Z_N$  is the impedance of the neutral conductor

## 6 Calculation of short-circuit current

Table 3 below summarizes the relations for the fault currents, taking into account the upstream defined or infinite power network values and the distance of the fault from the transformer.

Table 3

	Upstream defined power network		Upstream infinite power network $Z_{NET} \rightarrow 0$	
	Far-from the transformer	Near the transformer $Z_L \rightarrow 0, Z_{PE} \text{ (o } Z_N) \rightarrow 0$	Far-from the transformer	Near the transformer $Z_L \rightarrow 0, Z_{PE} \text{ (o } Z_N) \rightarrow 0$
$I_{k3}$	$I_{k3} = \frac{U_r}{\sqrt{3} \cdot (Z_{NET} + Z_T + Z_L)}$	$I_{k3} = \frac{U_r}{\sqrt{3} \cdot (Z_{NET} + Z_T)}$	$I_{k3} = \frac{U_r}{\sqrt{3} \cdot (Z_T + Z_L)}$	$I_{k3} = \frac{U_r}{\sqrt{3} \cdot (Z_T)}$
$I_{k2}$	$I_{k2} = \frac{U_r}{2 \cdot (Z_{NET} + Z_T + Z_L)}$	$I_{k2} = \frac{U_r}{2 \cdot (Z_{NET} + Z_T)}$	$I_{k2} = \frac{U_r}{2 \cdot (Z_T + Z_L)}$	$I_{k2} = \frac{U_r}{2 \cdot (Z_T)}$
	$I_{k2} < I_{k3}$	$I_{k2} = 0.87 \cdot I_{k3}$	$I_{k2} = 0.87 \cdot I_{k3}$	$I_{k2} = 0.87 \cdot I_{k3}$
$I_{k1}$	$I_{k1} = \frac{U_r}{\sqrt{3} \cdot \left(\frac{2}{3} \cdot Z_{NET} + Z_T + Z_L + Z_{PE}\right)}$	$I_{k1} = \frac{U_r}{\sqrt{3} \cdot \left(\frac{2}{3} \cdot Z_{NET} + Z_T\right)}$	$I_{k1} = \frac{U_r}{\sqrt{3} \cdot (Z_T + Z_L + Z_{PE})}$	$I_{k1} = \frac{U_r}{\sqrt{3} \cdot (Z_T)}$
	$I_{k1} > I_{k3}$ if $Z_{NET} > 3 \cdot Z_{PE}$	$I_{k1} > I_{k3}$	$I_{k1} \approx I_{k3}$	$I_{k1} = I_{k3}$

---

## 6 Calculation of short-circuit current

---

### 6.6 Calculation of the peak value of the short-circuit current

The electrodynamical effects of the short-circuit currents are particularly dangerous for the bus ducts, but they can also damage cables.

The peak current is important also to evaluate the  $I_{cm}$  value of the circuit-breaker.

The  $I_{cm}$  value is also bound to the  $I_{cu}$  value, according to Table 16 of the Standard IEC 60947-1. With reference to the short-circuit current of the plant, it shall be  $I_{cm} > I_{kp}$ .

The peak current of a plant may be calculated by the following formula (see Std. IEC 60909-0):

$$I_{kp} = I_k'' \cdot \sqrt{2} \cdot \left( 1.02 + 0.98 \cdot e^{-\frac{3 \cdot R}{X}} \right)$$

where:

- $I_k''$  is the short-circuit current (rms value) at the initial instant of the short-circuit
- $R$  is the resistive component of the short-circuit impedance at the fault location
- $X$  is the reactive component of the short-circuit current at the fault location

When the power factor  $\cos\varphi_k$  is known, it is possible to write:

$$I_{kp} = I_k'' \cdot \sqrt{2} \cdot \left( 1.02 + 0.98 \cdot e^{-\frac{3}{\tan\varphi_k}} \right)$$



---

## 6 Calculation of short-circuit current

---

### 6.7 Considerations about UPS (Uninterruptible Power Supplies) contribution to short-circuit currents

In the following considerations particular attention is given to a double-conversion or UPS on-line, belonging to the category VFI (Voltage and Frequency Independent), for which the output voltage is independent of the mains voltage variations and frequency variations are controlled by this device within the standard limits prescribed by the Standards; this system is characterised by the following operating modalities:

- under normal operating conditions, in the presence of the network voltage, the load is fed by the network itself through the UPS;
- under emergency conditions (lack of network), power to the load is supplied by the battery and by the inverter ("island supply" with UPS disconnected from the mains);
- in case of temporary overcurrent required by the load (e.g. motor start-up), power supply to the load is guaranteed by the network through the static switch which excludes the UPS;
- in case of maintenance, for example due to a fault on the UPS, the load is fed by the network through a manual bypass switch, by temporarily giving up the availability of emergency power supply.

As regards the dimensioning of the protections on the supply side of the UPS, it is necessary to know the characteristics of the network voltage and of the short-circuit current; for the dimensioning of the protections on the load side, it is necessary to know the current values let through by the UPS. If power supply of the loads is provided directly from the network through manual bypass, also the circuit-breaker on the load side must have a breaking capacity (I<sub>cu</sub>) suitable for the short-circuit current of the supply-side network. Furthermore, if required, an evaluation of the protection co-ordination in relation to the operating conditions is necessary.

## 6 Calculation of short-circuit current

However, in order to choose the suitable protections, it is important to distinguish between two operating conditions for UPS:

### 1) UPS under normal operating conditions

a) Overload condition:

- if due to a possible fault on the battery, this condition affects only the circuit-breaker on the supply-side of the UPS (also likely the intervention of the protections inside the battery);
- if required by the load, this condition might not be supported by the UPS, which is bypassed by the static converter.

b) Short-circuit condition:

The short-circuit current is limited by the dimensioning of the thyristors of the bridge inverter. In the practice, UPS may supply a maximum short-circuit current equal to 150 to 200% of the rated value. In the event of a short-circuit, the inverter supplies the maximum current for a limited time (some hundreds of milliseconds) and then switches to the network, so that power to the load is supplied by the bypass circuit.

In this case, selectivity between the circuit-breaker on the supply side and the circuit-breaker on the load side is important in order to disconnect only the load affected by the fault.

The bypass circuit, which is also called static switch, and is formed by thyristors protected by extrarapid fuses, can feed the load with a higher current than the inverter; this current results to be limited by the dimensioning of the thyristors used, by the power installed and by the provided protections.

The thyristors of the bypass circuit are usually dimensioned to withstand the following overload conditions:

125%	for 600 seconds
150%	for 60 seconds
700%	for 600 milliseconds
1000%	for 100 milliseconds

Generally, more detailed data can be obtained from the technical information given by the manufacturer.

## 6 Calculation of short-circuit current

### 2) UPS under emergency operating conditions

#### a) Overload condition:

this condition, involving the load-side circuit-breaker only, is supported by the battery with inverter, which presents an overload condition usually calculable in the following orders of magnitude:

- 1.15 x  $I_n$  for indefinite time
- 1.25 x  $I_n$  for 600 seconds
- 1.5 x  $I_n$  for 60 seconds
- 2 x  $I_n$  for 1 seconds

Generally, more detailed data can be obtained from the technical information given by the manufacturer.

#### b) Short-circuit condition:

the maximum current towards the load is limited by the inverter circuit only (with a value from 150 to 200% of the nominal value). The inverter feeds the short-circuit for a certain period of time, usually limited to some milliseconds, after which the UPS unit disconnects the load leaving it without supply. In this operating modality, it is necessary to obtain selectivity between the circuit-breaker on the load side and the inverter, which is quite difficult due to the reduced tripping times of the protection device of the inverter.

Figure 7

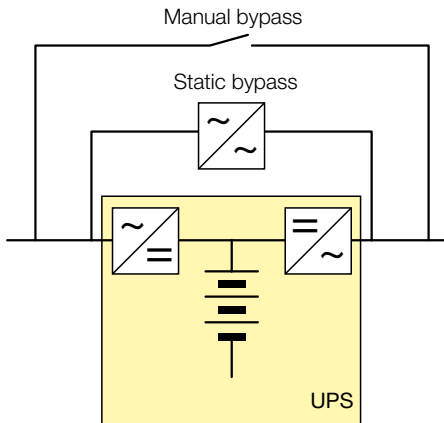

UPS on-line with static switch

Figure 8

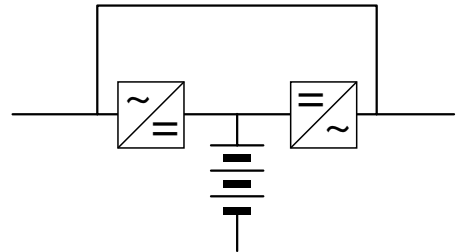

UPS off-line: loads directly fed by the network

## Annex A: Calculation of load current $I_b$

### Generic loads

The formula for the calculation of the load current of a generic load is:

$$I_b = \frac{P}{k \cdot U_r \cdot \cos\varphi}$$

where:

- P is the active power [W];
- k is a coefficient which has the value:
  - 1 for single-phase systems or for direct current systems;
  - $\sqrt{3}$  for three-phase systems;
- $U_r$  is the rated voltage [V] (for three-phase systems it is the line voltage, for single-phase systems it is the phase voltage);
- $\cos\varphi$  is the power factor.

Table 1 allows the load current to be determined for some power values according to the rated voltage. The table has been calculated considering  $\cos\varphi$  to be equal to 0.9; for different power factors, the value from Table 1 must be multiplied by the coefficient given in Table 2 corresponding to the actual value of the power factor ( $\cos\varphi_{act}$ ).

**Table 1: Load current for three-phase systems with  $\cos\varphi = 0.9$**

P [kW]	$U_r$ [V]						
	230	400	415	440	500	600	690
	$I_b$ [A]						
0.03	0.08	0.05	0.05	0.04	0.04	0.03	0.03
0.04	0.11	0.06	0.06	0.06	0.05	0.04	0.04
0.06	0.17	0.10	0.09	0.09	0.08	0.06	0.06
0.1	0.28	0.16	0.15	0.15	0.13	0.11	0.09
0.2	0.56	0.32	0.31	0.29	0.26	0.21	0.19
0.5	1.39	0.80	0.77	0.73	0.64	0.53	0.46
1	2.79	1.60	1.55	1.46	1.28	1.07	0.93
2	5.58	3.21	3.09	2.92	2.57	2.14	1.86
5	13.95	8.02	7.73	7.29	6.42	5.35	4.65
10	27.89	16.04	15.46	14.58	12.83	10.69	9.30
20	55.78	32.08	30.92	29.16	25.66	21.38	18.59
30	83.67	48.11	46.37	43.74	38.49	32.08	27.89
40	111.57	64.15	61.83	58.32	51.32	42.77	37.19
50	139.46	80.19	77.29	72.90	64.15	53.46	46.49
60	167.35	96.23	92.75	87.48	76.98	64.15	55.78
70	195.24	112.26	108.20	102.06	89.81	74.84	65.08
80	223.13	128.30	123.66	116.64	102.64	85.53	74.38
90	251.02	144.34	139.12	131.22	115.47	96.23	83.67
100	278.91	160.38	154.58	145.80	128.30	106.92	92.97
110	306.80	176.41	170.04	160.38	141.13	117.61	102.27
120	334.70	192.45	185.49	174.95	153.96	128.30	111.57
130	362.59	208.49	200.95	189.53	166.79	138.99	120.86
140	390.48	224.53	216.41	204.11	179.62	149.68	130.16
150	418.37	240.56	231.87	218.69	192.45	160.38	139.46
200	557.83	320.75	309.16	291.59	256.60	213.83	185.94

## Annex A: Calculation of load current $I_b$

P [kW]	$U_r$ [V]						
	230	400	415	440	500	600	690
	$I_b$ [A]						
250	697.28	400.94	386.45	364.49	320.75	267.29	232.43
300	836.74	481.13	463.74	437.39	384.90	320.75	278.91
350	976.20	561.31	541.02	510.28	449.05	374.21	325.40
400	1115.65	641.50	618.31	583.18	513.20	427.67	371.88
450	1255.11	721.69	695.60	656.08	577.35	481.13	418.37
500	1394.57	801.88	772.89	728.98	641.50	534.58	464.86
550	1534.02	882.06	850.18	801.88	705.65	588.04	511.34
600	1673.48	962.25	927.47	874.77	769.80	641.50	557.83
650	1812.94	1042.44	1004.76	947.67	833.95	694.96	604.31
700	1952.39	1122.63	1082.05	1020.57	898.10	748.42	650.80
750	2091.85	1202.81	1159.34	1093.47	962.25	801.88	697.28
800	2231.31	1283.00	1236.63	1166.36	1026.40	855.33	743.77
850	2370.76	1363.19	1313.92	1239.26	1090.55	908.79	790.25
900	2510.22	1443.38	1391.21	1312.16	1154.70	962.25	836.74
950	2649.68	1523.56	1468.49	1385.06	1218.85	1015.71	883.23
1000	2789.13	1603.75	1545.78	1457.96	1283.00	1069.17	929.71

**Table 2: Correction factors for load current with  $\cos\varphi$  other than 0.9**

$\cos\varphi_{act}$	1	0.95	0.9	0.85	0.8	0.75	0.7
$k_{\cos\varphi}$	0.9	0.947	1	1.059	1.125	1.2	1.286

For  $\cos\varphi_{act}$  values not present in the table,  $k_{\cos\varphi} = \frac{0.9}{\cos\varphi_{act}}$

Table 3 allows the load current to be determined for some power values according to the rated voltage. The table has been calculated considering  $\cos\varphi$  to be equal to 1; for different power factors, the value from Table 3 must be multiplied by the coefficient given in Table 4 corresponding to the actual value of the power factor ( $\cos\varphi_{act}$ ).

**Table 3: Load current for single-phase systems with  $\cos\varphi = 1$  or dc systems**

P [kW]	$U_r$ [V]						
	230	400	415	440	500	600	690
	$I_b$ [A]						
0.03	0.13	0.08	0.07	0.07	0.06	0.05	0.04
0.04	0.17	0.10	0.10	0.09	0.08	0.07	0.06
0.06	0.26	0.15	0.14	0.14	0.12	0.10	0.09
0.1	0.43	0.25	0.24	0.23	0.20	0.17	0.14
0.2	0.87	0.50	0.48	0.45	0.40	0.33	0.29
0.5	2.17	1.25	1.20	1.14	1.00	0.83	0.72
1	4.35	2.50	2.41	2.27	2.00	1.67	1.45
2	8.70	5.00	4.82	4.55	4.00	3.33	2.90
5	21.74	12.50	12.05	11.36	10.00	8.33	7.25
10	43.48	25.00	24.10	22.73	20.00	16.67	14.49
20	86.96	50.00	48.19	45.45	40.00	33.33	28.99

## Annex A: Calculation of load current $I_b$

P [kW]	$U_L$ [V]						
	230	400	415	440	500	600	690
	$I_b$ [A]						
30	130.43	75.00	72.29	68.18	60.00	50.00	43.48
40	173.91	100.00	96.39	90.91	80.00	66.67	57.97
50	217.39	125.00	120.48	113.64	100.00	83.33	72.46
60	260.87	150.00	144.58	136.36	120.00	100.00	86.96
70	304.35	175.00	168.67	159.09	140.00	116.67	101.45
80	347.83	200.00	192.77	181.82	160.00	133.33	115.94
90	391.30	225.00	216.87	204.55	180.00	150.00	130.43
100	434.78	250.00	240.96	227.27	200.00	166.67	144.93
110	478.26	275.00	265.06	250.00	220.00	183.33	159.42
120	521.74	300.00	289.16	272.73	240.00	200.00	173.91
130	565.22	325.00	313.25	295.45	260.00	216.67	188.41
140	608.70	350.00	337.35	318.18	280.00	233.33	202.90
150	652.17	375.00	361.45	340.91	300.00	250.00	217.39
200	869.57	500.00	481.93	454.55	400.00	333.33	289.86
250	1086.96	625.00	602.41	588.18	500.00	416.67	362.32
300	1304.35	750.00	722.89	681.82	600.00	500.00	434.78
350	1521.74	875.00	843.37	795.45	700.00	583.33	507.25
400	1739.13	1000.00	963.86	909.09	800.00	666.67	579.71
450	1956.52	1125.00	1084.34	1022.73	900.00	750.00	652.17
500	2173.91	1250.00	1204.82	1136.36	1000.00	833.33	724.64
550	2391.30	1375.00	1325.30	1250.00	1100.00	916.67	797.10
600	2608.70	1500.00	1445.78	1363.64	1200.00	1000.00	869.57
650	2826.09	1625.00	1566.27	1477.27	1300.00	1083.33	942.03
700	3043.48	1750.00	1686.75	1590.91	1400.00	1166.67	1014.49
750	3260.87	1875.00	1807.23	1704.55	1500.00	1250.00	1086.96
800	3478.26	2000.00	1927.71	1818.18	1600.00	1333.33	1159.42
850	3695.65	2125.00	2048.19	1931.82	1700.00	1416.67	1231.88
900	3913.04	2250.00	2168.67	2045.45	1800.00	1500.00	1304.35
950	4130.43	2375.00	2289.16	2159.09	1900.00	1583.33	1376.81
1000	4347.83	2500.00	2409.64	2272.73	2000.00	1666.67	1449.28

**Table 4: Correction factors for load current with  $\cos\varphi$  other than 1**

$\cos\varphi_{act}$	1	0.95	0.9	0.85	0.8	0.75	0.7
$k_{\cos\varphi}$	1	1.053	1.111	1.176	1.25	1.333	1.429

\* For  $\cos\varphi_{act}$  values not present in the table,  $k_{\cos\varphi} = \frac{1}{\cos\varphi_{act}}$

### Lighting circuits

The current absorbed by the lighting system may be deduced from the lighting equipment catalogue, or approximately calculated using the following formula:

$$I_b = \frac{P_L n_L k_B k_N}{U_{rL} \cos\varphi}$$

where:

- $P_L$  is the power of the lamp [W];
- $n_L$  is the number of lamps per phase;
- $k_B$  is a coefficient which has the value:
  - 1 for lamps which do not need any auxiliary starter;
  - 1.25 for lamps which need auxiliary starters;
- $k_N$  is a coefficient which has the value:
  - 1 for star-connected lamps;
  - $\sqrt{3}$  for delta-connected lamps;
- $U_{rL}$  is the rated voltage of the lamps;
- $\cos\varphi$  is the power factor of the lamps which has the value:
  - 0.4 for lamps without compensation;
  - 0.9 for lamps with compensation.

## Annex A: Calculation of load current $I_L$ Motors

Table 5 gives the approximate values of the load current for some three-phase squirrel-cage motors, 1500 rpm at 50 Hz, according to the rated voltage.

Note: these values are given for information only, and may vary according to the motor manufacturer and depending on the number of poles

**Table 5: Motor load current**

<b>Motor power</b>		<b>Rated current of the motor at:</b>								
<b>[kW]</b>	<b>PS = hp</b>	<b>220-230 V</b>	<b>240 V</b>	<b>380-400 V</b>	<b>415 V</b>	<b>440 V</b>	<b>500 V</b>	<b>600 V</b>	<b>660-690 V</b>	
		<b>[A]</b>	<b>[A]</b>	<b>[A]</b>	<b>[A]</b>	<b>[A]</b>	<b>[A]</b>	<b>[A]</b>	<b>[A]</b>	
0.06	1/12	0.38	0.35	0.22	0.20	0.19	0.16	0.12	-	
0.09	1/8	0.55	0.50	0.33	0.30	0.28	0.24	0.21	-	
0.12	1/6	0.76	0.68	0.42	0.40	0.37	0.33	0.27	-	
0.18	1/4	1.1	1	0.64	0.60	0.55	0.46	0.40	-	
0.25	1/3	1.4	1.38	0.88	0.85	0.76	0.59	0.56	-	
0.37	1/2	2.1	1.93	1.22	1.15	1.06	0.85	0.77	0.7	
0.55	3/4	2.7	2.3	1.5	1.40	1.25	1.20	1.02	0.9	
0.75	1	3.3	3.1	2	2	1.67	1.48	1.22	1.1	
1.1	1.5	4.9	4.1	2.6	2.5	2.26	2.1	1.66	1.5	
1.5	2	6.2	5.6	3.5	3.5	3.03	2.6	2.22	2	
2.2	3	8.7	7.9	5	5	4.31	3.8	3.16	2.9	
2.5	3.4	9.8	8.9	5.7	5.5	4.9	4.3	3.59	3.3	
3	4	11.6	10.6	6.6	6.5	5.8	5.1	4.25	3.5	
3.7	5	14.2	13	8.2	7.5	7.1	6.2	5.2	4.4	
4	5.5	15.3	14	8.5	8.4	7.6	6.5	5.6	4.9	
5	6.8	18.9	17.2	10.5	10	9.4	8.1	6.9	6	
5.5	7.5	20.6	18.9	11.5	11	10.3	8.9	7.5	6.7	
6.5	8.8	23.7	21.8	13.8	12.5	12	10.4	8.7	8.1	
7.5	10	27.4	24.8	15.5	14	13.5	11.9	9.9	9	
8	11	28.8	26.4	16.7	15.4	14.4	12.7	10.6	9.7	
9	12.5	32	29.3	18.3	17	15.8	13.9	11.6	10.6	
11	15	39.2	35.3	22	21	19.3	16.7	14.1	13	
12.5	17	43.8	40.2	25	23	21.9	19	16.1	15	
15	20	52.6	48.2	30	28	26.3	22.5	19.3	17.5	
18.5	25	64.9	58.7	37	35	32	28.5	23.5	21	
20	27	69.3	63.4	40	37	34.6	30.6	25.4	23	
22	30	75.2	68	44	40	37.1	33	27.2	25	
25	34	84.4	77.2	50	47	42.1	38	30.9	28	
30	40	101	92.7	60	55	50.1	44	37.1	33	
37	50	124	114	72	66	61.9	54	45.4	42	
40	54	134	123	79	72	67	60	49.1	44	
45	60	150	136	85	80	73.9	64.5	54.2	49	
51	70	168	154	97	90	83.8	73.7	61.4	56	
55	75	181	166	105	96	90.3	79	66.2	60	
59	80	194	178	112	105	96.9	85.3	71.1	66	
75	100	245	226	140	135	123	106	90.3	82	
80	110	260	241	147	138	131	112	96.3	86	
90	125	292	268	170	165	146	128	107	98	
100	136	325	297	188	182	162	143	119	107	
110	150	358	327	205	200	178	156	131	118	
129	175	420	384	242	230	209	184	153	135	
132	180	425	393	245	242	214	186	157	140	
140	190	449	416	260	250	227	200	167	145	
147	200	472	432	273	260	236	207	173	152	
160	220	502	471	295	280	256	220	188	170	
180	245	578	530	333	320	289	254	212	190	
184	250	590	541	340	325	295	259	217	200	
200	270	626	589	370	340	321	278	235	215	
220	300	700	647	408	385	353	310	260	235	
250	340	803	736	460	425	401	353	295	268	
257	350	826	756	475	450	412	363	302	280	
295	400	948	868	546	500	473	416	348	320	
315	430	990	927	580	535	505	445	370	337	
355	480	1080	1010	636	580	549	483	405	366	
400	545	1250	1130	710	650	611	538	450	410	
450	610	1410	1270	800	740	688	608	508	460	
475	645	1490	1340	850	780	730	645	540	485	
500	680	1570	1420	890	830	770	680	565	510	
560	760	1750	1580	1000	920	860	760	630	570	
600	810	-	-	1080	990	920	810	680	610	
670	910	-	-	1200	1100	1030	910	760	680	

---

## Annex B: Harmonics

### What are they?

The harmonics allow to represent any periodic waveform; in fact, according to Fourier's theorem, any periodic function of a period  $T$  may be represented as a summation of:

- a sinusoid with the same period  $T$ ;
- some sinusoids with the same frequency as whole multiples of the fundamental;
- a possible continuous component, if the function has an average value not null in the period.

The harmonic with frequency corresponding to the period of the original waveform is called fundamental and the harmonic with frequency equal to "n" times that of the fundamental is called harmonic component of order "n".

A perfectly sinusoidal waveform complying with Fourier's theorem does not present harmonic components of order different from the fundamental one. Therefore, it is understandable how there are no harmonics in an electrical system when the waveforms of current and voltage are sinusoidal. On the contrary, the presence of harmonics in an electrical system is an index of the distortion of the voltage or current waveform and this implies such a distribution of the electric power that malfunctioning of equipment and protective devices can be caused.

To summarize: the harmonics are nothing less than the components of a distorted waveform and their use allows us to analyse any periodic nonsinusoidal waveform through different sinusoidal waveform components.

Figure 1 below shows a graphical representation of this concept.

Figure 1

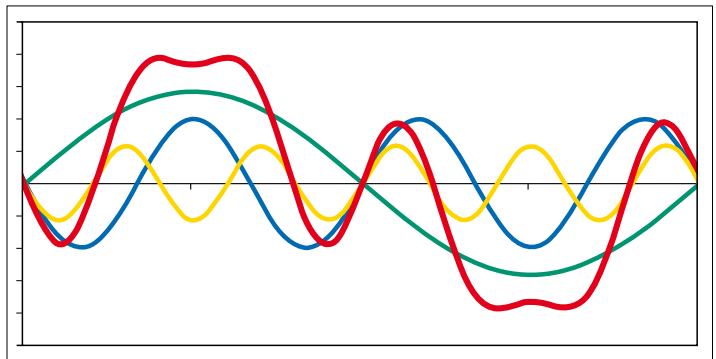

Caption:

- nonsinusoidal waveform
- first harmonic (fundamental)
- third harmonic
- fifth harmonic



## Annex B: Harmonics

### How harmonics are generated?

Harmonics are generated by nonlinear loads. When we apply a sinusoidal voltage to a load of this type, we shall obtain a current with non-sinusoidal waveform. The diagram of Figure 2 illustrates an example of nonsinusoidal current waveform due to a nonlinear load:

Figure 2

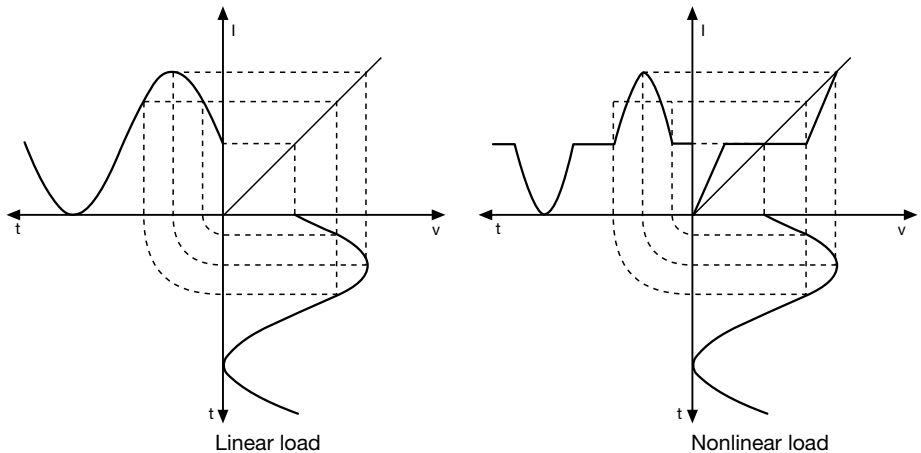

As already said, this nonsinusoidal waveform can be deconstructed into harmonics. If the network impedances are very low, the voltage distortion resulting from a harmonic current is low too and rarely it is above the pollution level already present in the network. As a consequence, the voltage can remain practically sinusoidal also in the presence of current harmonics.

To function properly, many electronic devices need a definite current waveform and thus they have to 'cut' the sinusoidal waveform so as to change its rms value or to get a direct current from an alternate value; in these cases the current on the line has a nonsinusoidal curve.

The main equipment generating harmonics are:

- personal computer
- fluorescent lamps
- static converters
- continuity groups
- variable speed drives
- welders.

In general, waveform distortion is due to the presence, inside of these equipment, of bridge rectifiers, whose semiconductor devices carry the current only for a fraction of the whole period, thus originating discontinuous curves with the consequent introduction of numerous harmonics.

## Annex B: Harmonics

Also transformers can be cause of harmonic pollution; in fact, by applying a perfectly sinusoidal voltage to a transformer, it results into a sinusoidal magnetizing flux, but, due to the phenomenon of the magnetic saturation of iron, the magnetizing current shall not be sinusoidal. Figure 3 shows a graphic representation of this phenomenon:

Figure 3

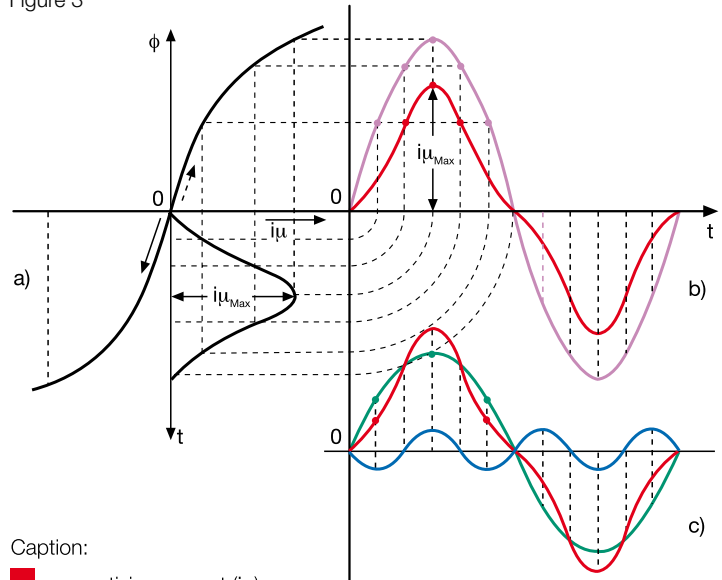

Caption:

- magnetizing current ( $i_{\mu}$ )
- first harmonic current (fundamental)
- third harmonic current
- flux variable in time:  $\phi = \phi_{Max} \sin \omega t$

The resultant waveform of the magnetizing current contains numerous harmonics, the greatest of which is the third one. However, it should be noted that the magnetizing current is generally a little percentage of the rated current of the transformer and the distortion effect becomes more and more negligible the most loaded the transformer results to be.

### Effects

The main problems caused by harmonic currents are:

- 1) overloading of neutrals
- 2) increase of losses in the transformers
- 3) increase of skin effect.

The main effects of the harmonics voltages are:

- 4) voltage distortion
- 5) disturbances in the torque of induction motors

## Annex B: Harmonics

### 1) Overloading of neutrals

In a three phase symmetric and balanced system with neutral, the waveforms between the phases are shifted by a  $120^\circ$  phase angle so that, when the phases are equally loaded, the current in the neutral is zero. The presence of unbalanced loads (phase-to-phase, phase-to-neutral etc.) allows the flowing of an unbalanced current in the neutral.

Figure 4

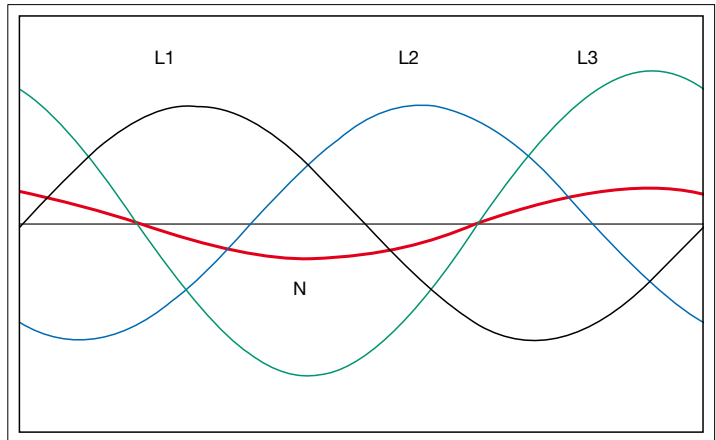

Figure 4 shows an unbalanced system of currents (phase 3 with a load 30% higher than the other two phases), and the current resultant in the neutral is highlighted in red. Under these circumstances, the Standards allow the neutral conductor to be dimensioned with a cross section smaller than the phase conductors. In the presence of distortion loads it is necessary to evaluate correctly the effects of harmonics.

In fact, although the currents at fundamental frequency in the three phases cancel each other out, the components of the third harmonic, having a period equal to a third of the fundamental, that is equal to the phase shift between the phases (see Figure 5), are reciprocally in phase and consequently they sum in the neutral conductor adding themselves to the normal unbalance currents.

The same is true also for the harmonics multiple of three (even and odd, although actually the odd ones are more common).

## Annex B: Harmonics

Figure 5

Phase 1:  
fundamental harmonic and 3<sup>rd</sup> harmonic

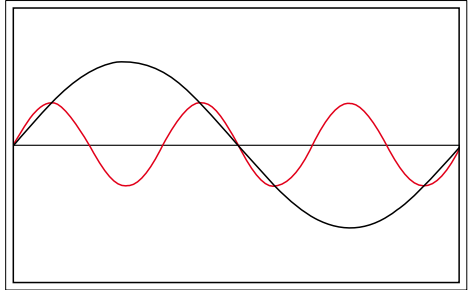

Phase 2:  
fundamental harmonic and 3<sup>rd</sup> harmonic

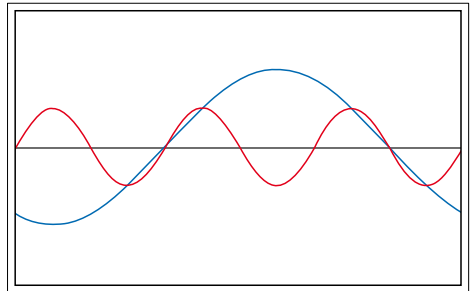

Phase 3:  
fundamental harmonic and 3<sup>rd</sup> harmonic

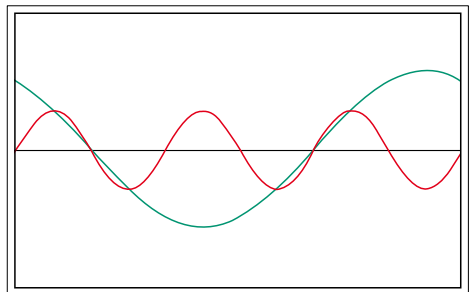

Resultant of the currents of the three phases

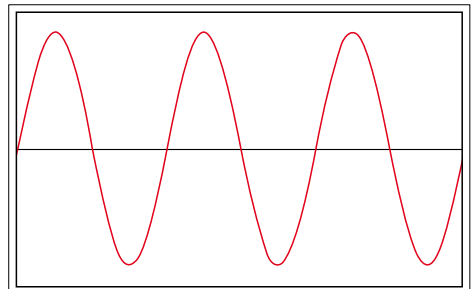

## Annex B: Harmonics

### 2) Increase of losses in the transformers

The effects of harmonics inside the transformers involve mainly three aspects:

- a) increase of iron losses (or no-load losses)
- b) increase of copper losses
- c) presence of harmonics circulating in the windings

a) The iron losses are due to the hysteresis phenomenon and to the losses caused by eddy currents; the losses due to hysteresis are proportional to the frequency, whereas the losses due to eddy currents depend on the square of the frequency.

b) The copper losses correspond to the power dissipated by Joule effect in the transformer windings. As the frequency rises (starting from 350 Hz) the current tends to thicken on the surface of the conductors (skin effect); under these circumstances, the conductors offer a smaller cross section to the current flow, since the losses by Joule effect increase.

These two first aspects affect the overheating which sometimes causes a derating of the transformer.

c) The third aspect is relevant to the effects of the triple-N harmonics (homopolar harmonics) on the transformer windings. In case of delta windings, the harmonics flow through the windings and do not propagate upstream towards the network since they are all in phase; the delta windings therefore represent a barrier for triple-N harmonics, but it is necessary to pay particular attention to this type of harmonic components for a correct dimensioning of the transformer.

### 3) Increase of skin effect

When the frequency rises, the current tends to flow on the outer surface of a conductor. This phenomenon is known as skin effect and is more pronounced at high frequencies. At 50 Hz power supply frequency, skin effect is negligible, but above 350 Hz, which corresponds to the 7th harmonic, the cross section for the current flow reduces, thus increasing the resistance and causing additional losses and heating.

In the presence of high-order harmonics, it is necessary to take skin effect into account, because it affects the life of cables. In order to overcome this problem, it is possible to use multiple conductor cables or busbar systems formed by more elementary isolated conductors.

### 4) Voltage distortion

The distorted load current drawn by the nonlinear load causes a distorted voltage drop in the cable impedance. The resultant distorted voltage waveform is applied to all other loads connected to the same circuit, causing harmonic currents to flow in them, even if they are linear loads.

The solution consists in separating the circuits which supply harmonic generating loads from those supplying loads sensitive to harmonics.

### 5) Disturbances in the torque of induction motors

Harmonic voltage distortion causes increased eddy current losses in the motors, in the same way as seen for transformers. The additional losses are due to the generation of harmonic fields in the stator, each of which is trying to rotate the motor at a different speed, both forwards (1<sup>st</sup>, 4<sup>th</sup>, 7<sup>th</sup>, ...) as well as backwards (2<sup>nd</sup>, 5<sup>th</sup>, 8<sup>th</sup>, ...). High frequency currents induced in the rotor further increase losses.

## Annex B: Harmonics

### Main formulas

The definitions of the main quantities typically used in a harmonic analysis are given hereunder.

### Frequency spectrum

The frequency spectrum is the classic representation of the harmonic content of a waveform and consists of a histogram reporting the value of each harmonic as a percentage of the fundamental component. For example, for the following waveform:

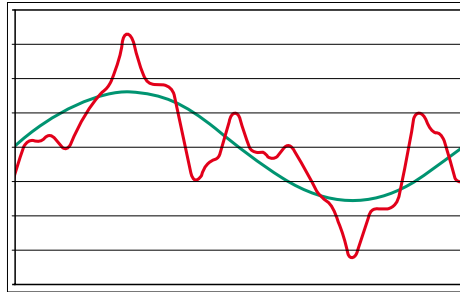

the frequency spectrum is:

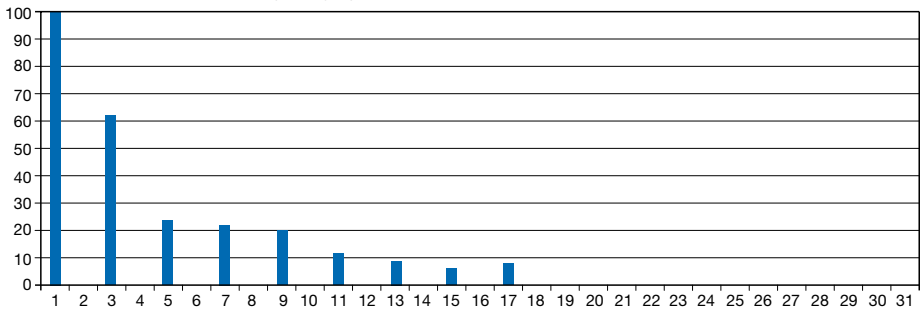

The frequency spectrum provides the size of the existing harmonic components.

### Peak factor

The peak factor is defined as the ratio between the peak value and the rms value of the waveform:

$$k = \frac{I_p}{I_{rms}}$$

in case of perfectly sinusoidal waveforms, it is worth  $\sqrt{2}$ , but in the presence of harmonics it can reach higher values.

High peak factors may cause the unwanted tripping of the protection devices.

### Rms value

The rms value of a periodical waveform  $e(t)$  is defined as:

$$E_{rms} = \sqrt{\frac{1}{T} \int_0^T e^2(t) dt}$$

where  $T$  is the period.

## Annex B: Harmonics

If the rms values of the harmonic components are known, the total rms value can be easily calculated by the following formula:

$$E_{\text{rms}} = \sqrt{\sum_{n=1}^{\infty} E_n^2}$$

### Total harmonic distortion THD

The total harmonic distortion is defined as:

$$\text{THD}_i = \frac{\sqrt{\sum_{n=2}^{\infty} I_n^2}}{I_1} \quad \text{THD in current}$$

$$\text{THD}_u = \frac{\sqrt{\sum_{n=2}^{\infty} U_n^2}}{U_1} \quad \text{THD in voltage}$$

The harmonic distortion ratio is a very important parameter, which gives information about the harmonic content of the voltage and current waveforms and about the necessary measures to be taken should these values be high. For  $\text{THD}_i < 10\%$  and  $\text{THD}_u < 5\%$ , the harmonic content is considered negligible and such as not to require any provisions.

### Standard references for circuit-breakers

#### *IEC 60947 Low-voltage switchgear and controlgear*

Annex F of the Standard IEC 60947-2 (third edition 2003) gives information about the tests to check the immunity of the overcurrent releases against harmonics.

In particular, it describes the waveform of the test current, at which, in correspondence with determinate values of injected current, the release shall have a behaviour complying with the prescriptions of this Standard.

Hereunder, the characteristics of the waveform of the test current are reported, which shall be formed, in alternative, as follows:

1) by the fundamental component and by a 3rd harmonic variable between 72% and 88% of the fundamental, with peak factor equal to 2 or by a 5th harmonic variable between 45% and 55% of the fundamental, with peak factor equal to 1.9

or

2) by the fundamental component and by a 3rd harmonic higher than 60% of the fundamental, by a 5th harmonic higher than 14% of the fundamental and by a 7th harmonic higher than 7% of the fundamental. This test current shall have a peak factor  $\geq 2.1$  and shall flow for a given time  $\leq 42\%$  of the period for each half period.

## Annex C: Calculation of the coefficient k for the cables ( $k^2S^2$ )

By using the formula (1), it is possible to determine the conductor minimum section S, in the hypothesis that the generic conductor is submitted to an adiabatic heating from a known initial temperature up to a specific final temperature (applicable if the fault is removed in less than 5 s):

$$S = \frac{\sqrt{I^2 t}}{k} \quad (1)$$

where:

- S is the cross section [ $\text{mm}^2$ ];
- I is the value (r.m.s) of prospective fault current for a fault of negligible impedance, which can flow through the protective device [A];
- t is the operating time of the protective device for automatic disconnection [s];

k can be evaluated using the tables 2+7 or calculated according to the formula (2):

$$k = \sqrt{\frac{Q_c (B+20)}{\rho_{20}} \ln \left( 1 + \frac{\theta_f - \theta_i}{B + \theta_i} \right)} \quad (2)$$

where:

- $Q_c$  is the volumetric heat capacity of conductor material [ $\text{J}/^\circ\text{Cmm}^3$ ] at  $20^\circ\text{C}$ ;
- B is the reciprocal of temperature coefficient of resistivity at  $0^\circ\text{C}$  for the conductor [ $^\circ\text{C}$ ];
- $\rho_{20}$  is the electrical resistivity of conductor material at  $20^\circ\text{C}$  [ $\Omega\text{mm}$ ];
- $\theta_i$  initial temperature of conductor [ $^\circ\text{C}$ ];
- $\theta_f$  final temperature of conductor [ $^\circ\text{C}$ ].

Table 1 shows the values of the parameters described above.

**Table 1: Value of parameters for different materials**

Material	B [ $^\circ\text{C}$ ]	$Q_c$ [ $\text{J}/^\circ\text{Cmm}^3$ ]	$\rho_{20}$ [ $\Omega\text{mm}$ ]	$\sqrt{\frac{Q_c (B+20)}{\rho_{20}}}$
Copper	234.5	$3.45 \cdot 10^{-3}$	$17.241 \cdot 10^{-6}$	226
Aluminium	228	$2.5 \cdot 10^{-3}$	$28.264 \cdot 10^{-6}$	148
Lead	230	$1.45 \cdot 10^{-3}$	$214 \cdot 10^{-6}$	41
Steel	202	$3.8 \cdot 10^{-3}$	$138 \cdot 10^{-6}$	78



## Annex C: Calculation of the coefficient $k$ for the cables ( $k^2S^2$ )

**Table 2: Values of  $k$  for phase conductor**

	Conductor insulation					
	PVC ≤ 300 mm <sup>2</sup>	PVC ≤ 300 mm <sup>2</sup>	EPR XLPE	Rubber 60 °C	Mineral PVC	Bare
Initial temperature °C	70	70	90	60	70	105
Final temperature °C	160	140	250	200	160	250
Material of conductor:						
<i>copper</i>	115	103	143	141	115	135/115 <sup>a</sup>
<i>aluminium</i>	76	68	94	93	-	-
<i>tin-soldered joints in copper conductors</i>	115	-	-	-	-	-

<sup>a</sup> This value shall be used for bare cables exposed to touch.

**Table 3: Values of  $k$  for insulated protective conductors not incorporated in cables and not bunched with other cables**

Conductor insulation	Temperature °C <sup>b</sup>		Material of conductor		
	Initial	Final	Copper	Aluminium Value for $k$	Steel
70 °C PVC	30	160/140 <sup>a</sup>	143/133 <sup>a</sup>	95/88 <sup>a</sup>	52/49 <sup>a</sup>
90 °C PVC	30	160/140 <sup>a</sup>	143/133 <sup>a</sup>	95/88 <sup>a</sup>	52/49 <sup>a</sup>
90 °C thermosetting	30	250	176	116	64
60 °C rubber	30	200	159	105	58
85 °C rubber	30	220	166	110	60
Silicone rubber	30	350	201	133	73

<sup>a</sup> The lower value applies to PVC insulated conductors of cross section greater than 300 mm<sup>2</sup>.

<sup>b</sup> Temperature limits for various types of insulation are given in IEC 60724.

## Annex C: Calculation of the coefficient $k$ for the cables ( $k^2S^2$ )

**Table 4: Values of  $k$  for bare protective conductors in contact with cable covering but not bunched with other cables**

Cable covering	Temperature °C <sup>a</sup>		Material of conductor		
	Initial	Final	Copper	Aluminium Value for $k$	Steel
PVC	30	200	159	105	58
Polyethylene	30	150	138	91	50
CSP	30	220	166	110	60

<sup>a</sup> Temperature limits for various types of insulation are given in IEC 60724.

**Table 5: Values of  $k$  for protective conductors as a core incorporated in a cable or bunched with other cables or insulated conductors**

Conductor insulation	Temperature °C <sup>b</sup>		Material of conductor		
	Initial	Final	Copper	Aluminium Value for $k$	Steel
70 °C PVC	70	160/140 <sup>a</sup>	115/103 <sup>a</sup>	76/68 <sup>a</sup>	42/37 <sup>a</sup>
90 °C PVC	90	160/140 <sup>a</sup>	100/86 <sup>a</sup>	66/57 <sup>a</sup>	36/31 <sup>a</sup>
90 °C thermosetting	90	250	143	94	52
60 °C rubber	60	200	141	93	51
85 °C rubber	85	220	134	89	48
Silicone rubber	180	350	132	87	47

<sup>a</sup> The lower value applies to PVC insulated conductors of cross section greater than 300 mm<sup>2</sup>.

<sup>b</sup> Temperature limits for various types of insulation are given in IEC 60724.

## Annex C: Calculation of the coefficient $k$ for the cables ( $k^2S^2$ )

**Table 6: Values of  $k$  for protective conductors as a metallic layer of a cable e.g. armour, metallic sheath, concentric conductor, etc.**

Conductor insulation	Temperature °C		Material of conductor			
	Initial	Final	Copper	Aluminium	Lead	Steel
70 °C PVC	60	200	141	93	26	51
90 °C PVC	80	200	128	85	23	46
90 °C thermosetting	80	200	128	85	23	46
60 °C rubber	55	200	144	95	26	52
85 °C rubber	75	220	140	93	26	51
Mineral PVC covered <sup>a</sup>	70	200	135	-	-	-
Mineral bare sheath	105	250	135	-	-	-

<sup>a</sup> This value shall also be used for bare conductors exposed to touch or in contact with combustible material.

**Table 7: Value of  $k$  for bare conductors where there is no risk of damage to any neighbouring material by the temperature indicated**

Conductor insulation	Initial temperature °C	Material of conductor					
		Copper		Aluminium		Steel	
		Maximum temperature °C	k value	Maximum temperature °C	k value	Maximum temperature °C	k value
Visible and in restricted area	30	228	500	125	300	82	500
Normal conditions	30	159	200	105	200	58	200
Fire risk	30	138	150	91	150	50	150

## Annex D: Main physical quantities and electrotechnical formulas

### The International System of Units (SI)

#### SI Base Units

Quantity	Symbol	Unit name
Length	m	metre
Mass	kg	kilogram
Time	s	Second
Electric Current	A	ampere
Thermodynamic Temperature	K	kelvin
Amount of Substance	mol	mole
Luminous Intensity	cd	candela

#### Metric Prefixes for Multiples and Sub-multiples of Units

Decimal power	Prefix	Symbol	Decimal power	Prefix	Symbol
$10^{24}$	yotta	Y	$10^{-1}$	deci	d
$10^{21}$	zetta	Z	$10^{-2}$	centi	c
$10^{18}$	exa	E	$10^{-3}$	milli	m
$10^{15}$	peta	P	$10^{-6}$	mikro	$\mu$
$10^{12}$	tera	T	$10^{-9}$	nano	n
$10^9$	giga	G	$10^{-12}$	pico	p
$10^6$	mega	M	$10^{-15}$	femto	f
$10^3$	kilo	k	$10^{-18}$	atto	a
$10^2$	etto	h	$10^{-21}$	zepto	z
10	deca	da	$10^{-24}$	yocto	y

# Annex D: Main physical quantities and electrotechnical formulas

## Main quantities and SI units

Quantity Symbol	Name	SI unit Symbol	Name	Other units Symbol	Name	Conversion
<b>Length, area, volume</b>						
l	length	m	metre	in	inch	1 in = 25.4 mm
				ft	foot	1 ft = 30.48 cm
				fathom	fathom	1 fathom = 6 ft = 1.8288 m
				mile	mile	1 mile = 1609.344 m
				sm	sea mile	1 sm = 1852 m
A	area	m <sup>2</sup>	square metre	yd	yard	1 yd = 91.44 cm
				a	are	1 a = 10 <sup>2</sup> m <sup>2</sup>
				ha	hectare	1 ha = 10 <sup>4</sup> m <sup>2</sup>
V	volume	m <sup>3</sup>	cubic metre	l	litre	1 l = 1 dm <sup>3</sup> = 10 <sup>-3</sup> m <sup>3</sup>
				UK pt	pint	1 UK pt = 0.5683 dm <sup>3</sup>
				UK gal	gallon	1 UK gal = 4.5461 dm <sup>3</sup>
				US gal	gallon	1 US gal = 3.7855 dm <sup>3</sup>
<b>Angles</b>						
α, β, γ	plane angle	rad	radian	°	degrees	1° = $\frac{\pi}{180}$ · rad
Ω	solid angle	sr	steradian			
<b>Mass</b>						
m	mass, weight	kg	kilogram	lb	pound	1 lb = 0.45359 kg
ρ	density	kg/m <sup>3</sup>	kilogram			
v	specific volume	m <sup>3</sup> /kg	cubic metre for kilogram			
M	moment of inertia	kg·m <sup>2</sup>	kilogram for square metre			
<b>Time</b>						
t	duration	s	second			
f	frequency	Hz	Hertz	1 Hz = 1/s		
ω	angular frequency	1/s	reciprocal second	ω = 2πf		
v	speed	m/s	metre per second	km/h	kilometre per hour	1 km/h = 0.2777 m/s
				mile/h	mile per hour	1 mile/h = 0.4470 m/s
				knot	kn	1 kn = 0.5144 m/s
g	acceleration	m/s <sup>2</sup>	metre per second squared			
<b>Force, energy, power</b>						
F	force	N	newton			1 N = 1 kg·m/s <sup>2</sup>
				kgf		1 kgf = 9.80665 N
p	pressure/stress	Pa	pascal	bar	bar	1 bar = 10 <sup>5</sup> Pa
				bar	horsepower	1 Hp = 745.7 W
W	energy, work	J	joule	1 J = 1 W·s = 1 N·m		
P	power	W	watt			
<b>Temperature and heat</b>						
T	temperature	K	kelvin	°C	Celsius	T[K] = 273.15 + T [°C]
				°F	Fahrenheit	T[K] = 273.15 + (5/9)·(T [°F]-32)
Q	quantity of heat	J	joule			
S	entropy	J/K	joule per kelvin			
<b>Photometric quantities</b>						
I	luminous intensity	cd	candela			
L	luminance	cd/m <sup>2</sup>	candela per square metre			
Φ	luminous flux	lm	lumen	1 lm = 1 cd·sr		
E	illuminance	lux		1 lux = 1 lm/m <sup>2</sup>		

## Annex D: Main physical quantities and electrotechnical formulas

### Main electrical and magnetic quantities and SI units

Quantity	SI unit	Other units	Conversion	
Symbol	Name	Symbol	Name	
I	current	A	ampere	
V	voltage	V	volt	
R	resistance	$\Omega$	ohm	
G	conductance	S	siemens	$G = 1/R$
X	reactance	$\Omega$	ohm	$X_L = \omega L$ $X_C = -1/\omega C$
B	susceptance	S	siemens	$B_L = -1/\omega L$ $B_C = \omega C$
Z	impedance	$\Omega$	ohm	
Y	admittance	S	siemens	
P	active power	W	watt	
Q	reactive power	var	reactive volt ampere	
S	apparent power	VA	volt ampere	
Q	electric charge	C	coulomb	Ah      ampere/hour $1 C = 1 A \cdot s$ $1 Ah = 3600 A \cdot s$
E	electric field strength	V/m	volt per metre	
C	electric capacitance	F	farad	$1 F = 1 C/V$
H	magnetic field	A/m	ampere per metre	
B	magnetic induction	T	tesla	G      gauss $1 T = 1 V \cdot s/m^2$ $1 G = 10^{-4} T$
L	inductance	H	henry	$1 H = 1 \Omega \cdot s$

### Resistivity values, conductivity and temperature coefficient at 20 °C of the main electrical materials

conductor	conductivity resistivity $\rho_{20}$ [mm <sup>2</sup> Ω/m]	$\gamma_{20} = 1/\rho_{20}$ [m/mm <sup>2</sup> Ω]	temperature coefficient $\alpha_{20}$ [K <sup>-1</sup> ]
Aluminium	0.0287	34.84	$3.8 \cdot 10^{-3}$
Brass, CuZn 40	$\leq 0.067$	$\geq 15$	$2 \cdot 10^{-3}$
Constantan	0.50	2	$-3 \cdot 10^{-4}$
Copper	0.0175	57.14	$3.95 \cdot 10^{-3}$
Gold	0.023	43.5	$3.8 \cdot 10^{-3}$
Iron wire	0.1 to 0.15	10 to 6.7	$4.5 \cdot 10^{-3}$
Lead	0.208	4.81	$3.9 \cdot 10^{-3}$
Magnesium	0.043	23.26	$4.1 \cdot 10^{-3}$
Manganin	0.43	2.33	$4 \cdot 10^{-6}$
Mercury	0.941	1.06	$9.2 \cdot 10^{-4}$
Ni Cr 8020	1	1	$2.5 \cdot 10^{-4}$
Nickeline	0.43	2.33	$2.3 \cdot 10^{-4}$
Silver	0.016	62.5	$3.8 \cdot 10^{-3}$
Zinc	0.06	16.7	$4.2 \cdot 10^{-3}$

# Annex D: Main physical quantities and electrotechnical formulas

## Main electrotechnical formulas

### Impedance

resistance of a conductor at temperature $\vartheta$	$R_{\vartheta} = \rho_{\vartheta} \cdot \frac{\ell}{S}$
conductance of a conductor at temperature $\vartheta$	$G_{\vartheta} = \frac{1}{R_{\vartheta}} = \chi_{\vartheta} \cdot \frac{S}{\ell}$
resistivity of a conductor at temperature $\vartheta$	$\rho_{\vartheta} = \rho_{20} [1 + \alpha_{20} (\vartheta - 20)]$
capacitive reactance	$X_C = \frac{-1}{\omega \cdot C} = -\frac{1}{2 \cdot \pi \cdot f \cdot C}$
inductive reactance	$X_L = \omega \cdot L = 2 \cdot \pi \cdot f \cdot L$
impedance	$Z = R + jX$
module impedance	$Z = \sqrt{R^2 + X^2}$
phase impedance	$\varphi = \arctan \frac{R}{X}$
conductance	$G = \frac{1}{R}$
capacitive susceptance	$B_C = \frac{-1}{X_C} = \omega \cdot C = 2 \cdot \pi \cdot f \cdot C$
inductive susceptance	$B_L = \frac{-1}{X_L} = -\frac{1}{\omega \cdot L} = -\frac{1}{2 \cdot \pi \cdot f \cdot L}$
admittance	$Y = G - jB$
module admittance	$Y = \sqrt{G^2 + B^2}$
phase admittance	$\varphi = \arctan \frac{B}{G}$

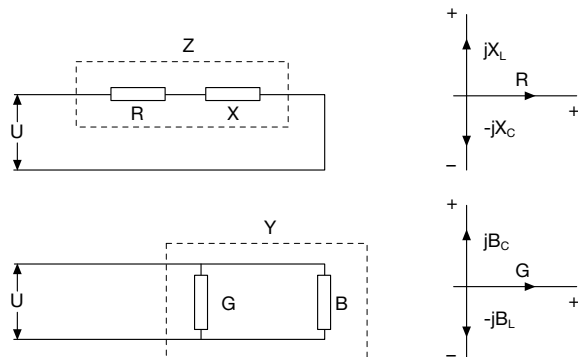

## Annex D: Main physical quantities and electrotechnical formulas

Impedances in series

$$Z = Z_1 + Z_2 + Z_3 + \dots$$

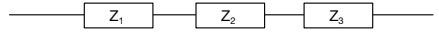

Admittances in series

$$Y = \frac{1}{\frac{1}{Y_1} + \frac{1}{Y_2} + \frac{1}{Y_3} + \dots}$$

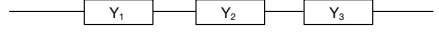

Impedances in parallel

$$Z = \frac{1}{\frac{1}{Z_1} + \frac{1}{Z_2} + \frac{1}{Z_3} + \dots}$$

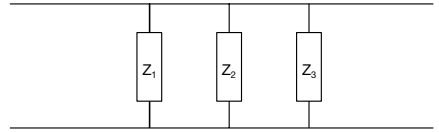

Admittances in parallel

$$Y = Y_1 + Y_2 + Y_3 + \dots$$

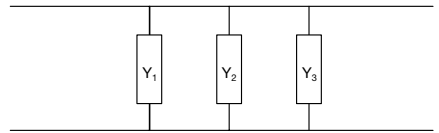

Delta-star and star-delta transformations

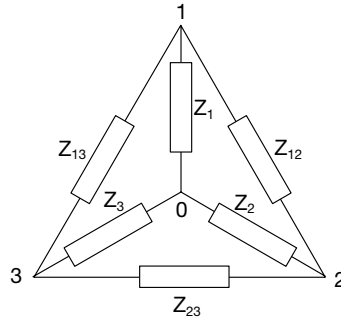

$Y \rightarrow \Delta$	$\Delta \rightarrow Y$
$Z_{12} = Z_1 + Z_2 + \frac{Z_1 \cdot Z_2}{Z_3}$	$Z_1 = \frac{Z_{12} \cdot Z_{13}}{Z_{12} + Z_{13} + Z_{23}}$
$Z_{23} = Z_2 + Z_3 + \frac{Z_2 \cdot Z_3}{Z_1}$	$Z_2 = \frac{Z_{12} \cdot Z_{23}}{Z_{12} + Z_{13} + Z_{23}}$
$Z_{13} = Z_3 + Z_1 + \frac{Z_3 \cdot Z_1}{Z_2}$	$Z_3 = \frac{Z_{23} \cdot Z_{13}}{Z_{12} + Z_{13} + Z_{23}}$



## Annex D: Main physical quantities and electrotechnical formulas

### Transformers

#### Two-winding transformer

rated current	$I_r = \frac{S_r}{\sqrt{3} \cdot U_r}$
short-circuit power	$S_k = \frac{S_r}{u_k\%} \cdot 100$
short-circuit current	$I_k = \frac{S_k}{\sqrt{3} \cdot U_r} = \frac{I_r}{u_k\%} \cdot 100$
longitudinal impedance	$Z_T = \frac{u_k\%}{100} \cdot \frac{U_r^2}{S_r} = \frac{u_k\%}{100} \cdot \frac{S_r}{3 \cdot I_r^2}$
longitudinal resistance	$R_T = \frac{p_k\%}{100} \cdot \frac{U_r^2}{S_r} = \frac{p_k\%}{100} \cdot \frac{S_r}{3 \cdot I_r^2}$
longitudinal reactance	$X_T = \sqrt{Z_T^2 - R_T^2}$

#### Three-winding transformer

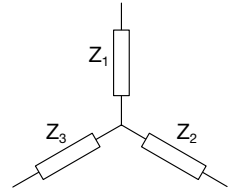
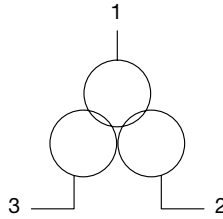

$$Z_{12} = \frac{u_{12}}{100} \cdot \frac{U_r^2}{S_{r12}}$$

$$Z_1 = \frac{1}{2} (Z_{12} + Z_{13} - Z_{23})$$

$$Z_{13} = \frac{u_{13}}{100} \cdot \frac{U_r^2}{S_{r13}}$$

$$Z_2 = \frac{1}{2} (Z_{12} + Z_{23} - Z_{13})$$

$$Z_{23} = \frac{u_{23}}{100} \cdot \frac{U_r^2}{S_{r23}}$$

$$Z_3 = \frac{1}{2} (Z_{13} + Z_{23} - Z_{12})$$

## Annex D: Main physical quantities and electrotechnical formulas

### Voltage drop and power

	single-phase	three-phase	direct current
<b>voltage drop</b>	$U = 2 \cdot I \cdot \ell \cdot (r \cos\varphi + x \sin\varphi)$	$U = \sqrt{3} \cdot I \cdot \ell \cdot (r \cos\varphi + x \sin\varphi)$	$U = 2 \cdot I \cdot \ell \cdot r$
<b>percentage voltage drop</b>	$u = \frac{U}{U_r} \cdot 100$	$u = \frac{U}{U_r} \cdot 100$	$u = \frac{U}{U_r} \cdot 100$
<b>active power</b>	$P = U \cdot I \cdot \cos\varphi$	$P = \sqrt{3} \cdot U \cdot I \cdot \cos\varphi$	$P = U \cdot I$
<b>reactive power</b>	$Q = U \cdot I \cdot \sin\varphi$	$Q = \sqrt{3} \cdot U \cdot I \cdot \sin\varphi$	-
<b>apparent power</b>	$S = U \cdot I = \sqrt{P^2 + Q^2}$	$S = \sqrt{3} \cdot U \cdot I = \sqrt{P^2 + Q^2}$	-
<b>power factor</b>	$\cos\varphi = \frac{P}{S}$	$\cos\varphi = \frac{P}{S}$	-
<b>power loss</b>	$P = 2 \cdot \ell \cdot r \cdot I^2$	$P = 3 \cdot \ell \cdot r \cdot I^2$	$P = 2 \cdot \ell \cdot r \cdot I^2$

### Caption

$\rho_{20}$	resistivity at 20 °C
$\ell$	total length of conductor
$S$	cross section of conductor
$\alpha_{20}$	temperature coefficient of conductor at 20 °C
$\theta$	temperature of conductor
$\rho\theta$	resistivity against the conductor temperature
$\omega$	angular frequency
$f$	frequency
$r$	resistance of conductor per length unit
$x$	reactance of conductor per length unit
$u_s\%$	short-circuit percentage voltage of the transformer
$S_r$	rated apparent power of the transformer
$U_r$	rated voltage of the transformer
$p_x\%$	percentage impedance losses of the transformer under short-circuit conditions





















# Contact us

## **ABB SACE**

**A division of ABB S.p.A.**

## **L.V. Breakers**

Via Baioni, 35

24123 Bergamo - Italy

Tel.: +39 035 395 111

Fax: +39 035 395306-433

**[www.abb.com](http://www.abb.com)**

The data and illustrations are not binding. We reserve the right to modify the contents of this document on the basis of technical development of the products, without prior notice.

Copyright 2010 ABB. All rights reserved.

1SDC010002D0206 - 1000