

Electrical installation handbook
Volume 1
3rd edition

Protection and control devices

1SDC008001D0203



ABB SACE



Electrical installation handbook

Volume 1

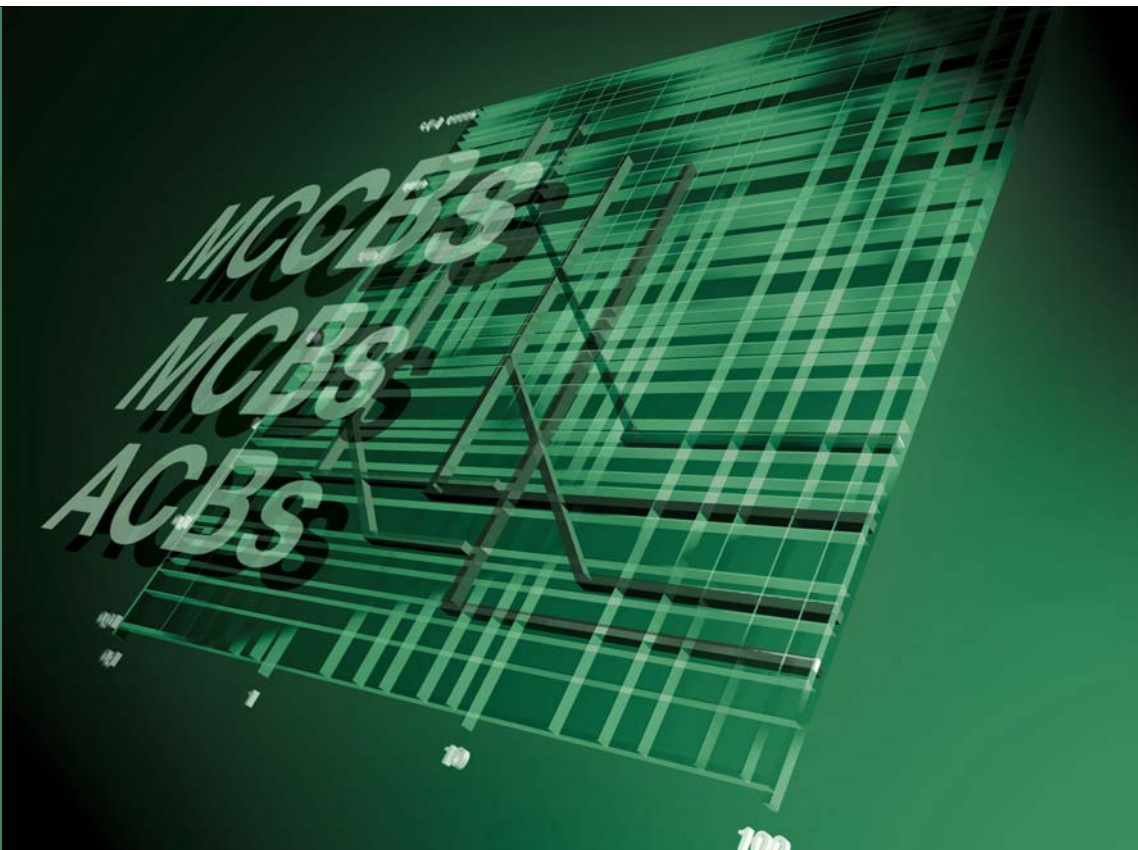
Protection and control devices

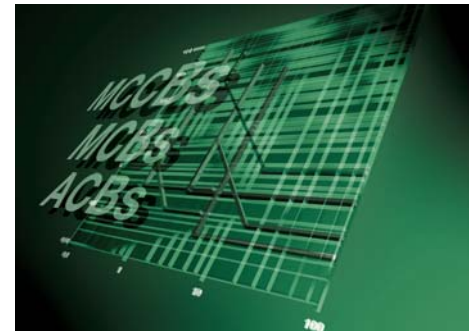

3rd edition
June 2005

First edition 2003
Second edition 2004
Third edition 2005

*Published by ABB SACE
via Baioni, 35 - 24123 Bergamo (Italy)*

All rights reserved

Index

Introduction	2
1 Standards	
1.1 General aspects	3
1.2 IEC Standards for electrical installation	15
2 Protection and control devices	
2.1 Circuit-breaker nameplates	22
2.2 Main definitions	25
2.3 Types of releases	28
3 General characteristics	
3.1 Electrical characteristics of circuit breakers	38
3.2 Trip curves	49
3.3 Limitation curves	111
3.4 Specific let-through energy curves	142
3.5 Temperature derating	172
3.6 Altitude derating	187
3.7 Electrical characteristics of switch disconnectors	188
4 Protection coordination	
4.1 Protection coordination	194
4.2 Discrimination tables	203
4.3 Back-up tables	228
4.4 Coordination tables between circuit breakers and switch disconnectors	232
5 Special applications	
5.1 Direct current networks	236
5.2 Networks at particular frequencies; 400 Hz and 16 2/3 Hz	247
5.3 1000 Vdc and 1000 Vac networks	264
5.4 Automatic Transfer Switches	276
6 Switchboards	
6.1 Electrical switchboards	285
6.2 MNS switchboards	293
6.3 ArTu distribution switchboards	294
Annex A: Protection against short-circuit effects inside low-voltage switchboards	297
Annex B: Temperature rise evaluation according to IEC 60890	306
Annex C: Application examples: Advanced protection functions with PR123/P release	320

Introduction

Scope and objectives

The scope of this electrical installation handbook is to provide the designer and user of electrical plants with a quick reference, immediate-use working tool. This is not intended to be a theoretical document, nor a technical catalogue, but, in addition to the latter, aims to be of help in the correct definition of equipment, in numerous practical installation situations.

The dimensioning of an electrical plant requires knowledge of different factors relating to, for example, installation utilities, the electrical conductors and other components; this knowledge leads the design engineer to consult numerous documents and technical catalogues. This electrical installation handbook, however, aims to supply, in a single document, tables for the quick definition of the main parameters of the components of an electrical plant and for the selection of the protection devices for a wide range of installations. Some application examples are included to aid comprehension of the selection tables.

Electrical installation handbook users

The electrical installation handbook is a tool which is suitable for all those who are interested in electrical plants: useful for installers and maintenance technicians through brief yet important electrotechnical references, and for sales engineers through quick reference selection tables.

Validity of the electrical installation handbook

Some tables show approximate values due to the generalization of the selection process, for example those regarding the constructional characteristics of electrical machinery. In every case, where possible, correction factors are given for actual conditions which may differ from the assumed ones. The tables are always drawn up conservatively, in favour of safety; for more accurate calculations, the use of DOCWin software is recommended for the dimensioning of electrical installations.

1 Standards

1.1 General aspects

In each technical field, and in particular in the electrical sector, a condition sufficient (even if not necessary) for the realization of plants according to the **“status of the art”** and a requirement essential to properly meet the demands of customers and of the community, is the respect of all the relevant laws and technical standards.

Therefore, a precise knowledge of the standards is the fundamental premise for a correct approach to the problems of the electrical plants which shall be designed in order to guarantee that **“acceptable safety level”** which is never absolute.

Juridical Standards

These are all the standards from which derive rules of behavior for the juridical persons who are under the sovereignty of that State.

Technical Standards

These standards are the whole of the prescriptions on the basis of which machines, apparatus, materials and the installations should be designed, manufactured and tested so that efficiency and function safety are ensured.

The technical standards, published by national and international bodies, are circumstantially drawn up and can have legal force when this is attributed by a legislative measure.

	Application fields		
	Electrotechnics and Electronics	Telecommunications	Mechanics, Ergonomics and Safety
International Body	IEC	ITU	ISO
European Body	CENELEC	ETSI	CEN

This technical collection takes into consideration only the bodies dealing with electrical and electronic technologies.

IEC International Electrotechnical Commission

The *International Electrotechnical Commission* (IEC) was officially founded in 1906, with the aim of securing the international co-operation as regards standardization and certification in electrical and electronic technologies. This association is formed by the International Committees of over 40 countries all over the world.

The IEC publishes international standards, technical guides and reports which are the bases or, in any case, a reference of utmost importance for any national and European standardization activity.

IEC Standards are generally issued in two languages: English and French.

In 1991 the IEC has ratified co-operation agreements with CENELEC (European standardization body), for a common planning of new standardization activities and for parallel voting on standard drafts.

1 Standards

CENELEC European Committee for Electrotechnical Standardization

The *European Committee for Electrotechnical Standardization* (CENELEC) was set up in 1973. Presently it comprises 28 countries (Austria, Belgium, Cyprus, Czech Republic, Denmark, Estonia, Finland, France, Germany, Greece, Hungary, Iceland, Ireland, Italy, Latvia, Lithuania, Luxembourg, Malta, Netherlands, Norway, Portugal, Poland, Slovakia, Slovenia, Spain, Sweden, Switzerland, United Kingdom) and cooperates with 7 affiliates (Albania, Bosnia and Herzegovina, Bulgaria, Croatia, Romania, Turkey, Ukraine) which have first maintained the national documents side by side with the CENELEC ones and then replaced them with the Harmonized Documents (HD).

There is a difference between EN Standards and Harmonization Documents (HD): while the first ones have to be accepted at any level and without additions or modifications in the different countries, the second ones can be amended to meet particular national requirements.

EN Standards are generally issued in three languages: English, French and German.

From 1991 CENELEC cooperates with the IEC to accelerate the standards preparation process of International Standards.

CENELEC deals with specific subjects, for which standardization is urgently required.

When the study of a specific subject has already been started by the IEC, the European standardization body (CENELEC) can decide to accept or, whenever necessary, to amend the works already approved by the International standardization body.

EC DIRECTIVES FOR ELECTRICAL EQUIPMENT

Among its institutional roles, the European Community has the task of promulgating directives which must be adopted by the different member states and then transposed into national law.

Once adopted, these directives come into juridical force and become a reference for manufacturers, installers, and dealers who must fulfill the duties prescribed by law.

Directives are based on the following principles:

- harmonization is limited to essential requirements;
- only the products which comply with the essential requirements specified by the directives can be marketed and put into service;
- the harmonized standards, whose reference numbers are published in the Official Journal of the European Communities and which are transposed into the national standards, are considered in compliance with the essential requirements;
- the applicability of the harmonized standards or of other technical specifications is facultative and manufacturers are free to choose other technical solutions which ensure compliance with the essential requirements;
- a manufacturer can choose among the different conformity evaluation procedure provided by the applicable directive.

The scope of each directive is to make manufacturers take all the necessary steps and measures so that the product does not affect the safety and health of persons, animals and property.

1 Standards

“Low Voltage” Directive 73/23/CEE – 93/68/CEE

The Low Voltage Directive refers to any electrical equipment designed for use at a rated voltage from 50 to 1000 V for alternating current and from 75 to 1500 V for direct current.

In particular, it is applicable to any apparatus used for production, conversion, transmission, distribution and use of electrical power, such as machines, transformers, devices, measuring instruments, protection devices and wiring materials.

The following categories are outside the scope of this Directive:

- electrical equipment for use in an explosive atmosphere;
- electrical equipment for radiology and medical purposes;
- electrical parts for goods and passenger lifts;
- electrical energy meters;
- plugs and socket outlets for domestic use;
- electric fence controllers;
- radio-electrical interference;
- specialized electrical equipment, for use on ships, aircraft or railways, which complies with the safety provisions drawn up by international bodies in which the Member States participate.

Directive EMC 89/336/EEC (“Electromagnetic Compatibility”)

The Directive on electromagnetic compatibility regards all the electrical and electronic apparatus as well as systems and installations containing electrical and/or electronic components. In particular, the apparatus covered by this Directive are divided into the following categories according to their characteristics:

- domestic radio and TV receivers;
- industrial manufacturing equipment;
- mobile radio equipment;
- mobile radio and commercial radio telephone equipment;
- medical and scientific apparatus;
- information technology equipment (ITE);
- domestic appliances and household electronic equipment;
- aeronautical and marine radio apparatus;
- educational electronic equipment;
- telecommunications networks and apparatus;
- radio and television broadcast transmitters;
- lights and fluorescent lamps.

The apparatus shall be so constructed that:

- a) the electromagnetic disturbance it generates does not exceed a level allowing radio and telecommunications equipment and other apparatus to operate as intended;
- b) the apparatus has an adequate level of intrinsic immunity to electromagnetic disturbance to enable it to operate as intended.

An apparatus is declared in conformity to the provisions at points a) and b) when the apparatus complies with the harmonized standards relevant to its product family or, in case there aren't any, with the general standards.

1 Standards

CE conformity marking

The CE conformity marking shall indicate conformity to all the obligations imposed on the manufacturer, as regards his products, by virtue of the European Community directives providing for the affixing of the CE marking.



When the CE marking is affixed on a product, it represents a declaration of the manufacturer or of his authorized representative that the product in question conforms to all the applicable provisions including the conformity assessment procedures. This prevents the Member States from limiting the marketing and putting into service of products bearing the CE marking, unless this measure is justified by the proved non-conformity of the product.

Flow diagram for the conformity assessment procedures established by the Directive 73/23/EEC on electrical equipment designed for use within particular voltage range:

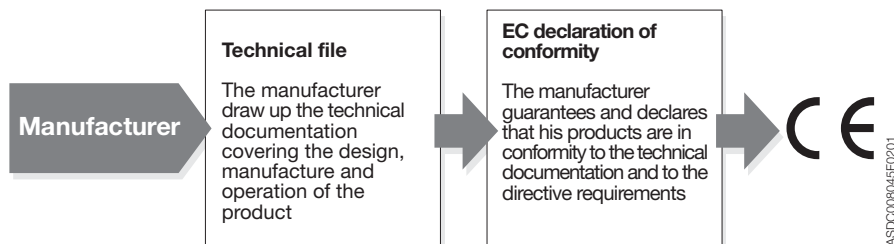

Naval type approval

The environmental conditions which characterize the use of circuit breakers for on-board installations can be different from the service conditions in standard industrial environments; as a matter of fact, marine applications can require installation under particular conditions, such as:

- environments characterized by high temperature and humidity, including salt-mist atmosphere (damp-heat, salt-mist environment);
- on board environments (engine room) where the apparatus operate in the presence of vibrations characterized by considerable amplitude and duration.

In order to ensure the proper function in such environments, the shipping registers require that the apparatus has to be tested according to specific type approval tests, the most significant of which are vibration, dynamic inclination, humidity and dry-heat tests.

1 Standards

ABB SACE circuit-breakers (Isomax-Tmax-Emax) are approved by the following shipping registers:

• RINA	Registro Italiano Navale	Italian shipping register
• DNV	Det Norske Veritas	Norwegian shipping register
• BV	Bureau Veritas	French shipping register
• GL	Germanischer Lloyd	German shipping register
• LRs	Lloyd's Register of Shipping	British shipping register
• ABS	American Bureau of Shipping	American shipping register









It is always advisable to ask ABB SACE as regards the typologies and the performances of the certified circuit-breakers or to consult the section certificates in the website <http://bol.it.abb.com>.

Marks of conformity to the relevant national and international Standards









The international and national marks of conformity are reported in the following table, for information only:

COUNTRY	Symbol	Mark designation	Applicability/Organization
EUROPE		-	Mark of compliance with the harmonized European standards listed in the ENEC Agreement.
AUSTRALIA		AS Mark	Electrical and non-electrical products. It guarantees compliance with SAA (Standard Association of Australia).
AUSTRALIA		S.A.A. Mark	Standards Association of Australia (S.A.A.). The Electricity Authority of New South Wales Sydney Australia
AUSTRIA		Austrian Test Mark	Installation equipment and materials









1 Standards

COUNTRY	Symbol	Mark designation	Applicability/Organization
AUSTRIA		ÖVE Identification Thread	Cables
BELGIUM		CEBEC Mark	Installation materials and electrical appliances
BELGIUM		CEBEC Mark	Conduits and ducts, conductors and flexible cords
BELGIUM		Certification of Conformity	Installation material and electrical appliances (in case there are no equivalent national standards or criteria)
CANADA		CSA Mark	Electrical and non-electrical products. This mark guarantees compliance with CSA (Canadian Standard Association)
CHINA		CCEE Mark	Great Wall Mark Commission for Certification of Electrical Equipment
Czech Republic		EZU' Mark	Electrotechnical Testing Institute
Slovakia Republic		EVPU' Mark	Electrotechnical Research and Design Institute









1 Standards

COUNTRY	Symbol	Mark designation	Applicability/Organization
CROATIA		KONKAR	Electrical Engineering Institute
DENMARK		DEMKO Approval Mark	Low voltage materials. This mark guarantees the compliance of the product with the requirements (safety) of the "Heavy Current Regulations"
FINLAND		Safety Mark of the Elektriska Inspektoratet	Low voltage material. This mark guarantees the compliance of the product with the requirements (safety) of the "Heavy Current Regulations"
FRANCE		ESC Mark	Household appliances
FRANCE		NF Mark	Conductors and cables – Conduits and ducting – Installation materials
FRANCE		NF Identification Thread	Cables
FRANCE		NF Mark	Portable motor-operated tools
FRANCE		NF Mark	Household appliances







1 Standards

COUNTRY	Symbol	Mark designation	Applicability/Organization
GERMANY		VDE Mark	For appliances and technical equipment, installation accessories such as plugs, sockets, fuses, wires and cables, as well as other components (capacitors, earthing systems, lamp holders and electronic devices)
GERMANY		VDE Identification Thread	Cables and cords
GERMANY		VDE Cable Mark	For cables, insulated cords, installation conduits and ducts
GERMANY		VDE-GS Mark for technical equipment	Safety mark for technical equipment to be affixed after the product has been tested and certified by the VDE Test Laboratory in Offenbach; the conformity mark is the mark VDE, which is granted both to be used alone as well as in combination with the mark GS
HUNGARY		MEEI	Hungarian Institute for Testing and Certification of Electrical Equipment
JAPAN		JIS Mark	Mark which guarantees compliance with the relevant Japanese Industrial Standard(s).
IRELAND		IIRS Mark	Electrical equipment
IRELAND		IIRS Mark	Electrical equipment



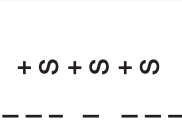





1 Standards

COUNTRY	Symbol	Mark designation	Applicability/Organization
ITALY		IMQ Mark	Mark to be affixed on electrical material for non-skilled users; it certifies compliance with the European Standard(s).
NORWAY		Norwegian Approval Mark	Mandatory safety approval for low voltage material and equipment
NETHERLANDS		KEMA-KEUR	General for all equipment
POLAND		KWE	Electrical products
RUSSIA		Certification of Conformity	Electrical and non-electrical products. It guarantees compliance with national standard (Gosstandard of Russia)
SINGAPORE		SISIR	Electrical and non-electrical products
SLOVENIA		SIQ	Slovenian Institute of Quality and Metrology
SPAIN		AEE	Electrical products. The mark is under the control of the Asociación Electrotécnica Española (Spanish Electrotechnical Association)



1 Standards

COUNTRY	Symbol	Mark designation	Applicability/Organization
SPAIN		AENOR	Asociación Española de Normalización y Certificación. (Spanish Standardization and Certification Association)
SWEDEN		SEMKO Mark	Mandatory safety approval for low voltage material and equipment.
SWITZERLAND		Safety Mark	Swiss low voltage material subject to mandatory approval (safety).
SWITZERLAND		–	Cables subject to mandatory approval
SWITZERLAND		SEV Safety Mark	Low voltage material subject to mandatory approval
UNITED KINGDOM		ASTA Mark	Mark which guarantees compliance with the relevant "British Standards"
UNITED KINGDOM		BASEC Mark	Mark which guarantees compliance with the "British Standards" for conductors, cables and ancillary products.
UNITED KINGDOM		BASEC Identification Thread	Cables

1 Standards

COUNTRY	Symbol	Mark designation	Applicability/Organization
UNITED KINGDOM		BEAB Safety Mark	Compliance with the "British Standards" for household appliances
UNITED KINGDOM		BSI Safety Mark	Compliance with the "British Standards"
UNITED KINGDOM		BEAB Kitemark	Compliance with the relevant "British Standards" regarding safety and performances
U.S.A.		UNDERWRITERS LABORATORIES Mark	Electrical and non-electrical products
U.S.A.		UNDERWRITERS LABORATORIES Mark	Electrical and non-electrical products
U.S.A.		UL Recognition	Electrical and non-electrical products
CEN		CEN Mark	Mark issued by the European Committee for Standardization (CEN): it guarantees compliance with the European Standards.
CENELEC		Mark	Cables

1 Standards

COUNTRY	Symbol	Mark designation	Applicability/Organization
CENELEC		Harmonization Mark	Certification mark providing assurance that the harmonized cable complies with the relevant harmonized CENELEC Standards – identification thread
EC		Ex EUROPEA Mark	Mark assuring the compliance with the relevant European Standards of the products to be used in environments with explosion hazards
CEEel		CEEel Mark	Mark which is applicable to some household appliances (shavers, electric clocks, etc).

EC - Declaration of Conformity

The EC Declaration of Conformity is the statement of the manufacturer, who declares under his own responsibility that all the equipment, procedures or services refer and comply with specific standards (directives) or other normative documents.

The EC Declaration of Conformity should contain the following information:

- name and address of the manufacturer or by its European representative;
- description of the product;
- reference to the harmonized standards and directives involved;
- any reference to the technical specifications of conformity;
- the two last digits of the year of affixing of the CE marking;
- identification of the signer.

A copy of the EC Declaration of Conformity shall be kept by the manufacturer or by his representative together with the technical documentation.

1 Standards

1.2 IEC Standards for electrical installation

STANDARD	YEAR	TITLE
IEC 60027-1	1992	Letter symbols to be used in electrical technology - Part 1: General
IEC 60034-1	2004	Rotating electrical machines - Part 1: Rating and performance
IEC 60617-DB-12M	2001	Graphical symbols for diagrams - 12-month subscription to online database comprising parts 2 to 11 of IEC 60617
IEC 61082-1	1991	Preparation of documents used in electrotechnology - Part 1: General requirements
IEC 61082-2	1993	Preparation of documents used in electrotechnology - Part 2: Function-oriented diagrams
IEC 61082-3	1993	Preparation of documents used in electrotechnology - Part 3: Connection diagrams, tables and lists
IEC 61082-4	1996	Preparation of documents used in electrotechnology - Part 4: Location and installation documents
IEC 60038	2002	IEC standard voltages
IEC 60664-1	2002	Insulation coordination for equipment within low-voltage systems - Part 1: Principles, requirements and tests
IEC 60909-0	2001	Short-circuit currents in three-phase a.c. systems - Part 0: Calculation of currents
IEC 60865-1	1993	Short-circuit currents - Calculation of effects - Part 1: Definitions and calculation methods
IEC 60781	1989	Application guide for calculation of short-circuit currents in low-voltage radial systems
IEC 60076-1	2000	Power transformers - Part 1: General
IEC 60076-2	1993	Power transformers - Part 2: Temperature rise
IEC 60076-3	2000	Power transformers - Part 3: Insulation levels, dielectric tests and external clearances in air
IEC 60076-5	2000	Power transformers - Part 5: Ability to withstand short circuit
IEC/TR 60616	1978	Terminal and tapping markings for power transformers
IEC 60076-11	2004	Power transformers - Part 11: Dry-type transformers
IEC 60445	1999	Basic and safety principles for man-machine interface, marking and identification - Identification of equipment terminals and of terminations of certain designated conductors, including general rules for an alphanumeric system

1 Standards

STANDARD	YEAR	TITLE
IEC 60073	2002	Basic and safety principles for man-machine interface, marking and identification – Coding for indicators and actuators
IEC 60446	1999	Basic and safety principles for man-machine interface, marking and identification - Identification of conductors by colours or numerals
IEC 60447	2004	Basic and safety principles for man-machine interface, marking and identification - Actuating principles
IEC 60947-1	2004	Low-voltage switchgear and controlgear - Part 1: General rules
IEC 60947-2	2003	Low-voltage switchgear and controlgear - Part 2: Circuit-breakers
IEC 60947-3	2001	Low-voltage switchgear and controlgear - Part 3: Switches, disconnectors, switch-disconnectors and fuse-combination units
IEC 60947-4-1	2002	Low-voltage switchgear and controlgear - Part 4-1: Contactors and motor-starters – Electromechanical contactors and motor-starters
IEC 60947-4-2	2002	Low-voltage switchgear and controlgear - Part 4-2: Contactors and motor-starters – AC semiconductor motor controllers and starters
IEC 60947-4-3	1999	Low-voltage switchgear and controlgear - Part 4-3: Contactors and motor-starters – AC semiconductor controllers and contactors for non-motor loads
IEC 60947-5-1	2003	Low-voltage switchgear and controlgear - Part 5-1: Control circuit devices and switching elements - Electromechanical control circuit devices
IEC 60947-5-2	2004	Low-voltage switchgear and controlgear - Part 5-2: Control circuit devices and switching elements – Proximity switches
IEC 60947-5-3	1999	Low-voltage switchgear and controlgear - Part 5-3: Control circuit devices and switching elements – Requirements for proximity devices with defined behaviour under fault conditions
IEC 60947-5-4	2002	Low-voltage switchgear and controlgear - Part 5: Control circuit devices and switching elements – Section 4: Method of assessing the performance of low energy contacts. Special tests
IEC 60947-5-5	1997	Low-voltage switchgear and controlgear - Part 5-5: Control circuit devices and switching elements - Electrical emergency stop device with mechanical latching function

1 Standards

STANDARD	YEAR	TITLE
IEC 60947-5-6	1999	Low-voltage switchgear and controlgear - Part 5-6: Control circuit devices and switching elements – DC interface for proximity sensors and switching amplifiers (NAMUR)
IEC 60947-6-1	1998	Low-voltage switchgear and controlgear - Part 6-1: Multiple function equipment – Automatic transfer switching equipment
IEC 60947-6-2	2002	Low-voltage switchgear and controlgear - Part 6-2: Multiple function equipment - Control and protective switching devices (or equipment) (CPS)
IEC 60947-7-1	2002	Low-voltage switchgear and controlgear - Part 7: Ancillary equipment - Section 1: Terminal blocks for copper conductors
IEC 60947-7-2	2002	Low-voltage switchgear and controlgear - Part 7: Ancillary equipment - Section 2: Protective conductor terminal blocks for copper conductors
IEC 60439-1	2004	Low-voltage switchgear and controlgear assemblies - Part 1: Type-tested and partially type-tested assemblies
IEC 60439-2	2000	Low-voltage switchgear and controlgear assemblies - Part 2: Particular requirements for busbar trunking systems (busways)
IEC 60439-3	2001	Low-voltage switchgear and controlgear assemblies - Part 3: Particular requirements for low-voltage switchgear and controlgear assemblies intended to be installed in places where unskilled persons have access for their use - Distribution boards
IEC 60439-4	2004	Low-voltage switchgear and controlgear assemblies - Part 4: Particular requirements for assemblies for construction sites (ACS)
IEC 60439-5	1998	Low-voltage switchgear and controlgear assemblies - Part 5: Particular requirements for assemblies intended to be installed outdoors in public places - Cable distribution cabinets (CDCs) for power distribution in networks
IEC 61095	2000	Electromechanical contactors for household and similar purposes

1 Standards

STANDARD	YEAR	TITLE
IEC 60890	1987	A method of temperature-rise assessment by extrapolation for partially type-tested assemblies (PTTA) of low-voltage switchgear and controlgear
IEC/TR 61117	1992	A method for assessing the short-circuit withstand strength of partially type-tested assemblies (PTTA)
IEC 60092-303	1980	Electrical installations in ships. Part 303: Equipment - Transformers for power and lighting
IEC 60092-301	1980	Electrical installations in ships. Part 301: Equipment - Generators and motors
IEC 60092-101	2002	Electrical installations in ships - Part 101: Definitions and general requirements
IEC 60092-401	1980	Electrical installations in ships. Part 401: Installation and test of completed installation
IEC 60092-201	1994	Electrical installations in ships - Part 201: System design - General
IEC 60092-202	1994	Electrical installations in ships - Part 202: System design - Protection
IEC 60092-302	1997	Electrical installations in ships - Part 302: Low-voltage switchgear and controlgear assemblies
IEC 60092-350	2001	Electrical installations in ships - Part 350: Shipboard power cables - General construction and test requirements
IEC 60092-352	1997	Electrical installations in ships - Part 352: Choice and installation of cables for low-voltage power systems
IEC 60364-5-52	2001	Electrical installations of buildings - Part 5-52: Selection and erection of electrical equipment – Wiring systems
IEC 60227		Polyvinyl chloride insulated cables of rated voltages up to and including 450/750 V
	1998	Part 1: General requirements
	2003	Part 2: Test methods
	1997	Part 3: Non-sheathed cables for fixed wiring
	1997	Part 4: Sheathed cables for fixed wiring
	2003	Part 5: Flexible cables (cords)
	2001	Part 6: Lift cables and cables for flexible connections
	2003	Part 7: Flexible cables screened and unscreened with two or more conductors
IEC 60228	2004	Conductors of insulated cables
IEC 60245		Rubber insulated cables - Rated voltages up to and including 450/750 V
	2003	Part 1: General requirements
	1998	Part 2: Test methods
	1994	Part 3: Heat resistant silicone insulated cables

1 Standards

STANDARD	YEAR	TITLE
	1994	Part 5: Lift cables
	1994	Part 6: Arc welding electrode cables
	1994	Part 7: Heat resistant ethylene-vinyl acetate rubber insulated cables
	2004	Part 8: Cords for applications requiring high flexibility
IEC 60309-2	1999	Plugs, socket-outlets and couplers for industrial purposes - Part 2: Dimensional interchangeability requirements for pin and contact-tube accessories
IEC 61008-1	2002	Residual current operated circuit-breakers without integral overcurrent protection for household and similar uses (RCCBs) - Part 1: General rules
IEC 61008-2-1	1990	Residual current operated circuit-breakers without integral overcurrent protection for household and similar uses (RCCB's). Part 2-1: Applicability of the general rules to RCCB's functionally independent of line voltage
IEC 61008-2-2	1990	Residual current operated circuit-breakers without integral overcurrent protection for household and similar uses (RCCB's). Part 2-2: Applicability of the general rules to RCCB's functionally dependent on line voltage
IEC 61009-1	2003	Residual current operated circuit-breakers with integral overcurrent protection for household and similar uses (RCBOs) - Part 1: General rules
IEC 61009-2-1	1991	Residual current operated circuit-breakers with integral overcurrent protection for household and similar uses (RCBO's) Part 2-1: Applicability of the general rules to RCBO's functionally independent of line voltage
IEC 61009-2-2	1991	Residual current operated circuit-breakers with integral overcurrent protection for household and similar uses (RCBO's) - Part 2-2: Applicability of the general rules to RCBO's functionally dependent on line voltage
IEC 60670-1	2002	Boxes and enclosures for electrical accessories for household and similar fixed electrical installations - Part 1: General requirements
IEC 60669-2-1	2002	Switches for household and similar fixed electrical installations - Part 2-1: Particular requirements – Electronic switches
IEC 60669-2-2	2002	Switches for household and similar fixed electrical installations - Part 2: Particular requirements – Section 2: Remote-control switches (RCS)
IEC 60669-2-3	1997	Switches for household and similar fixed electrical installations - Part 2-3: Particular requirements – Time-delay switches (TDS)

1 Standards

STANDARD	YEAR	TITLE
IEC 60079-10	2002	Electrical apparatus for explosive gas atmospheres - Part 10: Classification of hazardous areas
IEC 60079-14	2002	Electrical apparatus for explosive gas atmospheres - Part 14: Electrical installations in hazardous areas (other than mines)
IEC 60079-17	2002	Electrical apparatus for explosive gas atmospheres - Part 17: Inspection and maintenance of electrical installations in hazardous areas (other than mines)
IEC 60269-1	1998	Low-voltage fuses - Part 1: General requirements
IEC 60269-2	1986	Low-voltage fuses. Part 2: Supplementary requirements for fuses for use by authorized persons (fuses mainly for industrial application)
IEC 60269-3-1	2004	Low-voltage fuses - Part 3-1: Supplementary requirements for fuses for use by unskilled persons (fuses mainly for household and similar applications) - Sections I to IV: Examples of types of standardized fuses
IEC 60127-1/10		Miniature fuses -
	2003	Part 1: Definitions for miniature fuses and general requirements for miniature fuse-links
	2003	Part 2: Cartridge fuse-links
	1988	Part 3: Sub-miniature fuse-links
	1996	Part 4: Universal Modular Fuse-Links (UMF)
	1988	Part 5: Guidelines for quality assessment of miniature fuse-links
	1994	Part 6: Fuse-holders for miniature cartridge fuse-links
IEC 60730-2-7	2001	Part 10: User guide for miniature fuses
	1990	Automatic electrical controls for household and similar use. Part 2-7: Particular requirements for timers and time switches
IEC 60364-1	2001	Electrical installations of buildings - Part 1: Fundamental principles, assessment of general characteristics, definitions
IEC 60364-4	2001	Electrical installations of buildings - Part 4: Protection for safety
IEC 60364-5	2001...2002	Electrical installations of buildings - Part 5: Selection and erection of electrical equipment
IEC 60364-6	2001	Electrical installations of buildings - Part 6: Verification
IEC 60364-7	1983...2002	Electrical installations of buildings. Part 7: Requirements for special installations or locations

1 Standards

STANDARD	YEAR	TITLE
IEC 60529	2001	Degrees of protection provided by enclosures (IP Code)
IEC 61032	1997	Protection of persons and equipment by enclosures - Probes for verification
IEC/TR 61000-1-1	1992	Electromagnetic compatibility (EMC) - Part 1: General - Section 1: Application and interpretation of fundamental definitions and terms
IEC/TS 61000-1-2	2001	Electromagnetic compatibility (EMC) - Part 1-2: General - Methodology for the achievement of the functional safety of electrical and electronic equipment with regard to electromagnetic phenomena
IEC/TR 61000-1-3	2002	Electromagnetic compatibility (EMC) - Part 1-3: General - The effects of high-altitude EMP (HEMP) on civil equipment and systems

2 Protection and control devices

2.1 Circuit-breaker nameplates

Moulded-case circuit-breaker: Tmax

CIRCUIT-BREAKER TYPE			
Series T	Size 1 2 3 4 5 6	Rated ultimate short-circuit breaking capacity at 415 Vac B = 16 kA C = 25 kA N = 36 kA S = 50 kA H = 70 kA L = 85 kA (for T2) L = 120 kA (for T4-T5) L = 100 kA (for T6) V = 200 kA	Rated uninterrupted current 160 A 250 A 320 A 400 A 630 A 800 A 1000 A

Tmax T2L 160		Iu=160A Ue=690V Ui=800V Uimp=8kV IEC 60947-2	
Ue (V)	230 400/415 440 500 690	250	500
Icu (kA)	150 85 75 50 10	85	85
Ics (% Icu)	75 75 75 75 75	75	75
Cat A	~ 50-60Hz	2 P	3 P in series

SACE S7L		Iu=1250A Ue=690V IEC 947-2 CEI EN 60947-2	
Ue (V)	230 400/415 440 500 690	Ics = 50% Icu	CE
Icu 50-60 Hz (kA)	200 100 80 70 35	Cat B	CE

Rated ultimate short-circuit breaking capacity (**Icu**) and rated service short-circuit breaking capacity (**Ics**) at different voltage values.

According to the international Standard IEC 60947-2, the circuit breakers can be divided into Category **A**, i.e. without a specified short-time withstand current rating, or Category **B**, i.e. with a specified short-time withstand current rating.

CE marking affixed on ABB circuit-breakers to indicate compliance with the following CE directives: "Low Voltage Directive" (LVD) no. 73/23 EEC "Electromagnetic Compatibility Directive" (EMC) no. 89/336 EEC.

Rated impulse withstand voltage **Uimp**; i.e. the peak value of impulse voltage which the circuit-breaker can withstand under specified test conditions.

Compliance with the international Standard **IEC 60947-2**: "Low-Voltage switchgear and controlgear-Circuit-breakers".

Rated insulation voltage **Ui**; i.e. the maximum r.m.s. value of voltage which the circuit-breaker is capable of withstanding at the supply frequency under specified test conditions.

Rated operational voltage **Ue**

Rated ultimate short-circuit breaking capacity (**Icu**) at different voltage values.

Compliance with national and international product Standards.

Rated ultimate short-circuit breaking capacity (**Icu**) at different voltage values.

Moulded-case circuit-breaker: Isomax

CIRCUIT-BREAKER TYPE			
Series S	Size 7 8	Rated ultimate short-circuit breaking capacity at 415 Vac S = 50 kA H = 65 kA (for S7) H = 85 kA (for S8) L = 100 kA V = 120 kA	

SACE S7L		Iu=1250A Ue=690V IEC 947-2 CEI EN 60947-2	
Ue (V)	230 400/415 440 500 690	Ics = 50% Icu	CE
Icu 50-60 Hz (kA)	200 100 80 70 35	Cat B	CE

Rated ultimate short-circuit breaking capacity (**Icu**) and rated service short-circuit breaking capacity (**Ics**) at different voltage values.

According to the international Standard IEC 60947-2, the circuit-breakers can be divided into Category **A**, i.e. without a specified short-time withstand current rating, or Category **B**, i.e. with a specified short-time withstand current rating.

CE marking affixed on ABB circuit-breakers to indicate compliance with the following CE directives: "Low Voltage Directive" (LVD) no. 73/23 EEC "Electromagnetic Compatibility Directive" (EMC) no. 89/336 EEC.

Rated insulation voltage **Ui**; i.e. the maximum r.m.s. value of voltage which the circuit-breaker is capable of withstanding at the supply frequency under specified test conditions.

Rated operational voltage **Ue**

Rated ultimate short-circuit breaking capacity (**Icu**) at different voltage values.



Compliance with national and international product Standards.

Rated ultimate short-circuit breaking capacity (**Icu**) at different voltage values.

2 Protection and control devices

Air circuit-breaker: Emax

CIRCUIT-BREAKER TYPE					
Series E	Size 1 2 3 4 6	Rated ultimate short-circuit breaking capacity at 415 Vac		Rated uninterrupted current	
		B = 42 kA		08 ⇒ 800 A	
		N = 65 kA (50 kA E1)		10 ⇒ 1000 A	
		S = 75 kA (85 kA E2)		12 ⇒ 1250 A	
		H = 100 kA		16 ⇒ 1600 A	
		L = 130 kA		20 ⇒ 2000 A	
		V = 150 kA (130 kA E3)		25 ⇒ 2500 A	
				32 ⇒ 3200 A	
				40 ⇒ 4000 A	
				50 ⇒ 5000 A	
				63 ⇒ 6300 A	

SACE E3V 32		I _u =3200A U _e =690V		
		I _{cs} =85kA x 1s		
Cat B	~ 50-60 Hz	IEC 60947-2 made in Italy by ABB-SACE		
U _e (V)	230 415 440 525 690			
I _{cu} (kA)	130 130 130 100 100			
I _{cs} (kA)	100 100 100 85 85			

Rated uninterrupted current **I_u**

Rated operational voltage **U_e**

Rated short-time withstand current **I_{cs}**; i.e. the maximum current that the circuit-breaker can carry during a specified time.

According to the international Standard IEC 60947-2, the circuit-breakers can be divided into Category **A**, i.e. without a specified short-time withstand current rating, or Category **B**, i.e. with a specified short-time withstand current rating.

Rated ultimate short-circuit breaking capacity (**I_{cu}**) and rated service short-circuit breaking capacity (**I_{cs}**) at different voltage values.

CE marking affixed on ABB circuit-breakers to indicate compliance with the following CE directives: "Low Voltage Directive" (LVD) no. 73/23 EEC "Electromagnetic Compatibility Directive" (EMC) no. 89/336 EEC.

Compliance with the international Standard **IEC 60947-2**: "Low-Voltage switchgear and controlgear-Circuit-breakers".

ASDC008048F0201

2 Protection and control devices

2.2 Main definitions

The main definitions regarding LV switchgear and controlgear are included in the international Standards IEC 60947-1, IEC 60947-2 and IEC 60947-3.

Main characteristics

Circuit-breaker

A mechanical switching device, capable of making, carrying and breaking currents under normal circuit conditions and also making, carrying for a specified time and breaking currents under specified abnormal circuit conditions such as those of short-circuit.

Current-limiting circuit-breaker

A circuit-breaker with a break-time short enough to prevent the short-circuit current reaching its otherwise attainable peak value.

Plug-in circuit-breaker

A circuit-breaker which, in addition to its interrupting contacts, has a set of contacts which enable the circuit-breaker to be removed.

Withdrawable circuit-breaker

A circuit-breaker which, in addition to its interrupting contacts, has a set of isolating contacts which enable the circuit-breaker to be disconnected from the main circuit, in the withdrawn position, to achieve an isolating distance in accordance with specified requirements.

Moulded-case circuit-breaker

A circuit-breaker having a supporting housing of moulded insulating material forming an integral part of the circuit-breaker.

Disconnecter

A mechanical switching device which, in the open position, complies with the requirements specified for the isolating function.

Release

A device, mechanically connected to a mechanical switching device, which releases the holding means and permits the opening or the closing of the switching device.

Fault types and currents

Overload

Operating conditions in an electrically undamaged circuit which cause an over-current.

Short-circuit

The accidental or intentional connection, by a relatively low resistance or impedance, of two or more points in a circuit which are normally at different voltages.

Residual current (I_{Δ})

It is the vectorial sum of the currents flowing in the main circuit of the circuit-breaker.

2 Protection and control devices

Rated performances

Voltages and frequencies

Rated operational voltage (U_e)

A rated operational voltage of an equipment is a value of voltage which, combined with a rated operational current, determines the application of the equipment and to which the relevant tests and the utilization categories are referred to.

Rated insulation voltage (U_i)

The rated insulation voltage of an equipment is the value of voltage to which dielectric tests voltage and creepage distances are referred. In no case the maximum value of the rated operational voltage shall exceed that of the rated insulation voltage.

Rated impulse withstand voltage (U_{imp})

The peak value of an impulse voltage of prescribed form and polarity which the equipment is capable of withstanding without failure under specified conditions of test and to which the values of the clearances are referred.

Rated frequency

The supply frequency for which an equipment is designed and to which the other characteristic values correspond.

Currents

Rated uninterrupted current (I_u)

The rated uninterrupted current of an equipment is a value of current, stated by the manufacturer, which the equipment can carry in uninterrupted duty.

Rated residual operating current (I_{rN})

It is the r.m.s. value of a sinusoidal residual operating current assigned to the CBR by the manufacturer, at which the CBR shall operate under specified conditions.

Performances under short-circuit conditions

Rated making capacity

The rated making capacity of an equipment is a value of current, stated by the manufacturer, which the equipment can satisfactorily make under specified making conditions.

Rated breaking capacity

The rated breaking of an equipment is a value of current, stated by the manufacturer, which the equipment can satisfactorily break, under specified breaking conditions.

2 Protection and control devices

Rated ultimate short-circuit breaking capacity (I_{cu})

The rated ultimate short-circuit breaking capacity of a circuit-breaker is the maximum short-circuit current value which the circuit-breaker can break twice (in accordance with the sequence O – t – CO), at the corresponding rated operational voltage. After the opening and closing sequence the circuit-breaker is not required to carry its rated current.

Rated service short-circuit breaking capacity (I_{cs})

The rated service short-circuit breaking capacity of a circuit-breaker is the maximum short-circuit current value which the circuit-breaker can break three times in accordance with a sequence of opening and closing operations (O - t - CO - t - CO) at a defined rated operational voltage (U_e) and at a defined power factor. After this sequence the circuit-breaker is required to carry its rated current.

Rated short-time withstand current (I_{cw})

The rated short-time withstand current is the current that the circuit-breaker in the closed position can carry during a specified short time under prescribed conditions of use and behaviour; the circuit-breaker shall be able to carry this current during the associated short-time delay in order to ensure discrimination between the circuit-breakers in series.

Rated short-circuit making capacity (I_{cm})

The rated short-circuit making capacity of an equipment is the value of short-circuit making capacity assigned to that equipment by the manufacturer for the rated operational voltage, at rated frequency, and at a specified power-factor for ac.

Utilization categories

The utilization category of a circuit-breaker shall be stated with reference to whether or not it is specifically intended for selectivity by means of an intentional time delay with respect to other circuit-breakers in series on the load side, under short-circuit conditions (Table 4 IEC 60947-2).

Category A - Circuit-breakers not specifically intended for selectivity under short-circuit conditions with respect to other short-circuit protective devices in series on the load side, i.e. without a short-time withstand current rating.

Category B - Circuit-breakers specifically intended for selectivity under short-circuit conditions with respect to other short-circuit protective devices in series on the load side, i.e. with and intentional short-time delay provided for selectivity under short-circuit conditions. Such circuit-breakers have a short-time withstand current rating.

2 Protection and control devices

A circuit-breaker is classified in category B if its I_{cw} is higher than (Table 3 IEC 60947-2):

12·In or 5 kA, whichever is the greater	for $In \leq 2500A$
30 kA	for $In > 2500A$

Electrical and mechanical durability

Mechanical durability

The mechanical durability of an apparatus is expressed by the number of no-load operating cycles (each operating cycle consists of one closing and opening operation) which can be effected before it becomes necessary to service or replace any of its mechanical parts (however, normal maintenance may be permitted).

Electrical durability

The electrical durability of an apparatus is expressed by the number of on-load operating cycles and gives the contact resistance to electrical wear under the service conditions stated in the relevant product Standard.

2.3 Types of releases

A circuit-breaker must control and protect, in case of faults or malfunctioning, the connected elements of a plant. In order to perform this function, after detection of an anomalous condition, the release intervenes in a definite time by opening the interrupting part.

The protection releases fitted with ABB SACE moulded-case and air circuit-breakers can control and protect any plant, from the simplest ones to those

2 Protection and control devices

with particular requirements, thanks to their wide setting possibilities of both thresholds and tripping times.

Among the devices sensitive to overcurrents, the following can be considered:

- thermomagnetic releases and magnetic only releases;
- microprocessor-based releases;
- residual current devices.

The choice and adjusting of protection releases are based both on the requirements of the part of plant to be protected, as well as on the coordination with other devices; in general, discriminating factors for the selection are the required threshold, time and curve characteristic.

2.3.1 THERMOMAGNETIC RELEASES AND MAGNETIC ONLY RELEASES

The thermomagnetic releases use a bimetal and an electromagnet to detect overloads and short-circuits; they are suitable to protect both alternating and direct current networks.

The following table shows the available rated currents and the relevant magnetic settings.

Circuit-breaker Magnetic type	In [A]	1	1.6	2	2.5	3.2	4	5	6.3	8	8.5	10	11	12.5	16	20	25	32	40	50	52	63	80	100	125	160	200	250	320	400	500	630	800		
T1 TMD 10xIn	Thermal [A]→	1.1-1.6	1.4-2	1.8-2.5	2.2-3.2	2.8-4	3.5-5	4.4-6.3	5.6-8	-	7-10	-	8.8-12.5	11-16	14-20	18-25	22-32	28-40		35-50	-	44-63	56-80	70-100	88-125	112-160	140-200	175-250	224-320	280-400	350-500	441-630	560-800		
T2 TMD 10xIn	I ₃ [A]	16	20	25	32	40	50	63	80		100		125	500	500	500	500	500		500		630	800	1000	1250	1600									
MF 13xIn		13	21	26	33	42	52	65	84		110		145	163																					
MA 6-12xIn															120-240	192-384					314-624	480-960	600-1200												
T3 TMD 10xIn																					630	800	1000	1250	1600	2000	2500								
TMG 3xIn																					400	400	400	400	480	600	750								
MA 6-12xIn																								600-1200	750-1500	960-1920	1200-2400								
T4 TMD 10xIn	I ₃ [A]														320	320				500				400-800	500-1000	625-1250	800-1600	1000-2000	1250-2500						
TMA 5-10xIn																																			
MA 6-14xIn										60-140						150-350					314-728	480-1120	600-1400	750-1750	960-2240	1200-2800									
T5 TMA 5-10xIn																												1600-3200	2000-4000	2500-5000					
TMG 2.5-5xIn																												800-1600	1000-2000	1250-2500					
T6 TMA 5-10xIn																																		3150-6300	4000-8000

*Note: TMD Thermomagnetic release with adjustable thermal and fixed magnetic threshold
TMA Thermomagnetic release with adjustable thermal and magnetic threshold
TMG Thermomagnetic release for generator protection
MA Adjustable magnetic only releases
MF Fixed magnetic only releases

2 Protection and control devices

For example, a circuit-breaker type T2, with rated current I_n equal to 2.5 A, is available in two versions:

- thermomagnetic with adjustable thermal current I_1 from 1.8 up to 2.5 A and fixed magnetic current I_3 equal to 25 A;
- fixed magnetic only releases (MF) with I_3 equal to 33 A.

2.3.2 ELECTRONIC RELEASES

These releases are connected with current transformers (three or four according to the number of conductors to be protected), which are positioned inside the circuit-breaker and have the double functions of supplying the power necessary to the proper functioning of the release (self-supply) and of detecting the value of the current flowing inside the live conductors; therefore they are compatible with alternating current networks only.

The signal coming from the transformers and from the Rogowsky coils is processed by the electronic component (microprocessor) which compares it with the set thresholds. When the signal exceeds the thresholds, the trip of the circuit-breaker is operated through an opening solenoid which directly acts on the circuit-breaker operating mechanism.

In case of auxiliary power supply in addition to self-supply from the current transformers, the voltage shall be 24 Vdc \pm 20%.

Rated Current I_n [A] →		10	25	63	100 ⁽¹⁾	160 ⁽²⁾	200	250	320	400	630	800	1000	1250	1600	2000	2500	3200	
L Function	PR221	4-10	10-25	25-63	40-100	64-160		100-250	128-320	160-400	252-630	320-800	400-1000						
	PR222				40-100	64-160		100-250	128-320	160-400	252-630	320-800	400-1000						
	PR223				18-100	28.8-160		45-250	57.6-320	72-400	113.4-630	144-800	180-1000						
	PR211/PR212 PR222/MP PR212/MP				40-100	64-160	80-200		128-320	160-400	252-630		400-1000	500-1250	640-1600	800-2000	1000-2500	1280-3200	
S Function	PR221 ⁽¹⁾	10-100	25-250	63-630	100-1000	160-1600		250-2500	320-3200	400-4000	630-6300	800-8000	1000-10000						
	PR222				60-1000	96-1600		150-2500	192-3200	240-4000	378-6300	480-8000	600-10000						
	PR223				60-1000	96-1600		150-2500	192-3200	240-4000	378-6300	480-8000	600-10000						
	PR211/PR212												1000-10000	1250-12500	1600-1600	2000-20000	2500-25000	3200-32000	
I Function	PR221 ⁽¹⁾	10-100	25-250	63-630	100-1000	160-1600		250-2500	320-3200	400-4000	630-6300	800-8000	1000-10000						
	PR222				150-1200	240-1920		375-3000	480-3200*	600-4800	945-6300**	1200-9600	1500-12000						
	PR223				150-1200	240-1920		375-3000	480-3200*	600-4800	945-6300**	1200-9600	1500-12000						
	PR211/PR212 PR222/MP PR212/MP							600-1300	960-2080	1200-2600		1920-4160	2400-5200	3780-8190		6000-13000			

⁽¹⁾ For T2 only: S function is in alternative to I function

⁽²⁾ Not available with PR223 EF

* For T5 480-3840

CURRENT TRANSFORMER SIZE

Rated current I_n [A] →	10	25	63	100	160	250	320	400	630	800	1000	1250	1600	2000	2500	3200
Circuit-breaker	u [A]															
T2	160															
T4	250															
T5	400															
T6	630															
S7	1250															
S8	2000															

** For T6 945-7560

2 Protection and control devices

Besides the standard protection functions, releases provide:

- measurements of the main characteristics of the plant: current, voltage, power, power factor, frequency, peak factor and energy (PR223);
- measurements of the main characteristics of the plant: current, voltage, power, power factor, frequency, peak factor, energy, harmonics calculation and maintenance (PR122-PR123);
- serial communication with remote control for a complete management of the plant (PR212-PR222-PR223-PR122-PR123 equipped with dialogue unit).

2 Protection and control devices

Rating plugs		CURRENT TRANSFORMER SIZE											
Type of circuit-breaker	Rated current I _n	In [A]											
		400	630	800	1000	1250	1600	2000	2500	3200	4000	5000	6300
E1B	800												
	1000-1250												
	1600												
E1N	800												
	1000-1250												
	1600												
E2B	1600												
	2000												
E2N	1000-1250												
	1600												
	2000												
E2S	800												
	1000-1250												
	1600												
E2L	1250												
	1600												
	2000												
E3N	2500												
	3200												
	1000-1250												
E3S	1600												
	2000												
	2500												
	3200												
	800												
E3H	1000-1250												
	1600												
	2000												
	2500												
	3200												
E3V	800												
	1250												
	1600												
	2000												
	2500												
E3L	2000												
	2500												
E4S, E4S/f	4000												
	3200												
E4H, E4H/f	4000												
	3200												
E4V	4000												
	4000												
E6H, E6H/f	5000												
	6300												
	3200												
E6V	4000												
	5000												
	6300												

Rated current In [A] →		400	630	800	1000	1250	1600	2000	2500	3200	4000	5000	6300
L	Function PR121												
	Function PR122/PR123	160+400	252+630	320+800	400+1000	500+1250	640+1600	800+2000	1000+2500	1280+3200	1600+4000	2000+5000	2520+6300
S	Function PR121	400+4000	630+6300	800+8000	1000+10000	1250+12500	1600+16000	2000+20000	2500+25000	3200+32000	4000+40000	5000+50000	6300+63000
	Function PR122/PR123	240+4000	378+6300	480+8000	600+10000	750+12500	960+16000	1200+20000	1500+25000	1920+32000	2400+40000	3000+50000	3780+63000
I	Function PR121	600+6000	945+9450	1200+12000	1500+15000	1875+18750	2400+24000	3000+30000	3750+37500	4800+48000	6000+60000	7500+75000	9450+94500
	Function PR122/PR123												

2 Protection and control devices

2.3.2.1 PROTECTION FUNCTIONS OF ELECTRONIC RELEASES

The protection functions available for the electronic releases are:

L - Overload protection with inverse long time delay

Function of protection against overloads with inverse long time delay and constant specific let-through energy; it cannot be excluded.

L - Overload protection in compliance with Std. IEC 60255-3

Function of protection against overloads with inverse long time delay and trip curves complying with IEC 60255-3; applicable in the coordination with fuses and with medium voltage protections.

S - Short-circuit protection with adjustable delay

Function of protection against short-circuit currents with adjustable delay; thanks to the adjustable delay, this protection is particularly useful when it is necessary to obtain selective coordination between different devices.

S₂ - Double S

This function allows two thresholds of protection function S to be set independently and activated simultaneously, selectivity can also be achieved under highly critical conditions.

D - Directional short-circuit protection with adjustable delay

The directional protection, which is similar to function S, can intervene in a different way according to the direction of the short-circuit current; particularly suitable in meshed networks or with multiple supply lines in parallel.

I - Short-circuit protection with instantaneous trip

Function for the instantaneous protection against short-circuit.

EFDP - Early Fault Detection and Prevention

Thanks to this function, the release is able to isolate a fault in shorter times than the zone selectivities currently available on the market.

Rc - Residual current protection

This function is particularly suitable where low-sensitivity residual current protection is required and for high-sensitivity applications to protect people against indirect contact.

G - Earth fault protection with adjustable delay

Function protecting the plant against earth faults.

U - Phase unbalance protection

Protection function which intervenes when an excessive unbalance between the currents of the single phases protected by the circuit-breaker is detected.

OT - Self-protection against overtemperature

Protection function controlling the opening of the circuit-breaker when the temperature inside the release can jeopardize its functioning.

UV - Undervoltage protection

Protection function which intervenes when the phase voltage drops below the preset threshold.

2 Protection and control devices

OV - Overvoltage protection

Protection function which intervenes when the phase voltage exceeds the preset threshold.

RV - Residual voltage protection

Protection which identifies anomalous voltages on the neutral conductor.

RP - Reverse power protection

Protection which intervenes when the direction of the active power is opposite to normal operation.

UF - Under frequency protection

This frequency protection detects the reduction of network frequency above the adjustable threshold, generating an alarm or opening the circuit.

OF - Overfrequency protection

This frequency protection detects the increase of network frequency above the adjustable threshold, generating an alarm or opening the circuit.

M - Thermal memory

Thanks to this function, it is possible to take into account the heating of a component so that the tripping is the quicker the less time has elapsed since the last one.

R - Protection against rotor blockage

Function intervening as soon as conditions are detected, which could lead to the block of the rotor of the protected motor during operation.

linst - Very fast instantaneous protection against short-circuit

This particular protection function has the aim of maintaining the integrity of the circuit-breaker and of the plant in case of high currents requiring delays lower than those guaranteed by the protection against instantaneous short-circuit. This protection must be set exclusively by ABB SACE and cannot be excluded.

Dual setting

With this function it is possible to program two different sets of parameters (LSIG) and, through an external command, to switch from one set to the other.

The following table summarizes the types of electronic release and the functions they implement:

SERIES	SIZE	RELEASE	PROTECTION FUNCTION	
Tmax	T2	PR221DS LS	L-S or L-I	
		PR221DS I	I	
	T4-T5-T6	PR221DS LS/I	L-S-I	
		PR222DS/P LSI	L-S-I	
		PR222DS/P LSIG	L-S-I-G	
		PR222MP LRIU	L-R-I-U	
		PR223DS	L-S-I-G	
		PR223EF	L-S-I-G-EFDP	
	Isomax	S7	PR211/P LI	L-I
			PR211/P I	I
S7-S8		PR212/P LSI	L-S-I	
		PR212/P LSIG	L-S-I-G	
Emax	S7	PR212/MP LRIU	L-R-I-U	
		E1-E2-E3-E4-E6	PR121/P LI	L-I
	PR121/P LSI		L-S-I	
	PR121/P LSIG		L-S-I-G	
	PR122/P LI		L-I-OT-U-M	
	PR122/P LSI		L-S-I-OT-U-M	
	PR122/P LSIG		L-S-I-G-OT-U-M	
	PR122/P LSI Rc		L-S-I-Rc-OT-U-M	
	PR123/P LSI		L-S-S ₂ -I-Rc-D-U-OT-UV-OV-RV-RP-UF-OF-M	
	PR123/P LSIG	L-S-S ₂ -I-G-Rc-D-U-OT-UV-OV-RV-RP-UF-OF-M		

The settings and curves of the single protection functions are reported in the chapter 3.2.2

2 Protection and control devices

2.3.3 RESIDUAL CURRENT DEVICES

The residual current releases are associated with the circuit-breaker in order to obtain two main functions in a single device:

- protection against overloads and short-circuits;
- protection against indirect contacts (presence of voltage on exposed conductive parts due to loss of insulation).

Besides, they can guarantee an additional protection against the risk of fire deriving from the evolution of small fault or leakage currents which are not detected by the standard protections against overload.

Residual current devices having a rated residual current not exceeding 30 mA are also used as a means for additional protection against direct contact in case of failure of the relevant protective means.

Their logic is based on the detection of the vectorial sum of the line currents through an internal or external toroid.

This sum is zero under service conditions or equal to the earth fault current (I_{Δ}) in case of earth fault.

When the release detects a residual current different from zero, it opens the circuit-breaker through an opening solenoid.

As we can see in the picture the protection conductor or the equipotential conductor have to be installed outside the eventual external toroid.

Generic distribution system (IT, TT, TN)

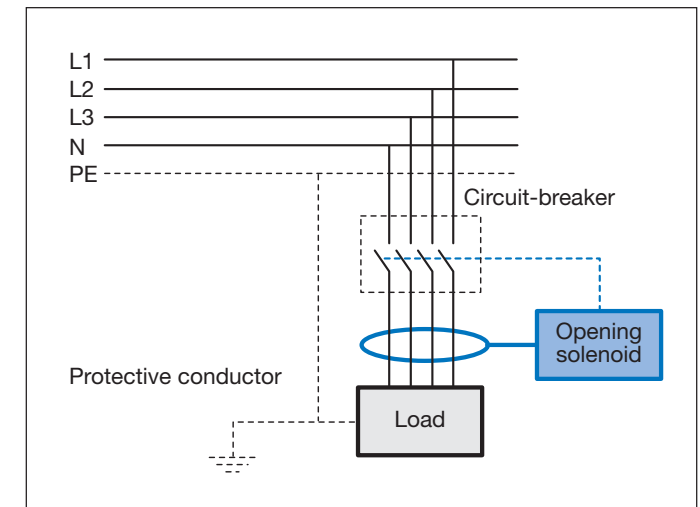





The operating principle of the residual current release makes it suitable for the distribution systems TT, IT (even if paying particular attention to the latter) and TN-S, but not in the systems TN-C. In fact, in these systems, the neutral is used also as protective conductor and therefore the detection of the residual current would not be possible if the neutral passes through the toroid, since the vectorial sum of the currents would always be equal to zero.

2 Protection and control devices

One of the main characteristics of a residual current release is its minimum rated residual current $I_{\Delta n}$. This represents the sensitivity of the release.

According to their sensitivity to the fault current, the residual current circuit-breakers are classified as:

- type AC: a residual current device for which tripping is ensured in case of residual sinusoidal alternating current, in the absence of a dc component whether suddenly applied or slowly rising;
- type A: a residual current device for which tripping is ensured for residual sinusoidal alternating currents in the presence of specified residual pulsating direct currents, whether suddenly applied or slowly rising.
- type B residual current device for which tripping is ensured for residual sinusoidal alternating currents in presence of specified residual pulsating direct currents whether suddenly applied or slowly rising, for residual direct currents may result from rectifying circuits.

	Form of residual current	Correct functioning of residual current devices		
		Type	A	B
Sinusoidal ac	 suddenly applied	AC	+	+
	 slowly rising	+	+	+
Pulsating dc	 suddenly applied with or without $\uparrow 0,006A$		+	+
	 slowly rising			
Smooth dc				+

ASDC008003F0201

In presence of electrical apparatuses with electronic components (computers, photocopiers, fax etc.) the earth fault current might assume a non sinusoidal shape but a type of a pulsating unidirectional dc shape. In these cases it is necessary to use a residual current release classified as type A.

In presence of rectifying circuits (i.e. single phase connection with capacitive load causing smooth direct current, three pulse star connection or six pulse bridge connection, two pulse connection line-to-line) the earth fault current might assume a unidirectional dc shape.

2 Protection and control devices

In these case it is necessary to use a residual current release classified as type B. The following table shows the main characteristics of ABB SACE residual current devices; they can be mounted both on circuit-breakers as well as on switch disconnectors (in case of fault currents to earth lower than the apparatus breaking capacity), are type A devices and they do not need auxiliary supply since they are self-supplied.

Suitable for circuit-breaker type	RC221		RC222	
	T1-T2-T3 T1D-T3D	T1-T2-T3 T1D-T3D	T4 T4D	T5 T5D
Primary service voltage [V]	85-500	85-500	85-500	85-500
Rated service current [A]	250	250	250	400
Rated residual current trip $I_{\Delta n}$ [A]	0.03-0.1-0.3- 0.5-1-3	0.03-0.05-0.1- 0.3-0.5-1 3-5-10	0.03-0.05-0.1- 0.3-0.5-1 3-5-10	0.03-0.05-0.1- 0.3-0.5-1 3-5-10
Time limit for non-trip (at $2x I_{\Delta n}$) [s]	Instantaneous	Inst.-0.1-0.2- 0.3-0.5-1-2-3	Inst.-0.1-0.2- 0.3-0.5-1-2-3	Inst.-0.1-0.2- 0.3-0.5-1-2-3
Tolerance over trip times [%]		± 20	± 20	± 20

Note: for detailed information, please consult the relevant technical catalogues.

Emax air circuit-breakers can be equipped with a toroid fitted on the back of the circuit-breaker so as to ensure protection against earth faults. In particular, the electronic release types able to perform this function are:

- PR122/P LSIRc
- PR122/P LSIG with "Measuring module"
- PR123/P LSIG

which can all be provided for the following types of circuit-breakers: E2 and E3, both three and four pole version, and E4 (three pole version).

Along with the family of residual current releases illustrated previously, ABB SACE is developing the RC223 (B type) residual current release, which can only be combined with the Tmax T4 four-pole circuit-breaker in the fixed or plug-in version. It is characterized by the same types of reference as the RC222 (S and AE types) release, but can also boast conformity with type B operation, which guarantees sensitivity to residual fault currents with alternating, alternating pulsating and direct current components.

Apart from the signals and settings typical of the RC222 residual current release, the RC223 also allows selection of the maximum threshold of sensitivity to the residual fault frequency (3 steps: 400 – 700 – 1000 Hz). It is therefore possible to adapt the residual current device to the different requirements of the industrial plant according to the prospective fault frequencies generated on the load side of the release.

ABB SACE moulded-case circuit-breakers series Isomax¹ and Tmax and air circuit-breakers series Emax¹ can be combined with the switchboard residual current relay type RCQ, type A, with separate toroid (to be installed externally on the line conductors).

		RCQ
Power supply voltage	ac [V]	80 + 500
	dc [V]	48+125
Trip threshold adjustments $I_{\Delta n}$		
	1 st range of adjustments [A]	0.03 – 0.05 - 0.1 - 0.3 – 0.5
	2 nd range of adjustments [A]	1 – 3 – 5 – 10 - 30
Trip time adjustment		
	[s]	0 - 0.1 - 0.2 - 0.3 - 0.5 - 0.7 - 1 - 2 - 3 - 5
Tolerance over Trip times [%]		± 20

Note: for detailed information, please consult the relevant technical catalogues.

The versions with adjustable trip times allow to obtain a residual current protection system coordinated from a discrimination point of view, from the main switchboard up to the ultimate load.

3 General characteristics

SACE Isomax moulded-case circuit-breakers

Rated uninterrupted current, I_u	[A]
Poles	No.
Rated operational voltage, U_e	(ac) 50-60Hz [V] (dc) [V]
Rated impulse withstand voltage, U_{imp}	[kV]
Rated insulation voltage, U_i	[V]
Test voltage at industrial frequency for 1 min.	[V]
Rated ultimate short-circuit breaking capacity, I_{cu}	
(ac) 50-60 Hz 220/230 V	[kA]
(ac) 50-60 Hz 380/415 V	[kA]
(ac) 50-60 Hz 440 V	[kA]
(ac) 50-60 Hz 500 V	[kA]
(ac) 50-60 Hz 690 V	[kA]
(dc) 250 V - 2 poles in series	[kA]
(dc) 500 V - 2 poles in series	[kA]
(dc) 500 V - 3 poles in series	[kA]
(dc) 750 V - 3 poles in series	[kA]
Rated short-circuit service breaking capacity, I_{cs}	[%I _{cu}]
Rated short-circuit making capacity (415 V) I_{cm}	[kA]
Opening time (415V at I _{cu})	[ms]
Rated short-time withstand current for 1 s, I_{cw}	[kA]
Utilization category (EN 60947-2)	
Isolation behaviour	
IEC 60947-2, EN 60947-2	
Releases: thermomagnetic	T adjustable, M adjustable TMA
	T adjustable, M fixed 2,5 In TMG
with microprocessor	PR211/P (I-LI) PR212/P (LSI-LSIG)
Interchangeability	
Versions	
Terminals	fixed
	plug-in
	withdrawable (1)
Mechanical life	[No. operations / operations per hours]
Electrical life (at 415 V)	[No. operations / operations per hours]
Basic dimensions, fixed	3/4 poles
	L [mm]
	D [mm]
	H [mm]
Weights	fixed 3/4 poles [kg]
	plug-in 3/4 poles [kg]
	withdrawable 3/4 poles [kg]

(1) The withdrawable version circuit-breakers must be fitted with the front flange for the lever operating mechanism or with its alternative accessories, such as the rotary handle or the motor operator

KEY TO VERSIONS
F = Fixed
P = Plug-in
W = Withdrawable

3 General characteristics

S7			S8	
1250 - 1600			2000 - 2500 - 3200	
3-4			3-4	
690			690	
-			-	
8			8	
800			690	
3000			2500	
S	H	L	H	V
85	100	200	85	120
50	65	100	85	120
40	55	80	70	100
35	45	70	50	70
20	25	35	40	50
-	-	-	-	-
-	-	-	-	-
-	-	-	-	-
-	-	-	-	-
100%	75%	50%	50%	50%
105	143	220	187	264
22	22	22	20	20
15 (1250A) - 20 (1600A)			35	
B			B	
■			■	
■			■	
-			-	
-			-	
-			-	
■			■	
■			■	
■			■	
F - W			F	
F - EF - ES - FC CuAl (1250A) - HR - VR			F (2000-2500A) - VR	
-			-	
EF - HR - VR			-	
10000/120			10000/20	
7000(1250A) - 5000(1600A)/20			2500(2500A)/20 - 1500(3200A)/10	
210/280			406/556	
138.5			242	
406			400	
17 / 22			57/76	
-			-	
21.8 / 29.2			-	

KEY TO TERMINALS
F = Front
EF = Extended front
ES = Extended spreaded front

FC CuAl = Front for copper or aluminium cables
R = Rear threaded
RC = Rear for copper or aluminium cables
HR = Rear horizontal flat bar
VR = Rear vertical flat bar

3 General characteristics

SACE Isomax moulded-case circuit-breakers for motor protection

Rated uninterrupted, Iu	[A]
Rated current, In	[A]
Poles	No
Rated operational voltage (ac) 50-60 Hz, Ue	[V]
Rated impulse withstand voltage, Uimp	[kV]
Rated insulation voltage, Ui	[V]
Test voltage at industrial frequency for 1 minute	[V]
Rated ultimate short-circuit braking capacity, Icu	
(ac) 50-60Hz 220/230V	[kA]
(ac) 50-60Hz 380/415V	[kA]
(ac) 50-60Hz 440V	[kA]
(ac) 50-60Hz 500V	[kA]
(ac) 50-60Hz 690V	[kA]
Rated service short-circuit braking capacity, Ics	[%Icu]
Rated short-circuit making capacity (415Vac), Icm	[kA]
Opening time (415Vac at Icu)	[ms]
Utilization category (EN 60947-2)	
Insulation behaviour	
Reference standard	
IEC 60947-2, EN60947-2	
IEC 60947-4-1, EN60947-4-1	
Microprocessor-based release	
Interchangeability	
Versions	
Terminals	
Fixed	
Plug-in	
Withdrawable	
Mechanical life	[No. of operations]
	[Operations per hour]
	L [mm]
	D [mm]
Basic dimensions, fixed 3 poles	H [mm]
	3 poles fixed [kg]
	3 poles plug-in [kg]
Weight	3 poles withdrawable [kg]

KEY TO VERSIONS

F = Fixed

P = Plug-in

W = Withdrawable

KEY TO TERMINALS

F = Front

EF = Extended front

ES = Extended spreaded front

FC CuAl = Front for copper or aluminium cables
R = Rear threaded

3 General characteristics

S7			S7	
1250 / 1600			1250	
1000, 1250 / 1600			1000	
3			3	
690			690	
8			8	
8000			8000	
3000			3000	
S	H	L	S	H
85	100	200	85	100
50	65	100	50	65
40	55	80	40	55
35	45	70	35	45
20	25	35	20	25
100%	75%	50%	100%	75%
105	143	220	105	143
22	22	22	22	22
B			B	
■			■	
-			■	
PR211/P (I)			PR212/MP (L-R-I-U)	
■			■	
F - W			F - W	
F - EF - ES - FCCuAl (1250A) - HR - VR			F - EF - ES - FCCuAl - HR - VR	
-			-	
EF - HR - VR			EF - HR - VR	
10000			10000	
120			120	
210			210	
138.5			138.5	
406			406	
17			17	
-			-	
21.8			21.8	

RC = Rear for copper or aluminium cables

HR = Rear horizontal flat bar

VR = Rear vertical flat bar

3 General characteristics

SACE Emax air circuit-breakers

Common data

Voltages		
Rated operational voltage <i>U_e</i>	[V]	690 ~
Rated insulation voltage <i>U_i</i>	[V]	1000
Rated impulse withstand voltage <i>U_{imp}</i>	[kV]	12
Test voltage at industrial frequency for 1 min.	[V]	3500 ~
Service temperature	[°C]	-25...+70
Storage temperature	[°C]	-40...+70
Frequency <i>f</i>	[Hz]	50 - 60
Number of poles		3 - 4
Version		Fixed -Withdrawable

Performance levels		
Currents: rated uninterrupted current (at 40 °C) <i>I_u</i>		
		[A]
220/230/380/400/415 V ~		[kA]
440 V ~		[kA]
500/525 V ~		[kA]
660/690 V ~		[kA]
Rated service breaking capacity under short-circuit <i>I_{cs}</i>		
220/230/380/400/415 V ~		[kA]
440 V ~		[kA]
500/525 V ~		[kA]
660/690 V ~		[kA]
Rated short-time withstand current <i>I_{sw}</i>		
	(1s)	[kA]
	(3s)	[kA]
Rated making capacity under short-circuit (peak value) <i>I_{cm}</i>		
220/230/380/400/415 V ~		[kA]
440 V ~		[kA]
500/525 V ~		[kA]
660/690 V ~		[kA]
Utilisation category (according to CEI EN 60947-2)		
Isolation behaviour (according to CEI EN 60947-2)		
O vercurrent protection		
Electronic releases for AC applications		
Operating times		
Closing time (max)		[ms]
Breaking time for <i>I_{cs}</i> (max) ⁽¹⁾		[ms]
Breaking time for <i>I_{sw}</i> (max)		[ms]
Overall dimensions		
F xed: H = 418 mm - D = 302 mm L (3/4 poles)		[mm]
W thdrawable: H = 461 mm - D = 396.5 mm L (3/4 poles)		[mm]
W eights (circuit-breaker complete with releases and CTs, including accessories)		
Fixed 3/4 poles		[kg]
W thdrawable 3/4 poles (including fixed part)		[kg]

(1) Without intentional delays
(2) Performance at 600 V is 100 kA

SACE Emax air circuit-breakers

	E1 B-N			E2 B-N-S		
	800	1000-1250	1600	800	1000-1250	1600 2000
Rated uninterrupted current (at 40 °C) <i>I_u</i>	[A]					
Mechanical life with regular ordinary maintenance	[No. operations x 1000]					
Operation frequency	[Operations/hour]					
Electrical life	(440 V ~) [No. operations x 1000]					
	(690 V ~) [No. operations x 1000]					
Operation frequency	[Operations/hour]					

3 General characteristics

E1			E2			E3			E4			E6					
B	N		B	N	S	N	S	H	V	L		S	H	V	H	V	
800	800		1600	1000	800 1250	2500	1000	800	800	2000	4000	3200	3200	4000	3200		
1000	1000		2000	1250	1000 1600	3200	1250	1000	1250	2500		4000	4000	5000	4000		
1250	1250		1600	1250		1600	1250	1600						6300	5000		
1600	1600				2000 1600	2000	1600	2000							6300		
			2000			2500 2000 2500											
						3200 2500 3200											
						3200											
100	100		100	100	100 100	100	100	100	100	100	50	50	50	50	50		
42	50		42	65	85 130	65	75	100	130	130	75	100	150	100	150		
42	50		42	65	85 110	65	75	100	130	110	75	100	150	100	150		
42	50		42	55	65 85	65	75	100	100	85	75	100	130	100	130		
42	50		42	55	65 85	65	75	85 ⁽²⁾	100	85	75	85 ⁽²⁾	100	100	100		
42	50		42	65	85 130	65	75	85	100	130	75	100	125	100	125		
42	50		42	65	85 110	65	75	85	100	110	75	100	125	100	125		
42	50		42	55	65 65	65	75	85	65	65	75	100	130	100	100		
42	50		42	55	65 65	65	75	85	85	65	75	85	100	100	100		
42	50		42	55	65 10	65	75	75	85	15	75	100	100	100	100		
36	36		42	42	42 -	65	65	65	65	-	75	75	75	85	85		
88.2	105		88.2	143	187 286	143	165	220	286	286	165	220	330	220	330		
88.2	105		88.2	143	187 242	143	165	220	286	242	165	220	330	220	330		
75.6	75.6		84	121	143 187	143	165	187	220	187	165	220	286	220	286		
75.6	75.6		84	121	143 187	143	165	187	220	187	165	187	220	220	220		
B	B		B	B	B A	B	B	B	B A		B	B	B	B	B		
■	■		■	■	■	■	■	■	■	■	■	■	■	■	■		
■	■		■	■	■	■	■	■	■	■	■	■	■	■	■		
80	80		80	80	80 80	80	80	80	80	80	80	80	80	80	80		
70	70		70	70	70 70	70	70	70	70	70	70	70	70	70	70		
30	30		30	30	30 12	30	30	30	30	12	30	30	30	30	30		
			296/386			296/386			404/530			566/656			782/908		
			324/414			324/414			432/558			594/684			810/936		
			45/54 45/54			50/61 50/61 50/61 52/63			66/80 66/80 66/80 66/80			72/83			97/117 97/117 97/117		
			70/82 70/82			78/93 78/93 78/93 80/95			104/125 104/125 104/125 104/125			110/127			147/165 147/165 147/165		
			140/160 140/160			210/260 210/260											

E2 L		E3 N-S-H-V				E3 L		E4 S-H-V			E6 H-V				
1250	1600	800	1000-1250	1600	2000	2500	3200	2000	2500	3200	4000	3200	4000	5000	6300
20	20	20	20	20	20	20	20	15	15	15	15	12	12	12	12
60	60	60	60	60	60	60	60	60	60	60	60	60	60	60	60
4	3	12	12	10	9	8	6	2	1.8	7	5	5	4	3	2
3	2	12	12	10	9	7	5	1.5	1.3	7	4	5	4	2	1.5
20	20	20	20	20	20	20	20	20	20	10	10	10	10	10	10

3 General characteristics

SACE Emax air circuit-breakers with full-size neutral conductor

		E4S/f	E4H/f	E6H/f	
Rated uninterrupted current (at 40 °C) I_u	[A]	4000	3200	4000	
	[A]		4000	5000	
				6300	
Number of poles		4	4	4	
Rated operational voltage U_e	[V ~]	690	690	690	
Rated ultimate short-circuit breaking capacity I_{cu}	220/230/380/400/415 V ~	[kA]	80	100	100
	440 V ~	[kA]	80	100	100
	500/525 V ~	[kA]	75	100	100
	660/690 V ~	[kA]	75	100	100
Rated service short-circuit breaking capacity I_{cs}	220/230/380/400/415 V ~	[kA]	80	100	100
	440 V ~	[kA]	80	100	100
	500/525 V ~	[kA]	75	100	100
	660/690 V ~	[kA]	75	100	100
Rated short-time withstand current I_{cw}	(1s)	[kA]	75	85	100
	(3s)	[kA]	75	75	85
Rated short-circuit making capacity I_{cm}	220/230/380/400/415 V ~	[kA]	176	220	220
	440 V ~	[kA]	176	220	220
	500/525 V ~	[kA]	165	220	220
	660/690 V ~	[kA]	165	220	220
Utilization category (in accordance with IEC 60947-2)		B	B	B	
Isolation behavior (in accordance with IEC 60947-2)		■	■	■	
Overall dimensions					
Fixed: H = 418 mm - D = 302 mm L	[mm]	746	746	1034	
Withdrawable: H = 461 - D = 396.5 mm L	[mm]	774	774	1062	
Weight (circuit-breaker complete with releases and CT, not including accessories)					
Fixed	[kg]	120	120	165	
Withdrawable (including fixed part)	[kg]	170	170	250	

3 General characteristics

3.2 Trip curves

3.2.1 Trip curves of thermomagnetic and magnetic only releases

The overload protection function must not trip the breaker in 2 hours for current values which are lower than 1.05 times the set current, and must trip within 1.3 times the set current. By "cold trip conditions", it is meant that the overload occurs when the circuit-breaker has not reached normal working temperature (no current flows through the circuit-breaker before the anomalous condition occurs); on the contrary "hot trip conditions" refer to the circuit-breaker having reached the normal working temperature with the rated current flowing through, before the overload current occurs. For this reason "cold trip conditions" times are always greater than "hot trip conditions" times.

The protection function against short-circuit is represented in the time-current curve by a vertical line, corresponding to the rated value of the trip threshold I_3 . In accordance with the Standard IEC 60947-2, the real value of this threshold is within the range 0.8- I_3 and 1.2- I_3 . The trip time of this protection varies according to the electrical characteristics of the fault and the presence of other devices; it is not possible to represent the envelope of all the possible situations in a sufficiently clear way in this curve; therefore it is better to use a single straight line, parallel to the current axis. All the information relevant to this trip area and useful for the sizing and coordination of the plant are represented in the limitation curve and in the curves for the specific let-through energy of the circuit-breaker under short-circuit conditions.

3 General characteristics

Trip curve
thermomagnetic
release

T1 160

TMD

$I_n = 16 \div 63 \text{ A}$

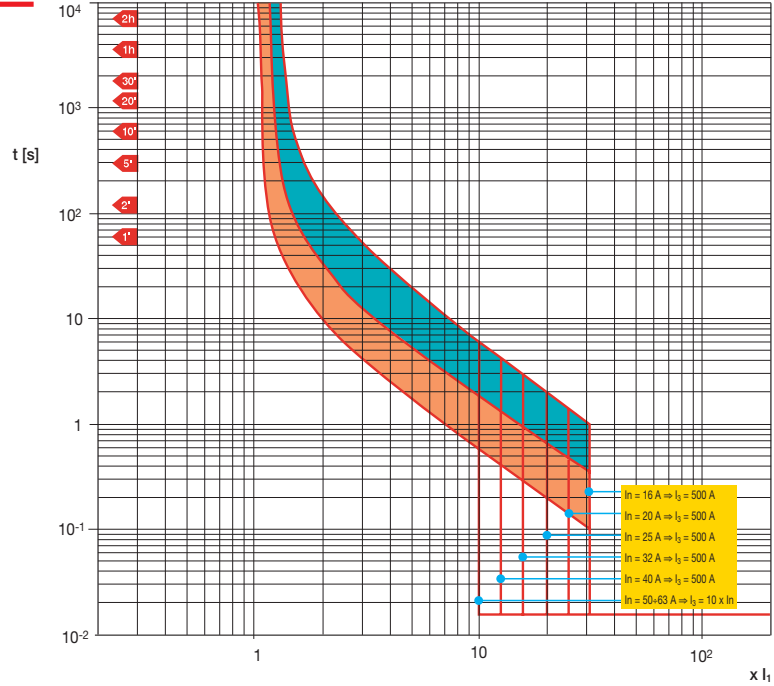

3 General characteristics

Trip curve
thermomagnetic
release

T1 160

TMD

$I_n = 80 \div 160 \text{ A}$

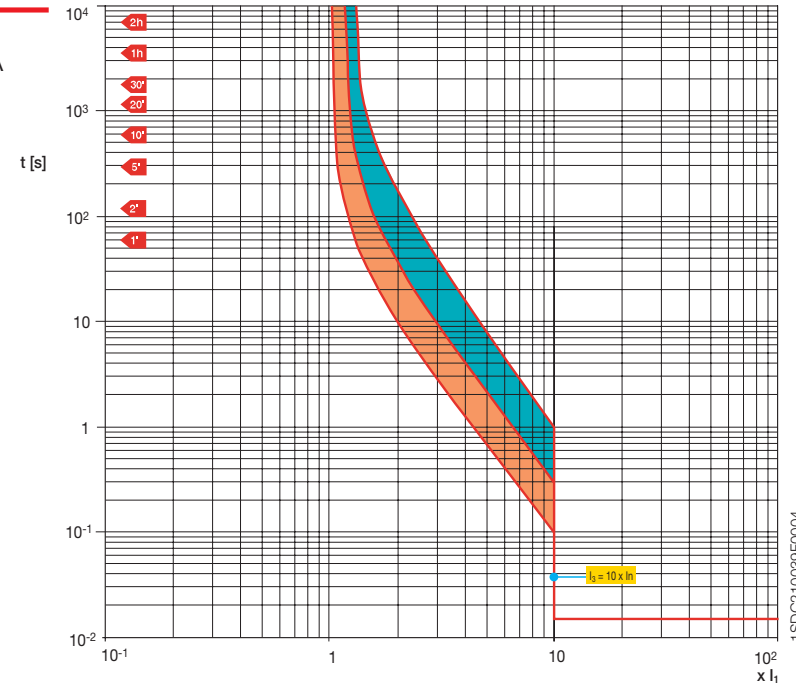

1SDC210039F0004

3 General characteristics

Trip curve
thermomagnetic
release

T2 160

MF

$I_3 = 13 \times I_n$

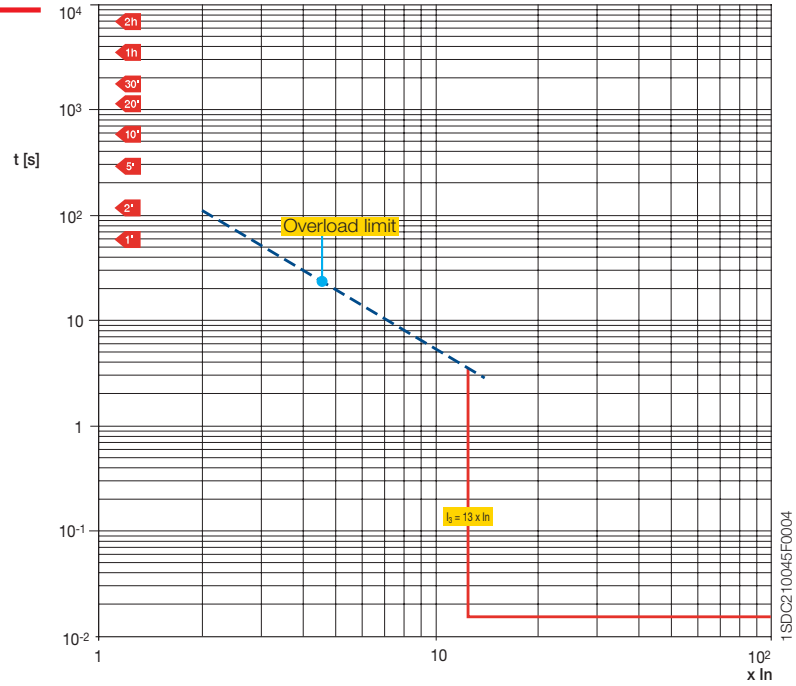

3 General characteristics

Trip curve
thermomagnetic
release

T2 160

TMD

$I_n = 1.6 \div 100 \text{ A}$

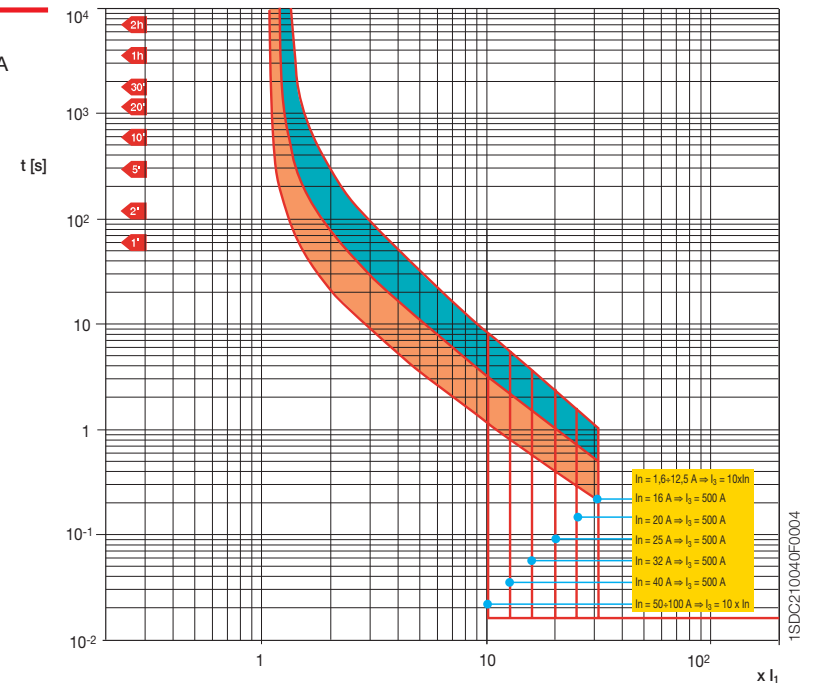

3 General characteristics

Trip curve
thermomagnetic
release

T2 160

TMD

$I_n = 125 \pm 160 \text{ A}$

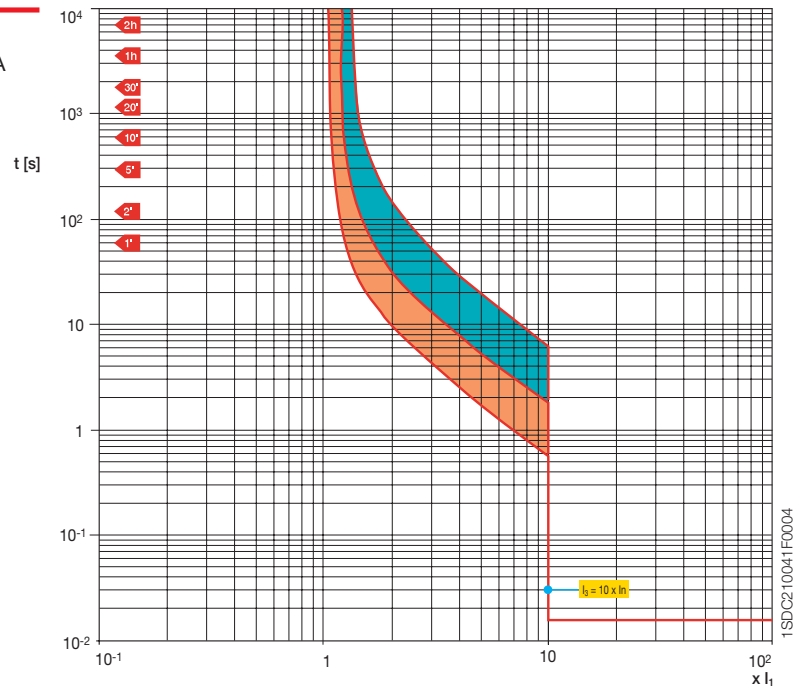

3 General characteristics

Trip curve
thermomagnetic
release

T2 160/T3 250

MA

$I_3 = 6 \dots 12 \times I_n$

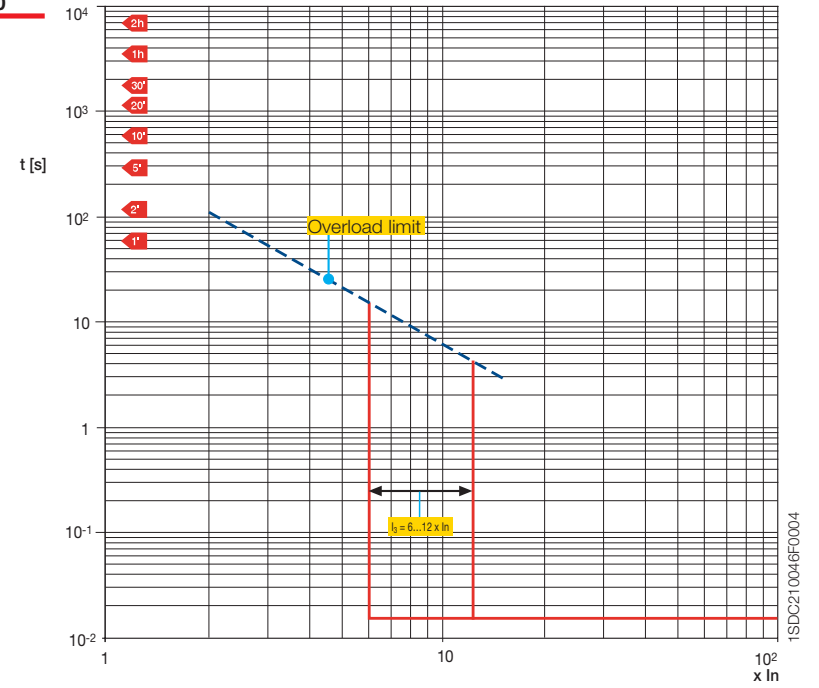

3 General characteristics

Trip curve
thermomagnetic
release

T3 250

TMD

$I_n = 63\div 250\text{ A}$

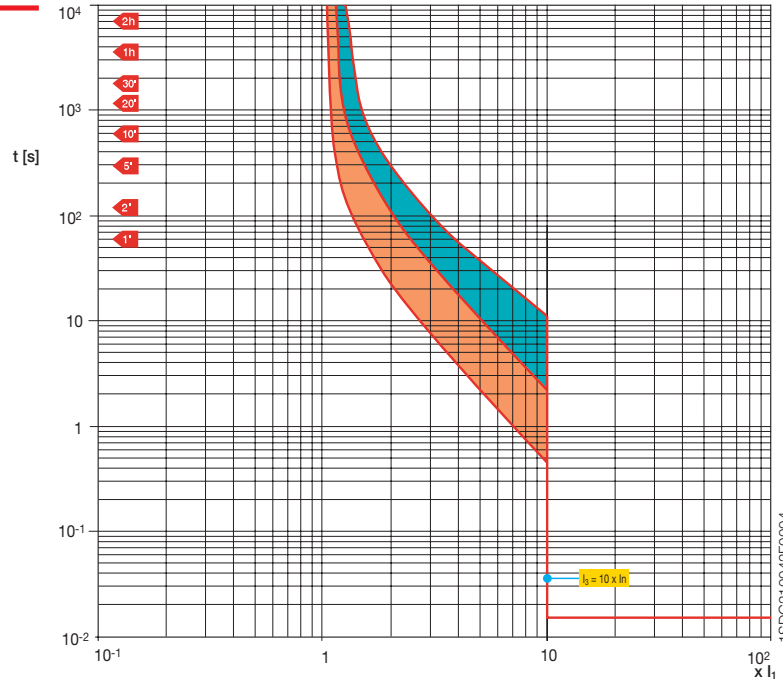

3 General characteristics

Trip curve
thermomagnetic
release

T3 250

TMG

$I_n = 63\div 250\text{ A}$

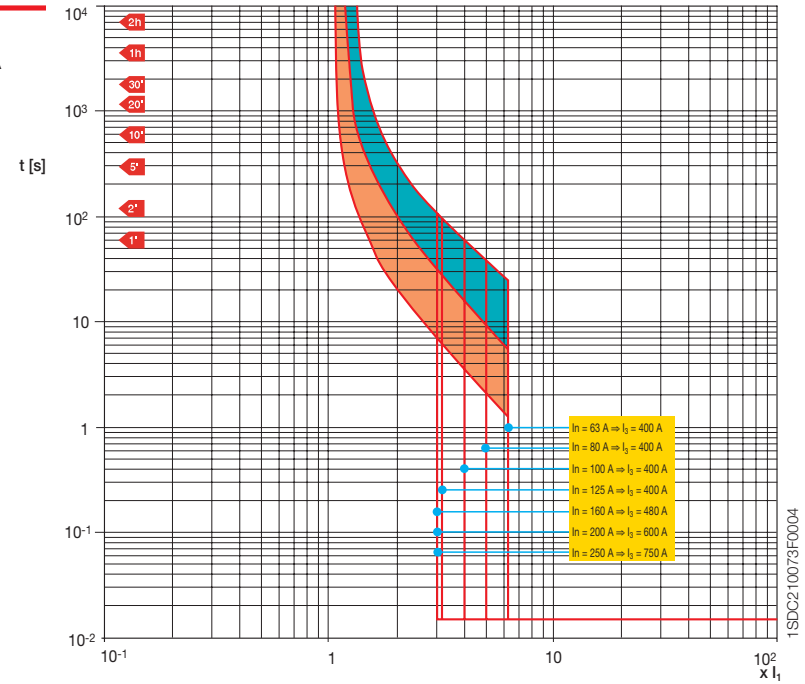

3 General characteristics

Trip curve
thermomagnetic
release

T4 250

MA

$$I_3 = 6 \dots 14 \times I_n$$

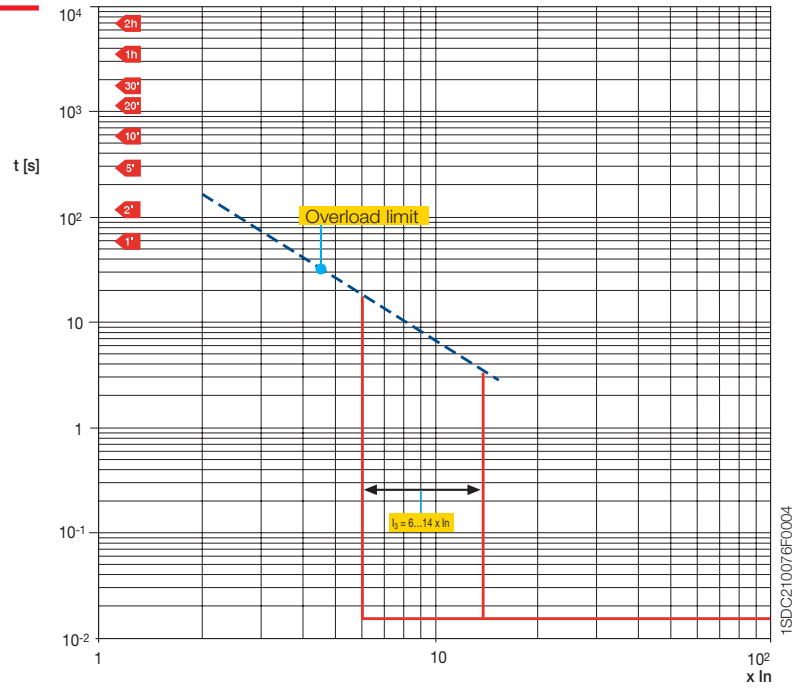

1SDC210076F0004

3 General characteristics

Trip curve
thermomagnetic
release

T4 250

TMD

$$I_n = 20 \div 50 \text{ A}$$

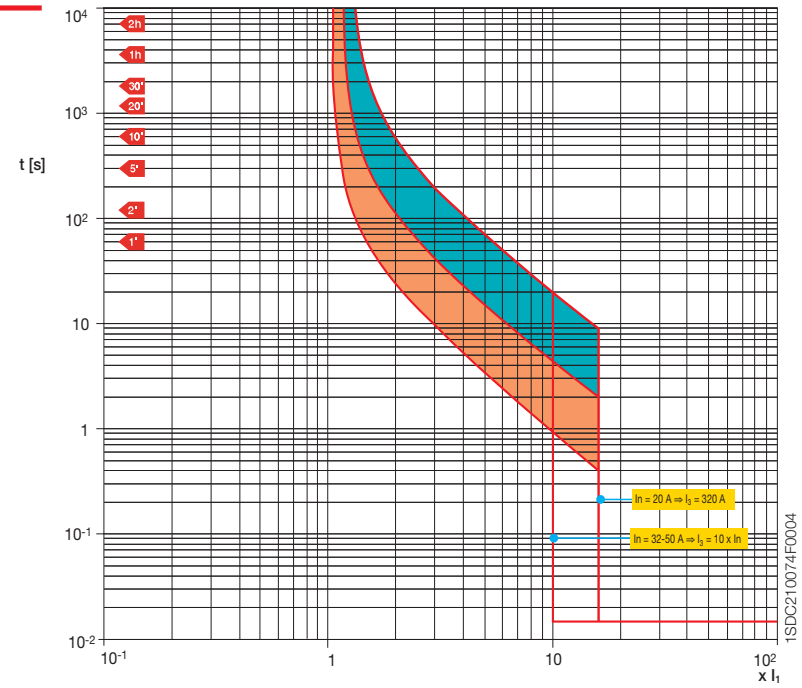

1SDC210074F0004

3 General characteristics

Trip curve
thermomagnetic
release

T4 250/320

TMA

$I_n = 80 \div 250 \text{ A}$

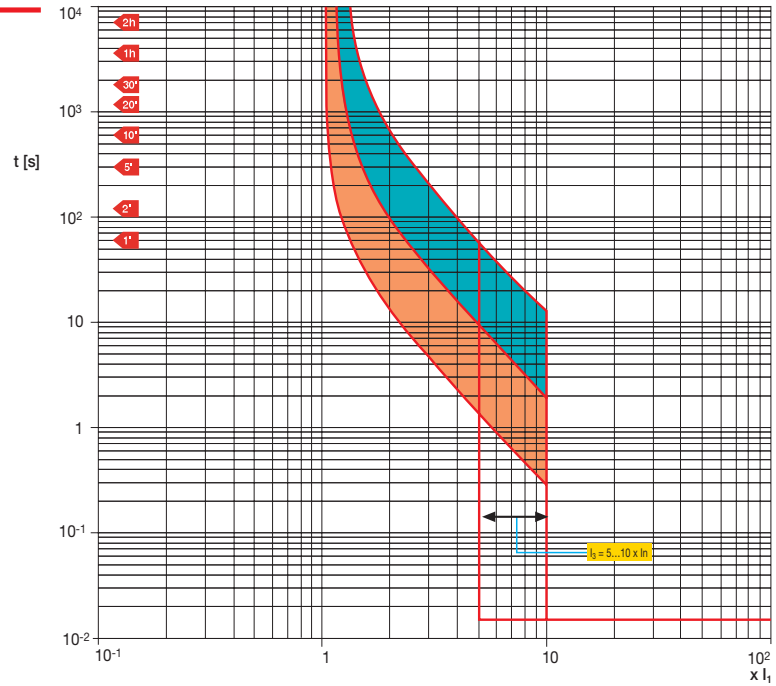

1SDC210033F0004

3 General characteristics

Trip curve
thermomagnetic
release

T5 400/630

TMA

$I_n = 320 \div 500 \text{ A}$

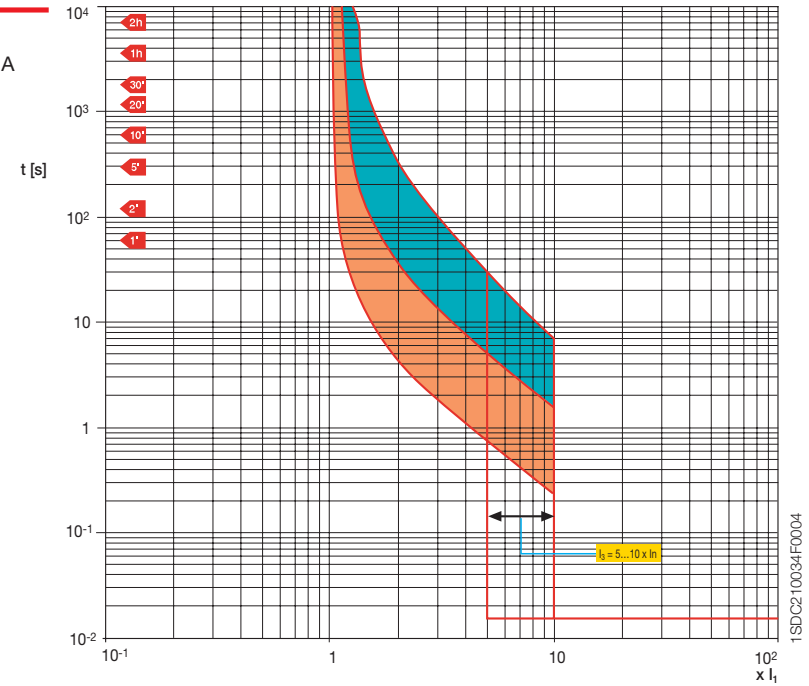

1SDC210034F0004

3 General characteristics

Trip curve
thermomagnetic
release

T5 400/630

TMG

$I_n = 320 \div 500 \text{ A}$

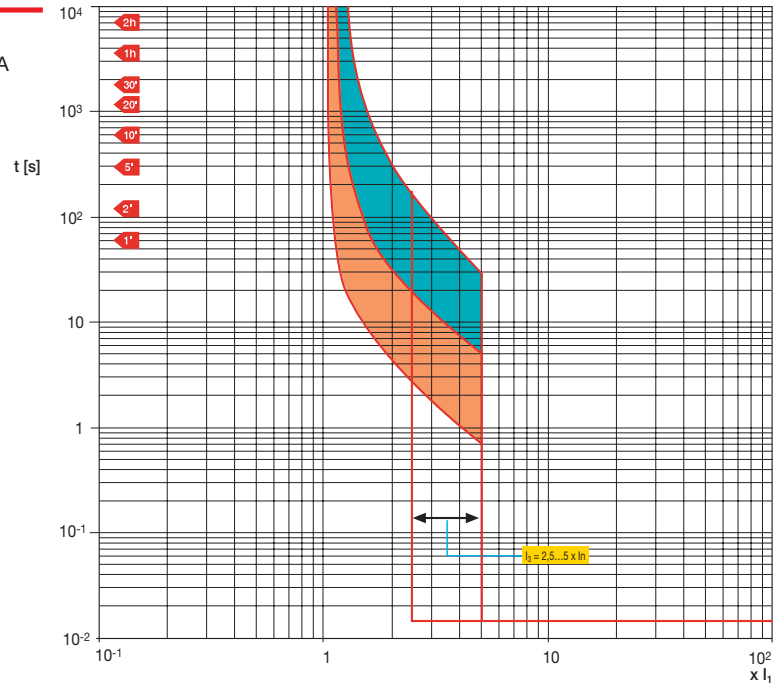

3 General characteristics

Trip curve
thermomagnetic
release

T6 630

TMA

$I_n = 630 \text{ A}$

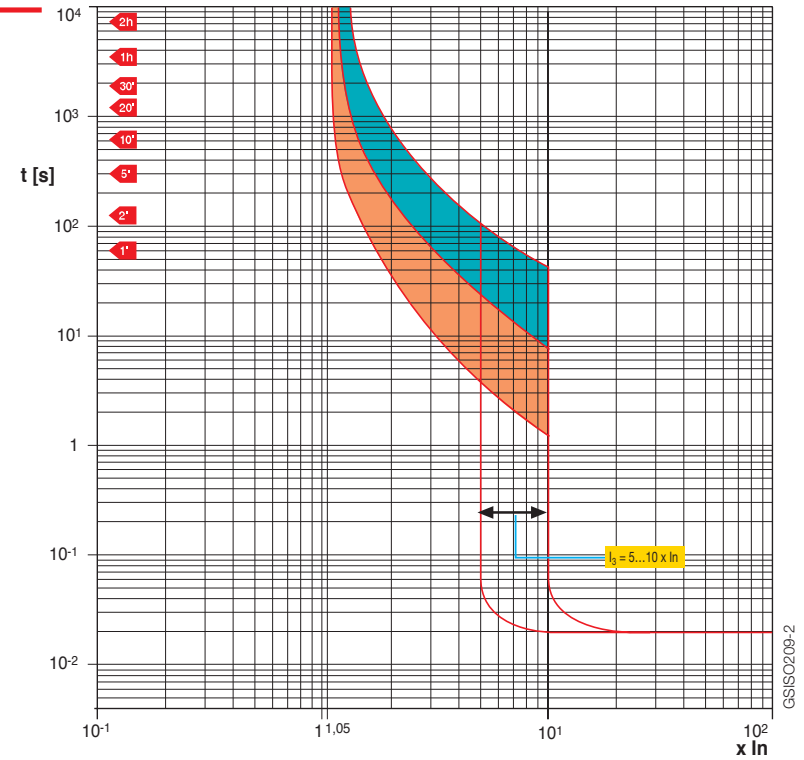

3 General characteristics

Trip curve
thermomagnetic
release

T6 800

TMA

$I_n = 800 \text{ A}$

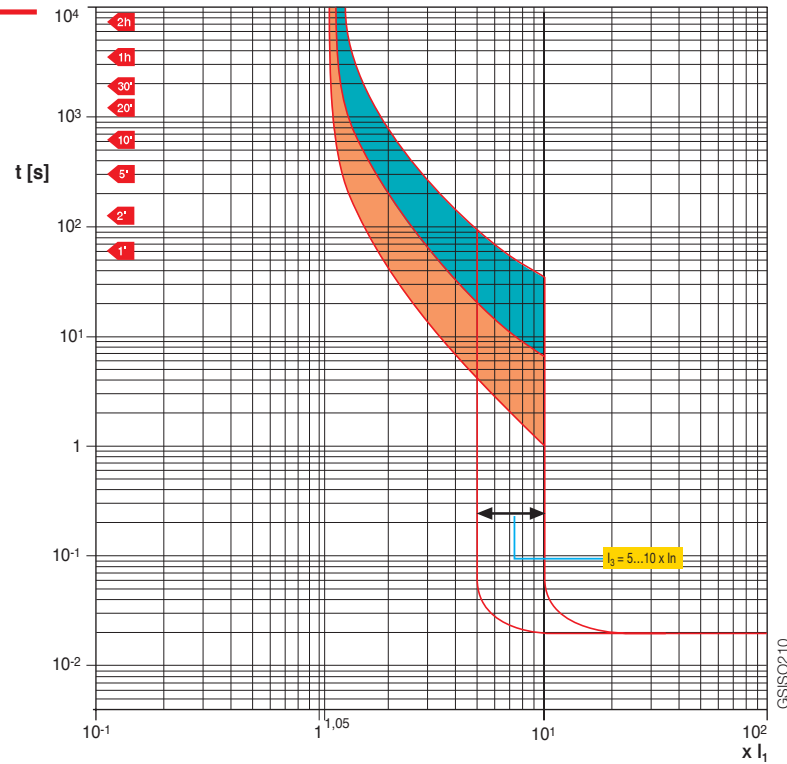

GSIS0210

3 General characteristics

Example of thermomagnetic release setting

Consider a circuit-breaker type T1 160 In 160 and select, using the trimmer for thermal regulation, the current threshold, for example at 144 A; the magnetic trip threshold, fixed at $10 \cdot I_n$, is equal to 1600 A.

Note that, according to the conditions under which the overload occurs, that is either with the circuit-breaker at full working temperature or not, the trip of the thermal release varies considerably. For example, for an overload current of 600 A, the trip time is between 1.2 and 3.8 s for hot trip, and between 3.8 and 14.8 s for cold trip.

For fault current values higher than 1600 A, the circuit-breaker trips instantaneously through magnetic protection.

T1 160 - In 160 Time-Current curves

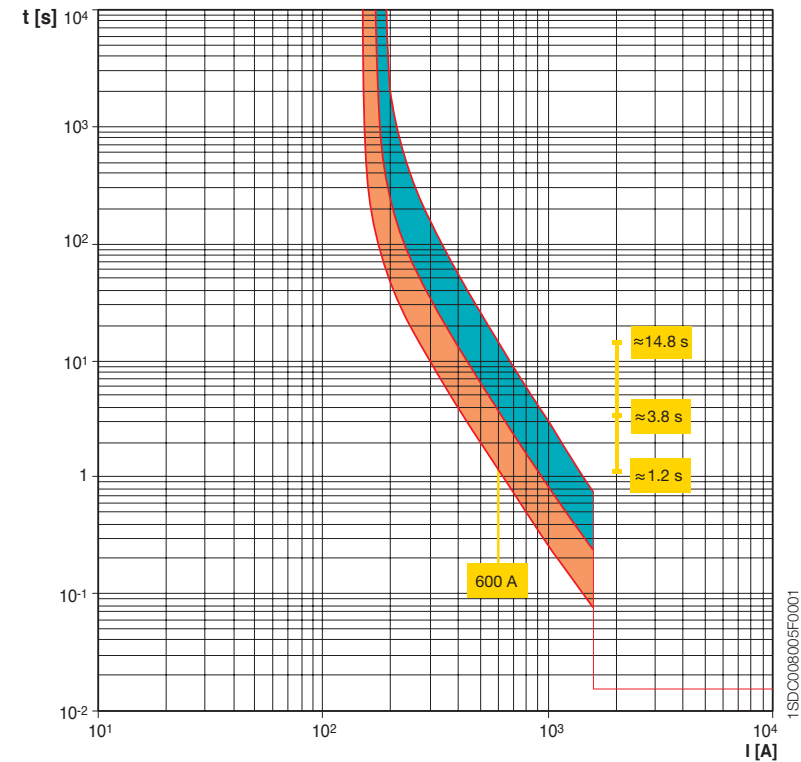

1SPD008005F0001

3 General characteristics

3.2.2 Trip curves of electronic releases

Introduction

The following figures show the curves of the single protection functions available in the electronic releases. The setting ranges and resolution are referred to setting operations to be carried out locally.

L FUNCTION (overload protection)

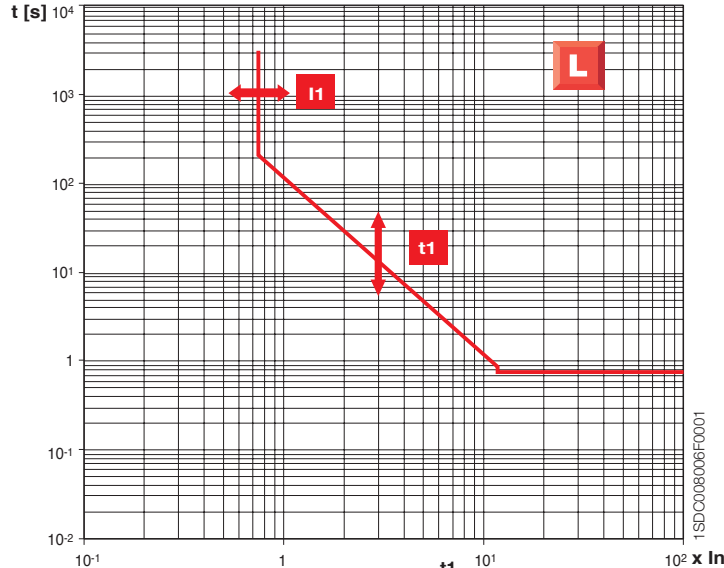

	I1	t1
PR221	(0.4 - 0.44 - 0.48 - 0.52 - 0.56 - 0.6 - 0.64 - 0.68 - 0.72 - 0.76 - 0.8 - 0.84 - 0.88 - 0.92 - 0.96 - 1) x In	3s - 6s (@ 6 x I1) for T2 3s - 12s (@ 6 x I1) for T4, T5, T6
PR222	(0.4...1) x In with step 0.02 x In	3s - 6s - 9s - 18 ⁽¹⁾ s (@ 6xI1)
PR223	(0.18...1) x In with step 0.01 x In	3...18s ⁽¹⁾ (@ 6xI1)
PR211	(0.4 - 0.5 - 0.6 - 0.7 - 0.8 - 0.9 - 0.95 - 1) x In	A= 3s; B= 6s; C= 12s; D= 18s (@ 6 x I1)
PR212	(0.4 - 0.5 - 0.55 - 0.6 - 0.65 - 0.7 - 0.75 - 0.8 - 0.85 - 0.875 - 0.9 - 0.925 - 0.95 - 0.975 - 1) x In	A= 3s; B= 6s; C= 12s; D= 18s (@ 6 x I1)
PR121	(0.4 - 0.425 - 0.45 - 0.475 - 0.5 - 0.525 - 0.55 - 0.575 - 0.6 - 0.625 - 0.65 - 0.675 - 0.7 - 0.725 - 0.75 - 0.775 - 0.8 - 0.825 - 0.85 - 0.875 - 0.9 - 0.925 - 0.95 - 0.975) x In	3 - 12 - 24 - 36 - 48 - 72 - 108 - 144 s ⁽²⁾ (@ 3 x I1)
PR122	(0.4 ... 1) x In with step 0.01 x In	3 ... 144s with step 3s (@ 3 x I1)
PR123		

⁽¹⁾ for T4 In = 320 A and T5 In = 630 A → t1 = 12s.

Here below the tolerances:

	I1	t1
PR221 ⁽³⁾	1.1+1.3 x I1	± 10 % (up to 6 x In) ± 20 % (over 6 x In)
PR222	1.1+1.3 x I1	± 10 %
PR223	1.1+1.3 x I1	± 10 %
PR221 ⁽⁴⁾	1.05+1.3 x I1	± 10 % (up to 2 x In) ± 20 % (over 2 x In)
PR211		
PR212		
PR121	1.05+1.2 x I1	± 10 % (up to 4 x In) ± 20 % (over 4 x In)
PR121		
PR122		

⁽¹⁾ For T4 In=320A and T5 In=630A → t1=12s, ⁽²⁾ The minimum trip values is 1 s, regardless of type of curve set (self protection), ⁽³⁾ For T4-T5-T6, ⁽⁴⁾ For T2.

3 General characteristics

S FUNCTION (short-circuit protection with time delay)

(I²=k, t=k)

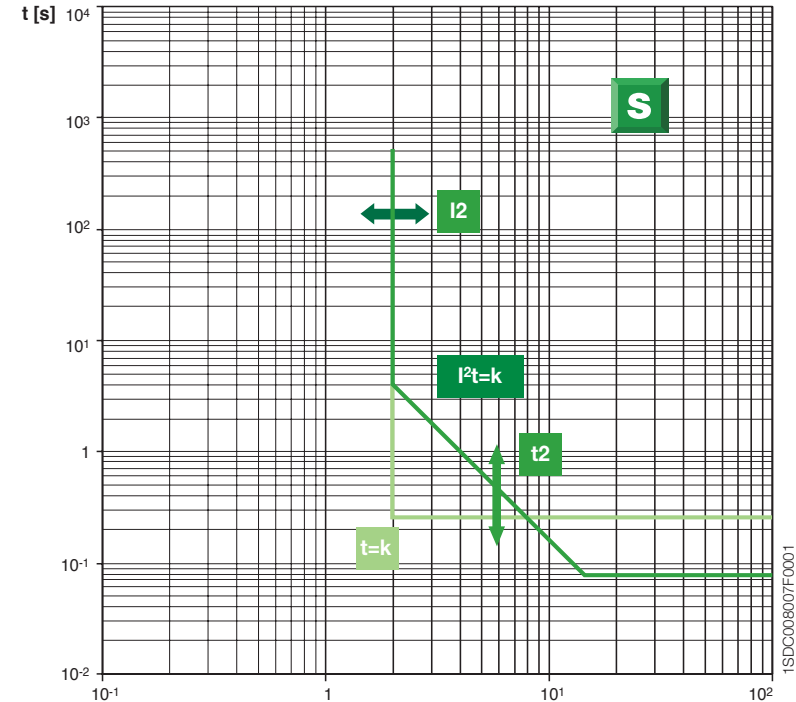

	I2	t2
PR221	(1 - 1.5 - 2 - 2.5 - 3 - 3.5 - 4.5 - 5.5 - 6.5 - 7 - 7.5 - 8 - 8.5 - 9 - 10 - OFF) x In	0.1s - 0.25s (@ 8 x I2)
PR222	0.6...10 x In with step 0.1 x In	0.05s - 0.1s - 0.25s - 0.5s (@ 8 x In)
PR223	(0.6...10-OFF) x In with step 0.1 x In	0.05s - 0.5s (@ 8 x In)
PR211	(1 - 2 - 3 - 4 - 6 - 8 - 10 - OFF) x In	A= 0.05s; B= 0.1s; C= 0.25s; D= 0.5s (@ 8 x I2)
PR212		
PR121	(1 - 1.5 - 2 - 2.5 - 3 - 3.5 - 4.5 - 5.5 - 6.5 - 7 - 7.5 - 8 - 8.5 - 9 - 10 - OFF) x In	0.1-0.2-0.3-0.4-0.5-0.6-0.7-0.8s (@>I2 with t=k) 0.1-0.2-0.3-0.4-0.5-0.6-0.7-0.8s (@10xIn with I2 t=k)
PR122	(0.6 ... 10 - OFF) x In with step 0.1 x In	0.05...0.8s with step 0.01s (@>I2 with t=k) 0.05...0.8s with step 0.01s (@10xIn with I2 t=k)
PR123 ⁽²⁾		

Here below the tolerances:

	I2	t2
PR221	± 10 % (T4-T5-T6) ± 10 % (up to 2 x In) (T2) ± 20 % (over 2 x In) (T2)	± 10 % up to 6 x In (T4-T5-T6) ± 20 % over to 6 x In (T4-T5-T6) ± 20 % (T2)
PR222	± 10 %	± 10% ⁽¹⁾
PR223		
PR211	± 10 %	± 20 %
PR212		
PR121	± 7 % (up to 4 x In) ± 10 % (over 4 x In)	the better of the two figures: ± 10 % or ± 40 ms (t=k)
PR122		± 15 % (up to 4 x In, with I ² =k)
PR123		± 20 % (over 4 x In, with I ² =k)

⁽²⁾ Settings valid for function S₃ too.

3 General characteristics

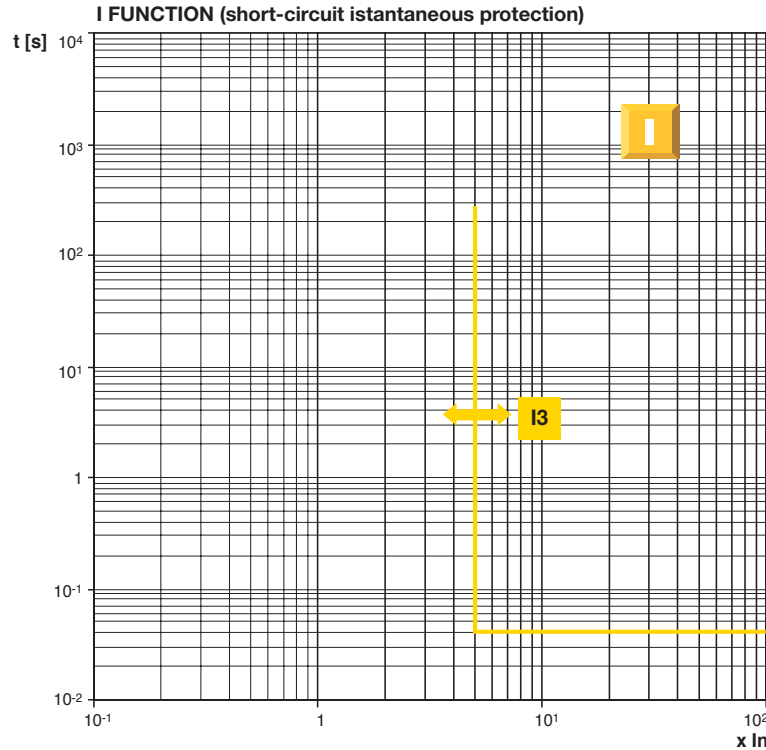

	I3
PR221	(1 - 1.5 - 2 - 2.5 - 3 - 3.5 - 4.5 - 5.5 - 6.5 - 7 - 7.5 - 8 - 8.5 - 9 - 10 - OFF) x In
PR222	(1.5 - 2.5 - 3 - 4 - 3.5 - 4.5 - 5 - 5.5 - 6.5 - 7 - 7.5 - 8 - 9 - 9.5 - 10.5 - 12 - OFF) x In ⁽¹⁾
PR223	(1.5 ... 12 - OFF) x In ⁽¹⁾ with step 0.1 x In
PR211 PR212	(1.5 - 2 - 4 - 6 - 8 - 10 - 12 - OFF) x In
PR121	(1.5 - 2 - 3 - 4 - 5 - 6 - 7 - 8 - 9 - 10 - 11 - 12 - 13 - 14 - 15 OFF) x In
PR122 PR123	(1.5 ... 15 - OFF) x In with step 0.1 x In

⁽¹⁾ for T4 In = 320 A and T5 In = 630 A → I3 max = 10 x In

Here below the tolerances:

	I3	Tripping time:
PR221	± 10 % (T4-T5-T6) ± 20 % (T2)	≤ 25 ms
PR222 PR223	± 10 %	≤ 25 ms
PR211 PR212	± 20 %	≤ 25 ms
PR121 PR122 PR123	± 10 %	≤ 30 ms

The given tolerances are valid only if the release is self-supplied in steady state condition with two-phase or three-phase power supply.

3 General characteristics

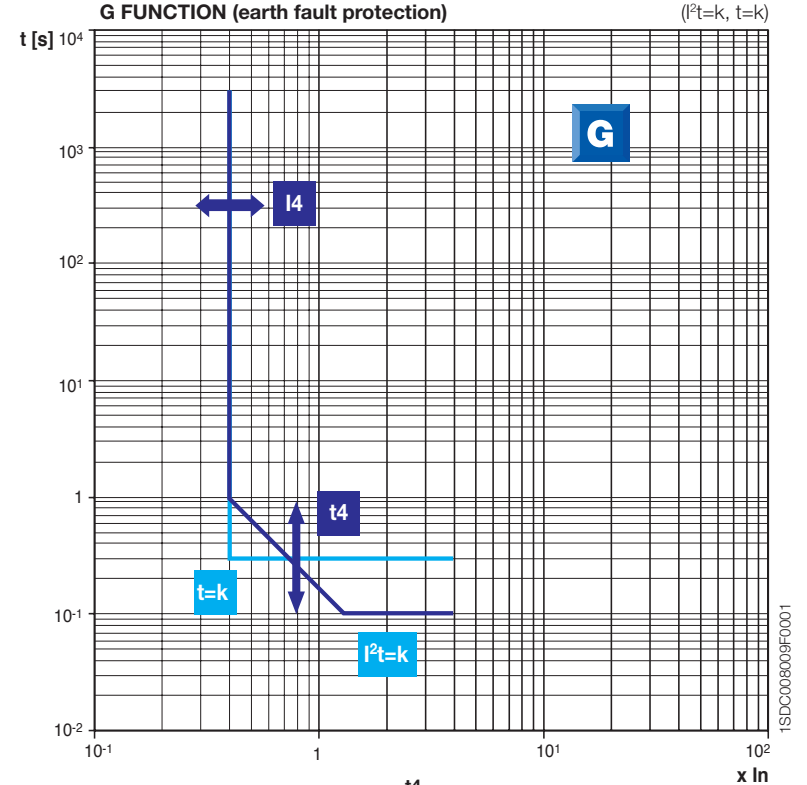

	I4	t4
PR222	(0.2 - 0.25 - 0.45 - 0.55 - 0.75 - 0.8 - 1 - OFF) x In	0.1s up to 3.15xI4; 0.2s up to 2.25xI4 0.4s up to 1.6xI4; 0.8s up to 1.10xI4
PR212	(0.2 - 0.3 - 0.4 - 0.6 - 0.8 - 0.9 - 1 - OFF) x In	A= 0.1s; B= 0.2s; C= 0.4s; D= 0.8s (@ 4 x I4)
PR223	(0.2...1 - OFF) x In with step 0.01 x In	0.1...0.8s with step 0.01s
PR121	(0.2 - 0.3 - 0.4 - 0.6 - 0.8 - 0.9 - 1 - OFF) x In	t4= 0.1 - 0.2 - 0.4 - 0.8 s (@ 4 x I4, with I ² t=k) t4= 0.1 - 0.2 - 0.4 - 0.8 s (@ I > I4, with t=k)
PR122 PR123	(0.2...1 - OFF) x In with step 0.02 x In	t4= 0.1...1 s with step 0.05 (@ 4 x I4, with I ² t=k) t4= 0.1...1 s with step 0.05 (@ I > I4, with t=k)

Here below the tolerances:

	I4	t4
PR222 PR223	± 10 %	± 20 %
PR212	± 20 %	± 20 %
PR121 PR122 PR123	± 7 %	± 15 % (I ² t=k) the better of the two figures: ± 10 % or ± 40 ms (t=k)

3 General characteristics

Trip curve
electronic releases

T2 160
PR221DS

L-S Functions

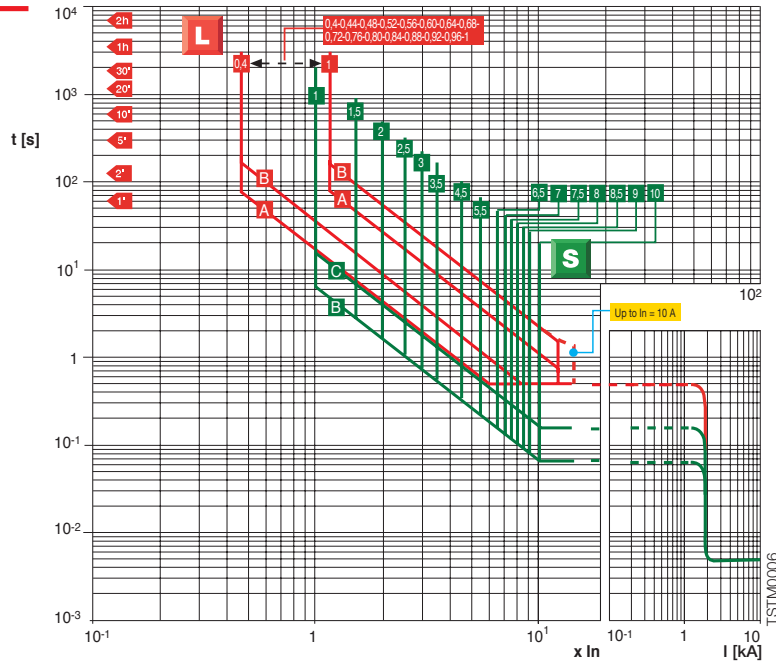

TSTM0006

3 General characteristics

Trip curve
electronic releases

T2 160
PR221DS

L-I Functions

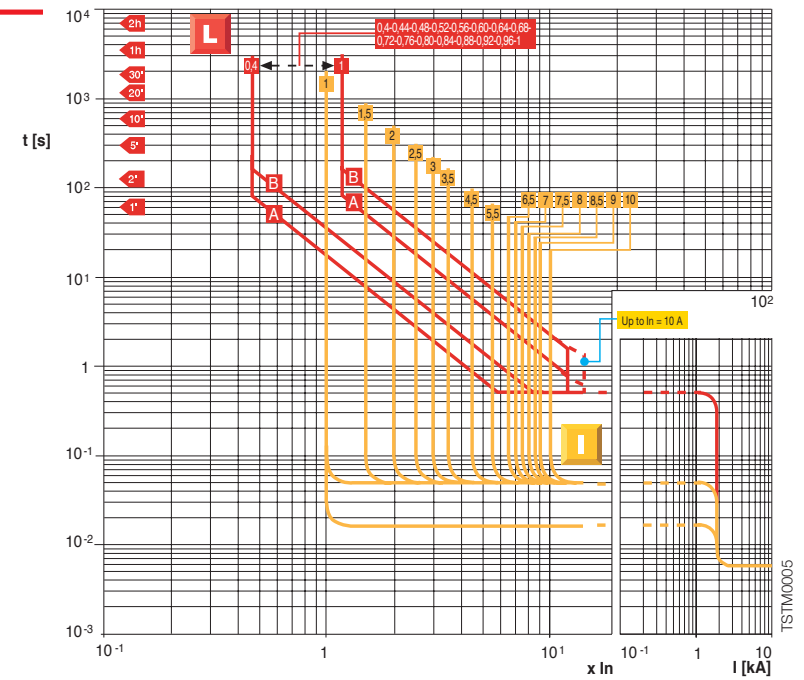

TSTM0005

3 General characteristics

Trip curve
electronic releases

T4 250/320
T5 400/630
T6 630/800/1000
PR221DS

L-I Functions

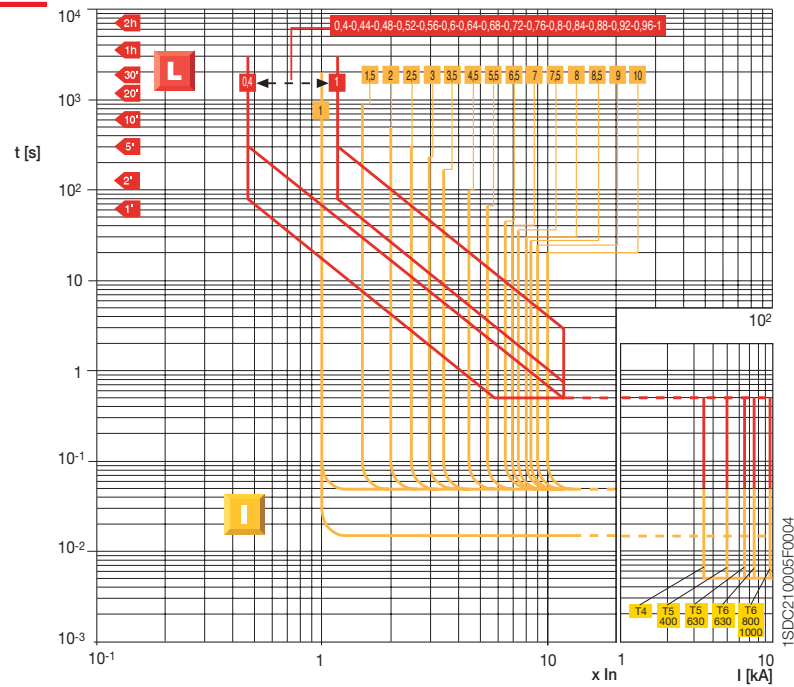

3 General characteristics

Trip curve
electronic releases

T4 250/320
T5 400/630
T6 630/800/1000
PR221DS

L-S Functions

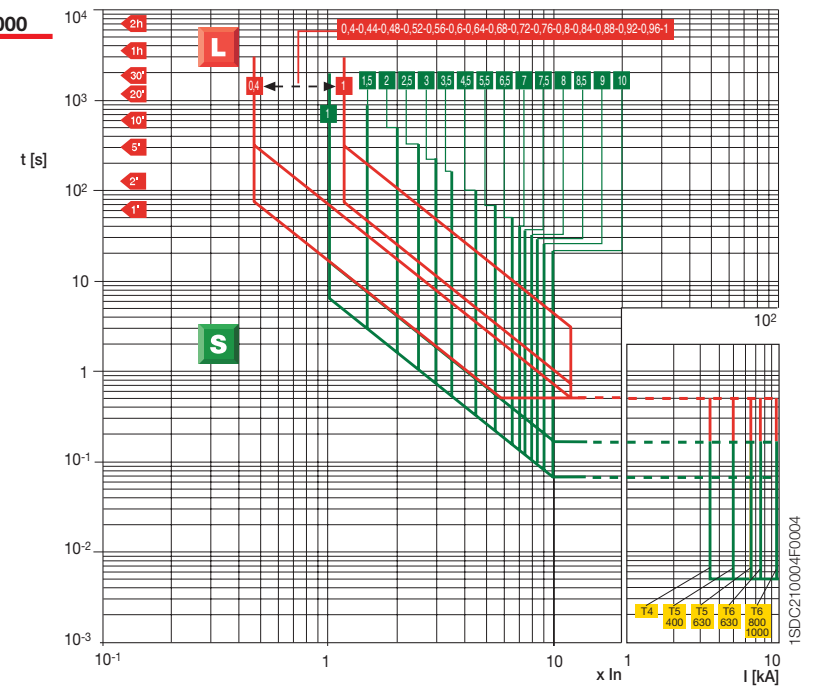

3 General characteristics

Trip curve
electronic releases

T4 250/320
T5 400/630
T6 630/800/1000

PR222DS/P
PR222DS/PD
PR223DS
PR223EF*

*without Vaux

L-S-I Functions
(I²t const = ON)

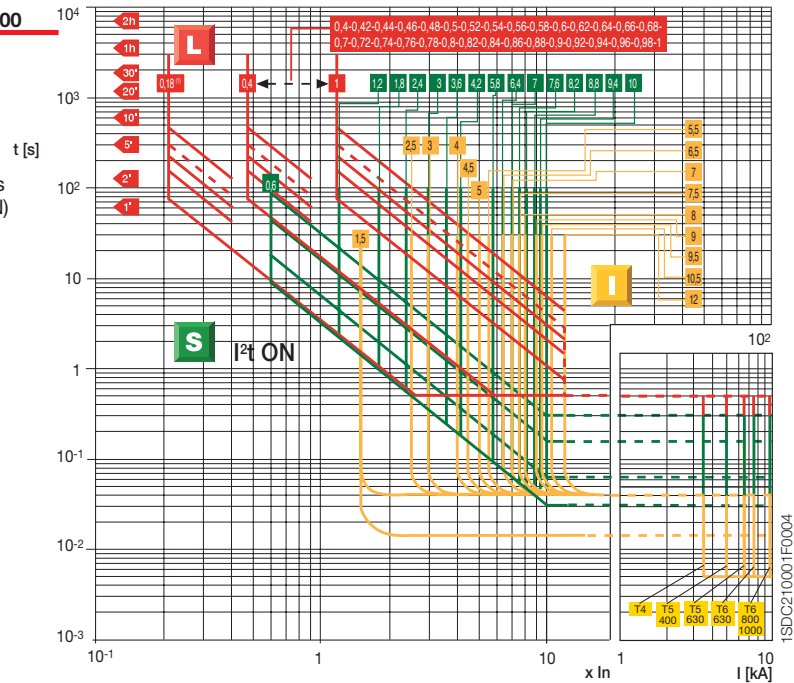

Note:

The dotted curve of function L corresponds to the maximum delay (t_1) which can be set at $6xI_n$, in the case where 320 A CTs are used for T4 and 630 A for T5. For all the CT sizes $t_1=18s$, except with 320 A CT (T4) and 630 A (T5) where $t_1=12s$. For T4 $I_n = 320$ A, T5 $I_n = 630$ A and T6 $I_n = 1000$ A $\Rightarrow I_3 \text{ max} = 10 \times I_n$. For PR223DS and PR223EF the electronic settings only are available.

(1) For PR223DS and PR223EF only.

3 General characteristics

Trip curve
electronic releases

T4 250/320
T5 400/630
T6 630/800/1000

PR222DS/P
PR222DS/PD
PR223DS
PR223EF*

*without Vaux

L-S-I Functions
(I²t const = OFF)

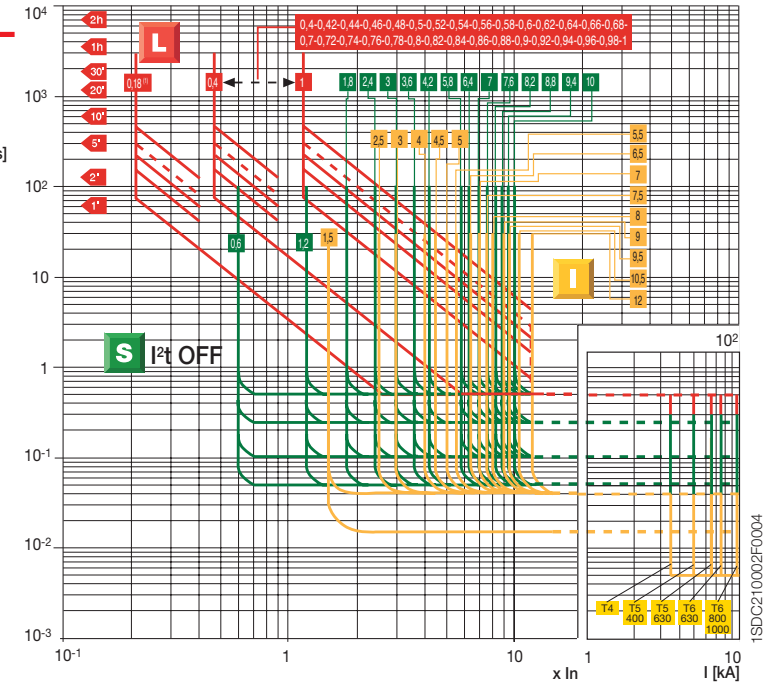

Note:

The dotted curve of function L corresponds to the maximum delay (t_1) which can be set at $6xI_n$, in the case where 320 A CTs are used for T4 and 630 A for T5. For all the CT sizes $t_1=18s$, except with 320 A CT (T4) and 630 A (T5) where $t_1=12s$. For T4 $I_n = 320$ A, T5 $I_n = 630$ A and T6 $I_n = 1000$ A $\Rightarrow I_3 \text{ max} = 10 \times I_n$. For PR223DS and PR223EF the electronic settings only are available.

(1) For PR223DS and PR223EF only.

3 General characteristics

Trip curve
electronic releases

- T4 250/320
- T5 400/630
- T6 630/800/1000**
- PR222DS/P
- PR222DS/PD
- PR223DS
- PR223EF

G Function

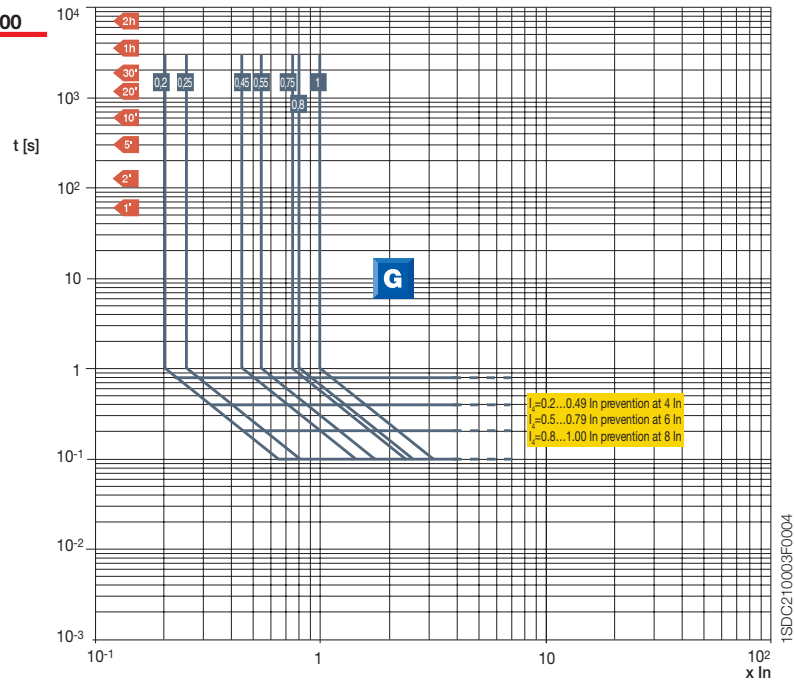

Note:

For PR223DS and PR223EF the electronic settings only are available.

3 General characteristics

Trip curve
electronic releases

- T4L 250/320
- T5L 400/630
- T6L 630/800/1000**
- PR223EF

with Vaux

L-S-EF Functions

(I²t const = ON)

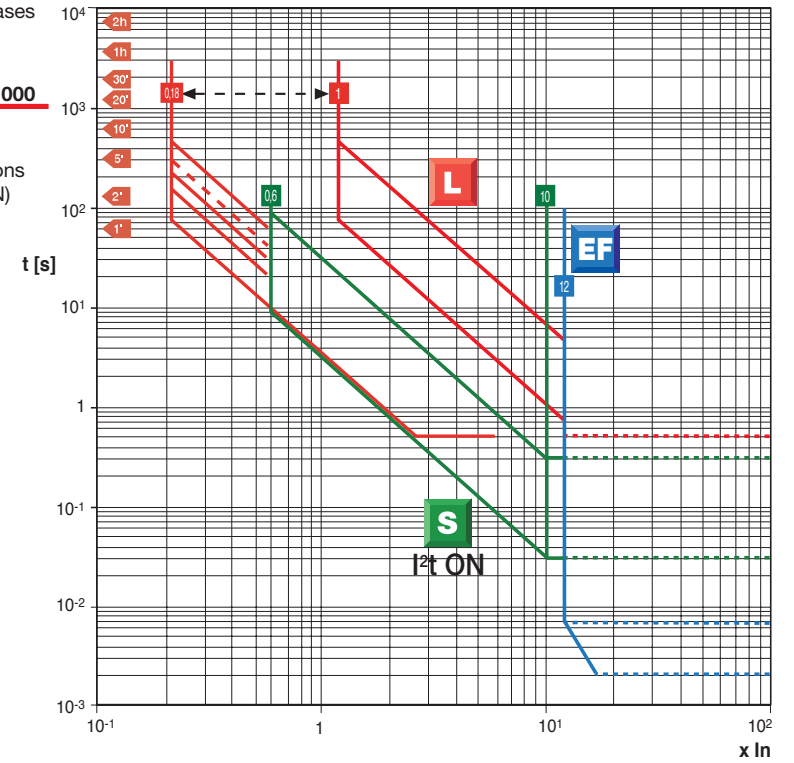

Note:

For all the CT sizes the maximum delay t_1 is equal to 18s, except for 320 A CT (T4) and 630 A (T5) where $t_1=12s$.

For T4 In = 320 A, T5 In = 630 A and T6 In = 630 A $\Rightarrow I_3 \text{ max} = 10 \times I_n$.

Only the electronic settings are available.

3 General characteristics

Trip curve
electronic releases
T4L 250/320
T5L 400/630
T6L 630/800/1000
PR223EF
with Vaux
L-S-EF Functions
(I²t const = OFF)

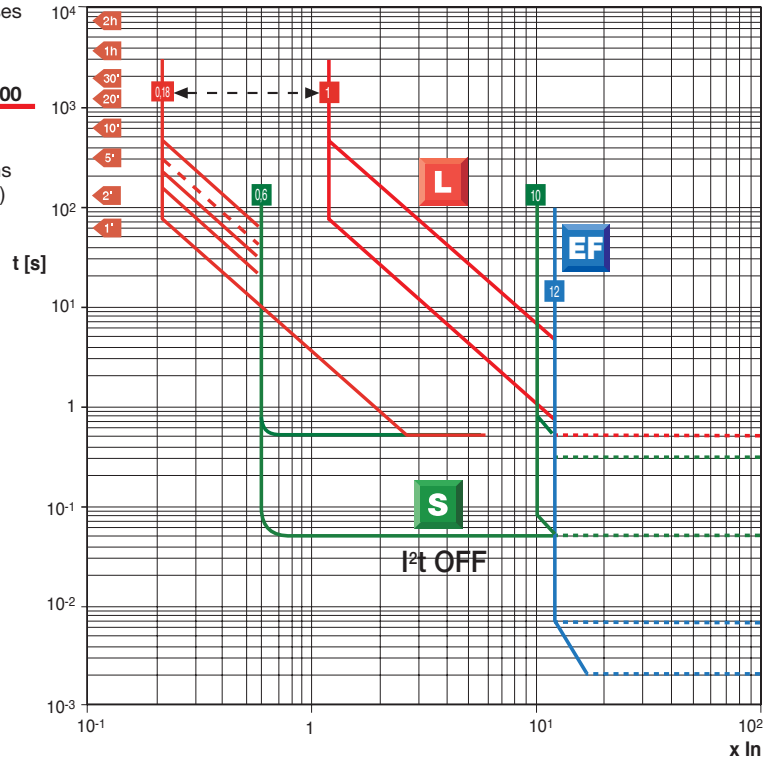

Note:
For all the CT sizes the maximum delay t_1 is equal to 18s, except for 320 A CT (T4) and 630 A (T5) where $t_1=12s$.
For T4 In = 320 A, T5 In = 630 A and T6 In = 630 A $\Rightarrow I_3 \text{ max} = 10 \times I_n$.
Only the electronic settings are available.

3 General characteristics

Trip curve
electronic releases
T2 160
PR221DS-I
I Function

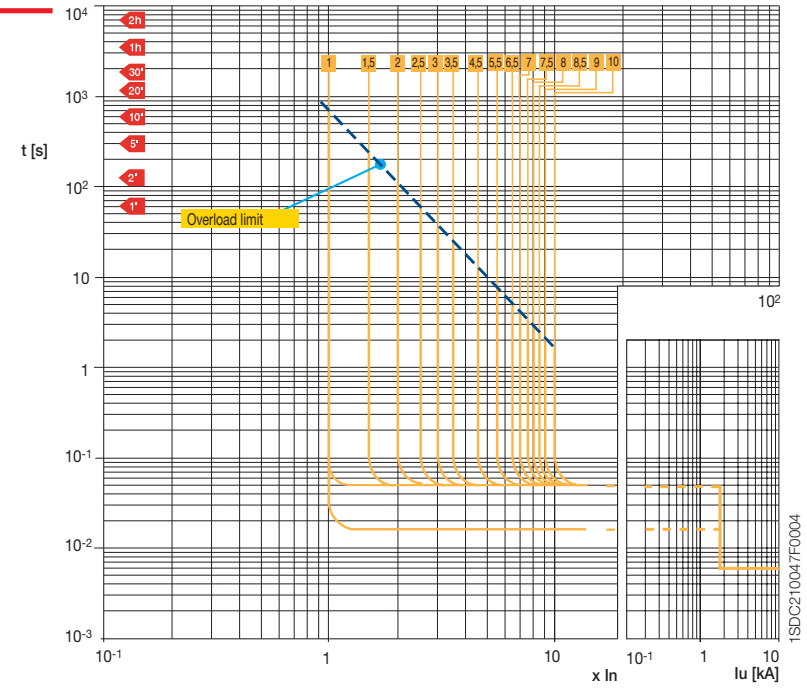

1SDC210047F0004

3 General characteristics

Trip curve
electronic releases

T4 250/320
T5 400/630
T6 630/800/1000
PR221DS-I

I Function

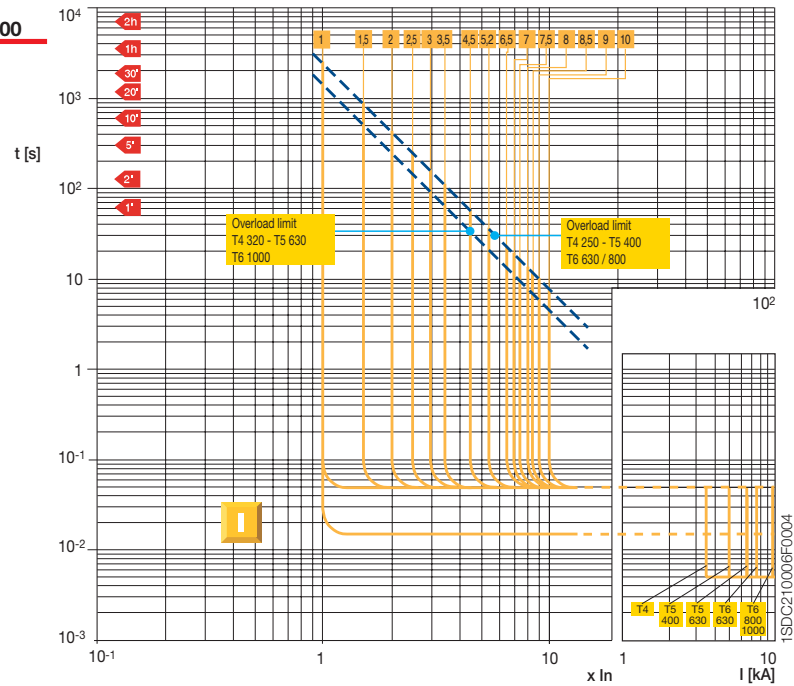

3 General characteristics

Trip curve
electronic releases

T4 250
T5 400
T6 800
PR222MP

L Function
(hot and cold trip)

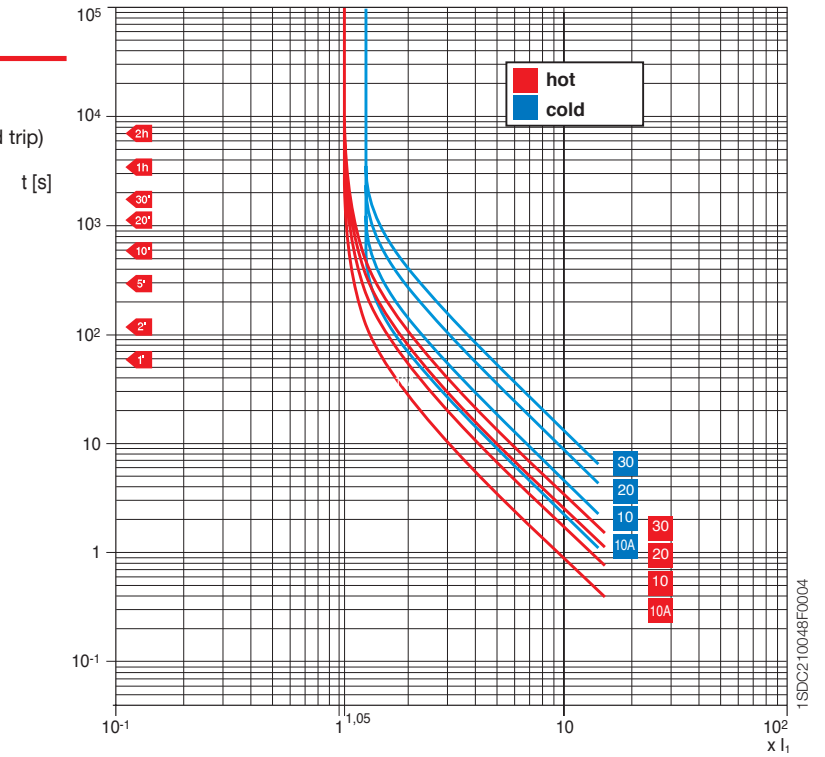

	I1	t1
PR222MP	(0.4 + 1) x In with step 0.01 x In	4 – 8 – 16 – 24 s

Here the tolerances

	I1	t1
PR222MP	According to IEC 60947-4-1	According to IEC 60947-4-1

3 General characteristics

Trip curve
electronic releases

T4 250
T5 400
T6 800
PR222MP

L Function
(hot trip with 1 or 2
phases supplied)

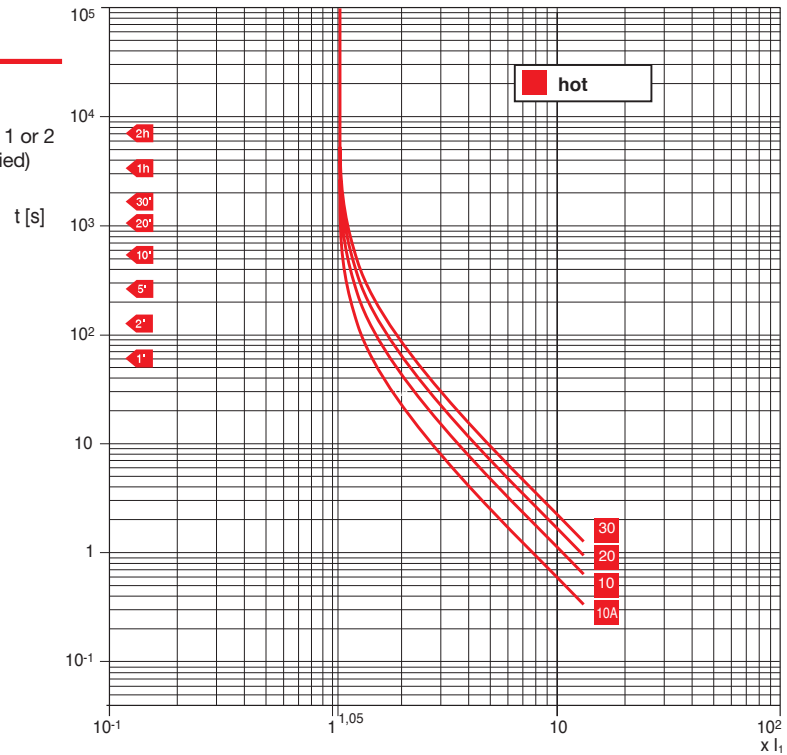

1SDC210049F0004

	I1	t1
PR222MP	(0.4 + 1) x I _n with step 0.01 x I _n	4 - 8 - 16 - 24 s

Here the tolerances

	I1	t1
PR222MP	±15%	±15%

3 General characteristics

Trip curve
electronic releases

T4 250
T5 400
T6 800
PR222MP

R-U Functions

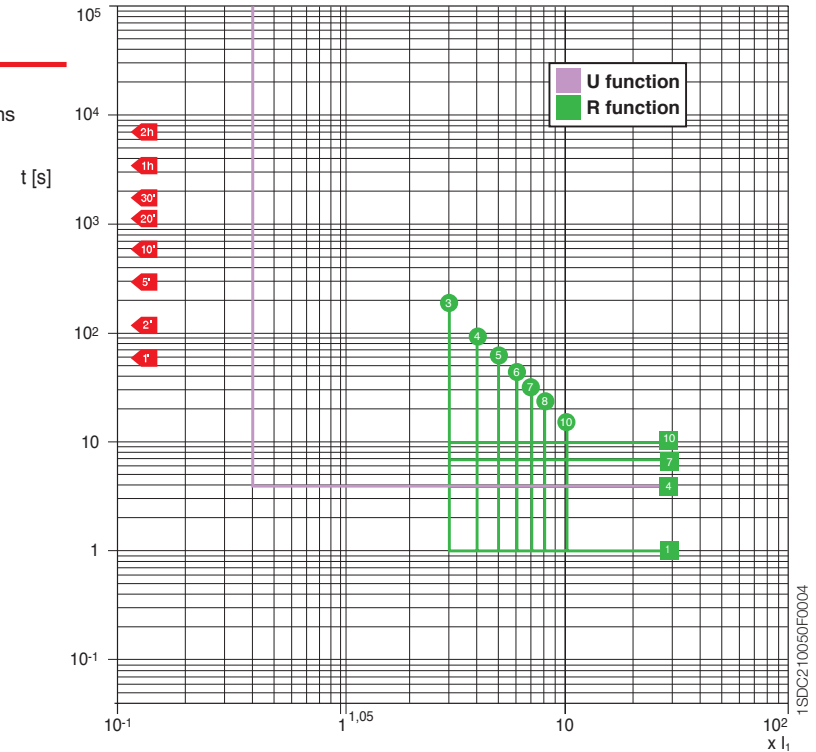

1SDC210050F0004

	I5	t5
R	(3 - 4 - 5 - 6 - 7 - 8 - 10 - OFF) x I1	1 - 4 - 7 - 10 s
PR222MP		
	I6	t6
U	ON (0.4 x I1) - OFF	4 s
PR222MP		

Here the tolerances

	I5	t5
R	± 15 %	± 10 %
PR222MP		
	I6	t6
U	± 15 %	± 10 %
PR222MP		

3 General characteristics

Trip curve
electronic releases

- T4 250
- T5 400
- T6 800
- PR222MP**

I Functions

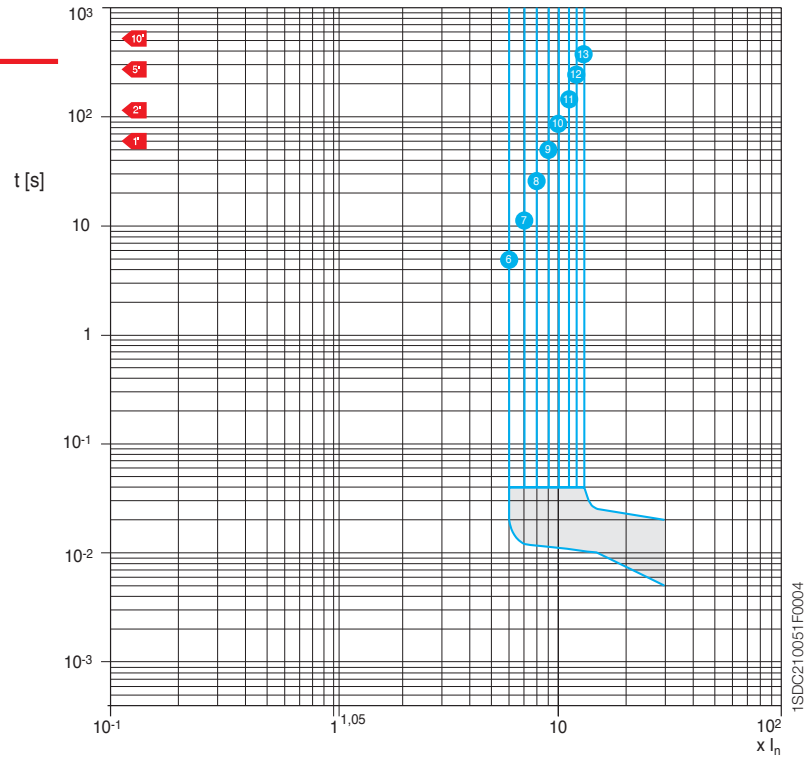

1SDC210051 F0004

	I3
PR222MP	(6 - 7 - 8 - 9 - 10 - 11 - 12 - 13) x In

Here the tolerances

	I3
PR222MP	± 15 %

3 General characteristics

Trip curve
electronic releases

- S7
- PR211/P**

L-I Functions

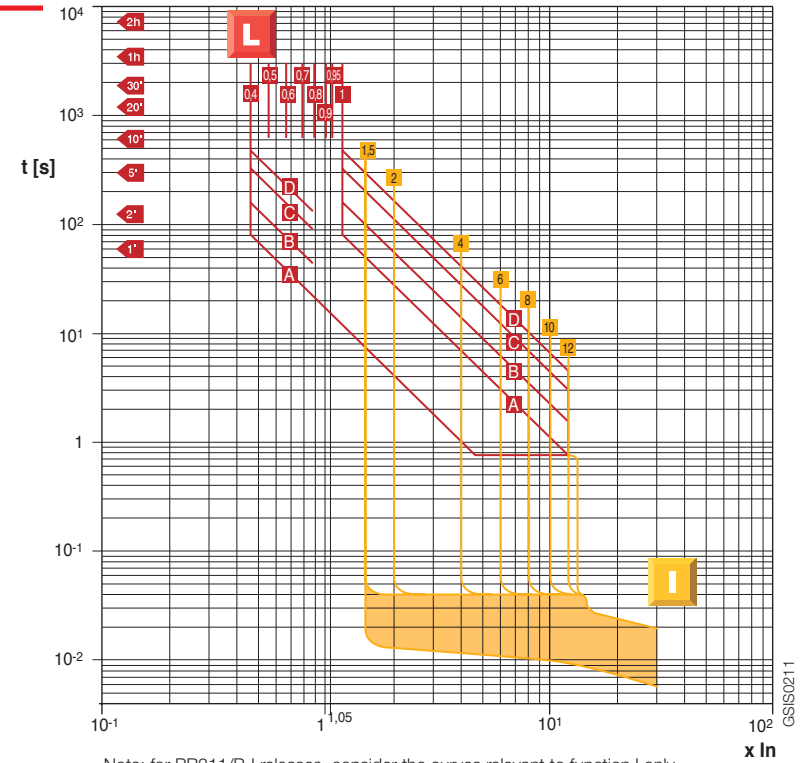

GSIS0211

Note: for PR211/P-I releases, consider the curves relevant to function I only.

3 General characteristics

Trip curve
electronic releases

S7 - S8

PR212/P

L-S-I Functions,
S inverse short
delay
($I^2t = \text{constant}$)

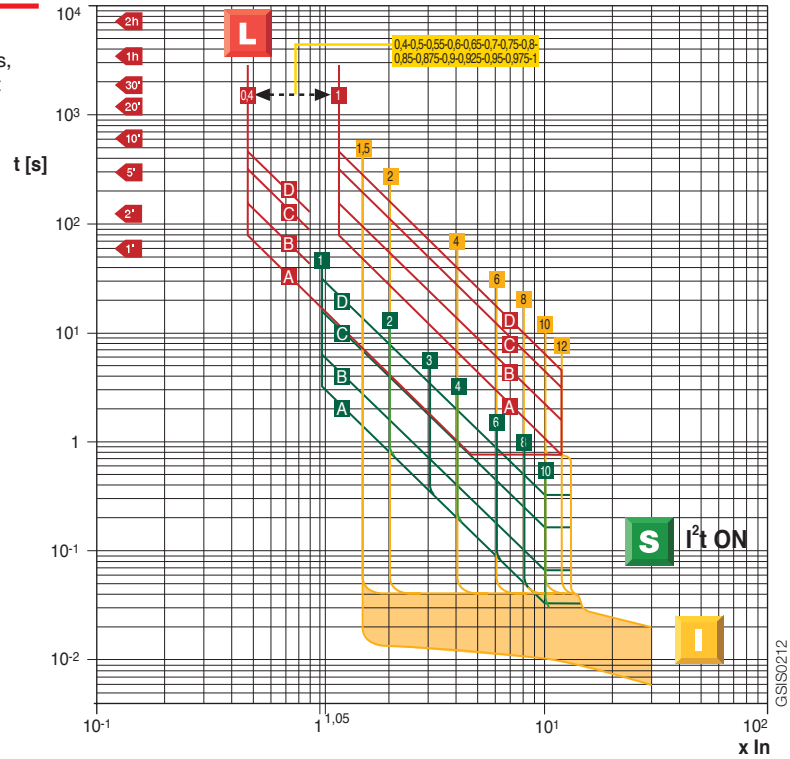

3 General characteristics

Trip curve
electronic releases

S7 - S8

PR212/P

L-S-I Functions,
S inverse short
delay
($t = \text{constant}$)

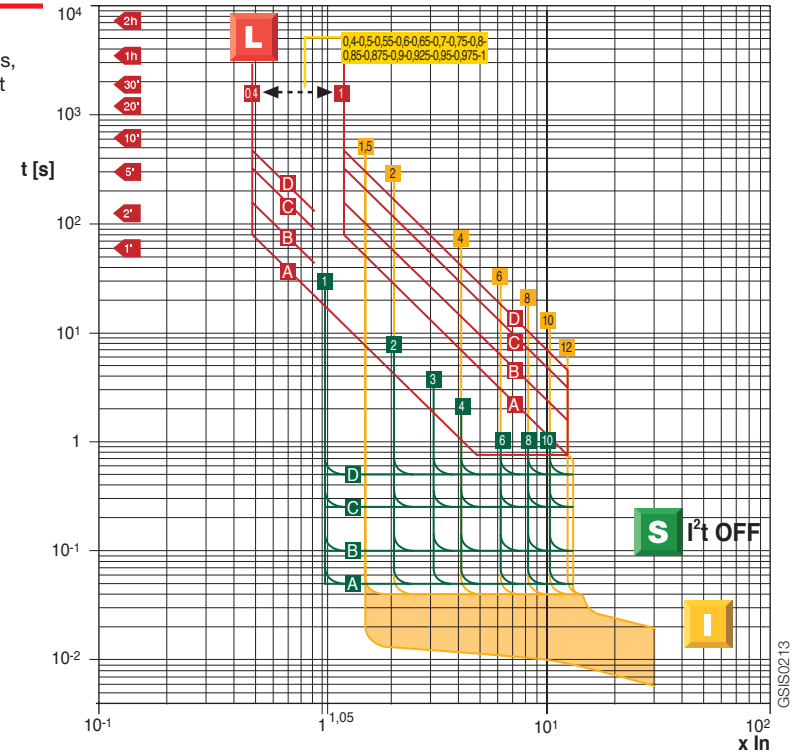

3 General characteristics

Trip curve
electronic releases

S7 - S8

PR212/P

G Function

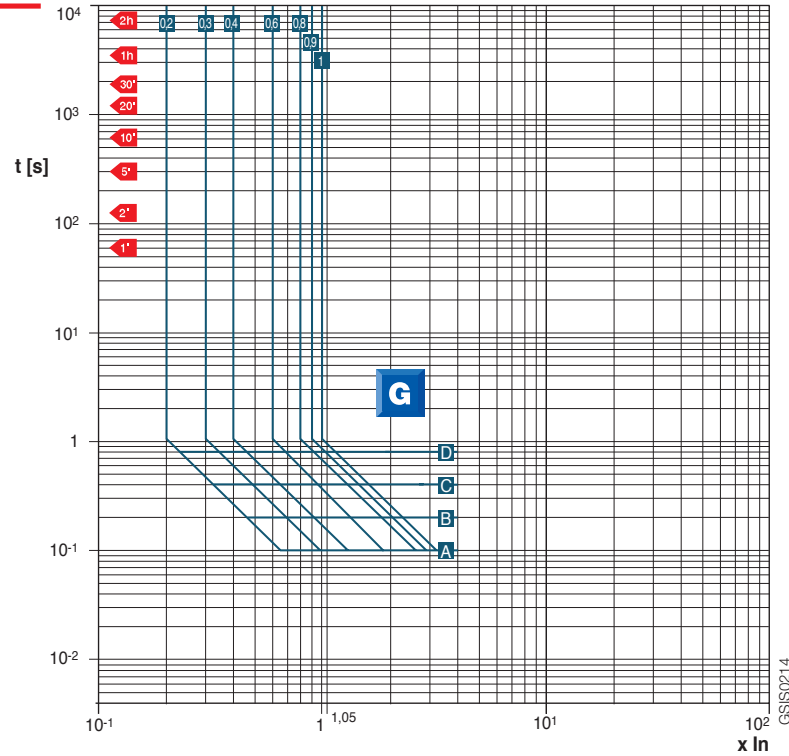

GSS0214

3 General characteristics

Trip curve
electronic releases

S7

PR212/MP

L Function
(hot and cold trip)

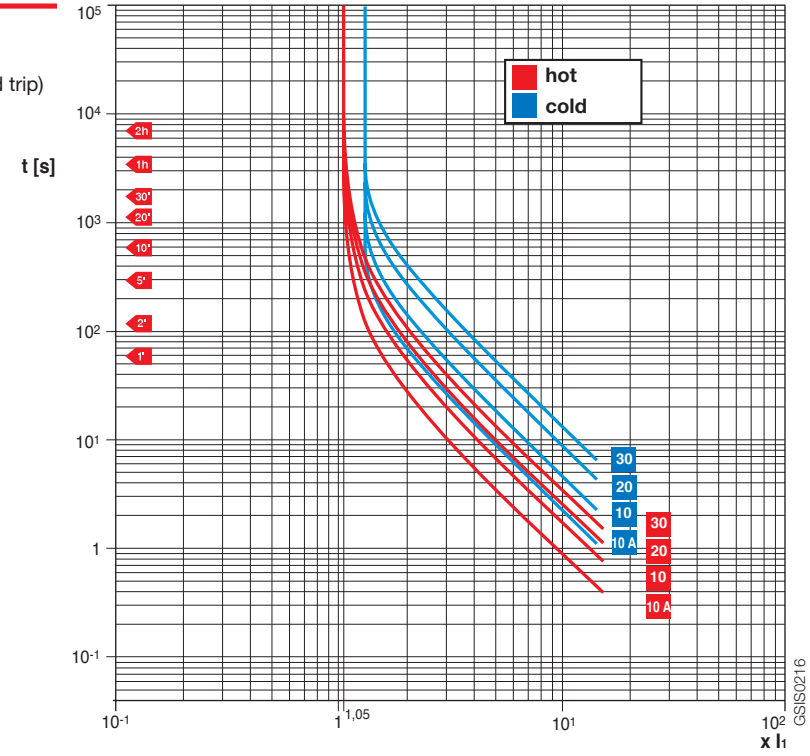

GSS0216

	I_i	t₁
PR212/MP	(0.4 + 1) x I _n with step 0.01 x I _n	4 - 8 - 16 - 24 s

Here the tolerances

	I_i	t₁
PR212/MP	According to IEC 60947-4-1	According to IEC 60947-4-1

3 General characteristics

Trip curve
electronic releases

S7

PR212/MP

L Function
(hot trip with one
or two phases
supplied)

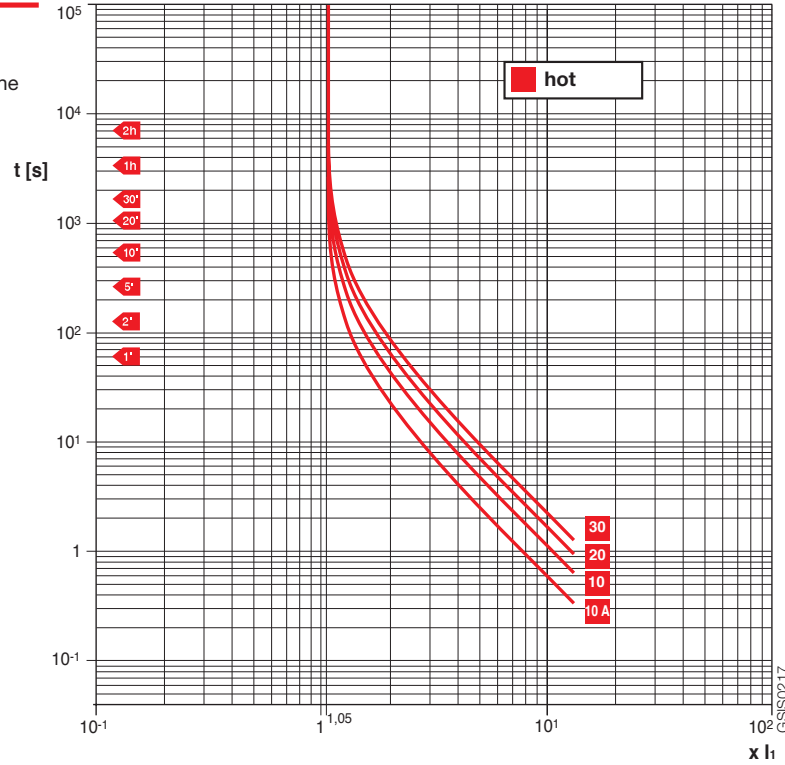

GSS0217

3 General characteristics

Trip curve
electronic releases

S7

PR212/MP

R-U Functions

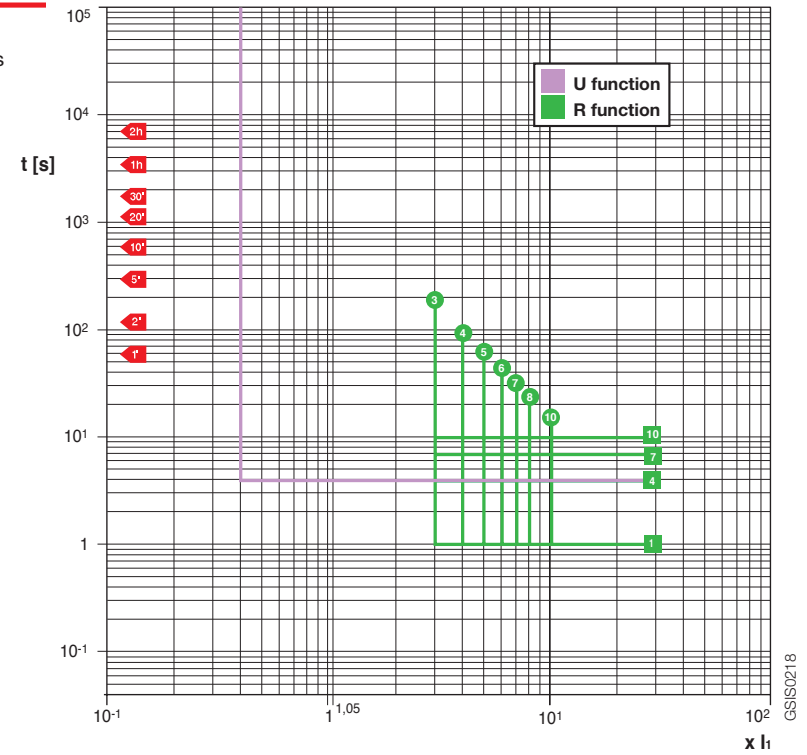

GSS0218

R	I5	t5
PR212/MP	(3 - 4 - 5 - 6 - 7 - 8 - 10 - OFF) x I1	1 - 4 - 7 - 10 s
U	I6	t6
PR212/MP	0.4 x I1	4 s

Here the tolerances

R	I5	t5
PR212/MP	± 10 %	± 20 %
U	I6	t6
PR212/MP	± 20 %	± 20 %

3 General characteristics

Trip curve
electronic releases

S7
PR212/MP

I Function

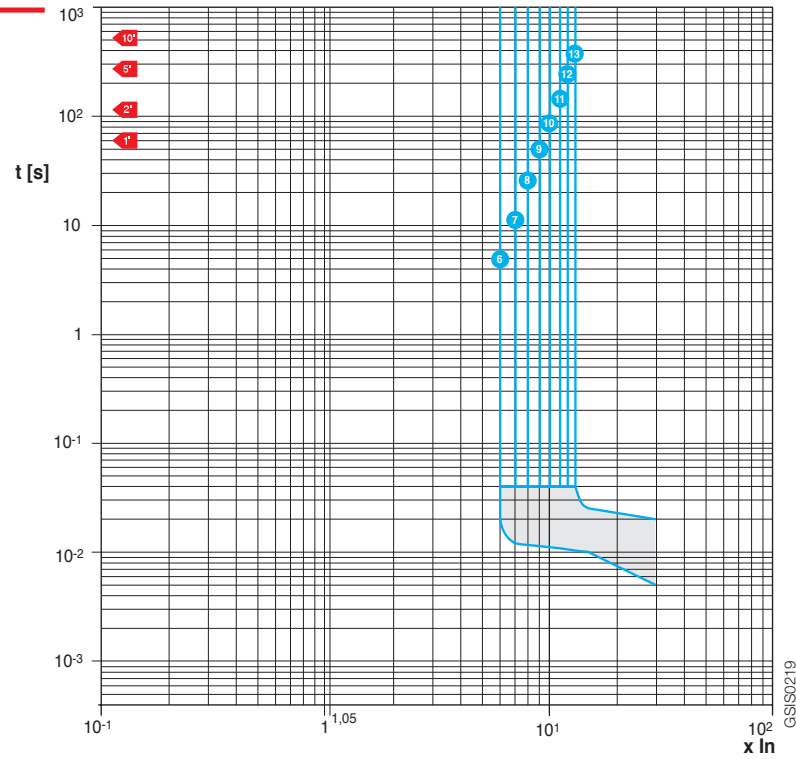

G3S0219

I3

PR212/MP (6 - 7 - 8 - 9 - 10 - 11 - 12 - 13 - OFF) x In

The tolerances are according to IEC 60947-4-1.

3 General characteristics

Trip curve
electronic releases

Emax
PR121/P

L- I Functions

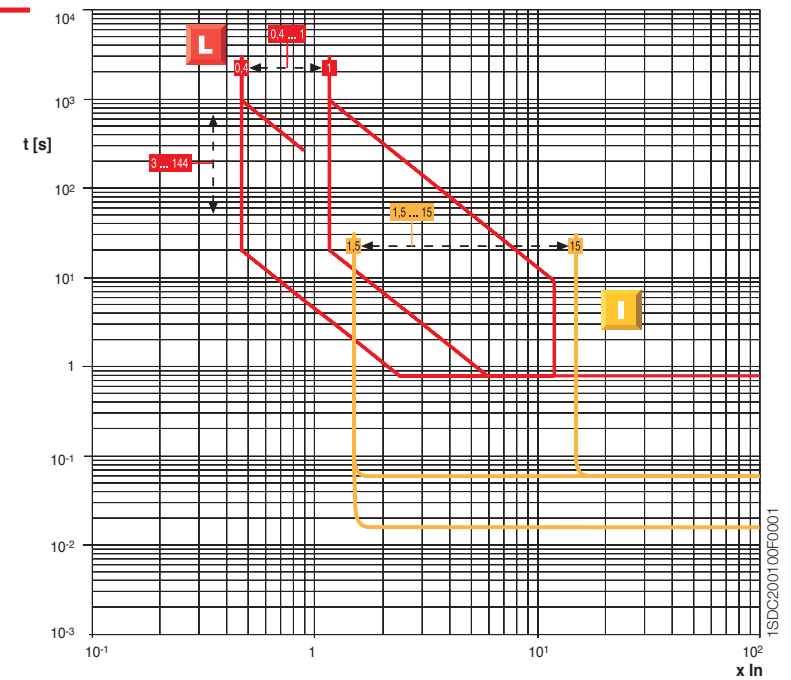

1SDC200100F0001

3 General characteristics

Trip curve
electronic releases

Emax

PR121/P

L-S-I Functions,
S inverse short
time delay
($I^2t = \text{const.}$)

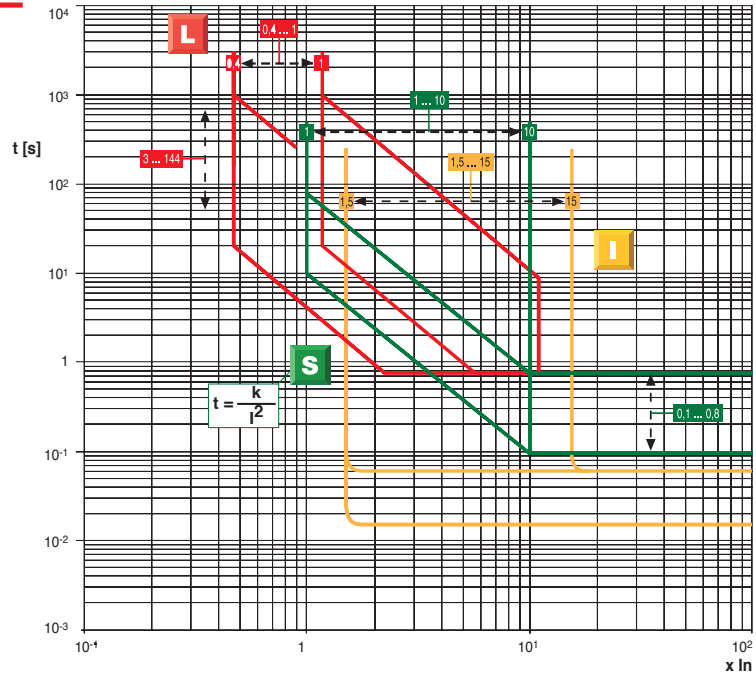

3 General characteristics

Trip curve
electronic releases

Emax

PR121/P

L-S-I Functions,
S independent
time delay
($t = \text{constant}$)

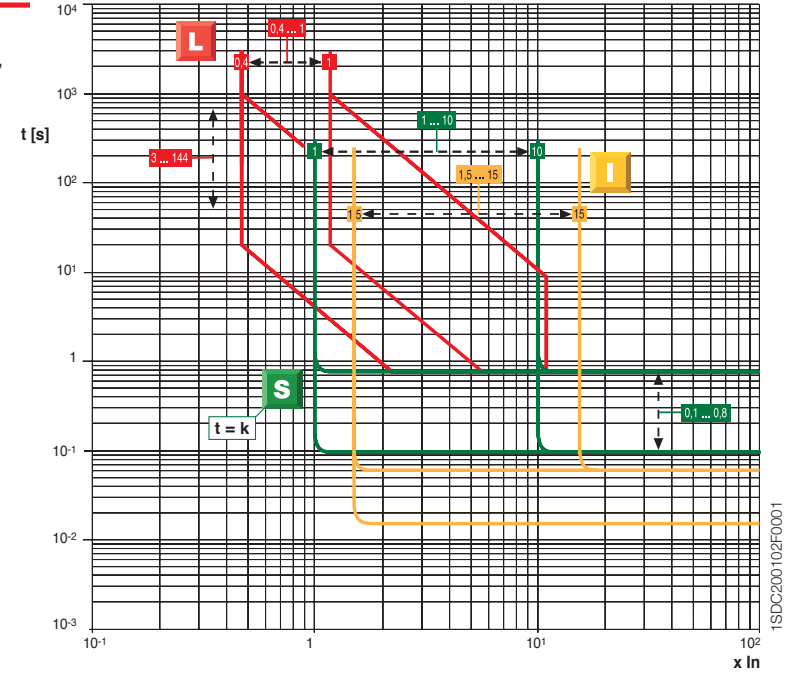

3 General characteristics

Trip curve
electronic releases

Emax
PR121/P

G Function

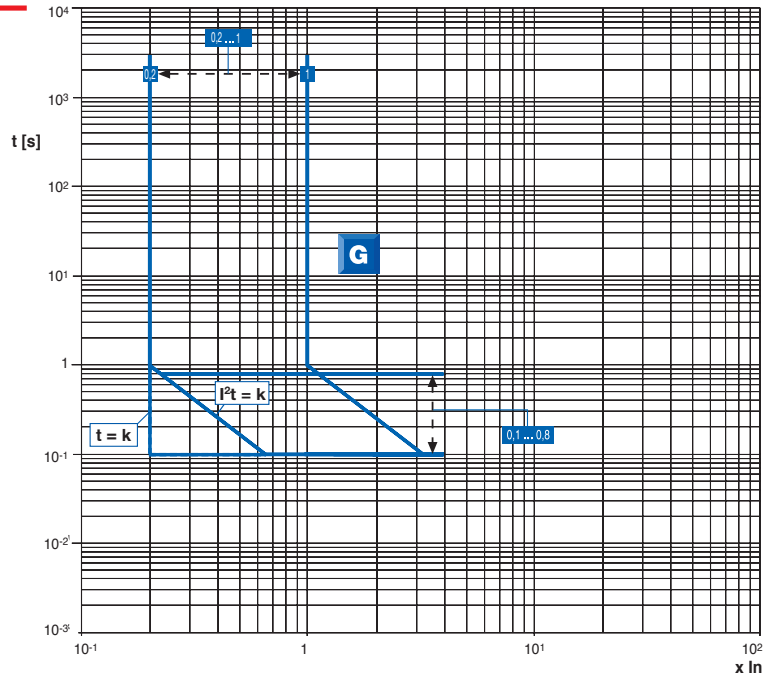

1SDC2001.03F0001

3 General characteristics

Trip curve
electronic releases

Emax
PR122/P

L-I Functions

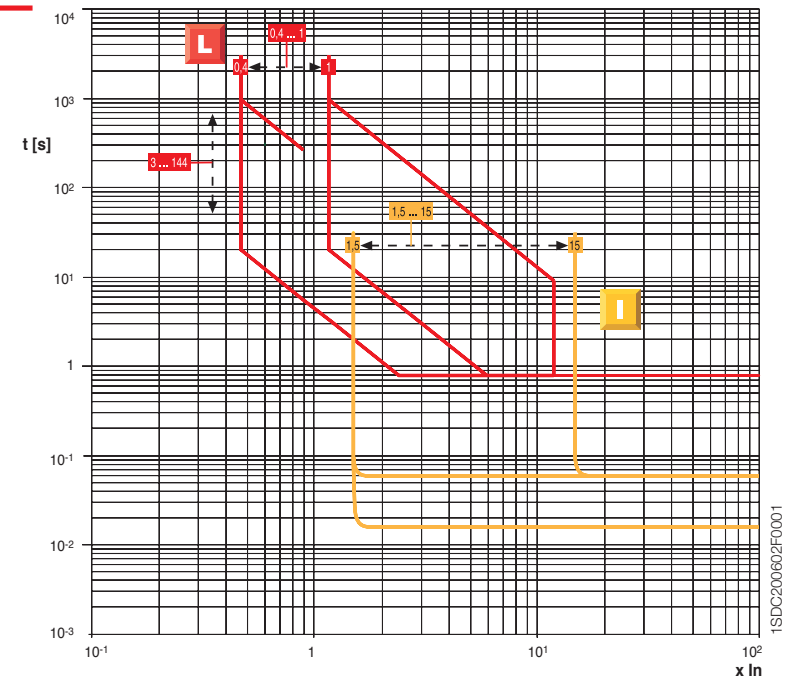

1SDC200602F0001

3 General characteristics

Trip curve
electronic releases

E_{max}
PR122/P-PR123/P

L-S-I Functions
S inverse short
time delay
($I^2t = \text{const.}$)

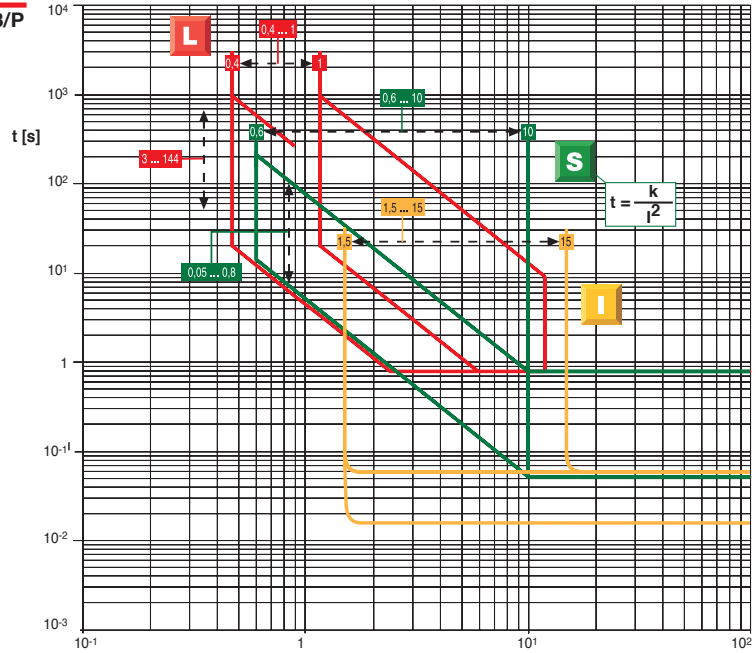

3 General characteristics

Trip curve
electronic releases

E_{max}
PR122/P-PR123/P

L-S-I Functions
S independent
time delay
($t = \text{constant}$)

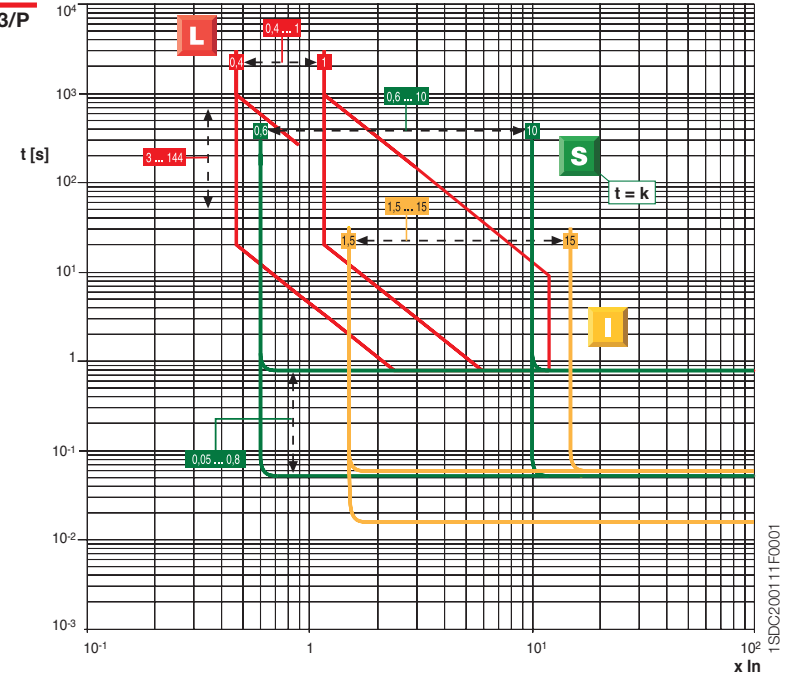

3 General characteristics

Trip curve
electronic releases

Emax
PR122/P-PR123/P

G Function

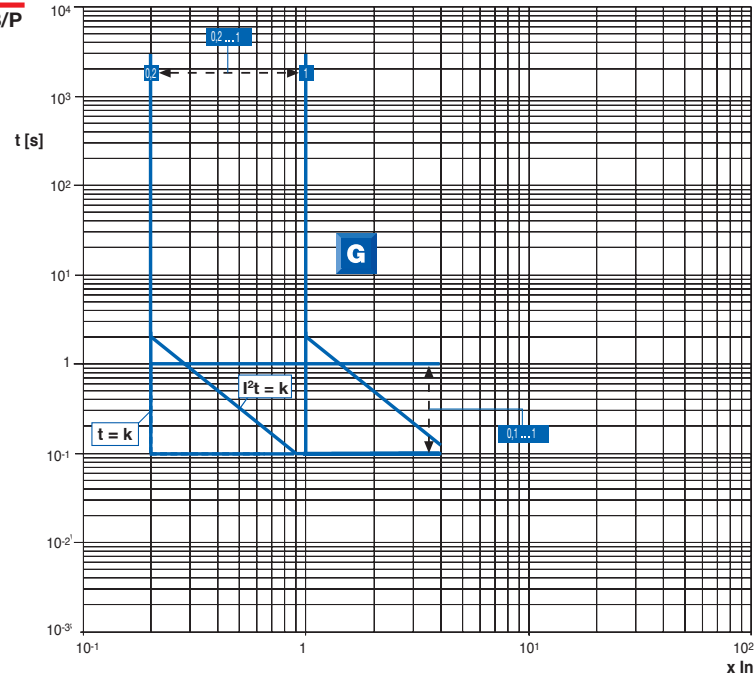

1SDC200112F0001

3 General characteristics

Trip curve
electronic releases

Emax
PR123/P

L Function
(IEC 60255-3)

PR123/P release – Function L in compliance with Std. IEC 60255-3

The following three curves refer to the protection function L complying with Std. IEC 60255-3 and integrate the standard one; they are applicable in coordination with fuses and MV circuit-breakers.

PR 123/P k=0.14 alfa=0.02

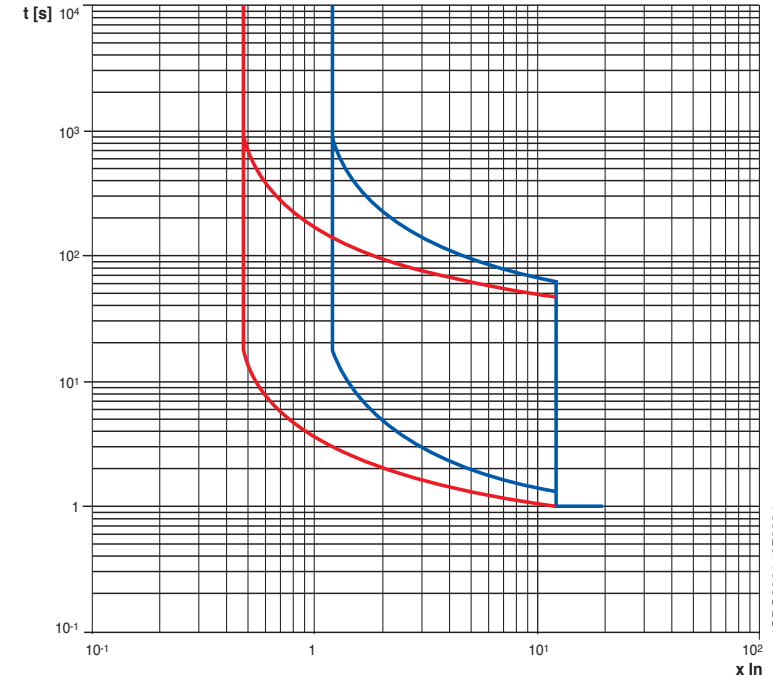

1SDC200118F0001

	I1	t1
PR123	(0.4...1) x In with step 0.01 x In	t1=3s...144s with step 3s (1) (@ I=3 x Un)
Here below the tolerances:		
	I1	
PR123	1.05...1.2 x In	± 20 % I _g > 5 x I ₁ ± 30 % 2 x I ₁ ≤ I _g ≤ 5 x I ₁ In

⁽¹⁾The minimum trip values is 1 s, regardless of the type of curve set (self protection)

3 General characteristics

Trip curve
electronic releases

Emax
PR123/P

L Function
(IEC 60255-3)

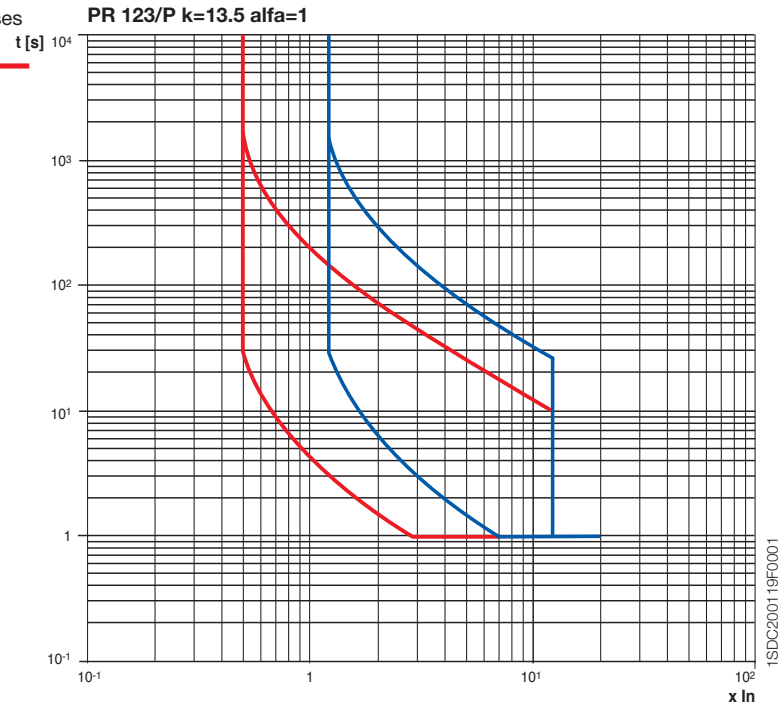

1SDC200119F0001

	I1	t1
PR123	$(0.4...1) \times I_n$ with step $0.01 \times I_n$	$t_1=3s...144s$ with step 3s (1) (@ $I=3 \times I_n$)
Here below the tolerances:		
	I1	
PR123	$1.05...1.2 \times I_n$	$\pm 20\% I_g > 5 \times I_1$ $\pm 30\% 2 \times I_1 \leq I_g \leq 5 \times I_1 I_n$

⁽¹⁾ The minimum trip values is 1 s, regardless of the type of curve set (self protection)

3 General characteristics

Trip curve
electronic releases

Emax
PR123/P

L Function
(IEC 60255-3)

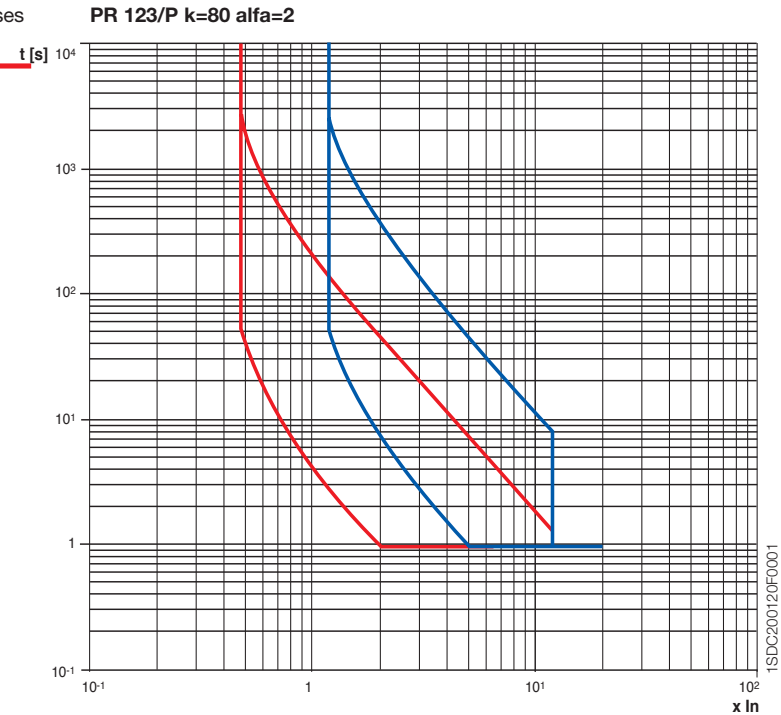

1SDC200120F0001

	I1	t1
PR123	$(0.4...1) \times I_n$ with step $0.01 \times I_n$	$t_1=3s...144s$ with step 3s (1) (@ $I=3 \times I_n$)
Here below the tolerances:		
	I1	
PR123	$1.05...1.2 \times I_n$	$\pm 20\% I_g > 5 \times I_1$ $\pm 30\% 2 \times I_1 \leq I_g \leq 5 \times I_1 I_n$

⁽¹⁾ The minimum trip values is 1 s, regardless of the type of curve set (self protection)

3 General characteristics

Trip curve
electronic releases

E_{max}
PR123/P

Function D

PR 122/PR123 release – Other protection functions

The following curves refer to the particular protection functions provided for PR122/PR123.

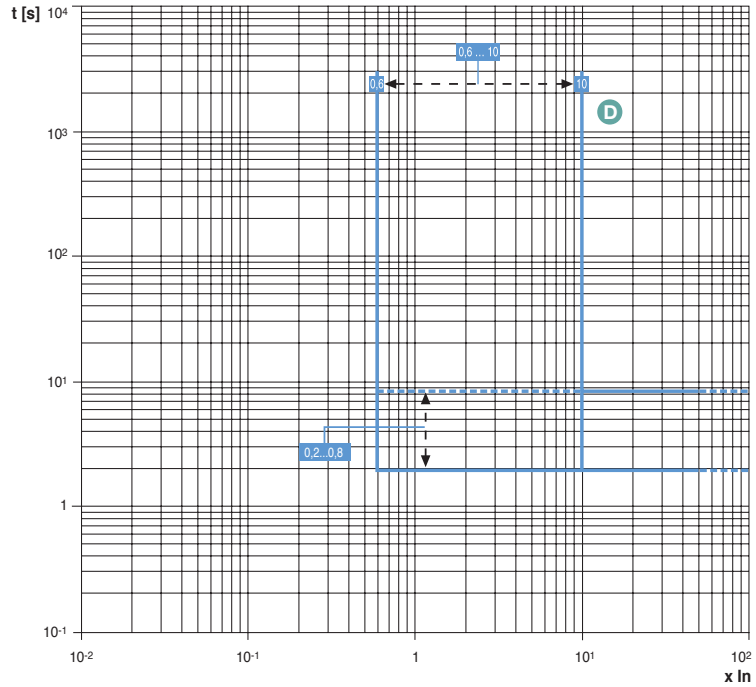

1SDC200122F0001

	t7	t7
PR123	(0.6 ... 10 – OFF) x In with step 0.1 x In	0.2s ... 0.8s with step 0.01s (@ I > I ₇)
	Here below the tolerances:	
PR123	± 10 %	the better of the two figures: ± 10 % or ± 40 ms

3 General characteristics

Trip curve
electronic releases

E_{max}
PR122/P
PR123/P
Function U

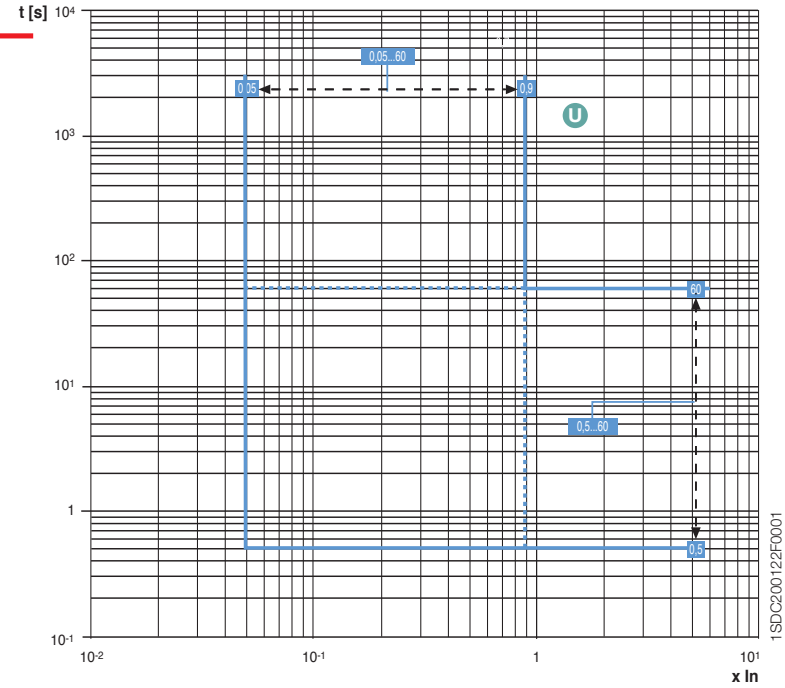

1SDC200122F0001

	t6	t6
PR122/P PR123/P	(5%...90% – OFF) with step 5%	0.5 ... 60s with step 0.5s
	Here below the tolerances:	
PR122/P PR123/P	± 10 %	The better of the two figures: ± 20 % or ± 100 ms

3 General characteristics

Trip curve
electronic releases

Emax
PR122/P
PR123/P
Function UV

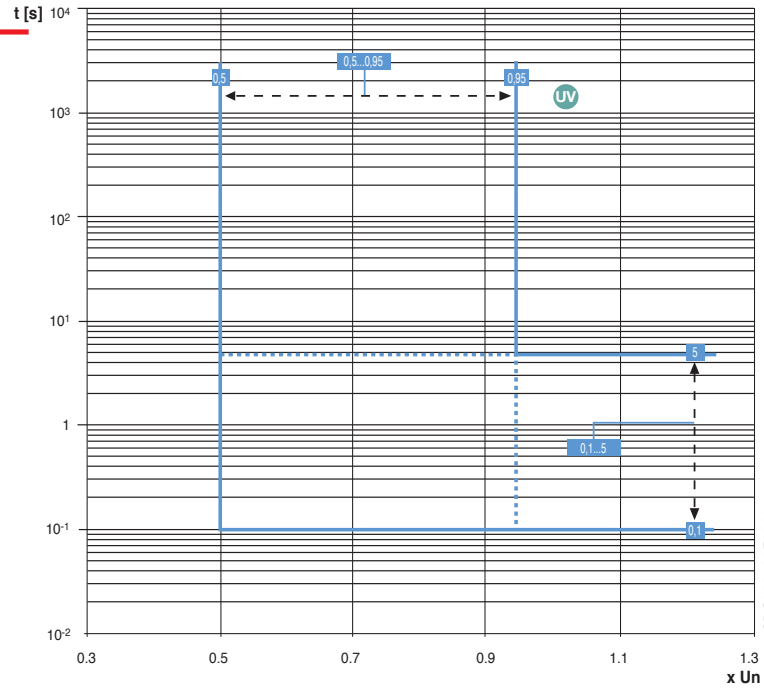

1SDC200123F0001

	U8	t8
PR122/P PR123/P	(0.5 ... 0.95 – OFF) x Un with step 0.01 x Un	with $U < U_8$ 0.1 ... 5s with step 0.1s
Here below the tolerances:		
	U8	t8
PR122/P	± 5 %	The better of two figures: ± 20 % or ± 100 ms
PR123/P	± 5 %	The better of two figures: ± 20 % or ± 40 ms

3 General characteristics

Trip curve
electronic releases

Emax
PR122/P
PR123/P
Function OV

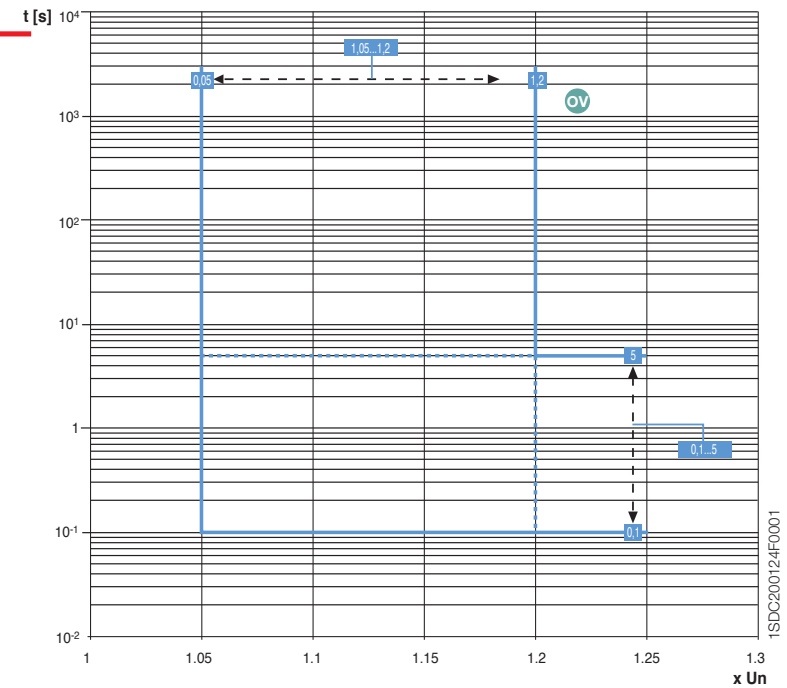

1SDC200124F0001

	U9	t9
PR122/P PR123/P	(1.05 ... 1.2 – OFF) x Un with step 0.01 x Un	with $U < U_9$ 0.1s ... 5s with step 0.1s
Here below the tolerances:		
	U9	t9
PR122/P	± 5 %	The better of two figures: ± 20 % or ± 100 ms
PR123/P	± 5 %	The better of two figures: ± 20 % or ± 40 ms

3 General characteristics

Trip curve
electronic releases

Emax
PR122/P
PR123/P
Function RV

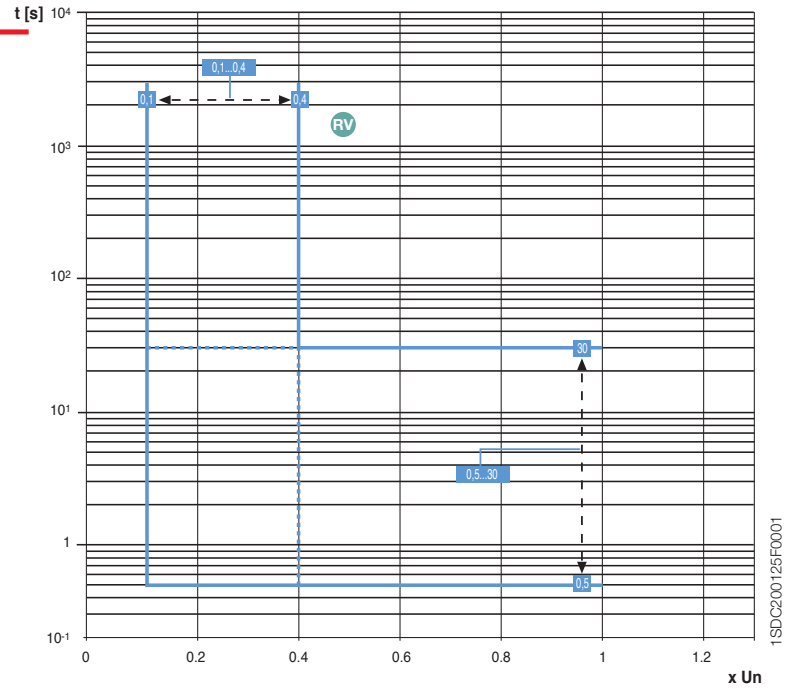

1SDC200125F0001

	U10	t10
PR122/P PR123/P	(0.1 ... 0.4 – OFF) x Un with step 0.05 x Un	with $U < U_{10}$ 0.5s ... 30s with step 0.5s
	Here below the tolerances:	
PR122/P PR123/P	± 5 %	the better of the two figures: ± 10 % or ± 100 ms

3 General characteristics

Trip curve
electronic releases

Emax
PR122/P
PR123/P
Function RP

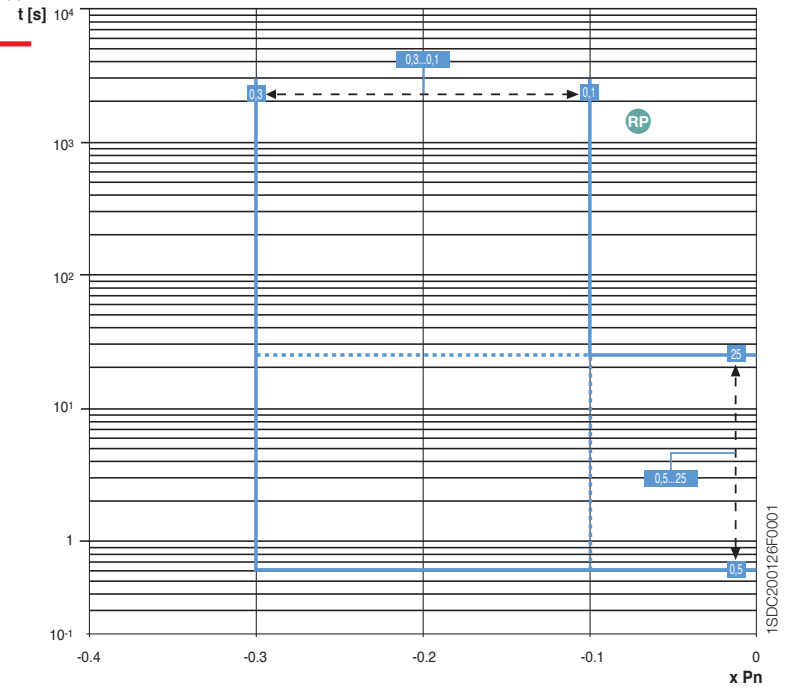

1SDC200126F0001

	P11	t11
PR122/P PR123/P	(-0.3 ... -0.1 – OFF) x Pn with step 0.02 x Pn	with $P < P_{11}$ 0.1 ... 25s with step 0.1s
	Here below the tolerances:	
PR122/P PR123/P	± 5 %	the better of the two figures: ± 10 % or ± 100 ms
PR123/P	10 %	

3 General characteristics

Example of electronic release setting

Considering a circuit-breaker type E1B1000 fitted with a PR121/P LSI release and with a rating plugs of 1000, it is supposed that for the system requirements, the protection functions are regulated according to the following settings:

L	$I1=0.6$	$t1=12s$
S	$I2=4$	$t2=0.3$
I	$I3=8$	

The trip curve of the release is represented in the following figure (continuous lines): it can be seen that:

- for function L, the curve is represented by the mean value between the tolerances given by the Standard (the overload protection function must not trip for current values lower than $1.05 \cdot I_n$, and must trip within $1.3 \cdot I_n$), therefore corresponding to $1.175 \cdot I_n$ (around 700 A);
- graphically, point **1** is obtained at the intersection of the vertical part of function L and the horizontal segment ($C_{0.4I_n} - C_{1I_n}$) which connects the points relevant to the same $t1$, taken from the curves with setting $0.4 \cdot I_n$ and $1 \cdot I_n$;
- corresponding to point **2** (4000 A), the function S takes the place of function L, as the trip time of function S is lower than the trip time of function L;
- in the same way as for point **2**, for point **3** (8000 A) and beyond, function S is substituted by function I.

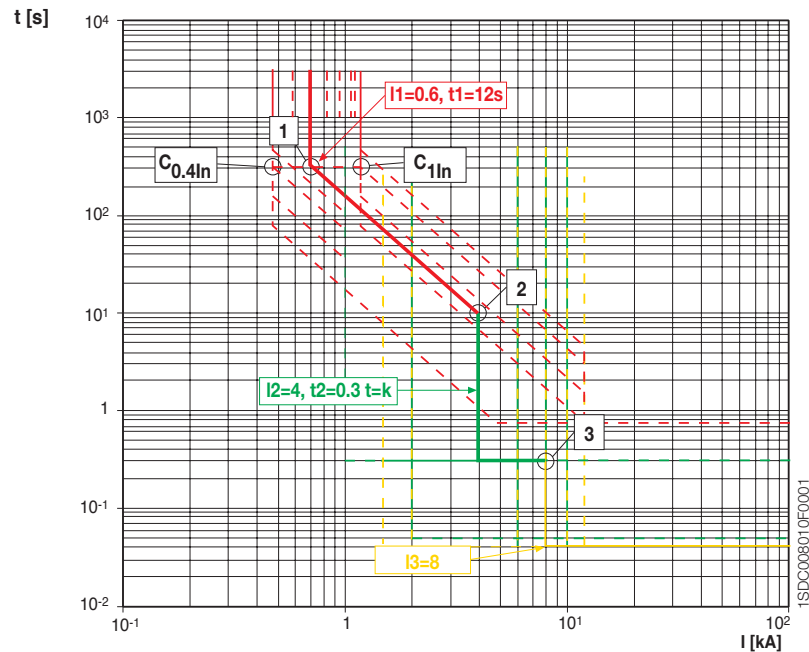

3 General characteristics

3.3 Limitation curves

A circuit-breaker in which the opening of the contacts occurs after the passage of the peak of the short-circuit current, or in which the trip occurs with the natural passage to zero, allows the system components to be subjected to high stresses, of both thermal and dynamic type. To reduce these stresses, current-limiting circuit-breakers have been designed (see Chapter 2.2 "Main definitions"), which are able to start the opening operation before the short-circuit current has reached its first peak, and to quickly extinguish the arc between the contacts; the following diagram shows the shape of the waves of both the prospective short-circuit current as well as of the limited short-circuit current.

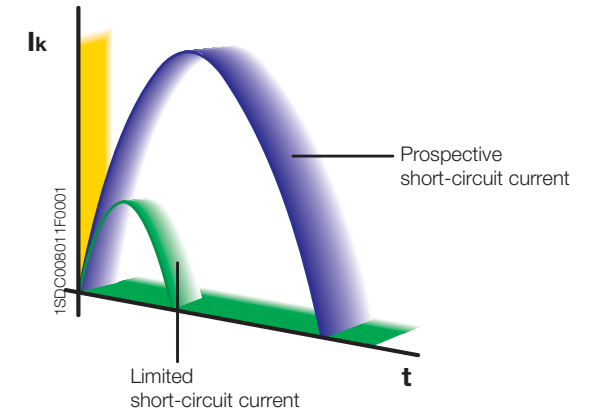

The following diagram shows the limit curve for Tmax T2L160, I_n160 circuit-breaker. The x-axis shows the effective values of the symmetrical prospective short-circuit current, while the y-axis shows the relative peak value. The limiting effect can be evaluated by comparing, at equal values of symmetrical fault current, the peak value corresponding to the prospective short-circuit current (curve A) with the limited peak value (curve B).

Circuit-breaker T2L160 with thermomagnetic release I_n160 at 400 V, for a fault current of 40 kA, limits the short-circuit peak to 16.2 kA only, with a reduction of about 68 kA compared with the peak value in the absence of limitation (84 kA).

3 General characteristics

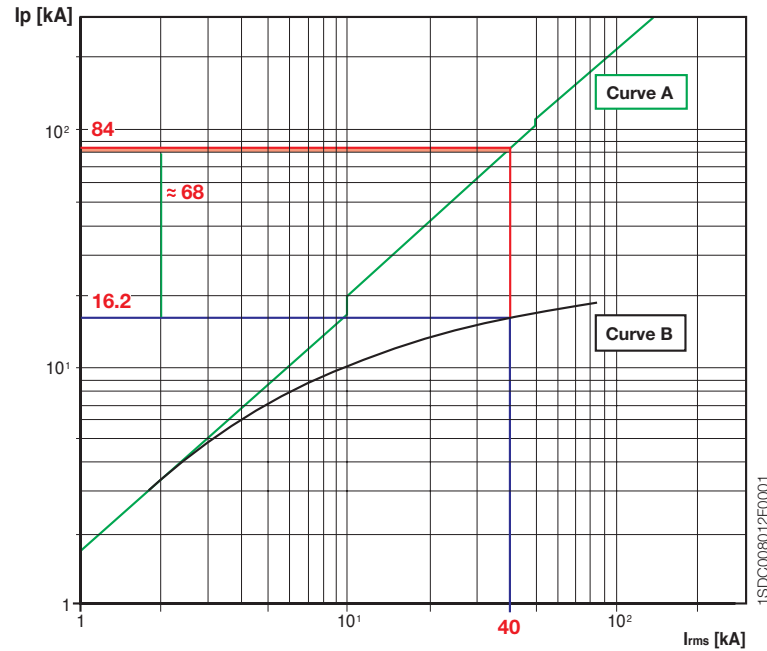

Considering that the electro-dynamic stresses and the consequent mechanical stresses are closely connected to the current peak, the use of current limiting circuit-breakers allows optimum dimensioning of the components in an electrical plant. Besides, current limitation may also be used to obtain back-up protection between two circuit-breakers in series.

In addition to the advantages in terms of design, the use of current-limiting circuit-breakers allows, for the cases detailed by Standard IEC 60439-1, the avoidance of short-circuit withstand verifications for switchboards. Clause 8.2.3.1 of the Standard "Circuits of ASSEMBLIES which are exempted from the verification of the short-circuit withstand strength" states that:

"A verification of the short-circuit withstand strength is not required in the following cases.

...

For ASSEMBLIES protected by current-limiting devices having a cut-off current not exceeding 17 kA at the maximum allowable prospective short-circuit current at the terminals of the incoming circuit of the ASSEMBLY.

..."

The example above is included among those considered by the Standard: if the circuit-breaker was used as a main breaker in a switchboard to be installed in a point of the plant where the prospective short-circuit current is 40 kA, it would not be necessary to carry out the verification of short-circuit withstand.

3 General characteristics

Limitation curves

T1 160

230 V

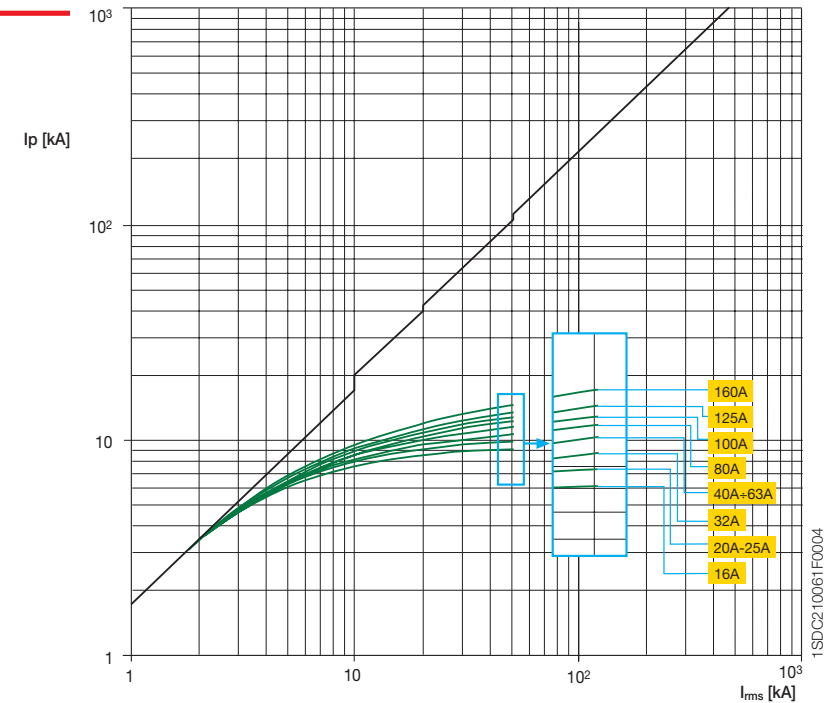

3 General characteristics

Limitation curves

T2 160

230 V

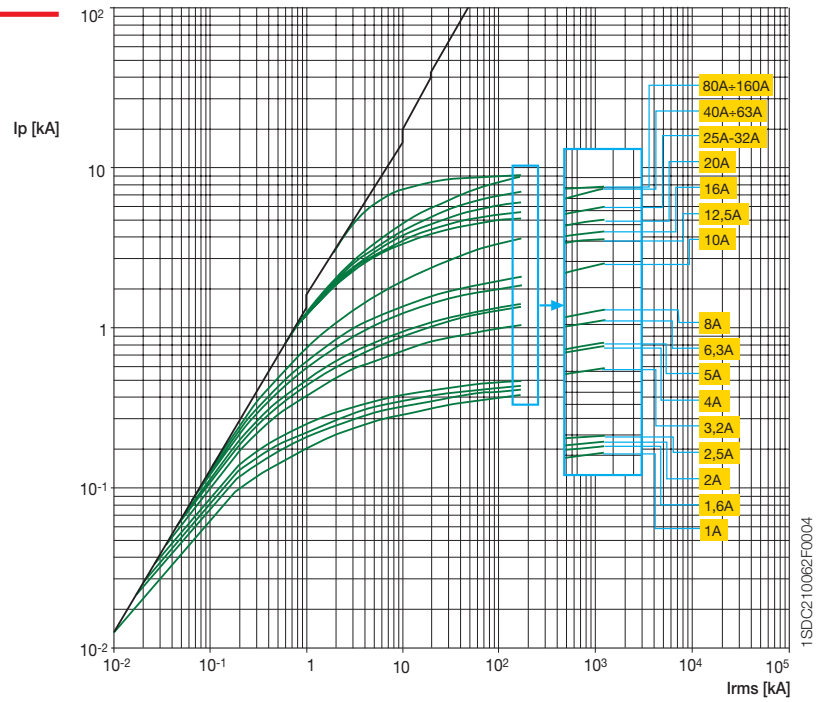

3 General characteristics

Limitation curves

T3 250

230 V

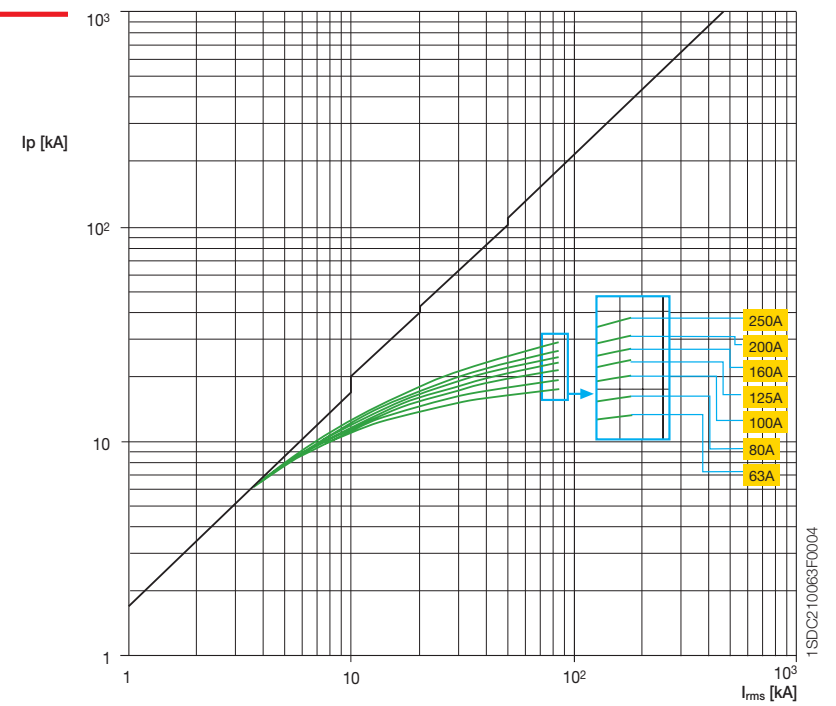

3 General characteristics

Limitation curves

T4 250/320

230 V

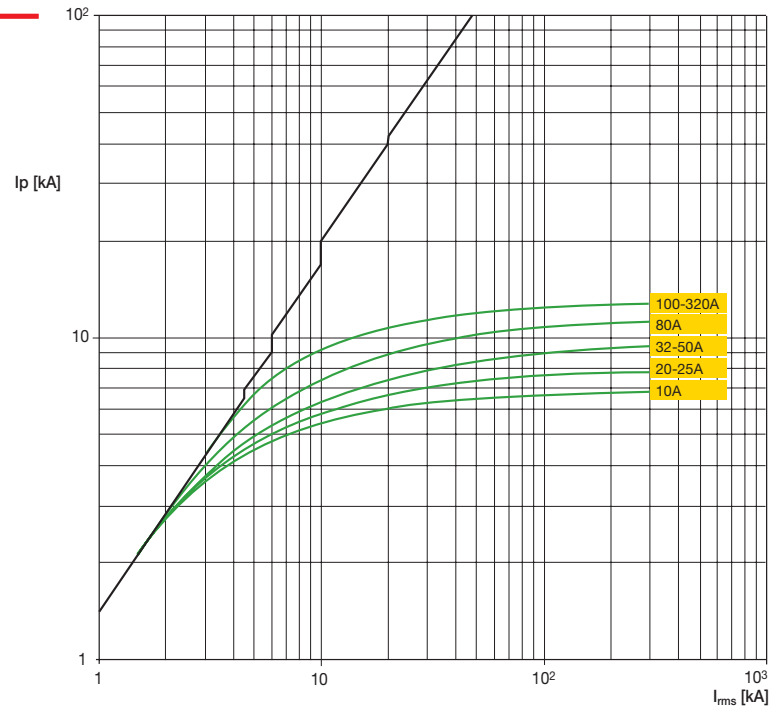

3 General characteristics

Limitation curves

T5 400/630

230 V

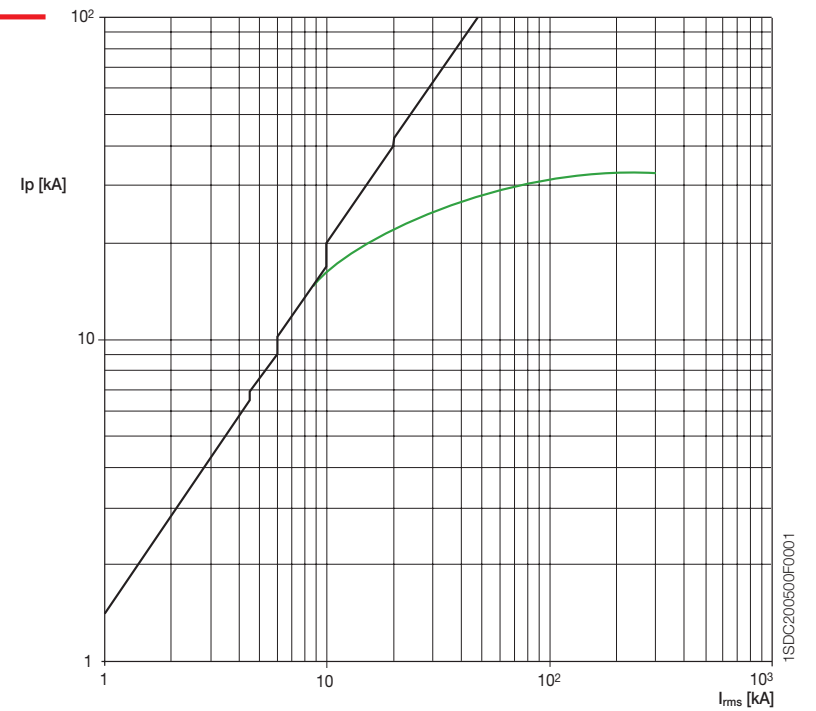

3 General characteristics

Limitation curves

T6 630/800/1000

230 V

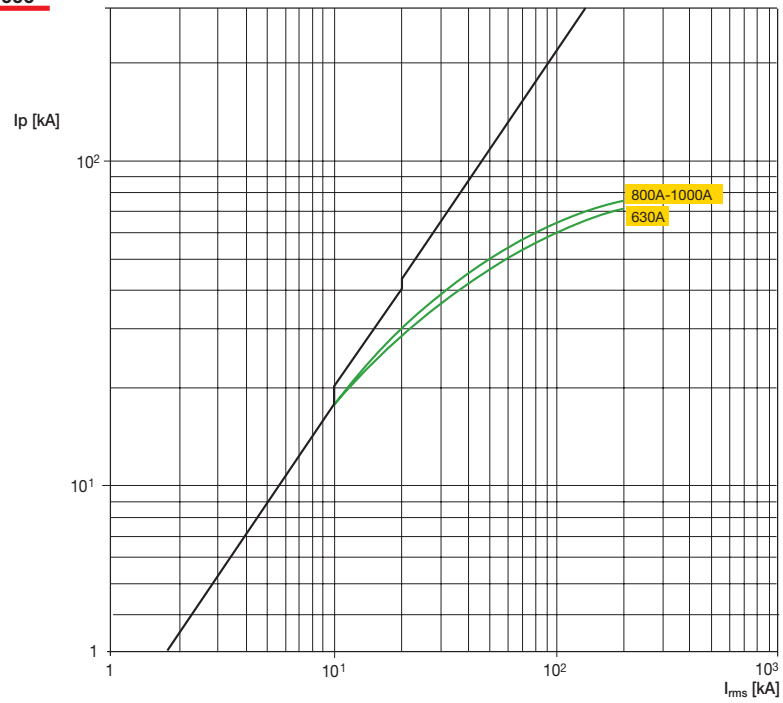

3 General characteristics

Limitation curves

T1 160

400-440 V

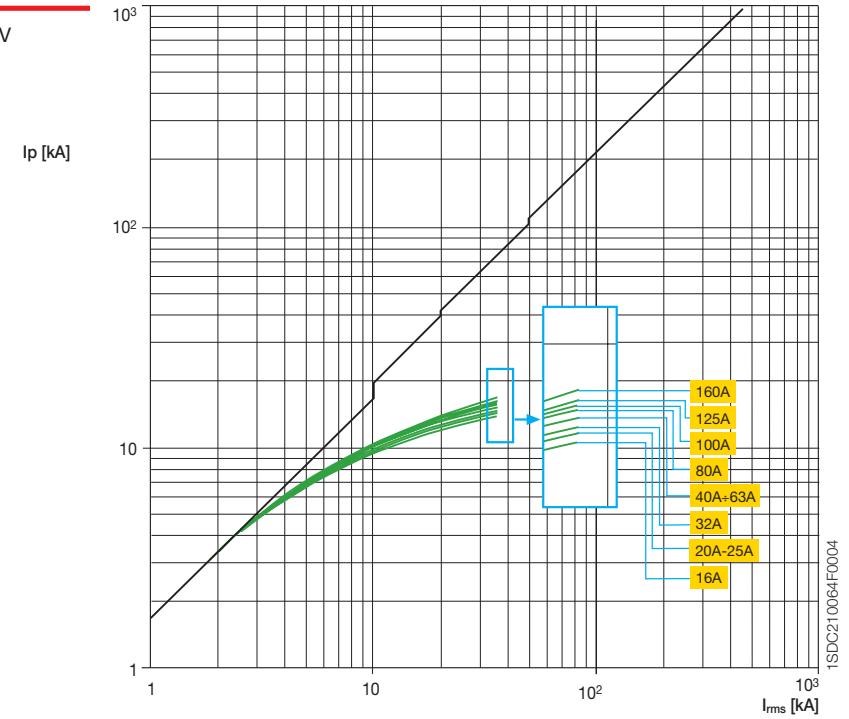

1SDC210064F0004

3 General characteristics

Limitation curves

T2 160

400-440 V

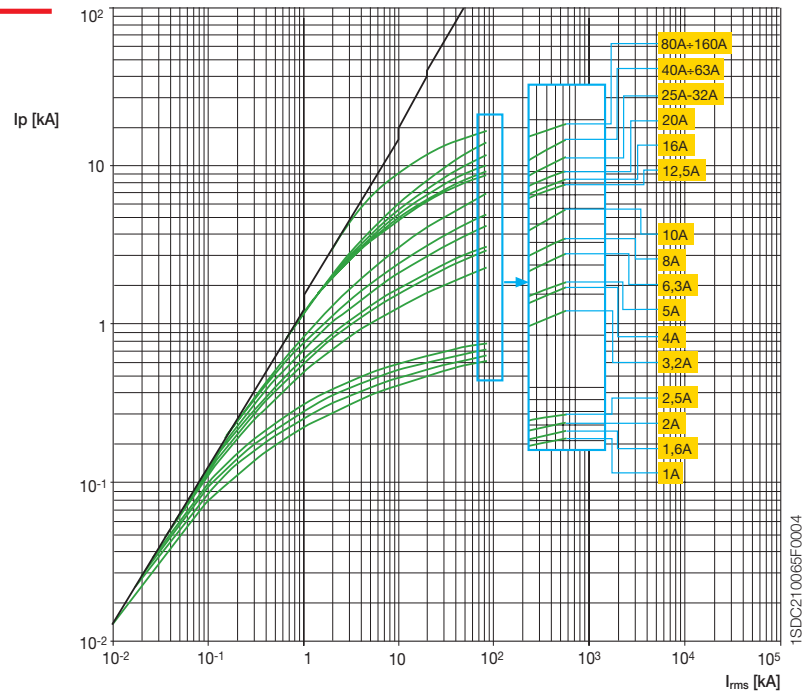

1SDC210066F0004

3 General characteristics

Limitation curves

T3 250

400-440 V

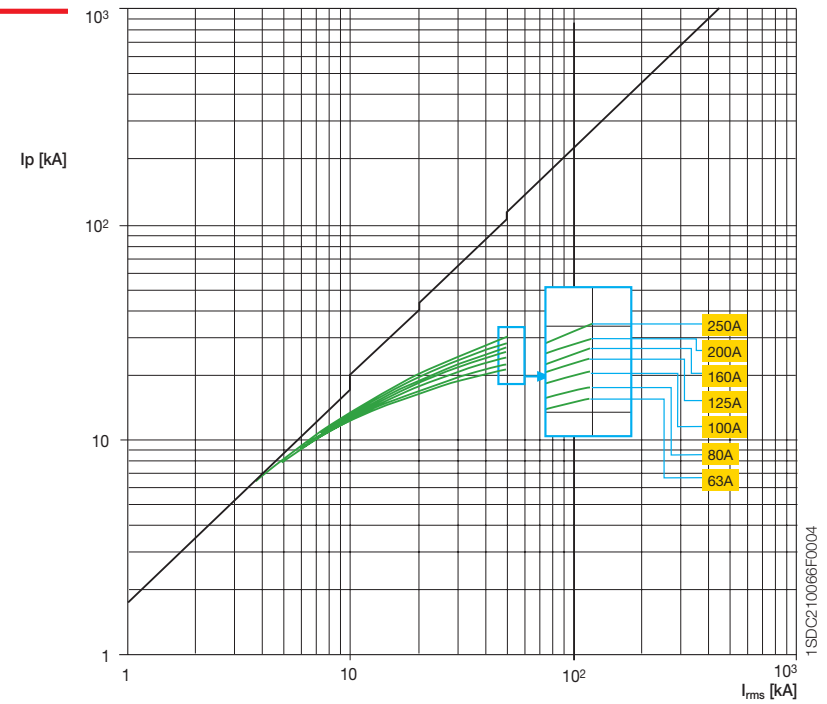

1SDC210066F0004

3 General characteristics

Limitation curves

T4 250/320

400-440 V

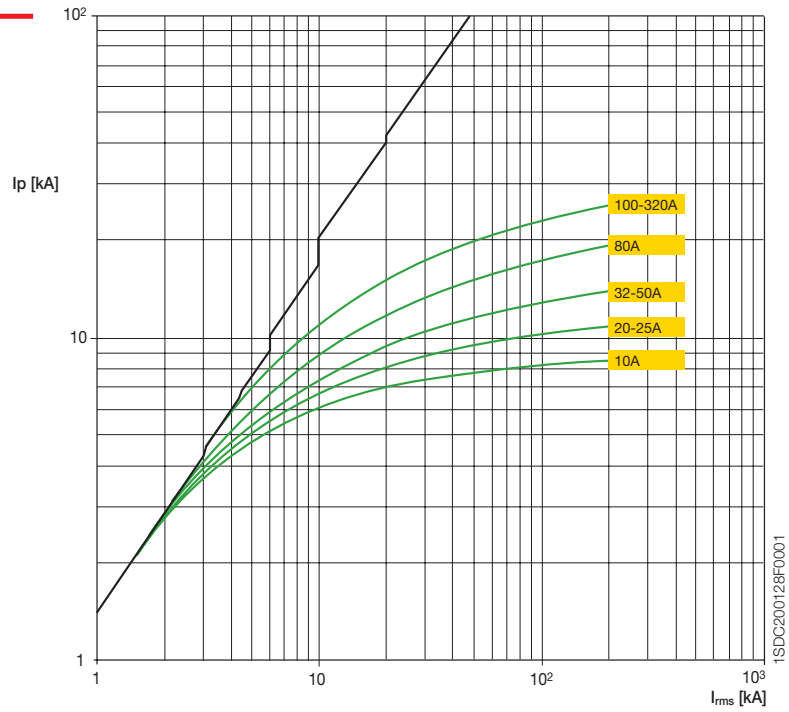

3 General characteristics

Limitation curves

T5 400/630

400-440 V

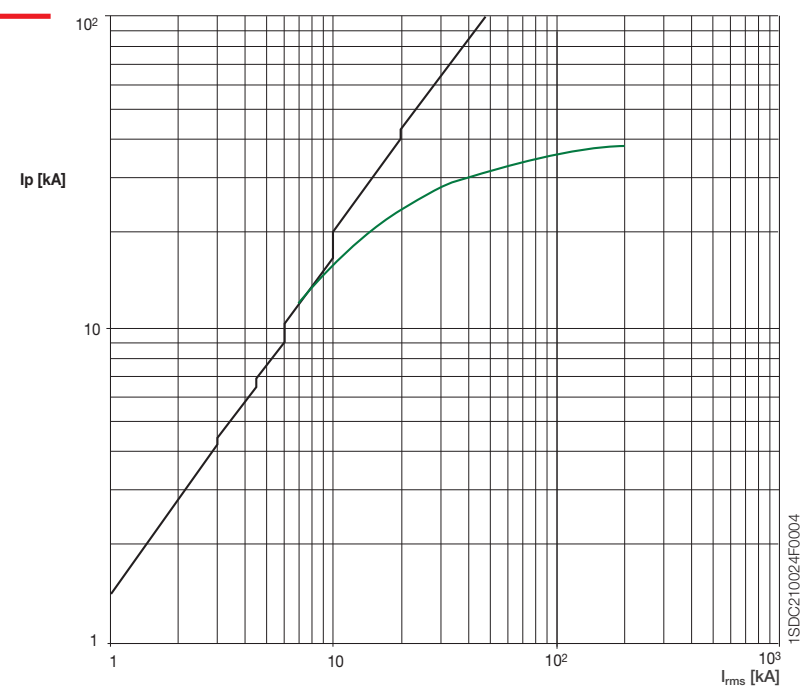

3 General characteristics

Limitation curves

T6 630/800/1000

400-440 V

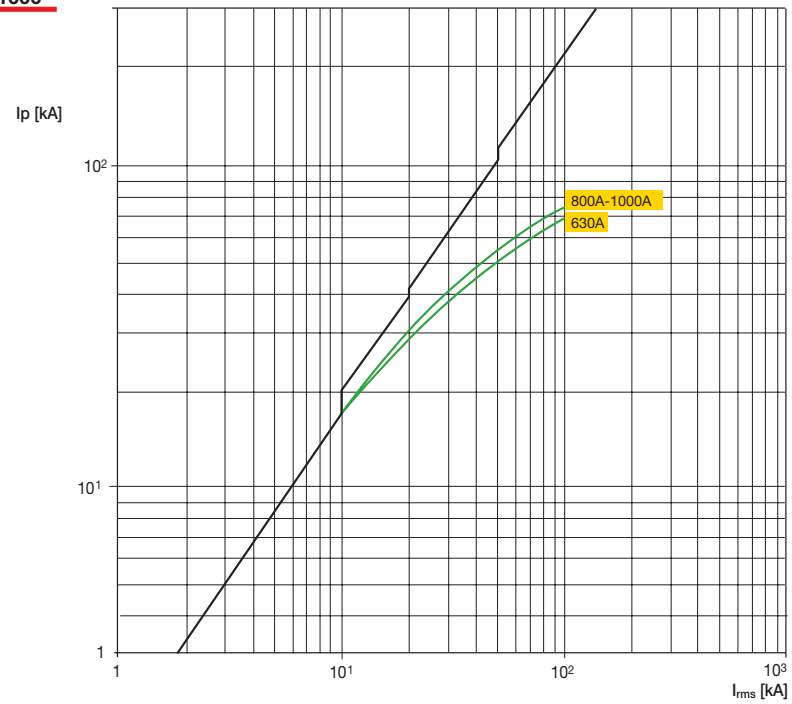

3 General characteristics

Limitation curves

T1 160

500 V

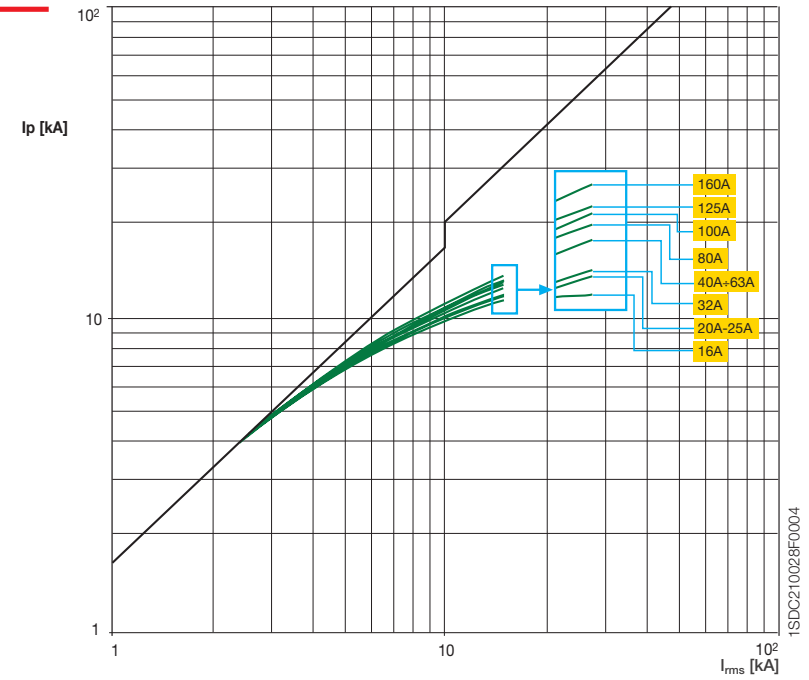

1SDC210028F0004

3 General characteristics

Limitation curves

T2 160

500 V

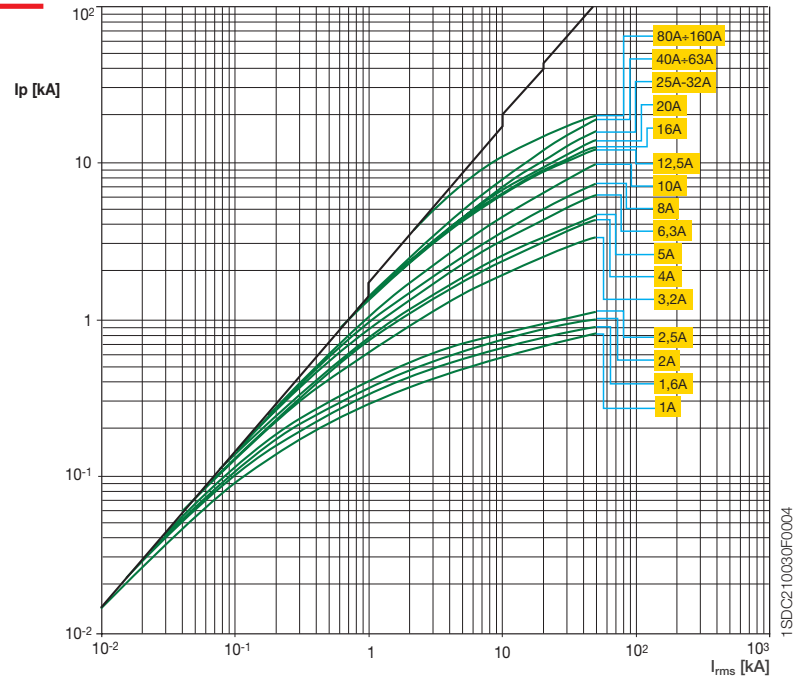

1SDC210032F0004

3 General characteristics

Limitation curves

T3 250

500 V

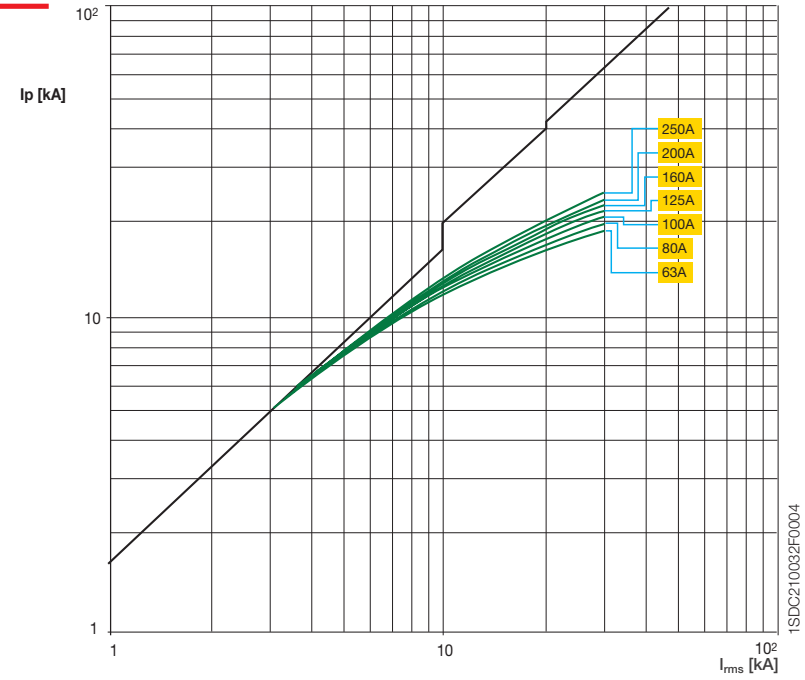

1SDC210032F0004

3 General characteristics

Limitation curves

T4 250/320

500 V

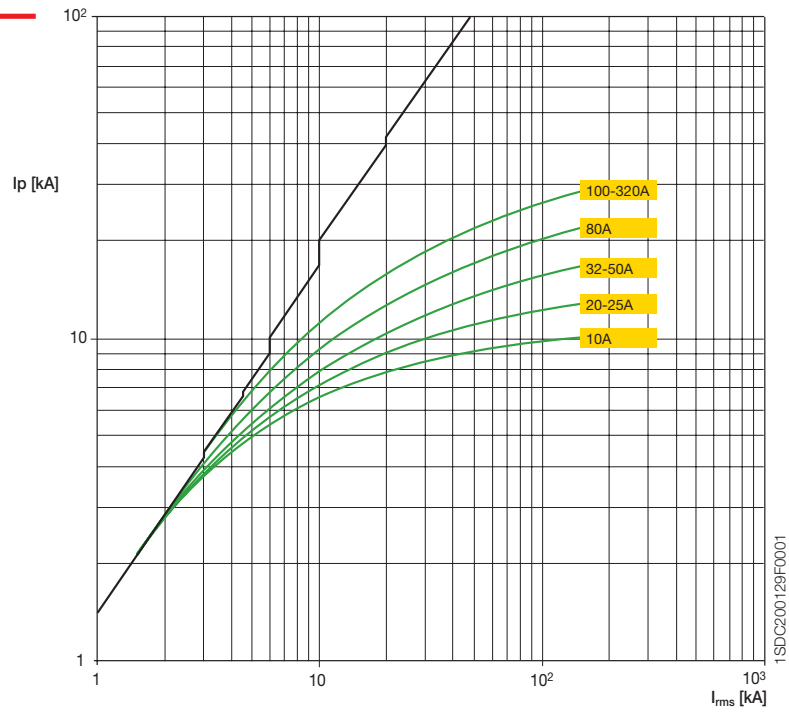

3 General characteristics

Limitation curves

T5 400/630

500 V

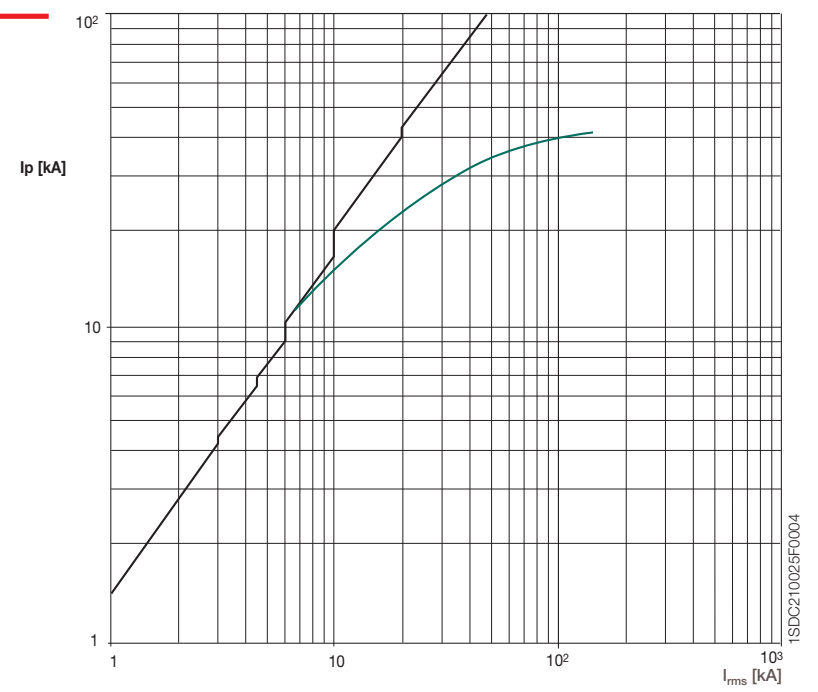

3 General characteristics

Limitation curves

T6 630/800/1000

500 V

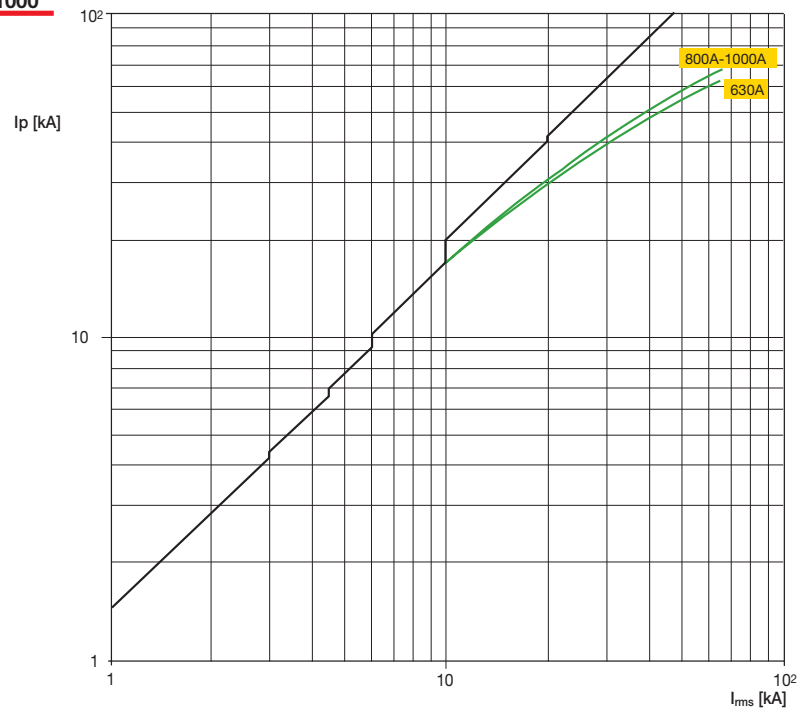

3 General characteristics

Limitation curves

T1 160

690 V

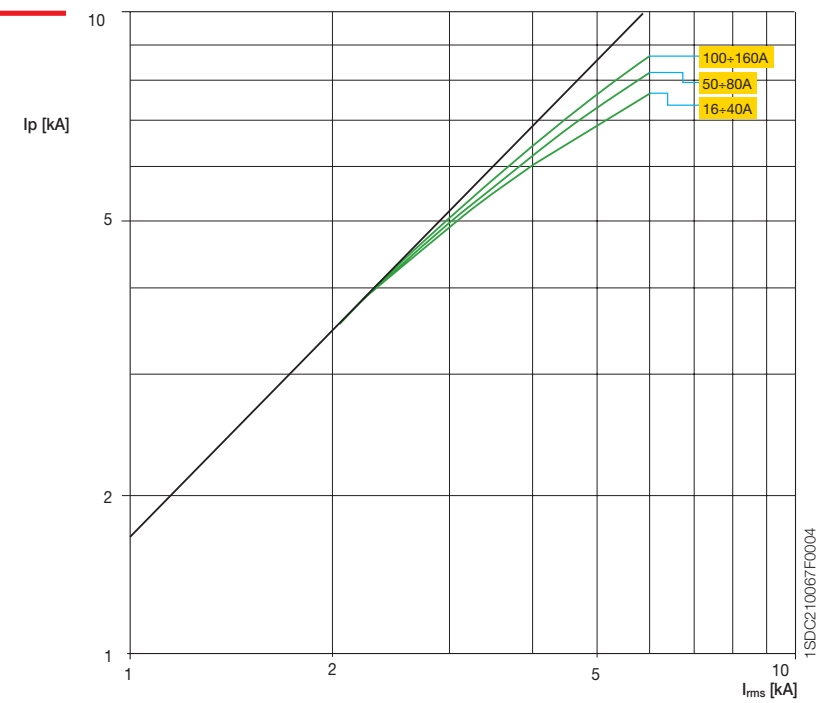

1SDC210067F0004

3 General characteristics

Limitation curves

T2 160

690 V

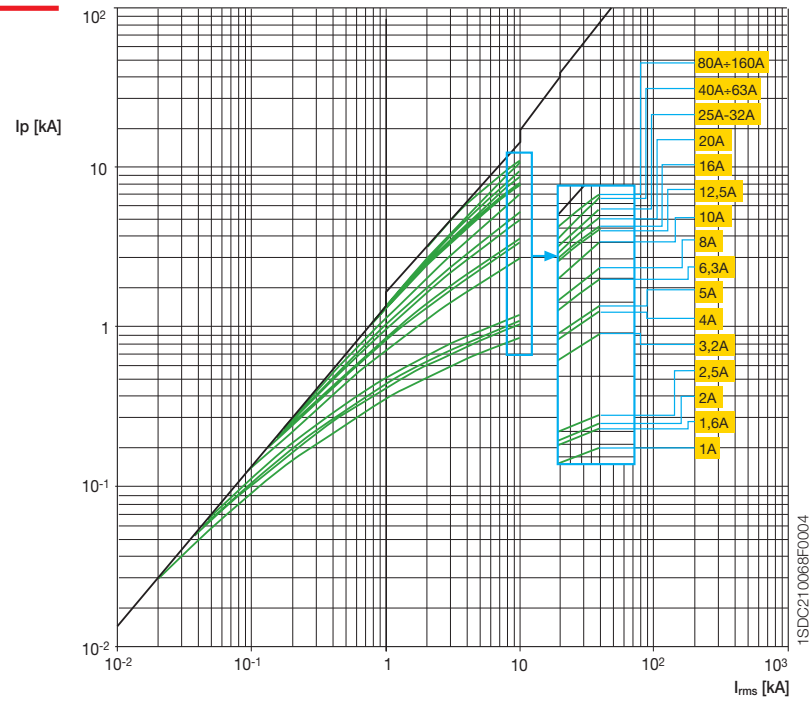

1SDC21 0068F0004

3 General characteristics

Limitation curves

T3 250

690 V

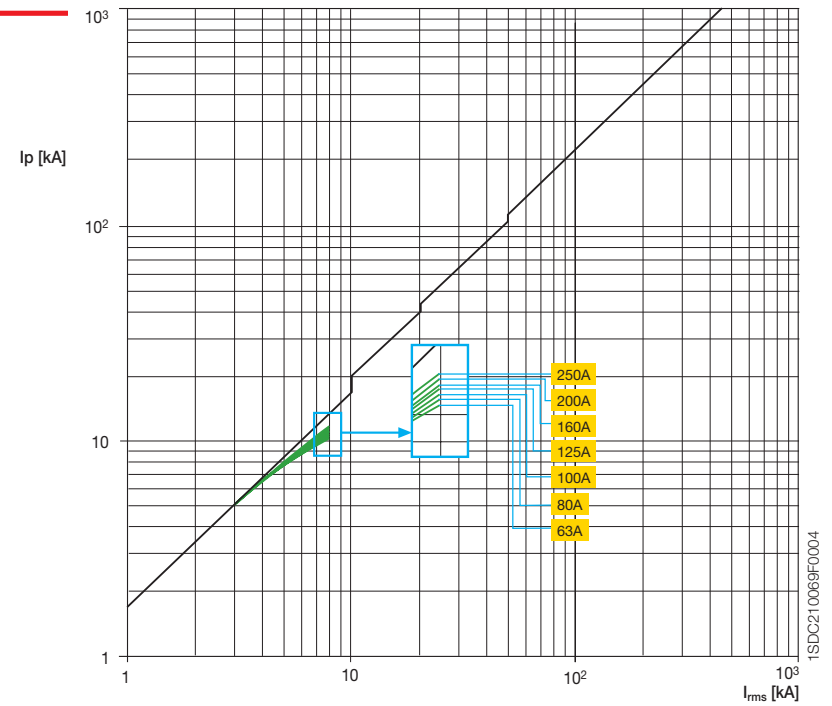

1SDC21 0069F0004

3 General characteristics

Limitation curves

T4 250/320

690 V

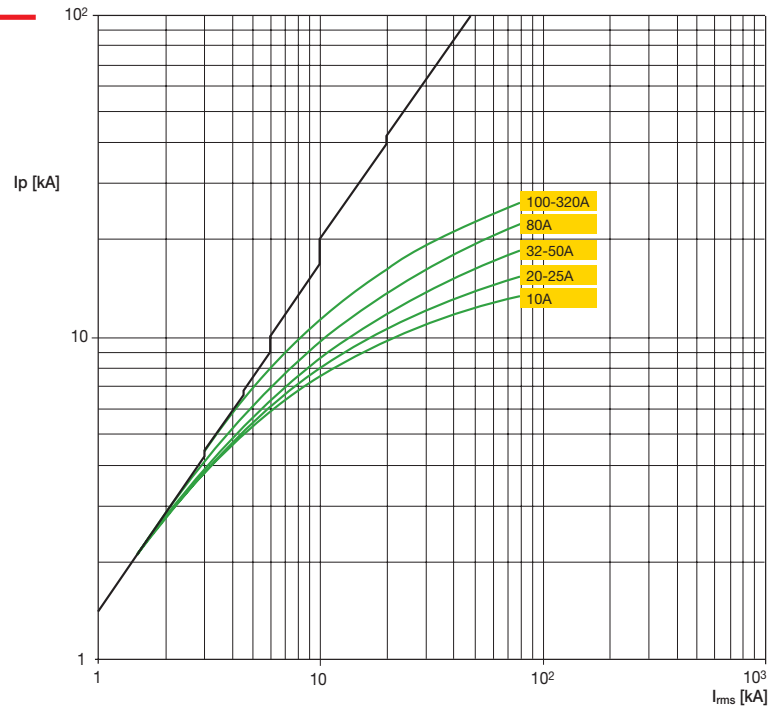

3 General characteristics

Limitation curves

T5 400/630

690 V

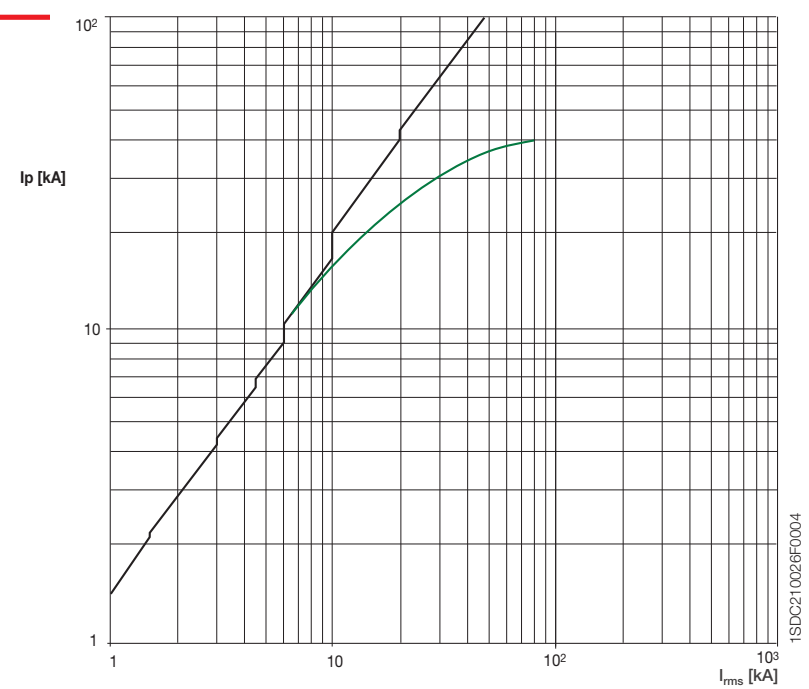

3 General characteristics

Limitation curves

T6 630/800/1000

690 V

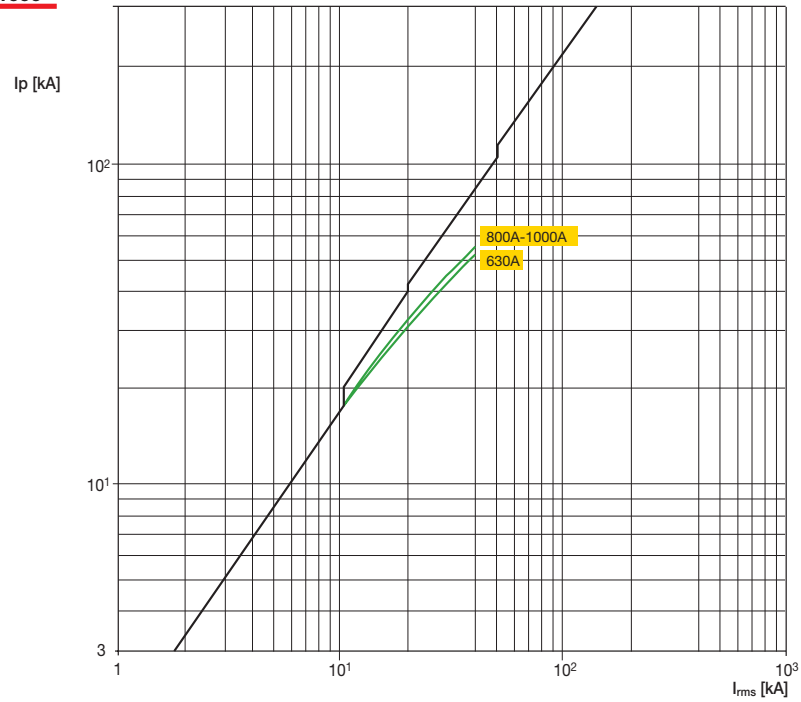

3 General characteristics

Limitation curves

S7 - S8

230 V

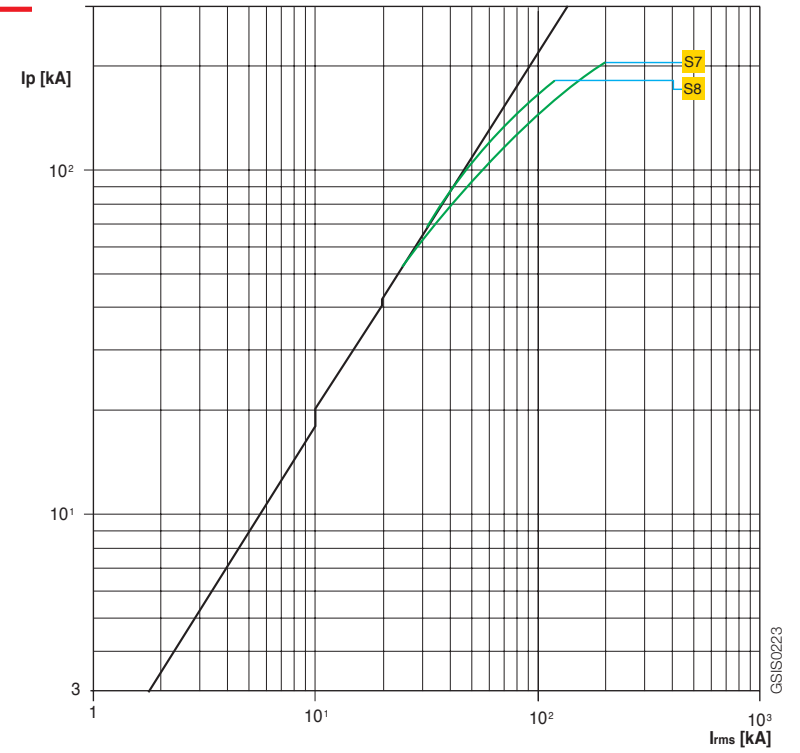

GSIS0223

3 General characteristics

Limitation curves

S7 - S8

400-440 V

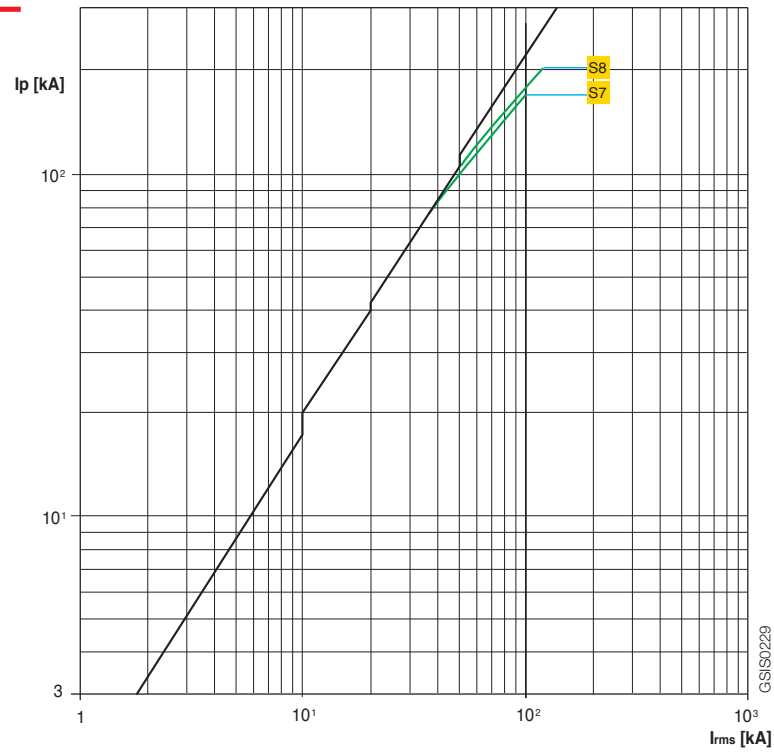

3 General characteristics

Limitation curves

S7 - S8

690 V

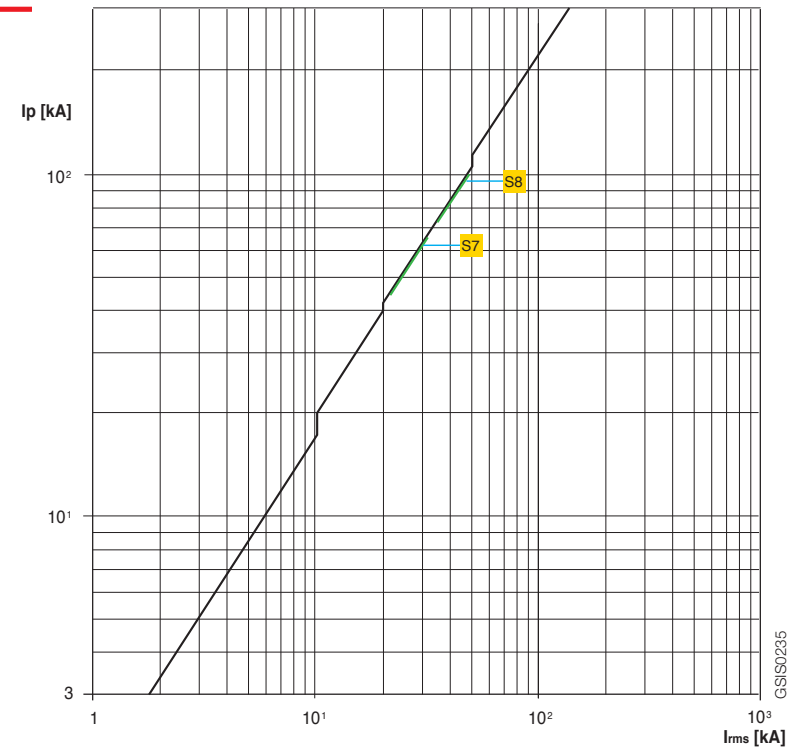

3 General characteristics

Limitation curves

E2L

690 V ~
380/415 V ~

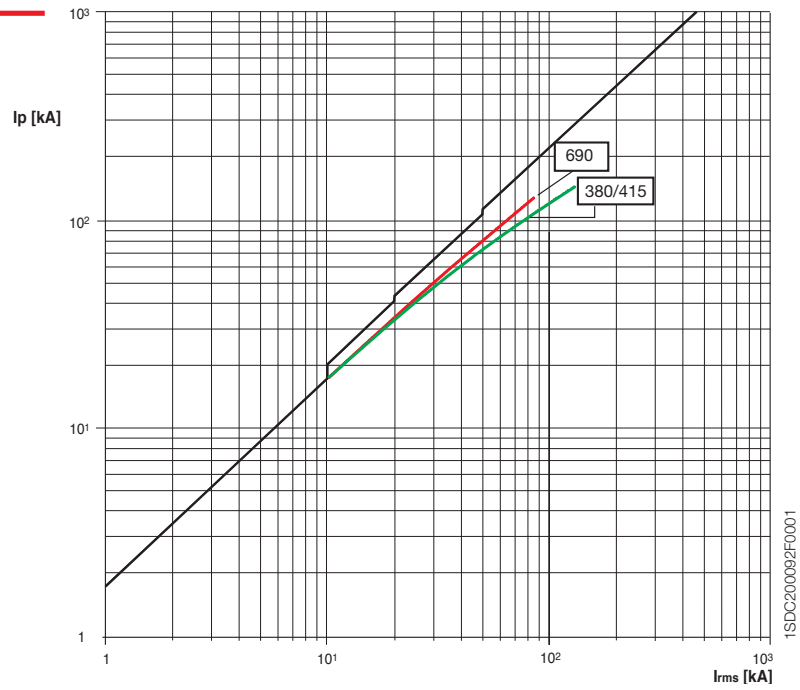

1SDC200092F0001

3 General characteristics

Limitation curves

E3L

690 V ~
380/415 V ~

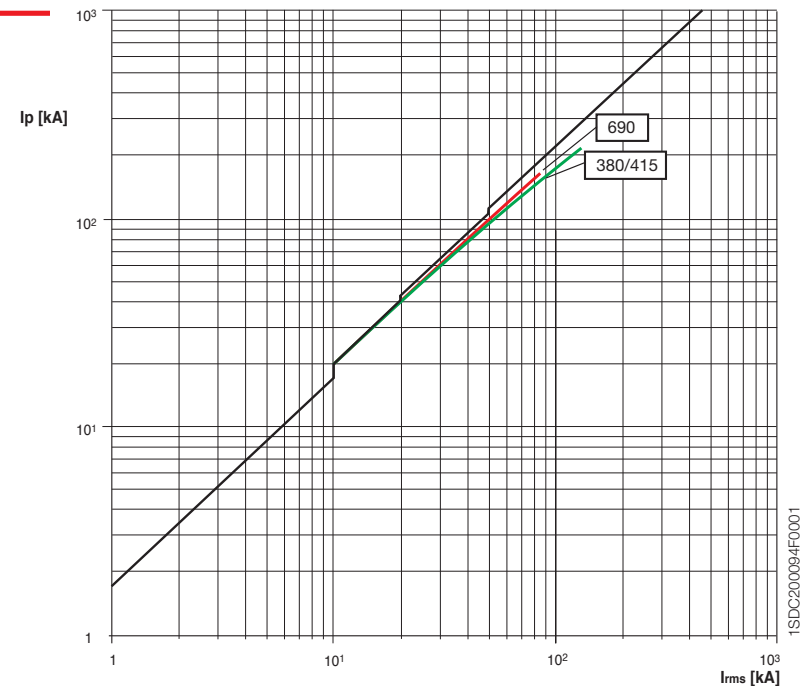

1SDC200094F0001

3 General characteristics

3.4 Specific let-through energy curves

In case of short-circuit, the parts of a plant affected by a fault are subjected to thermal stresses which are proportional both to the square of the fault current as well as to the time required by the protection device to break the current. The energy let through by the protection device during the trip is termed "specific let-through energy" (I^2t), measured in A^2s . The knowledge of the value of the specific let-through energy in various fault conditions is fundamental for the dimensioning and the protection of the various parts of the installation. The effect of limitation and the reduced trip times influence the value of the specific let-through energy. For those current values for which the tripping of the circuit-breaker is regulated by the timing of the release, the value of the specific let-through energy is obtained by multiplying the square of the effective fault current by the time required for the protection device to trip; in other cases the value of the specific let-through energy may be obtained from the following diagrams.

The following is an example of the reading from a diagram of the specific let-through energy curve for a circuit-breaker type T3S 250 In160 at 400 V. The x-axis shows the symmetrical prospective short-circuit current, while the y-axis shows the specific let-through energy values, expressed in $(kA)^2s$. Corresponding to a short-circuit current equal to 20 kA, the circuit-breaker lets through a value of I^2t equal to 1.17 $(kA)^2s$ (1170000 A^2s).

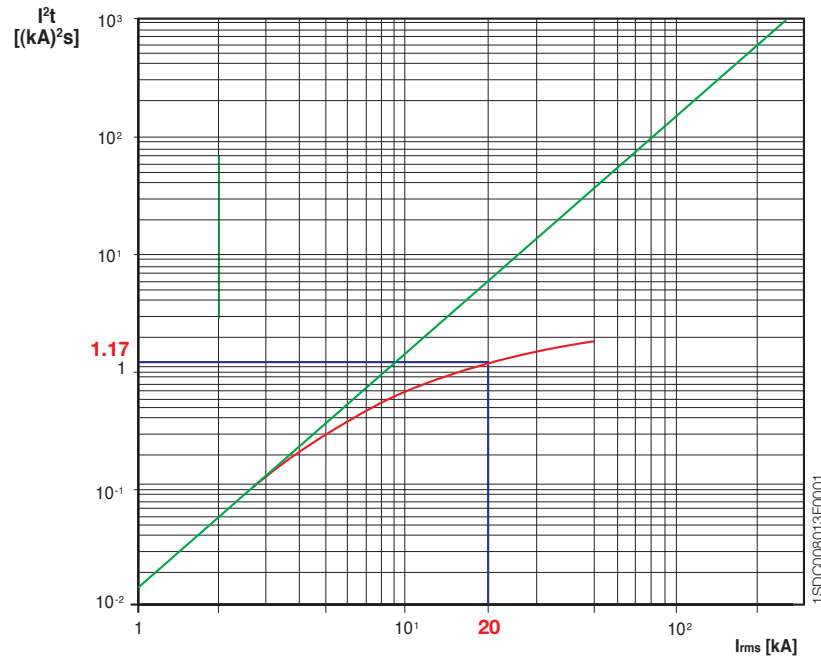

3 General characteristics

Specific let-through energy curves

T1 160

230 V

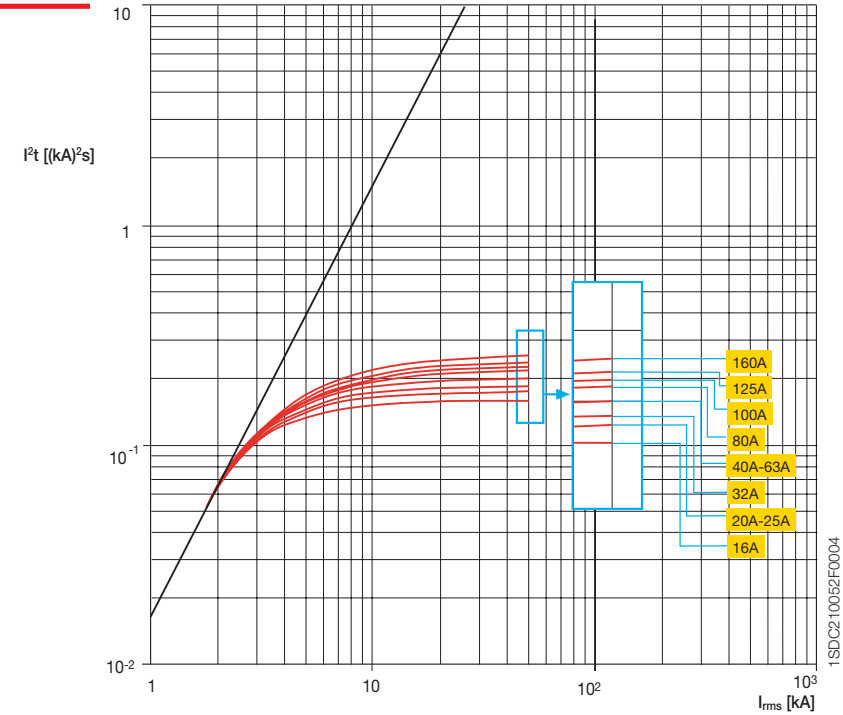

3 General characteristics

Specific let-through energy curves

T2 160

230 V

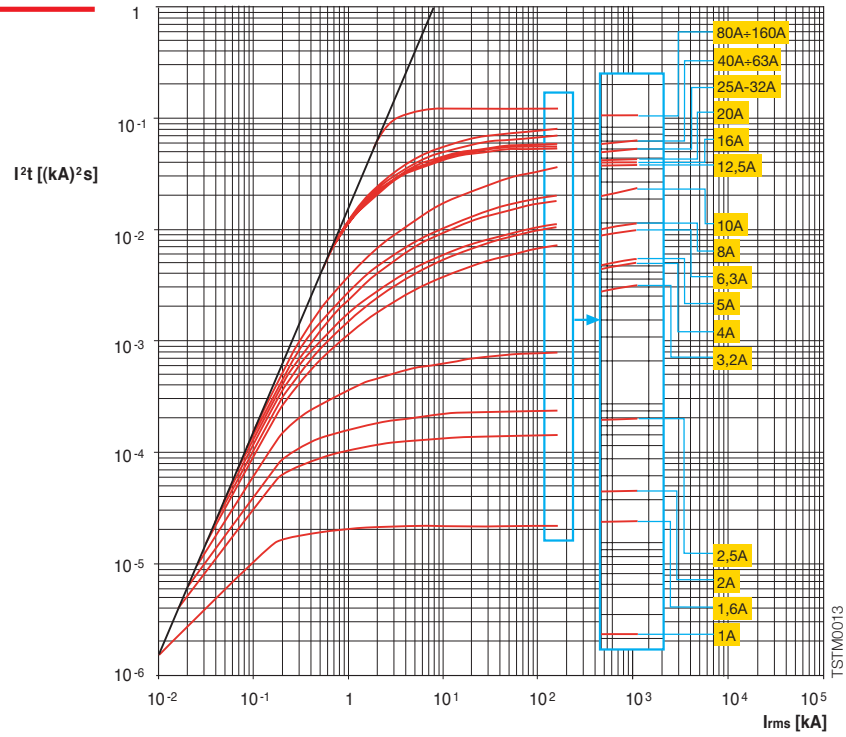

TSTM0013

3 General characteristics

Specific let-through energy curves

T3 250

230 V

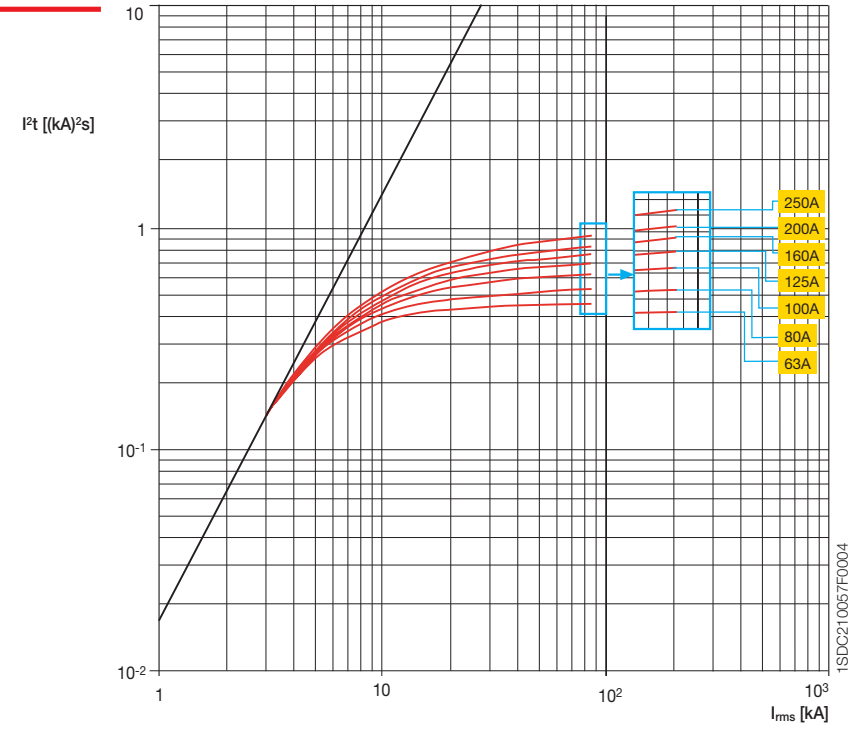

1SDC210057F0004

3 General characteristics

Specific let-through energy curves

T4 250/320

230 V

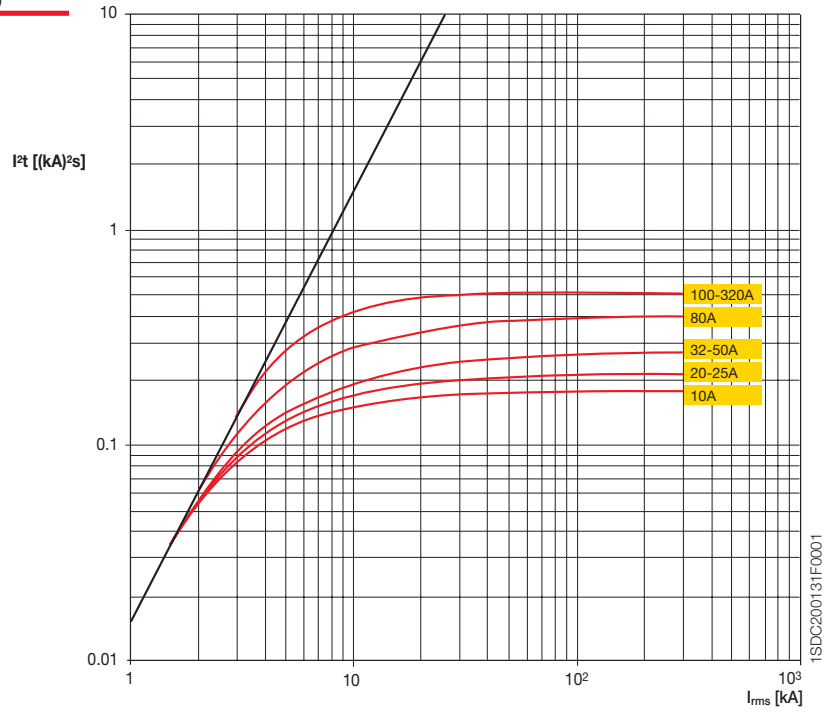

3 General characteristics

Specific let-through energy curves

T5 400/630

230 V

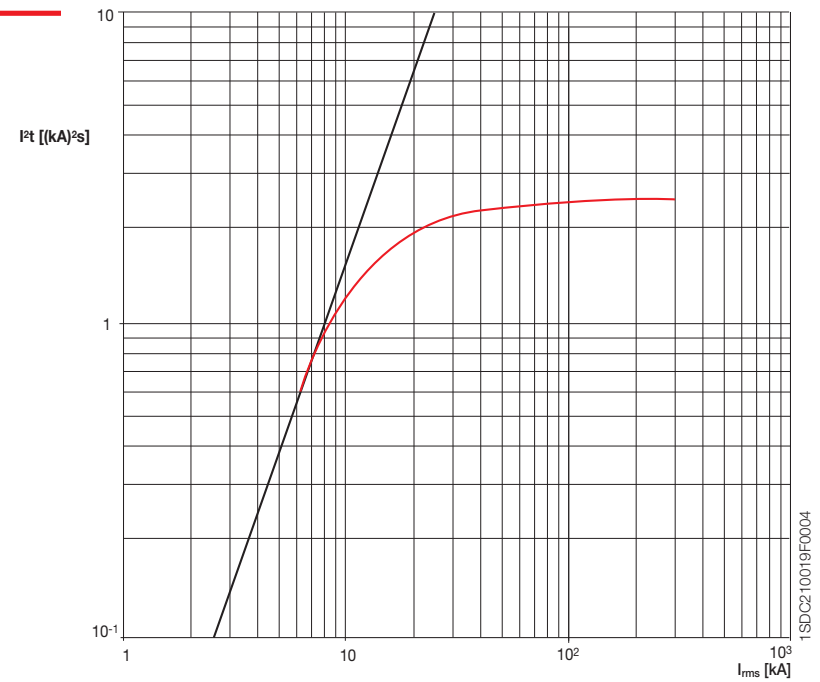

3 General characteristics

Specific let-through energy curves

T6 630/800/1000

230 V

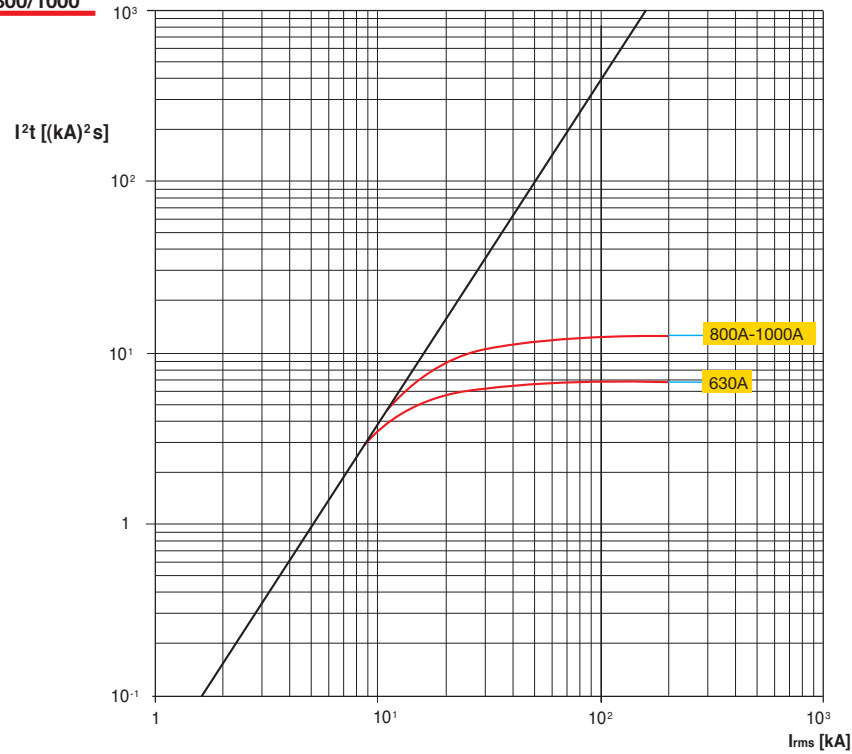

3 General characteristics

Specific let-through energy curves

T1 160

400-440 V

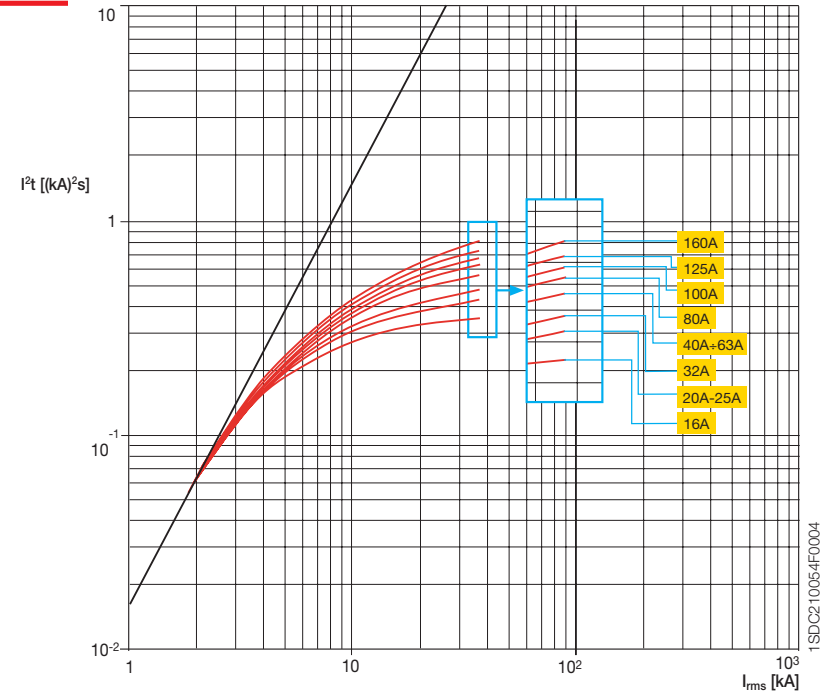

1SDC210054F0004

3 General characteristics

Specific let-through energy curves

T2 160

400-440 V

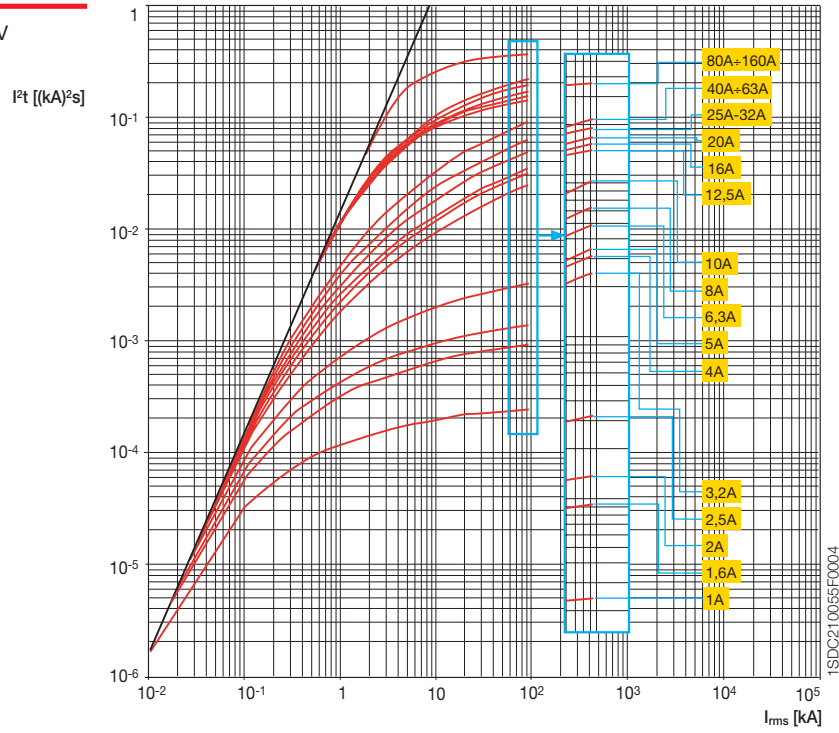

1SDC210066F0004

3 General characteristics

Specific let-through energy curves

T3 250

400-440 V

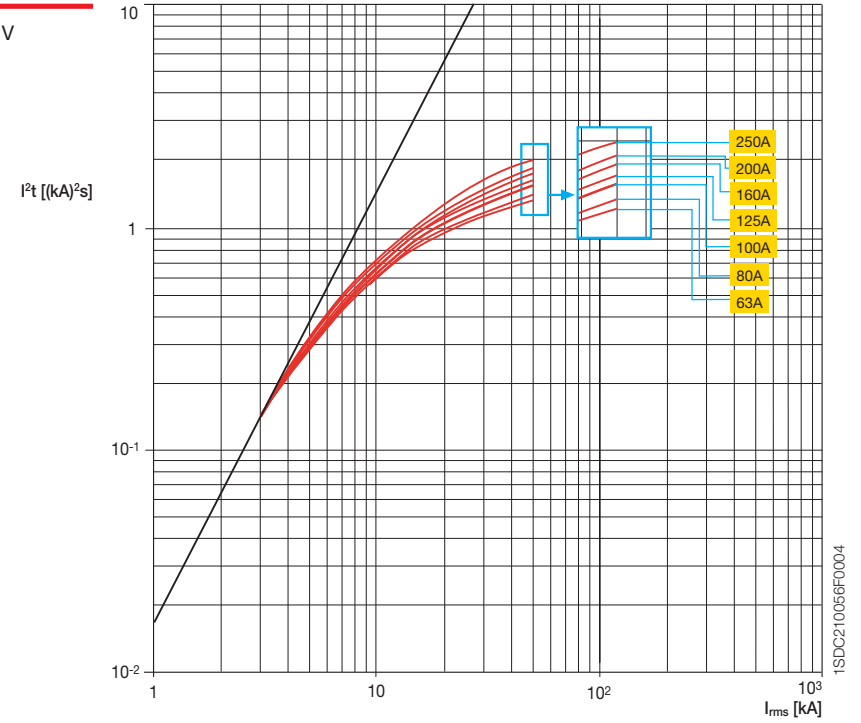

1SDC210066F0004

3 General characteristics

Specific let-through energy curves

T4 250/320

400-440 V

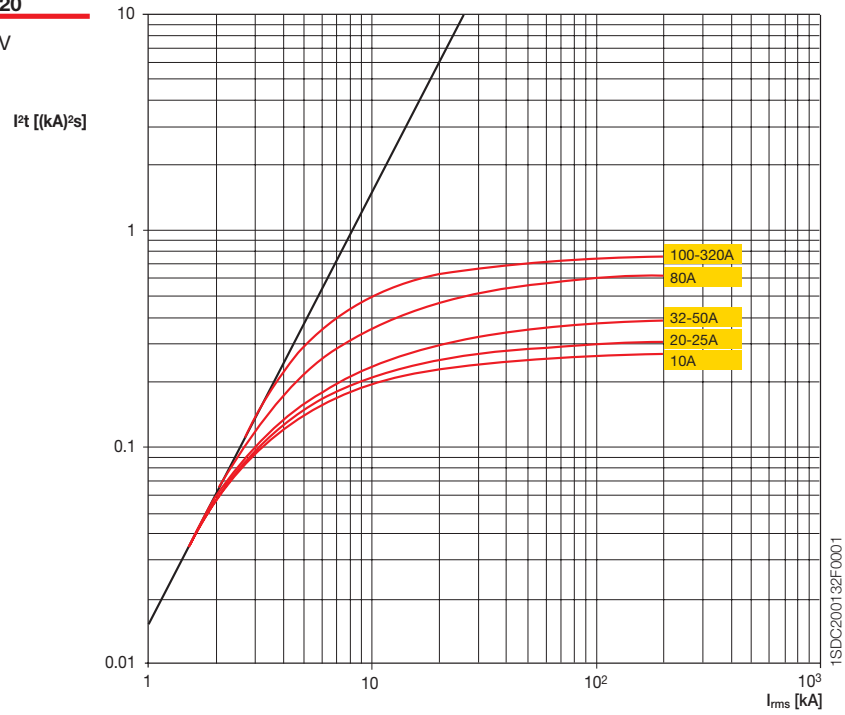

3 General characteristics

Specific let-through energy curves

T5 400/630

400-440 V

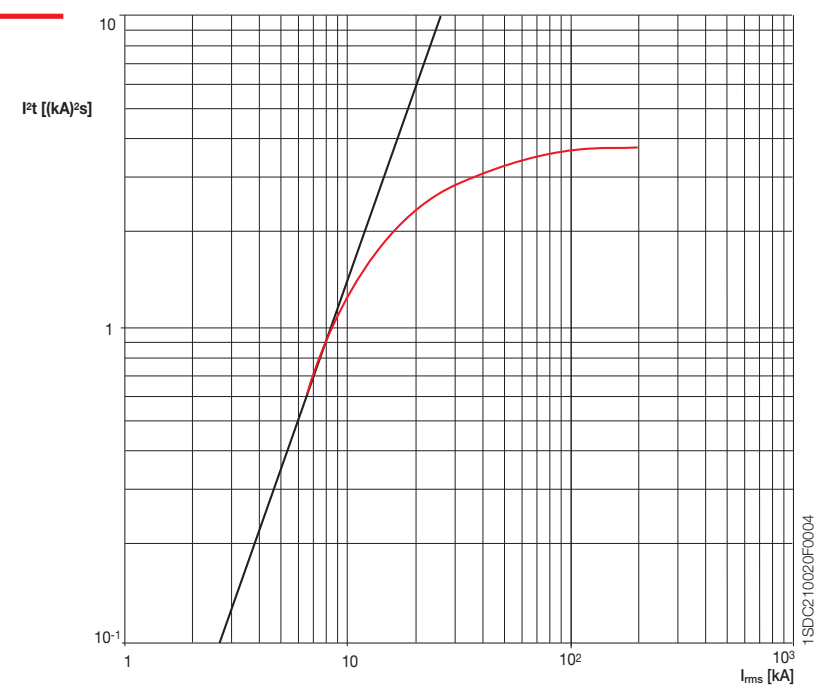

3 General characteristics

Specific let-through energy curves

T6 630/800/1000

400-440 V

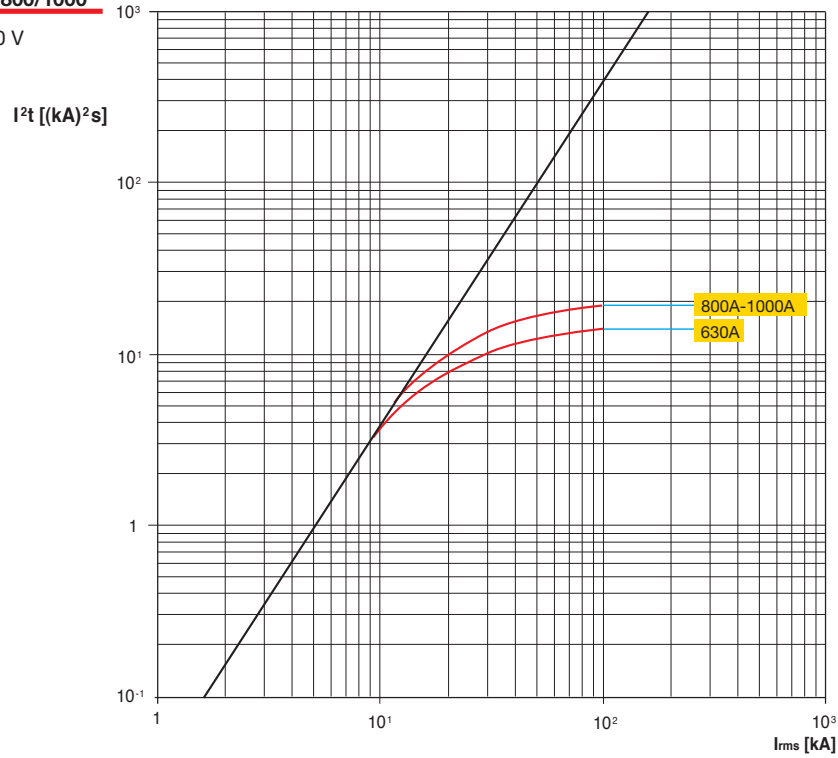

3 General characteristics

Specific let-through energy curves

T1 160

500 V

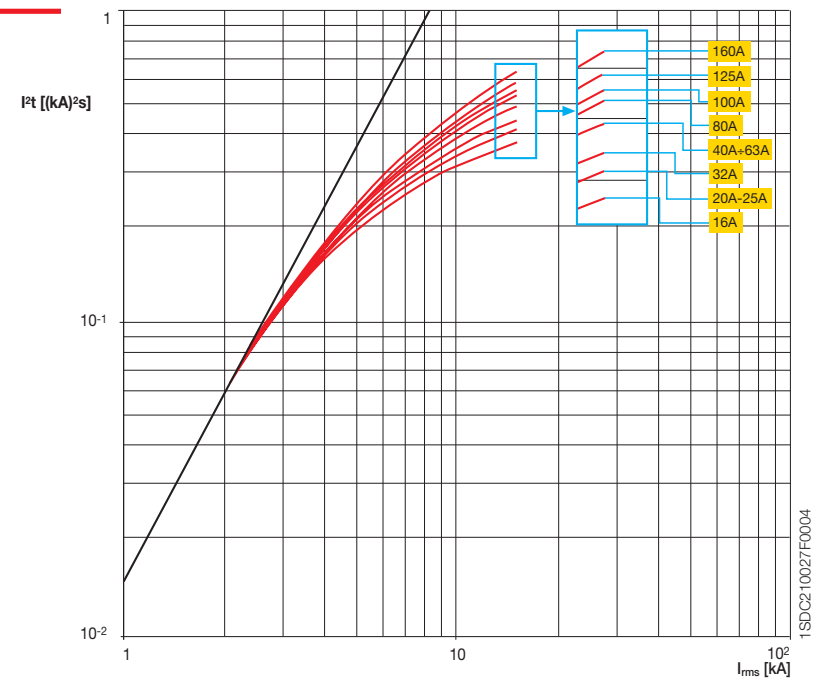

1SDC210027F0004

3 General characteristics

Specific let-through energy curves

T2 160

500 V

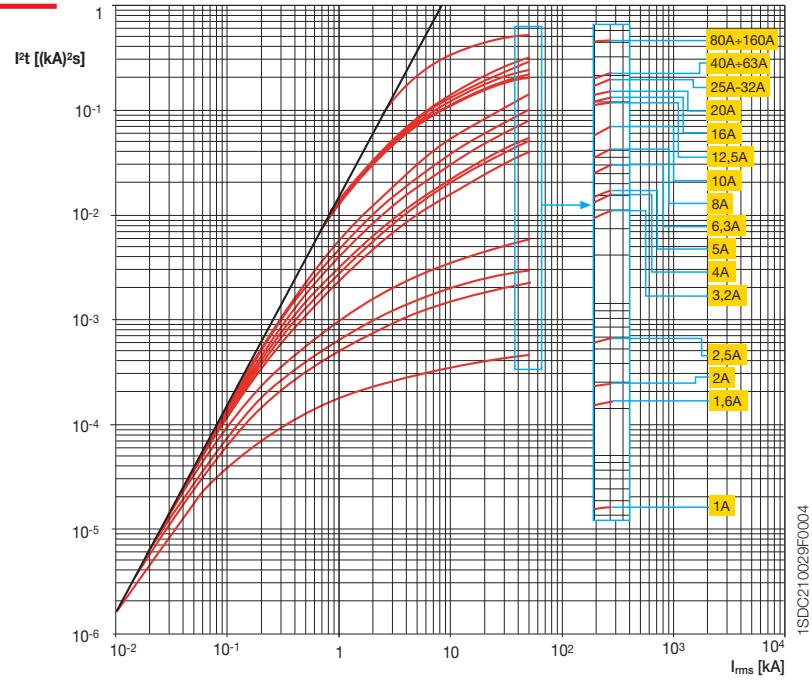

3 General characteristics

Specific let-through energy curves

T3 250

500 V

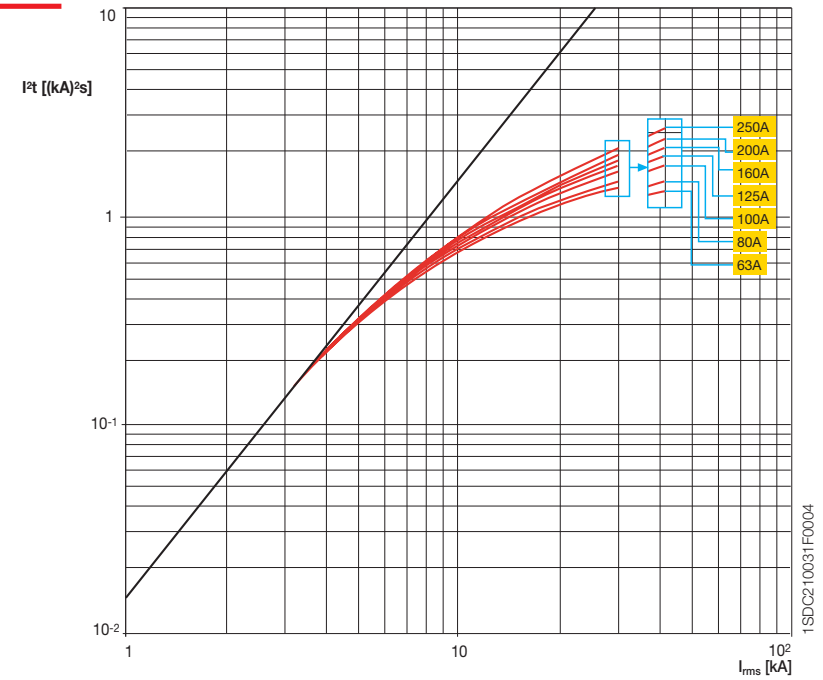

3 General characteristics

Specific let-through energy curves

T4 250/320

500 V

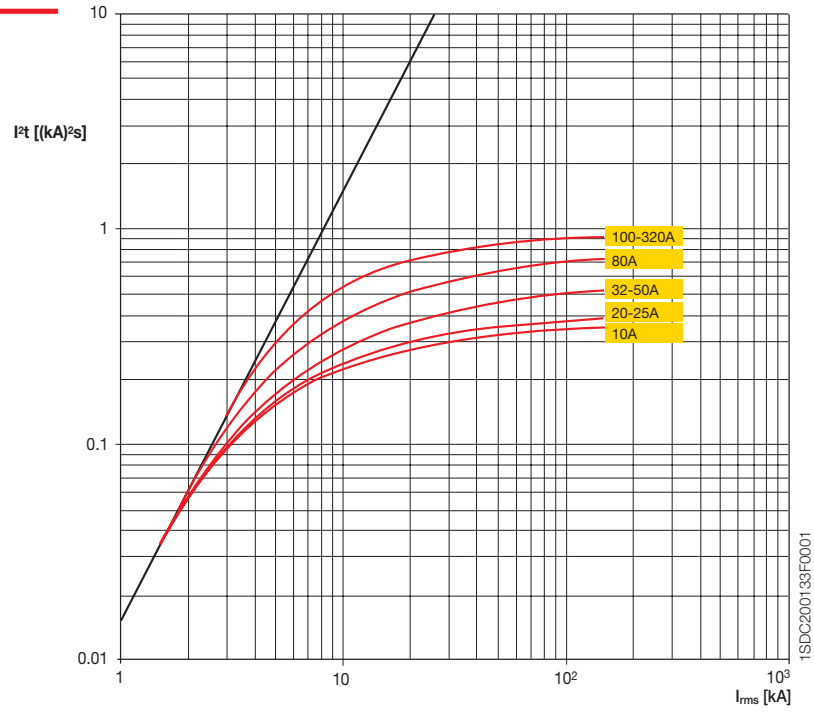

3 General characteristics

Specific let-through energy curves

T5 400/630

500 V

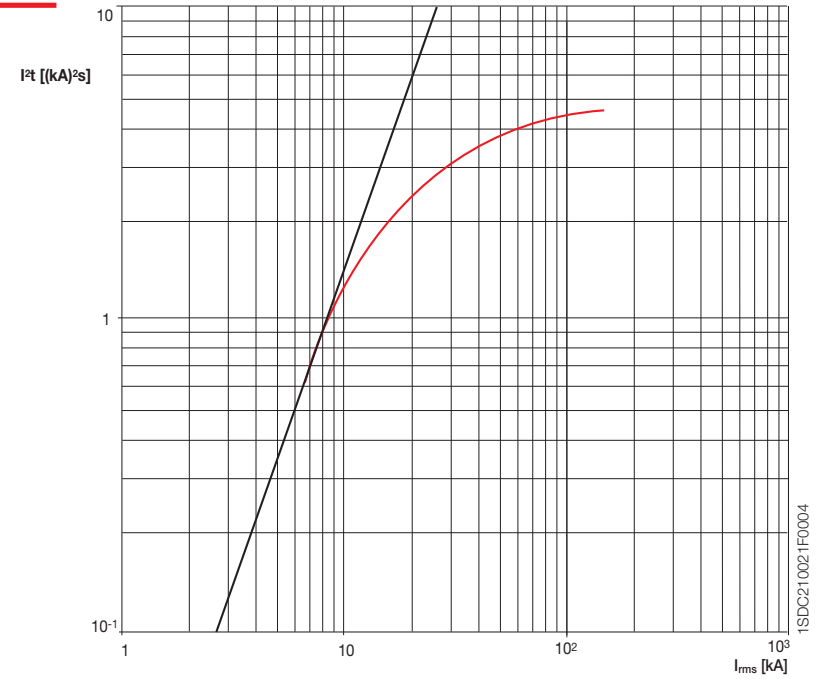

3 General characteristics

Specific let-through energy curves

T6 630/800/1000

500 V

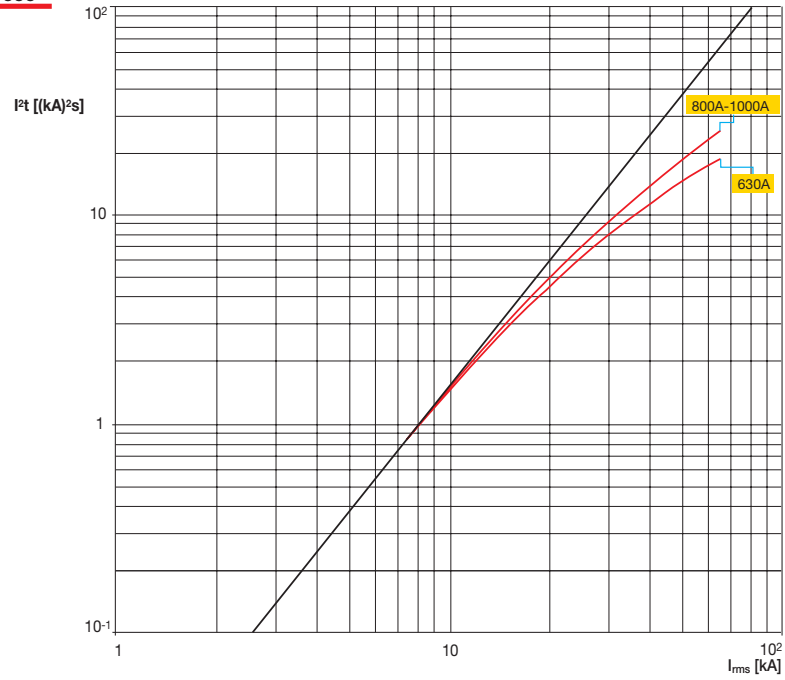

3 General characteristics

Specific let-through energy curves

T1 160

690 V

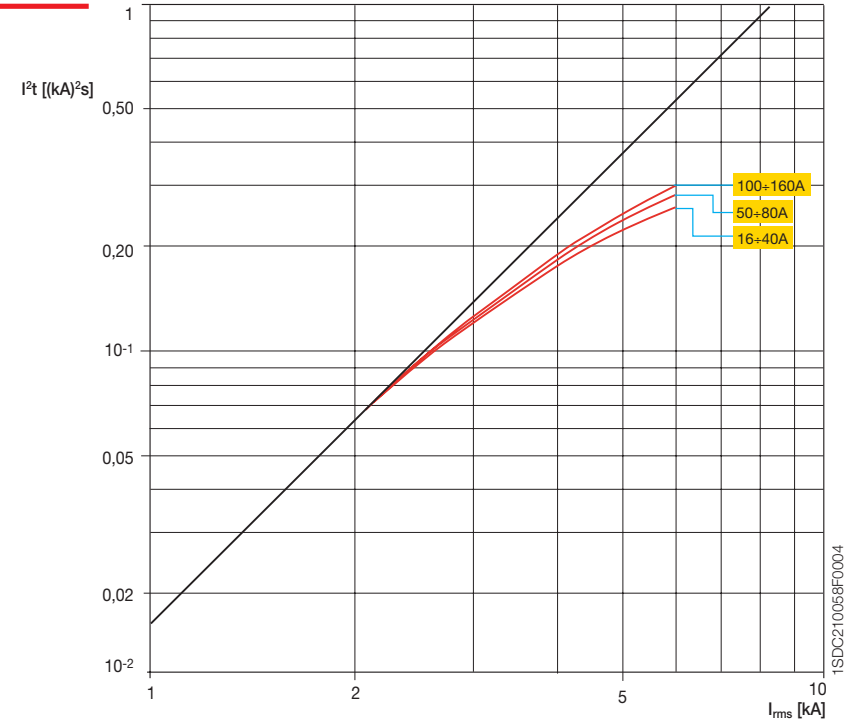

3 General characteristics

Specific let-through energy curves

T2 160

690 V

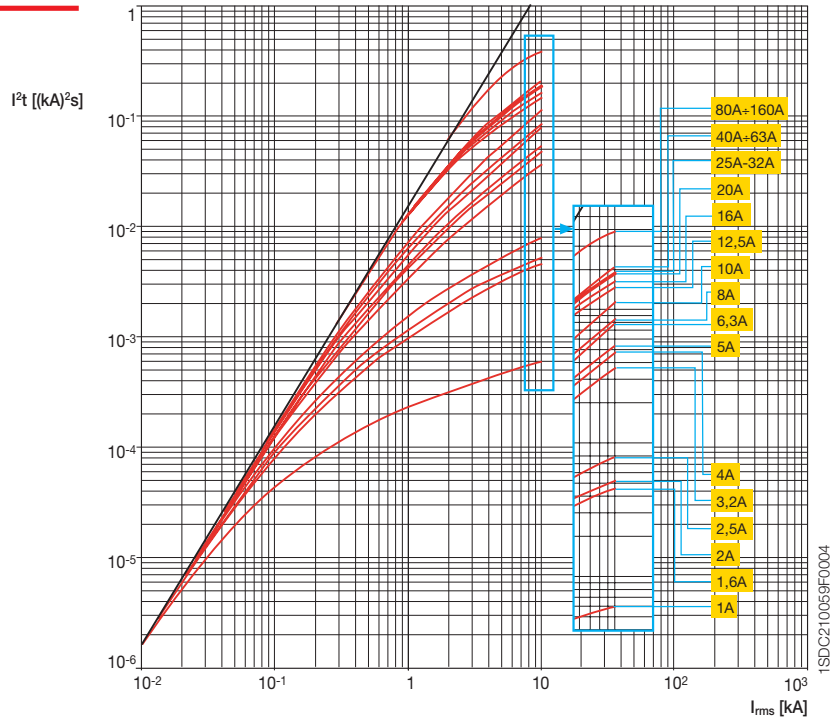

3 General characteristics

Specific let-through energy curves

T3 250

690 V

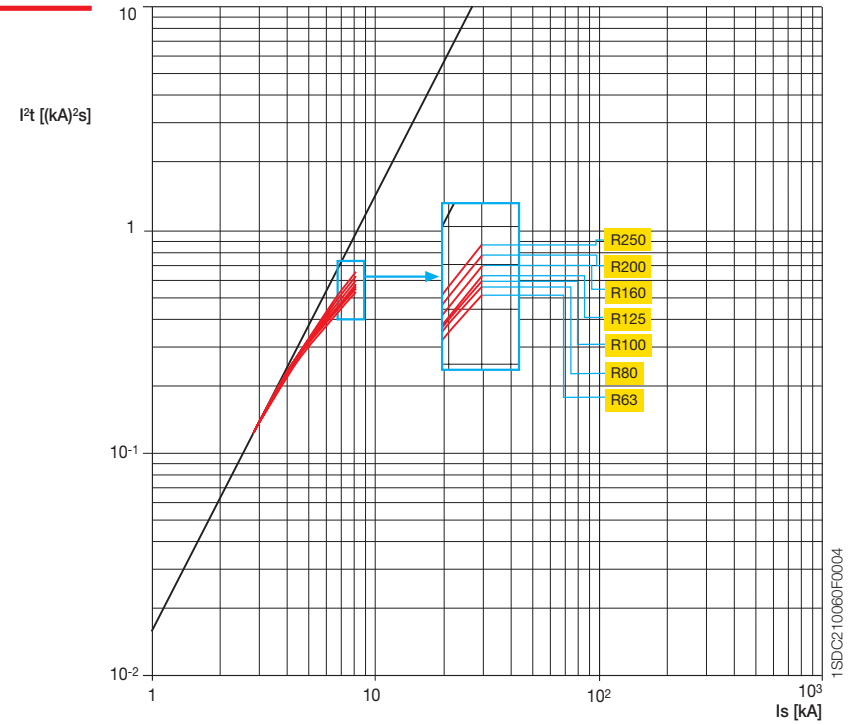

3 General characteristics

Specific let-through energy curves

T4 250/320

690 V

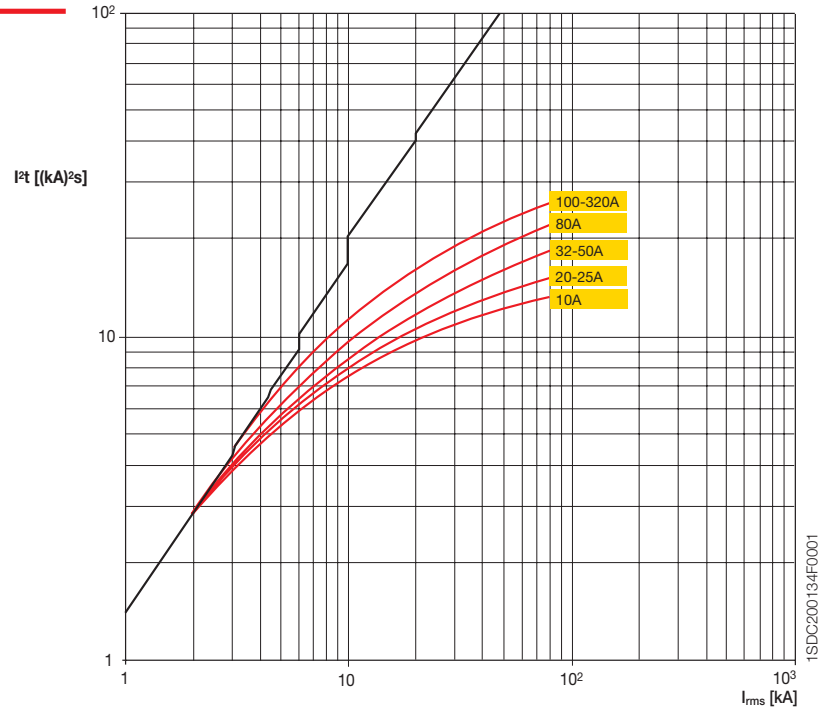

3 General characteristics

Specific let-through energy curves

T5 400/630

690 V

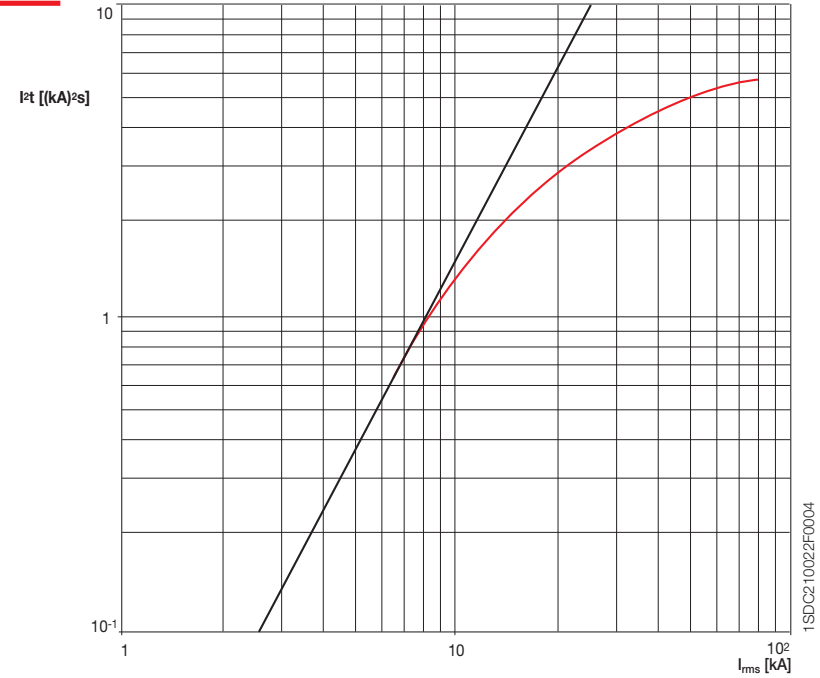

3 General characteristics

Specific let-through energy curves

T6 630/800/1000

690 V

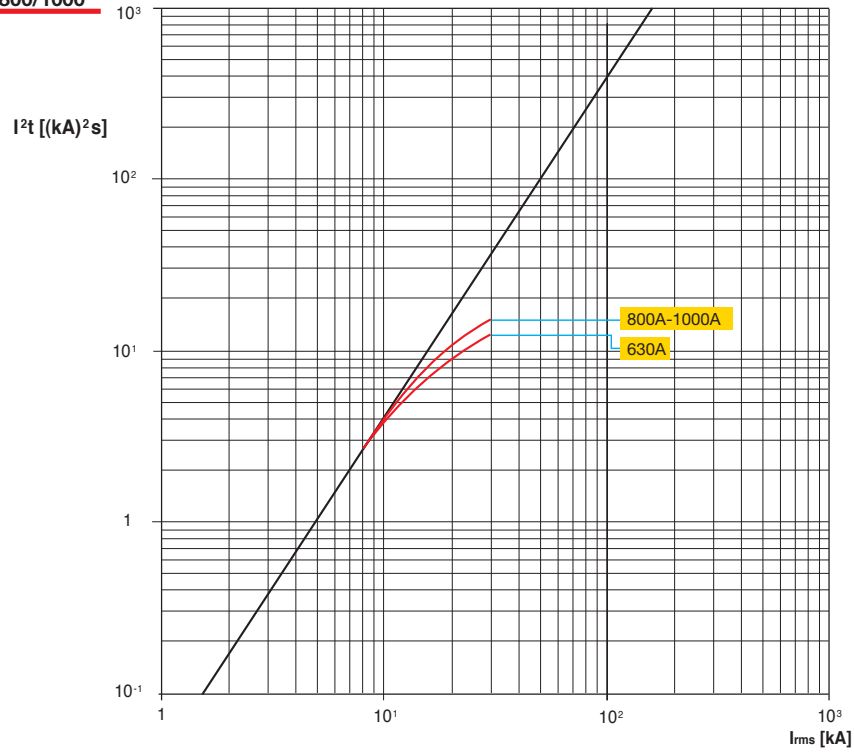

3 General characteristics

Specific let-through energy curves

S7 - S8

230 V

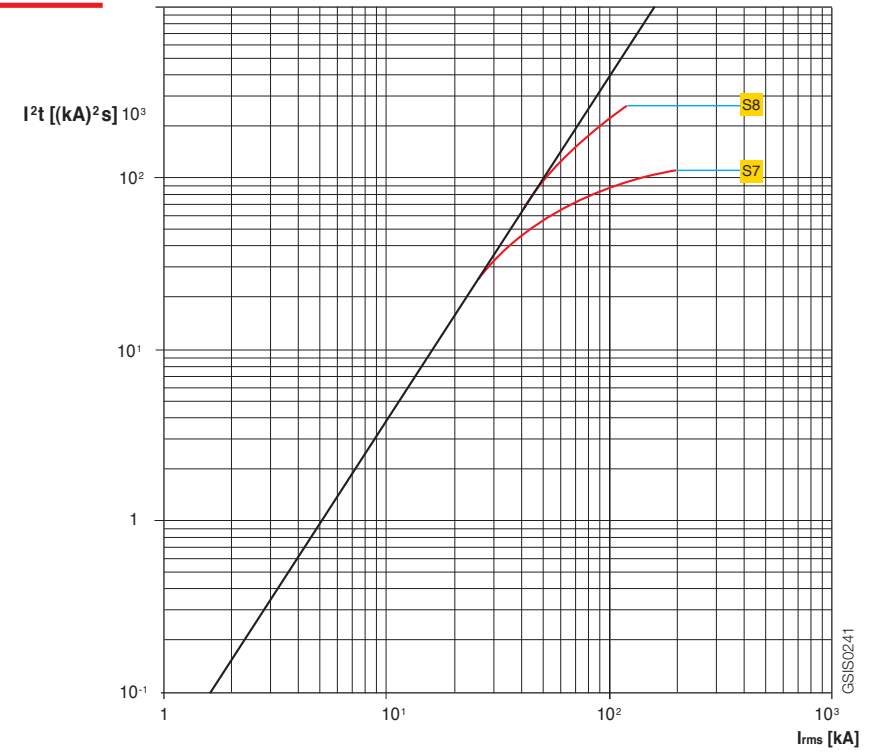

GSI0241

3 General characteristics

Specific let-through energy curves

S7 - S8

400-440 V

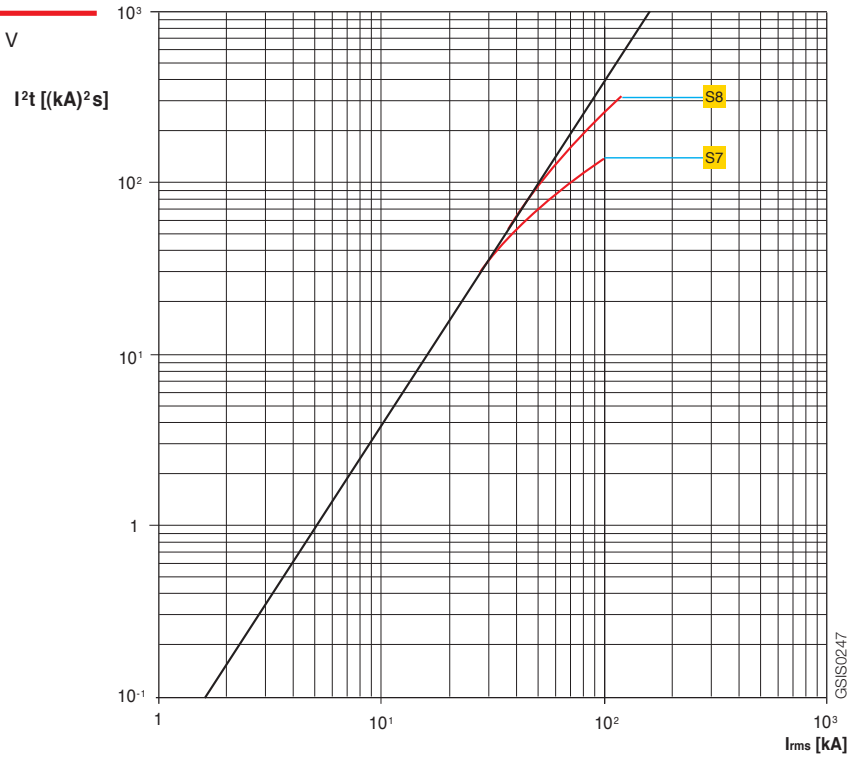

GSIS0247

3 General characteristics

Specific let-through energy curves

S7 - S8

690 V

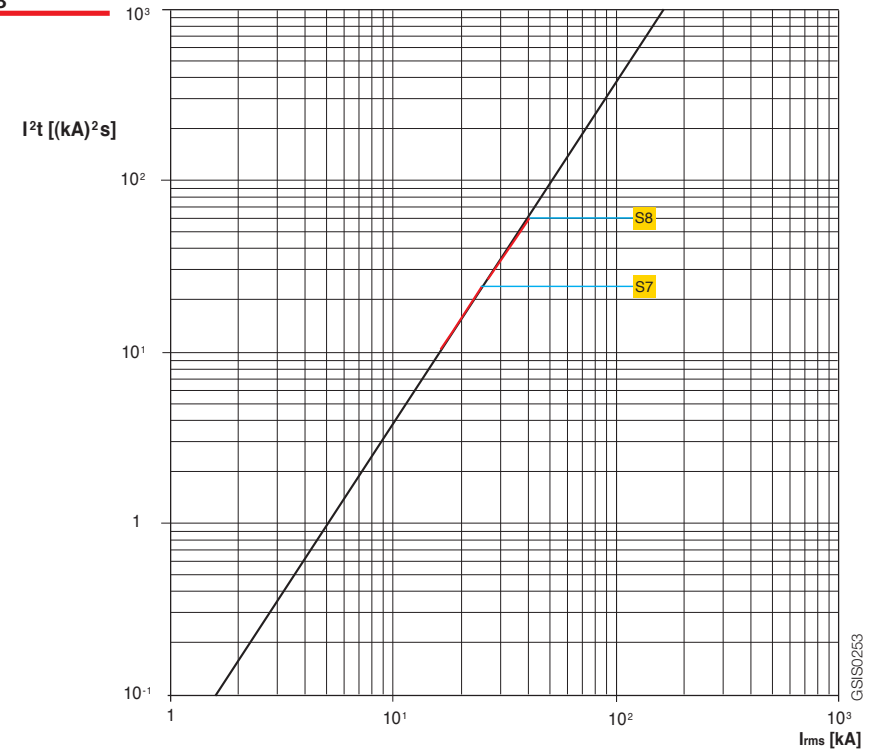

GSIS0253

3 General characteristics

Specific let-through energy curves

E2L

690 V~
380/415 V~

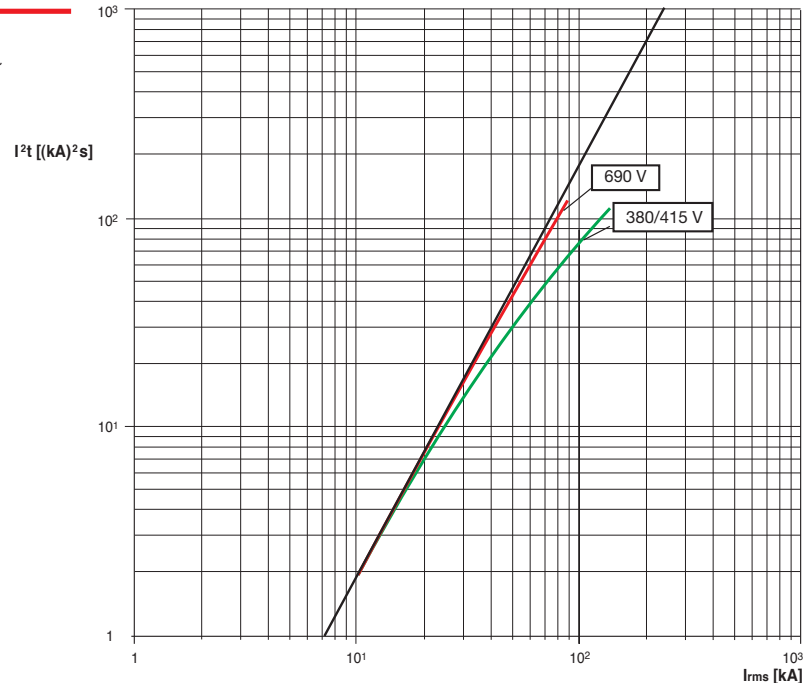

3 General characteristics

Specific let-through energy curves

E3L

690 V~
380/415 V~

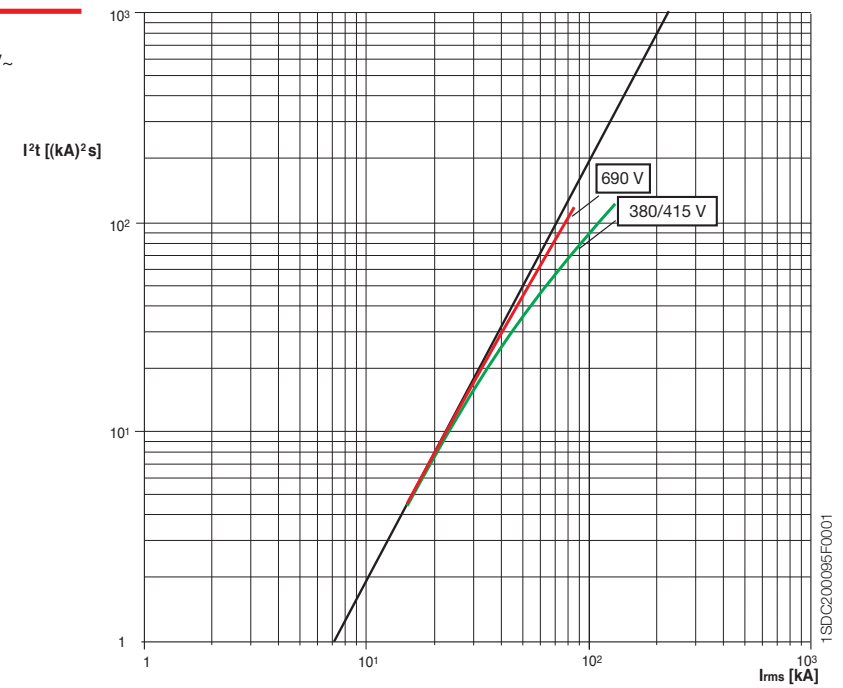

3 General characteristics

3.5 Temperature derating

Standard IEC 60947-2 states that the temperature rise limits for circuit-breakers working at rated current must be within the limits given in the following table:

Table 1 - Temperature rise limits for terminals and accessible parts

Description of part*	Temperature rise limits	
	K	
- Terminal for external connections	80	
- Manual operating means:	metallic	25
	non metallic	35
- Parts intended to be touched but not hand-held:	metallic	40
	non metallic	50
- Parts which need not be touched for normal operation:	metallic	50
	non metallic	60

* No value is specified for parts other than those listed but no damage should be caused to adjacent parts of insulating materials.

These values are valid for a maximum reference ambient temperature of 40°C, as stated in Standard IEC 60947-1, clause 6.1.1.

Whenever the ambient temperature is other than 40°C, the value of the current which can be carried continuously by the circuit-breaker is given in the following tables:

Circuit-breakers with thermomagnetic release

Tmax T1 and T1 1P (*)

In [A]	10 °C		20 °C		30 °C		40 °C		50 °C		60 °C		70 °C	
	MIN	MAX	MIN	MAX	MIN	MAX	MIN	MAX	MIN	MAX	MIN	MAX	MIN	MAX
16	13	18	12	18	11	17	11	16	10	15	10	14	9	13
20	16	23	15	22	15	21	14	20	13	19	12	18	11	16
25	20	29	19	28	18	26	18	25	16	23	15	22	14	20
32	26	37	25	35	24	34	22	32	21	30	20	28	18	26
40	32	46	31	44	29	42	28	40	26	38	25	35	23	33
50	40	58	39	55	37	53	35	50	33	47	31	44	28	41
63	51	72	49	69	46	66	44	63	41	59	39	55	36	51
80	64	92	62	88	59	84	56	80	53	75	49	70	46	65
100	81	115	77	110	74	105	70	100	66	94	61	88	57	81
125	101	144	96	138	92	131	88	125	82	117	77	109	71	102
160	129	184	123	176	118	168	112	160	105	150	98	140	91	130

(*) For the T1 1P circuit-breaker (fitted with TMF fixed thermomagnetic release), consider only the column corresponding to the maximum adjustment of the TMD releases.

3 General characteristics

Tmax T2

In [A]	10 °C		20 °C		30 °C		40 °C		50 °C		60 °C		70 °C	
	MIN	MAX	MIN	MAX	MIN	MAX	MIN	MAX	MIN	MAX	MIN	MAX	MIN	MAX
1	0.8	1.1	0.8	1.1	0.7	1.1	0.7	1.0	0.7	0.9	0.6	0.9	0.6	0.8
1.6	1.3	1.8	1.2	1.8	1.2	1.7	1.1	1.6	1.0	1.5	1.0	1.4	0.9	1.3
2	1.6	2.3	1.5	2.2	1.5	2.1	1.4	2.0	1.3	1.9	1.2	1.7	1.1	1.6
2.5	2.0	2.9	1.9	2.8	1.8	2.6	1.8	2.5	1.6	2.3	1.5	2.2	1.4	2.0
3.2	2.6	3.7	2.5	3.5	2.4	3.4	2.2	3.2	2.1	3.0	1.9	2.8	1.8	2.6
4	3.2	4.6	3.1	4.4	2.9	4.2	2.8	4.0	2.6	3.7	2.4	3.5	2.3	3.2
5	4.0	5.7	3.9	5.5	3.7	5.3	3.5	5.0	3.3	4.7	3.0	4.3	2.8	4.0
6.3	5.1	7.2	4.9	6.9	4.6	6.6	4.4	6.3	4.1	5.9	3.8	5.5	3.6	5.1
8	6.4	9.2	6.2	8.8	5.9	8.4	5.6	8.0	5.2	7.5	4.9	7.0	4.5	6.5
10	8.0	11.5	7.7	11.0	7.4	10.5	7.0	10.0	6.5	9.3	6.1	8.7	5.6	8.1
12.5	10.1	14.4	9.6	13.8	9.2	13.2	8.8	12.5	8.2	11.7	7.6	10.9	7.1	10.1
16	13	18	12	18	12	17	11	16	10	15	10	14	9	13
20	16	23	15	22	15	21	14	20	13	19	12	17	11	16
25	20	29	19	28	18	26	18	25	16	23	15	22	14	20
32	26	37	25	35	24	34	22	32	21	30	19	28	18	26
40	32	46	31	44	29	42	28	40	26	37	24	35	23	32
50	40	57	39	55	37	53	35	50	33	47	30	43	28	40
63	51	72	49	69	46	66	44	63	41	59	38	55	36	51
80	64	92	62	88	59	84	56	80	52	75	49	70	45	65
100	80	115	77	110	74	105	70	100	65	93	61	87	56	81
125	101	144	96	138	92	132	88	125	82	117	76	109	71	101
160	129	184	123	178	118	168	112	160	105	150	97	139	90	129

Tmax T3

In [A]	10 °C		20 °C		30 °C		40 °C		50 °C		60 °C		70 °C	
	MIN	MAX	MIN	MAX	MIN	MAX	MIN	MAX	MIN	MAX	MIN	MAX	MIN	MAX
63	51	72	49	69	46	66	44	63	41	59	38	55	35	51
80	64	92	62	88	59	84	56	80	52	75	48	69	45	64
100	80	115	77	110	74	105	70	100	65	93	61	87	56	80
125	101	144	96	138	92	132	88	125	82	116	76	108	70	100
160	129	184	123	176	118	168	112	160	104	149	97	139	90	129
200	161	230	154	220	147	211	140	200	130	186	121	173	112	161
250	201	287	193	278	184	263	175	250	163	233	152	216	141	201

3 General characteristics

Tmax T4

In [A]	10 °C		20 °C		30 °C		40 °C		50 °C		60 °C		70 °C	
	MIN	MAX	MIN	MAX	MIN	MAX	MIN	MAX	MIN	MAX	MIN	MAX	MIN	MAX
20	19	27	18	24	16	23	14	20	12	17	10	15	8	13
32	26	43	24	39	22	36	19	32	16	27	14	24	11	21
50	37	62	35	58	33	54	30	50	27	46	25	42	22	39
80	59	98	55	92	52	86	48	80	44	74	40	66	32	58
100	83	118	80	113	74	106	70	100	66	95	59	85	49	75
125	103	145	100	140	94	134	88	125	80	115	73	105	63	95
160	130	185	124	176	118	168	112	160	106	150	100	104	90	130
200	162	230	155	220	147	210	140	200	133	190	122	175	107	160
250	200	285	193	275	183	262	175	250	168	240	160	230	150	220

Tmax T5

In [A]	10 °C		20 °C		30 °C		40 °C		50 °C		60 °C		70 °C	
	MIN	MAX	MIN	MAX	MIN	MAX	MIN	MAX	MIN	MAX	MIN	MAX	MIN	MAX
320	260	368	245	350	234	335	224	320	212	305	200	285	182	263
400	325	465	310	442	295	420	280	400	265	380	250	355	230	325
500	435	620	405	580	380	540	350	500	315	450	280	400	240	345

Tmax T6

In [A]	10 °C		20 °C		30 °C		40 °C		50 °C		60 °C		70 °C	
	MIN	MAX	MIN	MAX	MIN	MAX	MIN	MAX	MIN	MAX	MIN	MAX	MIN	MAX
630	520	740	493	705	462	660	441	630	405	580	380	540	350	500
800	685	965	640	905	605	855	560	800	520	740	470	670	420	610

3 General characteristics

Circuit-breakers with electronic release

Tmax T2 160

Fixed	up to 40 °C		50 °C		60 °C		70 °C	
	I _{max} [A]	I _t	I _{max} [A]	I _t	I _{max} [A]	I _t	I _{max} [A]	I _t
F	160	1	153.6	0.96	140.8	0.88	128	0.8
EF	160	1	153.6	0.96	140.8	0.88	128	0.8
ES	160	1	153.6	0.96	140.8	0.88	128	0.8
FC Cu	160	1	153.6	0.96	140.8	0.88	128	0.8
FC Cu	160	1	153.6	0.96	140.8	0.88	128	0.8
R	160	1	153.6	0.96	140.8	0.88	128	0.8

F = Front flat terminals; EF = Front extended terminals; ES = Front extended spread terminals;
FC Cu = Front terminals for copper cables; FC CuAl = Front terminals for CuAl cables; R = Rear terminals

Tmax T4 250

Fixed	up to 40 °C		50 °C		60 °C		70 °C	
	I _{max} [A]	I _t	I _{max} [A]	I _t	I _{max} [A]	I _t	I _{max} [A]	I _t
FC	250	1	250	1	250	1	230	0.92
F	250	1	250	1	250	1	230	0.92
HR	250	1	250	1	250	1	220	0.88
VR	250	1	250	1	250	1	220	0.88

Plug-in - Withdrawable

FC	250	1	250	1	240	0.96	220	0.88
F	250	1	250	1	240	0.96	220	0.88
HR	250	1	250	1	230	0.92	210	0.84
VR	250	1	250	1	230	0.92	210	0.84

FC = Front terminals for cables; F = Front flat terminals; HR = Rear flat horizontal terminals; VR = Rear flat vertical terminals.

Tmax T4 320

Fixed	up to 40 °C		50 °C		60 °C		70 °C	
	I _{max} [A]	I _t	I _{max} [A]	I _t	I _{max} [A]	I _t	I _{max} [A]	I _t
FC	320	1	307	0.96	281	0.88	256	0.80
F	320	1	307	0.96	281	0.88	256	0.80
HR	320	1	294	0.92	269	0.84	243	0.76
VR	320	1	294	0.92	269	0.84	243	0.76

Plug-in - Withdrawable

FC	320	1	294	0.92	268	0.84	242	0.76
F	320	1	307	0.96	282	0.88	256	0.80
HR	320	1	294	0.92	268	0.84	242	0.76
VR	320	1	294	0.92	268	0.84	242	0.76

FC = Front terminals for cables; F = Front flat terminals; HR = Rear flat horizontal terminals; VR = Rear flat vertical terminals.

3 General characteristics

Tmax T5 400

Fixed	up to 40 °C		50 °C		60 °C		70 °C	
	I _{max} [A]	I _t	I _{max} [A]	I _t	I _{max} [A]	I _t	I _{max} [A]	I _t
FC	400	1	400	1	400	1	368	0.92
F	400	1	400	1	400	1	368	0.92
HR	400	1	400	1	400	1	352	0.88
VR	400	1	400	1	400	1	352	0.88

Plug-in - Withdrawable

FC	400	1	400	1	382	0.96	350	0.88
F	400	1	400	1	382	0.96	350	0.88
HR	400	1	400	1	368	0.92	336	0.84
VR	400	1	400	1	368	0.92	336	0.84

FC = Front terminals for cables; F = Front flat terminals; HR = Rear flat horizontal terminals; VR = Rear flat vertical terminals.

Tmax T5 630

Fixed	up to 40 °C		50 °C		60 °C		70 °C	
	I _{max} [A]	I _t	I _{max} [A]	I _t	I _{max} [A]	I _t	I _{max} [A]	I _t
FC	630	1	605	0.96	554	0.88	504	0.80
F	630	1	605	0.96	554	0.88	504	0.80
HR	630	1	580	0.92	529	0.84	479	0.76
VR	630	1	580	0.92	529	0.84	479	0.76

Plug-in - Withdrawable

F	630	1	607	0.96	552	0.88	476	0.76
HR	630	1	580	0.92	517	0.82	454	0.72
VR	630<	1	580	0.92	517	0.82	454	0.72

FC = Front terminals for cables; F = Front flat terminals; HR = Rear flat horizontal terminals; VR = Rear flat vertical terminals.

Tmax T6 630

Fixed	up to 40 °C		50 °C		60 °C		70 °C	
	I _{max} [A]	I _t	I _{max} [A]	I _t	I _{max} [A]	I _t	I _{max} [A]	I _t
F	630	1	630	1	630	1	598.5	0.95
FC	630	1	630	1	598.5	0.95	567	0.9
R (HR - VR)	630	1	630	1	567	0.9	504	0.8

Withdrawable

EF	630	1	630	1	598.5	0.95	567	0.9
VR	630	1	630	1	598.5	0.95	567	0.9
HR	630	1	598.5	0.95	567	0.9	504	0.8

FC = Front terminals for cables; F = Front flat terminals; HR = Rear flat horizontal terminals; VR = Rear flat vertical terminals; R = Rear terminals; EF = Front extended.

Tmax T6 800

Fixed	up to 40 °C		50 °C		60 °C		70 °C	
	I _{max} [A]	I _t	I _{max} [A]	I _t	I _{max} [A]	I _t	I _{max} [A]	I _t
F	800	1	800	1	800	1	760	0.95
FC	800	1	800	1	760	0.95	720	0.9
R (HR - VR)	800	1	800	1	720	0.9	640	0.8

Withdrawable

EF	800	1	800	1	760	0.95	720	0.9
VR	800	1	800	1	760	0.95	720	0.9
HR	800	1	760	0.95	720	0.9	640	0.8

FC = Front terminals for cables; F = Front flat terminals; HR = Rear flat horizontal terminals; VR = Rear flat vertical terminals; R = Rear terminals; EF = Front extended.

3 General characteristics

Tmax T6 1000

Fixed	up to 40 °C		50 °C		60 °C		70 °C	
	I _{max} [A]	I _t	I _{max} [A]	I _t	I _{max} [A]	I _t	I _{max} [A]	I _t
FC	1000	1	1000	1	913	0.91	817	0.82
R(HR)	1000	1	926	0.93	845	0.85	756	0.76
R(VR)	1000	1	961	0.96	877	0.88	784	0.78
ES	1000	1	800	0.8	600	0.6	600	0.4

FC = Front terminals for cables; R(HR) = Rear terminals oriented in horizontal; R(VR) = Rear terminals oriented in vertical; ES = Spreaded extended front terminals.

SACE Isomax S7 1600

Fixed	up to 40 °C		50 °C		60 °C		70 °C	
	I _{max} [A]	I _t	I _{max} [A]	I _t	I _{max} [A]	I _t	I _{max} [A]	I _t
Front flat bar	1600	1	1520	0.95	1440	0.9	1280	0.8
Rear vertical flat bar	1600	1	1520	0.95	1440	0.9	1280	0.8
Rear horizontal flat bar	1600	1	1440	0.9	1280	0.8	1120	0.7

Plug-in - Withdrawable

Front flat bar	1600	1	1440	0.9	1280	0.8	1120	0.7
Rear vertical flat bar	1600	1	1440	0.9	1280	0.8	1120	0.7
Rear horizontal flat bar	1600	1	1280	0.8	1120	0.7	906	0.6

SACE Isomax S8 2000

Fixed	up to 40 °C		50 °C		60 °C		70 °C	
	I _{max} [A]	I _t	I _{max} [A]	I _t	I _{max} [A]	I _t	I _{max} [A]	I _t
Front flat bar	2000	1	2000	1	1900	0.95	1715	0.85
Rear vertical flat bar	2000	1	2000	1	2000	1	1785	0.9

SACE Isomax S8 2500

Fixed	up to 40 °C		50 °C		60 °C		70 °C	
	I _{max} [A]	I _t	I _{max} [A]	I _t	I _{max} [A]	I _t	I _{max} [A]	I _t
Front flat bar	2500	1	2500	1	2270	0.9	2040	0.8
Rear vertical flat bar	2500	1	2500	1	2375	0.95	2130	0.85

SACE Isomax S8 3200

Fixed	up to 40 °C		50 °C		60 °C		70 °C	
	I _{max} [A]	I _t	I _{max} [A]	I _t	I _{max} [A]	I _t	I _{max} [A]	I _t
Rear vertical flat bar	3200	1	3060	0.95	2780	0.85	2510	0.8

3 General characteristics

SACE Emax E1

Temperature [°C]	E1 800		E1 1000		E1 1250		E1 1600	
	%	[A]	%	[A]	%	[A]	%	[A]
10	100	800	100	1000	100	1250	100	1600
20	100	800	100	1000	100	1250	100	1600
30	100	800	100	1000	100	1250	100	1600
40	100	800	100	1000	100	1250	100	1600
45	100	800	100	1000	100	1250	98	1570
50	100	800	100	1000	100	1250	96	1530
55	100	800	100	1000	100	1250	94	1500
60	100	800	100	1000	100	1250	92	1470
65	100	800	100	1000	99	1240	89	1430
70	100	800	100	1000	98	1230	87	1400

SACE Emax E2

Temperature [°C]	E2 800		E2 1000		E2 1250		E2 1600		E2 2000	
	%	[A]	%	[A]	%	[A]	%	[A]	%	[A]
10	100	800	100	1000	100	1250	100	1600	100	2000
20	100	800	100	1000	100	1250	100	1600	100	2000
30	100	800	100	1000	100	1250	100	1600	100	2000
40	100	800	100	1000	100	1250	100	1600	100	2000
45	100	800	100	1000	100	1250	100	1600	100	2000
50	100	800	100	1000	100	1250	100	1600	97	1945
55	100	800	100	1000	100	1250	100	1600	94	1885
60	100	800	100	1000	100	1250	98	1570	91	1825
65	100	800	100	1000	100	1250	96	1538	88	1765
70	100	800	100	1000	100	1250	94	1510	85	1705

SACE Emax E3

Temperature [C°]	E3 800		E3 1000		E3 1250		E3 1600		E3 2000		E3 2500		E3 3200	
	%	[A]	%	[A]	%	[A]	%	[A]	%	[A]	%	[A]	%	[A]
10	100	800	100	1000	100	1250	100	1600	100	2000	100	2500	100	3200
20	100	800	100	1000	100	1250	100	1600	100	2000	100	2500	100	3200
30	100	800	100	1000	100	1250	100	1600	100	2000	100	2500	100	3200
40	100	800	100	1000	100	1250	100	1600	100	2000	100	2500	100	3200
45	100	800	100	1000	100	1250	100	1600	100	2000	100	2500	100	3200
50	100	800	100	1000	100	1250	100	1600	100	2000	100	2500	97	3090
55	100	800	100	1000	100	1250	100	1600	100	2000	100	2500	93	2975
60	100	800	100	1000	100	1250	100	1600	100	2000	100	2500	89	2860
65	100	800	100	1000	100	1250	100	1600	100	2000	97	2425	86	2745
70	100	800	100	1000	100	1250	100	1600	100	2000	94	2350	82	2630

3 General characteristics

Emax E4

Temperature [°C]	E4 3200		E4 4000	
	%	[A]	%	[A]
10	100	3200	100	4000
20	100	3200	100	4000
30	100	3200	100	4000
40	100	3200	100	4000
45	100	3200	100	4000
50	100	3200	98	3900
55	100	3200	95	3790
60	100	3200	92	3680
65	98	3120	89	3570
70	95	3040	87	3460

Emax E6

Temperature [°C]	E6 3200		E6 4000		E6 5000		E6 6300	
	%	[A]	%	[A]	%	[A]	%	[A]
10	100	3200	100	4000	100	5000	100	6300
20	100	3200	100	4000	100	5000	100	6300
30	100	3200	100	4000	100	5000	100	6300
40	100	3200	100	4000	100	5000	100	6300
45	100	3200	100	4000	100	5000	100	6300
50	100	3200	100	4000	100	5000	100	6300
55	100	3200	100	4000	100	5000	98	6190
60	100	3200	100	4000	98	4910	96	6070
65	100	3200	100	4000	96	4815	94	5850
70	100	3200	100	4000	94	4720	92	5600

3 General characteristics

The following table lists examples of the continuous current carrying capacity for circuit-breakers installed in a switchboard with the dimensions indicated below. These values refer to withdrawable switchgear installed in non segregated switchboards with a protection rating up to IP31, and following dimensions: 2300x800x900 (HxLxD) for E1 - E2 - E3; 2300x1400x1500 (HxLxD) for E4 - E6.

The values refer to a maximum temperature at the terminals of 120 °C. For withdrawable circuit-breakers with a rated current of 6300 A, the use of vertical rear terminals is recommended.

Type	I _n [A]	Vertical terminals				Horizontal and front terminals			
		Continuous capacity				Continuous capacity			
		35°C	45°C	55°C	Busbars section [mm ²]	35°C	45°C	55°C	Busbars section [mm ²]
E1B/N 08	800	800	800	800	1x(60x10)	800	800	800	1x(60x10)
E1B/N 10	1000	1000	1000	1000	1x(80x10)	1000	1000	1000	2x(60x8)
E1B/N 12	1250	1250	1250	1250	1x(80x10)	1250	1250	1200	2x(60x8)
E1B/N 16	1600	1600	1600	1500	2x(60x10)	1550	1450	1350	2x(60x10)
E2S 08	800	800	800	800	1x(60x10)	800	800	800	1x(60x10)
E2NS 10	1000	1000	1000	1000	1x(60x10)	1000	1000	1000	1x(60x10)
E2NS 12	1250	1250	1250	1250	1x(60x10)	1250	1250	1250	1x(60x10)
E2B/NS 16	1600	1600	1600	1600	2x(60x10)	1600	1600	1530	2x(60x10)
E2B/NS 20	2000	2000	2000	1800	3x(60x10)	2000	2000	1750	3x(60x10)
E2L 12	1250	1250	1250	1250	1x(60x10)	1250	1250	1250	1x(60x10)
E2L 16	1600	1600	1600	1500	2x(60x10)	1600	1500	1400	2x(60x10)
E3H/V 08	800	800	800	800	1x(60x10)	800	800	800	1x(60x10)
E3S/H 10	1000	1000	1000	1000	1x(60x10)	1000	1000	1000	1x(60x10)
E3S/H/V 12	1250	1250	1250	1250	1x(60x10)	1250	1250	1250	1x(60x10)
E3S/H/V 16	1600	1600	1600	1600	1x(100x10)	1600	1600	1600	1x(100x10)
E3S/H/V 20	2000	2000	2000	2000	2x(100x10)	2000	2000	2000	2x(100x10)
E3NS/H/V 25	2500	2500	2500	2500	2x(100x10)	2500	2450	2400	2x(100x10)
E3NS/H/V 32	3200	3200	3100	2800	3x(100x10)	3000	2880	2650	3x(100x10)
E3L 20	2000	2000	2000	2000	2x(100x10)	2000	2000	1970	2x(100x10)
E3L 25	2500	2500	2390	2250	2x(100x10)	2375	2270	2100	2x(100x10)
E4H/V 32	3200	3200	3200	3200	3x(100x10)	3200	3150	3000	3x(100x10)
E4S/H/V 40	4000	4000	3980	3500	4x(100x10)	3600	3510	3150	6x(60x10)
E6V 32	3200	3200	3200	3200	3x(100x10)	3200	3200	3200	3x(100x10)
E6HV 40	4000	4000	4000	4000	4x(100x10)	4000	4000	4000	4x(100x10)
E6HV 50	5000	5000	4850	4600	6x(100x10)	4850	4510	4250	6x(100x10)
E6HV 63	6300	6000	5700	5250	7x(100x10)	-	-	-	-

Note: the reference temperature is the ambient temperature

Examples:

Selection of a moulded-case circuit-breaker, with thermomagnetic release, for a load current of 180 A, at an ambient temperature of 60°C. From the table referring to Tmax circuit-breakers (page 173), it can be seen that the most suitable breaker is the T3 In 250, which can be set from 152 A to 216 A.

Selection of a moulded-case circuit-breaker, with electronic release, in withdrawable version with rear flat horizontal bar terminals, for a load current equal to 720 A, with an ambient temperature of 50 °C. From the table referring to Tmax circuit-breakers (page 176), it can be seen that the most suitable breaker is the T6 800, which can be set from 320 A to 760 A.

Selection of an air circuit-breaker, with electronic release, in withdrawable version with vertical terminals, for a load current of 2700 A, with a temperature outside of the IP31 switchboard of 55 °C. From the tables referring to the current carrying capacity inside the switchboard for Emax circuit-breakers (see above), it can be seen that the most suitable breaker is the E3 3200, with busbar section 3x(100x10)mm², which can be set from 1280 A to 2800 A.

3 General characteristics

The following tables show the maximum settings for L protection (against overload) for electronic releases, according to temperature, version and terminals.

Tmax T2 In ≤ 125A	All terminals	
	F	P
≤40	1	1
45		
50		
55		
60		
65		
70		

Tmax T2 In = 160A	All terminals	
	F	P
≤40	1	0.88
45	0.96	0.88
50	0.96	0.88
55	0.92	0.88
60	0.88	0.88
65	0.84	0.84
70	0.8	0.8

Tmax T2 In ≤ 100A	Fixed - Plug-in	
	PR221	
	All terminals	
≤40	1	
45		
50		
55		
60		
65		
70		

Tmax T2 In 160A	Fixed - Plug-in	
	PR221	
	All terminals	
≤40	1	
45	0.96	
50	0.96	
55	0.92	
60	0.88	
65	0.84	
70	0.8	

Tmax T2 In ≤ 160A	Fixed - Plug-in Withdrawable	
	PR221 - PR222	
	FC - F - HR - VR	
≤40	1	
45		
50		
55		
60		
65		
70		

Tmax T4 In = 250A	Fixed				Plug-in - Withdrawable			
	PR221		PR222/PR223		PR221		PR222/PR223	
	FC - F	HR - VR	FC - F	HR - VR	FC - F	HR - VR	FC - F	HR - VR
≤40	1	1	1	1	1	1	1	1
45								
50								
55								
60								
65	0.96	0.92	0.96	0.94	0.92	0.88	0.92	0.88
70	0.92	0.88	0.92	0.88	0.88	0.84	0.88	0.84

FC = Front terminals for cables; F = Front flat terminals; HR = Rear flat horizontal terminals; VR = Rear flat vertical terminals.

3 General characteristics

Tmax T4 In = 320A	Fixed				Plug-in - Withdrawable			
	PR221		PR222/PR223		PR221		PR222/PR223	
	FC - F	HR - VR	FC - F	HR - VR	F	FC-HR-VR	F	FC-HR-VR
≤40	1	1	1	1	1	1	1	1
45					0.96		0.96	
50	0.96	0.92	0.96	0.92	0.96	0.92	0.96	0.92
55	0.92	0.88	0.92	0.88	0.92	0.88	0.92	0.88
60	0.88	0.84	0.88	0.84	0.88	0.84	0.88	0.84
65	0.84	0.8	0.84	0.8	0.84	0.80	0.84	0.80
70	0.8	0.76	0.8	0.76	0.8	0.76	0.8	0.76

Tmax T5 In ≤ 320A	Fixed - Plug-in Withdrawable	
	PR221-PR222-PR223	
	FC - F - HR - VR	
≤40	1	
45	1	
50	1	
55	1	
60	1	
65	1	
70	1	

Tmax T5 In = 400A	Fixed				Plug-in - Withdrawable			
	PR221		PR222/PR223		PR221		PR222/PR223	
	FC - F	HR - VR	FC - F	HR - VR	FC - F	HR - VR	FC - F	HR - VR
≤40					1	1	1	1
45								
50	1	1	1	1				
55					0.96	0.96	0.98	0.96
60						0.92	0.96	0.92
65	0.96	0.92	0.96	0.94	0.92	0.88	0.92	0.88
70	0.92	0.88	0.92	0.88	0.88	0.84	0.88	0.84

Tmax T5 In = 630A	Fixed				Plug-in - Withdrawable			
	PR221		PR222/PR223		PR221		PR222/PR223	
	FC - F	HR - VR	FC - F	HR - VR	F	HR-VR	F	HR-VR
≤40	1	1	1	1	1	1	1	1
45								
50	0.96	0.92	0.96	0.92	0.96	0.92	0.96	0.92
55	0.92	0.88	0.92	0.88	0.92	0.84	0.92	0.86
60	0.88	0.84	0.88	0.84	0.88	0.8	0.88	0.82
65	0.84	0.8	0.84	0.8	0.8	0.76	0.8	0.76
70	0.8	0.76	0.8	0.76	0.76	0.72	0.76	0.72

FC = Front terminals for cables; F = Front flat terminals; HR = Rear flat horizontal terminals; VR = Rear flat vertical terminals.

3 General characteristics

Tmax T6 In = 630A	Fixed						Withdrawable			
	PR221			PR222/PR223			PR221		PR222/PR223	
	F	FC	R	F	FC	R	EF-VR	HR	EF-VR	HR
≤40								1		1
45								0.96		0.96
50	1	1	1	1	1	1	1	0.92	1	0.94
55		0.96	0.92		0.96	0.94	0.96	0.92	0.96	0.92
60		0.92	0.88		0.94	0.9	0.92	0.88	0.94	0.9
65	0.96	0.92	0.84	0.96	0.92	0.84	0.92	0.84	0.92	0.84
70	0.92	0.88	0.8	0.94	0.9	0.8	0.88	0.8	0.9	0.8

Tmax T6 In = 800A	Fixed						Withdrawable			
	PR221			PR222/PR223			PR221		PR222/PR223	
	F	FC	R	F	FC	R	EF-VR	HR	EF-VR	HR
≤40								1		1
45								0.96		0.96
50	1	1	1	1	1	1	1	0.92	1	0.94
55		0.96	0.92		0.96	0.94	0.96	0.92	0.96	0.92
60		0.92	0.88		0.94	0.9	0.92	0.88	0.94	0.9
65	0.96	0.92	0.84	0.96	0.92	0.84	0.92	0.84	0.92	0.84
70	0.92	0.88	0.8	0.94	0.9	0.8	0.88	0.8	0.9	0.8

Tmax T6 In = 1000A	Fixed							
	PR221				PR222/PR223			
	FC	R (HR)	R (VR)	ES	FC	R (HR)	R (VR)	ES
≤40		1	1	1		1	1	1
45	1	0.96	0.96	0.88	1	0.96	0.98	0.9
50		0.92	0.96	0.8		0.92	0.96	0.8
55	0.92	0.88	0.88	0.68	0.94	0.88	0.9	0.7
60	0.88	0.84	0.84	0.6	0.9	0.84	0.86	0.6
65	0.84	0.8	0.8	0.48	0.86	0.8	0.82	0.5
70	0.8	0.72	0.76	0.4	0.8	0.74	0.78	0.4

F = Front flat terminals; HR = Rear flat horizontal terminals; VR = Rear flat vertical terminals; FC = Front terminals for cables; R(HR) = Rear terminals oriented in horizontal; R(VR) = Rear terminals oriented in vertical; ES = Spreaded extended front terminals; R = Rear terminals; EF = Front extended.

3 General characteristics

Emax E1	800 A	
	PR121	PR122/PR123
≤40		
45		
50		
55	1	1
60		
65		
70		

Emax E1	1000 A	
	PR121	PR122/PR123
≤40		
45		
50		
55	1	1
60		
65		
70		

Emax E1	1250 A	
	PR121	PR122/PR123
≤40		
45		
50	1	1
55		
60		
65	0.975	0.99
70		0.98

Emax E1	1600 A	
	PR121	PR122/PR123
≤40	1	1
45	0.975	0.98
50	0.95	0.95
55	0.925	0.93
60	0.9	0.91
65	0.875	0.89
70	0.85	0.87

Emax E2	800/1000/1250 A	
	PR121	PR122/PR123
≤40		
45		
50		
55	1	1
60		
65		
70		

Emax E2	1600 A	
	PR121	PR122/PR123
≤40		
45		
50	1	1
55		
60	0.975	0.98
65	0.95	0.96
70	0.925	0.94

Emax E2	2000 A	
	PR121	PR122/PR123
≤40	1	1
45		
50	0.95	0.97
55	0.925	0.94
60	0.9	0.91
65	0.875	0.88
70	0.85	0.85

Emax E3	800/1000/1250/1600/2000 A	
	PR121	PR122/PR123
≤40		
45		
50		
55	1	1
60		
65		
70		

3 General characteristics

Emax E3	2500 A	
	PR121	PR122/PR123
≤40		
45		
50	1	1
55		
60		
65	0.95	0.97
70	0.925	0.94

Emax E3	3200 A	
	PR121	PR122/PR123
≤40		
45	1	1
50	0.95	0.96
55	0.9	0.92
60	0.875	0.89
65	0.85	0.85
70	0.8	0.82

Emax E4	3200 A	
	PR121	PR122/PR123
≤40		
45		
50	1	1
55		
60		
65	0.975	0.97
70	0.95	0.95

Emax E4	4000 A	
	PR121	PR122/PR123
≤40		
45	1	1
50	0.975	0.97
55	0.925	0.94
60	0.9	0.92
65	0.875	0.89
70	0.85	0.86

Emax E6	3200/4000 A	
	PR121	PR122/PR123
≤40		
45		
50		
55	1	1
60		
65		
70		

Emax E6	5000 A	
	PR121	PR122/PR123
≤40		
45		
50	1	1
55		
60	0.975	0.98
65	0.95	0.96
70	0.925	0.94

Emax E6	6300 A	
	PR121	PR122/PR123
≤40		
45	1	1
50		
55	0.975	0.98
60	0.95	0.96
65	0.9	0.92
70	0.875	0.88

3 General characteristics

	Vertical Terminals					
	35 °C		45 °C		55 °C	
	PR121	PR122/PR123	PR121	PR122/PR123	PR121	PR122/PR123
E1B/N 08	1	1	1	1	1	1
E1B/N 10	1	1	1	1	1	1
E1B/N 12	1	1	1	1	1	1
E1B/N 16	1	1	1	1	0.925	0.93
E2S 08	1	1	1	1	1	1
E2N/S 10	1	1	1	1	1	1
E2N/S 12	1	1	1	1	1	1
E2B/N/S16	1	1	1	1	1	1
E2B/N/S20	1	1	1	1	0.9	0.9
E2L 12	1	1	1	1	1	1
E2L 16	1	1	1	1	0.925	0.93
E3H/V 08	1	1	1	1	1	1
E3S/ V 10	1	1	1	1	1	1
E3S/H/V 12	1	1	1	1	1	1
E3S/H/V 16	1	1	1	1	1	1
E3S/H/V20	1	1	1	1	1	1
E3N/S/H/ V25	1	1	1	1	1	1
E3N/S/H/ V32	1	1	0.95	0.96	0.875	0.87
E3L 20	1	1	1	1	1	1
E3L 25	1	1	0.95	0.95	0.9	0.9
E4H/V32	1	1	1	1	1	1
E4S/H/V40	1	1	0.975	0.99	0.875	0.87
E6V 32	1	1	1	1	1	1
E6H/ V 40	1	1	1	1	1	1
E6H/ V 50	1	1	0.95	0.97	0.9	0.92
E6H/V 63	0.95	0.95	0.9	0.9	0.825	0.83

	Vertical Terminals					
	35 °C		45 °C		55 °C	
	PR121	PR122/PR123	PR121	PR122/PR123	PR121	PR122/PR123
E1B/N 08	1	1	1	1	1	1
E1B/N 10	1	1	1	1	1	1
E1B/N 12	1	1	1	1	0.95	0.96
E1B/N 16	0.95	0.96	0.9	0.9	0.825	0.84
E2S 08	1	1	1	1	1	1
E2N/S 10	1	1	1	1	1	1
E2N/S 12	1	1	1	1	1	1
E2B/N/S16	1	1	1	1	0.95	0.95
E2B/N/S20	1	1	1	1	0.875	0.87
E2L 12	1	1	1	1	1	1
E2L 16	1	1	0.925	0.93	0.875	0.87
E3H/ V 08	1	1	1	1	1	1
E3S/H 10	1	1	1	1	1	1
E3S/H/ V 12	1	1	1	1	1	1
E3S/H/ V16	1	1	1	1	1	1
E3S/H/ V20	1	1	1	1	1	1
E3N/S/H/ V25	1	1	0.975	0.98	0.95	0.96
E3N/S/H/ V32	0.925	0.93	0.9	0.9	0.825	0.82
E3L 20	1	1	1	1	0.975	0.98
E3L 25	0.95	0.95	0.9	0.9	0.825	0.84
E4H/ V32	1	1	0.975	0.98	0.925	0.93
E4S/H/ V40	0.9	0.9	0.875	0.87	0.775	0.78
E6V 32	1	1	1	1	1	1
E6H/ V 40	1	1	1	1	1	1
E6H/ V 50	0.95	0.97	0.9	0.9	0.85	0.85
E6H/ V 63	-	-	-	-	-	-

3 General characteristics

3.6 Altitude derating

For installations carried out at altitudes of more than 2000 m above sea level, the performance of low voltage circuit-breakers is subject to a decline.

Basically there are two main phenomena:

- the reduction of air density causes a lower efficiency in heat transfer. The allowable heating conditions for the various parts of the circuit-breaker can only be followed if the value of the rated uninterrupted current is decreased;
- the rarefaction of the air causes a decrease in dielectric rigidity, so the usual isolation distances become insufficient. This leads to a decrease in the maximum rated voltage at which the device can be used.

The correction factors for the different types of circuit-breakers, both moulded- case and air circuit-breakers, are given in the following table:

	Altitude	Rated operational voltage Ue [V]			
		2000[m]	3000[m]	4000[m]	5000[m]
Tmax*		690	600	500	440
Isomax		690	600	500	440
Emax		690	600	500	440

	Altitude	Rated uninterrupted current Iu [A]			
		2000[m]	3000[m]	4000[m]	5000[m]
Tmax		100%	98%	93%	90%
Isomax		100%	95%	90%	85%
Emax		100%	98%	93%	90%

*Excluding Tmax T1P

3 General characteristics

3.7 Electrical characteristics of switch disconnectors

A switch disconnector as defined by the standard IEC 60947-3 is a mechanical switching device which, when in the open position, carries out a disconnecting function and ensures an isolating distance (distance between contacts) sufficient to guarantee safety. This safety of disconnection must be guaranteed and verified by the positive operation: the operating lever must always indicate the actual position of the mobile contacts of the device.

The mechanical switching device must be able to make, carry and break currents in normal circuit conditions, including any overload currents in normal service, and to carry, for a specified duration, currents in abnormal circuit conditions, such as, for example, short-circuit conditions.

Switch disconnectors are often used as:

- main sub-switchboard devices;
- switching and disconnecting devices for lines, busbars or load units;
- bus-tie.

The switch disconnector shall ensure that the whole plant or part of it is not live, safely disconnecting from any electrical supply. The use of such a switch disconnector allows, for example, personnel to carry out work on the plant without risks of electrical nature.

Even if the use of a single pole devices side by side is not forbidden, the standards recommend the use of multi-pole devices so as to guarantee the simultaneous isolation of all poles in the circuit.

The specific rated characteristics of switch disconnectors are defined by the standard IEC 60947-3, as detailed below:

- **I_{cw} [kA]:** rated short-time withstand current:
is the current that a switch is capable of carrying, without damage, in the closed position for a specific duration
- **I_{cm} [kA]:** rated short-circuit making capacity:
is the maximum peak value of a short-circuit current which the switch disconnector can close without damages. When this value is not given by the manufacturer it must be taken to be at least equal to the peak current corresponding to I_{cw}. It is not possible to define a breaking capacity I_{cu} [kA] since switch disconnectors are not required to break short-circuit currents
- **utilization categories with alternating current AC and with direct current DC:**

define the kind of the conditions of using which are represented by two letters to indicate the type of circuit in which the device may be installed (AC for alternating current and DC for direct current), with a two digit number for the type of load which must be operated, and an additional letter (A or B) which represents the frequency in the using.

With reference to the utilization categories, the product standard defines the current values which the switch disconnector must be able to break and make under abnormal conditions.

3 General characteristics

The characteristics of the utilization categories are detailed in Table 1 below. The most demanding category in alternating current is AC23A, for which the device must be capable of connecting a current equal to 10 times the rated current of the device, and of disconnecting a current equal to 8 times the rated current of the device.

From the point of view of construction, the switch disconnector is a very simple device. It is not fitted with devices for overcurrent detection and the consequent automatic interruption of the current. Therefore the switch disconnector cannot be used for automatic protection against overcurrent which may occur in the case of failure, protection must be provided by a coordinated circuit-breaker. The combination of the two devices allows the use of switch disconnectors in systems in which the short-circuit current value is greater than the electrical parameters which define the performance of the disconnector (back-up protection see Chapter 4.4. This is valid only for Isomax and Tmax switch-disconnectors. For the Emax/MS air disconnectors, it must be verified that the values for I_{cw} and I_{cm} are higher to the values for short-circuit in the plant and correspondent peak, respectively.

Table1: Utilization categories

Nature of current	Utilization categories		
	Utilization category		Typical applications
	Frequent operation	Non-frequent operation	
Alternating Current	AC-20A	AC-20B	Connecting and disconnecting under no-load conditions
	AC-21A	AC-21B	Switching of resistive loads including moderate overloads
	AC-22A	AC-22B	Switching of mixed resistive and inductive loads, including moderate overload
	AC-23A	AC-23B	Switching of motor loads or other highly inductive loads
Direct Current	DC-20A	DC-20B	Connecting and disconnecting under no-load conditions
	DC-21A	DC-21B	Switching of resistive loads including moderate overloads
	DC-22A	DC-22B	Switching of mixed resistive and inductive loads, including moderate overload (e.g. shunt motors)
	DC-23A	DC-23B	Switching of highly inductive loads

3 General characteristics

Tables 2, 3 and 4 detail the main characteristics of the disconnectors.

Table 2: Tmax switch disconnectors

		T1D
Conventional thermal current, I _{th}	[A]	160
Rated current in AC-22A utilization category, I _e	[A]	160
Rated current in AC-23A utilization category, I _e	[A]	125
Poles	[Nr]	3/4
Rated operational voltage, U _e	50-60 Hz [Vac]	690
	dc [Vdc]	500
Rated impulse withstand voltage, U _{imp}	[kV]	8
Rated insulation voltage, U _i	[V]	800
Test voltage at industrial frequency for 1 minute	[V]	3000
Rated short-circuit making capacity (415Vac), I _{cm}	(min) switch disconnector only [kA]	2.8
	(max) with circuit-breaker on supply side [kA]	187
Rated short time withstand current for 1s, I _{cw}	[kA]	2
Insulation behaviour	■	■
Reference standard		IEC 60947-3
Versions		F
Terminals		FC Cu - EF FC CuAl
Mechanical life	[No. of operations]	25000
	[Operations per hour]	120
	3 poles L [mm]	76
Basic dimensions, fixed	4 poles L [mm]	102
	D [mm]	130
	H [mm]	70
	3/4 poles fixed [kg]	0.9/1.2
Weight	3/4 poles plug-in [kg]	-
	3/4 poles withdrawable [kg]	-

3 General characteristics

	T3D	T4D	T5D	T6D
Conventional thermal current, I _{th}	250	250/320	400/630	630/800/1000
Rated current in AC-22A utilization category, I _e	250	250/320	400/630	630/800/1000
Rated current in AC-23A utilization category, I _e	200	250	400	630/800
Poles	3/4	3/4	3/4	3/4
Rated operational voltage, U _e	690	690	690	690
	500	750	750	750
Rated impulse withstand voltage, U _{imp}	8	8	8	8
Rated insulation voltage, U _i	800	800	800	1000
Test voltage at industrial frequency for 1 minute	3000	3000	3000	3500
Rated short-circuit making capacity (415Vac), I _{cm}	(min) switch disconnector only [kA]	5.3	5,3	11
	(max) with circuit-breaker on supply side [kA]	105	440	440
Rated short time withstand current for 1s, I _{cw}	3.6	3.6	6	15
Insulation behaviour	■	■	■	■
Reference standard	IEC 60947-3	IEC 60947-3	IEC 60947-3	IEC 60947-3
Versions	F - P	F - P - W	F - P - W	F-W
Terminals	F - FC Cu - FC CuAl EF-ES - R - FC CuAl	F - FCCu - FCCuAl - EF-ES R- MC -HR - VR	F - FCCu - FCCuAl -EF ES- R - HR - VR	F-EF-FC - CuAl-R ES - RC
Mechanical life	[No. of operations]	25000	20000	20000
	[Operations per hour]	120	120	120
	3 poles L [mm]	105	105	140
Basic dimensions, fixed	4 poles L [mm]	140	140	184
	D [mm]	150	205	205
	H [mm]	70	103,5	103,5
	3/4 poles fixed [kg]	2.1/3	2.35/3.05	3.25/4.15
Weight	3/4 poles plug-in [kg]	2.1/3.7	3.6/4.65	5.15/6.65
	3/4 poles withdrawable [kg]	-	3.85/4.9	5.4/6.9

KEY TO VERSIONS
F = Fixed
P = Plug-in
W = Withdrawable

KEY TO TERMINALS
F = Front
EF = Extended front
ES = Extended spreaded front

FC CuAl = Front for copper or aluminium cables
R = Rear threaded
RC = Rear for copper or aluminium cables
HR = Rear horizontal flat bar

VR = Rear vertical flat bar

3 General characteristics

Table 3: SACE Isomax switch disconnectors

Conventional thermal current at 40 °C, I_{th}	[A]
Number of poles	Nr.
Rated operational voltage, U_e	(ac) 50-60Hz [V~] (dc) [V-]
Rated current, I_e	[A]
Rated impulse withstand voltage, U_{imp}	[kV]
Rated insulation voltage, U_i	[V]
Test voltage at industrial frequency for 1 min.	[V]
Rated short-circuit making capacity (415 V~), I_{cm}	[kA]
Rated short-time withstand current for 1 s, I_{cw}	[kA]
Isolation behaviour	
IEC 60947-3	
Versions	
Terminals	fixed plug-in withdrawable
Mechanical life [No. of operations / operation per hour]	
Basic dimensions, fixed	L (3/4 poles) [mm] D [mm] H [mm]
Weight, fixed	3/4 poles [kg]

Table 4: Emax switch disconnectors

		E1B/MS	E1N/MS	E2B/MS	E2N/MS	E2S/MS	E3N/MS	E3S/MS	E3V/MS	E4S/MS	E4H/fMS	E4H/MS	E6H/MS	E6H/f MS
Rated uninterrupted current (a 40 °C) I_{th}	[A]	800	800	1600	1000	1000	2500	1000	800	4000	3200	3200	4000	4000
	[A]	1000	1000	2000	1250	1250	3200	1250	1250		4000	4000	5000	5000
	[A]	1250	1250		1600	1600		1600	1600				6300	6300
	[A]	1600	1600		2000	2000		2000	2000					
	[A]							2500	2500					
	[A]							3200	3200					
Rated operational voltage U_e	[V ~]	690	690	690	690	690	690	690	690	690	690	690	690	690
	[V -]	250	250	250	250	250	250	250	250	250	250	250	250	250
Rated insulation voltage U_i	[V ~]	1000	1000	1000	1000	1000	1000	1000	1000	1000	1000	1000	1000	1000
Rated impulse withstand voltage U_{imp}	[kV]	12	12	12	12	12	12	12	12	12	12	12	12	12
Rated short-time withstand current I_{cw}	(1s) [kA]	42	50 ⁽¹⁾	42	55	65	65	75	85	75	85	100 ⁽²⁾	100	100
	(3s) [kA]	36	36	42	42	42	65	65	65	75	75	75	85	85
Rated short-circuit making capacity (peak value) I_{cm}	220/230/380/400/415/440 V ~ [kA]	88.2	105	88.2	143	187	143	165	286	165	220	220	220	220
	500/660/690 V ~ [kA]	75.6	75.6	88.2	121	143	143	165	220	165	220	187	220	220

Note: the breaking capacity I_{cw} , at the maximum rated use voltage, by means of external protection relay, with 500 ms maximum timing, is equal to the value of I_{cw} (1s).

⁽¹⁾ $I_{cw} = 36 \text{ kA} @ 690 \text{ V}$.

⁽²⁾ $I_{cw} = 85 \text{ kA} @ 690 \text{ V}$.

3 General characteristics

S7D	S8D
1000 / 1250 / 1600	2000 / 2500 / 3200
3/4	3/4
690	690
750	750
1000-1250-1600	2000-2500-3200
8	8
800	800
3000	3000
52,5	85
25	40
■	■
■	■
F - W	F
F - EF - FC CuAl (1250A) HR - VR	EF (2500A)-R
-	-
F - HR - VR	-
10000/120	10000/20
210/280	406/556
138,5	242
406	400
17/22	57/76

4 Protection coordination

4.1 Protection coordination

The design of a system for protecting an electric network is of fundamental importance both to ensure the correct economic and functional operation of the installation as a whole and to reduce to a minimum any problem caused by anomalous operating conditions and/or malfunctions.

The present analysis discusses the coordination between the different devices dedicated to the protection of zones and specific components with a view to:

- guaranteeing safety for people and installation at all times;
- identifying and rapidly excluding only the zone affected by a problem, instead of taking indiscriminate actions and thus reducing the energy available to the rest of the network;
- containing the effects of a malfunction on other intact parts of the network (voltage dips, loss of stability in the rotating machines);
- reducing the stress on components and damage in the affected zone;
- ensuring the continuity of the service with a good quality feeding voltage;
- guaranteeing an adequate back-up in the event of any malfunction of the protective device responsible for opening the circuit;
- providing staff and management systems with the information they need to restore the service as rapidly as possible and with a minimal disturbance to the rest of the network;
- achieving a valid compromise between reliability, simplicity and cost effectiveness.

To be more precise, a valid protection system must be able to:

- understand what has happened and where it has happened, discriminating between situations that are anomalous but tolerable and faults within a given zone of influence, avoiding unnecessary tripping and the consequent unjustified disconnection of a sound part of the system;
- take action as rapidly as possible to contain damage (destruction, accelerated ageing, ...), safeguarding the continuity and stability of the power supply.

The most suitable solution derives from a compromise between these two opposing needs - to identify precisely the fault and to act rapidly - and is defined in function of which of these two requirements takes priority.

Over-current coordination

Influence of the network's electrical parameters (rated current and short-circuit current)

The strategy adopted to coordinate the protective devices depends mainly on the rated current (I_n) and short-circuit current (I_k) values in the considered point of network.

Generally speaking, we can classify the following types of coordination:

- current discrimination;
- time (or time-current) discrimination;
- zone (or logical) discrimination;
- energy discrimination;
- back-up.

4 Protection coordination

Definition of discrimination

The **over-current discrimination** is defined in the Standards as “*coordination of the operating characteristics of two or more over-current protective devices such that, on the incidence of over-currents within stated limits, the device intended to operate within these limits does so, while the others do not operate*” (IEC 60947-1, def. 2.5.23);

It is possible to distinguish between:

- **total discrimination**, which means “*over-current discrimination such that, in the case of two over-current protective devices in series, the protective device on the load side provides protection without tripping the other protective device*” (IEC 60947-2, def. 2.17.2);
- **partial discrimination**, which means “*over-current discrimination such that, in the case of two over-current protective devices in series, the protective device on the load side provides protection up to a given over-current limit without tripping the other*” (IEC 60947-2, def. 2.17.3); this over-current threshold is called “*discrimination limit current I_S* ” (IEC 60947-2, def. 2.17.4).

Current discrimination

This type of discrimination is based on the observation that the closer the fault comes to the network's feeder, the greater the short-circuit current will be. We can therefore pinpoint the zone where the fault has occurred simply by calibrating the instantaneous protection of the device upstream to a limit value higher than the fault current which causes the tripping of the device downstream.

We can normally achieve total discrimination only in specific cases where the fault current is not very high (and comparable with the device's rated current) or where a component with high impedance is between the two protective devices (e.g. a transformer, a very long or small cable...) giving rise to a large difference between the short-circuit current values.

This type of coordination is consequently feasible mainly in final distribution networks (with low rated current and short-circuit current values and a high impedance of the connection cables).

The devices' time-current tripping curves are generally used for the study.

This solution is:

- rapid;
- easy to implement;
- and inexpensive.

On the other hand:

- the discrimination limits are normally low;
- increasing the discrimination levels causes a rapid growing of the device sizes.

The following example shows a typical application of current discrimination based on the different instantaneous tripping threshold values of the circuit-breakers considered.

4 Protection coordination

With a fault current value at the defined point equal to 1000 A, an adequate coordination is obtained by using the considered circuit-breakers as verified in the tripping curves of the protection devices.

The discrimination limit is given by the minimum magnetic threshold of the circuit-breaker upstream, T1B160 In160.

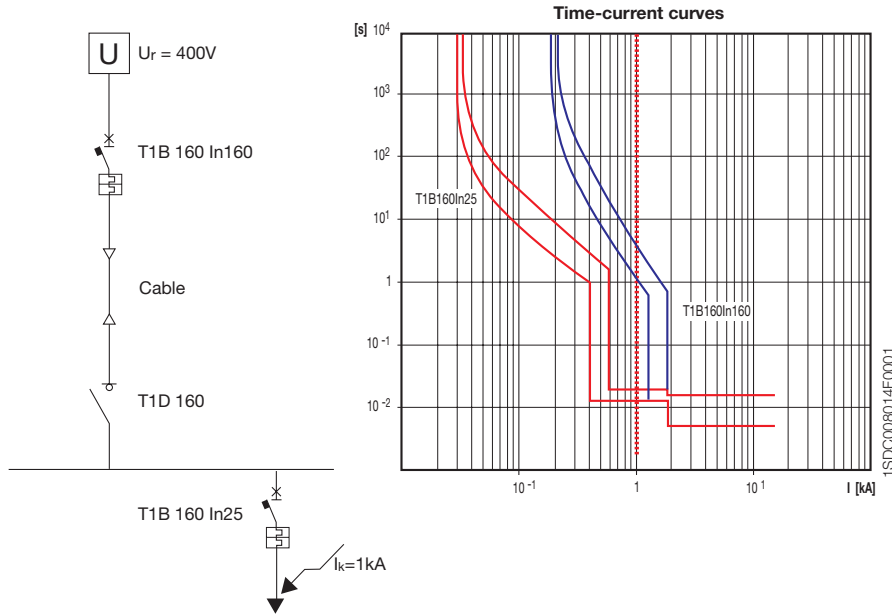

Time discrimination

This type of discrimination is an evolution from the previous one. The setting strategy is therefore based on progressively increasing the current thresholds and the time delays for tripping the protective devices as we come closer to the power supply source. As in the case of current discrimination, the study is based on a comparison of the time-current tripping curves of the protective devices.

This type of coordination:

- is easy to study and implement;
- is relatively inexpensive;
- enables to achieve even high discrimination levels, depending on the I_{cw} of the upstream device;
- allows a redundancy of the protective functions and can send valid information to the control system,

but has the following disadvantages:

- the tripping times and the energy levels that the protective devices (especially those closer to the sources) let through are high, with obvious problems concerning safety and damage to the components even in zones unaffected by the fault;

4 Protection coordination

- it enables the use of current-limiting circuit-breakers only at levels hierarchically lower down the chain; the other circuit-breakers have to be capable of withstanding the thermal and electro-dynamic stresses related to the passage of the fault current for the intentional time delay. Selective circuit-breakers, often air type, have to be used for the various levels to guarantee a sufficiently high short-time withstand current;
- the duration of the disturbance induced by the short-circuit current on the power supply voltages in the zones unaffected by the fault can cause problems with electronic and electro-mechanical devices (voltage below the electromagnetic releasing value);
- the number of discrimination levels is limited by the maximum time that the network can stand without loss of stability.

The following example shows a typical application of time discrimination obtained by setting differently the tripping times of the different protection devices.

Electronic release:	L (Long delay)	S (Short delay)	I (IST)
E4S 4000 PR121-LSI In4000	Setting: 0.9 Curve: 12s	Setting: 8.5 Curve: 0.5s	Off
E3N 2500 PR121-LSI In2500	Setting: 1 Curve: 3s	Setting: 10 Curve: 0.3s	Off
S7H 1600 PR211-LI In1600	Setting: 1 Curve: A		Setting: 10

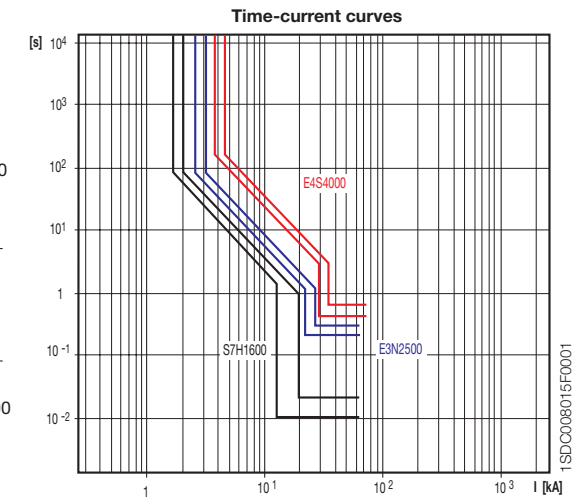
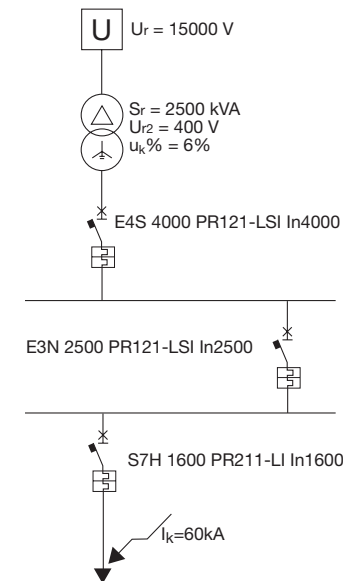

4 Protection coordination

Zone (or logical) discrimination

The zone discrimination is available with MCCB (T4 L-T6 L-T6L with PR223-EF) and ACB (with PR122 or PR123).

This type of coordination is implemented by means of a dialogue between current measuring devices that, when they ascertain that a setting threshold has been exceeded, give the correct identification and disconnection only of the zone affected by the fault.

In practice, it can be implemented in two ways:

- the releases send information on the preset current threshold that has been exceeded to the supervisor system and the latter decides which protective device has to trip;
- in the event of current values exceeding its setting threshold, each protective device sends a blocking signal via a direct connection or bus to the protective device higher in the hierarchy (i.e. upstream with respect to the direction of the power flow) and, before it trips, it makes sure that a similar blocking signal has not arrived from the protective device downstream; in this way, only the protective device immediately upstream of the fault trips.

The first mode foresees tripping times of about one second and is used mainly in the case of not particularly high short-circuit currents where a power flow is not uniquely defined.

The second mode enables distinctly shorter tripping times: with respect to a time discrimination coordination, there is no longer any need to increase the intentional time delay progressively as we move closer to the source of the power supply. The maximum delay is in relation to the time necessary to detect any presence of a blocking signal sent from the protective device downstream.

Advantages:

- reduction of the tripping times and increase of the safety level;
- reduction of both the damages caused by the fault as well of the disturbances in the power supply network;
- reduction of the thermal and dynamic stresses on the circuit-breakers and on the components of the system;
- large number of discrimination levels;
- redundancy of protections: in case of malfunction of zone discrimination, the tripping is ensured by the settings of the other protection functions of the circuit-breakers. In particular, it is possible to adjust the time-delay protection functions against short-circuit at increasing time values, the closer they are to the network's feeder.

Disadvantages:

- higher costs;
- greater complexity of the system (special components, additional wiring, auxiliary power sources, ...).

This solution is therefore used mainly in systems with high rated current and high short-circuit current values, with precise needs in terms of both safety and continuity of service: in particular, examples of logical discrimination can be often found in primary distribution switchboards, immediately downstream of transformers and generators and in meshed networks.

4 Protection coordination

Zone selectivity for circuit-breakers type Emax with PR123 releases

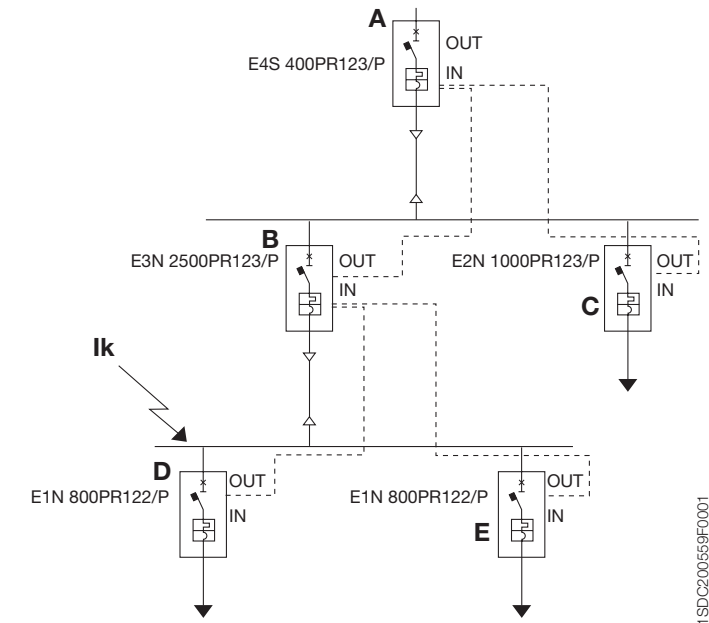

The example above shows a plant wired so as to guarantee zone selectivity with Emax CB equipped with PR122/P-PR123/P releases.

Each circuit-breaker detecting a fault sends a signal to the circuit-breaker immediately on the supply side through a communication wire; the circuit-breaker that does not receive any communication from the circuit-breakers on the load side shall launch the opening command.

In this example, with a fault located in the indicated point, the circuit-breakers D and E do not detect the fault and therefore they do not communicate with the circuit-breaker on the supply side (circuit-breaker B), which shall launch the opening command within the selectivity time set from 40 to 200 ms.

To actuate correctly zone selectivity, the following settings are suggested:

S	t_2 = selectivity time
I	I_3 = OFF
G	t_4 = selectivity time
Selectivity time	same settings for each circuit-breaker

4 Protection coordination

Zone selectivity for circuit-breakers type Tmax (T4L-T5L-T6L) with PR223 EF releases

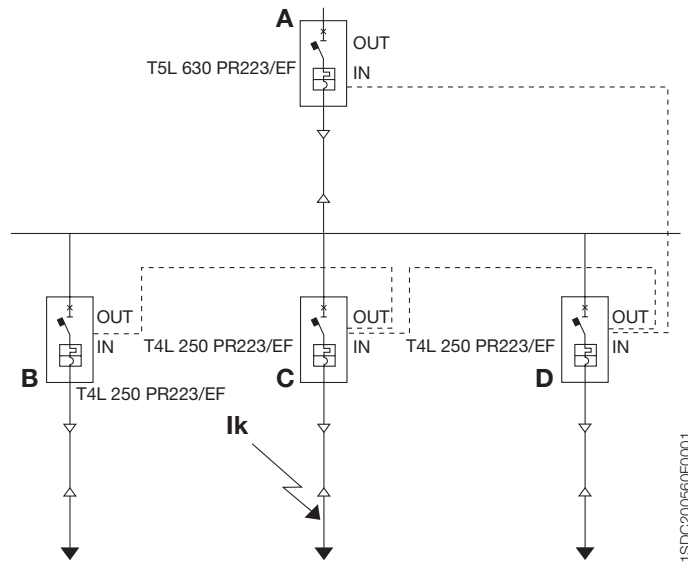

The example above shows a plant wired through an interlocking protocol (Interlocking, IL), so as to guarantee zone selectivity through PR223 EF release. In case of short-circuit, the circuit-breaker immediately on the supply side of the fault sends through the bus a block signal to the protection device hierarchically higher and verifies, before tripping, that an analogous block signal has not been sent by the protection on the load side.

In the example in the figure, the circuit-breaker C, immediately on the supply side of the fault, sends a block signal to the circuit-breaker A, which is hierarchically higher. If, as in the given example, no protection on the load side is present, the circuit-breaker C shall open in very quick times since it has received no block signal.

Everything occurs in shorter times (10 to 15ms) than in the case of zone selectivity with the Emax series air circuit-breaker (40 to 200ms), thus subjecting the plant to lower electrodynamic stresses, and with a consequent cost reduction for the plant.

4 Protection coordination

Energy discrimination

Energy coordination is a particular type of discrimination that exploits the current-limiting characteristics of moulded-case circuit-breakers. It is important to remember that a current-limiting circuit-breaker is "a circuit-breaker with a break time short enough to prevent the short-circuit current reaching its otherwise attainable peak value" (IEC 60947-2, def. 2.3).

In practice, ABB SACE moulded-case circuit-breakers of Isomax and Tmax series, under short-circuit conditions, are extremely rapid (tripping times of about some milliseconds) and therefore it is impossible to use the time-current curves for the coordination studies.

The phenomena are mainly dynamic (and therefore proportional to the square of the instantaneous current value) and can be described by using the specific let-through energy curves.

In general, it is necessary to verify that the let-through energy of the circuit-breaker downstream is lower than the energy value needed to complete the opening of the circuit-breaker upstream.

This type of discrimination is certainly more difficult to consider than the previous ones because it depends largely on the interaction between the two devices placed in series and demands access to data often unavailable to the end user. Manufacturers provide tables, rules and calculation programs in which the minimum discrimination limits are given between different combinations of circuit-breakers.

Advantages:

- fast breaking, with tripping times which reduce as the short-circuit current increases;
- reduction of the damages caused by the fault (thermal and dynamic stresses), of the disturbances to the power supply system, of the costs...;
- the discrimination level is no longer limited by the value of the short-time withstand current I_{cw} which the devices can withstand;
- large number of discrimination levels;
- possibility of coordination of different current-limiting devices (fuses, circuit-breakers,...) even if they are positioned in intermediate positions along the chain.

Disadvantage:

- difficulty of coordination between circuit-breakers of similar sizes.

This type of coordination is used above all for secondary and final distribution networks, with rated currents below 1600A.

Back-up protection

The back-up protection is an "over-current coordination of two over-current protective devices in series where the protective device, generally but not necessarily on the supply side, effects the over-current protection with or without the assistance of the other protective device and prevents any excessive stress on the latter" (IEC 60947-1, def. 2.5.24).

Besides, IEC 60364-4-43, § 434.5.1 states: "... A lower breaking capacity is admitted if another protective device having the necessary breaking capacity is installed on the supply side. In that case, characteristics of the devices, must be co-ordinated so that the energy let through by these two devices does not exceed that which can be withstood without damage by the device on the load side and the conductors protected by these devices."

4 Protection coordination

Advantages:

- cost-saving solution;
- extremely rapid tripping.

Disadvantages:

- extremely low discrimination values;
- low service quality, since at least two circuit-breakers in series have to trip.

Coordination between circuit-breaker and switch disconnecter

The switch disconnecter

The switch disconnectors derive from the corresponding circuit-breakers, of which they keep the overall dimensions, the fixing systems and the possibility of mounting all the accessories provided for the basic versions. They are devices which can make, carry and break currents under normal service conditions of the circuit.

They can also be used as general circuit-breakers in sub-switchboards, as bus-ties, or to isolate installation parts, such as lines, busbars or groups of loads.

Once the contacts have opened, these switches guarantee isolation thanks to their contacts, which are at the suitable distance to prevent an arc from striking in compliance with the prescriptions of the standards regarding aptitude to isolation.

Protection of switch disconnectors

Each switch disconnecter shall be protected by a coordinated device which safeguards it against overcurrents, usually a circuit-breaker able to limit the short-circuit current and the let-through energy values at levels acceptable for the switch-disconnector.

As regards overload protection, the rated current of the circuit-breaker shall be lower than or equal to the size of the disconnecter to be protected.

Regarding Isomax and Tmax series switch disconnectors the coordination tables show the circuit-breakers which can protect them against the indicated prospective short-circuit currents values.

Regarding Emax series switch disconnectors it is necessary to verify that the short-circuit current value at the installation point is lower than the short-time withstand current I_{cw} of the disconnecter, and that the peak value is lower than the making current value (I_{cm}).

4 Protection coordination

4.2 Discrimination tables

The tables below give the selectivity values of short-circuit currents (in kA) between pre-selected combinations of circuit-breakers, for voltages from 380 to 415 V. The tables cover the possible combinations of ABB SACE Emax air circuit-breakers series, ABB SACE Isomax and Tmax moulded-case circuit-breakers series and the series of ABB modular circuit-breakers. The values are obtained following particular rules which, if not respected, may give selectivity values which in some cases may be much lower than those given. Some of these guidelines are generally valid and are indicated below; others refer exclusively to particular types of circuit-breakers and will be subject to notes below the relevant table.

General rules:

- the function I of electronic releases (PR121-PR122-PR123, PR211/P-PR212/P, PR221DS-PR222DS/P) of upstream breakers must be excluded (I3 in OFF);
- the magnetic trip of thermomagnetic (TM) or magnetic only (MA-MF) breakers positioned upstream must be $\geq 10 \cdot I_n$ and set to the maximum threshold;
- it is fundamentally important to verify that the settings adopted by the user for the electronic and thermomagnetic releases of breakers positioned either upstream or downstream result in time-current curves properly spaced.

Notes for the correct reading of the coordination tables:

The limit value of selectivity is obtained considering the lower among the given value, the breaking capacity of the CB on the supply side and the breaking capacity of the CB on the load side.

The letter T indicates total selectivity for the given combination, the corresponding value in kA is obtained considering the lower of the downstream and upstream circuit-breakers' breaking capacities (Icu).

The following tables show the breaking capacities at 415Vac for SACE Emax, Isomax and Tmax circuit-breakers.

Tmax @ 415V ac		Isomax @ 415V ac		Emax @ 415V ac	
Version	Icu [kA]	Version	Icu [kA]	Version	Icu [kA]
B	16	N	35*	B	42
C	25	S	50	N	65**
N	36	H	65	S	75***
S	50	L	100	H	100
H	70			L	130
L (for T2)	85			V	150****
L (for T4-T5)	120				
L (for T6)	100				
V	200				

* Versions certified at 36 kA
 ** For Emax E1 version N Icu=50 kA
 *** For Emax E2 version S Icu=85 kA
 **** For Emax E3 version V Icu=130 kA

Keys

For MCCB (Moulded-case circuit-breaker) ACB (Air circuit-breaker) TM = thermomagnetic release - TMD (Tmax) - TMA (Tmax) - T adjustable M adjustable (Isomax) M = magnetic only release - MF (Tmax) - MA (Tmax) EL = electronic release - PR121/P - PR122/P - PR123/P - PR211/P - PR212/P (Isomax) - PR221DS - PR222DS (Tmax)	For MCB (Miniature circuit-breaker): B = characteristic trip (I3=3...5In) C = characteristic trip (I3=5...10In) D = characteristic trip (I3=10...20In) K = characteristic trip (I3=8...14In) Z = characteristic trip (I3=2...3In)
--	--

4 Protection coordination

Example:

From the selectivity table on page 213 it can be seen that breakers E2N1250 and T5H400, correctly set, are selective up to 55kA (higher than the short-circuit current at the busbar).

From the selectivity table on page 206 it can be seen that, between T5H400 and T1N160 In125, the total selectivity is granted; as already specified on page 189 this means selectivity up to the breaking capacity of T1N and therefore up to 36 kA (higher than the short-circuit current at the busbar).

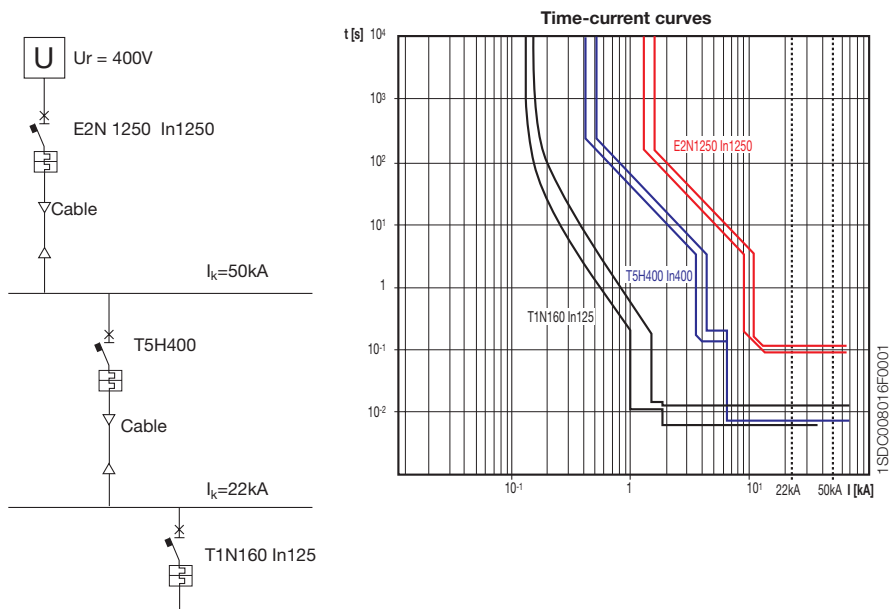

From the curves it is evident that between breakers E2N1250 and T5H400 time discrimination exists, while between breakers T5H400 and T1N160 there is energy discrimination.

4 Protection coordination

Discrimination tables MCB-MCB

MCB - S2.. B @ 415V

Char.		Supply s.									
		S290		S500							
Icu [kA]	In [A]	D		D							
		15	50	80	100	32	40	50	63		
6	≤2										
10	3										
15	4										
25	6	10.5	T	1.5	2	3	5.5				
	8	10.5	T	1.5	2	3	5.5				
	10	5	8	1	1.5	2	3				
	13	4.5	7		1.5	2	3				
	16	4.5	7			2	3				
	20	3.5	5				2.5				
	25	3.5	5								
	32		4.5								
	40										
	50										
	63										

MCB - S2.. C @ 415V

Char.		Supply s.									
		S290		S500							
Icu [kA]	In [A]	D		D							
		15	50	80	100	32	40	50	63		
6	≤2	T	T	T	T	T	T				
10	3	T	T	3	6	T	T				
15	4	T	T	2	3	6	T				
25	6	10.5	T	1.5	2	3	5.5				
	8	10.5	T	1.5	2	3	5.5				
	10	5	8	1	1.5	2	3				
	13	4.5	7		1.5	2	3				
	16	4.5	7			2	3				
	20	3.5	5				2.5				
	25	3.5	5								
	32		4.5								
	40										
	50										
	63										

4 Protection coordination

Discrimination tables MCB-MCB

MCB - S2.. D @ 415V

Char.		Supply s.									
		S290					S500				
		D					D				
Icu [kA]					In [A]	15		50			
	6	10	15	25		80	100	32	40	50	63
-	S200	S200M	S200P	≤2	T	T	T	T	T	T	T
-	S200	S200M	S200P	3	T	T	3	6	T	T	
-	S200	S200M	S200P	4	T	T	2	3	6	T	
-	S200	S200M	S200P	6	10.5	T	1.5	2	3	5.5	
-	S200	S200M	S200P	8	10.5	T	1.5	2	3	5.5	
-	S200	S200M	S200P	10	5	8	1	1.5	2	3	
-	S200	-	S200P	13	3	5			1.5	2	
-	S200	S200M	S200P	16	3	5				2	
-	S200	S200M	S200P	20	3	5					
-	S200	S200M	S200P	25		4					
-	S200	S200M-S200P	-	32							
-	S200	S200M-S200P	-	40							
-	S200	S200M-S200P	-	50							
-	S200	S200M-S200P	-	63							

MCB - S2.. K @ 415V

Char.		Supply s.									
		S290					S500				
		D					D				
Icu [kA]					In [A]	15		50			
	6	10	15	25		80	100	32	40	50	63
-	S200	S200M	S200P	≤2	T	T	T	T	T	T	T
-	S200	S200M	S200P	3	T	T	3	6	T	T	
-	S200	S200M	S200P	4	T	T	2	3	6	T	
-	S200	S200M	S200P	6	10.5	T	1.5	2	3	5.5	
-	S200	S200M	S200P	8	10.5	T	1.5	2	3	5.5	
-	S200	S200M	S200P	10	5	8		1.5	2	3	
-	-	-	S200P	13	3	5			1.5	2	
-	S200	S200M	S200P	16	3	5				2	
-	S200	S200M	S200P	20	3	5					
-	S200	S200M	S200P	25		4					
-	S200	S200M-S200P	-	32							
-	S200	S200M-S200P	-	40							
-	S200	S200M-S200P	-	50							
-	S200	S200M-S200P	-	63							

4 Protection coordination

MCB - S2.. Z @ 415V

Char.		Supply s.									
		S290					S500				
		D					D				
Icu [kA]					In [A]	15		50			
	6	10	15	25		80	100	32	40	50	63
-	S200	-	S200P	≤2	T	T	T	T	T	T	T
-	S200	-	S200P	3	T	T	3	6	T	T	
-	S200	-	S200P	4	T	T	2	3	6	T	
-	S200	-	S200P	6	10.5	T	1.5	2	3	5.5	
-	S200	-	S200P	8	10.5	T	1.5	2	3	5.5	
-	S200	-	S200P	10	5	8	1	1.5	2	3	
-	S200	-	S200P	13	4.5	7	1	1.5	2	3	
-	-	-	S200P	16	4.5	7	1	1.5	2	3	
-	S200	-	S200P	20	3.5	5			1.5	2	2.5
-	S200	-	S200P	25	3.5	5				2	2.5
-	S200	S200P	-	32	3	4.5					2
-	S200	S200P	-	40	3	4.5					
-	S200	S200P	-	50		3					
-	S200	S200P	-	63							

1SDC008005F0201

4 Protection coordination

4 Protection coordination

Discrimination tables MCCB - S2..

MCCB - S2.. B @ 415V

Char.	Icu [kA]	Version	B, C, N, S, H, L										B, C, N, S, H, L, V																																														
			Supply s.	TM					TM					EL																																													
				T2	T1-T2				T1-T2-T3					T3		T4						T5	T2			T4			T5																														
6	10	15	25	In [A]	12.5	16	20	25	32	40	50	63		80	100	125	160	200	250	20	25	32	50	80	100	125	160	200	250	320+	500	10	25	63	100	160	100	250	320+	630																			
Load s.	-	-	-	-	≤2																																																						
	-	-	-	-	3																																																						
	-	-	-	-	4																																																						
	-	S200	S200M	S200P	6	5.5 ⁽¹⁾	5.5	5.5	5.5	5.5	5.5	5.5	10.5		T	T	T	T	T	T	7.5	7.5 ⁽⁴⁾	7.5	7.5	T	T	T	T	T	T	T																												
	-	S200	S200M	S200P	8				5.5	5.5	5.5	5.5	10.5		T	T	T	T	T	T	7.5	7.5 ⁽⁴⁾	7.5	7.5	T	T	T	T	T	T																													
	-	S200	S200M	S200P	10				3 ⁽¹⁾	3	3	3	4.5	7.5		8.5	17	T	T	T	5	5 ⁽⁴⁾	5	6.5	9	T	T	T	T	T	T																												
	-	S200	S200M	S200P	13				3 ⁽¹⁾		3	3	4.5	7.5		7.5	12	20	T	T	5 ⁽⁴⁾	5	6.5	8	T	T	T	T	T	T																													
	-	S200	S200M	S200P	16					3 ⁽¹⁾	3	4.5	5			7.5	12	20	T	T	3 ⁽⁴⁾	5	6.5	8	T	T	T	T	T	T																													
	-	S200	S200M	S200P	20					3 ⁽¹⁾	3	5				6	10	15	T	T				5	7.5	T	T	T	T	T																													
	-	S200	S200M	S200P	25							3 ⁽¹⁾	5			6	10	15	T	T				5	7.5	T	T	T	T	T																													
	-	S200	S200M-S200P	-	32							3 ⁽¹⁾				6	7.5	12	T	T				5 ⁽⁴⁾	7.5	T	T	T	T	T																													
	-	S200	S200M-S200P	-	40											5.5 ⁽¹⁾	7.5	12	T	T					6.5	T	T	T	T	T																													
-	S200	S200M-S200P	-	50											3 ⁽¹⁾	5 ⁽²⁾	7.5	10.5	T	T				5 ⁽⁴⁾	T	T	T	T	T																														
-	S200	S200M-S200P	-	63												5 ⁽²⁾	6 ⁽²⁾	10.5	T	T					T ⁽⁴⁾	T ⁽⁴⁾	T	T	T	T																													
-	-	-	-	80																																																							
-	-	-	-	100																																																							
-	-	-	-	125																																																							

- (1) Value for the supply side magnetic only T2 circuit-breaker.
- (2) Value for the supply side magnetic only T2-T3 circuit-breaker.
- (3) Value for the supply side magnetic only T3 circuit-breaker.
- (4) Value for the supply side magnetic only T4 circuit-breaker.

1SDC008007F0201

4 Protection coordination

4 Protection coordination

Discrimination tables MCCB - S2..

MCCB - S2.. C @ 415V

Char.	Icu [kA]				Version	B, C, N, S, H, L																																			
					Release	TM																				EL															
					Supply s.	T2	T1-T2				T1-T2-T3				T3		T4								T5	T2				T4		T5									
6	10	15	25	In [A]	12.5	16	20	25	32	40	50	63	80	100	125	160	200	250	20	25	32	50	80	100	125	160	200	250	320+500	10	25	63	100	160	100	250	320+630				
Load s. C	-	S200	S200M	S200P	≤2	T	T	T	T	T	T	T		T	T	T	T	T	T	T ⁽⁴⁾	T	T	T	T	T	T	T	T	T	T	T	T	T	T	T	T	T	T	T		
	-	S200	S200M	S200P	3	T	T	T	T	T	T	T		T	T	T	T	T	T	T ⁽⁴⁾	T	T	T	T	T	T	T	T	T	T	T	T	T	T	T	T	T	T	T	T	
	-	S200	S200M	S200P	4	T	T	T	T	T	T	T		T	T	T	T	T	T	T ⁽⁴⁾	T	T	T	T	T	T	T	T	T	T	T	T	T	T	T	T	T	T	T	T	T
	S200L	S200	S200M	S200P	6	5.5 ⁽¹⁾	5.5	5.5	5.5	5.5	5.5	5.5	10.5		T	T	T	T	T	7.5	7.5 ⁽⁴⁾	7.5	7.5	T	T	T	T	T	T	T	T	T	T	T	T	T	T	T	T	T	T
	S200L	S200	S200M	S200P	8			5.5	5.5	5.5	5.5	5.5	10.5		T	T	T	T	T	7.5	7.5 ⁽⁴⁾	7.5	7.5	T	T	T	T	T	T	T	T	T	T	T	T	T	T	T	T	T	T
	S200L	S200	S200M	S200P	10			3 ⁽¹⁾	3	3	3	4.5	7.5		8.5	17	T	T	T	5	5 ⁽⁴⁾	5	6.5	9	T	T	T	T	T	T	T	T	T	T	T	T	T	T	T	T	T
	S200L	S200	S200M	S200P	13			3 ⁽¹⁾		3	3	4.5	7.5		7.5	12	20	T	T	T	5 ⁽⁴⁾	5	6.5	8	T	T	T	T	T	T	T	T	T	T	T	T	T	T	T	T	
	S200L	S200	S200M	S200P	16					3 ⁽¹⁾	3	4.5	5		7.5	12	20	T	T	T	3 ⁽⁴⁾	5	6.5	8	T	T	T	T	T	T	T	T	T	T	T	T	T	T	T	T	
	S200L	S200	S200M	S200P	20					3 ⁽¹⁾		3	5		6	10	15	T	T	T					5	7.5	T	T	T	T	T	T	T	T	T	T	T	T	T	T	
	S200L	S200	S200M	S200P	25						3 ⁽¹⁾		5		6	10	15	T	T	T					5	7.5	T	T	T	T	T	T	T	T	T	T	T	T	T	T	
	S200L	S200	S200M-S200P	-	32							3 ⁽¹⁾			6	7.5	12	T	T	T					5 ⁽⁴⁾	7.5	T	T	T	T	T	T	T	T	T	T	T	T	T	T	
	S200L	S200	S200M-S200P	-	40										5.5 ⁽¹⁾	7.5	12	T	T	T						6.5	T	T	T	T	T	T	T	T	T	T	T	T	T		
	-	S200	S200M-S200P	-	50										3 ⁽¹⁾	5 ⁽²⁾	7.5	10.5	T	T						5 ⁽⁴⁾	T	T	T	T	T	T	T	T	T	T	T	T	T		
	-	S200	S200M-S200P	-	63											5 ⁽²⁾	6 ⁽³⁾	10.5	T	T							T ⁽⁴⁾	T ⁽⁴⁾	T	T	T	T	T	T	T	T	T	T	T		
	-	-	S290	-	80												4 ⁽³⁾	10	15										5	11	T	T				4	T ⁽⁹⁾	T	T		
	-	-	S290	-	100												4 ⁽³⁾	7.5 ⁽³⁾	15										5 ⁽⁴⁾	8	T	T				4	12 ⁽⁴⁾	T	T		
	-	-	S290	-	125													7.5 ⁽³⁾											8 ⁽⁴⁾	12	T					4		T	T		

⁽¹⁾ Value for the supply side magnetic only T2 circuit-breaker.
⁽²⁾ Value for the supply side magnetic only T2-T3 circuit-breaker.
⁽³⁾ Value for the supply side magnetic only T3 circuit-breaker.
⁽⁴⁾ Value for the supply side magnetic only T4 circuit-breaker.
⁽⁵⁾ Value for the supply side T4 In160 circuit-breaker.

1SDC00808F0201

4 Protection coordination

4 Protection coordination

Discrimination tables MCCB - S2..

MCCB - S2.. D @ 415V

Char.	Icu [kA]				Version	B, C, N, S, H, L																																				
					Release	TM														TM														EL								
						Supply s.	T2	T1-T2				T1-T2-T3				T3		T4						T5	T2			T4			T5											
6	10	15	25	In [A]	12.5	16	20	25	32	40	50	63		80	100	125	160	200	250	20	25	32	50	80	100	125	160	200	250	320+	10	25	63	100	160	100	250	320+				
Load s. D	-	S200	S200M	S200P	≤2	T	T	T	T	T	T	T	T		T	T	T	T	T	T	T ⁽⁴⁾	T	T	T	T	T	T	T	T	T	T	T	T	T	T	T	T	T				
	-	S200	S200M	S200P	3	T	T	T	T	T	T	T	T		T	T	T	T	T	T	T	T ⁽⁴⁾	T	T	T	T	T	T	T	T	T	T	T	T	T	T	T	T	T	T		
	-	S200	S200M	S200P	4	T	T	T	T	T	T	T	T		T	T	T	T	T	T	T	T ⁽⁴⁾	T	T	T	T	T	T	T	T	T	T	T	T	T	T	T	T	T	T	T	
	-	S200	S200M	S200P	6	5.5 ⁽¹⁾	5.5	5.5	5.5	5.5	5.5	5.5	10.5		T	T	T	T	T	T	7.5	7.5 ⁽⁴⁾	7.5	7.5	T	T	T	T	T	T	T	T	T	T	T	T	T	T	T	T	T	
	-	S200	S200M	S200P	8			5.5	5.5	5.5	5.5	5.5	10.5		12	T	T	T	T	T	7.5	7.5 ⁽⁴⁾	7.5	7.5	T	T	T	T	T	T	T	T	T	T	T	T	T	T	T	T	T	
	-	S200	S200M	S200P	10			3 ⁽¹⁾	3	3	3	3	5		8.5	17	T	T	T	T	5	5 ⁽⁴⁾	5	5	9	T	T	T	T	T	T	T	T	T	T	T	T	T	T	T	T	T
	-	S200	-	S200P	13					2 ⁽¹⁾	2	2	3		5	8	13.5	T	T	T		5 ⁽⁴⁾		4	5.5	T	T	T	T	T	T	T	T	T	T	T	T	T	T	T	T	
	-	S200	S200M	S200P	16					2 ⁽¹⁾	2	2	3		5	8	13.5	T	T	T				4	5.5	T	T	T	T	T	T	T	T	T	T	T	T	T	T	T	T	
	-	S200	S200M	S200P	20					2 ⁽¹⁾		2	3		4.5	6.5	11	T	T	T				4 ⁽⁴⁾	5	T	T	T	T	T	T	T	T	T	T	T	T	T	T	T	T	
	-	S200	S200M	S200P	25							2 ⁽¹⁾	2.5		4	6	9.5	T	T	T				4 ⁽⁴⁾	4.5	T	T	T	T	T	T	T	T	T	T	T	T	T	T	T	T	
	-	S200	S200M-S200P	-	32										4	6	9.5	T	T	T				4.5 ⁽⁴⁾	T	T	T	T	T	T	T	T	T	T	T	T	T	T	T	T	T	
	-	S200	S200M-S200P	-	40										3 ⁽¹⁾	5	8	T	T	T				4.5 ⁽⁴⁾	T ⁽⁴⁾	T	T	T	T	T	T	T	T	T	T	T	T	T	T	T	T	
	-	S200	S200M-S200P	-	50										2 ⁽¹⁾	3 ⁽²⁾	5	9.5	T	T					T ⁽⁴⁾	T ⁽⁴⁾	T	T	T	T	T	T	T	T	T	T	T	T	T	T	T	
	-	S200	S200M-S200P	-	63											3 ⁽²⁾	5 ⁽⁸⁾	9.5	T	T					T ⁽⁴⁾	T ⁽⁴⁾	T	T	T	T	T	T	T	T	T	T	T	T	T	T	T	
	-	-	S290	-	80												4 ⁽⁸⁾	10	15								5	11	T	T							4	T ⁽⁸⁾	T	T	T	
-	-	S290	-	100												4 ⁽⁸⁾	7.5 ⁽⁸⁾	15									8	T	T							4	12 ⁽⁸⁾	T	T	T	T	
-	-	-	-	125																																						

(1) Value for the supply side magnetic only T2 circuit-breaker.
 (2) Value for the supply side magnetic only T2-T3 circuit-breaker.
 (3) Value for the supply side magnetic only T3 circuit-breaker.
 (4) Value for the supply side magnetic only T4 circuit-breaker.
 (5) Value for the supply side T4 In160 circuit-breaker.

1SD008009F0201

4 Protection coordination

4 Protection coordination

Discrimination tables MCCB - S2..

MCCB - S2.. K @ 415V

Char.	Icu [kA] 6 10 15 25				Version	B, C, N, S, H, L																																					
					Release	TM																TM																EL					
						Supply s.	T2	T1-T2				T1-T2-T3				T3		T4						T5	T2		T4		T5														
In [A]	12.5	16	20	25	32	40	50	63	80	100	125	160	200	250	20	25	32	50	80	100	125	160	200	250	320+	500	10	25	63	100	160	100	250	320+	630								
Loact s. K	-	S200	S200M	S200P	≤2	T	T	T	T	T	T	T	T	T	T	T	T ⁽⁴⁾	T	T	T	T	T	T	T	T	T	T	T	T	T	T	T	T	T	T	T	T						
	-	S200	S200M	S200P	3	T	T	T	T	T	T	T	T	T	T	T	T ⁽⁴⁾	T	T	T	T	T	T	T	T	T	T	T	T	T	T	T	T	T	T	T	T	T					
	-	S200	S200M	S200P	4	T	T	T	T	T	T	T	T	T	T	T	T ⁽⁴⁾	T	T	T	T	T	T	T	T	T	T	T	T	T	T	T	T	T	T	T	T	T	T				
	-	S200	S200M	S200P	6	5.5 ⁽¹⁾	5.5	5.5	5.5	5.5	5.5	5.5	10.5			T	T	T	T	T	7.5	7.5 ⁽⁴⁾	7.5	7.5	T	T	T	T	T	T	T	T	T	T	T	T	T	T					
	-	S200	S200M	S200P	8			5.5	5.5	5.5	5.5	5.5	10.5			12	T	T	T	T	7.5	7.5 ⁽⁴⁾	7.5	7.5	T	T	T	T	T	T	T	T	T	T	T	T	T	T					
	-	S200	S200M	S200P	10			3 ⁽¹⁾	3	3	3	6				8.5	17	T	T	T																							
	-	-	-	S200P	13				2 ⁽¹⁾	3	3	5				7.5	10	13.5	T	T																							
	-	S200	S200M	S200P	16				2 ⁽¹⁾	3	3	4.5				7.5	10	13.5	T	T																							
	-	S200	S200M	S200P	20				2 ⁽¹⁾		3	3.5				5.5	6.5	11	T	T																							
	-	S200	S200M	S200P	25					2 ⁽¹⁾		3.5				5.5	6	9.5	T	T																							
	-	S200	S200M-S200P	-	32											4.5	6	9.5	T	T																							
	-	S200	S200M-S200P	-	40											3 ⁽¹⁾	5	8	T	T																							
	-	S200	S200M-S200P	-	50											2 ⁽¹⁾	3 ⁽²⁾	6	9.5	T	T																						
	-	S200	S200M-S200P	-	63												3 ⁽²⁾	5.5 ⁽³⁾	9.5	T	T																						
	-	-	S290	-	80													4 ⁽³⁾	10	15																							
-	-	S290	-	100													4 ⁽³⁾	7.5 ⁽³⁾	15																								
-	-	-	-	125																																							

(1) Value for the supply side magnetic only T2 circuit-breaker.
 (2) Value for the supply side magnetic only T2-T3 circuit-breaker.
 (3) Value for the supply side magnetic only T3 circuit-breaker.
 (4) Value for the supply side magnetic only T4 circuit-breaker.
 (5) Value for the supply side T4 In160 circuit-breaker.

1SD0008010F0201

4 Protection coordination

4 Protection coordination

Discrimination tables MCCB - S2..

MCCB - S2.. Z @ 400V

Char.	Icu [kA]	Version												B, C, N, S, H, L												B, C, N, S, H, L, V																	
		Release												TM												EL																	
		Supply s.	T2				T1-T2				T1-T2-T3				T3		T4						T5		T2		T4		T5														
6	10	15	25	In [A]	12.5	16	20	25	32	40	50	63	80	100	125	160	200	250	20	25	32	50	80	100	125	160	200	250	320+	500	10	25	63	100	160	100	250	320+	630				
Z	-	S200	-	S200P	≤2	T	T	T	T	T	T	T		T	T	T	T	T	T	T ⁽⁴⁾	T	T	T	T	T	T	T	T	T	T	T	T	T	T	T	T	T	T	T	T			
	-	S200	-	S200P	3	T	T	T	T	T	T	T		T	T	T	T	T	T	T	T ⁽⁴⁾	T	T	T	T	T	T	T	T	T	T	T	T	T	T	T	T	T	T	T	T		
	-	S200	-	S200P	4	T	T	T	T	T	T	T		T	T	T	T	T	T	T	T ⁽⁴⁾	T	T	T	T	T	T	T	T	T	T	T	T	T	T	T	T	T	T	T	T	T	
	-	S200	-	S200P	6	5.5 ⁽¹⁾	5.5	5.5	5.5	5.5	5.5	5.5	10.5		T	T	T	T	T	T	7.5	7.5 ⁽⁴⁾	7.5	7.5	T	T	T	T	T	T	T	T	T	T	T	T	T	T	T	T	T	T	
	-	S200	-	S200P	8			5.5	5.5	5.5	5.5	5.5	10.5		T	T	T	T	T	T	7.5	7.5 ⁽⁴⁾	7.5	7.5	T	T	T	T	T	T	T	T	T	T	T	T	T	T	T	T	T	T	
	-	S200	-	S200P	10			3 ⁽¹⁾	3	3	3	4.5	8		8.5	17	T	T	T	T	5	5 ⁽⁴⁾	5	6.5	9	T	T	T	T	T	T	T	T	T	T	T	T	T	T	T	T	T	T
	-	-	-	S200P	13			3 ⁽¹⁾		3	3	4.5	7.5		7.5	12	20	T	T	T		5 ⁽⁴⁾	5	6.5	8	T	T	T	T	T	T	T	T	T	T	T	T	T	T	T	T	T	
	-	S200	-	S200P	16					3 ⁽¹⁾	3	4.5	5		7.5	12	20	T	T	T		5 ⁽⁴⁾	4.5	6.5	8	T	T	T	T	T	T	T	T	T	T	T	T	T	T	T	T	T	
	-	S200	-	S200P	20					3 ⁽¹⁾	3	5			6	10	15	T	T	T				5	6.5	T	T	T	T	T	T	T	T	T	T	T	T	T	T	T	T	T	
	-	S200	-	S200P	25						3 ⁽¹⁾	5			6	10	15	T	T	T				5	6.5	T	T	T	T	T	T	T	T	T	T	T	T	T	T	T	T	T	
	-	S200	S200P	-	32						3 ⁽¹⁾				6	7.5	12	T	T	T				5 ⁽⁴⁾	6.5	T	T	T	T	T	T	T	T	T	T	T	T	T	T	T	T	T	
	-	S200	S200P	-	40										5.5 ⁽¹⁾	7.5	12	T	T	T				5	6.5	T	T	T	T	T	T	T	T	T	T	T	T	T	T	T	T		
	-	S200	S200P	-	50										4 ⁽¹⁾	5 ⁽²⁾	7.5	10.5	T	T				3.5 ⁽⁴⁾	T	T	T	T	T	T	T	T	T	T	T	T	T	T	T	T	T		
	-	S200	S200P	-	63											5 ⁽²⁾	6 ⁽³⁾	10.5	T	T					T ⁽⁴⁾	T	T	T	T	T	T	T	T	T	T	T	T	T	T	T	T		
	-	-	-	-	80																																						
-	-	-	-	100																																							
-	-	-	-	125																																							

⁽¹⁾ Value for the supply side magnetic only T2 circuit-breaker.
⁽²⁾ Value for the supply side magnetic only T2-T3 circuit-breaker.
⁽³⁾ Value for the supply side magnetic only T3 circuit-breaker.
⁽⁴⁾ Value for the supply side magnetic only T4 circuit-breaker.

1SDC008011FC0201

4 Protection coordination

Discrimination tables MCCB - MCCB

MCCB - T1 @ 415V

		Supply s.		T1	T2					T3			T4							T4		T5			T6				S7																	
Version				B, C, N	N,S,H,L					N,S			N,S,H,L,V							N,S,H,L,V		N,S,H,L,V			N,S,H,L				S,H,L																	
Release				TM	TM,M		EL			TM,M			TM,M							EL		TM		EL	TM,M		EL		EL																	
Load s.		I _u [A]		160	160		160			250			250							400		320		400		630	800		630		800		1000	1250		1600										
		I _n [A]		160	160	25	63	100	160	160	200	250	20	25	32	50	80	100	125	160	200	250	100	160	250	320	320	400	500	320	400	630	800	630	800	1000	1000	1250	1600							
T1	B C N	TM	160	16	3	3		3	3	3	3	4	5			10*	10	10	10	10	10	10	10	10	10	10	10	10	10	10	10	10	10	10	10	10	10	10	10	10						
				20	3	3		3	3	3	3	4	5					10*	10	10	10	10	10	10	10	10	10	10	10	10	10	10	10	10	10	10	10	10	10	10	10	10	10	10		
				25	3	3		3	3	3	3	4	5					10*	10	10	10	10	10	10	10	10	10	10	10	10	10	10	10	10	10	10	10	10	10	10	10	10	10	10	10	
				32	3	3		3	3	3	3	4	5					10*	10	10	10	10	10	10	10	10	10	10	10	10	10	10	10	10	10	10	10	10	10	10	10	10	10	10	10	10
				40	3	3		3	3	3	3	4	5					10*	10	10	10	10	10	10	10	10	10	10	10	10	10	10	10	10	10	10	10	10	10	10	10	10	10	10	10	
				50	3	3		3	3	3	3	4	5					10*	10	10	10	10	10	10	10	10	10	10	10	10	10	10	10	10	10	10	10	10	10	10	10	10	10	10	10	
				63	3	3		3	3	3	3	4	5						10*	10	10	10	10	10	10	10	10	10	10	10	10	10	10	10	10	10	10	10	10	10	10	10	10	10	10	
				80				3	3	3	3	4	5										10	10	10	10	10	10	10	10	10	10	10	10	10	10	10	10	10	10	10	10	10	10	10	
				100								5											10*	10	10	10	10	10	10	10	10	10	10	10	10	10	10	10	10	10	10	10	10	10	10	
				125																				10*	10	10	10	10	10	10	10	10	10	10	10	10	10	10	10	10	10	10	10	10	10	
160																						10	10	10	10	10	10	10	10	10	10	10	10	10	10	10	10	10	10	10	10					

* Value for the supply side magnetic only circuit-breaker.

1SDC008012F0201

4 Protection coordination

4 Protection coordination

Discrimination tables MCCB - MCCB

MCCB T2 @ 415V

Load s.	Version	Release	I _n [A]	Supply s.		T1	T2	T3	T4		T4	T5	T6	S7																												
				B, C, N	N,S,H,L	N,S	N,S,H,L,V						N,S,H,L,V	N,S,H,L			N,S,H,L																									
				TM	TM,M	EL	TM,M	TM,M						EL	TM	EL	TM,M	EL																								
				160	160	160	160	200	250	20	25	32	50	80	100	125	160	200	250		250	320	400	630	400	630	630	800	630	800	1000	1000	1250	1600								
T2	N S H L	TM	160	1.6-2.5	T	T	T	T	T	T	T*	T	T	T	T	T	T	T	T	T		T	T	T	T	T	T	T	T	T	T	T	T	T	T	T						
				3.2	T	T	T	T	T	T	T	T	T	T*	T	T	T	T	T	T	T	T		T	T	T	T	T	T	T	T	T	T	T	T	T	T	T	T			
				4-5	T	T	T	T	T	T	T	T	T	T*	T	T	T	T	T	T	T	T		T	T	T	T	T	T	T	T	T	T	T	T	T	T	T	T	T	T	
				6.3	10	10	10	10	10	10	10	15	40	T*	T	T	T	T	T	T	T	T		T	T	T	T	T	T	T	T	T	T	T	T	T	T	T	T	T		
				8	10	10	10	10	10	10	15	40		T*	T	T	T	T	T	T	T	T		T	T	T	T	T	T	T	T	T	T	T	T	T	T	T	T	T	T	
				10	10	10	10	10	10	10	15	40		T*	T	T	T	T	T	T	T	T		T	T	T	T	T	T	T	T	T	T	T	T	T	T	T	T	T	T	
				12.5	3	3		3	3	3	3	4	5			T	T	T	T	T	T	T		T	T	T	T	T	T	T	T	T	T	T	T	T	T	T	T	T	T	
				16	3	3		3	3	3	3	4	5					70	70	70	70	70	70		70	70	70	70	70	70	70	70	70	70	70	70	70	70	70	70	70	
				20	3	3		3	3	3	3	4	5					55*	55	55	55	55	55		55	55	55	55	55	55	55	55	55	55	55	55	55	55	55	55	55	
				25	3	3		3	3	3	3	4	5					40*	40	40	40	40	40		40	40	40	40	40	40	40	40	40	40	40	40	40	40	40	40	40	
				32	3	3		3	3	3	3	4	5					40*	40	40	40	40	40		40	40	40	40	40	40	40	40	40	40	40	40	40	40	40	40	40	40
				40	3	3		3	3	3	3	4	5					30*	30*	30	30	30	30		30	30	30	30	30	30	30	30	30	30	30	30	30	30	30	30	30	
				50	3	3		3	3	3	3	4	5					30*	30*	30	30	30	30		30	30	30	30	30	30	30	30	30	30	30	30	30	30	30	30	30	
				63	3	3		3	3	3	3	4	5					30*	30*	30*	30	30	30		30	30	30	30	30	30	30	30	30	30	30	30	30	30	30	30	30	
				80				3	3*	4	5							25*	25*	25*	25	25	25		25	25	25	25	25	25	25	25	25	25	25	25	25	25	25	25	25	
				100						4	5									25*	25*	25*	25		25	25	25	25	25	25	25	25	25	25	25	25	25	25	25	25	25	
				125																	25*	25*				25	25	25	25	25	25	25	25	25	25	25	25	25	25	25	25	
				160																		25*			25	25	25	25	25	25	25	25	25	25	25	25	25	25	25	25	25	
				10								3	4					25	25	25	25	25	25		25	25	25	25	25	25	25	25	25	25	25	25	25	25	25	25	25	
				25								3	4					25	25	25	25	25	25		25	25	25	25	25	25	25	25	25	25	25	25	25	25	25	25	25	
63								3	4									25	25		25	25	25	25	25	25	25	25	25	25	25	25	25	25	25	25	25					
100								3	4												25	25	25	25	25	25	25	25	25	25	25	25	25	25	25	25	25					
160								3	4													25	25	25	25	25	25	25	25	25	25	25	25	25	25	25	25					

* Value for the supply side magnetic only circuit-breaker.

1SDC008013F0201

4 Protection coordination

4 Protection coordination

Discrimination tables MCCB - MCCB

MCCB - T3 @ 415V

		Supply s.		T1	T2			T3			T4						T4		T5			T6				S7												
Version		B, C, N		TM	N,S,H,L			N,S			N,S,H,L,V						N,S,H,L,V		N,S,H,L,V			N,S,H,L				S,H,L												
Release		TM, M		TM	EL			TM, M			TM, M						EL		TM	EL		TM, M	EL		EL													
Load s.		I _u [A]		160	160			250			250						250	320	400	630	400	630	630	800	630	800	1000	1250	1600									
T3	N S	TM	160	I _n [A]	160	160	25	63	100	160	160	200	250	20	25	32	50	80	100	125	160	200	250	250	320	400	630	400	630	630	800	630	800	1000	1250	1600		
				63																	7*	7	7	7														
				80							3*	4	5									7*	7	7														
				100								4*	5									7*	7*	7														
				125																			7*															
				160																																		
				200																																		
250																																						

* Value for the supply side magnetic only circuit-breaker.

1SD0008014F0201

MCCB - T4 @ 415V

		Supply s.		T5						T6				S7						
Version		N,S,H,L,V		N,S,H,L,V						N,S,H,L				S,H,L						
Release		TM, M		TM		EL		TM, M		EL		EL								
Load s.		I _u [A]		400	630	400	630	630	800	630	800	1000	1250	1600						
T4	N. S. H. L. V	TM	250	I _n [A]	320	400	500	320	400	630	630	800	630	800	1000	1000	1250	1600		
				20	T	T	T	T	T	T	T	T	T	T	T	T	T	T	T	
				25	T	T	T	T	T	T	T	T	T	T	T	T	T	T	T	T
				32	T	T	T	T	T	T	T	T	T	T	T	T	T	T	T	T
				50	T	T	T	T	T	T	T	T	T	T	T	T	T	T	T	T
				80	T	T	T	T	T	T	T	T	T	T	T	T	T	T	T	T
				100		50	50	50	50	50	T	T	T	T	T	T	T	T	T	T
				125			50	50	50	50	T	T	T	T	T	T	T	T	T	T
				160				50	50	50	T	T	T	T	T	T	T	T	T	T
				200					50	50	50	T	T	T	T	T	T	T	T	T
				250						50	50	T	T	T	T	T	T	T	T	T
				EL	250	100	50	50	50	50	50	T	T	T	T	T	T	T	T	T
				160		50	50	50	50	50	T	T	T	T	T	T	T	T	T	T
				250					50	50	T	T	T	T	T	T	T	T	T	T
	320	320						50	T	T	T	T	T	T	T	T				

* Value for the supply side magnetic only circuit-breaker.

4 Protection coordination

Discrimination tables MCCB - MCCB

MCCB - T5 @ 415V

		Supply s.		T6						S7			
Version				N,S,H,L						S,H,L			
Release				TM,M			EL			EL			
Load s.	N, S, H, L, V	I _v [A]	I _n [A]	630	800	630	800	1000	1250	1600			
				30	30	30	30	30	1000	1000	1250	1600	
T5	TM	400	320	30	30	30	30	30	T	T	T		
		400	400		30		30	30	T	T	T		
		630	500				30	30	T	T	T		
	EL	400	320	30	30	30	30	30	T	T	T		
		400	400	30	30	30	30	30	T	T	T		
		630	630				30	30	T	T	T		

MCCB - T6 @ 415V

		Supply s.		S7		
Version				S,H,L		
Release				EL		
Load s.	N, S, H, L, V	I _v [A]	I _n [A]	1250	1600	
				1000	1250	1600
T6	TM	630	630		40	40
		800	800		40	40
		630	630	40	40	40
	EL	800	800	40	40	40
		800	800	40	40	40
		1000	1000		40	40

4 Protection coordination

Discrimination tables ACB - MCCB

ACB - MCCB @ 415V

		Supply s.		E1		E2				E3				E4		E6			
Version				B	N	B	N	S	L*	N	S	H	V	L*	S	H	V		
Release				EL		EL				EL				EL		EL			
Load s.	N, S, H, L, V	I _v [A]	I _n [A]	800	800	1600	1000	800	1250	2500	1000	800	800	2000	4000	3200	3200	4000	
				1000	1000	2000	1250	1000	1600	3200	1250	1000	1000	2000	2500	4000	4000	5000	4000
T1	B	TM	160	T	T	T	T	T	T	T	T	T	T	T	T	T	T	T	
				T	T	T	T	T	T	T	T	T	T	T	T	T	T	T	
				T	T	T	T	T	T	T	T	T	T	T	T	T	T	T	T
T2	N	TM,EL	160	T	T	T	T	T	T	T	T	T	T	T	T	T	T	T	T
				T	T	T	T	T	T	T	T	T	T	T	T	T	T	T	T
				T	T	T	55	65	T	T	T	T	T	T	T	T	T	T	T
T3	S	TM	250	T	T	T	T	T	T	T	T	T	T	T	T	T	T	T	T
				T	T	T	T	T	T	T	T	T	T	T	T	T	T	T	T
				T	T	T	55	65	T	T	T	75	T	T	T	T	T	T	T
T4	H	TM,EL	250 320	T	T	T	T	T	T	T	T	T	T	T	T	T	T	T	T
				T	T	T	T	T	T	T	T	T	T	T	T	T	T	T	T
				T	T	T	55	65	T	T	T	75	85	100	T	T	100	T	100
T5	L	TM,EL	400 630	T	T	T	T	T	T	T	T	T	T	T	T	T	T	T	T
				T	T	T	55	65	T	T	T	T	T	T	T	T	T	T	
				T	T	T	55	65	100	T	T	75	85	100	T	T	100	T	100
T6	V	TM,EL	630 800 1000	T	T	T	T	T	T	T	T	T	T	T	T	T	T	T	T
				T	T	T	55	65	T	T	T	T	T	T	T	T	T	T	
				T	T	T	55	65	T	T	T	75	85	T	T	T	T	T	
S7	S	EL	1250 1600	T	T	T	T	T	T	T	T	T	T	T	T	T	T	T	T
				T	T	T	55	65	T	T	T	T	T	T	T	T	T	T	
				T	T	T	55	65	T	T	T	75	85	T	T	T	T	T	

Table valid for Emax circuit-breaker only with PR121/P, PR122/P and PR123/P releases
 *Emax L circuit-breakers only with PR122/P and PR123/P releases

TSDCC06015F0201

4 Protection coordination

4.3 Back-up tables

The tables shown give the short-circuit current value (in kA) for which the back-up protection is verified for the chosen circuit-breaker combination, at voltages from 380 up to 415 V. These tables cover all the possible combinations between ABB SACE moulded-case circuit-breakers Isomax and Tmax and those between the above mentioned circuit-breakers and ABB MCBs.

Notes for a correct interpretation of the coordination tables:

Tmax @ 415V ac	
Version	Icu [kA]
B	16
C	25
N	36
S	50
H	70
L (for T2)	85
L (for T4-T5)	120
L (for T6)	100
V	200

Isomax @ 415V ac	
Version	Icu [kA]
N	35*
S	50
H	65
L	100

Emax @ 415V ac	
Version	Icu [kA]
B	42
N	65**
S	75***
H	100
L	130
V	150****

* Versions certified at 36 kA
 ** For Emax E1 version N Icu=50 kA
 *** For Emax E2 version S Icu=85 kA
 **** For Emax E3 version V Icu=130 kA

Keys

For MCCB (Moulded-case circuit-breaker) ACB (Air circuit-breaker) TM = thermomagnetic release - TMD (Tmax) - TMA (Tmax) - T adjustable M adjustable (Isomax) M = magnetic only release - MF (Tmax) - MA (Tmax) EL = electronic release - PR121/P - PR122/P - PR123/P (Emax) - PR211/P - PR212/P (Isomax) - PR221DS - PR222DS (Tmax)	For MCB (Miniature circuit-breaker): B = characteristic trip (I3=3...5In) C = characteristic trip (I3=5...10In) D = characteristic trip (I3=10...20In) K = characteristic trip (I3=8...14In) Z = characteristic trip (I3=2...3In)
---	--

4 Protection coordination

Example:

From the coordination table on page 217 the following conclusion is derived: the circuit-breakers type T5H and T1N are coordinated in back-up protection up to a value of 65 kA (higher than the short-circuit current measured at the installation point), although the maximum breaking capacity of T1N, at 415 V, is 36 kA.

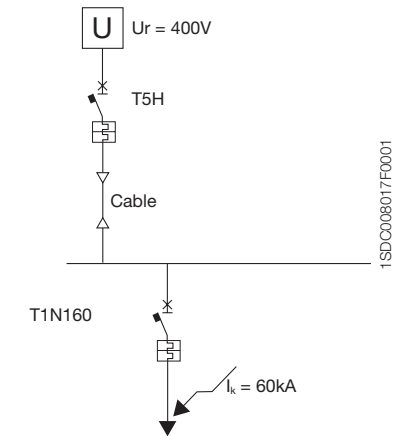

MCB - MCB @ 240V

Load s.	Char.	Icu [kA]	In [A]	Supply s.	S 200L	S 200	S 200M	S 200P	S 280	S 290	S 500
				C	B-C	B-C	B-C	B-C	C	B-C	
				10	20	25	40	40	20	25	100
				6.40	0.5..63	0.5..63	0.5..25	32..63	80, 100	80..125	6..63
S931 N	C	4.5	2..40	10	20	25	40	25	15	15	100
S941 N	B,C	6	2..40	10	20	25	40	25	15	15	100
S951 N	B,C	10	2..40	10	20	25	40	25	15	15	100
S971 N	B,C	10	2..40	10	20	25	40	25	15	15	100
S200L	C	10	6..40		20	25	40	25	15	15	100
S200	B,C,K,Z	20	0.5..63				25	40	25		100
S200M	B,C,D	25	0.5..63					40			100
S200P	B, C,	40	0.5..25								100
	D, K, Z	25	32..63								100
S280	B,C	20	80, 100								
S290	C,D	25	80..125								
S500	B,C,D		6..63								

4 Protection coordination

MCB - MCB @ 415V

Load s.	Char.	In [A]	Supply s.	S200L	S200	S200M	S200P		S280	S290	S500
			Version	C	B-C	B-C	B-C	B-C	B-C	C	B-C
			Icu [kA]	6	10	15	25	15	6	15	50
				6..40	0.5..63	0.5..63	0.5..25	32..63	80, 100	80..125	6..63
S200L	C	6	6..40		10	15	25	15		15	50
S200	B,C,K,Z	10	0.5..63			15	25	15		15	50
S200M	B,C,D	15	0.5..63				25				50
S200P	B, C,	25	0.5..25								50
	D, K, Z	15	32..63								
S280	B,C	6	80, 100								
S290	C,D	15	80..125								
S500	B,C,D	50	6..63								

MCCB - MCB @ 415V

Load s.	Char.	In [A]	Supply s.	T1	T1	T1	T2	T3	T4	T2	T3	T4	T2	T4	T4										
			Version	B	C	N			S			H	L	L	V										
			Icu [kA]	16	25	36			50			70	85	120	200										
S200L	C	6..10	6	16	25	30	36	36	36	35	40	40	40	40	40										
		13..40														16	16	16	16	16	16	16			
S200	B, C, K, Z	0.5..10	10	16	25	30	36	36	36	35	40	40	40	40	40										
		13..63														16	16	16	16	16	16	16			
S200M	B, C, D	0.5..10	15	16	25	30	36	36	36	50	40	40	70	85	40										
		13..63														25	25	25	25	25	25	25			
S200P	B, C, D, K, Z	0.5..10	25	16	25	30	36	36	36	50	40	40	70	85	40										
		13..25														30	30	30	50	30	40	60	40	60	40
		32..63																							
S280	B, C	80, 100	6	16	16	16	36	16	30	36	16	30	36	30	30										
S290	C, D	80,125	15	16	25	30	36	30	30	50	30	30	70	85	30										
S500	B, C, D	6..63	50										70	70	85										

1SDCC008035F0201

4 Protection coordination

MCCB - MCCB @ 415V

Load side	Version	Supply s.	T1	T1	T2	T3	T4	T5	T6	T2	T3	T4	T5	T6	S7	T2	T4	T5	T6	S7	T2	T4	T5	T6	S7	T4	T5		
		Version	C	N						S				H			L	L	L	V									
		Icu [kA]	25	36						50				70			65	85	120	100	200								
T1	B	16	25	36	36	36	30	30	30	50	50	36	36	36	70	40	40	40	85	50	50	50	85	85	70	50	85	85	
T1	C	25		36	36	36	36	36	36																				
T1	N	36								50	50	50	50	50	50	70	65	65	65	50	85	100	100	70	50	200	120		
T2											50	50	50	50	50	50	70	65	65	65	50	85	100	100	85	85	200	120	
T3												50	50	50	50	50	70	65	65	65	50	85	100	100	100	50	200	120	
T4													50	50	50	50	70	65	65	65	50	85	100	100	65	65	200	120	
T5														50	50	50	70	65	65	65	50	85	100	85	65	65	120		
T6																50	40									70	50		
T2	S	50														70	70	70	65	85	100	100	85	85	200	130			
T3																	70	70	70				100	100	100		200	150	
T4																	70	70	70	65				100	100	85	85	200	150
T5																		70	70	65					100	85	85	150	
T6																			70							85	85		
T2			H	70																		85	120	120	85	85	200	150	
T4																							120	120	100	100	200	150	
T5																								120	100	100		150	
T6																									100	85			
T2	L	85																				120	120			200	180		
T4																											200	200	
T5																												200	

1SDCC008036F0201

4 Protection coordination

4.4 Coordination tables between circuit-breakers and switch disconnectors

The tables shown give the values of the short-circuit current (in kA) for which back-up protection is verified by the pre-selected combination of circuit-breaker and switch disconnector, for voltages between 380 and 415 V. The tables cover the possible combinations of moulded-case circuit-breakers in the ABB SACE Isomax and Tmax series, with the switch disconnectors detailed above.

4 Protection coordination

Notes for the correct reading of the coordination tables:

Tmax @ 415V ac	
Version	Icu [kA]
B	16
C	25
N	36
S	50
H	70
L (for T2)	85
L (for T4-T5)	120
L (for T6)	100
V	200

Isomax @ 415V ac	
Version	Icu [kA]
S	50
H	65
L	100

415 V	SWITCH DISCONNECTOR												
	T1D 160	T3D 250	T4D 320	T5D 400	T5D 630	T6D 630	T6D 800	S7D 1000	S7D 1250	S7D 1600	S8D 2000	S8D 2500	S8D 3200
T1B	← 16 →												
T1C	← 25 →												
T1N	← 36 →												
T2N	← 36 →												
T2S	← 50 →												
T2H	← 70 →												
T2L	← 85 →												
T3N	← 36 →												
T3S	← 50 →												
T4N	← 36* →	← 36 →											
T4S	← 50* →	← 50 →											
T4H	← 70* →	← 70 →											
T4L	← 120* →	← 120 →											
T4V	← 200* →	← 200 →											
T5N	← 36 →							← 36 →					
T5S	← 50 →							← 50 →					
T5H	← 70 →							← 70 →					
T5L	← 120 →							← 120 →					
T5V	← 200 →							← 200 →					
T6N	← 36 →					← 36 →							
T6S	← 50 →					← 50 →							
T6H	← 70 →					← 70 →							
T6L	← 100 →					← 100 →							
S7S	← 50 →								← 50 →				
S7H	← 65 →								← 65 →				
S7L	← 100 →								← 100 →				
S8H	← 85 →										← 85 →		
S8V	← 120 →										← 120 →		

* for T4 250 or T4 320 only with I1 setting at 250 A.

1SDC008037F0201

4 Protection coordination

Example:

From the coordination table on page 218-219 it can be seen that circuit-breaker T2S160 is able to protect the switch disconnector T1D160 up to a short-circuit current of 50 kA (higher than the short-circuit current at the installation point). Overload protection is also verified, as the rated current of the breaker is not higher than the size of the disconnector.

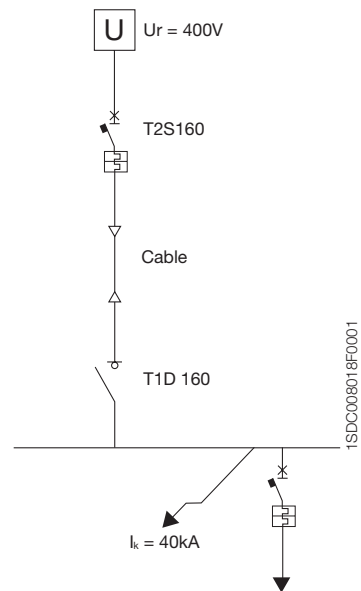

4 Protection coordination

Example:

For the correct selection of the components, the disconnector must be protected from overloads by a device with a rated current not greater than the size of the disconnector, while in short-circuit conditions it must be verified that:

$$I_{cw} \geq I_k$$

$$I_{cm} \geq I_p$$

Therefore, with regard to the electrical parameters of the single devices, Emax E2N1250/MS disconnector is selected, and a E2N1250 breaker. That is:

$$I_{cw}(E2N /MS) = 55 \text{ kA} > 45 \text{ kA}$$

$$I_{cm}(E2N /MS) = 143 \text{ kA} > 100 \text{ kA}.$$

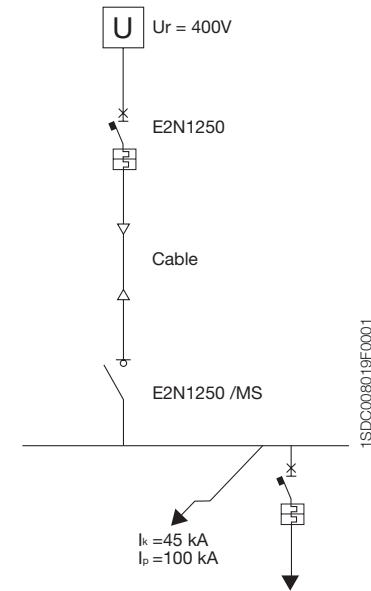

5 Special applications

5.1 Direct current networks

Main applications of direct current:

- Emergency supply or auxiliary services:
the use of direct current is due to the need to employ a back-up energy source which allows the supply of essential services such as protection services, emergency lighting, alarm systems, hospital and industrial services, data-processing centres etc., using accumulator batteries, for example.
- Electrical traction:
the advantages offered by the use of dc motors in terms of regulation and of single supply lines lead to the widespread use of direct current for railways, underground railways, trams, lifts and public transport in general.
- Particular industrial installations:
there are some electrolytic process plants and applications which have a particular need for the use of electrical machinery.

Typical uses of circuit-breakers include the protection of cables, devices and the operation of motors.

Considerations for the interruption of direct current

Direct current presents larger problems than alternating current does in terms of the phenomena associated with the interruption of high currents. Alternating currents have a natural passage to zero of the current every half-cycle, which corresponds to a spontaneous extinguishing of the arc which is formed when the circuit is opened.

This characteristic does not exist in direct currents, and furthermore, in order to extinguish the arc, it is necessary that the current lowers to zero.

The extinguishing time of a direct current, all other conditions being equal, is proportional to the time constant of the circuit $T = L/R$.

It is necessary that the interruption takes place gradually, without a sudden switching off of the current which could cause large over-voltages. This can be carried out by extending and cooling the arc so as to insert an ever higher resistance into the circuit.

The energetic characteristics which develop in the circuit depend upon the voltage level of the plant and result in the installation of breakers according to connection diagrams in which the poles of the breaker are positioned in series to increase their performance under short-circuit conditions. The breaking capacity of the switching device becomes higher as the number of contacts which open the circuit increases and, therefore, when the arc voltage applied is larger.

This also means that when the supply voltage of the installation rises, so must the number of current switches and therefore the poles in series.

5 Special applications

Calculation of the short-circuit current of an accumulator battery

The short-circuit current at the terminals of an accumulator battery may be supplied by the battery manufacturer, or may be calculated using the following formula:

$$I_k = \frac{U_{Max}}{R_i}$$

where:

- U_{Max} is the maximum flashover voltage (no-load voltage);
- R_i is the internal resistance of the elements forming the battery.

The internal resistance is usually supplied by the manufacturer, but may be calculated from the discharge characteristics obtained through a test such as detailed by IEC 60896 – 1 or IEC 60896 – 2.

For example, a battery of 12.84 V and internal resistance of 0.005 Ω gives a short-circuit current at the terminals of 2568 A.

Under short-circuit conditions the current increases very rapidly in the initial moments, reaches a peak and then decreases with the discharge voltage of the battery. Naturally, this high value of the fault current causes intense heating inside the battery, due to the internal resistance, and may lead to explosion. Therefore it is very important to prevent and / or minimize short-circuit currents in direct currents systems supplied by accumulator batteries.

Criteria for the selection of circuit-breakers

For the correct selection of a circuit-breaker for the protection of a direct current network, the following factors must be considered:

1. the load current, according to which the size of the breaker and the setting for the thermo-magnetic over-current release can be determined;
2. the rated plant voltage, according to which the number of poles to be connected in series is determined, thus the breaking capacity of the device can also be increased;
3. the prospective short-circuit current at the point of installation of the breaker influencing the choice of the breaker;
4. the type of network, more specifically the type of earthing connection.

Note: in case of using of four pole circuit-breakers, the neutral must be at 100%

Direct current network types

Direct current networks may be carried out:

- with both polarities insulated from earth;
- with one polarity connected to earth;
- with median point connected to earth.

5 Special applications

Network with both polarities insulated from earth

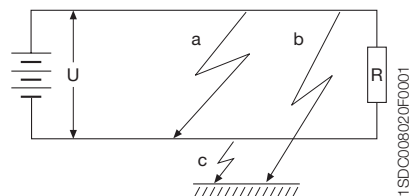

- Fault a: the fault, without negligible impedance, between the two polarities sets up a short-circuit current to which both polarities contribute to the full voltage, according to which the breaking capacity of the breaker must be selected.
- Fault b: the fault between the polarity and earth has no consequences from the point of view of the function of the installation.
- Fault c: again, this fault between the polarity and earth has no consequences from the point of view of the function of the installation.

In insulated networks it is necessary to install a device capable of signalling the presence of the first earth fault in order to eliminate it. In the worst conditions, when a second earth fault is verified, the breaker may have to interrupt the short-circuit current with the full voltage applied to a single polarity and therefore with a breaking capacity which may not be sufficient.

In networks with both polarities insulated from earth it is appropriate to divide the number of poles of the breaker necessary for interruption on each polarity (positive and negative) in such a way as to obtain separation of the circuit.

The diagrams to be used are as follows:

Diagram A

Three-pole breaker with one pole per polarity

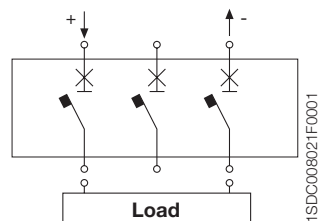

5 Special applications

Diagram B

Three-pole breaker with two poles in series for one polarity and one pole for the other polarity ⁽¹⁾

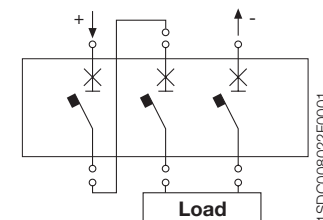

Diagram D

Four-pole breaker with two poles in parallel per polarity

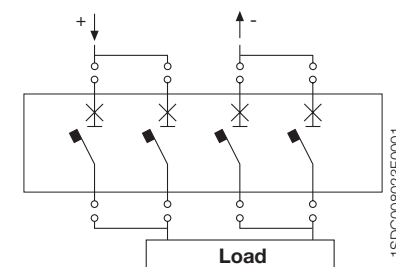
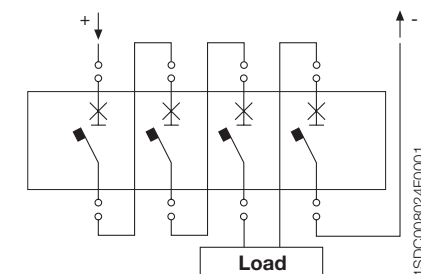

Diagram G

Four-pole breaker with three poles in series on one polarity and one pole on the remaining polarity ⁽¹⁾



⁽¹⁾ It is not advisable to divide the poles of the breaker unequally as, in this type of network, a second earth fault may lead to the single pole working under fault conditions at full voltage. In these circumstances, it is essential to install a device capable of signalling the earth fault or the loss of insulation of one polarity.

5 Special applications

Diagram H

Four-pole breaker with two poles in series per polarity

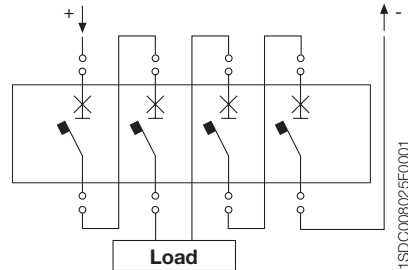

Network with one polarity connected to earth

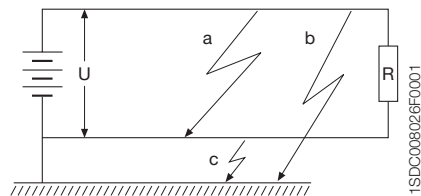

- Fault a: the fault between the two polarities sets up a short-circuit current to which both polarities contribute to the full voltage U , according to which the breaking capacity of the breaker is selected.
 - Fault b: the fault on the polarity not connected to earth sets up a current which involves the over-current protection according to the resistance of the ground.
 - Fault c: the fault between the polarity connected to earth and earth has no consequences from the point of view of the function of the installation.
- In a network with one polarity connected to earth, all the poles of the breaker necessary for protection must be connected in series on the non-earthed polarity. If isolation is required, it is necessary to provide another breaker pole on the earthed polarity.

5 Special applications

Diagrams to be used with circuit isolation are as follows:

Diagram A

Three-pole breaker with one pole per polarity

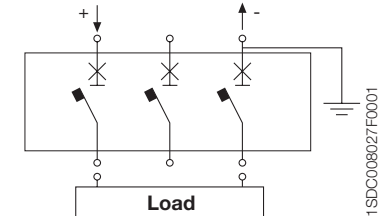

Diagram B

Three-pole breaker with two poles in series on the polarity not connected to earth, and one pole on the remaining polarity

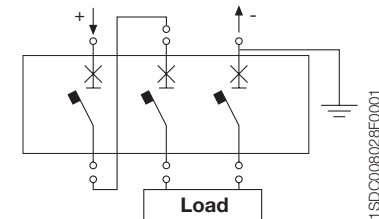
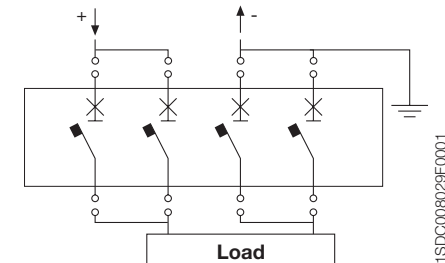

Diagram D

Four-pole breaker with two poles in parallel per polarity



5 Special applications

Diagram G

Four-pole breaker with three poles in series on the polarity not connected to earth, and one pole on the remaining polarity

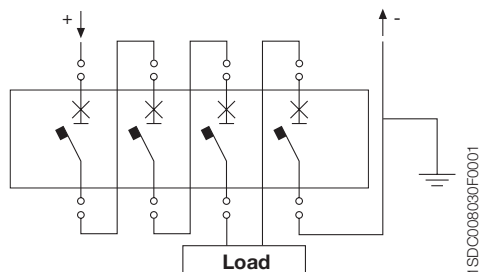

Diagrams to be used without circuit isolation are as follows:

Diagram C

Three-pole breaker with three poles in series

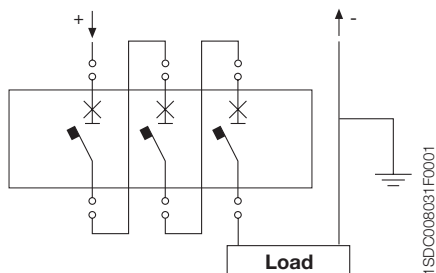
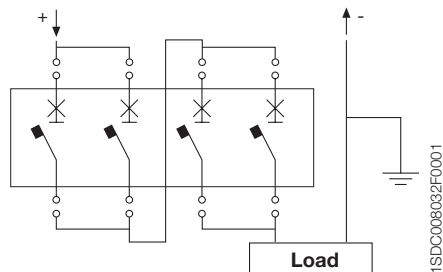

Diagram E

Four-pole breaker with series of two poles in parallel



5 Special applications

Diagram F

Four-pole breaker with four poles in series on the polarity not connected to earth

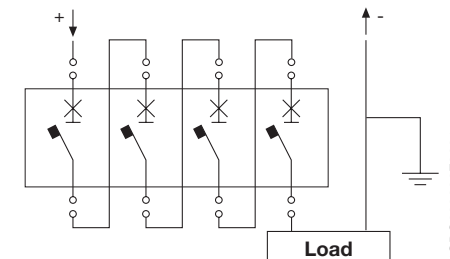

Network with the median point connected to earth

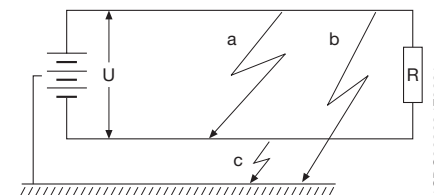

- Fault a: the fault between the two polarities sets up a short-circuit current to which both polarities contribute to the full voltage U , according to which the breaking capacity of the breaker is selected.
- Fault b: the fault between the polarity and earth sets up a short-circuit current less than that of a fault between the two polarities, as it is supplied by a voltage equal to $0.5 U$.
- Fault c: the fault in this case is analogous to the previous case, but concerns the negative polarity.

With network with the median point connected to earth the breaker must be inserted on both polarities.

Diagrams to be used are as follows:

Diagram A

Three-pole breaker with one pole per polarity

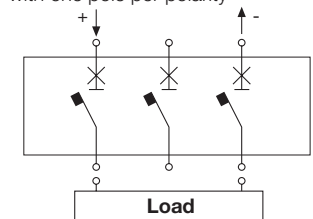

5 Special applications

Diagram D

Four-pole breaker with two poles in parallel per polarity

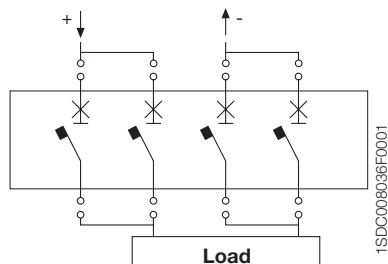
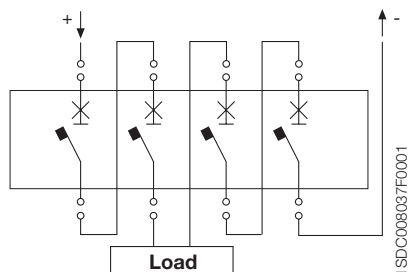

Diagram H

Four-pole breaker with two poles in series per polarity



Use of switching devices in direct current

Parallel connection of breaker poles

According to the number of poles connected in parallel, the coefficients detailed in the following table must be applied:

Table 1: Correction factor for poles connected in parallel

number of poles in parallel	2	3	4 (neutral 100%)
reduction factor of dc carrying capacity	0.9	0.8	0.7
breaker current carrying capacity	1.8xIn	2.4xIn	2.8xIn

The connections which are external from the breaker terminals must be carried out by the user in such a way as to ensure that the connection is perfectly balanced.

5 Special applications

Example:

Using a Tmax T6N800 In800 circuit-breaker with three poles in parallel, a coefficient equal to 0.8 must be applied, therefore the maximum carrying current will be $0.8 \cdot 3 \cdot 800 = 1920$ A.

Behaviour of thermal releases

As the functioning of these releases is based on thermal phenomena arising from the flowing of current, they can therefore be used with direct current, their trip characteristics remaining unaltered.

Behaviour of magnetic releases

The values of the trip thresholds of ac magnetic releases, used for direct current, must be multiplied by the following coefficient (k_m), according to the breaker and the connection diagram:

Table 2: k_m coefficient

Circuit-breaker	diagram A	diagram B	diagram C	diagram D	diagram E	diagram F	diagram G	diagram H
T1	1.3	1	1	-	-	-	-	-
T2	1.3	1.15	1.15	-	-	-	-	-
T3	1.3	1.15	1.15	-	-	-	-	-
T4	1.3	1.15	1.15	1	1	1	-	-
T5	1.1	1	1	0.9	0.9	0.9	-	-
T6	1.1	1	1	0.9	0.9	0.9	-	-

Example

Data:

- Direct current network connected to earth;
- Rated voltage $U_r = 250$ V;
- Short-circuit current $I_k = 32$ kA
- Load current $I_b = 230$ A

Using Table 3, it is possible to select the Tmax T3N250 In = 250 A three pole breaker, using the connection shown in diagram B (two poles in series for the polarity not connected to earth and one poles in series for the polarity connected to earth).

From Table 2 corresponding to diagram B, and with breaker Tmax T3, it results $k_m=1.15$; therefore the nominal magnetic trip will occur at 2875 A (taking into account the tolerance, the trip will occur between 2300 A and 3450 A).

5 Special applications

The following table summarizes the breaking capacity of the various circuit-breakers available for direct current. The number of poles to be connected in series to guarantee the breaking capacity is given in brackets.

Table 3: Breaking capacity in direct current according to the voltage

Circuit-breaker	Rated current [A]	Breaking capacity [kA]			
		≤ 125 [V] ¹	250 [V]	500 [V]	750 [V]
T1B160	16 + 160	16 (1P)	20 (3P) - 16 (2P)	16 (3P)	
T1C160	25 + 160	25 (1P)	30 (3P) - 25 (2P)	25 (3P)	
T1N160	32 + 160	36 (1P)	40 (3P) - 36 (2P)	36 (3P)	
T2N160	1.6 + 160	36 (1P)	40 (3P) - 36 (2P)	36 (3P)	
T2S160	1.6 + 160	50 (1P)	55 (3P) - 50 (2P)	50 (3P)	
T2H160	1.6 + 160	70 (1P)	85 (3P) - 70 (2P)	70 (3P)	
T2L160	1.6 + 160	85 (1P)	100 (3P) - 85 (2P)	85 (3P)	
T3N250	63 + 250	36 (1P)	40 (3P) - 36 (2P)	36 (3P)	
T3S250	63 + 250	50 (1P)	55 (3P) - 50 (2P)	50 (3P)	
T4N250/320	20 + 250	36 (1P)	36 (2P)	25 (2P)	16 (3P)
T4S250/320	20 + 250	50 (1P)	50 (2P)	36 (2P)	25 (3P)
T4H250/320	20 + 250	70 (1P)	70 (2P)	50 (2P)	36 (3P)
T4L250/320	20 + 250	100 (1P)	100 (2P)	70 (2P)	50 (3P)
T4V250/320	20 + 250	100 (1P)	100 (2P)	100 (2P)	70 (3P)
T5N400/630	320 + 500	36 (1P)	36 (2P)	25 (2P)	16 (3P)
T5S400/630	320 + 500	50 (1P)	50 (2P)	36 (2P)	25 (3P)
T5H400/630	320 + 500	70 (1P)	70 (2P)	50 (2P)	36 (3P)
T5L400/630	320 + 500	100 (1P)	100 (2P)	70 (2P)	50 (3P)
T5V400/630	320 + 500	100 (1P)	100 (2P)	100 (2P)	70 (3P)
T6N630/800	630-800	36 (1P)	36 (2P)	20 (2P)	16 (3P)
T6S630/800	630-800	50 (1P)	50 (2P)	35 (2P)	20 (3P)
T6H630/800	630-800	70 (1P)	70 (2P)	50 (2P)	36 (3P)
T6L630/800	630-800	100 (1P)	100 (2P)	65 (2P)	50 (3P)

¹ Minimum allowed voltage 24 Vdc.

5 Special applications

5.2 Networks at particular frequencies: 400 Hz and 16 2/3 Hz

Standard production breakers can be used with alternating currents with frequencies other than 50/60 Hz (the frequencies to which the rated performance of the device refer, with alternating current) as appropriate derating coefficients are applied.

5.2.1 400 Hz networks

At high frequencies, performance is reclassified to take into account phenomena such as:

- the increase in the skin effect and the increase in the inductive reactance directly proportional to the frequency causes overheating of the conductors or the copper components in the breaker which normally carry current;
- the lengthening of the hysteresis loop and the reduction of the magnetic saturation value with the consequent variation of the forces associated with the magnetic field at a given current value.

In general these phenomena have consequences on the behaviour of both thermo-magnetic releases and the current interrupting parts of the circuit-breaker.

The following tables refer to circuit-breakers with thermomagnetic releases, with a breaking capacity lower than 36 kA. This value is usually more than sufficient for the protection of installations where such a frequency is used, normally characterized by rather low short-circuit currents.

As can be seen from the data shown, the tripping threshold of the thermal element (I_n) decreases as the frequency increases because of the reduced conductivity of the materials and the increase of the associated thermal phenomena; in general, the derating of this performance is generally equal to 10%. Vice versa, the magnetic threshold (I_2) increases with the increase in frequency; for this reason it is recommended practice to use a 5- I_n version.

5 Special applications

Table 1: Tmax performance T1 16-63 A TMD

	I1 (400Hz)			I3			
	MIN	MED	MAX	I3 (50Hz)	K_m	I3 (400Hz)	
T1B 160							
T1C 160	In16	10	12	14	500	2	1000
T1N 160	In20	12	15	18	500	2	1000
	In25	16	19	22	500	2	1000
	In32	20	24.5	29	500	2	1000
	In40	25	30.5	36	500	2	1000
	In50	31	38	45	500	2	1000
	In63	39	48	57	630	2	1260

K_m = Multiplier factor of I3 due to the induced magnetic fields

5 Special applications

Table 2: Tmax performance T1 80 A TMD

	I1 (400Hz)			I3			
	MIN	MED	MAX	I3 (50Hz)	K_m	I3 (400Hz)	
T1B 160							
T1C 160	In80	50	61	72	800	2	1600
T1N 160							

K_m = Multiplier factor of I3 due to the induced magnetic fields

Trip curves
thermomagnetic release

T1 B/C/N 160

In 16 to 63 A
TMD

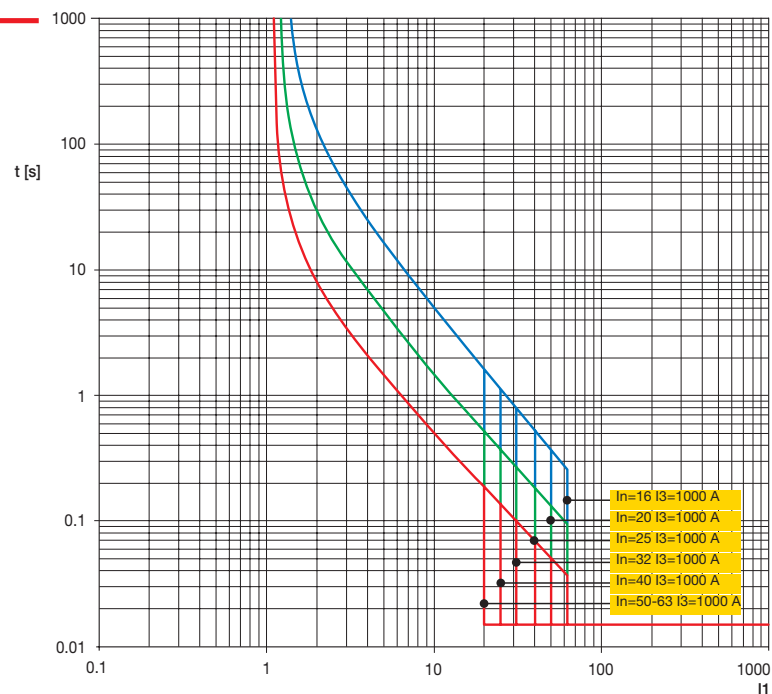

Trip curves
thermomagnetic release

T1 B/C/N 160

In 80 A
TMD

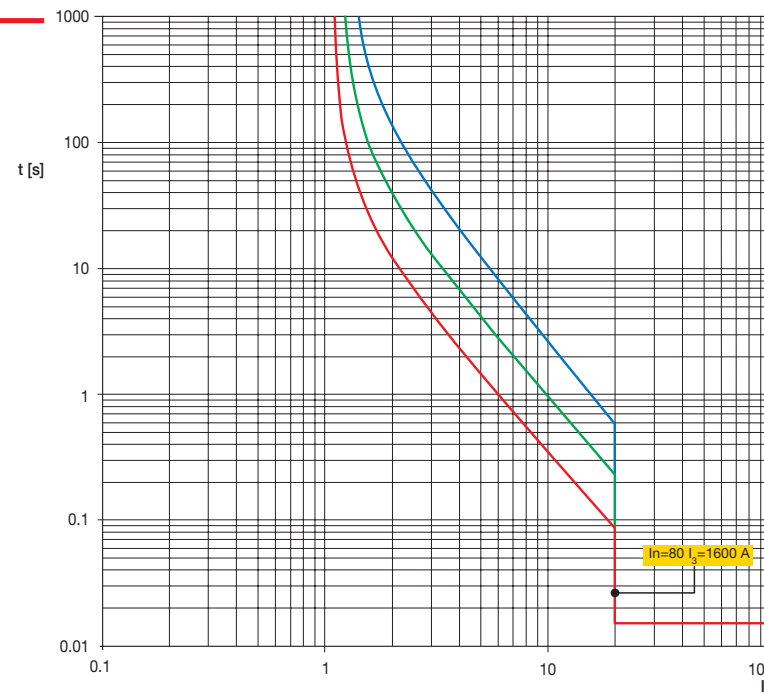

5 Special applications

Table 3: Tmax performance T2 1.6-80 A TMD

T2N 160	I1 (400Hz)			I3		
	MIN	MED	MAX	I3 (50Hz)	K _m	I3 (400Hz)
In1.6	1	1.2	1.4	16	1.7	27.2
In2	1.2	1.5	1.8	20	1.7	34
In2.5	1.5	1.9	2.2	25	1.7	42.5
In3.2	2	2.5	2.9	32	1.7	54.4
In4	2.5	3	3.6	40	1.7	68
In5	3	3.8	4.5	50	1.7	85
In6.3	4	4.8	5.7	63	1.7	107.1
In8	5	6.1	7.2	80	1.7	136
In10	6.3	7.6	9	100	1.7	170
In12.5	7.8	9.5	11.2	125	1.7	212.5
In16	10	12	14	500	1.7	850
In20	12	15	18	500	1.7	850
In25	16	19	22	500	1.7	850
In32	20	24.5	29	500	1.7	850
In40	25	30.5	36	500	1.7	850
In50	31	38	45	500	1.7	850
In63	39	48	57	630	1.7	1071
In80	50	61	72	800	1.7	1360

K_m = Multiplier factor of I3 due to the induced magnetic fields

Trip curves
thermomagnetic release

T2 N 160

In 1.6 to 80 A
TMD

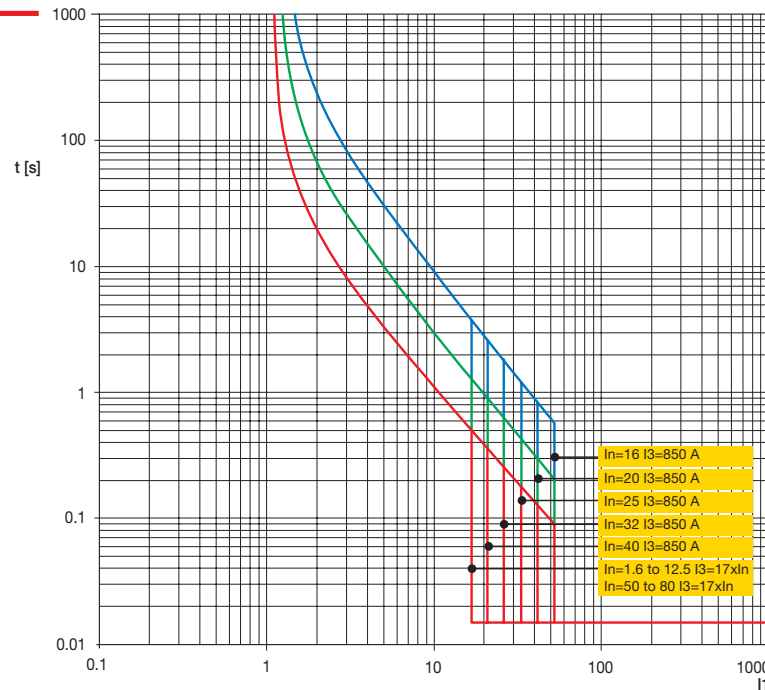

5 Special applications

Table 4: Tmax performance T3 63-250 A TMG

T3N 250	I1 (400Hz)			I3 (Low magnetic setting)		
	MIN	MED	MAX	I3 (50Hz)	K _m	I3 (400Hz)
In63	39	48	57	400	1.7	680
In80	50	61	72	400	1.7	680
In100	63	76.5	90	400	1.7	680
In125	79	96	113	400	1.7	680
In160	100	122	144	480	1.7	816
In200	126	153	180	600	1.7	1020
In250	157	191	225	750	1.7	1275

K_m = Multiplier factor of I3 due to the induced magnetic fields

Trip curves
thermomagnetic release

T3N 250

In 63 to 250 A
TMG

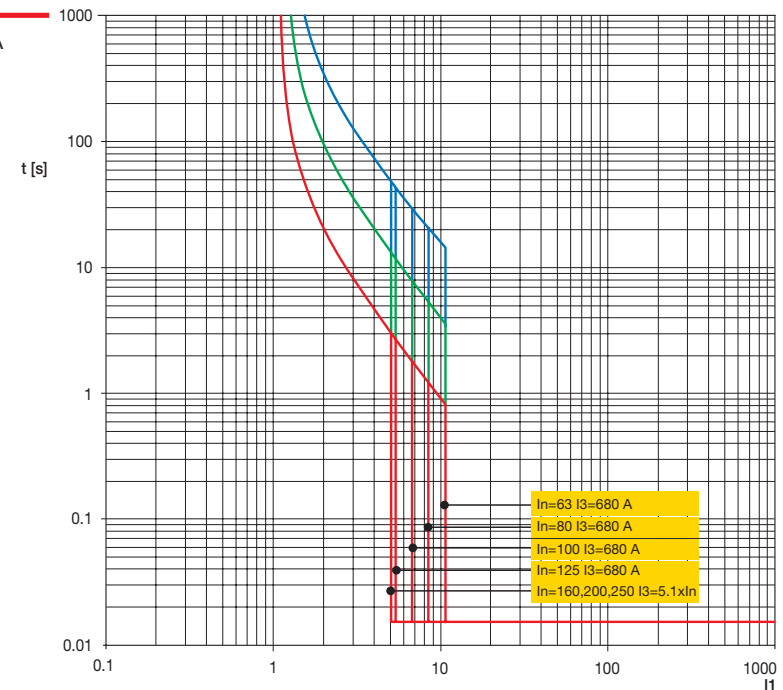

5 Special applications

Table 5: Tmax performance T3 63-125 A TMD

T3N 250	I1 (400Hz)			I3		
	MIN	MED	MAX	I3 (50Hz)	K_m	I3 (400Hz)
In63	39	48	57	630	1.7	1071
In80	50	61	72	800	1.7	1360
In100	63	76.5	90	1000	1.7	1700
In125	79	96	113	1250	1.7	2125

K_m = Multiplier factor of I3 due to the induced magnetic fields

5 Special applications

Table 6: Tmax performance T4 20-50 A TMD

T4N 250	I1 (400Hz)			I3		
	MIN	MED	MAX	I3 (50Hz)	K_m	I3 (400Hz)
In20	12	15	18	320	1.7	544
In32	20	24.5	29	320	1.7	544
In50	31	38	45	500	1.7	850

K_m = Multiplier factor of I3 due to the induced magnetic fields

Trip curves
thermomagnetic release

T3N 250

In 63 to 125 A
TMD

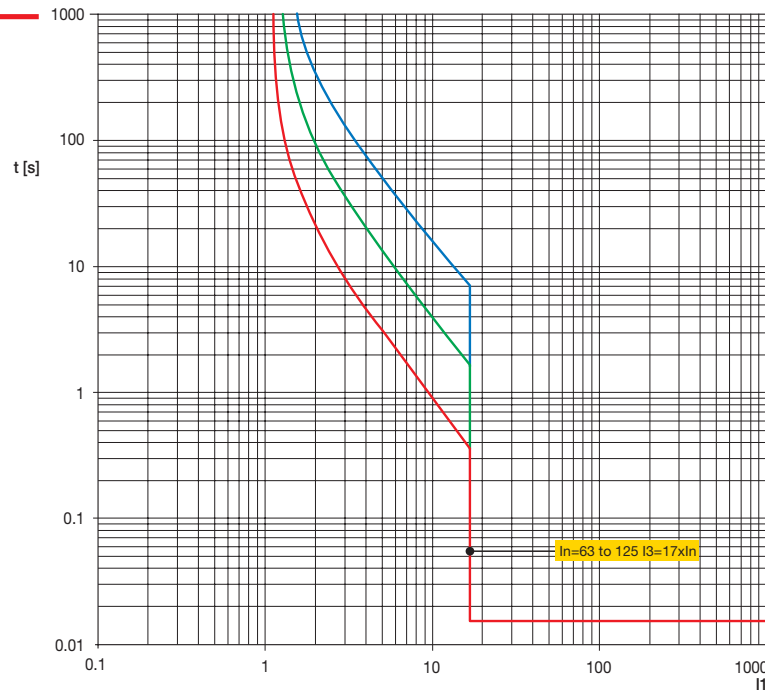

Trip curves
thermomagnetic release

T4 N 250

In 20 to 50 A
TMD

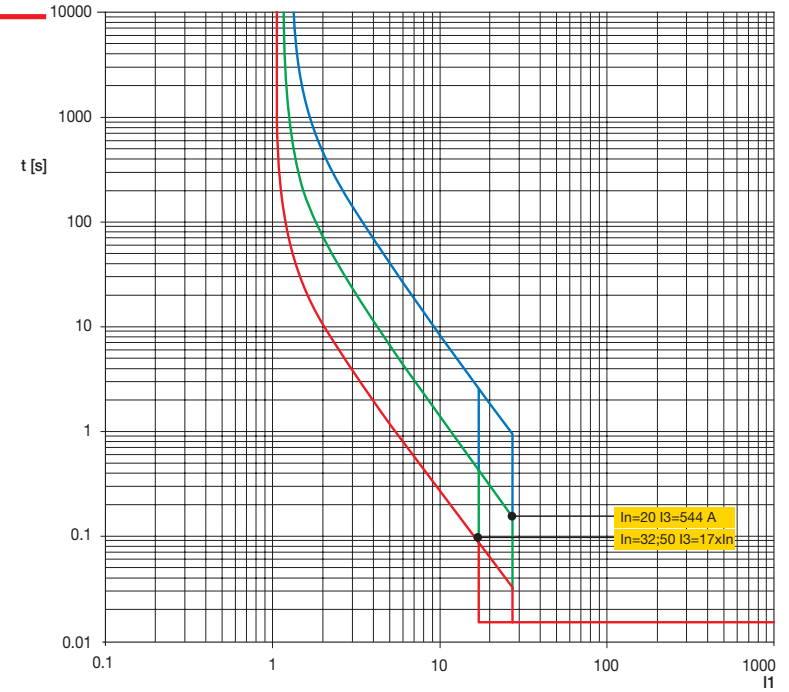

5 Special applications

Table 7: Tmax performance T4N 80-250 A TMA

T4N 250/320	I1 (400Hz)			I3 setting (MIN=5xIn)		
	MIN	MED	MAX	I3 @ 5xIn (50Hz)	K _m	I3 @ 5xIn (400Hz)
In80	50	61	72	400	1.7	680
In100	63	76.5	90	500	1.7	850
In125	79	96	113	625	1.7	1060
In160	100	122	144	800	1.7	1360
In200	126	153	180	1000	1.7	1700
In250	157	191	225	1250	1.7	2125

K_m = Multiplier factor of I3 due to the induced magnetic fields

Trip curves
thermomagnetic release

T4N 250/320

In 80 to 250 A
TMA

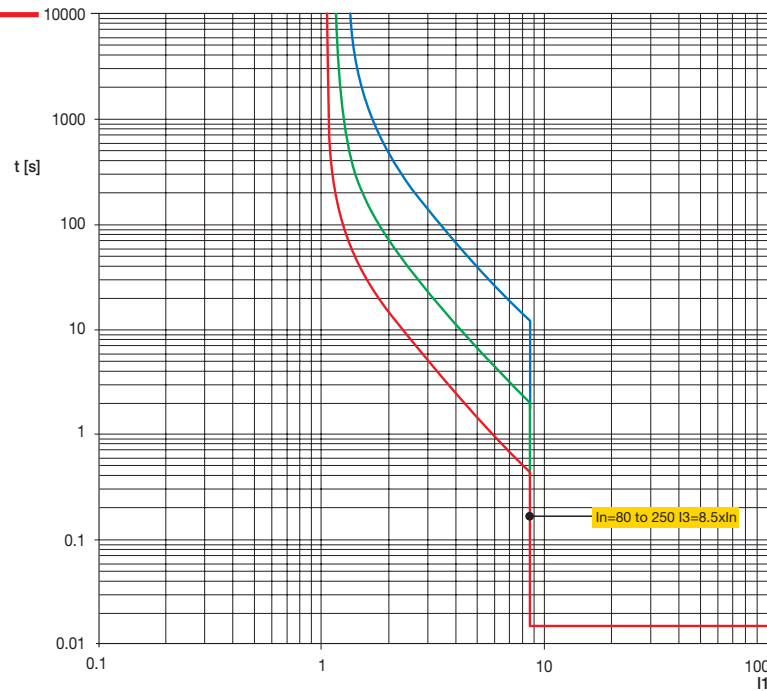

5 Special applications

Table 8: Tmax performance T5N 320-500 A TMA

T5N400/630	I1 (400Hz)			I3 setting (MIN=5xIn)		
	MIN	MED	MAX	I3 @ 5xIn(50Hz)	K _m	I3 @ 5xIn (400)Hz
In320	201	244	288	1600	1.5	2400
In400	252	306	360	2000	1.5	3000
In500	315	382	450	2500	1.5	3750

K_m = Multiplier factor of I3 due to the induced magnetic fields

Trip curves
thermomagnetic release

T5 N 400/630

In 320 to 500 A
TMA

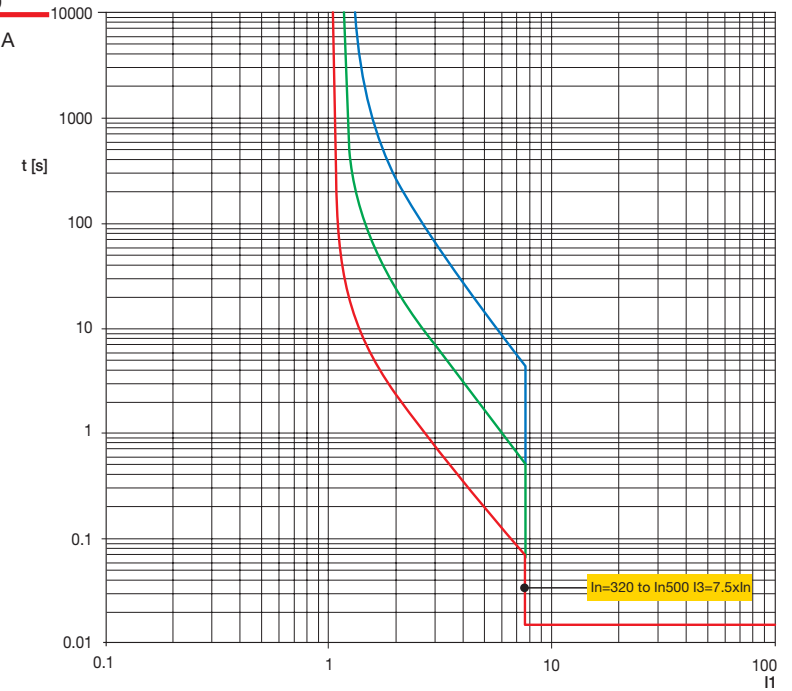

5 Special applications

Table 9: Tmax performance T5N 320-500 A TMG

T5N400/630	I1 (400Hz)			I3 setting (2.5...5xIn)		
	MIN	MED	MAX	I3 @ 2.5..5xIn (50Hz)	K _m	I3 @ 2.5..5xIn (400Hz)
In320	201	244	288	800...1600	1.5	1200...2400
In400	252	306	360	1000...2000	1.5	1500...3000
In500	315	382	450	1250...2500	1.5	1875...3750

K_m = Multiplier factor of I3 due to the induced magnetic fields

Trip curves
thermomagnetic release

T5N 400/630

In 320 to 500 A
TMG

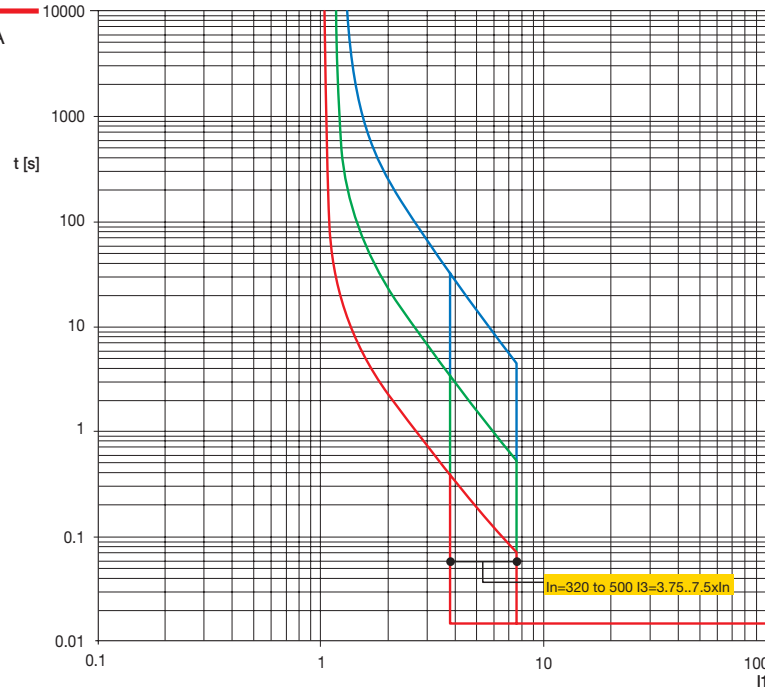

5 Special applications

Table 10: Tmax performance T6N 630 A TMA

T6N630	In630	I1 (400Hz)			I3 = 5..10In (set I3=5In)		
		MIN	MED	MAX	I3 (50Hz)	K _m	I3 (400Hz)
		397	482	567	3150	1.5	4725

K_m = Multiplier factor of I3 due to the induced magnetic fields

Trip curves
thermomagnetic release

T6N 630

In 630 A
TMA

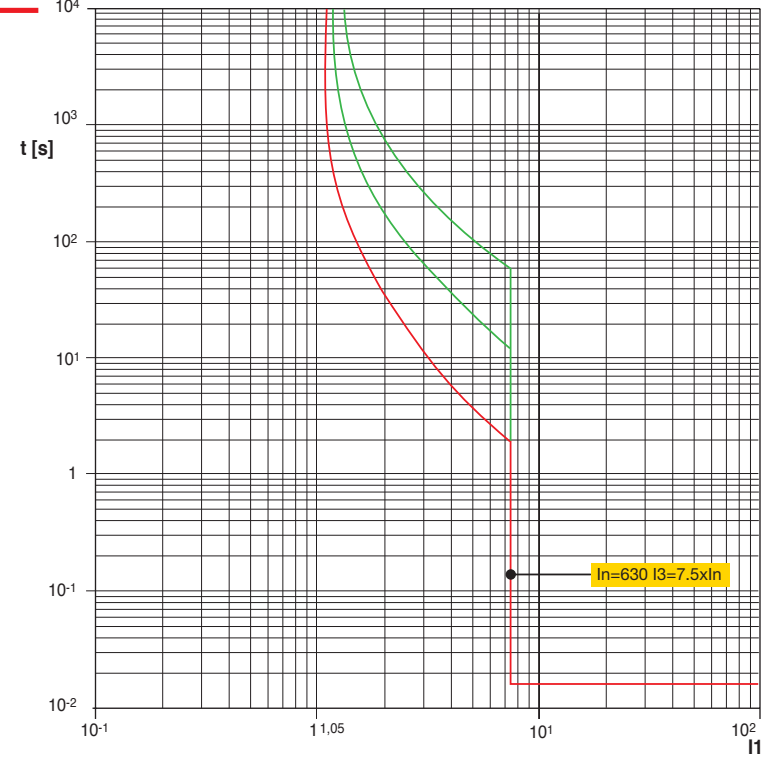

5 Special applications

Table 11: Tmax performance T6N 800 A TMA

T6N 800	In800	I1 (400Hz)			I3 = 5-10In (set I3=5In)		
		MIN	MED	MAX	I3 (50Hz)	K_m	I3 (400Hz)
		504	602	720	4000	1.5	6000

K_m = Multiplier factor of I3 due to the induced magnetic fields

Trip curves
thermomagnetic release

T6N 800

In 800 A
TMA

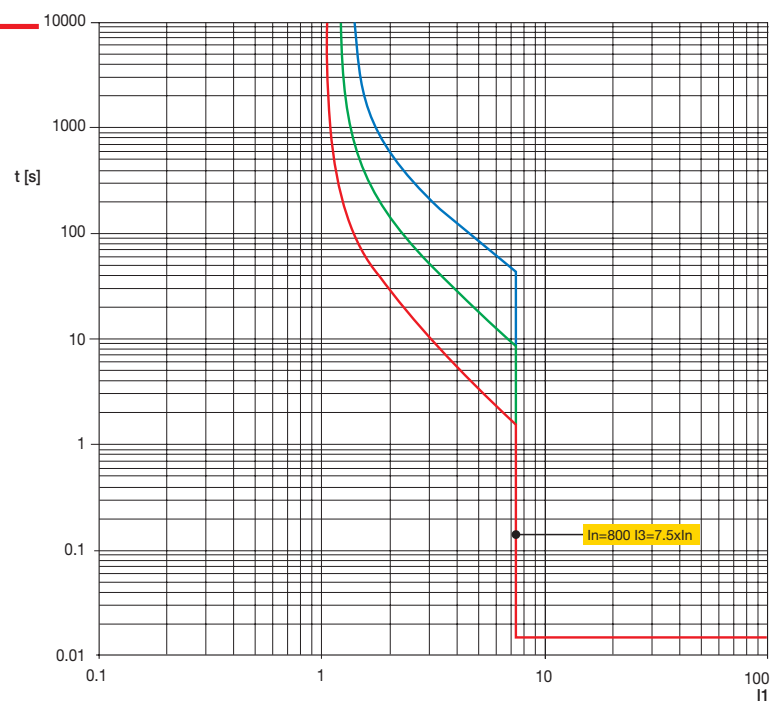

5 Special applications

5.2.2 16 2/3 Hz networks

Single phase distribution with a frequency of 16 2/3 Hz was developed for electrical traction systems as an alternative to three phase 50 Hz systems, and to direct current systems.

At low frequencies the thermal tripping threshold is not subject to any derating, while the magnetic threshold requires a correction coefficient k_m , as detailed in table 2.

The Isomax and Tmax series thermomagnetic moulded-case circuit-breakers are suitable for use with frequencies of 16 2/3 Hz; the electrical performance and the relevant connection diagrams are shown below.

Table 1: Breaking capacity [kA]

	In [A]	250 V	500 V	750 V	1000 V ⁽¹⁾
T1B160	16 + 160	16 (2P) 20 (3P)	16 (3P)	-	-
T1C160	25 + 160	25 (2P) 30 (3P)	25 (3P)	-	-
T1N160	32 + 160	36 (2P) 40 (3P)	36 (3P)	-	-
T2N160	1.6 + 160	36 (2P) 40 (3P)	36 (3P)	-	-
T2S160	1.6 + 160	50 (2P) 55 (3P)	50 (3P)	-	-
T2H160	1.6 + 160	70 (2P) 85 (3P)	70 (3P)	-	-
T2L160	1.6 + 160	85 (2P) 100 (3P)	85 (3P)	50 (4P) ⁽²⁾	-
T3N250	63 + 250	36 (2P) 40 (3P)	36 (3P)	-	-
T3S250	63 + 250	50 (2P) 55 (3P)	50 (3P)	-	-
T4N250/320	20 + 250	36 (2P)	25 (2P)	16 (3P)	-
T4S250/320	20 + 250	50 (2P)	36 (2P)	25 (3P)	-
T4H250/320	20 + 250	70 (2P)	50 (2P)	36 (3P)	-
T4L250/320	20 + 250	100 (2P)	70 (2P)	50 (3P)	-
T4V250/320	20 + 250	150 (2P)	100 (2P)	70 (3P)	-
T4V250	32 + 250	-	-	-	40 (4P)
T5N400/630	320 + 500	36 (2P)	25 (2P)	16 (3P)	-
T5S400/630	320 + 500	50 (2P)	36 (2P)	25 (3P)	-
T5H400/630	320 + 500	70 (2P)	50 (2P)	36 (3P)	-
T5L400/630	320 + 500	100 (2P)	70 (2P)	50 (3P)	-
T5V400/630	320 + 500	150 (2P)	100 (2P)	70 (3P)	-
T5V400/630	400 + 500	-	-	-	40 (4P)
T6N630/800	630 + 800	36 (2P)	20 (2P)	16 (3P)	-
T6S630/800	630 + 800	50 (2P)	35 (2P)	20 (3P)	-
T6H630/800	630 + 800	70 (2P)	50 (2P)	36 (3P)	-
T6L630/800	630 + 800	100 (2P)	70 (2P)	50 (3P)	40 (4P)

⁽¹⁾ 1000V version circuit-breakers in dc, with neutral at 100%.

⁽²⁾ Circuit-breakers with neutral at 100%.

5 Special applications

Table 2: k_m factor

	Diagram A	Diagram B	Diagram C
T1	1	1	-
T2	0.9	0.9	0.9
T3	0.9	0.9	-
T4	0.9	0.9	0.9
T5	0.9	0.9	0.9
T6	0.9	0.9	0.9

Table 3: Possible connections according to the voltage, the type of distribution and the type of fault

	Neutral not grounded	Neutral grounded*	
		L-N fault	L-E fault
250 V 2 poles in series	A1	A2	B2
250 V 3 poles in series**	B1	B2, B3	B3
500 V 2 poles in series	A1	A2, B2	B2, B3
500 V 3 poles in series**	B1	B2, B3	B3
750 V 3 poles in series	B1	B2, B3	B3
750 V 4 poles in series***	C1	C2, C3	C2
1000 V 4 poles in series	C1	C2, C3	C2

* In the case of the only possible faults being L-N or L-E (E=Earth) with non-significant impedance, use the diagrams shown. If both faults are possible, use the diagrams valid for L-E fault.

** T1, T2, T3 only

*** T2 only

5 Special applications

Connection diagrams

Diagram A1

Configuration with two poles in series (without neutral connected to earth)

- Interruption for phase to neutral fault: 2 poles in series
- Interruption for phase to earth fault: not considered
(The installation method must be such as to make the probability of a second earth fault negligible)

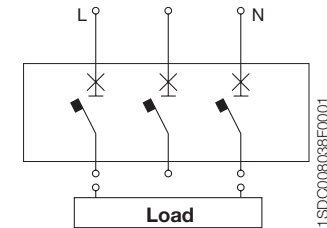
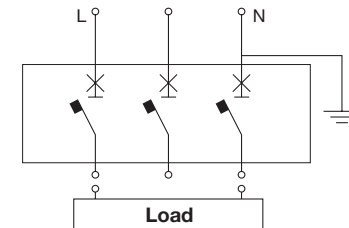

Diagram A2

Configuration with two poles in series (with neutral connected to earth)

- Interruption for phase to neutral fault: 2 poles in series
- Interruption for phase to earth fault: single pole (same capacity as two poles in series, but limited to 125V)



5 Special applications

Diagram B1

Configuration with three poles in series (without neutral connected to earth)

- Interruption for phase to neutral fault: 3 poles in series
- Interruption for phase to earth fault: not considered

(The installation method must be such as to make the probability of a second earth fault negligible)

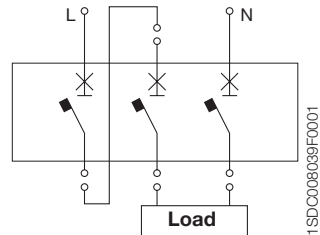

Diagram B2

Configuration with three poles in series (with neutral connected to earth and interrupted)

- Interruption for phase to neutral fault: 3 poles in series
- Interruption for phase to earth fault: 2 poles in series

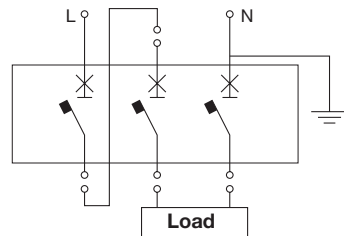
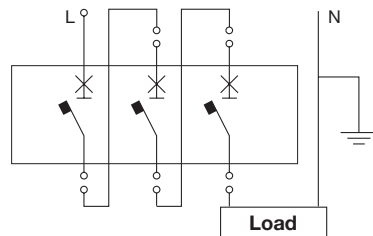

Diagram B3

Configuration with three poles in series (with neutral connected to earth but not interrupted)

- Interruption for phase to neutral fault: 3 poles in series
- Interruption for phase to earth fault: 3 poles in series



5 Special applications

Diagram C1

Configuration with four poles in series (without neutral connected to earth)

- Interruption for phase to neutral fault: 4 poles in series
- Interruption for phase to earth fault: not considered

(The installation method must be such as to make the probability of a second earth fault negligible)

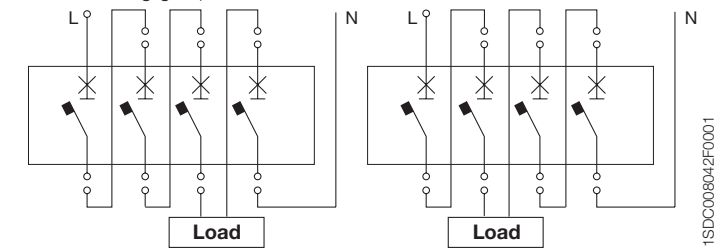

Diagram C2

Configuration with four poles in series, on one polarity (with neutral connected to earth and not interrupted)

- Interruption for phase to neutral fault: 4 poles in series
- Interruption for phase to earth fault: 4 poles in series

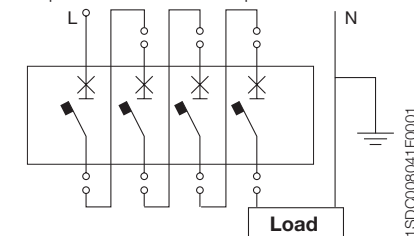
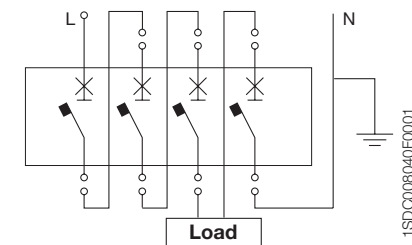

Diagram C3

Interruption with four poles in series (with neutral connected to earth and interrupted)

- Interruption for phase to neutral fault: 4 poles in series
- Interruption for phase to earth fault: 3 poles in series



5 Special applications

Example:

Network data:

Rated voltage 250 V

Rated frequency 16 2/3 Hz

Load current 120 A

Phase to neutral short-circuit current 45 kA

Neutral connected to earth

Assuming that the probability of a phase to earth fault is negligible, Table 3 shows that connections A2, B2 or B3 may be used.

Therefore it is possible to choose a Tmax T2S160 In125 circuit-breaker, which with the connection according to diagram A2 (two poles in series) has a breaking capacity of 50 kA, while according to diagrams B2 or B3 (three poles in series) the breaking capacity is 55 kA (Table 1). To determine the magnetic trip, see factor k_m in Table 2. The magnetic threshold will be:

$$I_3 = 1250 \cdot 0.9 = 1125 \text{ A}$$

whichever diagram is used.

If it is possible to have an earth fault with non significant impedance, the diagrams to be considered (Table 3) are only B2 or B3. In particular, in diagram B2 it can be seen that only 2 poles are working in series, the breaking capacity will be 50 kA (Table 1), while with diagram B3, with 3 poles working in series, the breaking capacity is 55 kA.

5.3 1000 Vdc and 1000 Vac networks

The Tmax, SACE Isomax and Emax /E 1000 V circuit-breakers are particularly suitable for use in installations in mines, petrochemical plants and services connected to electrical traction (tunnel lighting).

5.3.1 1000 V dc networks

1000 Vdc Moulded case circuit-breakers

General Characteristics

The range of Tmax and SACE Isomax S moulded-case circuit-breakers for use in installations with rated voltage up to 1000 V direct current comply with international standard IEC 60947-2. The range is fitted with adjustable thermomagnetic releases and is suitable for all installation requirements and has a range of available settings from 32 A to 800 A. The four-pole version circuit breakers allow high performance levels to be reached thanks to the series connection of the poles.

The circuit breakers in the Tmax and SACE Isomax S 1000 V range maintain the same dimensions and fixing points as standard circuit breakers.

These circuit-breakers can also be fitted with the relevant range of standard accessories, with the exception of residual current releases for Tmax and mechanical interlocks for SACE Isomax.

In particular it is possible to use conversion kits for removable and withdrawable moving parts and various terminal kits.

5 Special applications

1000 V dc Moulded-case circuit-breakers

	T4	T5	T6
Rated uninterrupted current, I_u [A]	250	400/630	630/800
Poles Nr.	4	4	4
Rated operational voltage, U_e [V -]	1000	1000	1000
Rated impulse withstand voltage, U_{imp} [kV]	8	8	8
Rated insulation voltage, U_i [V]	1000	1000	1000
Test voltage at industrial frequency for 1 min. [V]	3500	3500	3500
Rated ultimate short-circuit breaking capacity, I_{cu} (4 poles in series) [kA]	V	V	L
Rated short-time withstand current for 1 s, I_{cw} [kA]	-	5 (400A)	7.6 (630A) - 10 (800A)
Utilisation category (EN 60947-2)	A	B (400A)-A (630A)	B
Isolation behaviour	■	■	■
IEC 60947-2, EN 60947-2	■	■	■
Thermomagnetic releases TMD	■	-	-
Thermomagnetic releases TMA	■	■	■
Thermomagnetic releases, T adjustable - M adjustable	-	-	■
Versions	F	F	F
Terminals Fixed	FC Cu	FC Cu	F - FC CuAl - R
Mechanical life [No. operations / operations per hours]	20000/240	20000/120	20000/120
Basic dimensions, fixed L [mm]	140	184	280
D [mm]	103.5	103.5	103.5
H [mm]	205	205	268

TERMINAL CAPTION

F = Front
EF = Front extended

ES = Front extended spread

FC Cu = Front for copper cables
FC CuAl = Front for CuAl cables

R = Rear orientated

HR = Rear in horizontal flat bar
VR = Rear in vertical flat bar

MC = Multicable

Connection diagrams

Possible connection diagrams with reference to the type of distribution system in which they can be used follow.

Networks insulated from earth

The following diagrams can be used (the polarity may be inverted).

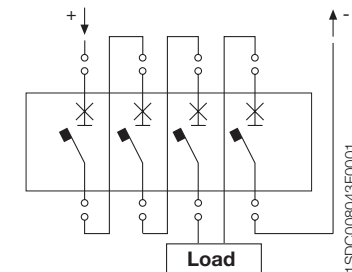

A) 3+1 poles in series (1000 Vdc)

5 Special applications

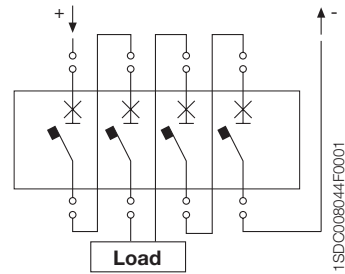

B) 2+2 poles in series (1000 Vdc)

It is assumed that the risk of a double earth fault in which the first fault is downstream of the breaker on one polarity and the second is upstream of the same switching device on the opposite polarity is null.

In this condition the fault current, which can reach high values, effects only some of the 4 poles necessary to ensure the breaking capacity.

It is possible to prevent the possibility of a double earth fault by installing a device which signals the loss of insulation and identifies the position of the first earth fault, allowing it to be eliminated quickly.

Networks with one polarity connected to earth

As the polarity connected to earth does not have to be interrupted (in the example it is assumed that the polarity connected to earth is negative, although the following is also valid with the polarity inverted), the diagram which shows the connection of 4 poles in series on the polarity not connected to earth may be used.

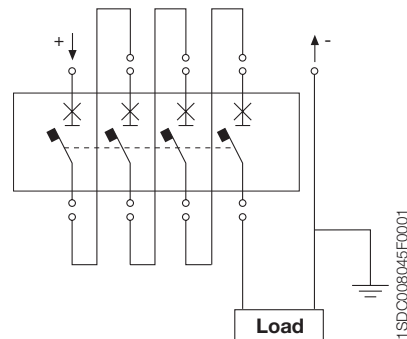

C) 4 poles in series (1000 Vdc)

5 Special applications

Networks with median point of the supply source connected to earth

In the presence of an earth fault of positive or negative polarity, the poles involved in the fault work at $U/2$ (500 V); the following diagram must be used:

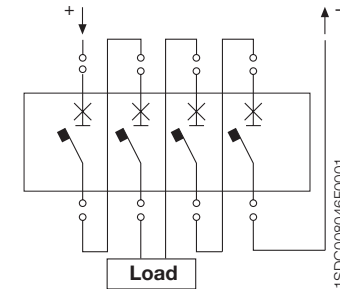

D) 2+2 poles in series (1000 Vdc)

Correction factors for tripping thresholds

With regard to overload protection, no correction factors need to be applied. However, for the magnetic threshold values in use with 1000 Vdc with the previously described applicable diagrams, refer to the corresponding values for alternating current, multiplied by the correction factors given in the following table:

Circuit-breaker	k_m
T4V	1
T5V	0.9
T6L	0.8

Circuit-breakers with thermomagnetic release for direct current

I_n [A]	32 ⁽¹⁾	50 ⁽¹⁾	80 ⁽²⁾	100 ⁽²⁾	125 ⁽²⁾	160 ⁽²⁾	200 ⁽²⁾	250 ⁽²⁾	400 ⁽²⁾	500 ⁽²⁾	630 ⁽²⁾	800 ⁽²⁾
T4V 250	■	■	■	■	■	■	■	■	-	-	-	-
T5V 400	-	-	-	-	-	-	-	-	■	-	-	-
T5V 630	-	-	-	-	-	-	-	-	-	■	-	-
T6L 630	-	-	-	-	-	-	-	-	-	-	■	-
T6L 800	-	-	-	-	-	-	-	-	-	-	-	■
$I_3 = (10 \times I_n)$ [A]	320	500	-	-	-	-	-	-	-	-	-	-
$I_3 = (5 \cdot 10 \times I_n)$ [A]	-	-	400+800	500+1000	625+1250	800+1600	1000+2000	1250+2500	2000+4000	2500+5000	3150+6300	4000+8000

⁽¹⁾ Thermal threshold adjustable from 0.7 and $1 \times I_n$; fixed magnetic threshold

⁽²⁾ Thermal threshold adjustable from 0.7 and $1 \times I_n$; magnetic threshold adjustable between 5 and $10 \times I_n$.

5 Special applications

Example

To ensure the protection of a user supplied with a network having the following characteristics:

Rated voltage	$U_r = 1000 \text{ Vdc}$
Short-circuit current	$I_k = 18 \text{ kA}$
Load current	$I_b = 420 \text{ A}$
Network with both polarities insulated from earth.	

From the table of available settings, the circuit-breaker to be used is:
 T5V 630 $I_n=500$ four-pole $I_{cu}@1000 \text{ Vdc} = 40 \text{ kA}$
 Thermal trip threshold adjustable from $(0.7-1) \times I_n$ therefore from 350 A to 500 A to be set at 0.84.

Magnetic trip threshold adjustable from $(5-10) \times I_n$ which with correction factor $K_{rn} = 0.9$ gives the following adjustment range: 2250 A to 4500 A. The magnetic threshold will be adjusted according to any conductors to be protected.

The connection of the poles must be as described in diagrams A or B.

A device which signals any first earth fault must be present.

With the same system data, if the network is carried out with a polarity connected to earth, the circuit-breaker must be connected as described in diagram C.

5 Special applications

1000 Vdc air switch disconnectors

The air switch disconnectors derived from the Emax air breakers are identified by the standard range code together with the code "E MS".

These comply with the international Standard IEC 60947-3 and are especially suitable for use as bus-ties or principle isolators in direct current installations, for example in electrical traction applications.

The overall dimensions and the fixing points remain unaltered from those of standard breakers, and they can be fitted with various terminal kits and all the accessories for the Emax range; they are available in both withdrawable and fixed versions, and in three-pole version (up to 750 Vdc) and four-pole (up to 1000 Vdc).

The withdrawable breakers are assembled with special version fixed parts for applications of 750/1000 Vdc.

The range covers all installation requirements up to 1000 Vdc / 3200 A or up to 750 Vdc / 4000 A.

A breaking capacity equal to the rated short-time withstand current is attributed to these breakers when they are associated with a suitable external relay.

The following table shows the available versions and their relative electrical performance:

		E1B/E MS		E2N/E MS		E3H/E MS		E4H/E MS		E6H/E MS	
		[A]	[A]	[A]	[A]	[A]	[A]	[A]	[A]	[A]	[A]
Rated current (at 40 °C) I_u	[A]	800		1250		1250		3200		5000	
	[A]	1250		1600		1600		4000		6300	
	[A]			2000		2000					
	[A]					2500					
	[A]					3200					
Poles		3 4	3 4	3 4	3 4	3 4	3 4	3 4	3 4	3 4	
Rated service voltage U_e	[V]	750 1000	750 1000	750 1000	750 1000	750 1000	750 1000	750 1000	750 1000	750 1000	
Rated insulation voltage U_i	[V]	1000 1000	1000 1000	1000 1000	1000 1000	1000 1000	1000 1000	1000 1000	1000 1000	1000 1000	
Rated impulse withstand voltage U_{imp}	[kV]	12 12	12 12	12 12	12 12	12 12	12 12	12 12	12 12	12 12	
Rated short-time withstand current I_{cw} (1s)	[kA]	20 20 ⁽¹⁾	25 25 ⁽¹⁾	40 40 ⁽¹⁾	65 65	65 65	65 65	65 65	65 65	65 65	
Rated making capacity I_{cm}	750V DC	[kA] 20 20	25 25	40 40	65 65	65 65	65 65	65 65	65 65	65 65	
	1000V DC	– 20	– 25	– 40	– 65	– 65	– 65	– 65	– 65	– 65	

Note: The breaking capacity I_{cu} , by means of external protection relay, with 500 ms maximum timing, is equal to the value of I_{cw} (1s).

(1) The performances at 750 V are:
 for E1B/E MS $I_{cw} = 25 \text{ kA}$,
 for E2N/E MS $I_{cw} = 40 \text{ kA}$ and
 for E3H/E MS $I_{cw} = 50 \text{ kA}$.

5 Special applications

Connection diagrams

Connection diagrams to be used according to the type of distribution system follow.

The risk of a double earth fault on different poles is assumed to be zero, that is, the fault current involves only one part of the breaker poles.

Networks insulated from earth

The following diagrams may be used (the polarity may be inverted).

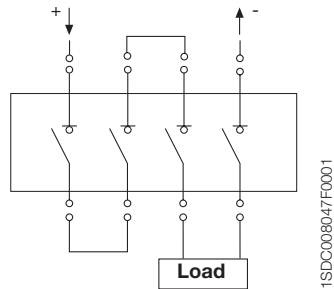

E) 3+1 poles in series (1000 Vdc)

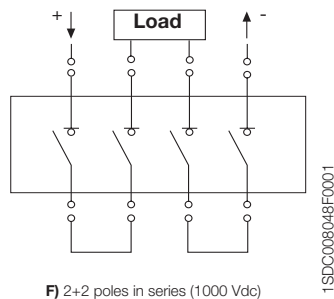

F) 2+2 poles in series (1000 Vdc)

5 Special applications

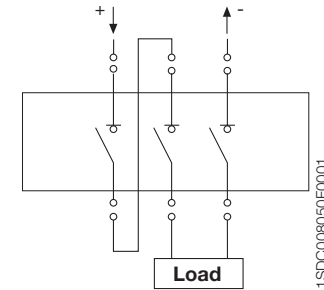

G) 2+1 poles in series (750 Vdc)

Networks with one polarity connected to earth

The polarity connected to earth does not have to be interrupted (in the examples it is assumed that the polarity connected to earth is negative):

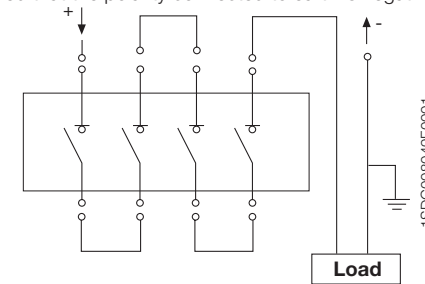

H) 4 poles in series (1000 Vdc)

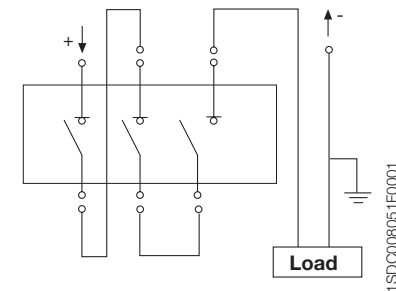

I) 3 poles in series (750 Vdc)

Networks with median point of the supply source connected to earth

Only four-pole breakers may be used as in the configuration shown in diagram F).

5 Special applications

5.3.2 1000 Vac networks

1000 Vac moulded-case circuit-breakers

General characteristics

The circuit breakers in the Tmax 1000 V range comply with the international standard IEC 60947-2.

These circuit breakers can be fitted with thermo-magnetic releases (for the smaller sizes) and with-electronic releases. All installation requirements can be met with a range of available settings from 32 A to 800 A and with breaking capacity up to 20 kA at 1000 Vac.

1000 Vac moulded-case circuit-breakers

Rated uninterrupted current, I_u	[A]
Poles	Nr.
Rated operational voltage, U_e (ac) 50-60Hz	[V]
Rated impulse withstand voltage, U_{imp}	[kV]
Rated insulation voltage, U_i	[V]
Test voltage at industrial frequency for 1 min.	[V]
Rated ultimate short-circuit breaking capacity, I_{cu} (ac) 50-60 Hz 1000 V	[kA]
Rated service short-circuit breaking capacity, I_{cs} (ac) 50-60 Hz 1000 V	[kA]
Rated short-circuit making capacity I_{cm} (ac) 50-60 Hz 1000 V	[kA]
Rated short-time withstand current for 1 s, I_{cw}	[kA]
Utilisation category (EN 60947-2)	
Isolation behaviour	
IEC 60947-2, EN 60947-2	
Thermomagnetic releases	TMD
	TMA
Electronic releases	PR221DS-LS
	PR221DS-I
	PR222DS-LSI
	PR222DS-LSIG
Interchangeability	
Versions	
Terminals	Fixed
Mechanical life	[No. operations / operations per hours]
Dimensions	L [mm]
	D [mm]
	H [mm]

5 Special applications

The circuit-breakers in the 1000 V range maintain the same dimensions as standard circuit breakers.

These circuit-breakers can also be fitted with the relevant range of standard accessories, with the exception of residual current releases.

The following tables show the electrical characteristics of the range:

T4			T5			T6	
250			400/630			630/800	
3	3	4	3	3	4	3	4
	1000			1000			1000
	8			8			8
	1000			1000			1000
	3500			3500			3500
L	V⁽¹⁾	V⁽¹⁾	L	V⁽¹⁾	V⁽¹⁾	L	
12	20	20	12	20	20	12	
12	12	12	10	10	10	6	
24	40	40	24	40	40	24	
				5 (400A)		7.6(630A) - 10(800A)	
	A			B (400A) A (630A)		B	
	■			■		■	
	■			■		■	
-	-	■	-	-	-	-	
-	-	■	-	-	■	-	■
■	■	-	■	■	-	■	-
■	■	-	■	■	-	■	-
■	■	-	■	■	-	■	-
	■			■		■	
	F			F		F	
	F-FC Cu			F-FC Cu		F-FC CuAl-R	
	20000/240			20000/120		20000/120	
105	105	140	140	140	184	210	280
103.5	103.5	103.5	103.5	103.5	103.5	103.5	
205	205	205	205	205	205	268	

TERMINAL CAPTION

F = Front
FC Cu = Front for copper cables
FC CuAl = Front for CuAl cables
R = Rear orientated

⁽¹⁾ The circuit-breaker can be supplied only through the upper terminals.

5 Special applications

The following tables show the available releases.

Circuit-breakers with electronic release for alternating currents

	In100	In250	In400	In630	In800
T4 250	■	■	-	-	-
T5 400	-	-	■	-	-
T5 630	-	-	-	■	-
T6L 630	-	-	-	■	-
T6L 800	-	-	-	-	■
$I_3 (1+10x \ln) [A]^{(1)}$	100+1000	250+2500	400+4000	630+6300	800+8000
$I_3 (1.5+12 x \ln) [A]^{(2)}$	150+1200	375+3000	600+4800	945+7560	1200+9600

⁽¹⁾ PR221

⁽²⁾ PR222

Circuit-breakers with thermomagnetic release for alternating currents

In [A]	32 ⁽¹⁾	50 ⁽¹⁾	80 ⁽²⁾	100 ⁽²⁾	125 ⁽²⁾	160 ⁽²⁾	200 ⁽²⁾	250 ⁽²⁾	400 ⁽²⁾	500 ⁽²⁾
T4V 250	■	■	■	■	■	■	■	■	-	-
T5V 400	-	-	-	-	-	-	-	-	■	-
T5V 630	-	-	-	-	-	-	-	-	-	■
$I_3 = (10xI_n) [A]$	320	500	-	-	-	-	-	-	-	-
$I_3 = (5-10xI_n) [A]$	-	-	400+800	500+1000	625+1250	800+1600	1000+2000	1250+2500	2000+4000	2500+5000

⁽¹⁾ Thermal threshold adjustable from 0.7 and 1 x In; fixed magnetic threshold

⁽²⁾ Thermal threshold adjustable from 0.7 and 1 x In; magnetic threshold adjustable between 5 and 10 x In.

1150 Vac air circuit-breakers and switch disconnectors

For 1150 V alternating current installations, the following devices are available:

- **Circuit-breakers** in compliance with Standard IEC 60947-2.

The special version breakers up to 1150 Vac are identified by the standard range code together with the suffix "/E", and are derived from the correspondent Emax standard breakers and retain the same versions, accessories and overall dimensions.

The Emax range of breakers is available in both withdrawable and fixed versions with three and four poles, and can be fitted with accessories and equipped with the full range of electronic releases and microprocessors (PR121-PR122-PR123).

- **Switch disconnectors** in compliance with Standard IEC 60947-3.

These breakers are identified by the code of the standard range, from which they are derived, together with the suffix "/E MS". Three-pole and four-pole versions are available in both withdrawable and fixed versions with the same dimensions, accessory characteristics and installation as the standard switch disconnectors.

5 Special applications

The following tables show the electrical characteristics of the devices:

Air circuit-breakers

		E2B/E		E2N/E			E3H/E				E4H/E		E6H/E		
Rated uninterrupted current (at 40 °C) I_u	[A]	1600	2000	1250	1600	2000	1250	1600	2000	2500	3200	3200	4000	5000	6300
Rated service voltage U_e	[V-]	1150	1150	1150	1150	1150	1150	1150	1150	1150	1150	1150	1150	1150	1150
Rated insulation voltage U_i	[V-]	1250	1250	1250	1250	1250	1250	1250	1250	1250	1250	1250	1250	1250	1250
Rated ultimate breaking capacity under short-circuit I_{cu}															
	1000 V [kA]	20	20	30	30	30	50	50	50	50	50	65	65	65	65
	1150 V [kA]	20	20	30	30	30	30	30	30	30	30	65	65	65	65
Rated service breaking capacity under short-circuit I_{cs}															
	1000 V [kA]	20	20	30	30	30	50	50	50	50	50	65	65	65	65
	1150 V [kA]	20	20	30	30	30	30	30	30	30	30	65	65	65	65
Rated short-time withstand current I_{cw} (1s)															
	1000 V [kA]	20	20	30	30	30	50	50	50	50	50	65	65	65	65
	1150 V [kA]	20	20	30	30	30	30	30	30	30	30	65	65	65	65
Rated making capacity under short-circuit (peak value) I_{cm}															
	1000 V [kA]	40	40	63	63	63	105	105	105	105	105	143	143	143	143
	1150 V [kA]	40	40	63	63	63	63	63	63	63	63	143	143	143	143

Air switch disconnectors (at 1150 Vac)

		E2B/E MS	E2N/E MS	E3H/E MS	E4H/E MS	E6H/E MS
Rated current (at 40 °C) I_u	[A]	1600	1250	1250	3200	5000
	[A]	2000	1600	1600	4000	6300
	[A]		2000	2000		
	[A]			2500		
	[A]			3200		
Poles		3/4	3/4	3/4	3/4	3/4
Rated service voltage U_e	[V]	1150	1150	1150	1150	1150
Rated insulation voltage U_i	[V]	1250	1250	1250	1250	1250
Rated impulse withstand voltage U_{imp}	[kV]	12	12	12	12	12
Rated short-time withstand current I_{cw} (1s)	[kA]	20	30	30 ⁽¹⁾	65	65
Rated making capacity I_{cm} (peak value)	[kA]	40	63	63 ⁽²⁾	143	143

Note: The breaking capacity I_{cu} , by means of external protection relay, with 500 ms maximum timing, is equal to the value of I_{cw} (1s).

⁽¹⁾ The performance at 1000V is 50 kA

⁽²⁾ The performance at 1000V is 105 kA

5 Special applications

5.4 Automatic Transfer Switches

In the electrical plants, where a high reliability is required from the power supply source because the operation cycle cannot be interrupted and the risk of a lack of power supply is unacceptable, an emergency line supply is indispensable to avoid the loss of large quantities of data, damages to working processes, plant stops etc.

For these reasons, transfer switch devices are used mainly for:

- power supply of hotels and airports;
- surgical rooms and primary services in hospitals;
- power supply of UPS groups;
- databanks, telecommunication systems, PC rooms;
- power supply of industrial lines for continuous processes.

ATS010 is the solution offered by ABB: it is an automatic transfer switch system with micro-processor based technology which allows switching of the supply from the normal line (N-Line) to the emergency line (E-Line) in case any of the following anomalies occurs on the main network:

- overvoltages and voltage dips;
- lack of one of the phases;
- asymmetries in the phase cycle;
- frequency values out of the setting range.

Then, when the network standard parameters are recovered, the system switches again the power supply to the main network (N-Line).

ATS010 is used in systems with two distinct supply lines connected to the same busbar system and functioning independently ("island condition"): the first one is used as normal supply line, the second is used for emergency power supply from a generator system. It is also possible to provide the system with a device to disconnect the non-priority loads when the network is supplied from the E-Line.

The following scheme shows a plant having a safety auxiliary power supply:

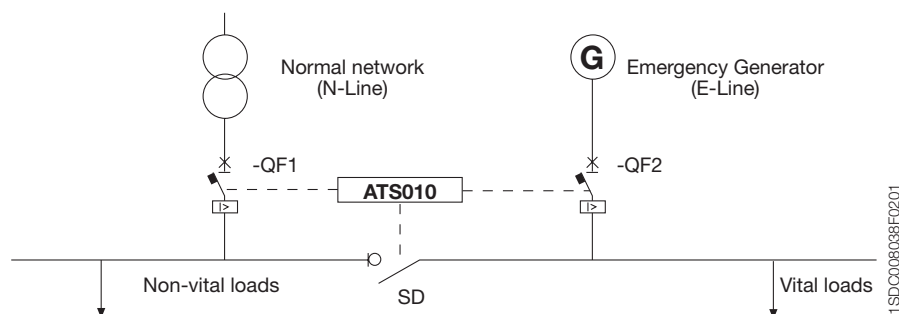

5 Special applications

ATS010 device is interfaced by means of appropriate terminals:

- with the protection circuit-breakers of the N-Line and of the E-Line, motorized and mechanically interlocked, to detect their status and send opening and closing commands according to the set time delays;
- with the control card of the Gen set to control its status and send start and stop commands;
- with any further signals coming from the plant in order to block the switching logic;
- with the N-Line to detect any possible anomaly and with the E-Line to verify the voltage presence;
- with an additional device to disconnect non-priority loads;
- with an auxiliary power supply at 24 Vdc \pm 20% (or 48 Vdc \pm 10%). This supply source shall be present also in case of lack of voltage on both lines (N-Line and E-Line).

The circuit-breakers used to switch from the N-line to the E-line shall have all the necessary accessories and shall be properly interlocked in order to guarantee the correct working of the plant. The following accessories are required:

Moulded-case circuit-breakers Tmax (T4-T5-T6) and SACE Isomax (S7):

- motor operator from 48 V to 110 V dc or up to 250V ac;
- trip signaling contact;
- open/closed signaling contact;
- racked-in signaling contact in case of plug-in or withdrawable circuit-breakers;
- mechanical interlock between two circuit-breakers.

Air circuit-breakers Emax:

- charging spring motor;
- shunt opening release;
- shunt closing release;
- trip signaling contact;
- open/closed signaling contacts;
- racked-in signaling contact in case of withdrawable circuit-breakers;
- mechanical interlock between two circuit-breakers.

Switching strategies

According to the application where ATS010 device is used, two different switching strategies can be chosen.

Strategy 1: this strategy is used when an auxiliary supply source is available for the supply of the motor operators of the circuit-breakers; the switching sequence is as follows:

- normal line anomaly detection;
- normal line circuit-breaker opening and Gen Set starting;
- waiting for presence of Gen Set voltage and emergency circuit-breaker closing.

5 Special applications

For example, strategy 1 is used for systems in which a redundant 110 V auxiliary power supply is available (MV/LV substations); the plant is designed so that the auxiliary voltage is always present even when neither the normal line nor the Gen Set are active. In this case, the auxiliary power supply can be used to feed the motor operators and/or the shunt opening and closing releases of the circuit-breakers. ATSO10 operates the circuit-breakers regardless of the presence of the network and of the Gen Set.

Strategy 2: this strategy is absolutely necessary when the power supply for the auxiliary accessories of the circuit-breakers is directly derived from the network and the Gen Set, since a safety auxiliary power supply is not available; in this case, before operating the circuit-breakers, ATSO10 waits for availability of normal line or emergency line voltage: normal line or Gen Set. The switching sequence is as follows:

- normal line anomaly detection;
- Gen Set starting;
- waiting for presence of Gen Set voltage and normal line circuit-breaker opening;
- Gen Set circuit-breaker closing.

Note: in both strategies, it is necessary to provide an auxiliary power supply for ATSO10.

Operating modes

By using the front selector it is possible to choose one of the following six operating modes:

TEST:

This operating mode is useful to test the Gen Set start and therefore to test the emergency line power supply status without disconnecting normal line power supply.

AUTOMATIC:

The transfer switch logic is ON and checks both the circuit-breakers as well as the generator. In case of normal line anomalies, the transfer switch procedure begins from normal to emergency line and viceversa when normal line voltage become available again.

5 Special applications

MANUAL:

The MANUAL mode offers a choice between the following possibilities:

1. Normal ON

The emergency line circuit-breaker is forced to open and the normal line circuit-breaker is forced to close; the Gen Set is stopped and the transfer switch logic is disabled.

This selector position guarantees that the emergency line is not closed and that the Gen Set is not running; this position is useful when the user wants to carry out maintenance on the emergency line or on the Gen Set (in these cases it is advisable to install mechanical lock in open position for the emergency line circuit-breaker).

2. Normal – Emergency OFF (maintenance)

Both circuit-breakers (N-Line and E-Line) are forced in open position. It is useful when all loads are to be disconnected from the power supply sources, for example to carry out maintenance on the plant (in these cases, it is advisable to mechanically lock both circuit-breakers in the open position).

3. Gen Set START

The START command of the Gen Set has been activated through the proper output. The circuit-breakers are not operated and the transfer switch logic is disabled.

When emergency line voltage is present and switching is enabled, it is possible to switch the selector to 'Emergency ON' position in order to force supply from the emergency line.

4. Emergency ON

Power supply is forced from the emergency line. Before switching to this position, 'Gen-Set START' operating mode is activated and shall be present until switching is enabled as previously described.

5 Special applications

Setting of parameters

All the parameters for the functioning of ATSO10 can be simply adjusted through dip-switches or trimmers.

Rated voltage for three-phase or single-phase plant

The following parameters of the N-Line can be set through dip-switches:

- network rated voltage value (from 100 V up to 500 V);
- power supply type (three-phase or single-phase);
- frequency value (50 Hz or 60 Hz);
- type of strategy.

Note: Voltages higher than 500 V can be reached by using VTs (voltage transformers); in this case the setting of the voltage value shall consider the transformation ratio.

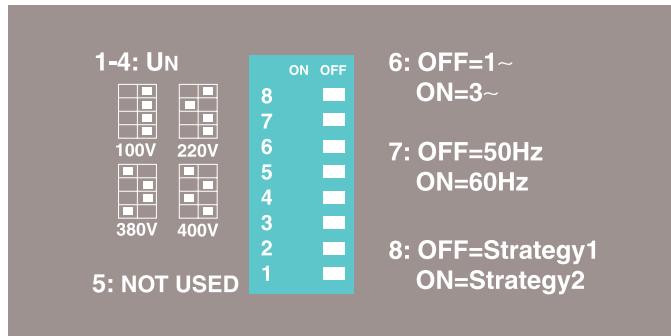

The figure below shows all the possible voltage values which can be set by the dip-switches from 1 to 4.

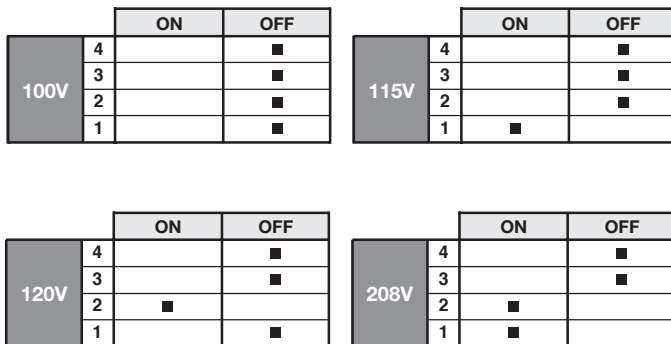

5 Special applications

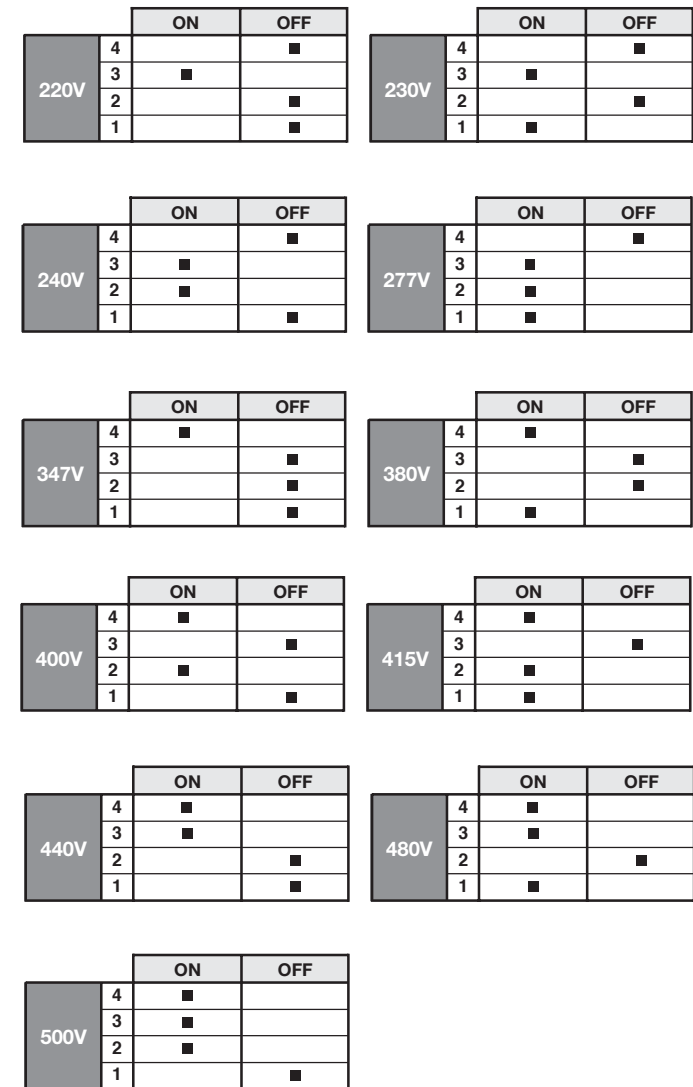

Note: the black square shows the dip-switch position.

5 Special applications

Overvoltage threshold

According to the load characteristics, it is possible to set the voltage range outside which the N-Line supply cannot be accepted and switching to the E-Line is necessary.

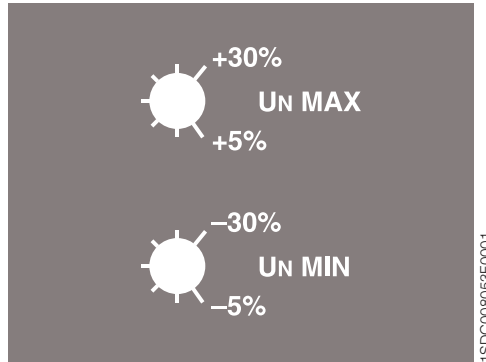

Transfer switch delay configuration

Transfer switch delays can be set through special trimmers. Setting times and relevant purposes are reported below:

T1 = 0 ÷ 32 s CB-N open

Delay time from net anomaly detection to N-Line CB opening. It is used to avoid transfer switching in case of short voltage dips.

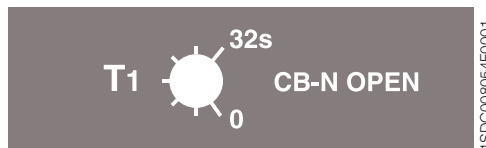

T2 = 0 ÷ 32 s GEN-SET START

Delay time from net anomaly detection to Gen set start command. It is used to prevent from transfer switching in case of short voltage dips.

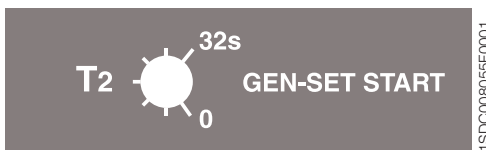

5 Special applications

T3= 0 ÷ 254 s GEN-SET STOP

Delay time from N-Line return to Gen set stop command. It is used when the Generator needs a cooling time after the disconnection of the load (opening of the E-Line circuit-breaker).

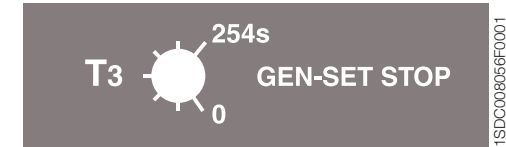

T4= 0 ÷ 254 s BACK TO NORMAL LINE OK

Delay time necessary for N-Line voltage to establish, before inverse switching procedure is started.

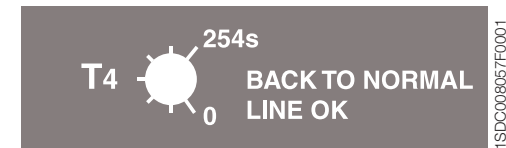

T5 = 0 ÷ 32 s CB-E CLOSE

Delay time to allow the gen-set voltage to stabilize: after starting the generator and detecting a voltage on the emergency line, the ATS010 unit waits for a time T5 before considering this voltage stable.

In Strategy 1, after detecting the gen-set voltage, the ATS010 unit waits for time T5 before closing CB-E.

In strategy 2, the ATS010 unit cannot open or close the breakers unless there is a stable voltage source. Therefore, the unit waits for a time T5 before opening CB-N. If, however, a time delay T1 since voltage loss has not elapsed, the ATS010 unit waits until T1 has elapsed, and only then opens CB-N.

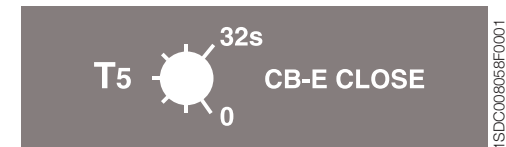

5 Special applications

Check on the plant and on the circuit-breakers

ATS010 can be used in plants with the following characteristics:

- the Gen set shall function independently ("island" condition);
- rated voltage and frequency of the plants are included within the given ranges;
- ATS010 supply is guaranteed even if N-Line and E-Line voltages are missing.

The two circuit-breakers controlled by ATS are to be:

- mechanically interlocked;
- of the prescribed type and size;
- equipped with the prescribed accessories.

References Standards

EN 50178 (1997): "Electronic equipment for use in power installations"
Compliance with "Low Voltage Directive" (LVD) no. 73/23/EEC and
"Electromagnetic Compatibility Directive" (EMC) no. 89/336/EEC.
Electromagnetic compatibility: EN 50081-2, EN 50082-2
Environmental conditions: IEC 60068-2-1, IEC 60068-2-2, IEC 60068-2-3.

ATS010 - main technical characteristics

Rated power supply voltage (galvanically isolated from the ground)	24 Vdc \pm 20% 48 Vdc \pm 10% (maximum ripple \pm 5%)
Maximum power consumption	5 W @ 24 Vdc 10 W @ 48 Vdc
Rated power (N-Line voltage present and CBs not operated)	1,8 W @ 24 Vdc 4,5 W @ 48 Vdc
Operating temperature	-25 °C...+70 °C
Maximum humidity	90 % without condensation
Storing temperature	-20 °C.....+80 °C
Degree of protection	IP54 (front panel)
Dimensions (H x W x D)	144 x 144 x 85
Weight [kg]	0,8

Normal line voltage sensor

Normal line rated voltage	100...500 Vac with direct connection Over 500 Vac with external voltage transformers
Rated frequency	50 Hz / 60 Hz
Impulse withstand voltage on L1, L2, L3 inputs	6 kV

Motor operators - shunt opening/closing releases

Tmax T4-T5-T6 Isomax S7	Up to 250 Vac From 48 Vdc to 110 Vdc
Emax	Up to 250 Vac From 24 Vdc to 110 Vdc

6 Switchboards

6.1 Electrical switchboards

The switchboard is a combination of one or more low voltage switching, protection and other devices assembled in one or more enclosure so as to satisfy the requirements regarding safety and to allow the functions for which it was designed to be carried out.

A switchboard consists of a container, termed enclosure by the relevant Standards (which has the function of support and mechanical protection of the components contained within), and the electrical equipment, which consists of devices, internal connections and input and output terminals for connection with the system.

The reference Standard is IEC 60439-1 published in 1999, titled "Low-voltage switchgear and controlgear assemblies - Part 1: Type-tested and partially type-tested assemblies", approved by CENELEC code number EN 60439-1.

Supplementary calculation guides are:

IEC 60890 "A method of temperature-rise assessment by extrapolation for partially type-tested assemblies (PTTA) of low-voltage switchgear and controlgear".

IEC 61117 "A method for assessing the short-circuit withstand strength of partially type-tested assemblies (PTTA)".

IEC 60865-1 "Short-circuit currents - Calculation of effects - Part 1: Definitions and calculation methods".

Standard IEC 60439-1 sets out the requirements relating to the construction, safety and maintainability of electrical switchboards, and identifies the nominal characteristics, the operational environmental conditions, the mechanical and electrical requirements and the performance regulations.

The type-tests and individual tests are defined, as well as the method of their execution and the criteria necessary for the evaluation of the results.

Standard IEC 60439-1 distinguishes between the two types of switchboard: TTA (type-tested assemblies) and PTTA (partially type-tested assemblies).

By "type-tested assemblies" (TTA), it is meant a low voltage switchgear and controlgear assemblies conforming to an established type or system without deviations likely to significantly influence the performance from the typical assembly verified to be in accordance with the Standard prescriptions.

TTA switchboards are assemblies derived directly from a prototype designed in all details and subjected to type-tests; as the type-tests are very complex, switchboards designed by a manufacturer with a sound technical and financial basis are referred to. Nevertheless, TTA assemblies can be mounted by a panel builder or installer who follows the manufacturer's instructions; deviations from the prototype are only allowed if they do not significantly change the performance compared with the type-tested equipment.

6 Switchboards

By "partially type-tested assemblies" (PTTA), it is meant a low voltage and controlgear assembly, tested only with a part of the type-tests; some tests may be substituted by extrapolation which are calculations based on experimental results obtained from assemblies which have passed the type-tests. Verifications through simplified measurements or calculations, allowed as an alternative to type tests, concern heating, short circuit withstand and insulation.

Standard IEC 60439-1 states that some steps of assembly may take place outside the factory of the manufacturer, provided the assembly is performed in accordance with the manufacturer's instructions.

The installer may use commercial assembly kits to realize a suitable switchboard configuration.

The same Standard specifies a division of responsibility between the manufacturer and the assembler in Table 7: "List of verifications and tests to be performed on TTA and PTTA" in which the type-tests and individual tests to be carried out on the assembly are detailed.

The type-tests verify the compliance of the prototype with the requirements of the Standard, and are generally under the responsibility of the manufacturer, who must also supply instructions for the production and assembly of the switchboard. The assembler has responsibility for the selection and assembly of components in accordance with the instructions supplied and must confirm compliance with the Standards through the previously stated checks in the case of switchboards that deviate from a tested prototype. Routine tests must also be carried out on every example produced.

The distinction between TTA and PTTA switchgear and controlgear assemblies has no relevance to the declaration of conformity with Standard IEC 60439-1, in so far as the switchboard must comply with this Standard.

6 Switchboards

List of verifications and tests to be performed on TTA and PTTA

No.	Characteristics to be checked	Sub-clauses	TTA	PTTA
1	Temperature-rise limits	8.2.1	Verification of temperature-rise limits by test (type test)	Verification of temperature-rise limits by test or extrapolation
2	Dielectric properties	8.2.2	Verification of dielectric properties by test (type test)	Verification of dielectric properties by test according to 8.2.2 or 8.3.2, or verification of insulation resistance according to 8.3.4 (see No. 9 and 11)
3	Short-circuit withstand strength	8.2.3	Verification of the short-circuit withstand strength by test (type test)	Verification of the short-circuit withstand strength by test or by extrapolation from similar type-tested arrangements
4	Effectiveness of the protective circuit	8.2.4		
	Effective connection between the exposed conductive parts of the ASSEMBLY and the protective circuit	8.2.4.1	Verification of the effective connection between the exposed conductive parts of the ASSEMBLY and the protective circuit by inspection or by resistance measurement (type test)	Verification of the effective connection between the exposed conductive parts of the ASSEMBLY and the protective circuit by inspection or by resistance measurement
	Short-circuit withstand strength of the protective circuit	8.2.4.2	Verification of the short-circuit withstand strength of the protective circuit by test (type test)	Verification of the short-circuit withstand strength of the protective circuit by test or appropriate design and arrangement of the protective conductor (see 7.4.3.1.1, last paragraph)
5	Clearances and creepage distances	8.2.5	Verification of the clearances and creepage distances (type test)	Verification of clearances and creepage distances
6	Mechanical operation	8.2.6	Verification of mechanical operation (type test)	Verification of mechanical operation
7	Degree of protection	8.2.7	Verification of the degree of protection (type test)	Verification of the degree of protection
8	Wiring, electrical operation	8.3.1	Inspection of the ASSEMBLY including inspection of wiring and, if necessary, electrical operation test (routine test)	Inspection of the ASSEMBLY including inspection of wiring and, if necessary, electrical operation test
9	Insulation	8.3.2	Dielectric test (routine test)	Dielectric test or verification of insulation resistance according to 8.3.4 (see No. 2 and 11)
10	Protective measures	8.3.3	Checking of protective measures and of the electrical continuity of the protective circuits (routine test)	Checking of protective measures
11	Insulation resistance	8.3.4		Verification of insulation resistance unless test according to 8.2.2 or 8.3.2 has been made (see No. 2 and 9)

6 Switchboards

Degrees of protection

The degree of protection IP indicates a level of protection provided by the assembly against access to or contact with live parts, against ingress of solid foreign bodies and against the ingress of liquid. The IP code is the system used for the identification of the degree of protection, in compliance with the requirements of Standard IEC 60529. Unless otherwise specified by the manufacturer, the degree of protection applies to the complete switchboard, assembled and installed for normal use (with door closed).

The manufacturer shall also state the degree of protection applicable to particular configurations which may arise in service, such as the degree of protection with the door open or with devices removed or withdrawn.

Elements of the IP Code and their meanings

Element	Numerals or letters	Meaning for the protection of equipment	Meaning for the protection of persons	Ref.
First characteristic numeral	IP	Against ingress of the solid foreign objects	Against access to hazardous parts with	Cl.5
	0	(non-protected)	(non-protected)	
	1	≥ 50 mm diameter	back of hand	
	2	≥ 12.5 mm diameter	finger	
	3	≥ 2.5 mm diameter	tool	
	4	≥ 1.0 mm diameter	wire	
	5	dust-protected	wire	
Second characteristic numeral	6	dust-tight	wire	Cl.6
	0	Against ingress of water with harmful effects		
	1	(non-protected)		
	2	vertically dripping		
	3	dripping (15° tilted)		
	4	spraying		
	5	splashing		
	6	jetting		
	7	powerful jetting		
8	temporary immersion			
Additional letter (optional)	8	continuous immersion	Against access to hazardous parts with	Cl.7
	A		back of hand	
	B		finger	
	C		tool	
	D		wire	
Supplementary letter (optional)		Supplementary information specific to:		Cl.8
	A	High voltage apparatus		
	B	Motion during water test		
	C	Stationary during water test		
	D	Weather conditions		

6 Switchboards

Form of separation and classification of switchboards

Forms of internal separation

By form of separation it is meant the type of subdivision provided within the switchboard. Separation by means of barriers or partitions (metallic or insulating) may have the function to:

- provide protection against direct contact (at least IPXXB) in the case of access to a part of the switchboard which is not live, with respect to the rest of the switchboard which remains live;
- reduce the risk of starting or propagating an internal arc;
- impede the passage of solid bodies between different parts of the switchboard (degree of protection of at least IP2X).

A partition is a separation element between two parts, while a barrier protects the operator from direct contact and from arcing effects from any interruption devices in the normal access direction.

The following table from Standard IEC 60439-1 highlights typical forms of separation which can be obtained using barriers or partitions:

Main criteria	Subcriteria	Form
No separation		Form 1
Separation of busbars from the functional units	Terminals for external conductors not separated from busbars	Form 2a
	Terminals for external conductors separated from busbars	Form 2b
Separation of busbars from the functional units and separation of all functional units from one another.	Terminals for external conductors not separated from busbars	Form 3a
	Separation of the terminals for external conductors from the functional units, but not from each other	Form 3b
Separation of busbars from the functional units and separation of all functional units from one another, including the terminals for external conductors which are an integral part of the functional unit	Terminals for external conductors in the same compartment as the associated functional unit	Form 4a
	Terminals for external conductors not in the same compartment as the associated functional unit, but in individual, separate, enclosed protected spaces or compartments	Form 4b

6 Switchboards

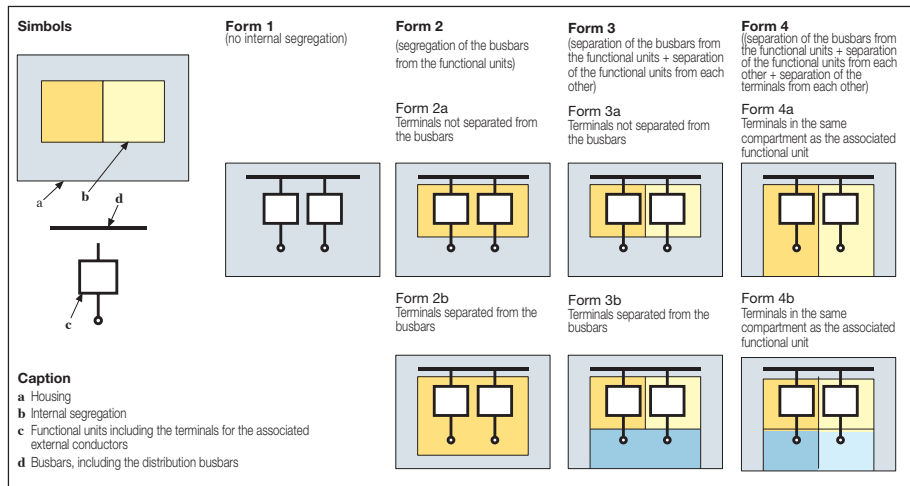

Classification

Different classifications of electrical switchboard exist, depending on a range of factors.

Based on construction type, Standard IEC 60439-1 firstly distinguishes between open and enclosed assemblies.

A switchboard is enclosed when it comprises protective panels on all sides, providing a degree of protection against direct contact of at least IPXXB. Switchboards used in normal environments must be enclosed.

Open switchboards, with or without front covering, which have the live parts accessible. These switchboards may only be used in electrical plants.

With regard to external design, switchboards are divided into the following categories:

- Cubicle-type assembly

Used for large scale control and distribution equipment; multi-cubicle-type assembly can be obtained by placing cubicles side by side.

6 Switchboards

- Desk-type assembly

Used for the control of machinery or complex systems in the mechanical, iron and steel, and chemical industries.

- Box-type assembly

Characterized by wall mounting, either mounted on a wall or flush-fitting; these switchboards are generally used for distribution at department or zone level in industrial environments and in the tertiary sector.

- Multi-box-type assembly

Each box, generally protected and flanged, contains a functional unit which may be an automatic circuit-breaker, a starter, a socket complete with locking switch or circuit-breaker.

With regard to the intended function, switchboards may be divided into the following types:

- Main distribution boards

Main distribution boards are generally installed immediately downstream of MV/LV transformers, or of generators; they are also termed power centres. Main distribution boards comprise one or more incoming units, busbar connectors, and a relatively smaller number of output units.

- Secondary distribution boards

Secondary distribution boards include a wide range of switchboards for the distribution of power, and are equipped with a single input unit and numerous output units.

- Motor operation boards

Motor control boards are designed for the control and centralised protection of motors: therefore they comprise the relative coordinated devices for operation and protection, and auxiliary control and signalling devices.

- Control, measurement and protection boards

Control, measurement and protection boards generally consist of desks containing mainly equipment for the control, monitoring and measurement of industrial processes and systems.

- Machine-side boards

Machine-side boards are functionally similar to the above; their role is to provide an interface between the machine with the power supply and the operator.

- Assemblies for construction sites (ASC)

Assemblies for construction sites may be of different sizes, from a simple plug and socket assembly to true distribution boards with enclosures of metal or insulating material. They are generally mobile or, in any case, transportable.

6 Switchboards

Method of temperature rise assessment by extrapolation for partially tested assemblies (PTTA)

For PTTA assemblies, the temperature rise can be determined by laboratory tests or calculations, which can be carried out in accordance with Standard IEC 60890. The formulae and coefficients given in this Standard are deduced from measurements taken from numerous switchboards, and the validity of the method has been checked by comparison with the test results.

This method does not cover the whole range of low voltage switchgear and controlgear assemblies since it has been developed under precise hypotheses which limit the applications; this can however be correct, suited and integrated with other calculation procedures which can be demonstrated to have a technical basis.

Standard IEC 60890 serves to determine the temperature rise of the air inside the switchboard caused by the energy dissipated by the devices and conductors installed within the switchboard.

To calculate the temperature rise of the air inside an enclosure, once the requirements of the Standard have been met, the following must be considered:

- Dimensions of the enclosure.
- Type of installation:
 - enclosure open to air on all sides;
 - wall-mounted enclosure;
 - enclosure designed for mounting in extremities;
 - enclosure in an internal position in a multi-compartment switchboard;
- Any ventilation openings, and their dimensions.
- Number of horizontal internal separators;
- Power losses from the effective current flowing through any device and conductor installed within the switchboard or compartment.

The Standard allows the calculation of temperature rise of the air at mid-height and at the highest point of the switchboard. Once the values are calculated, it must be evaluated if the switchboard can comply with the requirements relating to the set limits at certain points within the same switchboard.

The Annex B explains the calculation method described in the Standard.

ABB supplies the client with calculation software which allows the temperature rise inside the switchboard to be calculated quickly.

6 Switchboards

6.2 MNS switchboards

MNS systems are suitable for applications in all fields concerning the generation, distribution and use of electrical energy; e. g., they can be used as:

- main and sub-distribution boards;
- motor power supply of MCCs (Motor Control Centres);
- automation switchboards.

The MNS system is a framework construction with maintenance-free bolted connections which can be equipped as required with standardized components and can be adapted to any application. The consistent application of the modular principle both in electrical and mechanical design permits optional selection of the structural design, interior arrangement and degree of protection according to the operating and environmental conditions.

The design and material used for the MNS system largely prevent the occurrence of electric arcs, or provide for arc extinguishing within a short time. The MNS System complies with the requirements laid down in VDE0660 Part 500 as well as IEC 61641 and has furthermore been subjected to extensive accidental arc tests by an independent institute.

The MNS system offers the user many alternative solutions and notable advantages in comparison with conventional-type installations:

- compact, space-saving design;
- back-to-back arrangement;
- optimized energy distribution in the cubicles;
- easy project and detail engineering through standardized components;
- comprehensive range of standardized modules;
- various design levels depending on operating and environmental conditions;
- easy combination of the different equipment systems, such as fixed and withdrawable modules in a single cubicle;
- possibility of arc-proof design (standard design with fixed module design);
- possibility of earthquake-, vibration- and shock-proof design;
- easy assembly without special tools;
- easy conversion and retrofit;
- largely maintenance-free;
- high operational reliability;
- high safety for human beings.

The basic elements of the frame are C-sections with holes at 25 mm intervals in compliance with Standard DIN 43660. All frame parts are secured maintenance-free with tapping screws or ESLOK screws. Based on the basic grid size of 25 mm, frames can be constructed for the various cubicle types without any special tools. Single or multi-cubicle switchgear assemblies for front or front and rear operations are possible.

Different designs are available, depending on the enclosure required:

- single equipment compartment door;
- double equipment compartment door;
- equipment and cable compartment door;
- module doors and/or withdrawable module covers and cable compartment door.

The bottom side of the cubicle can be provided with floor plates. With the aid of flanged plates, cable ducts can be provided to suit all requirements. Doors and cladding can be provided with one or more ventilation opening, roof plates can be provided with metallic grid (IP 30 – IP40) or with ventilation chimney (IP 40, 41, 42).

6 Switchboards

Depending on the requirements, a frame structure can be subdivided into the following compartments (functional areas):

- equipment compartment;
- busbar compartment;
- cable compartment.

The equipment compartment holds the equipment modules, the busbar compartment contains the busbars and distribution bars, the cable compartment houses the incoming and outgoing cables (optionally from above and from below) with the wiring required for connecting the modules as well as the supporting devices (cable mounting rails, cable connection parts, parallel connections, wiring ducts, etc.). The functional compartments of a cubicle as well as the cubicles themselves can be separated by partitions. Horizontal partitions with or without ventilation openings can also be inserted between the compartments.

All incoming/outgoing feeder and bus coupler cubicles include one switching device. These devices can be fixed-mounted switch disconnectors, fixed-mounted or withdrawable air or moulded-case circuit-breakers.

This type of cubicles is subdivided into equipment and busbar compartments; their size (H x W) is 2200 mm x 400 mm / 1200 mm x 600 mm, and the depth depends on the dimensions of the switchgear used.

Cubicles with air circuit-breakers up to 2000 A can be built in the reduced dimensioned version (W = 400 mm).

It is possible to interconnect cubicles to form optimal delivery units with a maximum width of 3000 mm.

6.3 ArTu distribution switchboards

The range of ABB SACE ArTu distribution switchboards provides a complete and integrated offer of switchboards and kit systems for constructing primary and secondary low voltage distribution switchboards.

With a single range of accessories and starting from simple assembly kits, the ArTu switchboards make it possible to assemble a wide range of configurations mounting modular, moulded-case and air circuit-breakers, with any internal separation up to Form 4.

ABB SACE offers a series of standardized kits, consisting of pre-drilled plates and panels for the installation of the whole range of circuit-breakers type System pro M, Isomax, Tmax and Emax E1, E2, E3, E4 without the need of additional drilling operations or adaptations.

Special consideration has been given to cabling requirements, providing special seats to fix the plastic cabling duct horizontally and vertically.

Standardization of the components is extended to internal separation of the switchboard: in ArTu switchboards, separation is easily carried out and it does not require either construction of "made-to-measure" switchboards or any additional sheet cutting, bending or drilling work.

ArTu switchboards are characterized by the following features:

- integrated range of modular metalwork structures up to 4000 A with common accessories;
- possibility of fulfilling all application requirements in terms of installation (wall-mounting, floor-mounting, monoblock and cabinet kits) and degree of protection (IP31, IP41, IP43, IP65);
- structure made of hot-galvanized sheet;

6 Switchboards

- maximum integration with modular devices and ABB SACE moulded-case and air circuit-breakers;
- minimum switchboard assembly times thanks to the simplicity of the kits, the standardization of the small assembly items, the self-supporting elements and the presence of clear reference points for assembly of the plates and panels;
- separations in kits up to Form 4.

The range of ArTu switchboards includes four versions, which can be equipped with the same accessories.

ArTu L series

ArTu L series consists of a range of modular switchboard kits, with a capacity of 24 modules per row and degree of protection IP31 (without door) or IP43 (basic version with door). These switchboards can be wall- or floor-mounted:

- wall-mounted ArTu L series, with heights of 600, 800, 1000 and 1200 mm, depth 200 mm, width 700 mm. Both System pro M modular devices and moulded-case circuit-breakers Tmax T1-T2-T3 are housed inside this switchboard series;
- floor-mounted ArTu L series, with heights of 1400, 1600, 1800 and 2000 mm, depth 240 mm, width 700 mm. System pro M modular devices, moulded-case circuit-breakers type Tmax T1-T2-T3-T4-T5-T6 (fixed version with front terminals) are housed inside this switchboard series.

ArTu M series

ArTu M series consists of a modular range of monoblock switchboards for wall-mounted (with depths of 150 and 200 mm with IP65 degree of protection) or floor-mounted (with depth of 250 mm and IP31 or IP65 degrees of protection) installations, in which it is possible to mount System pro M modular devices and Tmax T1-T2-T3 moulded-case circuit-breakers on a DIN rail. ArTu M series of floor-mounted switchboards can be equipped with Tmax series.

ArTu K series

ArTu K series consists of a range of modular switchboard kits for floor-mounted installation with four different depths (250, 350, 600, 800 and 1000 mm) and with degree of protection IP31 (without front door), IP41 (with front door and ventilated side panels) or IP65 (with front door and blind side panels), in which it is possible to mount System pro M modular devices, the whole range of moulded-case circuit-breakers Tmax and Isomax, and Emax circuit-breakers E1, E2, E3 and E4.

ArTu switchboards have three functional widths:

- 400 mm, for the installation of moulded-case circuit-breakers up to 630 A (T5);
- 600 mm, which is the basic dimension for the installation of all the apparatus;
- 800 mm, for the creation of the side cable container within the structure of the floor-mounted switchboard or for the use of panels with the same width.

The available internal space varies in height from 600 mm (wall-mounted L series) to 2000 mm (floor-mounted M series and K series), thus offering a possible solution for the most varied application requirements.

6 Switchboards

ArTu PB Series (Panelboard and Pan Assembly)

The ArTu line is now upgraded with the new ArTu PB Panelboard solution. The ArTu PB Panelboard is suitable for distribution applications with an in-comer up to 800A and outgoing feeders up to 250A. The ArTu PB Panelboard is extremely sturdy thanks to its new designed framework and it is available both in the wall-mounted version as well as in the floor-mounted one. ArTu PB Panelboard customisation is extremely flexible due to the smart design based on configurations of 6, 12 and 18 outgoing ways and to the new ABB plug-in system that allows easy and fast connections for all T1 and T3 versions. Upon request, extension boxes are available on all sides of the structure, for metering purposes too. The vertical trunking system is running behind the MCCB's layer allowing easy access to every accessory wiring (SR's, UV's, AUX contacts). The ArTu PB Panelboard, supplied as a standard with a blind door, is available with a glazed one as well.

Annex A: Protection against short-circuit effects inside low-voltage switchboards

The Std. IEC 60439-1 specifies that ASSEMBLIES (referred to hereafter as switchboards) shall be constructed so as to be capable of withstanding the thermal and dynamic stresses resulting from short-circuit currents up to the rated values.

Furthermore, switchboards shall be protected against short-circuit currents by means of circuit-breakers, fuses or a combination of both, which may either be incorporated in the switchboard or arranged upstream.

When ordering a switchboard, the user shall specify the short-circuit conditions at the point of installation.

This chapter takes into consideration the following aspects:

- **The need, or not, to carry out a verification of the short-circuit withstand strength of the switchboard.**
- **The suitability of a switchboard for a plant as a function of the prospective short-circuit current of the plant and of the short-circuit parameters of the switchboard.**
- **The suitability of a busbar system as a function of the short-circuit current and of the protective devices.**

Annex A: Protection against short-circuit effects inside low-voltage switchboards

Verification of short-circuit withstand strength

The verification of the short-circuit withstand strength is dealt with in the Standard IEC 60439-1, where, in particular, the cases requiring this verification and the different types of verification are specified.

The verification of the short-circuit withstand strength is not required if the following conditions are fulfilled:

- For switchboards having a rated short-time current (I_{cw}) or rated conditional current (I_k) not exceeding 10 kA.
- For switchboards protected by current limiting devices having a cut-off current not exceeding 17 kA at the maximum allowable prospective short-circuit current at the terminals of the incoming circuit of the switchboard.
- For auxiliary circuits of switchboards intended to be connected to transformers whose rated power does not exceed 10 kVA for a rated secondary voltage of not less than 110 V, or 1.6 kVA for a rated secondary voltage less than 110 V, and whose short-circuit impedance is not less than 4%.
- For all the parts of switchboards (busbars, busbar supports, connections to busbars, incoming and outgoing units, switching and protective devices, etc.) which have already been subjected to type tests valid for conditions in the switchboard.

Therefore, from an engineering point of view, the need to verify the short-circuit withstand strength may be viewed as follows:

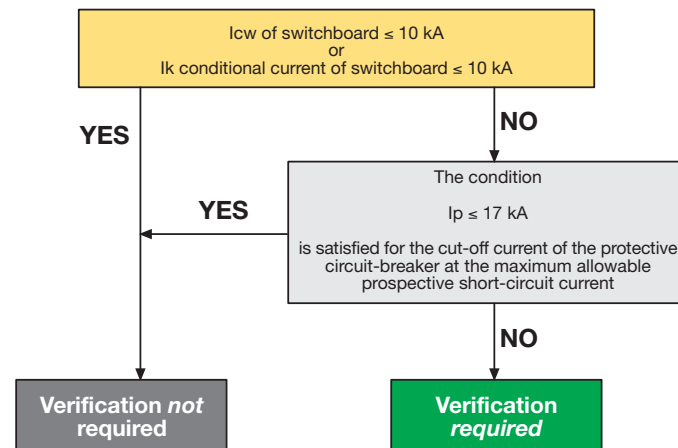

As regards the details of the test performance, reference shall be made directly to the Standard IEC 60439-1.

Annex A: Protection against short-circuit effects inside low-voltage switchboards

Short-circuit current and suitability of the switchboard for the plant

The verification of the short-circuit withstand strength is based on two values stated by the manufacturer in alternative to each other:

- the rated short-time current I_{cw}
- the rated conditional short-circuit current I_k

Based on one of these two values, it is possible to determine whether the switchboard is suitable to be installed in a particular point of the system.

It shall be necessary to verify that the breaking capacities of the apparatus inside the switchboard are compatible with the short-circuit values of the system.

The rated short-time withstand current I_{cw} is a predefined r.m.s. value of test current, to which a determined peak value applied to the test circuit of the switchboard for a specified time (usually 1s) corresponds. The switchboard shall be able to withstand the thermal and electro-dynamical stresses without damages or deformations which could compromise the operation of the system. From this test (if passed) it is possible to obtain the specific let-through energy (I^2t) which can be carried by the switchboard:

$$I^2t = I_{cw}^2t$$

The test shall be carried out at a power factor value specified below in the Table 4 of the Std. IEC 60439-1. A factor "n" corresponding at this $\cos\varphi$ value allows to determine the peak value of the short-circuit current withstood by the switchboard through the following formula:

$$I_p = I_{cw} \cdot n$$

Table 4

r.m.s. value of short-circuit current	power factor $\cos\varphi$	n
$I \leq 5$ kA	0.7	1.5
$5 < I \leq 10$ kA	0.5	1.7
$10 < I \leq 20$ kA	0.3	2
$20 < I \leq 50$ kA	0.25	2.1
$50 < I$	0.2	2.2

The values of this table represent the majority of applications. In special locations, for example in the vicinity of transformers or generators, lower values of power factor may be found, whereby the maximum prospective peak current may become the limiting value instead of the r.m.s. value of the short-circuit current.

The conditional short-circuit current is a predetermined r.m.s. value of test current to which a defined peak value corresponds and which can be withstood by the switchboard during the operating time of a specified protective device. This device is usually the main circuit-breaker of the switchboard.

By comparing the two values I_{cw} and I_p with the prospective short-circuit current of the plant, it is possible to establish whether the switchboard is suitable to be installed at a specified point of the system.

The following diagrams show the method to determine the compatibility of the switchboard with the plant.

Annex A: Protection against short-circuit effects inside low-voltage switchboards

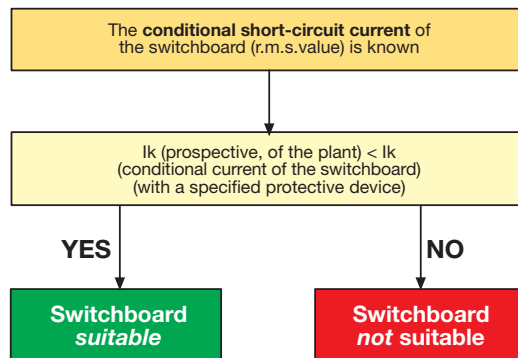
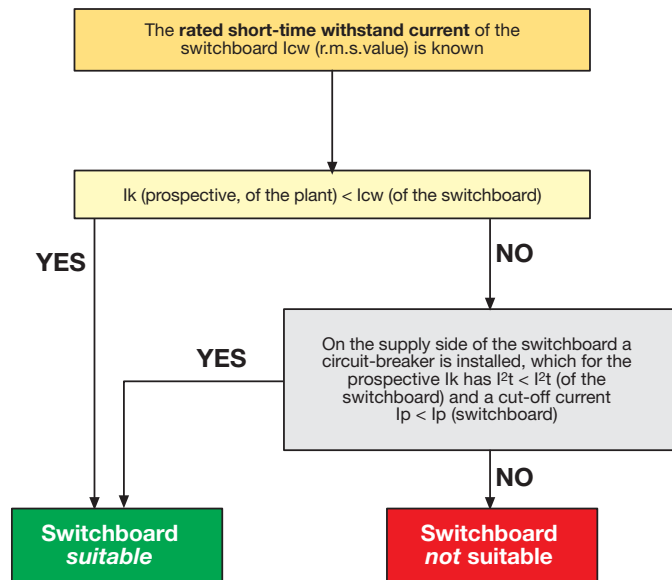

The breaking capacities of the apparatus inside the switchboard shall be verified to be compatible with the short-circuit values of the plant.

Annex A: Protection against short-circuit effects inside low-voltage switchboards

Example

Plant data: Rated voltage $U_r=400$ V
 Rated frequency $f_r=50$ Hz
 Short-circuit current $I_k=35$ kA

Assume that in an existing system there is a switchboard with I_{cw} equal to 35 kA and that, at the installation point of the switchboard, the prospective short-circuit current is equal to 35 kA.

Now assume that an increase in the power supply of a plant is decided and that the short-circuit value rises to 60 kA.

Plant data after the increase: Rated voltage $U_r=400$ V
 Rated frequency $f_r=50$ Hz
 Short-circuit current $I_k=60$ kA

Since the I_{cw} of the switchboard is lower than the short-circuit current of the system, in order to verify that the actual switchboard is still compatible, it is necessary to:

- determine the I^2t and I_p values let-through by the circuit-breaker on the supply side of the switchboard
- verify that the protective devices installed inside the switchboard have a sufficient breaking capacity (separately or in back-up)

$I_{cw} = 35$ kA from which:

$$I^2t_{\text{switchboard}} = 35^2 \times 1 = 1225 \text{ MA}^2\text{s}$$

$$I_{p\text{switchboard}} = 73.5 \text{ kA (according to Table 4)}$$

Assuming that on the supply side of the switchboard a circuit-breaker type Tmax T5H (**I_{cu}=70kA@415V**) is installed

$$I^2t_{\text{CB}} < 4 \text{ MA}^2\text{s}$$

$$I_{p\text{CB}} < 40 \text{ kA}$$

since

$$I^2t_{\text{switchboard}} > I^2t_{\text{CB}}$$

$$I_{p\text{switchboard}} > I_{p\text{CB}}$$

it results that the switchboard (structure and busbar system) is suitable.

Assume that the circuit-breakers installed inside the switchboard are circuit-breakers type T1, T2 and T3 version N with **I_{cu}=36kA@415V**. From the back-up tables (see Chapter 4.3), it results that the circuit-breakers inside the switchboard are suitable for the plant, since their breaking capacity is increased to 65 kA thanks to the circuit-breaker type T5H on the supply side.

Annex A: Protection against short-circuit effects inside low-voltage switchboards

Selection of the distribution system in relation to short-circuit withstand strength

The dimensioning of the distribution system of the switchboard is obtained by taking into consideration the rated current flowing through it and the prospective short-circuit current of the plant.

The manufacturer usually provides tables which allow the choice of the busbar cross-section as a function of the rated current and give the mounting distances of the busbar supports to ensure the short-circuit withstand strength.

To select a distribution system compatible with the short-circuit data of the plant, one of these procedures shall be followed:

• If the protective device on the supply side of the distribution system is known

From the I_{cw} value of the distribution system it results:

$I_{k_{sys}} = I_{cw} \cdot n$ where n is the factor deduced from the Table 4

$I^2t_{sys} = I_{cw}^2 \cdot t$ where t is equal to 1 s

In correspondence with the prospective short-circuit current value of the plant the following values can be determined:

the cut-off current of the circuit-breaker $I_{p_{CB}}$

the specific let-through energy of the circuit-breaker I^2t_{CB}

If $I_{p_{CB}} < I_{p_{sys}}$ and $I^2t_{CB} < I^2t_{sys}$, then the distribution system is suitable.

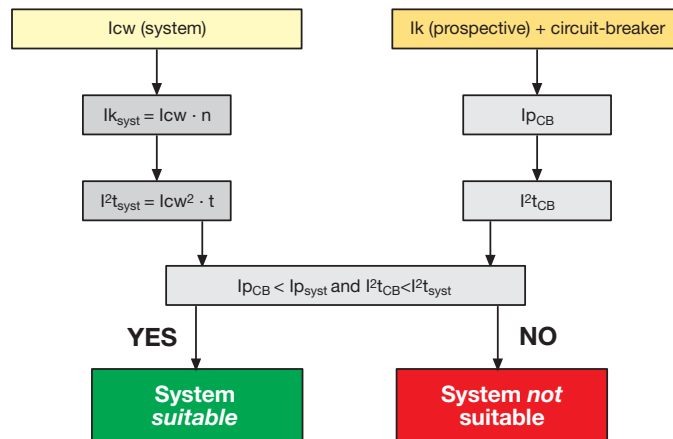

• If the protective device on the supply side of the distribution system is not known

The following condition must be fulfilled:

$$I_k (\text{prospective}) < I_{cw} (\text{system})$$

Annex A: Protection against short-circuit effects inside low-voltage switchboards

Example

Plant data: Rated voltage $U_r=400$ V
Rated frequency $f_r=50$ Hz
Short-circuit current $I_k=65$ kA

By considering the need of using a system of 400 A busbars with shaped form, in the ABB SACE catalogue "ArTu distribution switchboards" the following choice is possible:

BA0400 $I_n=400$ A (IP65) $I_{cw}=35$ kA.

By assuming to have on the supply side of the busbar system a moulded-case circuit-breaker type

ABB SACE Tmax T5400 $I_n=400$

from the I_{cw} of the busbar system, it derives:

$I_{p_{sys}} = I_{cw} \cdot n = 35 \cdot 2.1 = 73.5$ [kA]

$I^2t_{sys} = I_{cw}^2 \cdot t = 35^2 \cdot 1 = 1225$ [(kA)²s]

From the curves

- at page 118

I_k 65kA corresponds at about $I_{p_{CB}}=35$ kA

- at page 144

I_k 65kA corresponds at about $I^2t_{CB}=4$ [(kA)²s]= 4 [MA²sec]

Thus, since

$I_{p_{CB}} < I_{p_{sys}}$

and

$I^2t_{CB} < I^2t_{sys}$

it results that the busbar system is compatible with the switchboard.

Annex A: Protection against short-circuit effects inside low-voltage switchboards

Selection of conductors on the supply side of the protective devices

The Standard IEC 60439-1 prescribes that in a switchboard, the active conductors (distribution busbars included) positioned between the main busbars and the supply side of the single functional units, as well as the constructional components of these units, can be dimensioned according to the reduced short-circuit stresses which occur on the load side of the short-circuit protective device of the unit.

This may be possible if the conductors are installed in such a way throughout the switchboard that, under normal operating conditions, an internal short-circuit between phases and/or between phase and earth is only a remote possibility. It is advisable that such conductors are of solid rigid manufacture.

As an example, this Standard gives conductor types and installation requirements which allow to consider a short-circuit between phases and/or between phase and earth only a remote possibility.

Type of conductor	Requirements
Bare conductors or single-core conductors with basic insulation, for example cables according to IEC 60227-3.	Mutual contact or contact with conductive parts shall be avoided, for example by use of spacers.
Single-core conductors with basic insulation and a maximum permissible conductor-operating temperature above 90°C, for example cables according to IEC 60245-3, or heat-resistant PVC insulated cables according to IEC 60227-3.	Mutual contact or contact with conductive parts is permitted where there is no applied external pressure. Contact with sharp edges must be avoided. There must be no risk of mechanical damage. These conductors may only be loaded such that an operating temperature of 70°C is not exceeded.
Conductors with basic insulation, for example cables according to IEC 60227-3, having additional secondary insulation, for example individually covered cables with shrink sleeving or individually run cables in plastic conduits.	No additional requirements if there is no risk of mechanical damage.
Conductors insulated with a very high mechanical strength material, for example FTFE insulation, or double-insulated conductors with an enhanced outer sheath rated for use up to 3 kV, for example cables according to IEC 60502.	
Single or multi-core sheathed cables, for example cables according to IEC 60245-4 or 60227-4.	

Under these conditions or if anyway the integral short-circuit may be considered a remote possibility, the above described procedure shall be used to verify the suitability of the distribution system to the short-circuit conditions, when these are determined as a function of the characteristics of the circuit-breakers on the load side of the busbars.

Annex A: Protection against short-circuit effects inside low-voltage switchboards

Example

Plant data:
 Rated voltage $U_r=400$ V
 Rated frequency $f_r=50$ Hz
 Short-circuit current $I_k=45$ kA

In the switchboard shown in the figure, the vertical distribution busbars are derived from the main busbars. These are 800 A busbars with shaped section and with the following characteristics:
 I_n (IP65) = 800 A,
 I_{cw} max = 35 kA
 Since it is a "rigid" system with spacers, according to the Std. IEC 60439-1 a short-circuit between busbars is a remote possibility.

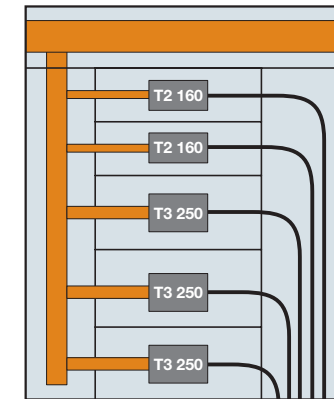

Anyway, a verification that the stresses reduced by the circuit-breakers on the load side of the system are compatible with the system is required. Assuming that in the cubicles there are the following circuit-breakers:

ABB SACE T3S250
 ABB SACE T2S160

it is necessary to verify that, in the case of a short-circuit on any outgoing conductor, the limitations created by the circuit-breaker are compatible with the busbar system; to comply with this requirement, at the maximum allowable prospective short-circuit current, the circuit-breaker with higher cut-off current and let-through energy must have an adequate current limiting capability for the busbar system.

In this case the circuit-breaker is type ABB SACE T3S250 In250. The verification shall be carried out as in the previous paragraph:

From the I_{cw} of the busbar system, it derives:

$$I_{p_{\text{sys}}} = I_{cw} \cdot n = 35 \cdot 2.1 = 73.5 \quad [\text{kA}]$$

$$I^2 t_{\text{sys}} = I_{cw}^2 \cdot t = 35^2 \cdot 1 = 1225 \quad [(\text{kA})^2 \text{s}]$$

From the limitation and let-through energy curves

- at page 116
 $I_k = 45$ kA corresponds at about $I_{p_{CB}} = 30$ kA
- at page 142
 $I_k = 45$ kA corresponds at about $I^2 t_{CB} = 2$ [(kA)²s]

Thus, since

$$I_{p_{CB}} < I_{p_{\text{sys}}}$$

$$\text{and}$$

$$I^2 t_{CB} < I^2 t_{\text{sys}}$$

it results that the busbar system is compatible with the switchboard.

Annex B: Temperature rise evaluation according to IEC 60890

The calculation method suggested in the Standard IEC 60890 makes it possible to evaluate the temperature rise inside an assembly (PTTA); this method is applicable only if the following conditions are met:

- there is an approximately even distribution of power losses inside the enclosure;
- the installed equipment is arranged in a way that air circulation is only slightly impeded;
- the equipment installed is designed for direct current or alternating current up to and including 60 Hz with the total of supply currents not exceeding 3150 A;
- conductors carrying high currents and structural parts are arranged in a way that eddy-current losses are negligible;
- for enclosures with ventilating openings, the cross-section of the air outlet openings is at least 1.1 times the cross-section of the air inlet openings;
- there are no more than three horizontal partitions in the PTTA or a section of it;
- where enclosures with external ventilation openings have compartments, the surface of the ventilation openings in each horizontal partition shall be at least 50% of the horizontal cross section of the compartment.

The data necessary for the calculation are:

- dimensions of the enclosure: height, width, depth;
- the type of installation of the enclosure (see Table 8);
- presence of ventilation openings;
- number of internal horizontal partitions;
- the power loss of the equipment installed in the enclosure (see Tables 13 and 14);
- the power loss of the conductors inside the enclosure, equal to the sum of the power loss of every conductor, according to Tables 1, 2 and 3.

For equipment and conductors not fully loaded, it is possible to evaluate the power loss as:

$$P = P_n \left(\frac{I_b}{I_n} \right)^2 \quad (1)$$

where:

- P is the actual power loss;
- P_n is the rated power loss (at I_n);
- I_b is the actual current;
- I_n is the rated current.

Annex B: Temperature rise evaluation according to IEC 60890

Table 1: Operating current and power losses of insulated conductors

Cross-section (Cu)	Maximum permissible conductor temperature 70 °C											
	Air temperature inside the enclosure around the conductors											
	35 °C		55 °C		35 °C		55 °C		35 °C		55 °C	
	operating current	power losses 2)	operating current	power losses 2)	operating current	power losses 2)	operating current	power losses 2)	operating current	power losses 2)	operating current	power losses 2)
mm ²	A	W/m	A	W/m	A	W/m	A	W/m	A	W/m	A	W/m
1.5	12	2.1	8	0.9	12	2.1	8	0.9	12	2.1	8	0.9
2.5	17	2.5	11	1.1	20	3.5	12	1.3	20	3.5	12	1.3
4	22	2.6	14	1.1	25	3.4	18	1.8	25	3.4	20	2.2
6	28	2.8	18	1.2	32	3.7	23	1.9	32	3.7	25	2.3
10	38	3.0	25	1.3	48	4.8	31	2.0	50	5.2	32	2.1
16	52	3.7	34	1.6	64	5.6	42	2.4	65	5.8	50	3.4
25					85	6.3	55	2.6	85	6.3	65	3.7
35					104	7.5	67	3.1	115	7.9	85	5.0
50					130	7.9	85	3.4	150	10.5	115	6.2
70					161	8.4	105	3.6	175	9.9	149	7.2
95					192	8.7	125	3.7	225	11.9	175	7.2
120					226	9.6	147	4.1	250	11.7	210	8.3
150					275	11.7	167	4.3	275	11.7	239	8.8
185					295	10.9	191	4.6	350	15.4	273	9.4
240					347	12.0	225	5.0	400	15.9	322	10.3
300					400	13.2	260	5.6	460	17.5	371	11.4

Conductors for auxiliary circuits					
					Diam.
0.12	2.6	1.2	1.7	0.5	0.4
0.14	2.9	1.3	1.9	0.6	-
0.20	3.2	1.1	2.1	0.5	-
0.22	3.6	1.3	2.3	0.5	0.5
0.30	4.4	1.4	2.9	0.6	0.6
0.34	4.7	1.4	3.1	0.6	0.6
0.50	6.4	1.8	4.2	0.8	0.8
0.56		1.6		0.7	-
0.75	8.2	1.9	5.4	0.8	1.0
1.00	9.3	1.8	6.1	0.8	-

1) Any arrangement desired with the values specified referring to six cores in a multi-core bundle with a simultaneous load 100%

2) single length

Annex B: Temperature rise evaluation according to IEC 60890

Table 2: Operating current and power losses of bare conductors, in vertical arrangement without direct connections to apparatus

Width x Thickness	Cross-section (Cu)	Maximum permissible conductor temperature 85 °C															
		Air temperature inside the enclosure around the conductors 35 °C								Air temperature inside the enclosure around the conductors 55 °C							
		50 Hz to 60 Hz ac				dc and ac to 16 2/3 Hz				50 Hz to 60 Hz ac				dc and ac to 16 2/3 Hz			
		operating current	power losses 1)	operating current	power losses 1)	operating current	power losses 1)	operating current	power losses 1)	operating current	power losses 1)	operating current	power losses 1)	operating current	power losses 1)	operating current	power losses 1)
mm x mm	mm ²	A*	W/m	A**	W/m	A*	W/m	A**	W/m	A*	W/m	A**	W/m	A*	W/m	A**	W/m
12 x 2	23.5	144	19.5	242	27.5	144	19.5	242	27.5	105	10.4	177	14.7	105	10.4	177	14.7
15 x 2	29.5	170	21.7	282	29.9	170	21.7	282	29.9	124	11.6	206	16.0	124	11.6	206	16.0
15 x 3	44.5	215	23.1	375	35.2	215	23.1	375	35.2	157	12.3	274	18.8	157	12.3	274	18.8
20 x 2	39.5	215	26.1	351	34.8	215	26.1	354	35.4	157	13.9	256	18.5	157	12.3	258	18.8
20 x 3	59.5	271	27.6	463	40.2	271	27.6	463	40.2	198	14.7	338	21.4	198	14.7	338	21.4
20 x 5	99.1	364	29.9	665	49.8	364	29.9	668	50.3	266	16.0	485	26.5	266	16.0	487	26.7
20 x 10	199	568	36.9	1097	69.2	569	36.7	1107	69.6	414	19.6	800	36.8	415	19.5	807	37.0
25 x 5	124	435	34.1	779	55.4	435	34.1	78	55.6	317	18.1	568	29.5	317	18.1	572	29.5
30 x 5	149	504	38.4	894	60.6	505	38.2	899	60.7	368	20.5	652	32.3	369	20.4	656	32.3
30 x 10	299	762	44.4	1410	77.9	770	44.8	1436	77.8	556	27.7	1028	41.4	562	23.9	1048	41.5
40 x 5	199	641	47.0	1112	72.5	644	47.0	1128	72.3	468	25.0	811	38.5	469	24.9	586	38.5
40 x 10	399	951	52.7	1716	88.9	968	52.6	1796	90.5	694	28.1	1251	47.3	706	28.0	1310	48.1
50 x 5	249	775	55.7	1322	82.9	782	55.4	1357	83.4	566	29.7	964	44.1	570	29.4	989	44.3
50 x 10	499	1133	60.9	2008	102.9	1164	61.4	2141	103.8	826	32.3	1465	54.8	849	32.7	1562	55.3
60 x 5	299	915	64.1	1530	94.2	926	64.7	1583	94.6	667	34.1	1116	50.1	675	34.4	1154	50.3
60 x 10	599	1310	68.5	2288	116.2	1357	69.5	2487	117.8	955	36.4	1668	62.0	989	36.9	1814	62.7
80 x 5	399	1170	80.7	1929	116.4	1200	80.8	2035	116.1	858	42.9	1407	61.9	875	42.9	1484	61.8
80 x 10	799	1649	85.0	2806	138.7	1742	85.1	3165	140.4	1203	45.3	2047	73.8	1271	45.3	1756	74.8
100 x 5	499	1436	100.1	2301	137.0	1476	98.7	2407	121.2	1048	53.3	1678	72.9	1077	52.5	1756	69.8
100 x 10	999	1982	101.7	3298	164.2	2128	102.6	3844	169.9	1445	54.0	2406	84.4	1552	54.6	2803	90.4
120 x 10	1200	2314	115.5	3804	187.3	2514	115.9	4509	189.9	1688	61.5	2774	99.6	1833	61.6	3288	101.0

*) one conductor per phase **) two conductors per phase 1) single length

1SDCC008041F0201

Annex B: Temperature rise evaluation according to IEC 60890

Table 3: Operating current and power losses of bare conductors used as connections between apparatus and busbars

Width x Thickness	Cross-section (Cu)	Maximum permissible conductor temperature 65 °C							
		Air temperature inside the enclosure around the conductors 35 °C				Air temperature inside the enclosure around the conductors 55 °C			
		50 Hz to 60 Hz ac and dc							
		operating current	power losses 1)	operating current	power losses 1)	operating current	power losses 1)	operating current	power losses 1)
mm x mm	mm ²	A*	W/m	A**	W/m	A*	W/m	A**	W/m
12 x 2	23.5	82	5.9	130	7.4	69	4.2	105	4.9
15 x 2	29.5	96	6.4	150	7.8	88	5.4	124	5.4
15 x 3	44.5	124	7.1	202	9.5	102	4.8	162	6.1
20 x 2	39.5	115	6.9	184	8.9	93	4.5	172	7.7
20 x 3	59.5	152	8.0	249	10.8	125	5.4	198	6.8
20 x 5	99.1	218	9.9	348	12.7	174	6.3	284	8.4
20 x 10	199	348	12.8	648	22.3	284	8.6	532	15.0
25 x 5	124	253	10.7	413	14.2	204	7.0	338	9.5
30 x 5	149	288	11.6	492	16.9	233	7.6	402	11.3
30 x 10	299	482	17.2	960	32.7	402	11.5	780	21.6
40 x 5	199	348	12.8	648	22.3	284	8.6	532	15.0
40 x 10	399	648	22.7	1245	41.9	532	15.3	1032	28.8
50 x 5	249	413	14.7	805	27.9	338	9.8	655	18.5
50 x 10	499	805	28.5	1560	53.5	660	19.2	1280	36.0
60 x 5	299	492	17.2	960	32.7	402	11.5	780	21.6
60 x 10	599	960	34.1	1848	63.2	780	22.5	1524	43.0
80 x 5	399	648	22.7	1256	42.6	532	15.3	1032	28.8
80 x 10	799	1256	45.8	2432	85.8	1032	30.9	1920	53.5
100 x 5	499	805	29.2	1560	54.8	660	19.6	1280	36.9
100 x 10	999	1560	58.4	2680	86.2	1280	39.3	2180	57.0
120 x 10	1200	1848	68.3	2928	85.7	1524	46.5	2400	57.6

*) one conductor per phase **) two conductors per phase 1) single length

1SDCC008042F0201

Annex B: Temperature rise evaluation according to IEC 60890

Where enclosures without vertical partitions or individual sections have an effective cooling surface greater than about 11.5 m or a width greater than about 1.5 m, they should be divided for the calculation into fictitious sections, whose dimensions approximate to the foregoing values.

The following diagram shows the procedure to evaluate the temperature rise.

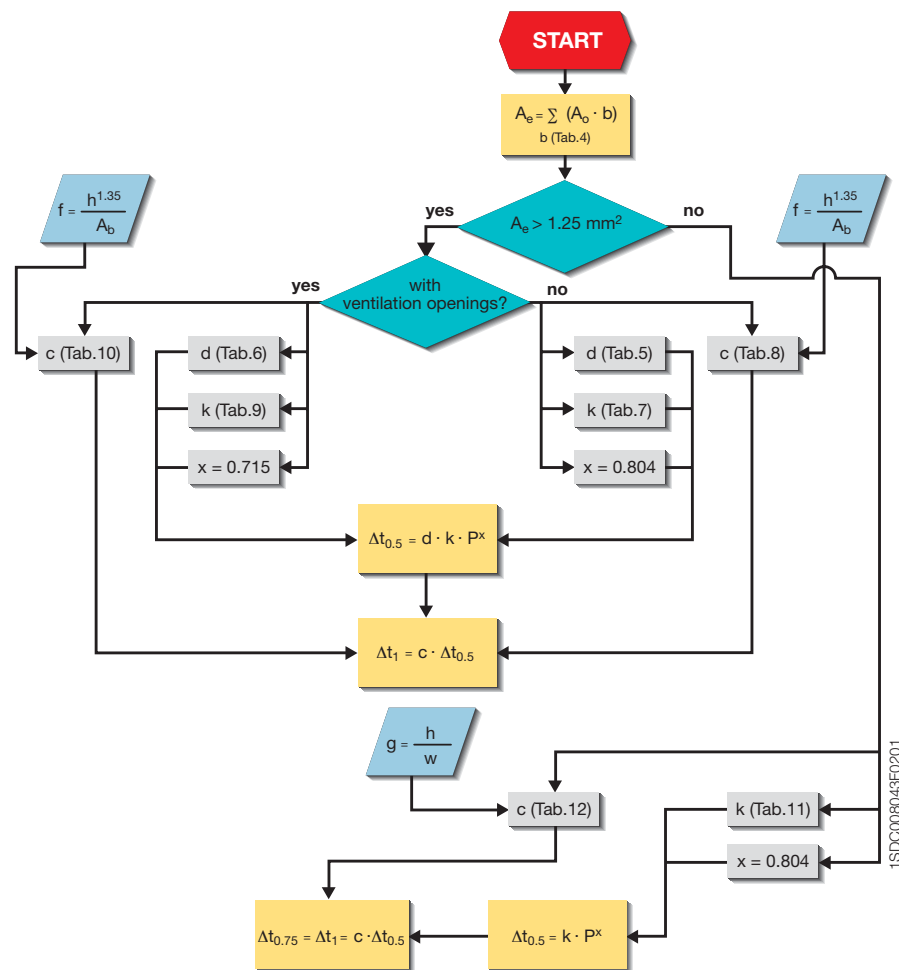

Annex B: Temperature rise evaluation according to IEC 60890

Table 4: Surface factor *b* according to the type of installation

Type of installation	Surface factor <i>b</i>
Exposed top surface	1.4
Covered top surface, e.g. of built-in enclosures	0.7
Exposed side faces, e.g. front, rear and side walls	0.9
Covered side faces, e.g. rear side of wall-mounted enclosures	0.5
Side faces of central enclosures	0.5
Floor surface	Not taken into account

Fictitious side faces of sections which have been introduced only for calculation purposes are not taken into account

Table 5: Factor *d* for enclosures without ventilation openings and with an effective cooling surface *A_e* > 1.25 m²

Number of horizontal partitions <i>n</i>	Factor <i>d</i>
0	1
1	1.05
2	1.15
3	1.3

Table 6: Factor *d* for enclosures with ventilation openings and with an effective cooling surface *A_e* > 1.25 m²

Number of horizontal partitions <i>n</i>	Factor <i>d</i>
0	1
1	1.05
2	1.1
3	1.15

Table 7: Enclosure constant *k* for enclosures without ventilation openings, with an effective cooling surface *A_e* > 1.25 m²

<i>A_e</i> [m ²]	<i>k</i>	<i>A_e</i> [m ²]	<i>k</i>
1.25	0.524	6.5	0.135
1.5	0.45	7	0.13
2	0.35	7.5	0.125
2.5	0.275	8	0.12
3	0.225	8.5	0.115
3.5	0.2	9	0.11
4	0.185	9.5	0.105
4.5	0.17	10	0.1
5	0.16	10.5	0.095
5.5	0.15	11	0.09
6	0.14	11.5	0.085

Annex B: Temperature rise evaluation according to IEC 60890

Table 8: Temperature distribution factor c for enclosures without ventilation openings, with an effective cooling surface $A_e > 1.25 \text{ m}^2$

$f = \frac{h^{1.35}}{A_b}$	Type of installation				
	1	2	3	4	5
0.6	1.225	1.21	1.19	1.17	1.113
1	1.24	1.225	1.21	1.185	1.14
1.5	1.265	1.245	1.23	1.21	1.17
2	1.285	1.27	1.25	1.23	1.19
2.5	1.31	1.29	1.275	1.25	1.21
3	1.325	1.31	1.295	1.27	1.23
3.5	1.35	1.33	1.315	1.29	1.255
4	1.37	1.355	1.34	1.32	1.275
4.5	1.395	1.375	1.36	1.34	1.295
5	1.415	1.395	1.38	1.36	1.32
5.5	1.435	1.415	1.4	1.38	1.34
6	1.45	1.435	1.42	1.395	1.355
6.5	1.47	1.45	1.435	1.41	1.37
7	1.48	1.47	1.45	1.43	1.39
7.5	1.495	1.48	1.465	1.44	1.4
8	1.51	1.49	1.475	1.455	1.415
8.5	1.52	1.505	1.49	1.47	1.43
9	1.535	1.52	1.5	1.48	1.44
9.5	1.55	1.53	1.515	1.49	1.455
10	1.56	1.54	1.52	1.5	1.47
10.5	1.57	1.55	1.535	1.51	1.475
11	1.575	1.565	1.549	1.52	1.485
11.5	1.585	1.57	1.55	1.525	1.49
12	1.59	1.58	1.56	1.535	1.5
12.5	1.6	1.585	1.57	1.54	1.51

where h is the height of the enclosure, and A_b is the area of the base.
For "Type of installation":

	Type of installation n°	
1	Separate enclosure, detached on all sides	
2	First or last enclosure, detached type	
3	Separate enclosure for wall-mounting	
	Central enclosure, detached type	
4	First or last enclosure, wall-mounting type	
	Central enclosure for wall-mounting and with covered top surface	
5	Central enclosure, wall-mounting type	

1SDC00089F0001

Annex B: Temperature rise evaluation according to IEC 60890

Table 9: Enclosure constant k for enclosures with ventilation openings and an effective cooling surface $A_e > 1.25 \text{ m}^2$

Ventilation opening in cm^2	$A_e \text{ [m}^2\text{]}$													
	1	1.5	2	2.5	3	4	5	6	7	8	10	12	14	
50	0.36	0.33	0.3	0.28	0.26	0.24	0.22	0.208	0.194	0.18	0.165	0.145	0.135	
100	0.293	0.27	0.25	0.233	0.22	0.203	0.187	0.175	0.165	0.153	0.14	0.128	0.119	
150	0.247	0.227	0.21	0.198	0.187	0.173	0.16	0.15	0.143	0.135	0.123	0.114	0.107	
200	0.213	0.196	0.184	0.174	0.164	0.152	0.143	0.135	0.127	0.12	0.11	0.103	0.097	
250	0.19	0.175	0.165	0.155	0.147	0.138	0.13	0.121	0.116	0.11	0.1	0.095	0.09	
300	0.17	0.157	0.148	0.14	0.133	0.125	0.118	0.115	0.106	0.1	0.093	0.088	0.084	
350	0.152	0.141	0.135	0.128	0.121	0.115	0.109	0.103	0.098	0.093	0.087	0.082	0.079	
400	0.138	0.129	0.121	0.117	0.11	0.106	0.1	0.096	0.091	0.088	0.081	0.078	0.075	
450	0.126	0.119	0.111	0.108	0.103	0.099	0.094	0.09	0.086	0.083	0.078	0.074	0.07	
500	0.116	0.11	0.104	0.1	0.096	0.092	0.088	0.085	0.082	0.078	0.073	0.07	0.067	
550	0.107	0.102	0.097	0.093	0.09	0.087	0.083	0.08	0.078	0.075	0.07	0.068	0.065	
600	0.1	0.095	0.09	0.088	0.085	0.082	0.079	0.076	0.073	0.07	0.067	0.065	0.063	
650	0.094	0.09	0.086	0.083	0.08	0.077	0.075	0.072	0.07	0.068	0.065	0.063	0.061	
700	0.089	0.085	0.08	0.078	0.076	0.074	0.072	0.07	0.068	0.066	0.064	0.062	0.06	

Table 10: Temperature distribution factor c for enclosures with ventilation openings and an effective cooling surface $A_e > 1.25 \text{ m}^2$

Ventilation opening in cm^2	$f = \frac{h^{1.35}}{A_b}$									
	1.5	2	3	4	5	6	7	8	9	10
50	1.3	1.35	1.43	1.5	1.57	1.63	1.68	1.74	1.78	1.83
100	1.41	1.46	1.55	1.62	1.68	1.74	1.79	1.84	1.88	1.92
150	1.5	1.55	1.63	1.69	1.75	1.8	1.85	1.9	1.94	1.97
200	1.56	1.61	1.67	1.75	1.8	1.85	1.9	1.94	1.97	2.01
250	1.61	1.65	1.73	1.78	1.84	1.88	1.93	1.97	2.01	2.04
300	1.65	1.69	1.75	1.82	1.86	1.92	1.96	2	2.03	2.06
350	1.68	1.72	1.78	1.85	1.9	1.94	1.97	2.02	2.05	2.08
400	1.71	1.75	1.81	1.87	1.92	1.96	2	2.04	2.07	2.1
450	1.74	1.77	1.83	1.88	1.94	1.97	2.02	2.05	2.08	2.12
500	1.76	1.79	1.85	1.9	1.95	1.99	2.04	2.06	2.1	2.13
550	1.77	1.82	1.88	1.93	1.97	2.01	2.05	2.08	2.11	2.14
600	1.8	1.83	1.88	1.94	1.98	2.02	2.06	2.09	2.12	2.15
650	1.81	1.85	1.9	1.95	1.99	2.04	2.07	2.1	2.14	2.17
700	1.83	1.87	1.92	1.96	2	2.05	2.08	2.12	2.15	2.18

Annex B: Temperature rise evaluation according to IEC 60890

Table 11: Enclosure constant k for enclosures without ventilation openings and with an effective cooling surface $A_e \leq 1.25 \text{ m}^2$

$A_e [\text{m}^2]$	k	$A_e [\text{m}^2]$	k
0.08	3.973	0.65	0.848
0.09	3.643	0.7	0.803
0.1	3.371	0.75	0.764
0.15	2.5	0.8	0.728
0.2	2.022	0.85	0.696
0.25	1.716	0.9	0.668
0.3	1.5	0.95	0.641
0.35	1.339	1	0.618
0.4	1.213	1.05	0.596
0.45	1.113	1.1	0.576
0.5	1.029	1.15	0.557
0.55	0.960	1.2	0.540
0.6	0.9	1.25	0.524

Table 12: Temperature distribution factor c for enclosures without ventilation openings and with an effective cooling surface $A_e \leq 1.25 \text{ m}^2$

g	c	g	c
0	1	1.5	1.231
0.1	1.02	1.6	1.237
0.2	1.04	1.7	1.24
0.3	1.06	1.8	1.244
0.4	1.078	1.9	1.246
0.5	1.097	2	1.249
0.6	1.118	2.1	1.251
0.7	1.137	2.2	1.253
0.8	1.156	2.3	1.254
0.9	1.174	2.4	1.255
1	1.188	2.5	1.256
1.1	1.2	2.6	1.257
1.2	1.21	2.7	1.258
1.3	1.22	2.8	1.259
1.4	1.226		

where g is the ratio of the height and the width of the enclosure.

Annex B: Temperature rise evaluation according to IEC 60890

Total (3/4 poles) power loss in W

Releases	T11P		T1		T2		T3		T4		T5		T6		S7		S8
	In[A]	F	F	F	P	F	P	F	P/W	F	P/W	F	W	F	W	F	
	1			4.5	5.1												
	1.6			6.3	7.5												
	2			7.5	8.7												
	2.5			7.8	9												
	3.2			8.7	10.2												
	4			7.8	9												
	5			8.7	10.5												
	6.3			10.5	12.3												
	8			8.1	9.6												
	10			9.3	10.8												
	12.5			3.3	3.9												
	16	1.5	4.5	4.2	4.8												
TMF	20	1.8	5.4	5.1	6				10.8	10.8							
TMD	25	2	6	6.9	8.4												
TMA	32	2.1	6.3	8.1	9.6				11.1	11.1							
MF	40	2.6	7.8	11.7	13.8												
MA	50	3.7	11.1	12.9	15				11.7	12.3							
	63	4.3	12.9	15.3	18	12.9	15.3										
	80	4.8	14.4	18.3	21.6	14.4	17.4	13.8	15								
	100	7	21	25.5	30	16.8	20.4	15.6	17.4								
	125	10.7	32.1	36	44.1	19.8	23.7	18.6	21.6								
	160	15	45	51	60	23.7	28.5	22.2	27								
	200					39.6	47.4	29.7	37.2								
	250					53.4	64.2	41.1	52.8								
	320									40.8	62.7						
	400									58.5	93						
	500									86.4	110.1						
	630											92	117				
	800											93	119				
	10			1.5	1.8												
	25			3	3.6												
	63			10.5	12												
	100			24	27.2			5.1	6.9								
	160			51	60			13.2	18								
PR211	250							32.1	43.8								
PR212	320							52.8	72	31.8	53.7						
PR221	400									49.5	84						
PR222	630									123	160.8	90	115				
PR223	800											96	125				
	1000													150	102	140	
	1250														160	220	
	1600														260	360	
	2000																200
	2500																315
	3200																500

The values indicated in the table refer to balanced loads, with a current flow equal to the In, and are valid for both circuit-breakers and switch-disconnectors, three-pole and four-pole versions. For the latter, the current of the neutral is nil by definition.

Annex B: Temperature rise evaluation according to IEC 60890

Table 14: Emax power losses

Total (3/4 poles) power loss in W	E1B-N		E2B-N-S		E2L		E3N-S-H-V		E3L		E4S-H-V		E6H-V	
	F	W	F	W	F	W	F	W	F	W	F	W	F	W
In=800	65	95	29	53			22	36						
In=1000	96	147	45	83			38	58						
In=1250	150	230	70	130	105	165	60	90						
In=1600	253	378	115	215	170	265	85	150						
In=2000			180	330			130	225	215	330				
In=2500							205	350	335	515				
In=3200							330	570			235	425	170	290
In=4000											360	660	265	445
In=5000													415	700
In=6300													650	1100

Example

Hereunder an example of temperature rise evaluation for a switchboard with the following characteristics:

- enclosure without ventilation openings
- no internal segregation
- separate enclosure for wall-mounting
- one main circuit-breaker
- 5 circuit-breakers for load supply
- busbars and cable systems

Enclosure

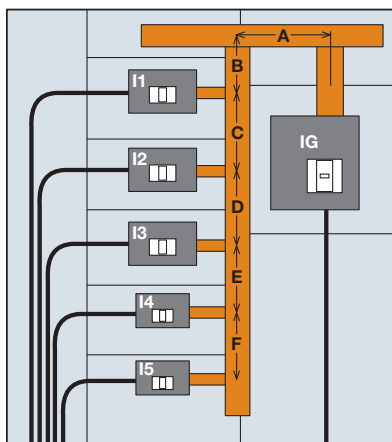

Circuit diagram

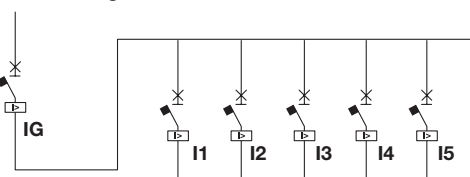

Dimensions [mm]			Number of horizontal partitions = 0
Height	Width	Depth	
2000	1440	840	Separate enclosure for wall-mounting

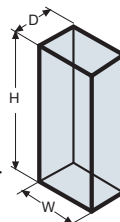

Annex B: Temperature rise evaluation according to IEC 60890

The power losses from each component of the above switchboard are evaluated hereunder.

For the circuit-breakers, the power losses are calculated as $P = P_n \left(\frac{I_b}{I_n}\right)^2$, with I_n and P_n given in the Tables 14 and 15.

The table below shows the values relevant to each circuit-breaker of the switchboard in question:

Circuit-breakers	In CB [A]	Ib [A]	Power losses [W]
IG	E2 1600 EL	1600	1340
I1	T5 400 EL	400	330
I2	T5 400 EL	400	330
I3	T5 400 EL	400	330
I4	T3 250 TMD	250	175
I5	T3 250 TMD	250	175
Total power loss of circuit-breakers [W]			234

For the busbars, the power losses are calculated as $P = P_n \left(\frac{I_b}{I_n}\right)^2 \cdot (3 \cdot \text{Length})$ with I_n and P_n given in the Table 2.

The table below shows the power losses of busbars:

Busbars	Cross-section nx[mm]x[mm]	Length [m]	Ib [A]	Power losses [W]
A	2x60x10	0.393	1340	47.2
B	80x10	0.332	1340	56
C	80x10	0.300	1010	28.7
D	80x10	0.300	680	13
E	80x10	0.300	350	3.5
F	80x10	0.300	175	0.9
Total power loss of busbars [W]				149

For the bare conductors connecting the busbars to the circuit-breakers, the power losses are calculated as $P = P_n \left(\frac{I_b}{I_n}\right)^2 \cdot (3 \cdot \text{Length})$, with I_n and P_n given in the Table 2. Here below the values for each section:

Connection bare conductors	Cross-section nx[mm]x[mm]	Length [m]	Ib [A]	Power losses [W]
Ig	2x60x10	0.450	1340	54
I1	30x10	0.150	330	3.8
I2	30x10	0.150	330	3.8
I3	30x10	0.150	330	3.8
I4	20x10	0.150	175	1.6
I5	20x10	0.150	175	1.6
Total power loss of bare conductors [W]				68

Annex B: Temperature rise evaluation according to IEC 60890

For the cables connecting the circuit-breakers to the supply and the loads, the power losses are calculated as $P = P_n \left(\frac{I_b}{I_n} \right)^2 \cdot (3 \cdot \text{Length})$, with I_n and P_n given in the Table 4.

Here below the power losses for each connection:

Cables	Cross-section [n]xmm ²	Length [m]	I _b [A]	Power losses [W]
I _G	4x240	1.0	1340	133.8
I ₁	240	2.0	330	64.9
I ₂	240	1.7	330	55.2
I ₃	240	1.4	330	45.4
I ₄	120	1.1	175	19
I ₅	120	0.8	175	13.8
Total power loss of cables [W]				332

Thus, the total power loss inside the enclosure is: **P = 784 [W]**

From the geometrical dimensions of the switchboard, the effective cooling surface A_e is determined below:

	Dimensions[m]x[m]	A ₀ [m ²]	b factor	A ₀
Top	0.840x1.44	1.21	1.4	1.69
Front	2x1.44	1.64	0.9	2.59
Rear	2x1.44	1.64	0.5	1.44
Left-hand side	2x0.840	1.68	0.9	1.51
Right-hand side	2x0.840	1.68	0.9	1.51
A_e=Σ(A₀·b)				8.75

Making reference to the procedure described in the diagram at page 294, it is possible to evaluate the temperature rise inside the switchboard.

Annex B: Temperature rise evaluation according to IEC 60890

From Table 7, k results 0.112 (value interpolated)

Since $x = 0.804$, the temperature rise at half the height of the enclosure is:

$$\Delta t_{0,5} = d \cdot k \cdot P^x = 1 \cdot 0.112 \cdot 784^{0.804} = 23.8 \text{ K}$$

For the evaluation of the temperature rise at the top of the enclosure, it is necessary to determine the c factor by using the f factor:

$$f = \frac{h^{1.35}}{A_b} = \frac{21.35}{1.44 \cdot 0.84} = 2.107 \quad (A_b \text{ is the base area of the switchboard})$$

From Table 8, column 3 (separate enclosure for wall-mounting), c results to be equal to 1.255 (value interpolated).

$$\Delta t_1 = c \cdot \Delta t_{0,5} = 1.255 \cdot 23.8 = 29.8 \text{ K}$$

Considering 35°C ambient temperature, as prescribed by the Standard, the following temperatures shall be reached inside the enclosure:

$$t_{0,5} = 35 + 23.8 \approx 59^\circ\text{C}$$

$$t_1 = 35 + 29.8 \approx 65^\circ\text{C}$$

Assuming that the temperature derating of the circuit-breakers inside the switchboard can be compared to the derating at an ambient temperature different from 40°C, through the tables of Chapter 3.5, it is possible to verify if the selected circuit-breakers can carry the required currents:

$$E2 \text{ 1600 at } 65^\circ\text{C} \quad I_n=1538[\text{A}] > I_g = 1340 [\text{A}]$$

$$T5 \text{ 400 at } 65^\circ\text{C} \quad I_n=384 [\text{A}] > I_1 = I_2 = I_3 = 330 [\text{A}]$$

$$T3 \text{ 250 at } 60^\circ\text{C} \quad I_n=216 [\text{A}] > I_4 = I_5 = 175 [\text{A}]$$

Annex C: Application examples Advanced protection functions with PR123 release

Dual Setting

Thanks to the new PR123 release, it is possible to program two different sets of parameters and, through an external command, to switch from one set to the other.

This function is useful when there is an emergency source (generator) in the system, only supplying voltage in the case of a power loss on the network side.

Example:

In the system described below, in the case of a loss of the normal supply on the network side, by means of ABB SACE ATSO10 automatic transfer switch, it is possible to switch the supply from the network to the emergency power unit and to disconnect the non-primary loads by opening the QS1 switch-disconnector.

Under normal service conditions of the installation, the circuit-breakers C are set in order to be selective with both circuit-breaker A, on the supply side, as well as with circuit-breakers D on the load side.

By switching from the network to the emergency power unit, circuit-breaker B becomes the reference circuit-breaker on the supply side of circuit-breakers C. This circuit-breaker, being the protection of a generator, must be set to trip times shorter than A and therefore the setting values of the circuit-breakers on the load side might not guarantee the selectivity with B.

By means of the “dual setting” function of the PR123 release, it is possible to switch circuit-breakers C from a parameter set which guarantees selectivity with A, to another set which makes them selective with B.

However, these new settings could make the combination between circuit-breakers C and the circuit-breakers on the load side non-selective.

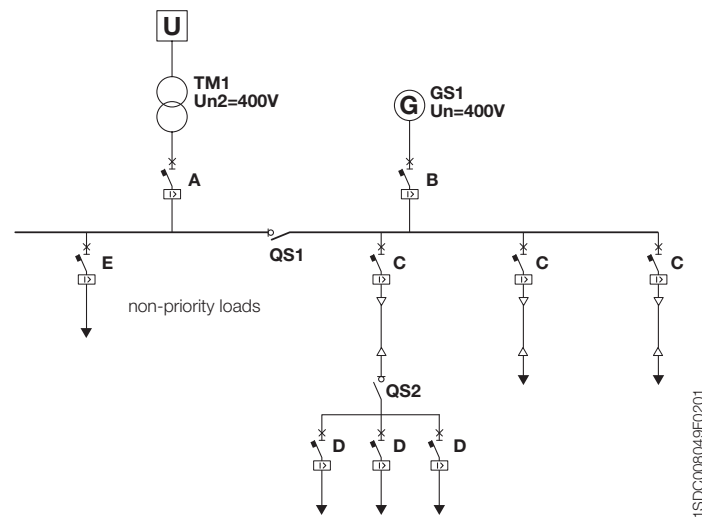

Annex C: Application examples Advanced protection functions with PR123 release

The figure at the side shows the time-current curves of the installation under normal service conditions. The values set allow no intersection of the curves.

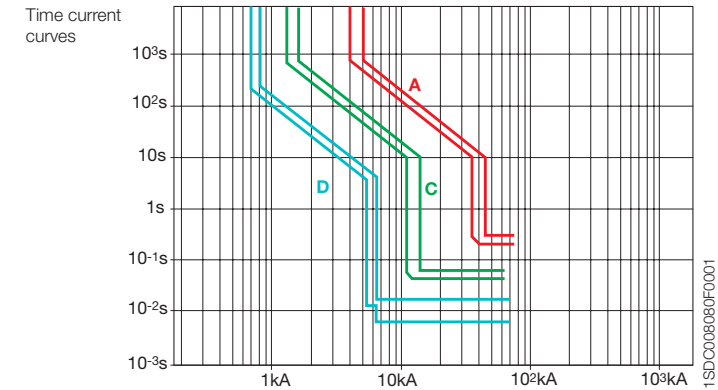

The figure at the side shows the situation in which, after switching, the power is supplied by the power unit through circuit-breaker B. If the settings of circuit-breakers C are not modified, there will be no selectivity with the main circuit-breaker B.

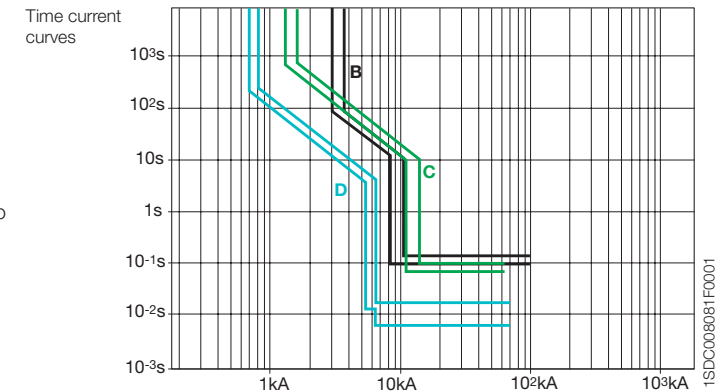

This last figure shows how it is possible to switch to a set of parameters which guarantees selectivity of circuit-breakers C with B by means of the “dual setting” function.

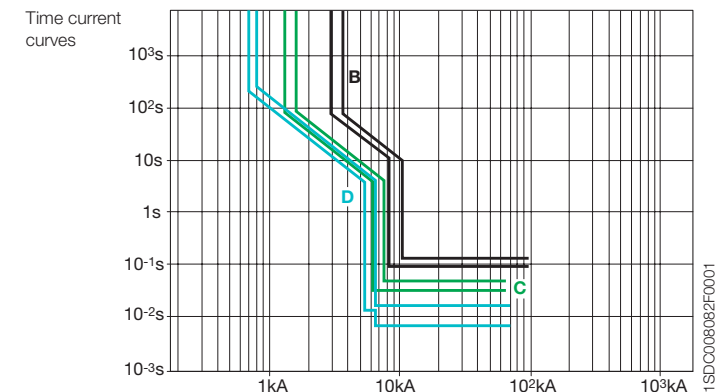

Annex C: Application examples

Advanced protection functions with PR123 release

Double G

The Emax type circuit-breakers, equipped with the PR123 electronic release, allow two independent curves for protection G:

- one for the internal protection (function G without external toroid);
- one for the external protection (function G with external toroid)

A typical application of function double G consists in simultaneous protection both against earth fault of the secondary of the transformer and of its connection cables to the circuit-breaker terminals (restricted earth fault protection), as well as against earth faults on the load side of the circuit-breaker (outside the restricted earth fault protection).

Example:

Figure 1 shows a fault on the load side of an Emax circuit-breaker: the fault current flows through one phase only and, if the vectorial sum of the currents detected by the four current transformers (CTs) results to be higher than the set threshold, the electronic release activates function G (and the circuit-breaker trips).

Figure 1

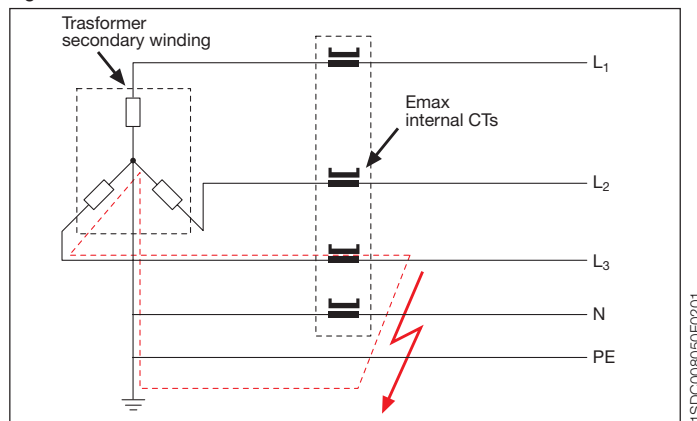

1SDC008050F0201

Annex C: Application examples

Advanced protection functions with PR123 release

With the same configuration, a fault on the supply side of the circuit-breaker (Figure 2) does not cause intervention of function G since the fault current does not affect either the CT of the phase or that of the neutral.

Figure 2

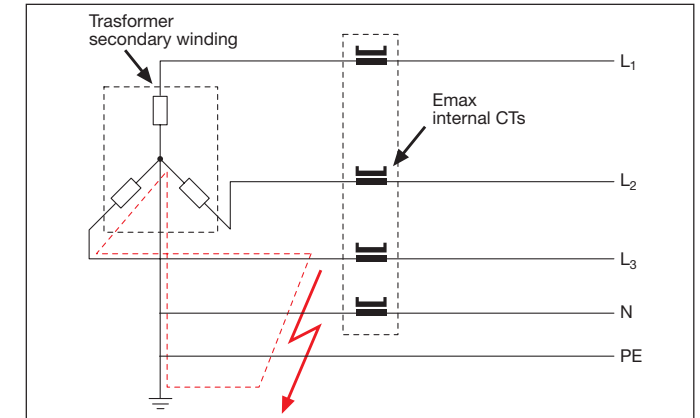

1SDC008051F0201

The use of function "double G" allows installation of an external toroid, as shown in Figure 3, so that earth faults on the supply side of Emax CB can be detected as well. In this case, the alarm contact of the second G is exploited in order to trip the circuit-breaker installed on the primary and to ensure fault disconnection.

Figure 3

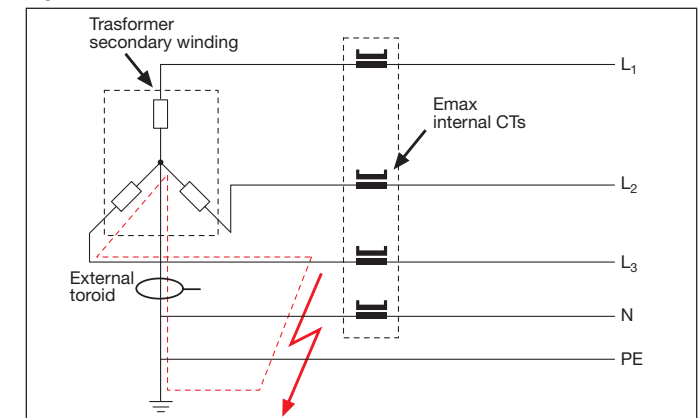

1SDC008052F0201

Annex C: Application examples

Advanced protection functions with PR123 release

If, with the same configuration as Figure 3, the fault occurs on the load side of the Emax circuit-breaker, the fault current would affect both the toroid as well as the current transformers on the phases. To define which circuit-breaker is to trip (MV or LV circuit-breaker), suitable coordination of the trip times is required: in particular, it is necessary to set the times so that LV circuit-breaker opening due to internal function G is faster than realization of the alarm signal coming from the external toroid. Therefore, thanks to the time-current discrimination between the two G protection functions, before the MV circuit-breaker on the primary of the transformer receives the trip command, the circuit-breaker on the LV side is able to eliminate the earth fault. Obviously, if the fault occurred on the supply side of the LV circuit-breaker, only the circuit-breaker on the MV side would trip.

The table shows the main characteristics of the range of toroids (available only in the closed version).

Characteristics of the toroid ranges

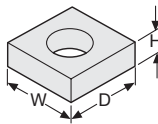
Rated current	100 A, 250 A, 400 A, 800 A
Outer dimensions of the toroid	
	W = 165 mm
	D = 160 mm
	H = 112 mm
Internal diameter of the toroid	Ø = 112 mm

1SDC008063F0201

Annex C: Application examples

Advanced protection functions with PR123 release

Double S

Thanks to the new PR123 release, which allows two thresholds of protection function S to be set independently and be activated simultaneously, selectivity can also be achieved under highly critical conditions.

Here is an example of how, by using the new release, it is possible to obtain a better selectivity level compared with the use of a release without "double S". This is the wiring diagram of the system under examination; in particular, attention must be focussed on:

- the presence, on the supply side, of a MV circuit-breaker, which, for selectivity reasons, imposes low setting values for the Emax circuit-breaker on the LV side
- the presence of a LV/LV transformer which, due to the inrush currents, imposes high setting values for the circuit-breakers on its primary side

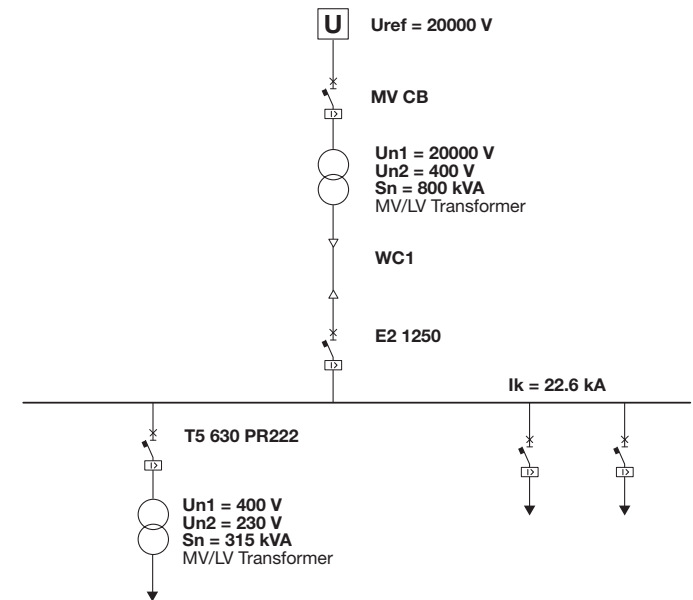

1SDC008064F0201

Annex C: Application examples Advanced protection functions with PR123 release

Solution with a release without “double S”

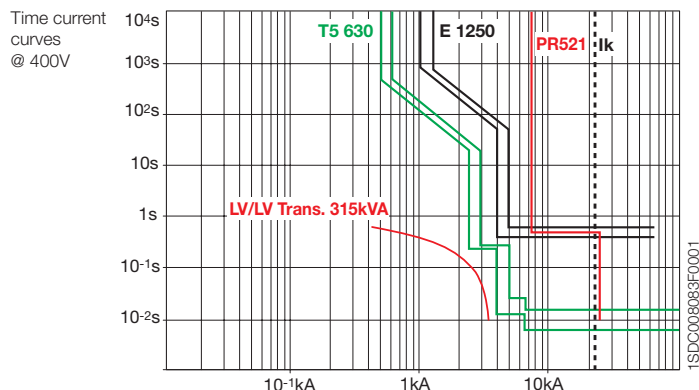

MV CB (PR521)

50	(I>): 50A	t=0.5s
51	(I>>): 500A	t=0s

		E2N 1250 PR122 LSIG R1250	T5V 630 PR222DS/P LSIG R630
L	Setting	0.8	0.74
	Curve	108s	12s
S t=constant	Setting	3.5	4.2
	Curve	0.5s	0.25s
I	Setting	OFF	7

In the case of a short-circuit, the Emax E2 circuit-breaker and the MV circuit-breaker will open simultaneously with this solution. Attention must be paid to the fact that, owing to the value Ik, function I of the E2 circuit-breaker has to be disabled (I3=OFF) so that selectivity with the T5 on the load side is guaranteed.

Annex C: Application examples Advanced protection functions with PR123 release

Solution with the PR123 release with “double S”

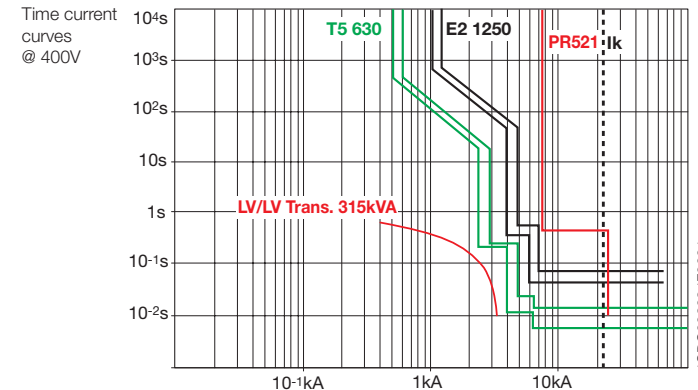

MV CB (PR521)

50	(I>): 50A	t=0.5s
51	(I>>): 500A	t=0s

		E2N 1250 PR123 LSIG R1250	T5V 630 PR222DS/P LSIG R630
L	Setting	0.8	0.74
	Curve	108s	12s
S t=constant	Setting	3.5	4.2
	Curve	0.5s	0.25s
S2 t=constant	Setting	5	-
	Curve	0.05s	-
I	Setting	OFF	7

As evident, by means of the “double S” function, selectivity can be achieved both with the T5 circuit-breaker on the load side as well as with the MV circuit-breaker on the supply side.

A further advantage obtained by using the “double S” function is the reduction in the time of permanence of high current values under short-circuit conditions, which results in lower thermal and dynamic stresses on the busbars and on the other installation components.



Due to possible developments of standards as well as of materials, the characteristics and dimensions specified in this document may only be considered binding after confirmation by ABB SACE.

1SDC008001D0203 06/05
Printed in Italy

ABB SACE S.p.A.
An ABB Group Company
L.V. Breakers
Via Baioni, 35
24123 Bergamo - Italy
Tel.: +39 035.395.111 - Telefax: +39 035.395.306-433

<http://www.abb.com>