

Rüdiger Ganslandt
Born in 1955. Studied German, Art and the History of Art in Aachen, Germany. Member of the project team on 'imaginary architecture'. Book publications on topics relating to sciences and humanities, article on lighting design. Joined Erco in 1987, work on texts and didactic concepts. Lives in Lüdenscheid, Germany.

Harald Hofmann
Born in 1941 in Worms, Germany. Studied Electrical Engineering at Darmstadt University of Technology from 1961 to 1968. Gained a doctorate in 1975. Worked as an educator and researcher in the Lighting Technology department at Darmstadt University of Technology until 1978. Joined Erco in 1979 as Head of Lighting Technology. Professor of Lighting Technology in the Faculty of Architecture at the Darmstadt University of Technology since 1997.

Title	Handbook of Lighting Design
Authors	Rüdiger Ganslandt Harald Hofmann
Layout and graphic design	otl aicher and Monika Schnell
Drawings	otl aicher Reinfriede Bettrich Peter Graf Druckhaus Maack
Reproduction	Druckhaus Maack, Lüdenscheid OffsetReproTechnik, Berlin Reproservice Schmidt, Kempten
Setting/printing	Druckhaus Maack, Lüdenscheid
Book binding	C. Fikentscher Großbuchbinderei Darmstadt

© ERCO Leuchten GmbH, Lüdenscheid
Friedr. Vieweg & Sohn Verlagsgesellschaft mbH, Braunschweig/Wiesbaden
1. edition 1992

The Vieweg publishing company is a Bertelsmann International Group company.

All rights reserved. No part of this publication may be reproduced in any form or by any means without permission from the publisher. This applies in particular to (photo)copying, translations, microfilms and saving or processing in electronic systems.

Printed in Germany

Rüdiger Ganslandt
Harald Hofmann

Handbook of Lighting Design

ERCO Edition

About this book

Wide interest has developed in light and lighting, not least because the growing awareness of architectural quality has given rise to an increased demand for good architectural lighting. Standardised lighting concepts may have sufficed to light the concrete architecture of the recent past, but the varied and distinctive architecture of modern-day buildings requires equally differentiated and distinctive lighting.

An extensive range of light sources and luminaires are available for this task; with technical progress the scope of lighting technology has expanded, and this has in turn led to the development of increasingly more specialised lighting equipment and tools. It is this fact that makes it increasingly difficult for the lighting designer to be adequately informed regarding the comprehensive range of lamps and luminaires available and to decide on the correct technical solution to meet the lighting requirements of a specific project.

The Handbook of Lighting Design covers the basic principles and practice of architectural lighting. It exists as much as a teaching aid, e.g. for students of architecture, as a reference book for lighting designers. The Handbook does not intend to compete with the existing comprehensive range of specialist literature on lighting engineering, nor to be added to the limited number of beautifully illustrated volumes containing finished projects. The Handbook aims to approach and deal with the subject of architectural lighting in a practical

and comprehensible manner. Background information is provided through a chapter dedicated to the history of lighting. The second part of the Handbook deals with the basics of lighting technology and surveys light sources, control gear and luminaires available. The third part deals with concepts, strategies and the processes involved in lighting design. In the fourth part there is a comprehensive collection of design concepts for the most frequent requirements of interior lighting. The glossary, index and bibliography provided to assist users of this Handbook in their daily work facilitate the search for information or further literature.

Contents

Foreword

- 1.0 History
- 1.1 The history of architectural lighting 12
 - 1.1.1 Daylight architecture 12
 - 1.1.2 Artificial lighting 13
 - 1.1.3 Science and lighting 15
 - 1.1.4 Modern light sources 16
 - 1.1.4.1 Gas lighting 17
 - 1.1.4.2 Electrical light sources 18
 - 1.1.5 Quantitative lighting design 22
 - 1.1.6 Beginnings of a new age kind lighting design 22
 - 1.1.6.1 The influence of stage lighting 24
 - 1.1.6.2 Qualitative lighting design 24
 - 1.1.6.3 Lighting engineering and lighting design 25
- 2.0 Basics
- 2.1 Perception 28
 - 2.1.1 Eye and camera 28
 - 2.1.2 Perceptual psychology 29
 - 2.1.2.1 Constancy 31
 - 2.1.2.2 Laws of gestalt 33
 - 2.1.3 Physiology of the eye 36
 - 2.1.4 Objects of peception 38
- 2.2 Terms and units 40
 - 2.2.1 Luminous flux 40
 - 2.2.2 Luminous efficacy 40
 - 2.2.3 Quantity of light 40
 - 2.2.4 Luminous intensity 40
 - 2.2.5 Illuminance 42
 - 2.2.6 Exposure 42
 - 2.2.7 Luminance 42
- 2.3 Light and light sources 43
 - 2.3.1 Incandescent lamps 45
 - 2.3.1.1 Halogen lamps 49
 - 2.3.2 Discharge lamps 52
 - 2.3.2.1 Fluorescent lamps 53
 - 2.3.2.2 Compact fluorescent lamps 54
 - 2.3.2.3 High-voltage fluorescent tubes 55
 - 2.3.2.4 Low-pressure sodium lamps 56
 - 2.3.2.5 High-pressure mercury lamps 57
 - 2.3.2.6 Self-ballasted mercury lamps 58
 - 2.3.2.7 Metal halide lamps 59
 - 2.3.2.8 High-pressure sodium lamps 60
- 2.4 Control gear and control equipment 65
 - 2.4.1 Control gear for discharge lamps 65
 - 2.4.1.1 Fluorescent lamps 65
 - 2.4.1.2 Compact fluorescent lamps 66
 - 2.4.1.3 High-voltage fluorescent tubes 66
 - 2.4.1.4 Low-pressure sodium lamps 66
 - 2.4.1.5 High-pressure mercury lamps 66
 - 2.4.1.6 Metal halide lamps 67
 - 2.4.1.7 High-pressure sodium lamps 67
 - 2.4.2 Compensation and wiring of discharge lamps 67
 - 2.4.3 Radio-interference suppression and limiting other interference 67
 - 2.4.4 Transformers for low-voltage installations 68
 - 2.4.5 Controlling brightness 71
 - 2.4.5.1 Incandescent and halogen lamps 71

2.4.5.2	Low-voltage halogen lamps	71
2.4.5.3	Fluorescent lamps	71
2.4.5.4	Compact fluorescent lamps	72
2.4.5.5	Other discharge lamps	72
2.4.6	Remote control	72
2.4.7	Lighting control systems	72
2.4.7.1	Lighting control systems for theatrical effects	73
2.5	Light – qualities and features	74
2.5.1	Quantity of light	74
2.5.2	Diffuse light and directed light	76
2.5.2.1	Modelling	77
2.5.2.2	Brilliance	78
2.5.3	Glare	79
2.5.4	Luminous colour and colour rendering	83
2.6	Controlling light	85
2.6.1	The principles of controlling light	85
2.6.1.1	Reflection	85
2.6.1.2	Transmission	85
2.6.1.3	Absorption	87
2.6.1.4	Refraction	87
2.6.1.5	Interference	87
2.6.2	Reflectors	88
2.6.2.1	Parabolic reflectors	89
2.6.2.2	Darklight reflectors	90
2.6.2.3	Spherical reflectors	90
2.6.2.4	Involute reflectors	90
2.6.2.5	Elliptical reflectors	90
2.6.3	Lens systems	91
2.6.3.1	Collecting lenses	91
2.6.3.2	Fresnel lenses	91
2.6.3.3	Projecting systems	91
2.6.4	Prismatic systems	92
2.6.5	Accessories	92
2.7	Luminaires	94
2.7.1	Stationary luminaires	94
2.7.1.1	Downlights	94
2.7.1.2	Uplights	97
2.7.1.3	Louvred luminaires	97
2.7.1.4	Washlights	100
2.7.1.5	Integral luminaires	101
2.7.2	Movable luminaires	102
2.7.2.1	Spotlights	102
2.7.2.2	Wallwashers	103
2.7.3	Light structures	104
2.7.4	Secondary reflector luminaires	105
2.7.5	Fibre optic systems	105
3.0	Lighting design	
3.1	Lighting design concepts	110
3.1.1	Quantitative lighting design	110
3.1.2	Luminance-based design	112
3.1.3	The principles of perception-oriented lighting design	115
3.1.3.1	Richard Kelly	115
3.1.3.2	William Lam	117
3.1.3.3	Architecture and atmosphere	118
3.2	Qualitative lighting design	119
3.2.1	Project analysis	119
3.2.1.1	Utilisation of space	119
3.2.1.2	Psychological requirements	122
3.2.1.3	Architecture and atmosphere	122

3.2.2	Project development	123
3.3	Practical planning	126
3.3.1	Lamp selection	126
3.3.1.1	Modelling and brilliance	127
3.3.1.2	Colour rendering	127
3.3.1.3	Luminous colour and colour temperature	128
3.3.1.4	Luminous flux	128
3.3.1.5	Efficiency	128
3.3.1.6	Brightness control	130
3.3.1.7	Ignition and re-ignition	130
3.3.1.8	Radiant and thermal load	130
3.3.2	Luminaire selection	132
3.3.2.1	Standard product or custom design	132
3.3.2.2	Integral or additive lighting	132
3.3.2.3	Stationary or movable lighting	136
3.3.2.4	General lighting or differentiated lighting	136
3.3.2.5	Direct or indirect lighting	136
3.3.2.6	Horizontal and vertical lighting	138
3.3.2.7	Lighting working areas and floors	138
3.3.2.8	Wall lighting	139
3.3.2.9	Ceiling lighting	141
3.3.2.10	Luminance limitation	141
3.3.2.11	Safety requirements	143
3.3.2.12	Relation to acoustics and air conditioning	143
3.3.2.13	Accessories	143
3.3.2.14	Lighting control and theatrical effects	144
3.3.3	Lighting layout	144
3.3.4	Switching and lighting control	150
3.3.5	Installation	152
3.3.5.1	Ceiling mounting	152
3.3.5.2	Wall and floor mounting	154
3.3.5.3	Suspension systems	154
3.3.6	Calculations	154
3.3.6.1	Utilisation factor method	154
3.3.6.2	Planning based on specific connected load	157
3.3.6.3	Point illuminance	158
3.3.6.4	Lighting costs	159
3.3.7	Simulation and presentation	160
3.3.8	Measuring lighting installations	168
3.3.9	Maintenance	169
4.0	Examples of lighting concepts	
4.1	Foyers	173
4.2	Lift lobbies	180
4.3	Corridors	184
4.4	Staircases	188
4.5	Team offices	192
4.6	Cellular offices	198
4.7	Executive offices	203
4.8	Conference rooms	207
4.9	Auditoriums	213
4.10	Canteens	217
4.11	Cafés, bistros	221
4.12	Restaurants	225
4.13	Multifunctional spaces	229
4.14	Museums, showcases	236
4.15	Museum, galleries	241
4.16	Vaulted ceilings	249
4.17	Sales areas, boutiques	252
4.18	Sales areas, counters	256
4.19	Administration buildings, public areas	259
4.20	Exhibitions	264
5.0	Appendix	
	Illuminance recommendations	270
	Classification of lamps	271
	Glossary	272, bibliography 282, acknowledgements 286, index 287

1.0

History

1.1

The history of architectural lighting

1.1 History 1.1.1 Daylight architecture

For the most part of the history of mankind, from the origins of man up to the 18. century, there were basically two sources of light available. The older one of these two is daylight, the medium by which we see and to whose properties the eye has adapted over millions of years. A considerable time elapsed before the stone age, with its development of cultural techniques and tools, added the flame as a second, artificial light source. From this time on lighting conditions remained the same for a considerable time. The paintings in the cave of Altamira were created to be viewed under the same light as Renaissance and Baroque paintings.

Lighting was limited to daylight and flame and it was for this very reason that man has continued to perfect the application of these two light sources for tens of thousands of years.

1.1.1 Daylight architecture

In the case of daylight this meant consistently adapting architecture to the requirements for lighting with natural light. Entire buildings and individual rooms were therefore aligned to the incidence of the sun's rays. The size of the rooms was also determined by the availability of natural lighting and ventilation. Different basic types of daylight architecture developed in conjunction with the lighting conditions in the various climatic zones of the globe. In cooler regions with a predominantly overcast sky we see the development of buildings with large, tall windows to allow as much light into the building as possible. It was found that diffuse celestial light produced uniform lighting; the problems inherent to bright sunshine – cast shadow, glare and overheating of interior spaces – were restricted to a few sunny days in the year and could be ignored.

In countries with a lot of sunshine these problems are critical. A majority of the buildings here have small windows located in the lower sections of the buildings and the exterior walls are highly reflective. This means that hardly any direct sunlight can penetrate the building. Even today the lighting is effected in the main by the light reflected from the building's surfaces, the light being dispersed in the course of the reflection process and a large proportion of its infrared component dissipated.

When it came to the question of whether there was sufficient light, aspects relating to aesthetic quality and perceptual psychology were also taken into account when dealing with daylight, which is evident in the way architectural details are treated. Certain elements were designed differently according to the light available to promote the required spatial effect through the interplay of light and shadow. In direct sunlight reliefs, ledges and the

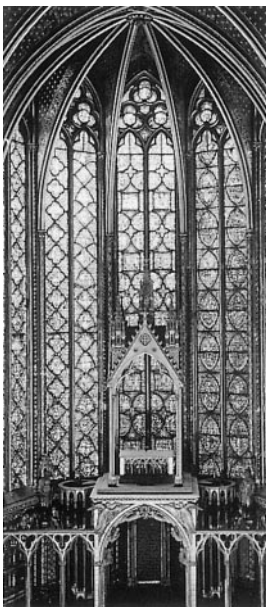

Daylight architecture:
large, tall windows.



Sunlight architecture:
small, low windows,
reflective outer walls.

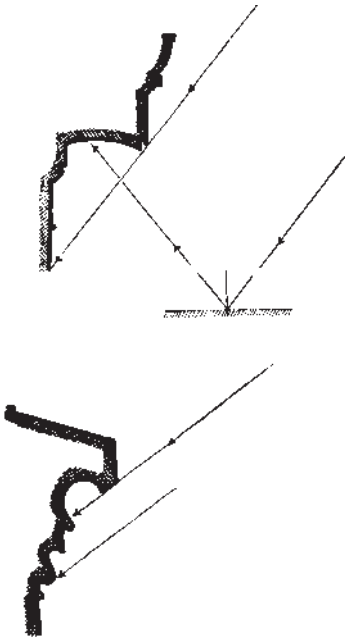

The influence of light on northern and southern architectural design. In the south spatial forms are aligned to the correlation of the steep angle of incident sun-light and light reflected from the ground. In the north it is the low angle of the sun's rays that affects the shape of the buildings.

fluting on columns have a three-dimensional effect even if they are of shallow depth. Such details require far more depth under diffuse light to achieve the same effect. Facades in southern countries therefore only needed shallow surface structures, whereas the architecture of more northern latitudes – and the design of interior spaces – was dependent on more pronounced forms and accentuation through colour to underline the structure of surfaces.

But light does not only serve to render spatial bodies three-dimensional. It is an excellent means for controlling our perception on a psychological level. In old Egyptian temples – e.g. in the sun temple of Amun Re in Karnak or in Abu Simbel – you will not find light in the form of uniform ambient lighting, but as a means to accentuate the essential – colonnades that gradually become darker allow the viewer to adapt to lower lighting levels, the highlighted image of the god then appearing overwhelmingly bright in contrast. An architectural construction can function similar to an astronomical clock, with special lighting effects only occurring on significant days or during particular periods in the year, when the sun rises or sets, or at the summer or the winter solstice.

In the course of history the skill to create purposefully differentiated daylighting effects has been continually perfected, reaching a climax in the churches of the Baroque period, – e.g. the pilgrimage church in Birnau or the pilgrimage church designed by Dominikus Zimmermann in Upper Bavaria – , where the visitor's gaze is drawn from the diffuse brightness of the nave towards the brightly lit altar area, where intricate wood carvings decorated in gold sparkle and stand out in relief.

1.1.2 Artificial lighting

A similar process of perfection also took place in the realm of artificial lighting, a development that was clearly confined by the inadequate luminous power provided by the light sources available.

The story began when the flame, the source of light, was separated from fire, the source of warmth - burning branches were removed from the fire and used for a specific purpose. It soon became obvious that it was an advantage to select pieces of wood that combust and emit light particularly well, and the branch was replaced by especially resinous pine wood. The next step involved not only relying on a natural feature of the wood, but, in the case of burning torches, to apply flammable material to produce more light artificially. The development of the oil lamp and the candle meant that man then had compact, relatively safe light sources at his disposal; select fuels were used eco-

Oil lamp made of brass

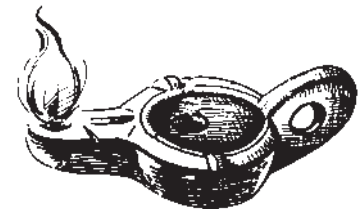

Greek oil lamp, a mass item in the ancient world

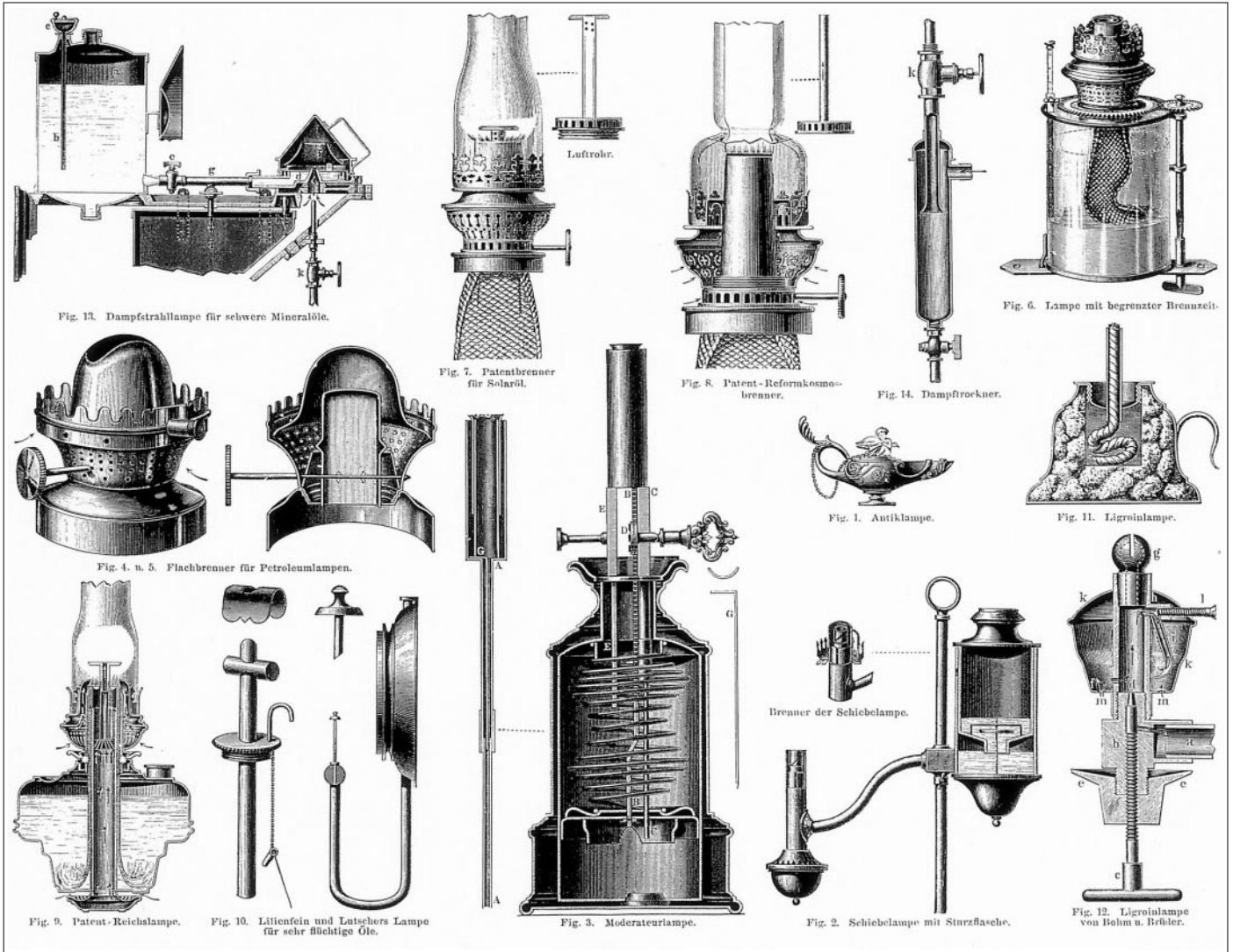

Lamps and burners dating back to the second half of the 19th century, copper engraving. Based on the construction of the Argand burner, the oil lamp was adapted through numerous technical innovations to meet a wide variety of requirements. The differences between lamps with flat wicks and those with the more efficient tubular wicks are clearly evident. In later paraffin lamps the light fuel

was transported to the flame via the capillary action of the wick alone, earlier lamps that used thick-bodied vegetable oils required more costly fuel supply solutions involving upturned glass bottles or spring mechanisms. In the case of especially volatile or thick-bodied oils there were special wickless lamps available that produced combustible gaseous mixtures through the inherent vapour pressure produced by the volatile oil or by external compression.

nomically in these cases, the torch holder was reduced to the wick as a means of transport for wax or oil.

The oil lamp, which was actually developed in prehistoric times, represented the highest form of lighting engineering progress for a very long time. The lamp itself – later to be joined by the candlestick – continued to be developed. All sorts of magnificent chandeliers and sconces were developed in a wide variety of styles, but the flame, and its luminous power, remained unchanged.

Compared to modern day light sources this luminous power was very poor, and artificial lighting remained a makeshift device. In contrast to daylight, which provided excellent and differentiated lighting for an entire space, the brightness of a flame was always restricted to its direct environment. People gathered around the element that provided light or positioned it directly next to the object to be lit. Light, albeit weak, began to mark man's night-time. To light interiors brightly after dark required large numbers of expensive lamps and fixtures, which were only conceivable for courtly gatherings. Up to the late 18th century architectural lighting as we know it today remained the exclusive domain of day-lighting.



Paraffin lamp with Argand burner.

1.1.3 Science and lighting

The reason why the development of efficient artificial light sources experienced a period of stagnation at this point in time lies in man's inadequate knowledge in the field of science. In the case of the oil lamp, it was due to man's false conception of the combustion process. Until the birth of modern chemistry, the belief laid down by the ancient Greeks was taken to be true: during the burning process a substance called "phlogistos" was released. According to the Greeks, any material that could be burned therefore consisted of ash and phlogistos (the classical elements of earth and fire), which were separated during the burning process – phlogistos was released as a flame, earth remained in the form of ash.

It is clear that the burning process could not be optimised as long as beliefs were based on this theory. The role of oxidation had not yet been discovered. It was only through Lavoisier's experiments that it became clear that combustion was a form of chemical action and that the flame was dependent on the presence of air.

Lavoisier's experiments were carried out in the 1770s and in 1783 the new findings were applied in the field of lighting. Francois Argand constructed a lamp that was to be named after him, the Argand lamp. This was an oil lamp with a tubular wick, whereby air supply to the flame was effected from within the tube as well as from the outer surface of the wick.

Improved oxygen supply together with an enlarged wick surface meant a huge and instantaneous improvement in luminous efficiency. The next step involved surrounding wick and flame with a glass cylinder, whereby the chimney effect resulted in an increased through-put of air and a further increase in efficiency. The Argand lamp became the epitome of the oil lamp. Even modern day paraffin lamps work according to this perfected principle.

Optical instruments have been recognised as aids to controlling light from very early times. Mirrors are known to have been used by ancient Greeks and Romans and the theory behind their application set down in writing. There is a tale about Archimedes setting fire to enemy ships off Syracuse using concave mirrors. And there are stories of burning glasses, in the form of water-filled glass spheres.

At the turn of the first millennium, there were a number of theoretical works in Arabia and China concerning the effect of optical lenses. There is in fact concrete evidence of these lenses dating from the 13th century. They were predominantly used in the form of magnifying glasses or spectacles as a vision aid. The material first used was ground beryl. This costly semi-precious stone was later replaced by glass, manufactured to a sufficiently clear quality. The German word for glasses is "Brille", demonstrating a clear semantic link to the original material used for the vision aid.

In the late 16th century the first telescopes were designed by Dutch lens grinders. In the 17th century these instruments were then perfected by Galileo, Kepler and Newton; microscopes and projector equipment were then constructed.

At the same time, some basic theories about the nature of light originated. Newton held the view that light was made up of numerous particles – a view that can be retraced to ancient time. Huygens, on the other hand, saw light as a phenomenon comprising waves. The two competing theories are substantiated by a series of optical phenomena and existed side by side. Today it is clear that light can neither be understood as a purely particle or wave-based phenomenon, but only through an understanding of the combination of both ideas.

With the development of photometrics – the theory of how to measure light – and illuminances – through Boguer and Lambert in the 18th century, the most essential scientific principles for workable lighting engineering were established. The application of these various correlated findings was restricted practically exclusively to the construction of optical instruments such as the telescope and the microscope, to instruments therefore that allow man to observe, and are dependent on external light sources. The active control of light using reflectors and lenses, known to be theoretically possible and



Christiaan Huygens.



Isaac Newton.

occasionally tested, was doomed to fail due to the shortcomings of the light sources available.

In the field of domestic lighting the fact that there was no controllable, centrally situated light available was not considered to be a concern. It was compensated for by family gatherings around the oil lamp in the evenings. This shortcoming gave rise to considerable problems in other areas, however. For example, in lighting situations where a considerable distance between the light source and the object to be lit was required, above all, therefore, in street lighting and stage lighting, and in the area of signalling, especially in the construction of lighthouses. It was therefore not surprising that the Argand lamp, with its considerably improved luminous intensity not only served to light living-rooms, but was welcomed in the above-mentioned critical areas and used to develop systems that control light.

This applied in the first place to street and stage lighting, where the Argand lamp found application shortly after its development. But the most important use was for lighthouses, which had previously been poorly lit by coal fires or by using a large number of oil lamps. The proposal to light lighthouses using systems comprising Argand lamps and parabolic mirrors was made in 1785; six years later the idea was used in France's most prominent lighthouse in Cordouan. In 1820 Augustin Jean Fresnel developed a composite system of stepped lens and prismatic rings which could be made large enough to concentrate the light from lighthouses; this construction was also first installed in Cordouan. Since then Fresnel lenses have been the basis for all lighthouse beacons and have also been applied in numerous types of projectors.

Beacon with Fresnel lenses and Argand burners.

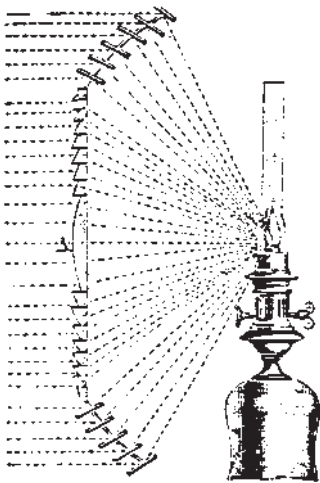
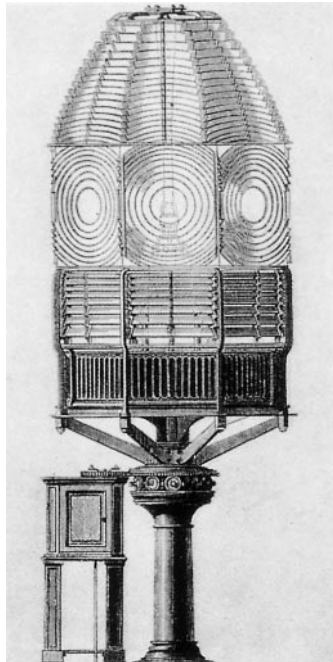

Fresnel lenses and Argand burners. The inner section of the luminous beam is concentrated via a stepped lens, the outer section deflected by means of separate prismatic rings.

1.1.4 Modern light sources

The Argand lamp marked the climax of a development which lasted tens of thousands of years, perfecting the use of the flame as a light source. The oil lamp at its very best, so to speak. Scientific progress, which rendered this latter development possible, gave rise to the development of completely new light sources, which revolutionised lighting engineering at an increasingly faster pace.

Augustin Jean Fresnel.



1.1 History
 1.1.4 Modern light sources

1.1.4.1 Gas lighting

The first competitor to the Argand lamp was gas lighting. People had known of the existence of combustible gases since the 17th century, but gaseous substances were first systematically understood and produced within the framework of modern chemistry. A process for recovering lighting gas from mineral coal was developed in parallel to the Argand lamp experimentation.

Towards the end of the 18th century the efficiency of gas lighting was demonstrated in a series of pilot projects – a lecture hall in Löwen lit by Jan Pieter Minckellaers; a factory, a private home and even an automobile lit by the English engineer William Murdoch. This new light source achieved as yet unknown illuminance levels. It was, however, not yet possible to introduce this new form of lighting on a large scale due to the costs involved in the manufacture of the lighting gas and in removing the admittedly foul-smelling residues. A number of small devices were developed, so-called thermo-lamps, which made it possible to produce gas for lighting and heating in individual households. These devices did not prove to be as successful as hoped. Gas lighting only became an economic proposition with the coupling of coke recovery and gas production, then entire sections of towns could benefit from central gas supply. Street lighting was the first area to be connected to a central gas supply, followed gradually by public buildings and finally private households.

As is the case with all other light sources a series of technical developments made gas lighting increasingly more efficient. Similar to the oil lamp a variety of different burners were developed whose increased flame sizes provided increased luminous intensity. The Argand principle involving the ring-shaped flame with its oxygen supply from both sides could also be applied in the case of gas lighting and in turn led to unsurpassed luminous efficacy.

The attempt to produce a surplus of oxygen in the gas mixture by continuing to develop the Argand burner produced a surprising result. As all the carbon contained in the gas was burned off to produce gaseous carbon dioxide, the glowing particles of carbon that incorporated the light produced by the flame were no longer evident; this gave rise to the extraordinarily hot, but barely glowing flame of the Bunsen burner. There was therefore a limit to the luminous intensity of self-luminous flames; for further increases in efficiency researchers had to fall back on other principles to produce light.

One possibility for producing highly efficient gas lighting was developed through the phenomenon of thermo-luminescence, the excitation of luminescent material by



Lighting shop windows using gas light (around 1870).

Carl Auer v. Welsbach.

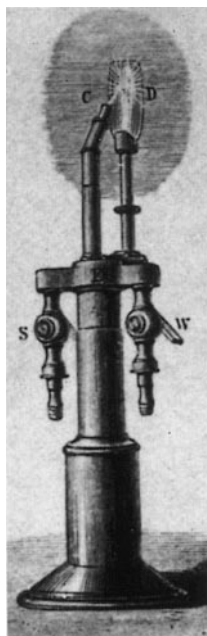

Drummond's limelight.

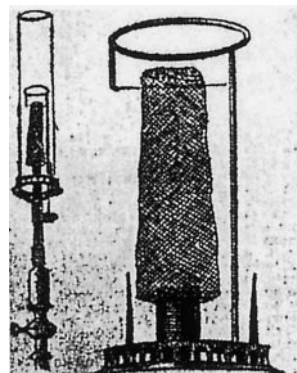

The incandescent mantle as invented by Auer v. Welsbach.

1.1 History
 1.1.4 Modern light sources

heating. In contrast to thermal radiation, luminous efficacy and colour appearance in this process were not solely dependent on the temperature, but also on the kind of material; more and whiter light was produced using temperature radiation methods.

The first light source to work according to this principle was Drummond's limelight, which was developed in 1826. This involved a piece of limestone being excited to a state of thermo-luminescence with the aid of an oxy-hydrogen burner. Limelight is admittedly very effective, but requires considerable manual control with the result that it was used almost exclusively for effect lighting in the theatre. It was only in 1890 that Austrian chemist Carl Auer von Welsbach came up with a far more practical method for utilising thermo-luminescence. Auer von Welsbach steeped a cylinder made of cotton fabric in a solution containing rare earths – substances that, similar to limestone, emit a strong white light when heated. These incandescent mantles were applied to Bunsen burners. On first ignition the cotton fabric burned, leaving behind nothing but the rare earths – the incandescent mantle in effect. Through the combination of the extremely hot flame of the Bunsen burner and incandescent mantles comprising rare earths, the optimum was achieved in the field of gas lighting. Just as the Argand lamp continues to exist today in the form of the paraffin lamp, the incandescent or Welsbach mantle is still used for gas lighting, e.g. in camping lamps.



Jablotschkow's version of the arc lamp, exposed and with glass bulb.

Hugo Bremer's arc lamp. A simple spring mechanism automatically controls the distance between the four carbon electrodes set in the shape of a V.

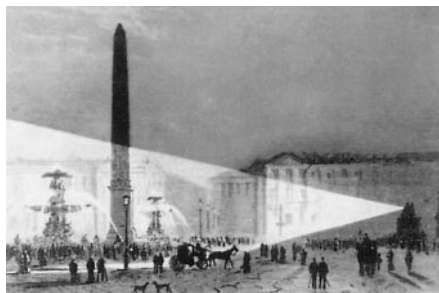

Arc lighting at the Place de la Concorde.

1.1.4.2 Electrical light sources

Incandescent gas light was doomed to go the way of most lighting discoveries that were fated to be overtaken by new light sources just as they are nearing perfection. This also applies to the candle, which only received an optimised wick in 1824 to prevent it from smoking too much. Similarly, the Argand lamp was pipped at the post by the development of gas lighting, and for lighting using incandescent mantles, which in turn had to compete with the newly developed forms of electric light.

In contrast to the oil lamp and gas lighting, which both started life as weak light sources and were developed to become ever more efficient, the electric lamp embarked on its career in its brightest form. From the beginning of the 19th century it was a known fact that by creating voltage between two carbon electrodes an extremely bright arc could be produced. Similar to Drummond's limelight, continuous manual adjustment was required, making it difficult for this new light source to gain acceptance, added to the fact that arc lamps first had to be operated on batteries, which was a costly business.

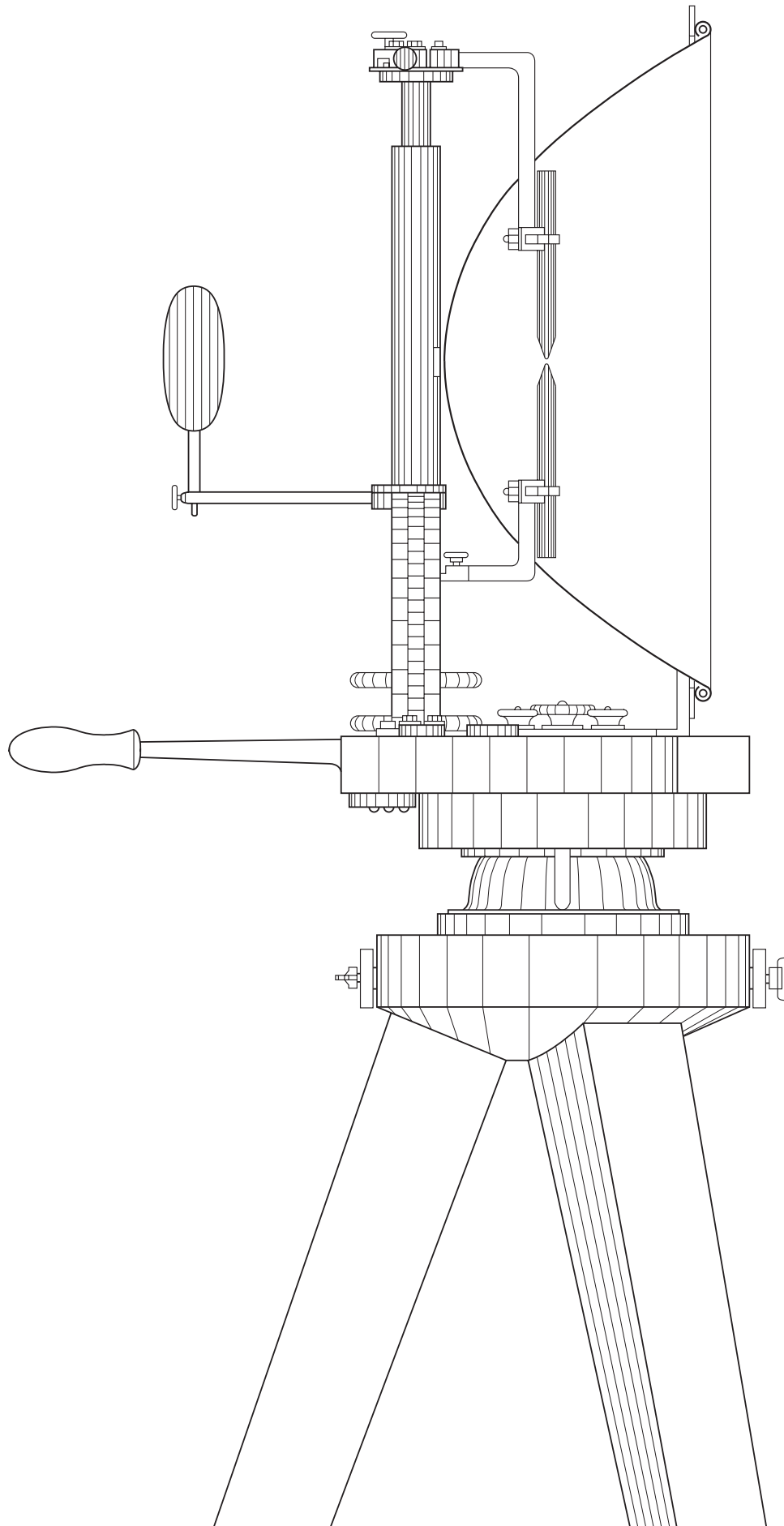

Siemens' arc lamp dating back to 1868. According to the description: an adjustable spotlight complete with "concave mirror, carriage, stand and anti-dazzle screen" – the oldest luminaire in Siemens' archives documented in the form of a drawing.

1.1 History
 1.1.4 Modern light sources



Heinrich Goebel, experimental incandescent lamps (carbon filaments in air-void eau-de-cologne bottles).

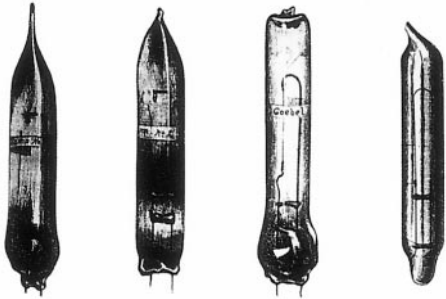

Joseph Wilson Swan, Swan's version of the incandescent lamp with graphite filament and spring base.

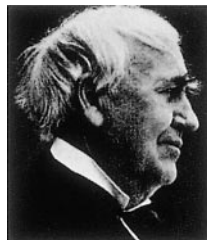
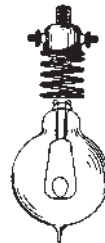
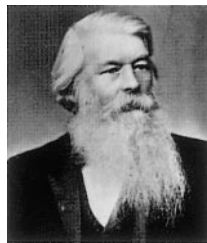

Thomas Alva Edison, Edison lamps, platinum and carbon filament version, as yet without the typical screw cap.

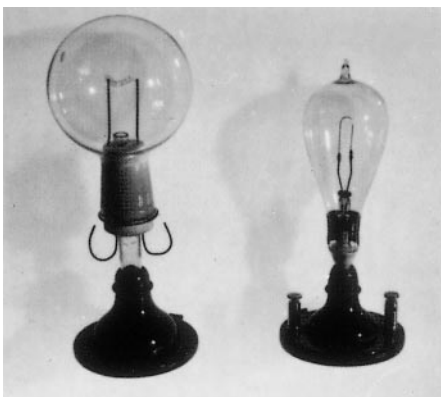

About mid-century self-adjusting lamps were developed, thereby eliminating the problem of manual adjustment. Generators that could guarantee a continuous supply of electricity were now also available. It was, however, still only possible to operate one arc lamp per power source; series connection – "splitting the light", as it was called – was not possible, as the different burning levels of the individual lamps meant that the entire series was quickly extinguished. This problem was only solved in the 1870s. The simple solution was provided by Jablotschkow's version of the arc lamp, which involved two parallel carbon electrodes set in a plaster cylinder and allowed to burn simultaneously from the top downwards. A more complex, but also more reliable solution was provided by the differential lamp, developed in 1878 by Friedrich v. Hefner-Alteneck, a Siemens engineer, whereby carbon supply and power constancy were effected via an electromagnetic system.

Now that light could be "divided up" the arc lamp became an extremely practical light source, which not only found individual application, but was also used on a wide scale. It was in fact applied wherever its excellent luminous intensity could be put to good use – once again in lighthouses, for stage lighting; and, above all, for all forms of street and exterior lighting. The arc lamp was not entirely suitable for application in private homes, however, because it tended to produce far too much light – a novelty in the field of lighting technology. It would take other forms of electric lighting to replace gas lighting in private living spaces.

It was discovered at a fairly early stage, that electrical conductors heat up to produce a sufficiently great resistance, and even begin to glow; in 1802 – eight years before his spectacular presentation of the first arc lamp – Humphrey Davy demonstrated how he could make a platinum wire glow by means of electrolysis.

The incandescent lamp failed to establish itself as a new light source for technical reasons, much the same as the arc lamp. There were only a few substances that had a melting point high enough to create incandescence before melting. Moreover, the high level of resistance required very thin filaments, which were difficult to produce, broke easily and burnt up quickly in the oxygen in the air.

First experiments made with platinum wires or carbon filaments did not produce much more than minimum service life. The life time could only be extended when the filament – predominantly made of carbon or graphite at that time – was prevented from burning up by surrounding it with a glass bulb, which was either evacuated or filled with inert gas. Pioneers in this field were Joseph Wilson Swan, who preceded Edison by six months with his graphite lamp, but above

1.1 History

1.1.4 Modern light sources

all Heinrich Goebel, who in 1854 produced incandescent lamps with a service life of 220 hours with the aid of carbonized bamboo fibres and air-void eau-de-cologne bottles.

The actual breakthrough, however, was indeed thanks to Thomas Alva Edison, who in 1879 succeeded in developing an industrial mass product out of the experimental constructions created by his predecessors. This product corresponded in many ways to the incandescent lamp as we know it today – right down to the construction of the screw cap. The filament was the only element that remained in need of improvement. Edison first used Goebel's carbon filament comprising carbonized bamboo. Later synthetic carbon filaments extruded from cellulose nitrate were developed. The luminous efficacy, always the main weakness of incandescent lamps, could, however, only be substantially improved with the changeover to metallic filaments. This is where Auer von Welsbach, who had already made more efficient gas lighting possible through the development of the incandescent mantle, comes into his own once again. He used osmium filaments derived through a laborious sintering process. The filaments did not prove to be very stable, however, giving way to tantalum lamps, which were developed a little later and were considerably more robust. These were in turn replaced by lamps with filaments made of tungsten, a material still used for the filament wire in lamps today.

Following the arc lamp and the incandescent lamp, discharge lamps took their place as the third form of electric lighting. Again physical findings were available long before the lamp was put to any practical use. As far back as the 17th century there were reports about luminous phenomena in mercury barometers. But it was Humphrey Davy once again who gave the first demonstration of how a discharge lamp worked. In fact, at the beginning of the 18th century Davy examined all three forms of electric lighting systematically. Almost eighty years passed, however, before the first truly functioning discharge lamps were actually constructed, and it was only after the incandescent lamp had established itself as a valid light source, that the first discharge lamps with the prime purpose of producing light were brought onto the market. This occurred around the turn of the century. One of these was the Moore lamp – a forerunner of the modern-day high voltage fluorescent tube. It consisted of long glass tubes of various shapes and sizes, high voltage and a pure gas discharge process. Another was the low-pressure mercury lamp, which is the equivalent of the fluorescent lamp as we know it today, except that it had no fluorescent coating.

Cooper-Hewitt's low-pressure mercury lamp. This lamp worked much like a modern-day fluorescent tube but did not contain any fluorescent material, so only very little visible light was produced. The lamp was mounted in the centre like a scale beam, because it was ignited by tipping the tubes by means of a drawstring.

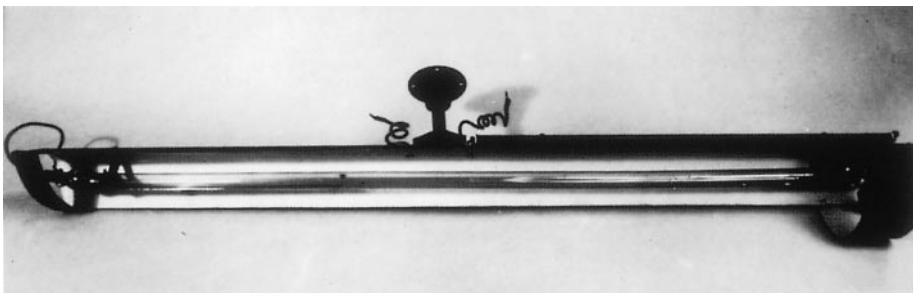

Theatre foyer lit by Moore lamps.





American light tower
(San José 1885).

The Moore lamp – like the high-voltage fluorescent tube today – was primarily used for contour lighting in architectural spaces and for advertising purposes; its luminous intensity was too low to be seriously used for functional lighting. The mercury vapour lamp, on the other hand, had excellent luminous efficacy values, which immediately established it as a competitor to the relatively inefficient incandescent lamp. Its advantages were, however, outweighed by its inadequate colour rendering properties, which meant that it could only be used for simple lighting tasks.

There were two completely different ways of solving this problem. One possibility was to compensate for the missing spectral components in the mercury vapour discharge process by adding luminous substances. The result was the fluorescent lamp, which did produce good colour rendering and offered enhanced luminous efficacy due to the exploitation of the considerable ultra-violet emission.

The other idea was to increase the pressure by which the mercury vapour was discharged. The result was moderate colour rendering, but a considerable increase in luminous efficacy. Moreover, this meant that higher light intensities could be achieved, which made the high-pressure mercury lamp a competitor to the arc lamp.

1.1.5 Quantitative lighting design

A good hundred years after scientific research into new light sources began all the standard lamps that we know today had been created, at least in their basic form. Up to this point in time, sufficient light had only been available during daylight hours. From now on, artificial light changed dramatically. It was no longer a temporary expedient but a form of lighting to be taken seriously, ranking with natural light.

Illuminance levels similar to those of daylight could technically now be produced in interior living and working spaces or in exterior spaces, e.g. for the lighting of streets and public spaces, or for the floodlighting of buildings. Especially in the case of street lighting, the temptation to turn night into day and to do away with darkness altogether was great. In the United States a number of projects were realised in which entire towns were lit by an array of light towers. Floodlighting on this scale soon proved to have more disadvantages than advantages due to glare problems and harsh shadows. The days of this extreme form of exterior lighting were therefore numbered.

Both the attempt to provide comprehensive street lighting and the failure of these attempts was yet another phase in the application of artificial light. Whereas

1.1 History

1.1.5 Quantitative lighting design

1.1.6 Beginnings of new lighting design

inadequate light sources had been the main problem to date, lighting specialists were then faced with the challenge of purposefully controlling excessive amounts of light. Specialist engineers started to think about how much light was to be required in which situations and what forms of lighting were to be applied.

Task lighting in particular was examined in detail to establish how great an influence illuminance and the kind of lighting applied had on productivity. The result of these perceptual physiological investigations was a comprehensive work of reference that contained the illuminance levels required for certain visual tasks plus minimum colour rendering qualities and glare limitation requirements.

Although this catalogue of standards was designed predominantly as an aid for the planning of lighting for workplaces, it soon became a guideline for lighting in general, and even today determines lighting design in practice. As a planning aid it is almost exclusively quantity-oriented and should, therefore, not be regarded as a comprehensive planning aid for all possible lighting tasks. The aim of standards is to manage the amount of light available in an economic sense, based on the physiological research that had been done on human visual requirements.

The fact that the perception of an object is more than a mere visual task and that, in addition to a physiological process, vision is also a psychological process, was disregarded. Quantitative lighting design is content with providing uniform ambient lighting that will meet the requirements of the most difficult visual task to be performed in the given space, while at the same time adhering to the standards with regard to glare limitation and colour distortion. How we see architecture, for instance, under a given light, whether its structure is clearly legible and its aesthetic quality has been enhanced by the lighting, goes beyond the realm of a set of rules.

1.1.6 Beginnings of a new kind of lighting design

It was, therefore, not surprising that alongside quantitative lighting technology and planning a new approach to designing with light was developed, an approach that was related far more intensely to architectural lighting and its inherent requirements.

This developed in part within the framework of lighting engineering as it was known. Joachim Teichmüller, founder of the Institute for Lighting Technology in Karlsruhe, is a name that should be mentioned here. Teichmüller defined the term "Lichtarchitektur" as architecture that

1.1 History

1.1.6 Beginnings of new lighting design

conceives light as a building material and incorporates it purposefully into the overall architectural design. He also pointed out – and he was the first to do so – that, with regard to architectural lighting, artificial light can surpass daylight, if it is applied purposefully and in a differentiated way.

Lighting engineers still tended to practise a quantitative lighting philosophy. It was the architects who were now beginning to develop new concepts for architectural lighting. From time immemorial, daylight had been the defining agent. The significance of light and shadow and the way light can structure a building is something every architect is familiar with. With the development of more efficient artificial light sources, the knowledge that has been gained of daylight technology was now joined by the scope offered by artificial light. Light no longer only had an effect coming from outside into the building. It could light interior spaces, and now even light from inside outwards. When Le Corbusier described architecture as the “correct and magnificent play of masses brought together in light”, this no longer only applied to sunlight, but also included the artificially lit interior space.

This new understanding of light had special significance for extensively glazed facades, which were not only openings to let daylight into the building, but gave the architecture a new appearance at night through artificial light. A German style of architecture known as “Gläserne Kette” in particular interpreted the building as a crystalline, self-luminous creation. Utopian ideas of glass architecture, luminous cities dotted with light towers and magnificent glazed structures, à la Paul Scheerbarth, were reflected in a number of equally visionary designs of sparkling crystals and shining domes. A little later, in the 1920s, a number of glass architecture concepts were created; large buildings such as industrial plants or department stores took on the appearance of self-illuminating structures after dark, their facades divided up via the interchange of dark wall sections and light glazed areas. In these cases, lighting design clearly went far beyond the mere creation of recommended illuminances. It addressed the structures of the lit architecture. And yet even this approach did not go far enough, because it regarded the building as a single entity, to be viewed from outside at night, and disregarded users of the building and their visual needs.

Buildings created up to the beginning of the second world war were therefore characterised by what is, in part, highly differentiated exterior lighting. All this, however, made little difference to the trend towards quantitative, unimaginative interior lighting, involving in the main standard louvred fittings.

Joachim Teichmüller.

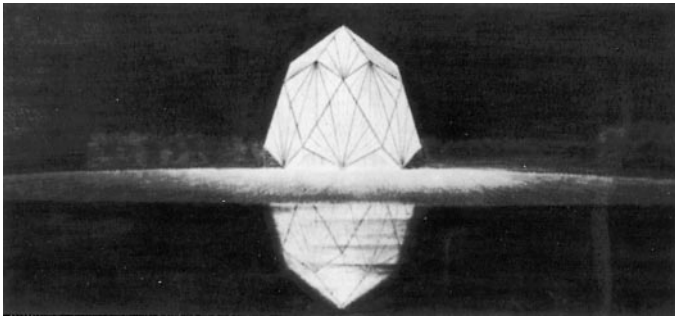

Wassili Luckhardt (1889–1972): Crystal on the sphere. Cult building. Second version. Crayon, around 1920.

J. Brinkmann, L. C. van der Vlugt and Mart Stam: Van Nelle tobacco factory, Rotterdam 1926–30.



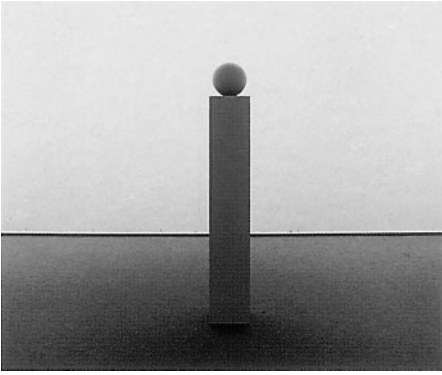

Ambient light.

In order to develop more far-reaching architectural lighting concepts, man had to become the third factor alongside architecture and light. Perceptual psychology provided the key. In contrast to physiological research, it was not simply a question of the quantitative limiting values for the perception of abstract "visual tasks". Man as a perceiving being was the focus of the research, the question of how reality perceived is reconstructed in the process of seeing. These investigations soon led to evidence that perception was not purely a process of reproducing images, not a photographing of our environment. Innumerable optical phenomena proved that perception involves a complex interpretation of surrounding stimuli, that eye and brain constructed rather than reproduced an image of the world around us.

In view of these findings lighting acquired a totally new meaning. Light was no longer just a physical quantity that provided sufficient illumination; it became a decisive factor in human perception. Lighting was not only there to render things and spaces around us visible, it determined the priority and the way individual objects in our visual environment were seen.

1.1.6.1 The influence of stage lighting

Lighting technology focussing on man as a perceptive being acquired a number of essential impulses from stage lighting. In the theatre, the question of illuminance levels and uniform lighting is of minor importance. The aim of stage lighting is not to render the stage or any of the technical equipment it comprises visible; what the audience has to perceive is changing scenes and moods – light alone can be applied on the same set to create the impression of different times of day, changes in the weather, frightening or romantic atmospheres.

Stage lighting goes much further in its intentions than architectural lighting does – it strives to create illusions, whereas architectural lighting is concerned with rendering real structures visible. Nevertheless stage lighting serves as an example for architectural lighting. It identifies methods of producing differentiated lighting effects and the instruments required to create these particular effects – both areas from which architectural lighting can benefit. It is therefore not surprising that stage lighting began to play a significant role in the development of lighting design and that a large number of well-known lighting designers have their roots in theatre lighting.

1.1.6.2 Qualitative lighting design

A new lighting philosophy that no longer confined itself exclusively to quantitative

aspects began to develop in the USA after the second world war. One of the pioneers in the field is without doubt Richard Kelly, who integrated existing ideas from the field of perceptual psychology and stage lighting to create one uniform concept.

Kelly broke away from the idea of uniform illuminance as the paramount criterion of lighting design. He substituted the issue of quantity with the issue of different qualities of light, of a series of functions that lighting had to meet to serve the needs of the perceiver. Kelly differentiated between three basic functions: ambient light, focal glow and play of brilliance.

Ambient light corresponded to what had up to then been termed quantitative lighting. General lighting was provided that was sufficient for the perception of the given visual tasks; these might include the perception of objects and building structures, orientation within an environment or orientation while in motion.

Focal glow went beyond this general lighting and allowed for the needs of man as a perceptive being in the respective environment. Focal glow picked out relevant visual information against a background of ambient light; significant areas were accentuated and less relevant visual information took second place. In contrast to uniform lighting, the visual environment was structured and could be perceived quickly and easily. Moreover, the viewer's attention could be drawn towards individual objects, with the result that focal glow not only contributed towards orientation, but could also be used for the presentation of goods and aesthetic objects.

Play of brilliance took into account the fact that light does not only illuminate objects and express visual information, but that it could become an object of contemplation, a source of information, in itself. In this third function light could also enhance an environment in an aesthetic sense – play of brilliance from a simple candle flame to a chandelier could lend a prestigious space life and atmosphere.

These three basic lighting categories provided a simple, but effective and clearly structured range of possibilities that allowed lighting to address the architecture and the objects within an environment as well as the perceptual needs of the users of the space. Starting in the USA, lighting design began to change gradually from a purely technical discipline to an equally important and indispensable discipline in the architectural design process – the competent lighting designer became a recognised partner in the design team, at least in the case of large-scale, prestigious projects.

1.1.6.3 Lighting engineering and lighting design

The growing demand for quality lighting design was accompanied by the demand for quality lighting equipment. Differentiated lighting required specialised luminaires designed to cope with specific lighting tasks. You need completely different luminaires to achieve uniform wash-light over a wall area, for example, than you do for accentuating one individual object, or different ones again for the permanent lighting in a theatre foyer than for the variable lighting required in a multi-purpose hall or exhibition space.

The development of technical possibilities and lighting application led to a productive correlation: industry had to meet the designers' demands for new luminaires, and further developments in the field of lamp technology and luminaire design were promoted to suit particular applications required by the lighting designers.

New lighting developments served to allow spatial differentiation and more flexible lighting. Exposed incandescent and fluorescent lamps were replaced by a variety of specialised reflector luminaires, providing the first opportunity to direct light purposefully into certain areas or onto objects – from the uniform lighting of extensive surfaces using wall or ceiling washers to the accentuation of a precisely defined area by means of reflector spot-lights. The development of track lighting opened up further scope for lighting design, because it allowed enormous flexibility. Lighting installations could be adapted to meet the respective requirements of the space.

Products that allowed spatial differentiation were followed by new developments that offered time-related differentiation: lighting control systems. With the use of compact control systems it has become possible to plan lighting installations that not only offer one fixed application, but are able to define a range of light scenes. Each scene can be adjusted to suit the requirements of a particular situation. This might be the different lighting conditions required for a podium discussion or for a slide show, but it might also be a matter of adapting to changes within a specific environment: the changing intensity of daylight or the time of day. Lighting control systems are therefore a logical consequence of spatial differentiation, allowing a lighting installation to be utilised to the full – a seamless transition between individual scenes, which is simply not feasible via manual switching.

There is currently considerable research and development being undertaken in the field of compact light sources: among the incandescents the halogen lamp, whose sparkling, concentrated light provides new concepts for display lighting. Similar qualities are achieved in the field

of discharge lamps with metal halide sources. Concentrated light can be applied effectively over larger distances. The third new development is the compact fluorescent lamp, which combines the advantages of the linear fluorescent with smaller volume, thereby achieving improved optical control, ideally suited to energy-efficient fluorescent downlights, for example.

All this means that lighting designers have a further range of tools at their disposal for the creation of differentiated lighting to meet the requirements of the specific situation and the perceptual needs of the people using the space. It can be expected in future that progress in the field of lighting design will depend on the continuing further development of light sources and luminaires, but above all on the consistent application of this 'hardware' in the interest of qualitative lighting design. Exotic solutions – using equipment such as laser lighting or lighting using huge reflector systems – will remain isolated cases and will not become part of general lighting practice.

Focal glow.

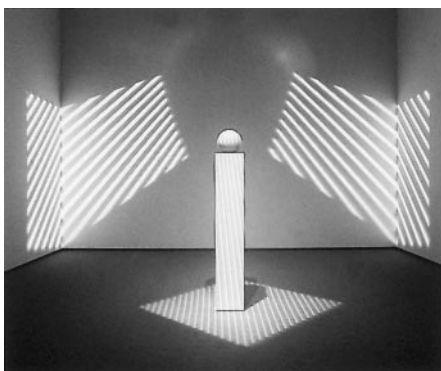
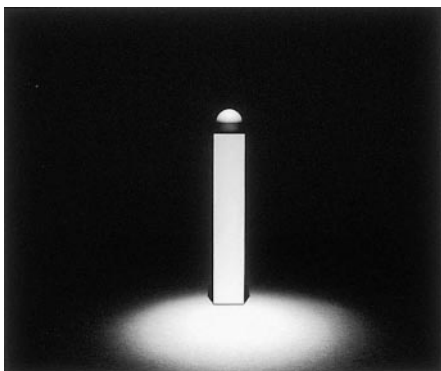

Play of brilliance

2.0

Basics

Perception

Most of the information we receive about the world around us is through our eyes. Light is not only an essential prerequisite and the medium by which we are able to see. Through its intensity, the way it is distributed throughout a space and through its properties, light creates specific conditions which can influence our perception.

Lighting design is, in fact, the planning of our visual environment. Good lighting design aims to create perceptual conditions which allow us to work effectively and orient ourselves safely while promoting a feeling of well-being in a particular environment and at the same time enhancing that same environment in an aesthetic sense. The physical qualities of a lighting situation can be calculated and measured. Ultimately it is the actual effect the lighting has on the user of a space, his subjective perception, that decides whether a lighting concept is successful or not. Lighting design can therefore not be restricted to the creation of technical concepts only. Human perception must be a key consideration in the lighting design process.

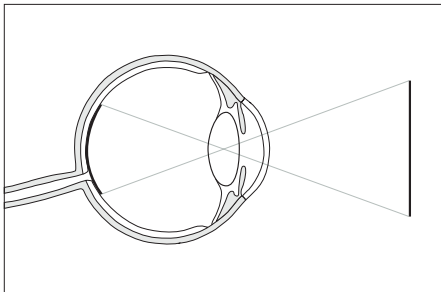

Spherical aberration. Projected images are distorted due to the curvature of the retina.

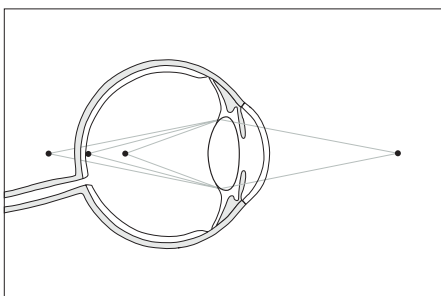

Chromatic aberration. Images are blurred due to the various degrees of refraction of spectral colours.

2.1.1 Eye and camera

The process of perception is frequently explained by comparing the eye with a camera. In the case of the camera, an adjustable system of lenses projects the reversed image of an object onto a light-sensitive film. The amount of light is controlled by a diaphragm. After developing the film and reversing the image during the enlarging process a visible, two-dimensional image of the object becomes apparent.

Similarly, in the eye, a reversed image is projected onto the inner surface of the eye, the so-called fundus oculi, via a deformable lens. The iris takes on the function of the diaphragm, the light-sensitive retina the role of the film. The image is then transported via the optic nerve from the retina to the brain, where it is adjusted in the cortex and made available to the conscious mind.

Comparing the eye with the camera in this way makes the process of vision fairly easy to understand, but it does not contribute to our comprehension of perception. The fault lies in the assumption that the image projected onto the retina is identical to the perceived image. The fact that the retina image forms the basis for perception is undisputed, but there are considerable differences between what is actually perceived in our field of vision and the image on the retina.

Firstly, the image is spatially distorted through its projection onto the curved surface of the retina – a straight line is as a rule depicted as a curve on the retina.

2.1 Perception
2.1.2 Perceptual psychology

Perceptual constancy: perception of a shape in spite of the fact that the image on the retina is changing with the changing perspective.

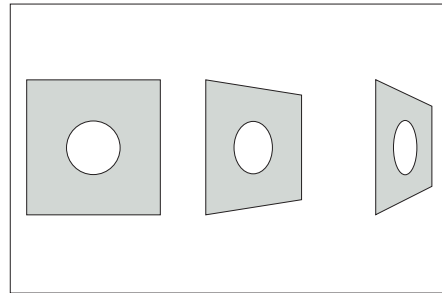

This spherical misrepresentation is accompanied by clear chromatic aberration – light of various wavelengths is refracted to varying degrees, which produces coloured rings around the objects viewed.

The eye is therefore a very inadequate optical instrument. It produces a spatially distorted and non-colour corrected image on the retina. But these defects are not evident in our actual perception of the world around us. This means that they must somehow be eliminated while the image is being processed in the brain.

Apart from this corrective process there are a number of other considerable differences between the image on the retina and what we actually perceive. If we perceive objects that are arranged within a space, this gives rise to images on the retina whose perspectives are distorted. A square perceived at an angle, for example, will produce a trapezoidal image on the retina. This image may, however, also have been produced by a trapezoidal surface viewed front on, or by an unlimited number of square shapes arranged at an angle. The only thing that is perceived is one single shape – the square that this image has actually produced. This perception of a square shape remains consistent, even if viewer or object move, although the shape of the image projected on the retina is constantly changing due to the changing perspective. Perception cannot therefore only be purely a matter of rendering the image on the retina available to our conscious mind. It is more a result of the way the image is interpreted.

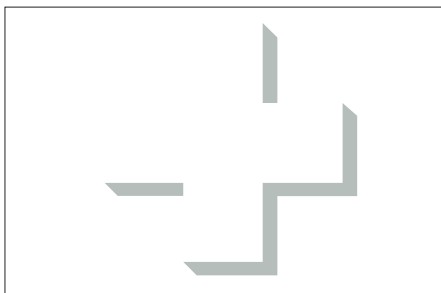

Perception of a shape based on shadow formation alone when contours are missing.

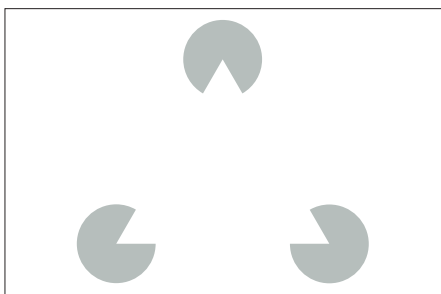

Recognising an overall shape by revealing essential details.

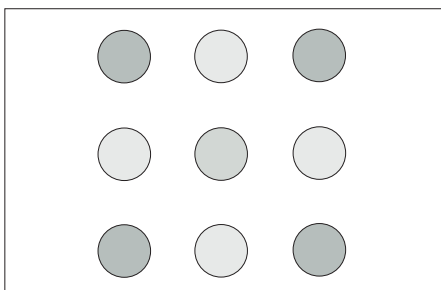

Matching a colour to the respective pattern perceived. The colour of the central grey point adjusts itself to the black or white colour of the respective perceived pattern of five

2.1.2 Perceptual psychology

Presenting a model of the eye to demonstrate the similarities to the workings of a camera does not provide any explanation as to how the perceived image comes into being – it only transports the object to be perceived from the outside world to the cortex. To truly understand what visual perception is all about, it is not so much the transport of visual information that is of significance, but rather the process involved in the interpretation of this information, the creation of visual impressions.

The next question that arises is whether our ability to perceive the world around us is innate or the result of a learning process, i.e. whether it has to be developed through experience. Another point to be considered is whether sense impressions from outside alone are responsible for the perceived image or whether the brain translates these stimuli into a perceivable image through the application of its own principles of order.

There is no clear answer to this question. Perceptual psychology is divided on this point. There are, in fact, a number of contradictory opinions, each of which can provide evidence of various kinds to prove

their point. But not one of these schools of thought is able to give a plausible explanation for all the phenomena that occur during the visual process.

There is an indication that the spatial aspect of perception is innate. If you place new-born animals (or six-month-old babies) on a glass panel that overlaps a step, they will avoid moving onto the area beyond the step. This indicates that the innate visual recognition of depth and its inherent dangers have priority over information relayed via the sense of touch, which tells the animal, or baby, that they are on a safe, flat surface.

On the other hand, it can be demonstrated that perception is also dependent on previous experience. Known shapes are more easily recognised than unknown ones. Once interpretations of complex visual shapes have been gained, they remain, and serve as a source of reference for future perception.

In this case experience, and the expectations linked with it, may be so strong that missing elements of a shape are perceived as complete or individual details amended to enable the object to meet our expectations.

When it comes to perception, therefore, both innate mechanisms and experience have a part to play. It may be presumed that the innate component is responsible for organising or structuring the information perceived, whereas on a higher level of processing experience helps us to interpret complex shapes and structures.

As for the issue of whether impressions received via the senses alone determine perception or whether the information also has to be structured on a psychological level, again there is evidence to prove both these concepts. The fact that a grey area will appear light grey if it is edged in black, or dark grey if it is edged in white can be explained by the fact that the stimuli perceived are processed directly – brightness is perceived as a result of the lightness contrast between the grey area and the immediate surroundings. What we are considering here is a visual impression that is based exclusively on sensory input which is not influenced by any criteria of order linked with our intellectual processing of this information.

On the other hand, the fact that vertical lines in a perspective drawing appear to be considerably larger further back in the drawing than in the foreground, can be explained by the fact that the drawing is interpreted spatially. A line that is further away, i.e. in the background, must be longer than a line in the foreground in order to produce an equivalently large retina image – in the depth of the space a line of effectively the same length will therefore be interpreted and perceived as being longer.

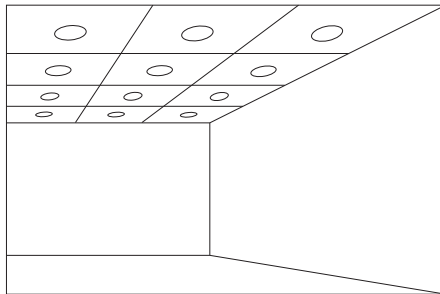
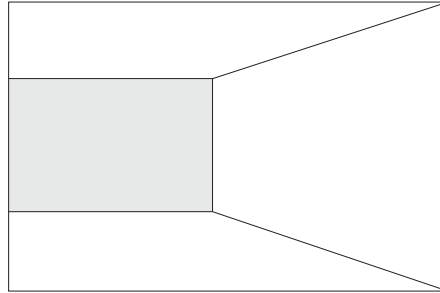

Constancy with regard to perception of size. Due to the perspective interpretation of this illustration the luminaires are all perceived as being the same size in spite of the variations in size of the retina images.

The perception of the lightness of the grey surface depends on its immediate surroundings. If the surrounding field is light an identical shade of grey will appear to be darker than when the surrounding field is dark.

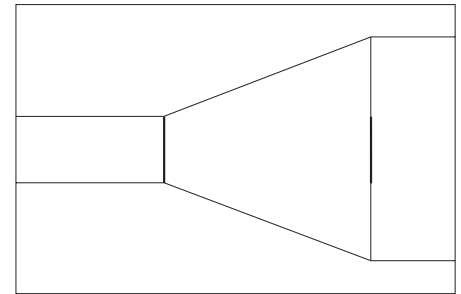
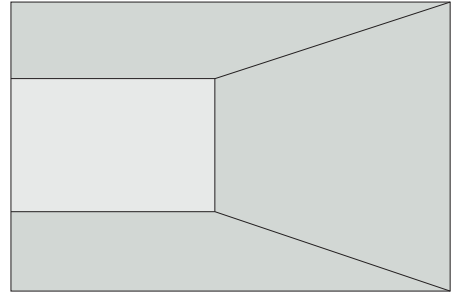

In this case the perspective interpretation leads to an optical illusion. The vertical line to the rear appears to be longer than a line of identical length in the foreground due to the perspective interpretation of the picture.

The continuous luminance gradient across the surface of the walls is interpreted as a property of the lighting of the wall. The wall reflectance factor is assumed to be constant. The grey of the sharply framed picture is interpreted as a property of the material, although the luminance is identical to the luminance of the corner of the room.

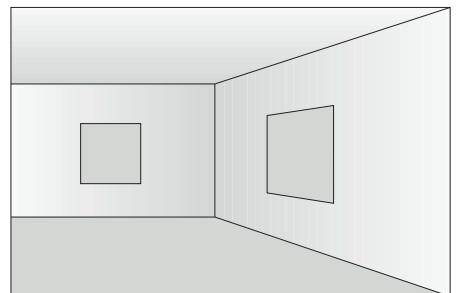

Our apparent knowledge of distance ratios therefore gives rise to a change in the way we perceive things. As the distances in the drawing are however fictitious, we can say that there is evidence that the brain is able to perform interpretative processes that are not dependent on external stimuli. Perception therefore cannot be attributed to one principle alone, but results from various mechanisms.

2.1.2.1 Constancy

Even if there is not one simple explanation for the way perception works, the question regarding which objective the various mechanisms serve remains an interesting one. Optical illusions provide an opportunity to examine the effects and aims of perception. Optical illusion is not a case of a perceptual faux pas, but can be regarded as the border case of a mechanism that provides essential information under everyday conditions. This indicates that both phenomena described above, both the changing perception of brightness on identical surfaces and the erroneous perception of lines of equal length, can be explained as stemming from one common objective.

One of the most important tasks of perception is to differentiate between constant objects and changes in our surroundings in the continuously changing shapes and distribution of brightness of the image on the retina. Since constant objects also produce retina images of varying shapes, sizes and brightness arising due to changes in lighting, distance or perspective, this indicates that mechanisms must exist to identify these objects and their properties and to perceive them as being constant.

Our misinterpretation of lines of the same length shows that the perceived size of an object does not depend on the size of the retina image alone, but that the distance of the observer from the object is significant. Vice versa, objects of known sizes are used to judge distances or to recognise the size of adjacent objects. Judging from daily experience this mechanism is sufficient to allow us to perceive objects and their size reliably. A person seen a long way away is therefore not perceived as a dwarf and a house on the horizon not as a small box. Only in extreme situations does our perception deceive us: looking out of an aeroplane objects on the ground appear to be tiny; the viewing of objects that are considerably farther away, e.g. the moon, is much more difficult for us to handle.

Just as we have mechanisms that handle the perception of size we have similar mechanisms that balance the perspective

distortion of objects. They guarantee that the changing trapezoidal and ellipsoidal forms in the retina image can be perceived as spatial manifestations of constant, rectangular or round objects, while taking into consideration the angle at which the object is viewed.

When it comes to lighting design there is a further complex of constancy phenomena that are of significance; those which control the perception of brightness. Through the identification of the luminous reflectance of a surface it becomes apparent that a surface reflects light differently depending on the intensity of the surrounding lighting, i.e. the luminance of a surface varies. The illuminated side of a unicoloured object has a higher luminance than the side that receives no direct light; a black object in sunlight shows a considerably higher level of luminance than a white object in an interior space. If perception depended on seen luminance, the luminous reflectance would not be recognised as a constant property of an object.

A mechanism is required that determines the luminous reflectance of a surface from the ratio of the luminances of this surface to its surroundings. This means that a white surface is assumed to be white both in light and shade, because in relation to the surrounding surfaces it reflects more light. There is, however, the borderline case, as indicated above, where two surfaces of the same colour are perceived as being of a different brightness under the same lighting due to different surrounding surfaces.

The ability of the perceptual process to recognise the luminous reflectance of objects under different illuminance levels is actually only half the story. There must be additional mechanisms that go beyond the perception of luminous reflectance, while processing varying gradients and sharp differences in luminance.

We are familiar with changing luminance levels on the surfaces around us. They may be the result of the type of lighting: one example of this is the gradual decrease in brightness along the rear wall of a space that is daylit from one side only. Or they may arise from the spatial form of the illuminated object: examples of this are the formation of typical shadows on spatial bodies such as cubes, cylinders or spheres. A third reason for the presence of different luminances may lie in the quality of the surface. Uneven reflectance results in uneven luminance even if the lighting is uniform. The aim of the perceptual process is to decide whether an object is of a single colour, but not lit uniformly, or whether it is spatially formed or a uniformly lit object with an uneven reflection factor.

The spatial impression is determined by the unconscious assumption that light comes from above. By inverting the picture the perception of elevation and depth is changed.

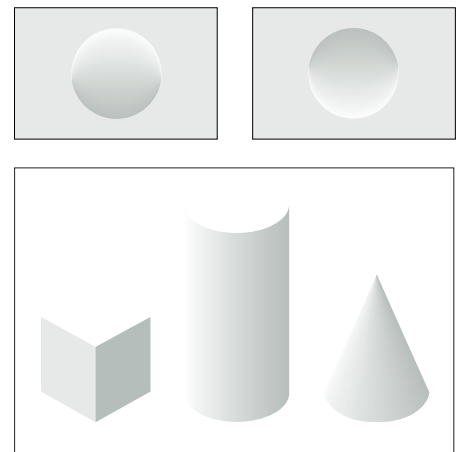

The spatial quality of an object can be recognised purely from the gradient of the shadows.

2.1 Perception
2.1.2 Perceptual psychology

Change of perception from light/dark to black/white if the spatial interpretation of the figure changes.

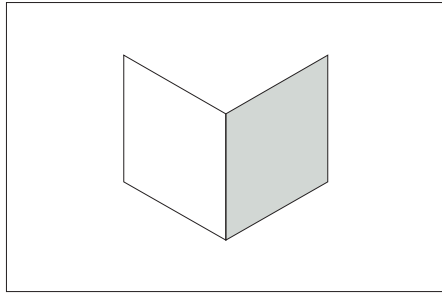

The example shown here serves to explain this process. As a rule the folded card is perceived as if it is being viewed from the outside (fold to the front). In this case it appears to be uniformly white but lit from one side. If the card is seen as being viewed from inside (fold to the rear), it is perceived as being uniformly lit but with one half coloured black. The luminance pattern of the retina image is therefore interpreted differently: in one case it is attributed to a characteristic black/white coloration of the perceived object; in the other case perception does not cover the different luminance in the perception of the apparently uniformly white card; it is taken to be a feature of the lighting situation.

The lighting distribution on an unstructured wall becomes a dominant feature, whereas the same lighting distribution on a structured wall is interpreted as background and not perceived.

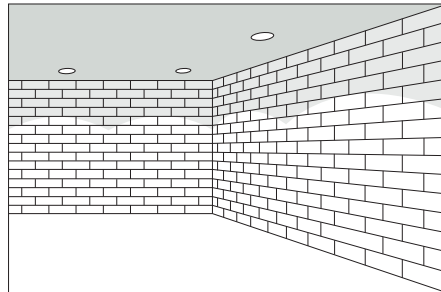
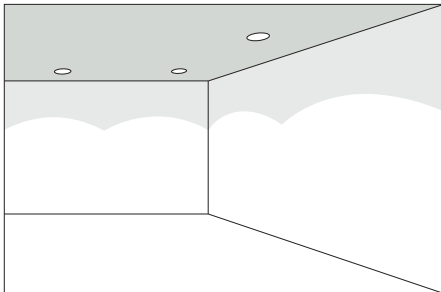

One characteristic feature of perception is, therefore, the preference for simple and easily comprehensible interpretations. Differences in luminance are effectively eliminated from the perceived images to a large extent or especially emphasized depending on whether they are interpreted as a characteristic feature of the object or as a feature of the surroundings – in this case, of the lighting.

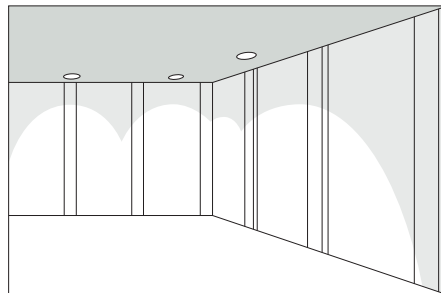
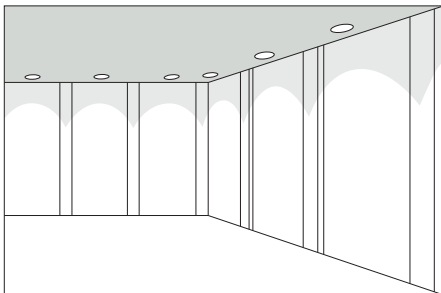

These mechanisms should be taken into consideration when designing the lighting for a space. The first conclusion that can be drawn is that the impression of uniform brightness does not depend on totally uniform lighting, but that it can be achieved by means of luminance gradients that run uniformly.

On the other hand irregular or uneven luminances can lead to confusing lighting situations. This is evident, for example, when luminous patterns created on the walls bear no relation to the architecture. The observer's attention is drawn to a luminance pattern that cannot be explained through the properties of the wall, nor as an important feature of the lighting. If luminance patterns are irregular they should, therefore, always be in accordance with the architecture.

Light distribution that is not aligned with the architectural structure of the space is perceived

as disturbing patterns that do not relate to the space.

The position of the luminous beam determines whether it is perceived as background or as a disturbing shape.

The perception of colour, similar to the perception of brightness, is dependent on surrounding colours and the quality of the lighting. The necessity to interpret colours is based on the fact that colour appearances around us are constantly changing.

A colour is therefore perceived as being constant both when viewed in the bluish light of an overcast sky or in warmer direct sunlight – colour photographs taken under the same conditions, however, show the colour shifts we expect under the particular lighting.

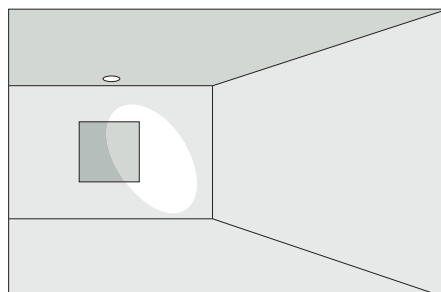
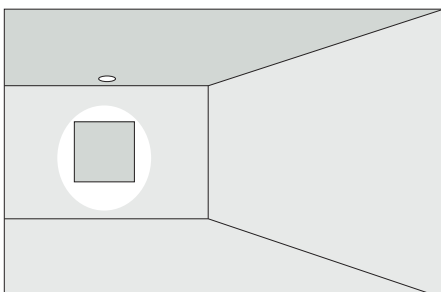

Perception is therefore able to adjust to the respective colour properties of the lighting, thereby providing constant colour perception under changing conditions. This only applies, however, when

the entire environment is lit with light of the same luminous colour and the lighting does not change too rapidly. If different lighting situations can be compared directly, the contrast due to different luminous colours will be perceived. This becomes evident when the observer moves through spaces that are lit differently, but above all when different light sources are used within one room or if the observer is in a space comprising coloured glazing and in a position to compare the lighting inside and outside the building. Lighting a space using different luminous colours can be done effectively, if the change of luminous colour bears a clear relation to the respective environment.

2.1.2.2 Laws of gestalt

The main theme of this chapter so far has been the question of how the properties of objects – size, form, reflectance and colour – are perceived as being constant in spite of changing retina images. These considerations did not include how the object itself is perceived.

Before properties can be attributed to an object, the object itself must be recognised, that is to say, distinguished from its surroundings. The process of identifying this object in the profusion of continuously changing stimuli on the retina is no less problematic than the perception of objects. Or to put it in more general terms: how does the perceptual process define the structures its attention has been drawn to and how does it distinguish them from their surroundings.

An example will serve to illustrate this process. In the drawing on the left most people spontaneously see a white vase against a grey background. On closer examination two grey heads facing each other against a white background become apparent. Once the hidden faces have been discovered, there is no difficulty in perceiving the vase or the faces, but it is impossible to see both at the same time.

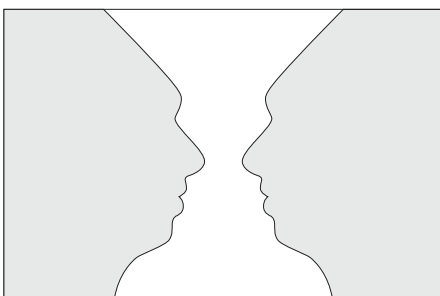

Depending on how you view this drawing, you will see a vase or two heads facing each other.

In both cases we perceive a figure – either the vase or the two faces against a background of a contrasting colour. The separation of gestalt (form) and environment, of motif and background, is so complete that if you imagine that the form is moved, the background does not move in unison. In our example the background is therefore an area behind the form and fills the entire drawing. Apart from its colour and its function as an environment no other properties are attributed to the background area. It is not an object in its own right and is not affected by changes inherent to the form. This impression is not influenced by the knowledge that the "background" in our example, is in fact, another form, or gestalt – the perceptual

mechanism is stronger than our conscious reasoning.

This example shows that the complex and inconsistent patterns of the retina image are ordered in the course of the perpetual process to enable us to interpret what we perceive easily and clearly. In our example, a portion of these patterns within one picture are grouped together to form an image, i.e. an object of interest while the rest of the patterns are regarded as the background and their properties by and large ignored.

Moreover, the fact that of the two interpretations the vase is the preferred one shows that this process of interpretation is subject to certain rules; that is to say, that it is possible to formulate laws according to which certain arrangements are grouped together to form shapes, i.e. objects of perception.

These rules are not only of value when it comes to describing the perceptual process, they are also of practical interest for the lighting designer. Every lighting installation comprises an arrangement of luminaires – on the ceiling, on the walls or in the space. This arrangement is not perceived as such, but is organised into forms or groups in accordance with the laws of gestalt. The architectural setting and the lighting effects produced by the luminaires give rise to further patterns, which are included in our perception of the overall situation.

It might occur that these structures are reorganised visually to such an extent that we do not perceive the patterns as intended, but other shapes and forms. Another, negative effect may be – for example, in the case of a chessboard pattern – that gestalt and background cannot be clearly identified. The result is continuously shifting focus selection. It is therefore necessary to consider to the laws of gestalt when developing lighting design concepts.

Law of gestalt relating to proximity. Luminaires are grouped in pairs.

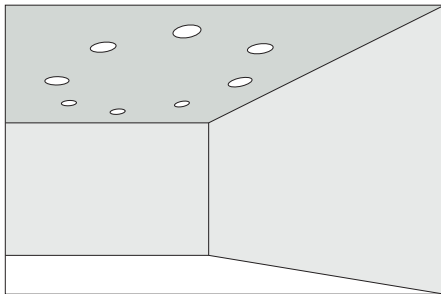
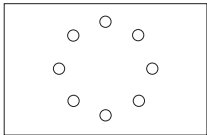
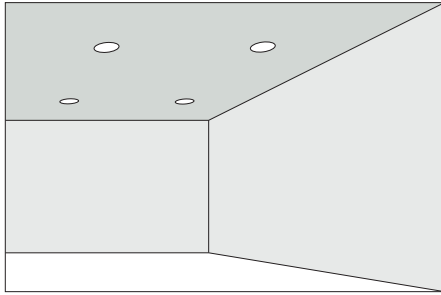
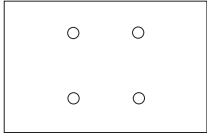
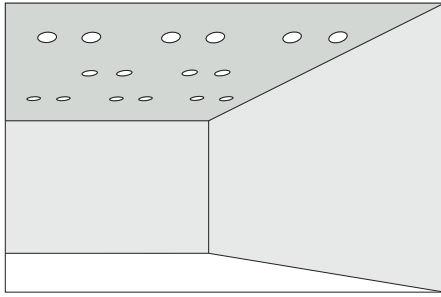

Law of gestalt relating to proximity. Four points are grouped to form a square, from eight points upwards a circle is formed.

An initial and essential principle of the perception of gestalt, is the tendency to interpret *closed forms* as a figure.

Closed forms need not possess a continuous contour. Elements arranged close together are grouped according to another law of gestalt, the *law of proximity*, and form a figure. The example on the left demonstrates that we first see a circle and then an arrangement of luminaires. The circles are arranged in such a strict order that the imaginary linking lines between them is not straight, but forms a circle; the resulting shape is not a polygon but a perfect circle.

Apart from the effect produced by proximity, there is another mechanism via which shapes that are not completely closed can be perceived as a gestalt. A closed shape is always seen as being on the *inside* of the linking line – the formative effect therefore only works in one direction. This inner side is usually identical to the concave, surrounding side of the line that encloses the figure. This in turn leads to a formative effect even in the case of open curves or angles, rendering a figure visible inside the line, that is to say in the partly enclosed area. If this leads to a plausible interpretation of the initial pattern, the effect of the inner side can be significant.

Patterns frequently possess no shapes that can be arranged according to the principles of closure or proximity, or the inner line. But in such cases there are laws of gestalt that allow certain arrangements to appear as a shape. The perception of a form as a pure shape is based on simple, logical structure, whereas more complex structures belonging to the same pattern disappear into an apparently continuous background. One example of this logical structuring of specific shapes is *symmetry*.

The downlights are arranged in two lines in accordance with the law of pure form. When two modular luminaires are added the arrangement is reorganised according to the law of symmetry to form two groups of five.

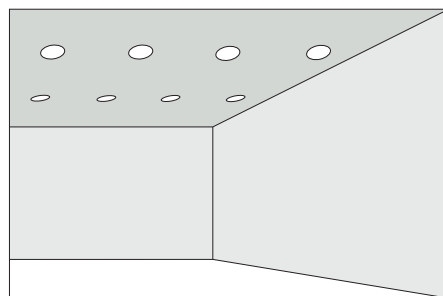
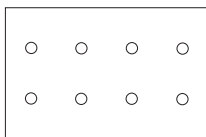

Shapes of *equal width* have a similar effect. This is not strictly a case of symmetry. A principle of order and organisation is, however, evident, and this allows us to perceive a shape.

If a pattern contains no symmetry or similar widths, *uniform style* can still be enough to render a shape a gestalt.

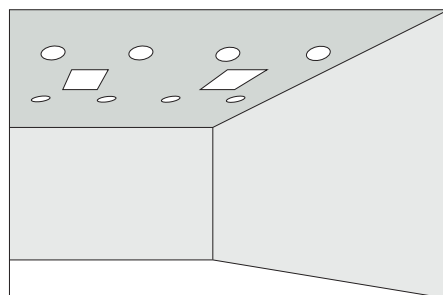
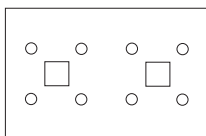

Apart from providing the ability to distinguish shapes from their surroundings, i.e. figures from their background, perception also clarifies the relation of figures to each other; be it the grouping together of individual shapes to form one large shape or the inter-relationship of a number of shapes to form a group. The basic principle that lies behind our ability to distinguish between shapes and background is once again evident here: our unconscious search for order in our visual field.

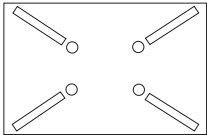
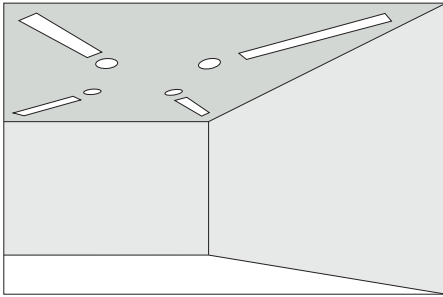

Law of gestalt relating to continuous lines. The arrangement is interpreted as two lines crossing.

A basic law of gestalt is to prefer to perceive lines as steady *continuous curves* or straight lines, and to avoid bends and deviations. The preference to perceive continuous lines is so great that it can influence the overall interpretation of an image.

When it comes to two-dimensional shapes the law of the continuous line conforms with the *law of pure form*. In this case, too, shapes are organised to create figures that are as simple and clearly arranged as possible.

When a given number of individual shapes are put together to form groups, similar laws of gestalt come into play as with the focal selection of figure and background. The *proximity* of shapes is an equally essential principle in this regard.

A further criterion for the formulation of groups is *symmetry*. Especially in the case of axial symmetry (arrangements around a vertical axis) the mirrored shapes are always grouped in pairs. This effect can be so strong that the grouping of adjacent shapes according to the law of proximity becomes irrelevant.

Besides spatial layout, the structure of the shapes themselves is also responsible for the formation into groups. The shapes in the adjacent drawing are not organised according to proximity or axial symmetry, but in groups of identical shapes. This principle of *identity* also applies when the shapes in a group are not absolutely identical but only similar.

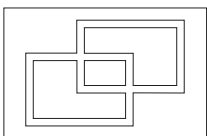
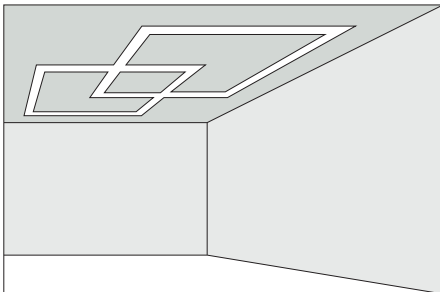

Law of gestalt relating to pure form. The arrangement is interpreted as two superimposed rectangles.

The final law of gestalt for the arrangement of groups is a special case, as it involves the element of movement. In the case of the law of "*common destiny*" it is not the similarity of structure, but rather a mutual change, predominantly of the spatial position, which assembles the figures into groups. This becomes apparent when some of the forms that were originally attributed to a previously well-organised group, move in unison, because in contrast to the remaining figures, it is as if they are drawn on a transparent overlay, which is placed on the original pattern. The common movement of the group in contrast to the immovability of the other figures renders their belonging together in any purposeful sense so probable that the original image is spontaneously reinterpreted.

At first glance these laws of gestalt appear to be very abstract and of little significance for the lighting designer. But these laws of gestalt do play an important role in the development of luminaire arrangements. The actual lighting effect produced by a planned arrangement of luminaires may deviate totally from the original design, if the concept it is based on ignores the mechanisms inherent to perception.

Law of gestalt relating to similarity. Luminaires of the same type are grouped together.

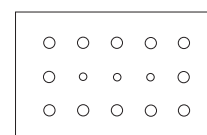
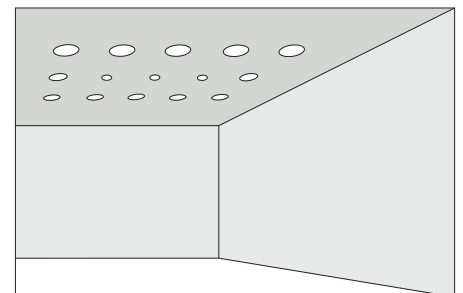

Sectional view of the eye, representation showing the parts of the eye which are significant in the physiology of vision:

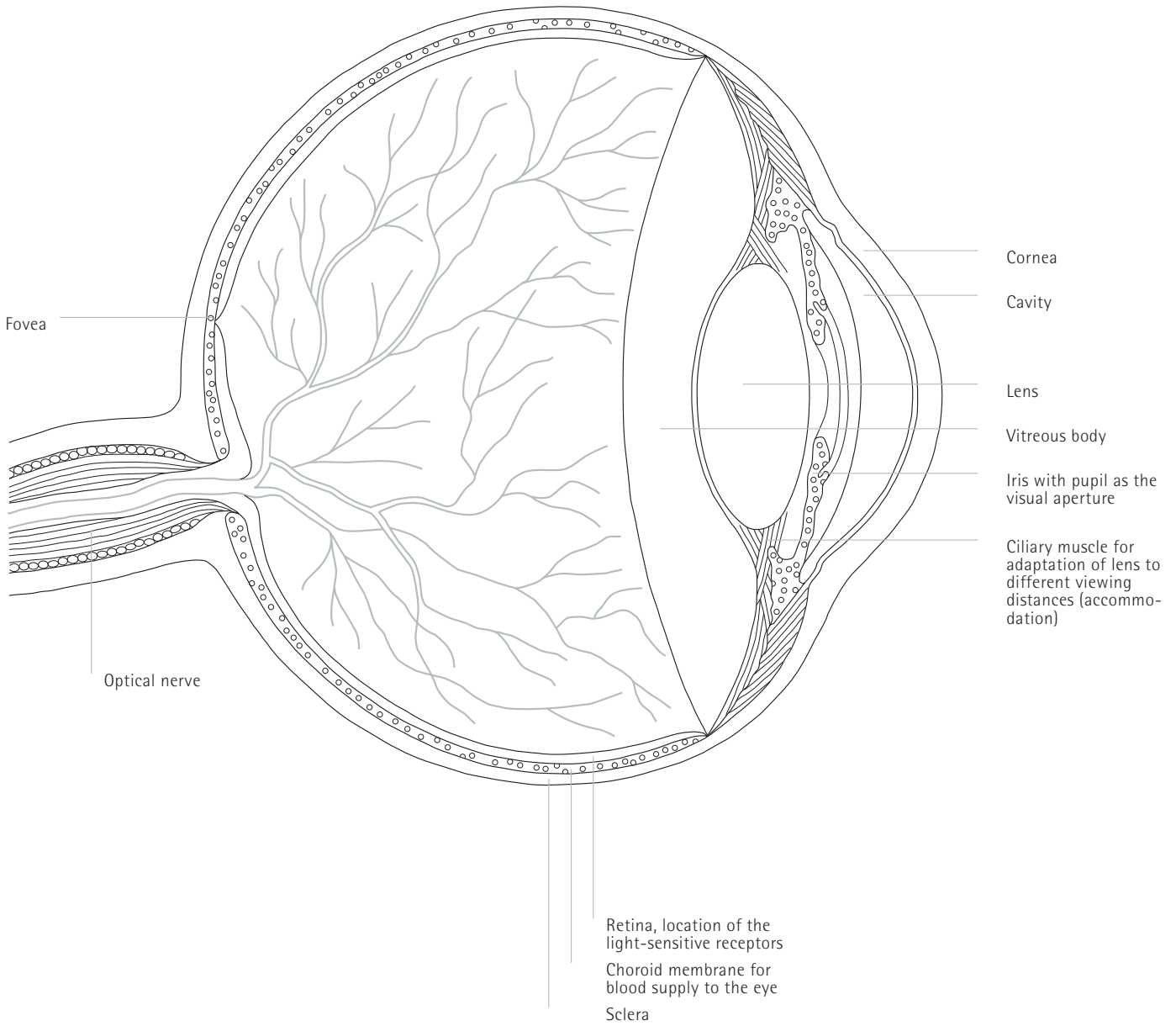

2.1.3 Physiology of the eye

The information presented in this chapter is based on the consideration that it is inadequate to portray the eye as an optical system when describing human perception. The process of perception is not a matter of how an image of our environment is transferred to the retina, but how the image is interpreted, how we differentiate between objects with constant properties in a changing environment. Although this means that priority will be given here to the process by which the image is created both physiologically and psychologically, the eye and its fundamental properties should not be ignored.

The eye is first and foremost an optical system creating images on the retina. We have described this system by comparing the eye with a camera, but more interesting by far is the surface on which the image occurs - the retina. It is in this layer that the pattern of luminances is translated into nervous impulses. The retina has, therefore, to possess light sensitive receptors that are numerous sufficient to allow a high resolution of the visual image.

On close examination it is evident that these receptors are not arranged in a uniform pattern; the retina is a very complicated structure: firstly there are two different types of receptor, the rods and the cones, which are not distributed evenly over the retina. At one point, the so-called "blind spot", there are no receptors at all, as this is the junction between the optic nerves and the retina. On the other hand there is an area called the fovea, which is at the focal point of the lens. Here there is the greatest concentration of cones, whereas the density of the cones reduces rapidly towards the peripheral area. This is where we find the greatest concentration of rods, which are not evident at all in the fovea.

The reason for this arrangement of different receptor types lies in the fact that our eyes consist of two visual systems. The older of these two systems, from an evolutionary point of view, is the one involving the rods. The special features of this system are a high level of light-sensitivity and a large capacity for perceiving movement over the entire field of vision. On the other hand, rods do not allow us to perceive colour; contours are not sharp, and it is not possible to concentrate on objects, i.e. to study items clearly when they are in the centre of our field of vision.

The rod system is extremely sensitive and it is activated when the illuminance level is below 1 lux. The main features of night vision - mainly the fact that colour is not evident, contours are blurred and poorly lit items in our peripheral field

of vision are more visible - can be explained by the properties of the rod system.

The other type of receptors, the cones, make up a system with very different properties. This is a system which we require to see things under greater luminous intensities, i.e. under daylight or electric light. The cone system has a lower level of light-sensitivity and is concentrated in the central area around the fovea. It allows us to see colours and sharper contours of objects on which we focus, i.e. whose image falls in the fovea area.

In contrast to rod vision, we do not perceive the entire field of vision uniformly; the main area of perception is in the central area. The peripheral field of vision is also significant, however; if interesting phenomena are perceived in that area then our attention is automatically drawn to these points, which are then received as an image in the fovea to be examined more closely. Apart from noticing sudden movement, striking colours and patterns, the main reason for us to change our direction of view is the presence of high luminances - our eyes and attention are attracted by bright light.

One of the most remarkable properties of the eye is its ability to adapt to different lighting conditions. We can perceive the world around us by moonlight or sunlight, although there is a difference of a factor of 10^5 in the illuminance. The extent of tasks the eye is capable of performing is extremely wide - a faintly glowing star in the night's sky can be perceived, although it only produces an illuminance of 10^{-12} lux on the eye.

This accommodation is only influenced to a very small extent by the pupil, which regulates incident light in a 1:16 ratio. Adaptation is performed to a large extent by the retina. The rod and cone system handles different levels of light intensity. The rod system comes into effect in relation to night vision (scotopic vision), the cones allow us to see during the daytime (photopic vision) and both receptor systems are activated in the transition times of dawn and dusk (mesopic vision).

Although vision is therefore possible over an extremely wide area of luminances there are clearly strict limits with regard to contrast perception in each individual lighting situation. The reason for this lies in the fact that the eye cannot cover the entire range of possible luminances at one and the same time, but adapts to cover one narrow range in which differentiated perception is possible. Objects that possess too high a luminance for a particular level of adaptation cause glare, that is to say, they appear to be extremely bright. Objects of low luminance, on the other hand, appear to be too dark.

The eye is able to adjust to new luminance conditions, but as it does so it

Number N of rods and cones on the retina in relation to the angle of sight.

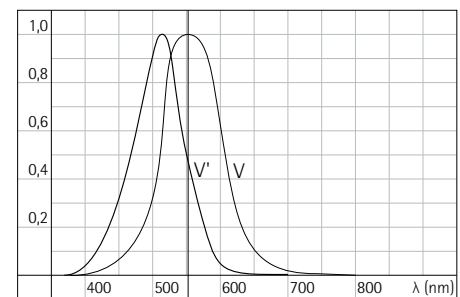
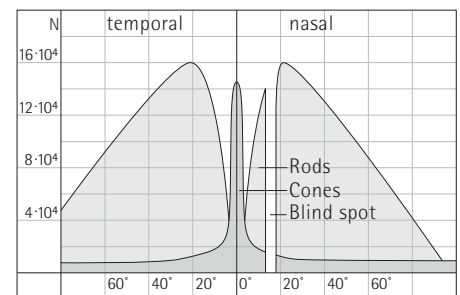

Relative spectral luminous efficiency of rods V' and cones V .

2.1 Perception
2.1.4 Objects of perception

simply selects a different but restricted range. This process of adaptation does take time. Adapting from dark to light situations occurs relatively rapidly, whereas adapting from light to darkness requires a considerably longer time. A good example of this is how bright we find it outside having come out of a dark cinema auditorium during the daytime, or the transitory period of night blindness we experience when entering a very dark room. Both the fact that contrast in luminance can only be processed by the eye within a certain range, plus the fact that it takes time to adapt to a new level of lighting, or brightness, have an impact on lighting design: the purposeful planning of different luminance grades within a space, for example, or when adjusting lighting levels in adjacent spaces.

2.1.4 Objects of perception

Although this chapter has described the psychological mechanisms involved in the perception process together with the physiological prerequisites, a third area has only been touched upon - the subject of perception. To this point the things that were seen were either "objects" or "figures" in general or examples chosen to illustrate a certain mechanism. We do not perceive any object that comes within our field of vision, however. The way the fovea prefers to focus on small, changing scenes shows that the perception process purposefully selects specific areas.

This selection is inevitable, as the brain is not capable of processing all the visual information in the field of vision, and it also makes sense because not all the information that exists in our environment is necessarily relevant for perception.

Any attempt to describe visual perception effectively must therefore also take into account the criteria by which the selection of the perceived information is effected. In the first instance the value of any particular information relates to the current activity of the observer. This activity may be work or movement-related or any other activity for which visual information is required.

The specific information received depends on the type of activity. A car driver has to concentrate on different visual tasks than a pedestrian. A precision mechanic processes different information than a worker in a warehouse. A visual task can be defined by size or location; it is of importance whether a visual task is movement-related or not, whether small details or slight contrasts have to be registered, whether colours or surface structures are essential properties. Lighting conditions under which the visual task can be perceived to an optimum degree can be determined from the above-mentioned specific features. It is possible

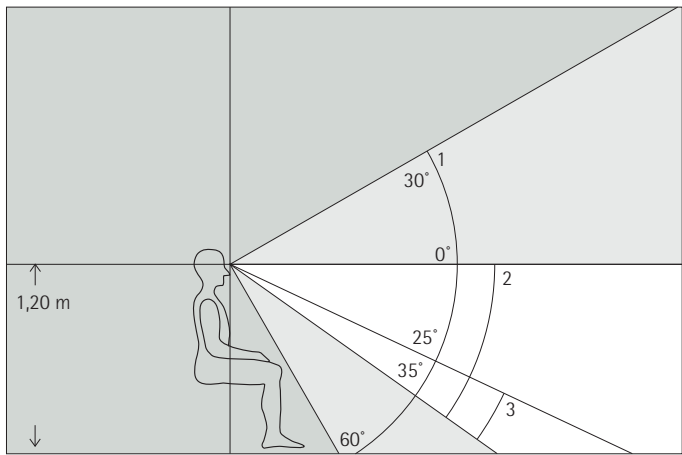
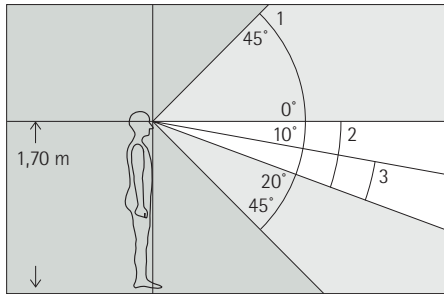

Visual field (1), preferred visual field (2) and optimum field of vision (3) of a person standing (above) and sitting (centre, below) for vertical visual tasks.

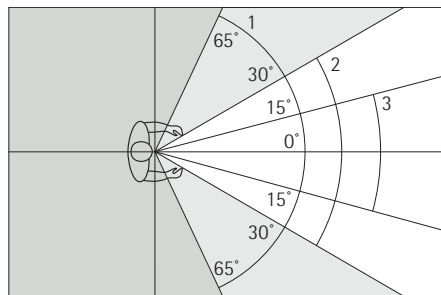

Frequency H of angle of sight α for horizontal visual tasks. Preferred field of vision between 15° and 40°, preferred direction of view 25°.

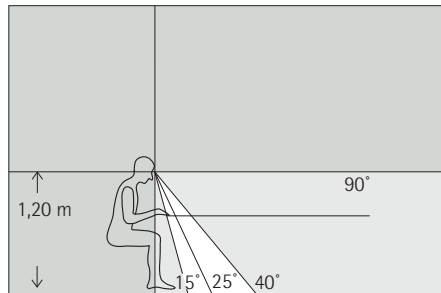
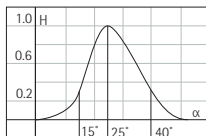

Preferred field of vision for horizontal visual tasks. Preferred direction of view 25°.

Typical illuminances E and luminances under daylight and electric light.

	E (lux)
Sunlight	100 000
Overcast sky	10 000
Task lighting	1 000
Circulation zone lighting	100
Street lighting	10
Moonlight	1

	L (cd/m ²)
Sunlight	1000 000 000
Incandescent lamp (matt finish)	100 000
Fluorescent lamp	10 000
Sunlit Clouds	10 000
Blue sky	5 000
Luminous ceiling	500
Louvred luminaires	100
Preferred values in interior spaces	50–500
White paper at 500 lx	100
Monitor (negative)	10–50
White paper at 5 lx	1

to define ways of lighting which will optimise the performance of specific activities. Investigations have been carried out especially in office and traffic situations to study the respective visual tasks and a wide range of activities and to determine the conditions required for optimum perception. Standards and recommendations for the lighting of workplaces and traffic systems are based on the findings of this research.

There is, however, another basic need for visual information that goes beyond the specific information required for a particular activity. This requirement for information is not related to any particular situation, it is the result of man's biological need to understand the world around him. Whereas you can enable a person to work more effectively by creating optimum perceptual conditions for certain activities, man's feeling of well-being in his visual environment depends on satisfying his biological need for information.

Much of the information required results from man's need to feel safe. To be able to evaluate a danger you have to be able to comprehend the structure of your environment. This applies both to orientation – knowing where you are, which route you are on, and what the potential destinations may be – and knowledge about the qualities and peculiarities of the environment you find yourself in. This knowledge, or lack of information, determines the way we feel and our behaviour. It can lead to a feeling of tension and unrest in unknown or potentially dangerous situations, or relaxation and tranquility in a familiar and safe environment. Other information about the world around us is required to allow us to adapt our behaviour to the specific situation. This may include knowledge of weather conditions and the time of day as well as information relating to other activities occurring in the given environment. Should this information not be available, e.g. in large, windowless buildings, the situation is often interpreted as being unnatural and oppressive.

A third area arises from man's social needs. The need for contact with other people and the demand for a private sphere are somewhat contradictory and have to be carefully balanced. The focus on which visual information is to be taken in is, therefore, determined by the activities being performed in a given environment and man's basic biological needs. Areas that promise significant information – be it in their own right, or through accentuation with the aid of light – are perceived first. They attract our attention. The information content of a given object is responsible for its being selected as an object of perception. Moreover, the information content also has an influence on the way in which an object is perceived and evaluated.

The glare phenomenon illustrates this particularly well. If the exterior lighting is especially strong, an opal glass window will produce glare, a fact that can be explained physiologically by the great contrast between the luminance of the window and the considerably lower luminance level of the surrounding wall surface. In the case of a window that provides an interesting view outside, the contrast is greater, but the feeling that we are being subjected to disturbing glare does not arise. Glare can, therefore, not only be explained from a physiological standpoint, as it occurs when a bright surface with no information content attracts our attention. Even high luminance contrasts are felt to be glare-free, if the area perceived offers interesting information. It is therefore clear that it is not practical to stipulate photometric quantities – e.g. luminance or illuminance limits – out of context, since the actual perception of these photometric quantities is influenced by the processing of the information provided.

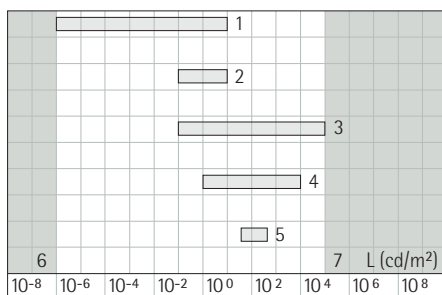

Luminance range L of rod vision (1), mesopic vision (2) and cone vision (3). Luminances (4) and preferred luminances (5) in interior spaces. Absolute threshold of vision (6) and threshold of absolute glare (7).

Terms and units

The amount of light emitted by a light source is the luminous flux Φ .

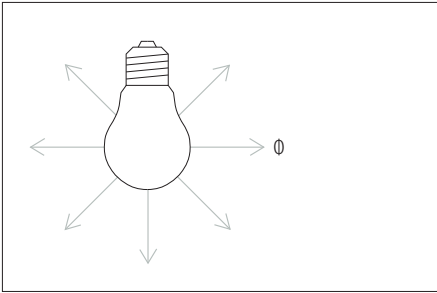

$$[\Phi] = \text{Lumen (lm)}$$

In lighting technology a number of technical terms and units are used to describe the properties of light sources and the effects that are produced.

2.2.1 Luminous flux

Luminous flux describes the total amount of light emitted by a light source. This radiation could basically be measured or expressed in *watt*. This does not, however, describe the optical effect of a light source adequately, since the varying spectral sensitivity of the eye is not taken into account.

To include the spectral sensitivity of the eye the luminous flux is measured in *lumen*. Radiant flux of 1 W emitted at the peak of the spectral sensitivity (in the photopic range at 555 nm) produces a luminous flux of 683 lm. Due to the shape of the $V(\lambda)$ curve the same radiant flux will produce correspondingly less luminous flux at different frequency points.

2.2.2 Luminous efficacy

Luminous efficacy describes the luminous flux of a lamp in relation to its power consumption and is therefore expressed in lumen per watt (lm/W). The maximum value theoretically attainable when the total radiant power is transformed into visible light is 683 lm/W. Luminous efficacy varies from light source to light source, but always remains well below this optimum value.

$$\eta = \frac{\Phi}{P}$$

$$[\eta] = \frac{\text{lm}}{\text{W}}$$

2.2.3 Quantity of light

The quantity of light, or luminous energy (US), is a product of the luminous flux emitted multiplied by time; luminous energy is generally expressed in klm · h.

$$Q = \Phi \cdot t$$

$$[Q] = \text{lm} \cdot \text{h}$$

Luminous intensity I is the luminous flux Φ radiating in a given direction per solid angle Ω .

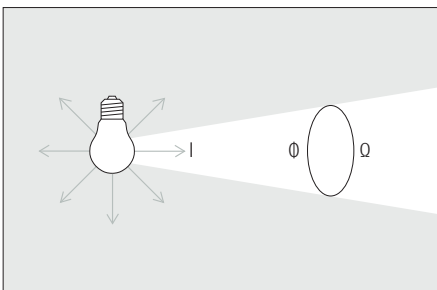

$$I = \frac{\Phi}{\Omega}$$

$$[I] = \frac{\text{lm}}{\text{sr}}$$

$$\frac{\text{lm}}{\text{sr}} = \text{Candela (cd)}$$

2.2.4 Luminous intensity

An ideal point-source lamp radiates luminous flux uniformly into the space in all directions; its luminous intensity is the same in all directions. In practice, however, luminous flux is not distributed uniformly. This results partly from the design of the light source, and partly on the way the light is intentionally directed. It makes sense, therefore, to have a way of presenting the spatial distribution of luminous flux, i.e. the luminous intensity distribution of the light source.

The unit for measuring luminous intensity is candela (cd). The candela is the primary basic unit in lighting technology from which all others are derived. The candela was originally defined by the luminous intensity of a standardised candle. Later thorium powder at the temperature of the solidification of platinum was de-

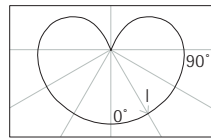
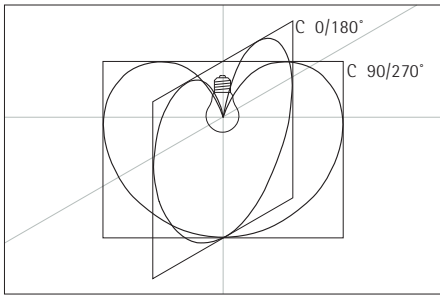

Luminous intensity distribution of a light source having rotational symmetry. A section through the C plane produces the luminous intensity distribution curve.

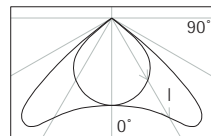
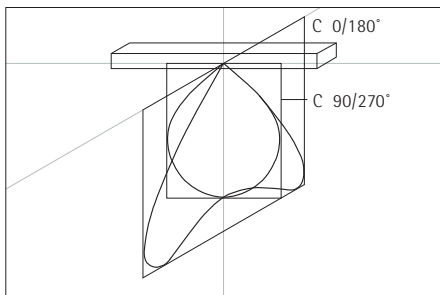

Luminous intensity distribution body and diagram (for planes C 0/180° and C 90/270°) of an axially symmetrical luminaire.

defined as the standard; since 1979 the candela has been defined by a source of radiation that radiates 1/683 W per steradian at a frequency of $540 \cdot 10^{12}$ Hz.

The distribution of the luminous intensity of a light source throughout a space produces a three-dimensional graph. A section through this graph results in a *luminous intensity distribution curve*, which describes the luminous intensity on one plane. The luminous intensity is usually indicated in a polar coordinate system as the function of the beam angle. To allow comparison between different light sources to be made, the light distribution curves are based on an output of 1000 lm. In the case of symmetrical luminaires one light distribution curve is sufficient to describe one luminaire, axially symmetrical luminaires require two curves, which are usually depicted in one diagram. The polar coordinate diagram is not sufficiently accurate for narrow-beam luminaires, e.g. stage projectors. In this case it is usual to provide a Cartesian coordinate system.

Luminous intensity distribution curve standardised to 1000 lm, represented in polar coordinates and Cartesian coordinates. The angle within which the maximum luminous intensity I' is reduced to $I'/2$, identifies the beam spread β . The cut-off angle α is the limiting angle of the luminous intensity distribution curve.

$I = I' \cdot \Phi$
 $[I] = \text{cd}$
 $[I'] = \text{cd/klm}$
 $[\Phi] = \text{klm}$

Conversion of 1000 lm-related luminous intensity I' to effective luminous intensity I .

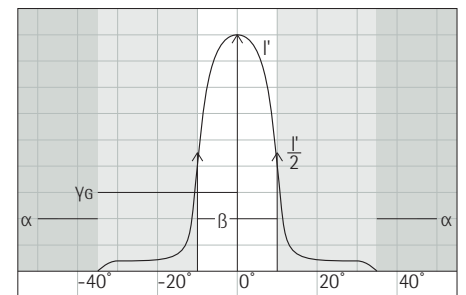
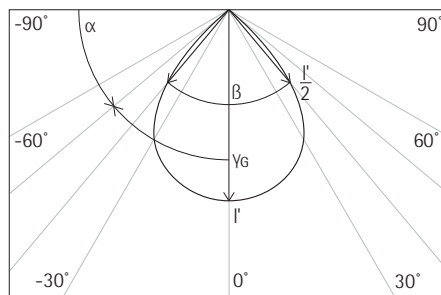

Illuminance E indicates the amount of luminous flux from a light source falling on a given surface A .

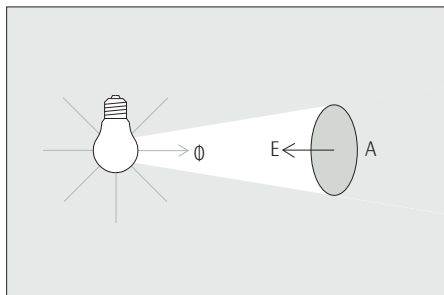

Horizontal illuminance E_h and vertical illuminance E_v in interior spaces.

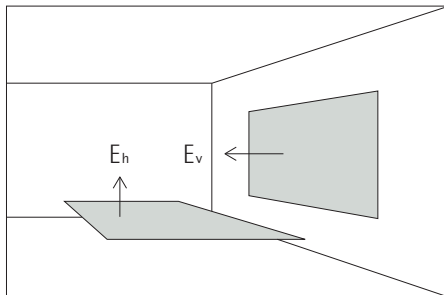

Average illuminance E_m is calculated from the luminous flux Φ falling on the given surface A .

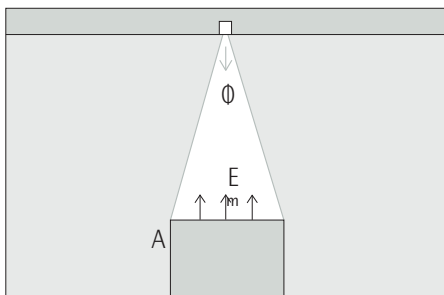

$$E_m = \frac{\Phi}{A}$$

The illuminance at a point E_p is calculated from the luminous intensity I and the distance a between the light source and the given point.

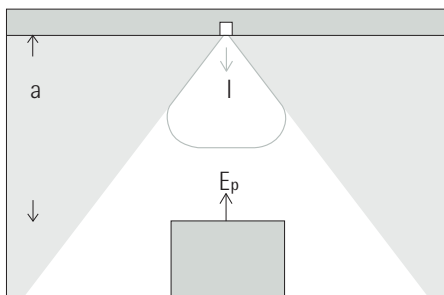

$$E_p = \frac{I}{a^2}$$

$$[E_p] = \text{lx}$$

$$[I] = \text{cd}$$

$$[a] = \text{m}$$

The luminance of a luminous surface is the ratio of luminous intensity I and the projected surface area A_p .

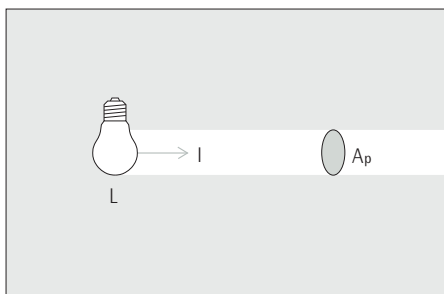

$$L = \frac{I}{A_p}$$

$$[L] = \frac{\text{cd}}{\text{m}^2}$$

The luminance of an illuminated surface with diffuse reflectance is proportional to the illuminance and the reflectance of the surface.

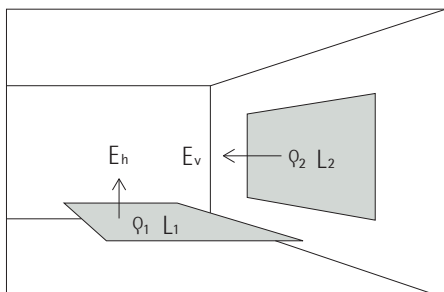

$$L_1 = \frac{E_h \cdot Q_1}{\pi}$$

$$L_2 = \frac{E_v \cdot Q_2}{\pi}$$

$$[L] = \frac{\text{cd}}{\text{m}^2}$$

$$[E] = \text{lx}$$

2.2.5 Illuminance

Illuminance is the means of evaluating the density of luminous flux. It indicates the amount of luminous flux from a light source falling on a given area. Illuminance need not necessarily be related to a real surface. It can be measured at any point within a space. Illuminance can be determined from the luminous intensity of the light source. Illuminance decreases with the square of the distance from the light source (inverse square law).

2.2.6 Exposure

Exposure is described as the product of the illuminance and the exposure time. Exposure is an important issue, for example, regarding the calculating of light exposure on exhibits in museums.

2.2.7 Luminance

Whereas illuminance indicates the amount of luminous flux falling on a given surface, luminance describes the brightness of an illuminated or luminous surface. Luminance is defined as the ratio of luminous intensity of a surface (cd) to the projected area of this surface (m²).

In the case of illumination the light can be reflected by the surface or transmitted through the surface. In the case of diffuse reflecting (matt) and diffuse transmitting (opaque) materials luminance can be calculated from the illuminance and the reflectance or transmittance.

Luminance is the basis for describing perceived brightness; the actual brightness is, however, still influenced by the state of adaptation of the eye, the surrounding contrast ratios and the information content of the perceived surface.

Light and light sources

Light, the basis for all vision, is an element of our lives that we take for granted. We are so familiar with brightness, darkness and the spectrum of visible colours that another form of perception in a different frequency range and with different colour sensitivity is difficult for us to imagine. Visible light is in fact just a small part of an essentially broader spectrum of electromagnetic waves, which range from cosmic rays to radio waves.

It is not just by chance that the 380 to 780 nm range forms the basis for our vision, i.e. "visible light". It is this very range that we have at our disposal as solar radiation on earth in relatively uniform amounts and can therefore serve as a reliable basis for our perception.

The human eye therefore utilises the part of the spectrum of electromagnetic waves available to gather information about the world around us. It perceives the amount and distribution of the light that is radiated or reflected from objects to gain information about their existence or their quality; it also perceives the colour of this light to acquire additional information about these objects.

The human eye is adjusted to the only light source that has been available for millions of years – the sun. The eye is therefore at its most sensitive in the area in which we experience maximum solar radiation. Our perception of colour is therefore also attuned to the continuous spectrum of sunlight.

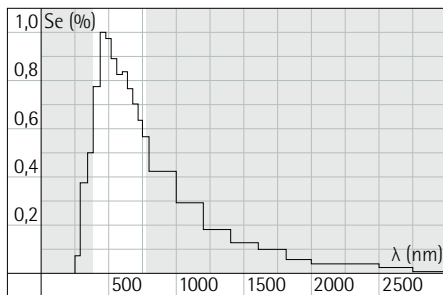

Relative spectral distribution $S_e(\lambda)$ of solar radiation (sunlight and sky light) with a pronounced emission maximum in the visible range.

Ranges of electromagnetic radiation. The spectrum of visible radiation comprises the narrow band between 380 and 780 nm.

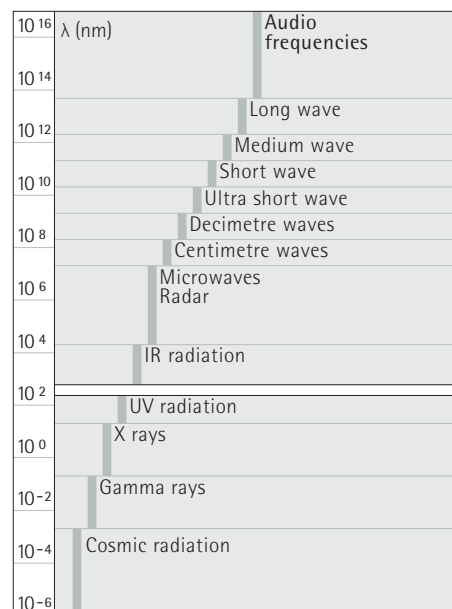

The first artificial light source was the flame of fire, in which glowing particles of carbon produce light that, like sunlight, has a continuous spectrum. For a long time the production of light was based on this principle, which exploited flaming torches and kindling, then the candle and the oil lamp and gas light to an increasingly effective degree.

With the development of the incandescent mantle for gas lighting in the second half of the 19th century the principle of the self luminous flame became outdated; in its place we find a material that can be made to glow by heating – the flame was now only needed to produce the required temperature. Incandescent gas light was accompanied practically simultaneously by the development of electric arc and incandescent lamps, which were joined at the end of the 19th century by discharge lamps.

In the 1930s gas light had practically been completely replaced by a whole range of electric light sources, whose operation provides the bases for all modern light sources. Electric light sources can be divided into two main groups, which differ according to the processes applied to convert electrical energy into light. One group comprises the thermal radiators, they include incandescent lamps and halogen lamps. The second group comprises the discharge lamps; they include a wide range of light sources, e.g. all forms of fluorescent lamps, mercury or sodium discharge lamps and metal halide lamps.

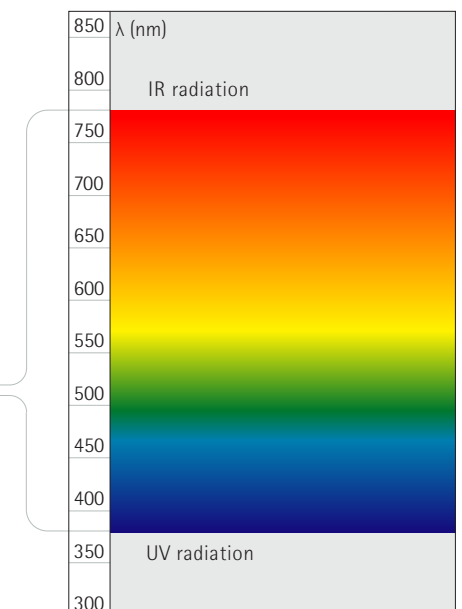

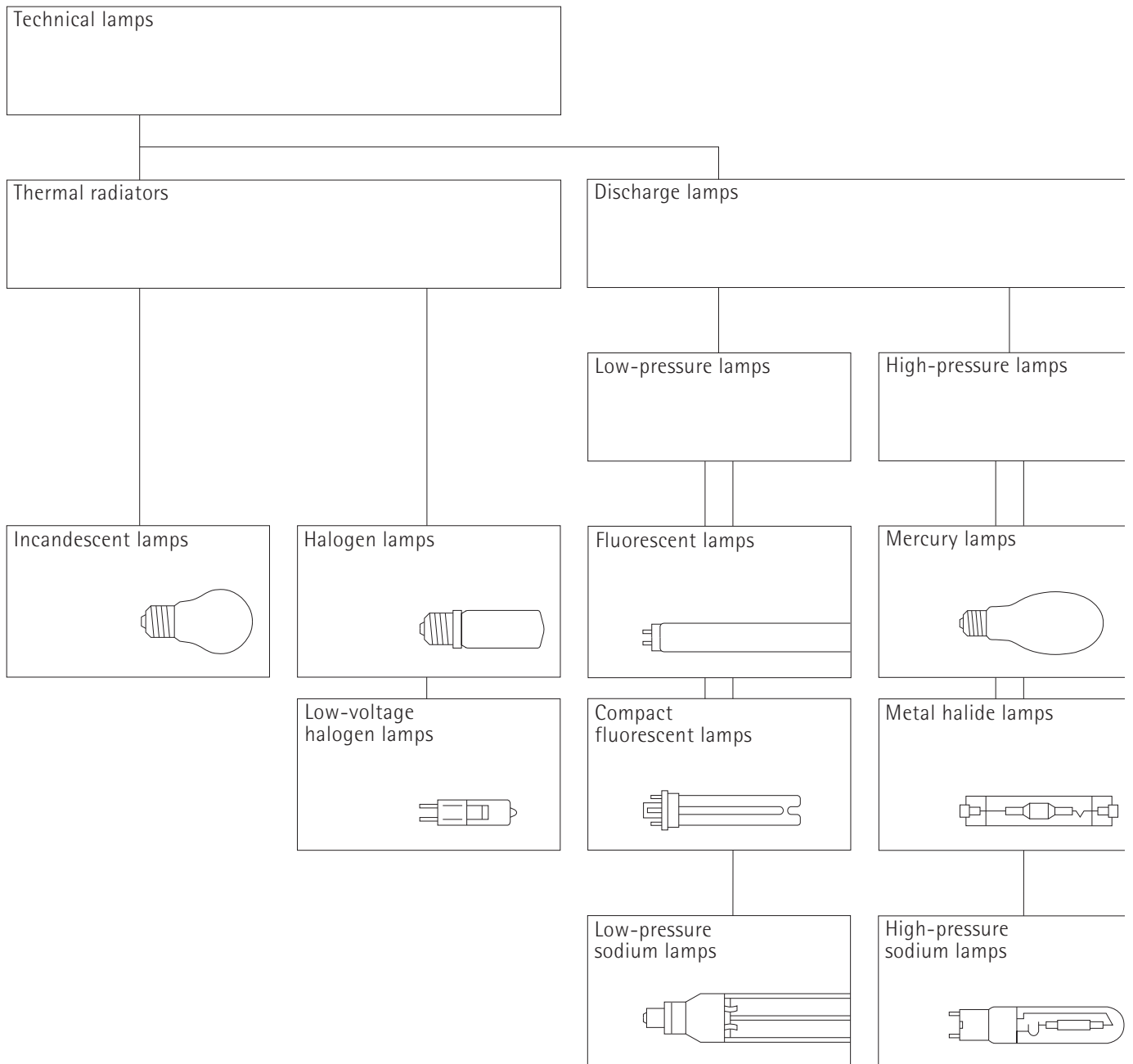

Representation of the different kinds of electric light sources according to the means of their light production. In the case of technical lamps the main distinction is between thermal radiators and discharge lamps. Discharge lamps are further subdivided into high-pressure and

low-pressure lamps. Current developments show a marked trend towards the development of compact light sources such as low-voltage halogen lamps, compact fluorescent lamps and metal halide lamps.

2.3.1 Incandescent lamps

The incandescent lamp is a thermal radiator. The filament wire begins to glow when it is heated to a sufficiently high temperature by an electric current. As the temperature increases the spectrum of the radiated light shifts towards the shorter wavelength range – the red heat of the filament shifts to the warm white light of the incandescent lamp. Depending on lamp type and wattage the temperature of the filament can reach up to 3000 K, in the case of halogen lamps over 3000 K. Maximum radiation at these temperatures still lies in the infrared range, with the result that in comparison to the visible spectrum there is a high degree of thermal radiation and very little UV radiation. Lack of a suitable material for the filament means that it is not possible to increase the temperature further, which would increase the luminous efficacy and produce a cool white luminous colour. As is the case with all heated solid bodies – or the highly compressed gas produced by the sun – the incandescent lamp radiates a continuous spectrum. The spectral distribution curve is therefore continuous and does not consist of a set of individual lines. The heating of the filament wire results from its high electrical resistance – electrical energy is converted into radiant energy, of which one part is visible light. Although this is basically a simple principle, there are a substantial number of practical problems involved in the construction of an incandescent lamp. There are only a few conducting materials, for example, that have a sufficiently high melting point and at the same time a sufficiently low evaporation rate below melting point that render them suitable for use as filament wires.

Nowadays practically only tungsten is used for the manufacture of filament wires, because it only melts at a temperature of 3653 K and has a low evaporation rate. The tungsten is made into fine wires and is wound to make single or double coiled filaments.

In the case of the incandescent lamp the filament is located inside a soft glass bulb, which is relatively large in order to keep light loss, due to deposits of evaporated tungsten (blackening), to a minimum. To prevent the filament from oxidising the outer envelope is evacuated for low wattages and filled with nitrogen or a nitrogen-based inert gas mixture for higher wattages. The thermal insulation properties of the gas used to fill the bulb increases the temperature of the wire filament, but at the same time reduces the evaporation rate of the tungsten, which in turn leads to increased luminous efficacy and a longer lamp life. The inert gases predominantly used are argon and krypton. The krypton permits a higher operating temperature – and greater lu-

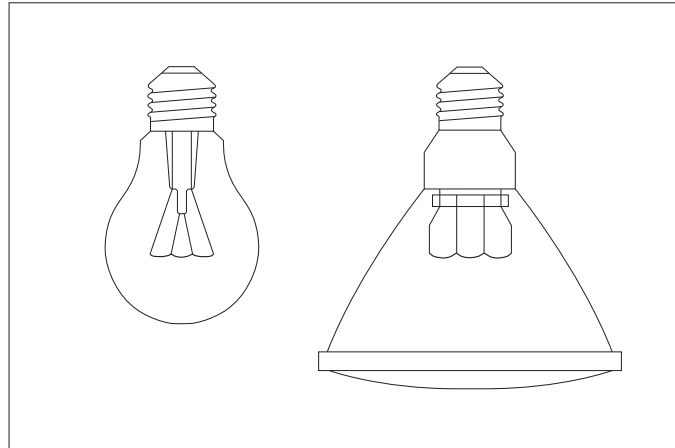

Incandescent lamps with tungsten filaments in an evacuated or gas-filled glass bulb. General service lamp (left) and pressed-glass lamp with integrated parabolic reflector (right).

Spectral distribution $S_e(\lambda)$ of a thermal radiator at different filament temperatures. As the temperature increases the maximum radiation shifts into the visible range.

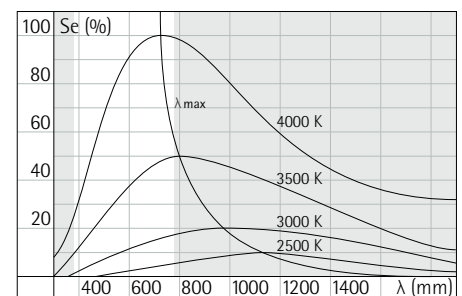

Dimming characteristics of incandescent lamps. Relative luminous flux Φ and colour temperature as a function of the relative voltage U/U_n . A reduction in voltage results in a disproportionate decrease in luminous flux.

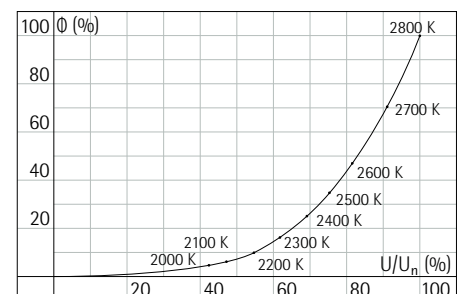

2.3 Light and light sources
2.3.1 Incandescent lamps

General service lamp: the principle of producing light by means of an electrically heated wire filament has been known since 1802. The first functional incandescent lamps were made in 1854 by Heinrich Goebel.

The real breakthrough that made the incandescent the most common light source can be ascribed to Thomas Alva Edison, who developed the incandescent lamp as we know it today in 1879.

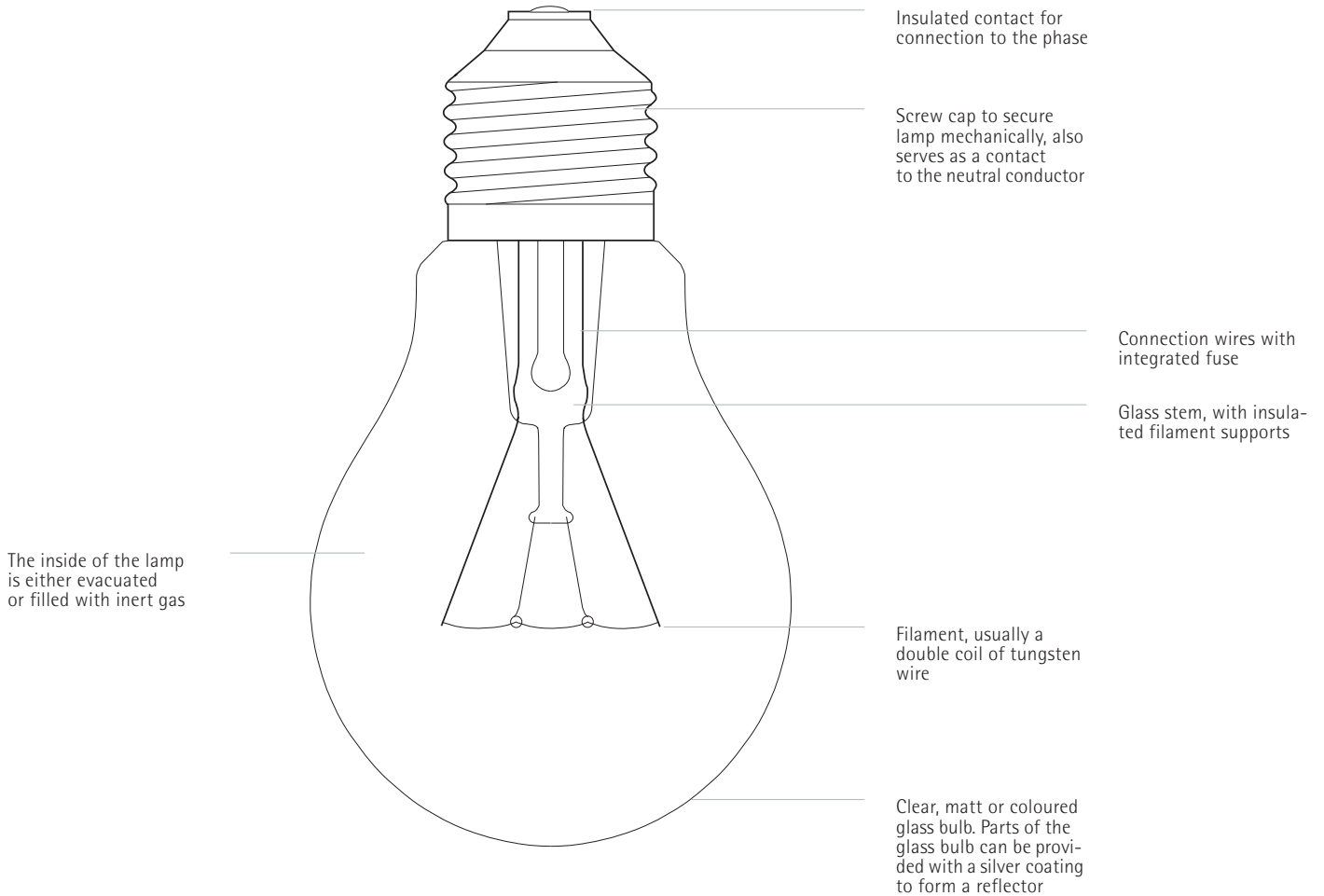

minous efficacy. Due to the fact that it is so expensive, krypton is only used in special applications.

A characteristic feature of incandescent lamps is their low colour temperature - the light they produce is warm in comparison to daylight. The continuous colour spectrum of the incandescent lamp provides excellent colour rendition.

As a point source with a high luminance, sparkling effects can be produced on shiny surfaces and the light easily controlled using optical equipment. Incandescent lamps can therefore be applied for both narrow-beam accent lighting and for wide-beam general lighting.

Incandescent lamps can be easily dimmed. No additional control gear is required for their operation and the lamps can be operated in any burning position. In spite of these advantages, there are a number of disadvantages: low luminous efficacy, for example, and a relatively short lamp life, while the lamp life relates significantly to the operating voltage. Special incandescent lamps are available with a dichroic coating inside the bulb that reflects the infrared component back to the wire filament, which increases the luminous efficacy by up to 40 %.

General service lamps (A lamps) are available in a variety of shapes and sizes. The glass bulbs are clear, matt or opal. Special forms are available for critical applications (e.g. rooms subject to the danger of explosion, or lamps exposed to mechanical loads), as well as a wide range of special models available for decorative purposes.

A second basic model is the reflector lamp (R lamp). The bulbs of these lamps are also blown from soft glass, although, in contrast with the A lamps, which radiate light in all directions, the R lamps control the light via their form and a partly silvered area inside the lamp. Another range of incandescents are the PAR (parabolic reflector) lamps. The PAR lamp is made of pressed glass to provide a higher resistance to changes in temperature and a more exact form; the parabolic reflector produces a well-defined beam spread.

In the case of cool-beam lamps, a subgroup of the PAR lamps, a dichroic, i.e. selectively reflective coating, is applied. Dichroic reflectors reflect visible light, but allow a large part of the IR radiation to pass the reflector. The thermal load on illuminated objects can therefore be reduced by half.

Relative power P of incandescent lamps as a function of voltage.

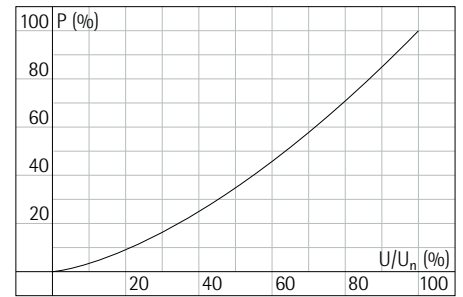

Effect of overvoltage and undervoltage on relative luminous flux Φ , luminous efficacy η , electrical power P and lamp life t.

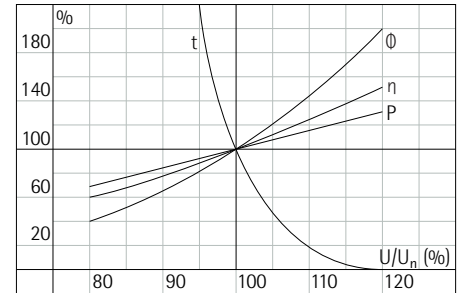

Luminous flux $\frac{\Phi}{\Phi_n} = \left(\frac{U}{U_n}\right)^{3.8}$

Luminous efficacy $\frac{\eta}{\eta_n} = \left(\frac{U}{U_n}\right)^{2.3}$

Power $\frac{P}{P_n} = \left(\frac{U}{U_n}\right)^{1.5}$

Lamp life $\frac{t}{t_n} = \left(\frac{U}{U_n}\right)^{-14}$

Colour temperature $\frac{T_f}{T_{fn}} = \left(\frac{U}{U_n}\right)^{0.4}$

Exponential correlation between the relative voltage U/U_n and electrical and photometric quantities.

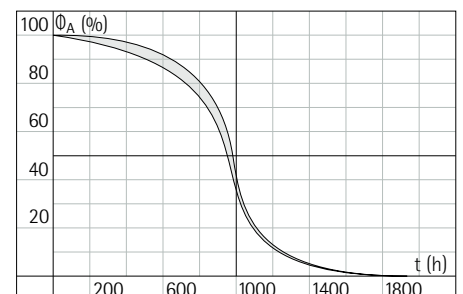
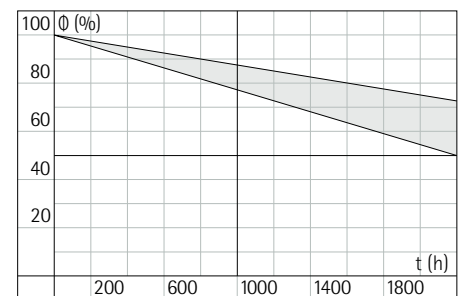
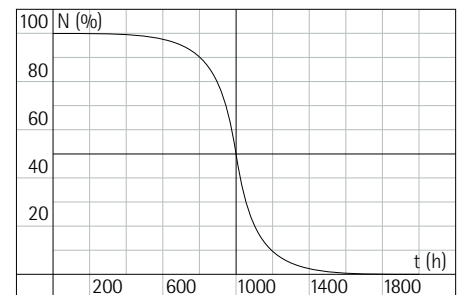

Proportion of operating lamps N, lamp lumens Φ and luminous flux of total installation Φ_A (as the product of both values) as a function of the operating time t.

2.3 Light and light sources
2.3.1 Incandescent lamps

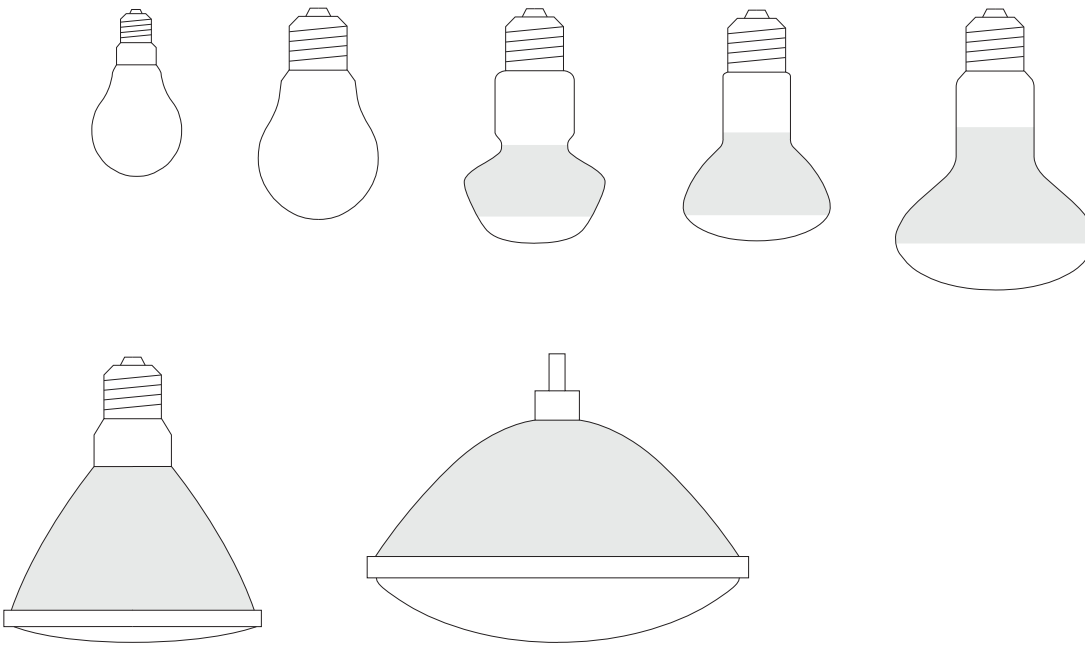

Top row (from left to right): decorative lamp, general service lamp, reflector lamp with soft glass bulb and ellipsoidal or parabolic reflector, producing medium beam characteristics. Bottom row (from left to right): reflector lamp with pressed glass bulb and efficient parabolic reflector (PAR lamp), available for narrow-beam (spot) and wide-beam (flood), also suitable for exterior application due to its high resistance to changes in temperature; high-power pressed-glass reflector lamp.

PAR lamp with dichroic cool-beam reflector. Visible light is reflected, infrared radiation transmitted, thereby reducing the thermal load on the illuminated objects.

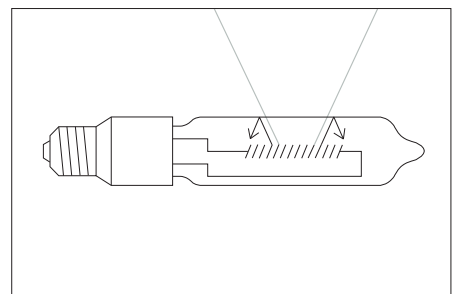
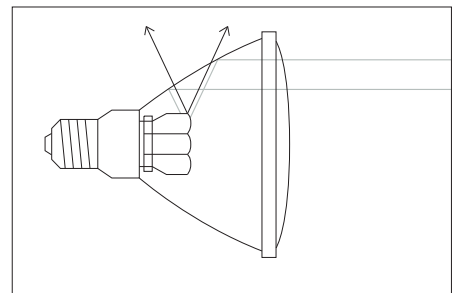

Incandescent lamp with glass bulb coated with dichroic material (hot mirror). This allows visible light to be transmitted; infrared radiation is reflected back to the filament. The increase in the temperature of the filament results in increased luminous efficacy.

2.3.1.1 Halogen lamps

It is not so much the melting point of the tungsten (which, at 3653 K, is still a relatively long way from the approx. 2800 K of the operating temperature of incandescents) that hinders the construction of more efficient incandescent lamps, but rather the increasing rate of evaporation of the filament that accompanies the increase in temperature. This initially leads to lower performance due to the blackening of the surrounding glass bulb until finally the filament burns through. The price to be paid for an increase in luminous efficiency is therefore a shorter lamp life.

One technical way of preventing the blackening of the glass is the adding of halogens to the gas mixture inside the lamp. The evaporated tungsten combines with the halogen to form a metal halide, which takes on the form of a gas at the temperature in the outer section of the lamp and can therefore leave no deposits on the glass bulb. The metal halide is split into tungsten and halogen once again at the considerably hotter filament and the tungsten is then returned to the coil.

The temperature of the outer glass envelope has to be over 250° C to allow the development of the halogen cycle to take place. In order to achieve this a compact bulb of quartz glass is fitted tightly over the filament. This compact form not only means an increase in temperature, but also an increase in gas pressure, which in turn reduces the evaporation rate of the tungsten.

Compared with the conventional incandescent the halogen lamp gives a whiter light – a result of its higher operating temperature of 3000 to 3300 K; its luminous colour is still in the warm white range. The continuous spectrum produces excellent colour rendering properties. The compact form of the halogen lamp makes it ideal as a point-source lamp; its light can be handled easily and it can create attractive sparkling effects. The luminous efficacy of halogen lamps is well above that of conventional incandescents – especially in the low-voltage range. Halogen lamps may have a dichroic, heat-reflecting coating inside the bulbs, which increases the luminous efficacy of these lamps considerably.

The lamp life of halogen lamps is longer than that of conventional incandescents. Halogen lamps are dimmable. Like conventional incandescent lamps, they require no additional control gear; low-voltage halogen lamps do have to be run on a transformer, however. In the case of double-ended lamps, projector lamps and special purpose lamps for studios the burning position is frequently restricted. Some tungsten halogen lamps have to be operated with a protective glass cover.

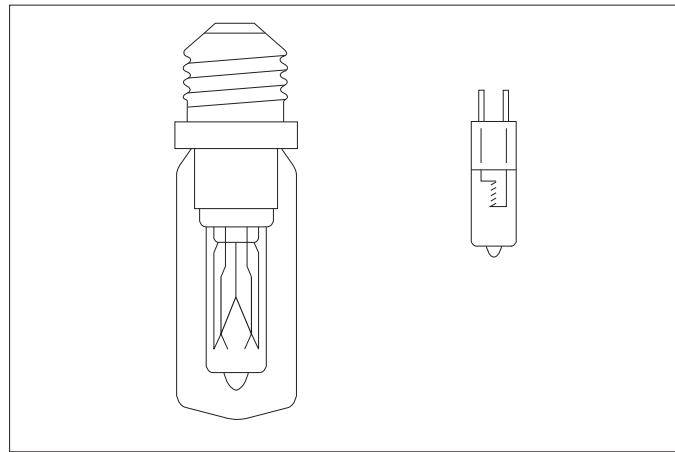

Halogen lamp for mains voltage with screw cap and outer envelope (left). The outer envelope means that the lamp can be operated without a protective glass covering. Low-voltage halogen lamp with pin base and axial filament in a quartz glass bulb (right).

Halogen cycle: combination of evaporated tungsten and halogen to produce tungsten halide in the peripheral area. Splitting of the tungsten halogens back to the filament.

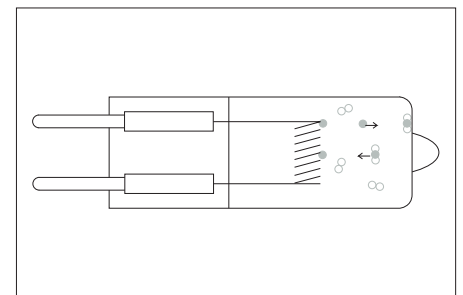

Proportion of operating lamps N as a function of the operating time t.

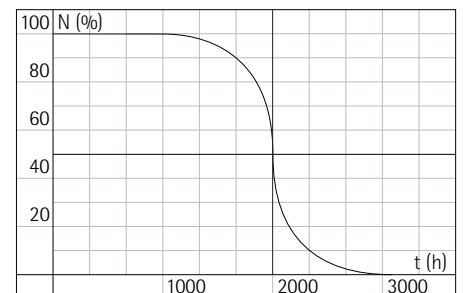

Influence of overvoltage and undervoltage on relative luminous flux Φ , luminous efficacy η , electrical power P and lamp life t.

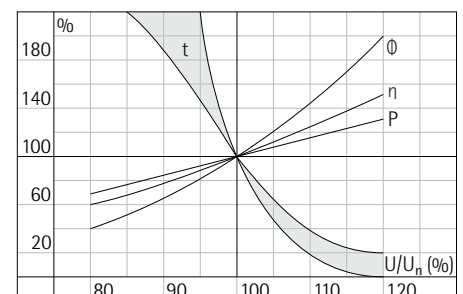

2.3 Light and light sources

2.3.1 Incandescent lamps

Like almost all conventional incandescent lamps, halogen lamps can be run on mains voltage. They usually have special caps, but some are equipped with an E 27 screw cap and an additional glass envelope and can be used in the same way as conventional incandescents.

As well as mains voltage halogen lamps, low-voltage halogen lamps are also gaining in importance. The advantages of this latter light source – high luminous efficiency in a small-dimensioned lamp – resulted in wide application of low-voltage halogen lamps in the field of architectural lighting.

The lamp's small size allows compact luminaire designs and concentrated spread angles. Low-voltage halogen lamps are available for different voltages (12/ 24 V) and in different shapes. Here too a selection can be made between clear lamps and various lamp and reflector combinations, or cool-beam reflector versions.

The halogen and low-voltage halogen lamps most commonly used in interior lighting.

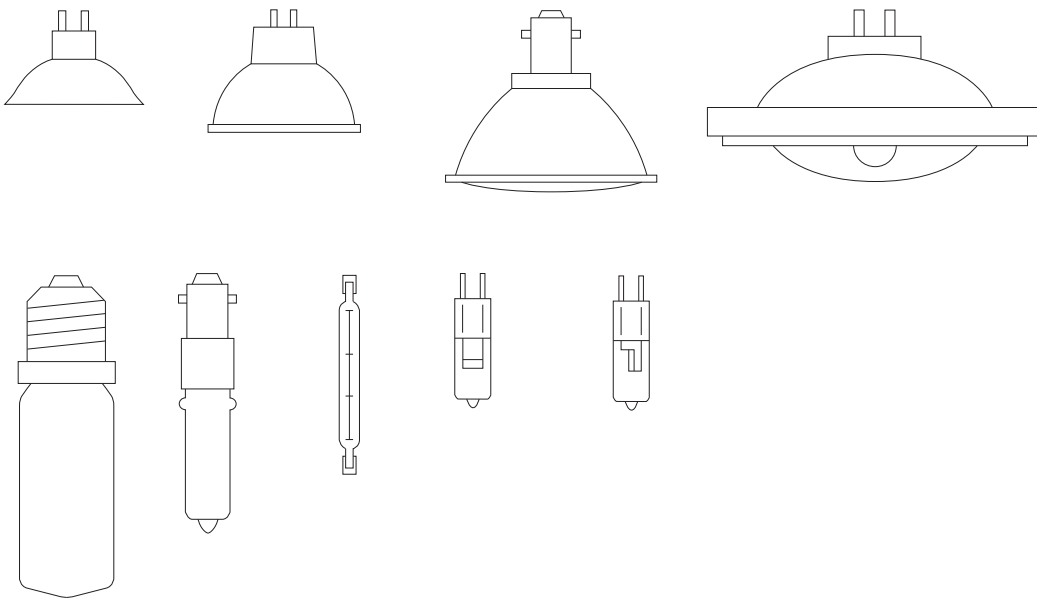

Above (from left to right): low-voltage halogen bi-pin lamp and aluminium reflector, bi-pin and cool-beam glass reflector, with bayonet connection and aluminium reflector, with an aluminium reflector for increased power.

Below (from left to right): halogen lamp for mains voltage with an E 27 cap and outer glass envelope, with a bayonet cap, and the double-ended version. Low-voltage halogen lamp with transverse filament and axial filament.

2.3 Light and light sources

2.3.1 Incandescent lamps

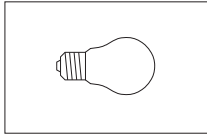

General service lamp				
Des.	P (W)	(lm)	l (mm)	d (mm)
A60	60	730	107	60
A60	100	1380	107	60
A65	150	2220	128	65
A80	200	3150	156	80
Cap: E27/E40		Lamp life 1000 h		

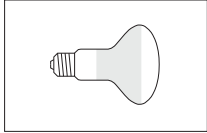

Reflector lamp				
Des.	P (W)	(lm)	l (mm)	d (mm)
R63	60	650	103	63
R80	100	1080	110	80
R95	100	1030	135	95
Cap: E27		Lamp life 1000 h		

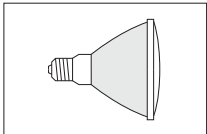

Parabolic reflector lamp				
Des.	P (W)	(lm)	l (mm)	d (mm)
PAR38	60	600	136	122
	80	800		
	120	1200		
Cap: E27		Lamp life 2000 h		

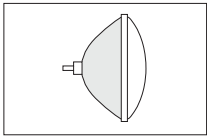

Parabolic reflector lamp				
Des.	P (W)	(lm)	l (mm)	d (mm)
PAR56	300	3000	127	179
Cap: GX16d		Lamp life 2000 h		

General service lamps, reflector lamps and two standard PAR lamps for mains voltage with data regarding lamp classification, power P, luminous flux Φ , lamp length l and lamp diameter d.

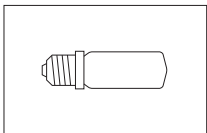

Halogen lamp				
Des.	P (W)	(lm)	l (mm)	d (mm)
QT32	75	1050	85	32
	100	1400	85	
	150	2500	105	
	250	4200	105	
Cap: E27		Lamp life 2000 h		

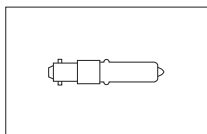

Halogen lamp				
Des.	P (W)	(lm)	l (mm)	d (mm)
QT18	75	1050	86	18
	100	1400	86	
	150	2500	98	
	250	4200	98	
Cap: B15d		Lamp life 2000 h		

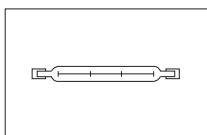

Halogen lamp				
Des.	P (W)	(lm)	l (mm)	d (mm)
QT-DE12	100	1650	75	12
	150	2500	75	
	200	3200	115	
	300	5000	115	
	500	9500	115	
Cap: R7s-15		Lamp life 2000 h		

Single and double-ended halogen lamps for mains voltage.

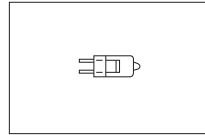

LV halogen lamp				
Des.	P (W)	(lm)	l (mm)	d (mm)
QT9	10	140	31	9
	20	350		
Cap: G4		Lamp life 2000 h		

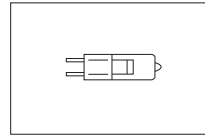

LV halogen lamp				
Des.	P (W)	(lm)	l (mm)	d (mm)
QT12	50	950	44	12
	75	1600		
	100	2500		
Cap: GY6.35		Lamp life 2000 h		

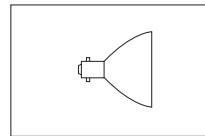

LV halogen reflector lamp				
Des.	P (W)	(lm)	l (mm)	d (mm)
QR38	20	7000	38	38
QR58	50	18000	59	58
Cap: B15d		Lamp life 2000 h		

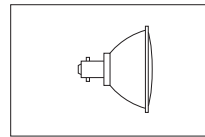

LV halogen reflector lamp				
Des.	P (W)	(lm)	l (mm)	d (mm)
QR70	20	5000	50	70
	75	15000		
	75	19000		
Cap: B15d		Lamp life 2000 h		

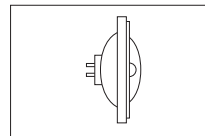

LV halogen reflector lamp				
Des.	P (W)	(lm)	l (mm)	d (mm)
QR111	50	20000	45	111
	75	25000		
	100	45000		
Cap: G53		Lamp life 2000 h		

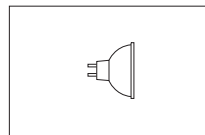

LV halogen cool-beam reflector lamp				
Des.	P (W)	(lm)	l (mm)	d (mm)
QR-CB35	20	5000	37/44	35
QR-CB35	35	8000		
Cap: GZ4		Lamp life 2000 h		

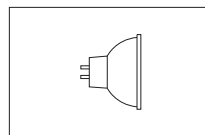

LV halogen cool-beam reflector lamp				
Des.	P (W)	(lm)	l (mm)	d (mm)
QR-CB51	20	8000	45	51
QR-CB51	35	13000		
	50	15000		
	65/70	20000		
Cap: GX5.3		Lamp life 3000 h		

Low-voltage halogen lamps, clear, with metal reflector or with cool-beam reflector.

2.3.2 Discharge lamps

In contrast to incandescent lamps, light from discharge lamps is not produced by heating a filament, but by exciting gases or metal vapours. This is effected by applying voltage between two electrodes located in a discharge tube filled with inert gases or metal vapours. Through the voltage current is produced between the two electrodes. On their way through the discharge tube the electrons collide with gas atoms, which are in turn excited to radiate light, when the electrons are travelling at a sufficiently high speed. For every type of gas there is a certain wavelength combination; radiation, i.e. light, is produced from one or several narrow frequency ranges.

If the speed of the electrons increases, the gas atoms are no longer excited on collision, but ionised; the gas atom is decomposed to create a free electron and a positively charged ion. The number of electrically charged, effective particles in the discharge tube is accordingly increased, giving rise to a corresponding increase in radiation.

It soon becomes evident that discharge lamps have different properties to incandescent lamps. This applies in the first place to the means by which the light of the respective lamp is produced. Whereas incandescent lamps have a continuous spectrum dependent on the temperature of the filament, discharge lamps produce a spectrum with narrow bands that are typical for the respective gases or metal vapours. The spectral lines can occur in all regions of the spectrum, from infrared through the visible region to ultraviolet. The number and distribution of the spectral lines results in light of different luminous colours. These can be determined by the choice of gas or metal vapour in the discharge tube, and as a result white light of various colour temperatures can be produced. Moreover, it is possible to exceed the given limit for thermal radiators of 3650 K and produce daylight-quality light of higher colour temperatures. Another method for the effective production of luminous colours is through the application of fluorescent coatings on the interior surfaces of the discharge tube. Ultraviolet radiation in particular, which occurs during certain gas discharge processes, is transformed into visible light by means of these fluorescent substances, through which specific luminous colours can be produced by the appropriate selection and mixing of the fluorescent material.

The quality of the discharge lamp can also be influenced by changing the pressure inside the discharge tube. The spectral lines spread out as the pressure increases, approaching continuous spectral distribution. This results in enhanced colour rendering and luminous efficacy.

Apart from the differences in the kind of light they produce, there are also differences between incandescent and discharge lamps when it comes to operating conditions. Incandescent lamps can be run on the mains without any additional control gear. They produce light as soon as they are switched on. In the case of discharge lamps, however, there are various special ignition and operating conditions.

To ignite a discharge lamp there must be sufficient electron current in the discharge tube. As the gas that is to be excited is not ionised before ignition, these electrons must be made available via a special starting device. Once the discharge lamp has been ignited there is an avalanche-like ionisation of the excited gases, which in turn leads to a continuously increasing operating current, which would increase and destroy the lamp in a relatively short time. To prevent this from happening the operating current must be controlled by means of a ballast.

Additional equipment is necessary for both the ignition and operation of discharge lamps. In some cases, this equipment is integrated into the lamp; but it is normally installed separate from the lamp, in the luminaire.

The ignition behaviour and performance of discharge lamps depend on the operating temperature; in some cases this leads to lamp forms with additional glass bulbs. If the current is interrupted it is usually necessary to allow the lamp to cool down for a while before restarting it. Instant reignition is only possible if the starting voltage is very high. There are special requirements for some of the lamps regarding the burning position.

Discharge lamps can be divided into two main groups depending on the operating pressure. Each of these groups has different properties. One group comprises low-pressure discharge lamps. These lamps contain inert gases or a mixture of inert gas and metal vapour at a pressure well below 1 bar. Due to the low pressure inside the discharge tube there is hardly any interaction between the gas molecules. The result is a pure line spectrum.

The luminous efficacy of low-pressure discharge lamps is mainly dependent on lamp volume. To attain adequate luminous power the lamps must have large discharge tubes.

High-pressure discharge lamps, on the other hand, are operated at a pressure well above 1 bar. Due to the high pressure and the resulting high temperatures there is a great deal of interaction in the discharge gas. Light is no longer radiated in narrow spectral lines but in broader frequency ranges. In general, radiation shifts with increasing pressure into the long-wave region of the spectrum.

The luminous power per unit of volume is far greater than that of a low-pressure

discharge; the discharge tubes are small. High-pressure discharge lamps – similar to incandescent lamps – are point sources with high lamp luminance. As a rule the actual discharge tubes are surrounded by an additional outer envelope, which stabilises the operating temperature of the lamp, or, if necessary, serves as a UV filter and can be used as a means of containing the fluorescent coating.

2.3.2.1 Fluorescent lamps

The fluorescent lamp is a low-pressure discharge lamp using mercury vapour. It has an elongated discharge tube with an electrode at each end. The gas used to fill the tube comprises inert gas, which ignites easily and controls the discharge, plus a small amount of mercury, the vapour of which produces ultraviolet radiation when excited. The inner surface of the discharge tube is coated with a fluorescent substance that transforms the ultraviolet radiation produced by the lamp into visible light by means of fluorescence.

To facilitate ignition of the fluorescent lamp the electrodes usually take the form of wire filaments and are coated with metallic oxide (emissive material) that promotes the flow of electrons. The electrodes are preheated at the ignition stage, the lamp ignites when the voltage is applied.

Different luminous colours can be achieved through the combination of appropriate fluorescent materials. To achieve this three different luminous substances are frequently combined, which, when mixed together, produce white light. Depending on the composition of the luminous substances, a warm white, neutral white or daylight white colour is produced.

In contrast to point sources (see incandescent lamps, above) the light from fluorescent sources is radiated from a larger surface area. The light is predominantly diffuse, making it more suitable for the uniform illumination of larger areas than for accent lighting.

The diffuse light of the fluorescent lamp gives rise to soft shadows. There are no sparkling effects on glossy surfaces. Spatial forms and material qualities are therefore not emphasised. Fluorescent lamps produce a spectrum, which is not continuous, which means that they have different colour rendering compared with incandescent lamps. It is possible to produce white light of any colour temperature by combining fewer fluorescent materials, but this light still has poorer colour rendering properties than light with a continuous spectrum due to the missing spectral components. To produce fluorescent lamps with very good colour rendering properties more luminous sub-

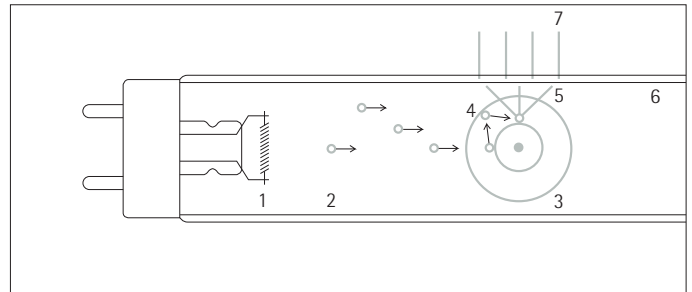

When leaving the electrode (1) the electrons (2) collide with mercury atoms (3). The mercury atoms (4) are thus excited and in turn produce UV radiation (5). The UV radiation is transformed into visible light (7) in the fluorescent coating (6).

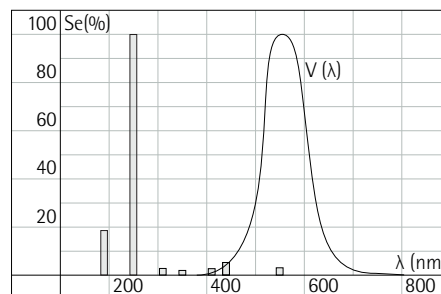

Relative spectral distribution $S_e(\lambda)$ of low-pressure discharge of mercury vapour. The radiation produced is to a large extent beyond the spectral sensitivity of the eye $V(\lambda)$.

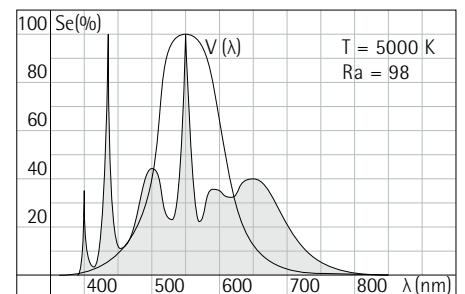
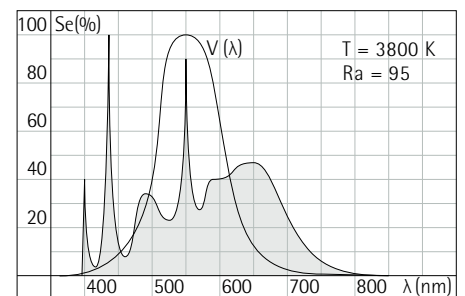
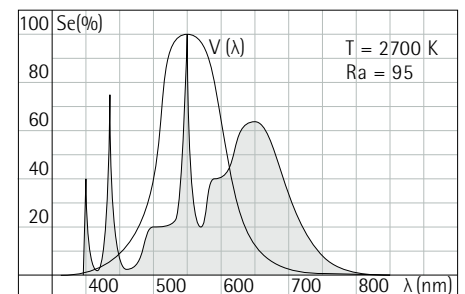

Relative spectral distribution $S_e(\lambda)$ of standard fluorescent lamps with very good colour rendering in warm white (above), neutral white (centre) and daylight white (below).

2.3 Light and light sources

2.3.2 Discharge lamps

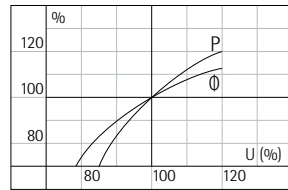
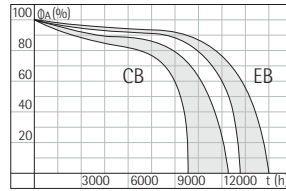
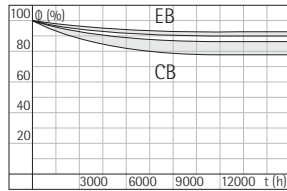
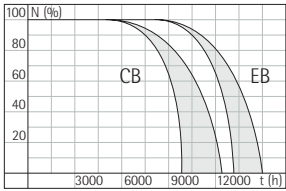

Effect of overvoltage and undervoltage on relative luminous flux Φ and electrical power P.

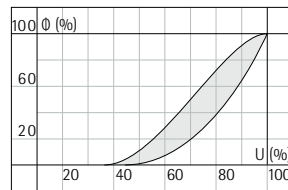

Relative luminous flux Φ of fluorescent lamps as a function of voltage.

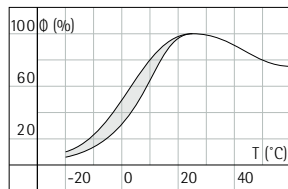

The effect of ambient temperature T on lamp lumens Φ .

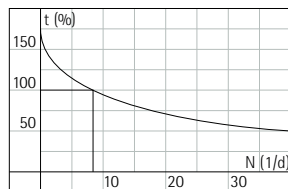

Lamp life t as a function of switching frequency per day N. Nominal lamp life of 100 % is achieved at a switching rate of 8 times every 24 hours.

Proportion of operating lamps N, lamp lumens Φ and luminous flux of total installation Φ_A (as the product of both values) as a function of the operating time t. Through the application of electronic control gear (EB) the operating quality of the lamps is improved by comparison with the operation with conventional control gear (CB).

stances have to be combined in such a way that the spectral distribution corresponds as closely as possible to that of a continuous spectrum.

Fluorescent lamps have a high luminous efficacy. They have a long lamp life, but this reduces considerably the higher the switching rate. Both ignitors and ballasts are required for the operation of fluorescent lamps. Fluorescent lamps ignite immediately and attain full power within a short period of time. Instant reignition is possible after an interruption of current. Fluorescent lamps can be dimmed. There are no restrictions with regard to burning position.

Fluorescent lamps are usually tubular in shape, whereby the length of the lamp is dependent on the wattage. U-shaped or ring-shaped fluorescents are available for special applications. The diameter of the lamps is 26 mm (and 16 mm). Lamp types with a diameter of 38 mm are of little significance.

Fluorescent lamps are available in a wide range of luminous colours, the main ones being warm white, neutral white and daylight white. There are also lamps available for special purposes (e.g. for lighting food displays, UV lamps) and coloured lamps. The colour rendering properties of fluorescents can be improved at the cost of the luminous efficacy; enhanced luminous efficacy therefore means a deterioration in the colour rendering quality.

Fluorescent lamps are usually ignited via an external starting device and preheated electrodes. Some models have integrated ignition, which means that they can do without a starting device altogether. These are mainly used in enclosed luminaires, for environments where there is a risk of explosion.

2.3.2.2 Compact fluorescent lamps

Compact fluorescent lamps do not function any differently from conventional fluorescent lamps, but they do have a more compact shape and consist of either one curved discharge tube or the combination of several short ones. Some models have an outer glass envelope around the discharge tube, which changes the appearance and the photometric properties of the lamp.

Compact fluorescent lamps basically have the same properties as conventional fluorescents, that is to say, above all, high luminous efficacy and a long lamp life. Their luminous efficiency is, however, limited due to the relatively small volume of the discharge tube. The compact form does offer a new set of qualities and fields of application. Fluorescent lamps in this form are not only confined to application in louvred luminaires, they can also be used in compact reflector luminaires (e.g. downlights). This means that concentra-

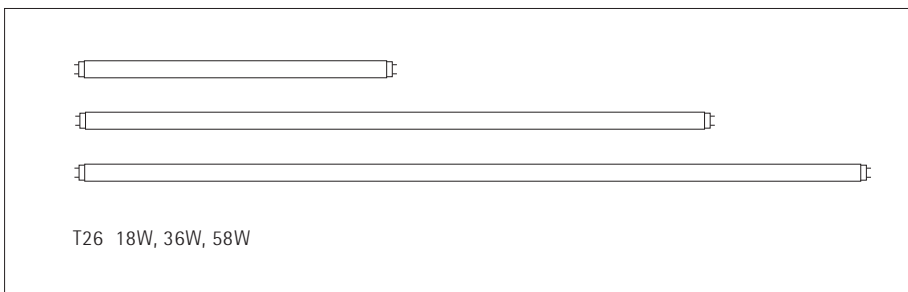

Comparison of lengths of standard T26 fluorescent lamps.

2.3 Light and light sources
2.3.2 Discharge lamps

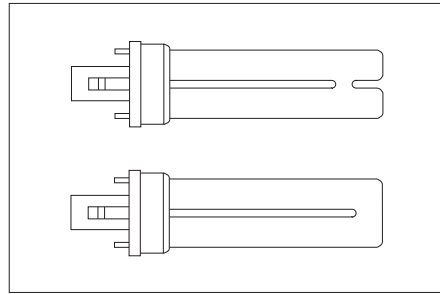

In contrast to conventional fluorescent lamps, in the case of compact fluorescents both ends of the discharge tube(s) are mounted on a single cap.

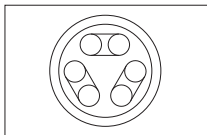
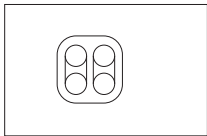

Arrangement of tubes in compact fluorescent lamps: TC/TC-L (above), TC-D (centre), TC-DEL (below).

Compact fluorescent lamps with two-pin plug-in cap and integral starting device (above), four-pin plug-in cap for operation on electronic control gear (centre), screw cap with integral ballast for mains operation (below).

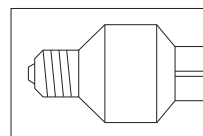
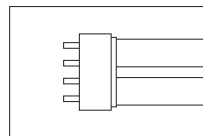
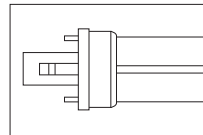

ted light can be produced to accentuate the qualities of illuminated objects by creating shadows.

Compact fluorescent lamps with an integrated starting device cannot be dimmed, but there are models available with external igniting devices and four-pin bases that can be run on electronic control gear, which allows dimming.

Compact fluorescent lamps are mainly available in the form of tubular lamps, in which each lamp has a combination of two or four discharge tubes. Starting device and ballast are required to operate these lamps; in the case of lamps with two-pin plug-in caps the starting device is integrated into the cap.

Alongside the standard forms equipped with plug-in caps and designed to be run on ballasts, there is a range of compact fluorescent lamps with integrated starting device and ballast; they have a screw cap and can be used like incandescent lamps. Some of these lamps have an additional cylindrical or spherical glass bulb or cover to make them look more like incandescent lamps. If these lamps are used in luminaires designed to take incandescent lamps it should be noted that the luminaire characteristics will be compromised by the greater volume of the lamp.

2.3.2.3 High-voltage fluorescent tubes

High-voltage fluorescent tubes work on the principle of low-pressure gas discharge, the gas being either an inert or rare gas or a mixture of inert gas and mercury vapour. In contrast to fluorescent lamps, the electrodes contained in these lamps are not heated, which means they have to be ignited and run on high voltage. As there are special regulations concerning installations run at 1000 V and more, high-voltage tubular lamps are usually operated at less than 1000 V. There are, however, high-voltage discharge lamps available that run at over 1000 V.

High-voltage fluorescent tubes have a considerably lower luminous efficacy than conventional fluorescent lamps, but they have a long lamp life. Rare-gas discharge does not allow much scope when it comes to producing different colours; red can be produced using neon gas or blue using argon. To extend the spectrum of colours available it is possible to use coloured discharge tubes. However, mercury is usually added to the inert gas and the resulting ultraviolet radiation transformed into the desired luminous colours using fluorescent material. High-voltage fluorescent tubes require a ballast; they are operated on leakage transformers, which manage the high voltages required for ignition and operation. High-voltage

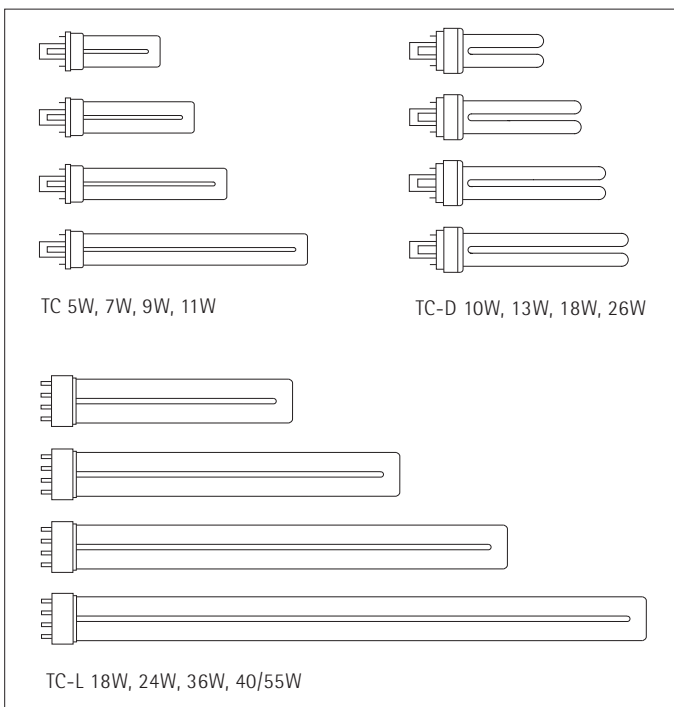

Comparison of sizes of standard TC, TC-D and TC-L compact fluorescent lamps.

2.3 Light and light sources
2.3.2 Discharge lamps

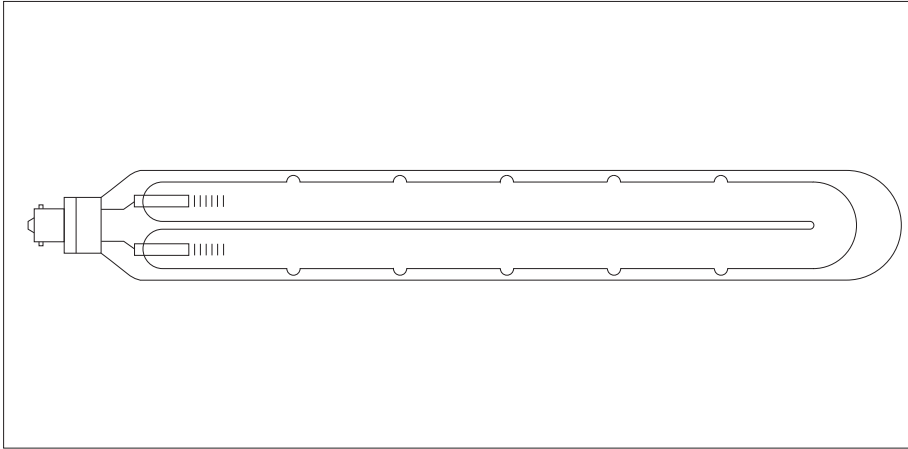

Low-pressure sodium lamp with U-shaped discharge tube in a dichroic glass bulb. The infrared radiation produced by the lamp is reflected back into the discharge tube via the dichroic coating on the glass, thereby cutting down the time required to reach operating temperature.

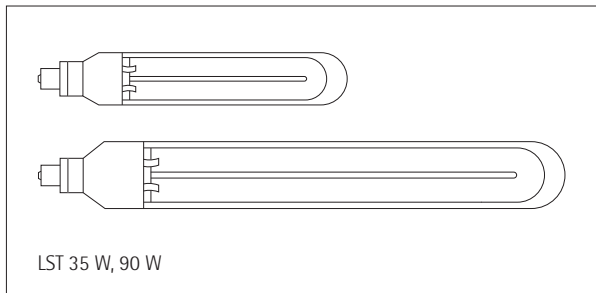

Comparison of sizes of low-pressure sodium lamps (LST).

fluorescent tubes ignite instantly and they can be restarted when hot. There are no restrictions with regard to burning position.

High-voltage fluorescent tubes come in various diameters and lengths. Different tubular shapes can be manufactured to meet the requirements of specific applications, e.g. for written signs and company logos. They are available in a variety of colours.

2.3.2.4 Low-pressure sodium lamps

Low-pressure sodium lamps are comparable to fluorescent lamps in the way they are constructed and how they operate. In this case sodium vapour is excited instead of mercury vapour. This leads to a number of essential differences to fluorescent lamps. In the first place, sodium lamps are more difficult to ignite than mercury lamps, because solid sodium – as opposed to liquid mercury – does not produce metal vapour at room temperature. In the case of sodium lamps, ignition can only be effected with the aid of additional inert gas; only when the rare-gas discharge produces sufficient heat does the sodium begin to evaporate, thereby enabling the actual metal vapour discharge to take place. Low-pressure sodium lamps require high ignition voltage and a relatively long run-up time before they reach maximum efficacy. To guarantee a sufficiently high operating temperature, the discharge tube is usually encased in a separate glass envelope that is often designed to reflect infrared radiation.

Another difference is the kind of light the lamp produces. Whereas mercury vapour excited at low pressure produces mainly ultraviolet radiation, which is transformed into light with the aid of fluorescent substances, sodium vapour produces light directly. Low-pressure sodium lamps therefore require no luminous substances to be added. Moreover, the luminous efficacy of these lamps is so high that the lamp volume required is considerably smaller than is the case for fluorescent lamps.

The most striking feature of low-pressure sodium lamps is their extraordinarily high luminous efficacy. As the low-pressure sodium lamp has a very long lamp life, it is the most economically efficient light source available.

Low-pressure sodium vapour only produces light in two spectral lines which are very close together; the light radiated by the lamp is monochrome yellow. Due to its monochromatic character it does not produce any chromatic aberration in the eye and therefore guarantees visual acuity. The obvious disadvantage of these lamps with regard to the advantages mentioned above is their exceptionally poor colour rendering quality. Colour ren-

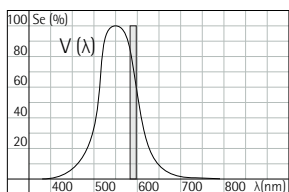

Relative spectral distribution $S_e(\lambda)$ of low-pressure sodium vapour discharge. The line spectrum produced is close to the maximum spectral sensitivity of the eye, but limits colour rendering through its monochromatic character.

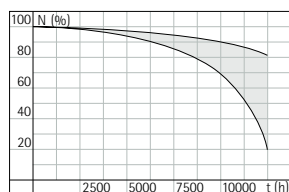

Proportion of operating lamps N , lamp lumens Φ and luminous flux of total installation Φ_A (as the product of both values) as a function of the operating time t .

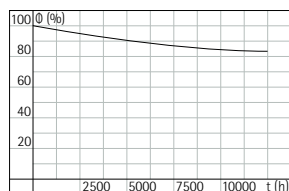

Run-up characteristic: lamp lumens Φ in relation to time t .

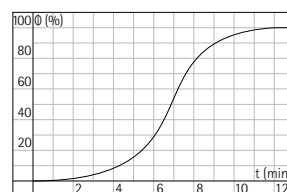
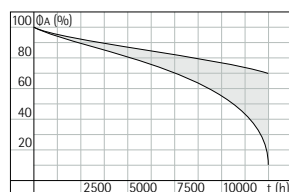

dering in the usual sense does not exist. All that is perceived is saturated yellow in various shades, from the pure colour to black. Low-pressure sodium lamps have therefore been replaced by high-pressure sodium lamps to a great extent, especially in their main field of application: street lighting.

A combination of ignitor and ballast is necessary to operate some of the tubular models, but usually a leakage transformer is used as a starting device and ballast. Low-pressure sodium lamps require a run-up time of a few minutes and a short cooling time before re-ignition. Instant re-ignition is possible if special control gear is used. There are restrictions regarding the burning position.

Low-pressure sodium lamps are normally U-shaped, sometimes also tubular, surrounded by an additional glass envelope.

2.3.2.5 High-pressure mercury lamps

High-pressure mercury lamps have a short quartz glass discharge tube that contains a mixture of inert gas and mercury. Electrodes are positioned at both ends of the discharge tube. In close proximity to one of the electrodes there is an additional auxiliary electrode for the ignition of the lamp. The discharge tube is surrounded by a glass envelope that stabilises the lamp temperature and protects the discharge tube from corrosion. The outer glass can be provided with a fluorescent coating to control the luminous colour.

When the lamp is ignited, there is an initial luminous discharge from the auxiliary electrode which gradually extends to the second main electrode. When the gas has been ionised in this way, there is an arc discharge between the two main electrodes, which, at this point in time, is the equivalent of a low-pressure discharge. Only when all the mercury has been evaporated via the arc discharge and the resulting heat has produced sufficient excess pressure, does high-pressure discharge take place and the lamp produce full power.

High-pressure mercury lamps have moderate luminous efficacy and a very long lamp life. As a light source they are relatively compact, which allows their light to be controlled via optical equipment.

The light produced by high-pressure mercury lamps is bluish-white in colour due to the lack of the red spectral range. Colour rendering is poor, but remains constant throughout the entire lamp life. A neutral white or warm white colour appearance and improved colour rendering properties are achieved by the addition of fluorescent materials.

Due to the integrated auxiliary electrode there is no need for high-pressure

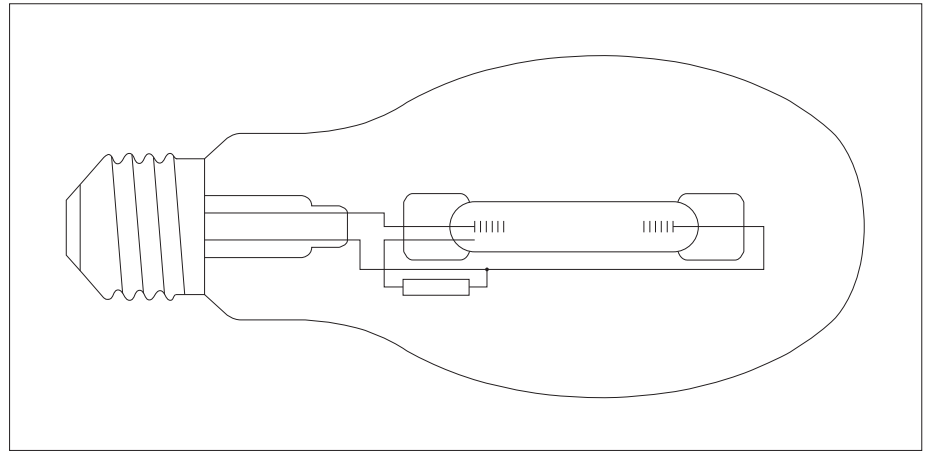

High-pressure mercury lamp with quartz glass discharge tube and elliptical bulb. As a rule the bulb is coated with a layer of fluorescent material which trans-

forms the UV radiation produced by the lamp into visible light, thereby improving luminous efficacy and colour rendering.

Standard high-pressure mercury lamps with elliptical bulb (HME), spherical bulb (HMG) and integrated reflector (HMR).

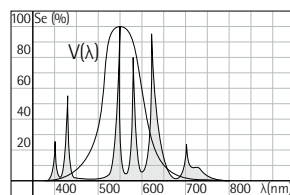
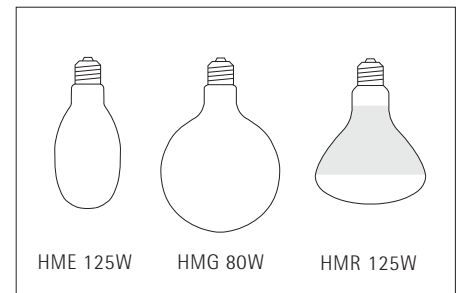

Relative spectral distribution $S_e(\lambda)$ of high-pressure mercury lamps.

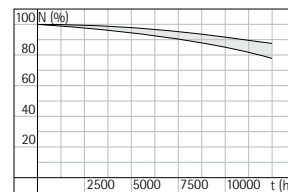

Proportion of operating lamps N , lamp lumens Φ and luminous flux of total installation Φ_A (as the product of both values) as a function of the operating time t .

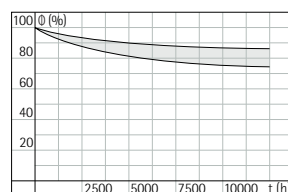

Run-up characteristic: lamp lumens Φ in relation to time t .

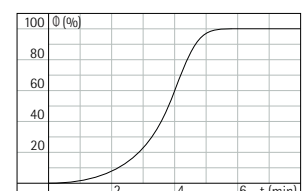
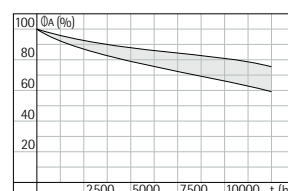

mercury lamps to have an ignitor, but they do have to be run on a ballast. High-pressure mercury lamps require a run up time of some minutes and a longer cooling time before restriking. There are no restrictions as to the burning position.

High-pressure mercury lamps are available in various shapes and sizes; the outer bulbs can be spherical, elliptical or mushroom-shaped, the latter versions being designed as reflector lamps.

2.3.2.6 Self-ballasted mercury lamps

Self-ballasted mercury lamps are basically constructed in the same way as high-pressure mercury lamps. They have an additional filament in the outer glass bulb, however, which is connected in series with the discharge tube. The filament takes on the role of a current limiter, making an external ballast unnecessary. The warm white light produced by the filament complements the missing red content in the mercury spectrum, which improves the colour rendering. Self-ballasted mercury lamps usually contain additional fluorescent material to enhance the luminous colour and improve the luminous efficacy.

Self-ballasted mercury lamps have similar qualities to high-pressure mercury lamps. Luminous efficacy and lamp life rates are not so good, however, with the consequence that they are seldom used for architectural lighting. Since they require no ignitor or control gear and are produced with an E 27 cap, self-ballasted mercury lamps can be used as incandescent lamps.

The filament in self-ballasted mercury lamps radiates light immediately on ignition. After a few minutes the incandescent component diminishes and the mercury vapour discharge reaches full power. Following an interruption to the mains supply self-ballasted mercury lamps require a cooling-off period. Self-ballasted mercury lamps cannot be dimmed. There are restrictions as to the burning position for certain lamp types.

Self-ballasted mercury lamps are available with an elliptical bulb or as mushroom-shaped reflector lamps.

Self-ballasted mercury lamp with a quartz glass discharge tube for high-pressure mercury discharge and an additional filament that takes on the function of preresistance and supplements the spectrum in the red range. The elliptical bulb is frequently provided with a coating of light-diffusing material.

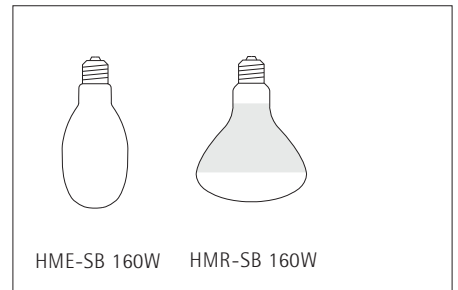
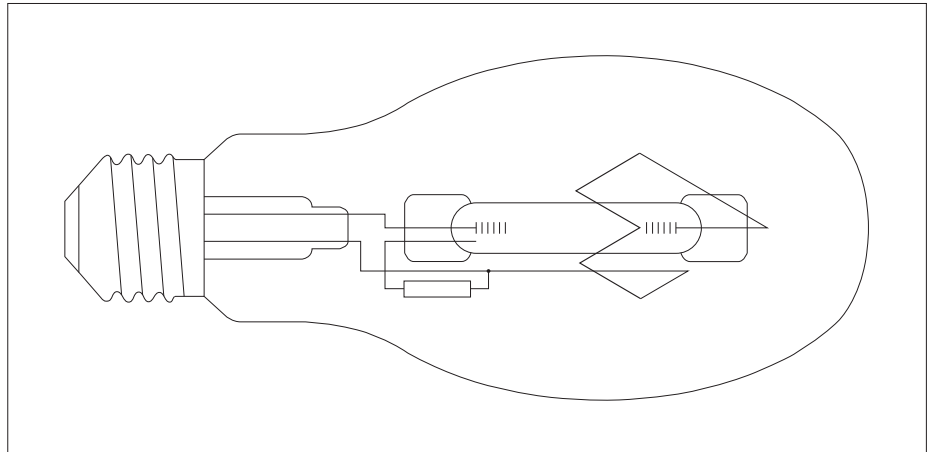

Standard self-ballasted mercury lamp with elliptical bulb (HME-SB), or integral reflector (HMR-SB).

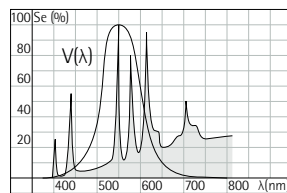

Relative spectral distribution $S_e(\lambda)$ of a self-ballasted mercury lamp with the combination of the spectra produced by the high-pressure mercury discharge and the filament.

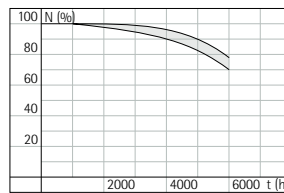

Proportion of functional lamps N , lamp lumen Φ and luminous flux of overall installation Φ_A (as the product of both values) in relation to the operating time t .

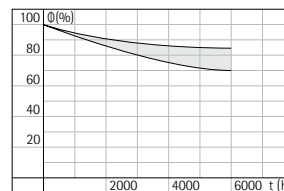

Run-up characteristic: lamp lumens Φ in relation to time t .

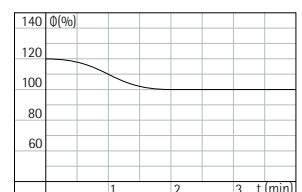
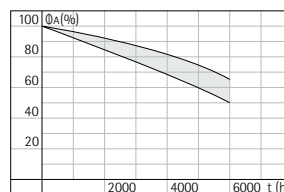

2.3.2.7 Metal halide lamps

Double-ended metal halide lamp with compact discharge tube and quartz glass outer envelope.

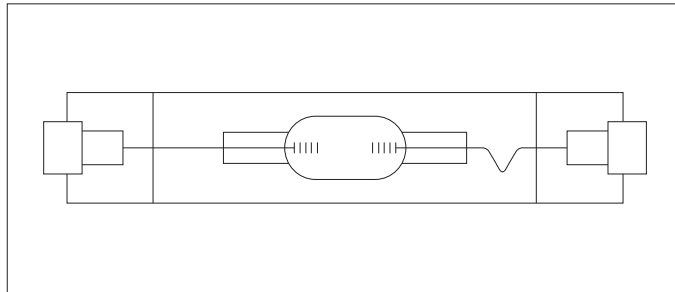

Metal halide lamps are a further development of mercury lamps and are therefore similar to these with regard to construction and function. Apart from mercury they also contain a mixture of metal halides. In contrast to pure metals, halogen compounds have the advantage that they melt at a considerably lower temperature. This means that metals that do not produce metal vapour when the lamp is in operation can also be used.

By adding metal halides, luminous efficacy is improved and, above all, colour rendering enhanced. If the metal combinations are correct then multi-line spectra can be produced, similar to those of fluorescent lamps; by using specific combinations it is possible to create a practically continuous spectrum consisting of numerous of spectral lines. Additional fluorescent substances to enhance colour rendering are not necessary. The mercury component primarily serves as an ignition aid and to stabilise the discharge process; when the metal halides have been evaporated via the initial mercury vapour discharge, these metal vapours essentially produce light.

The presence of halogens inside the lamp bulb means that auxiliary electrodes are not required as part of a starting device. Metal halide lamps require external control gear.

Metal halide lamps have excellent luminous efficacy and good colour rendering qualities; their nominal lamp life is high. They are extremely compact light sources, whose light can be easily controlled. The colour rendering and colour temperature of metal halide lamps is, however, not constant; it varies between individual lamps in a range and changes depending on the age of the lamp and the ambient conditions. This is particularly noticeable when it comes to the warm white lamps.

To operate metal halide lamps both an ignitor and a ballast are required. They require a run-up time of some minutes and a longer cooling time before restarting. Instant reignition is possible in the case of some double-ended types, but special ignitors or an electronic ballast is necessary. As a rule metal halide lamps cannot dimmed. The burning position is usually restricted.

Metal halide lamps are available in warm white, neutral white and daylight white, as single or double-ended tubular lamps, as elliptical lamps and as reflector lamps.

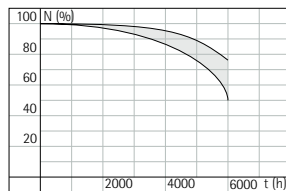

Proportion of functional lamps N , lamp lumens Φ and luminous flux of overall installation Φ_A (as the product of both values) in relation to the operating time t .

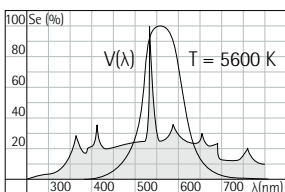
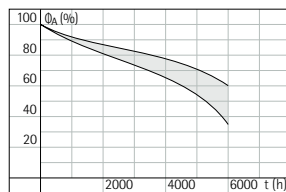
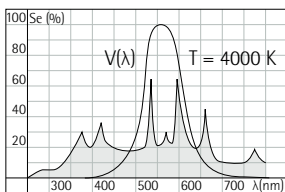
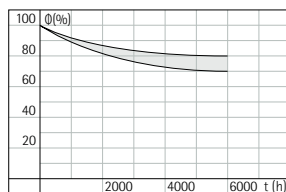
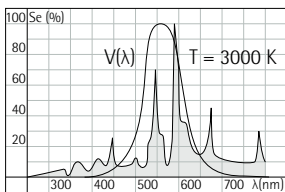

Relative spectral distribution $S_e(\lambda)$ of standard metal halide lamp with luminous colour warm white (above), neutral white (centre) and daylight white (below).

Decline in luminous flux Φ at different switching frequencies of 24, 12, 8, 3 and < 1 times per day.

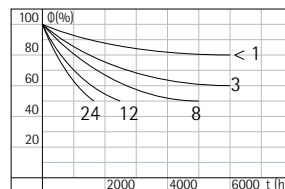

Run-up characteristic: lamp lumens Φ in relation to time t .

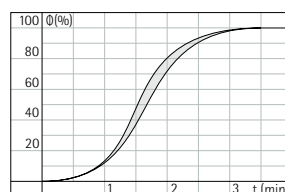

2.3.2.8 High-pressure sodium lamps

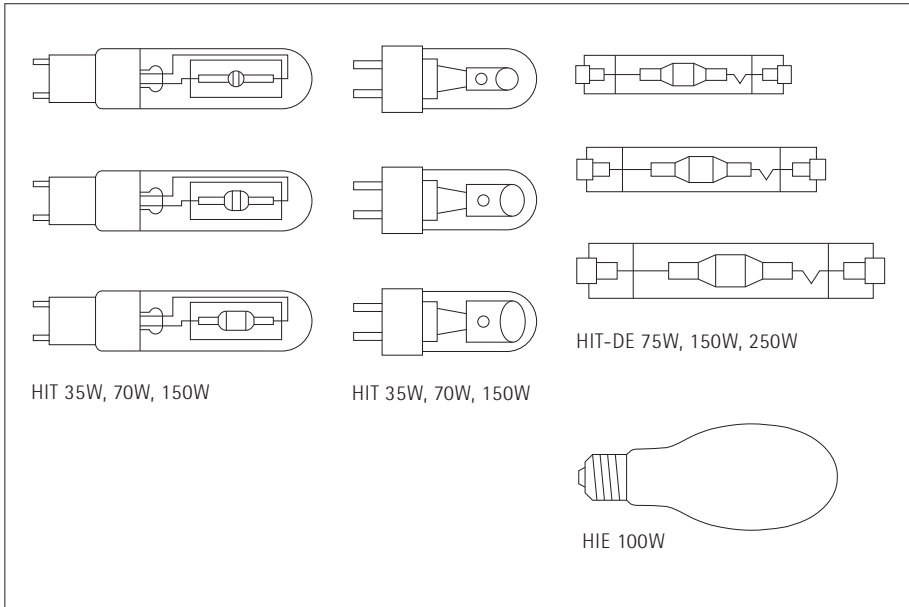

Standard metal halide lamps, single-ended (HIT) and double-ended versions (HIT-DE), plus elliptical version (HIE).

Single-ended high-pressure sodium lamp with ceramic discharge tube and additional outer glass envelope.

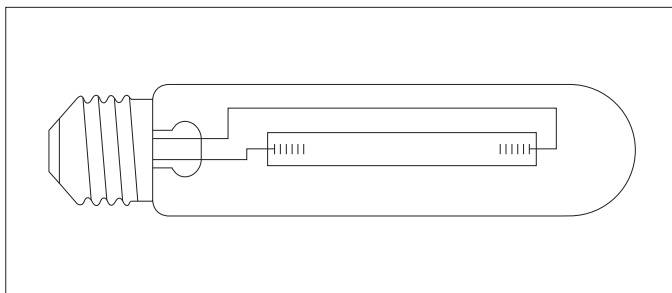

Similar to mercury lamps, the spectrum produced by sodium lamps can also be extended by increasing the pressure. If the pressure is sufficiently high the spectrum produced is practically continuous with the resultant enhanced colour rendering properties. Instead of the monochrome yellow light produced by the low-pressure sodium lamp, with the extremely poor colour rendering properties, the light produced is yellowish to warm white producing average to good colour rendering. The improvement in colour rendering is, however, at the cost of luminous efficacy. High-pressure sodium lamps are comparable to mercury lamps with regard to their construction and function. They also have a small discharge tube, which is in turn surrounded by a glass envelope. Whereas the discharge tube in high-pressure mercury lamps is made of quartz glass, the discharge tube in high-pressure sodium lamps is made of alumina ceramic, since high-pressure sodium vapours have an aggressive effect on glass. The lamps are filled with inert gases and an amalgam of mercury and sodium, such that the rare gas and mercury component serve to ignite the lamp and stabilise the discharge process.

The surrounding bulb of some high-pressure sodium lamps is provided with a special coating. This coating only serves to reduce the luminance of the lamp and to improve diffusion. It does not contain any fluorescent materials.

The luminous efficacy of high-pressure sodium lamps is not so high as that of low-pressure sodium lamps, but higher than that of other discharge lamps. These lamps have a long nominal lamp life. Colour rendering is average to good, distinctly better than that of monochrome yellow low-pressure sodium light.

High-pressure sodium lamps are run on a ballast and require an ignition device. They require a run-up time of some minutes and cooling time before restarting. Instant re-ignition is possible in the case of some double-ended types, but special ignition devices or an electronic ballast is necessary. As a rule there are no restrictions as to the burning position.

High-pressure sodium lamps are available as clear glass tubular lamps or with specially coated ellipsoidal bulbs. They are also available as compact, double-ended linear type lamps, which allow instant reignition and form an especially compact light source.

Standard high-pressure sodium lamps, single-ended ellipsoidal (HSE), tubular (HST), and double-ended tubular (HST-DE).

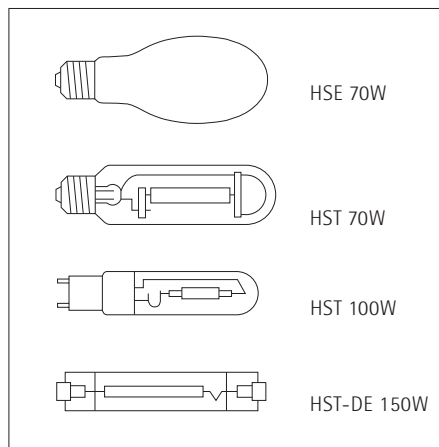

Relative spectral distribution $S_e(\lambda)$ of high-pressure sodium lamps. By increasing the pressure the spectrum is inverted, in contrast to low-pressure discharge. The result is wide spectral distribution with a minimum in the low-pressure sodium lamps.

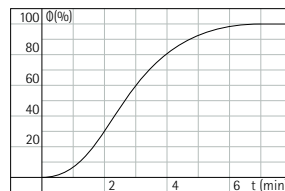
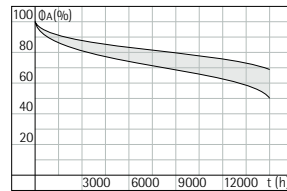
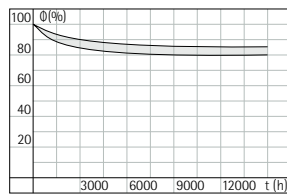
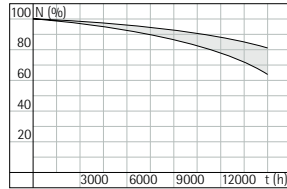
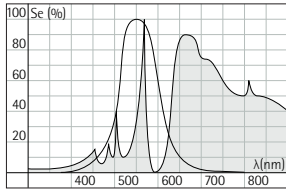

Run-up characteristic:
 lamp lumens Φ
 in re-lation to time t .

Proportion of functional lamps N , lamp lumens Φ and luminous flux of overall installation Φ_A (as the product of both values) in relation to the operating time t .

2.3 Light and light sources

2.3.2 Discharge lamps

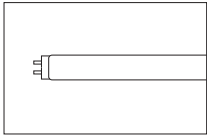

Fluorescent lamp				
Des.	P (W)	(lm)	l (mm)	d (mm)
T26	18	1350	590	26
	30	2400	895	
	36	3350	1200	
	38	3200	1047	
	58	5200	1500	
Cap: G13		Lamp life 7000 h		

Tubular fluorescent lamp (diameter 26 mm), of standard power.

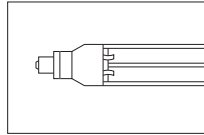

Low-pressure sodium lamp				
Des.	P (W)	(lm)	l (mm)	d (mm)
LST	35	4800	310	54
	55	8000	425	54
	90	13500	528	68
	Cap: BY22d		Lamp life 10000 h	

Single-ended low-pressure sodium lamp in the standard form with U-shaped discharge tube.

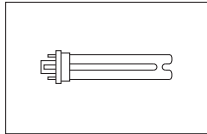

Compact fluorescent lamp				
Des.	P (W)	(lm)	l (mm)	d (mm)
TC	7	400	138	12
	9	600	168	
	11	900	238	
Cap: G23		Lamp life 8000 h		

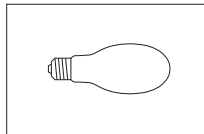

Mercury lamp				
Des.	P (W)	(lm)	l (mm)	d (mm)
HME	50	2000	130	55
	80	4000	156	70
	125	6500	170	75
	250	14000	226	90
Cap: E27/E40		Lamp life 8000 h		

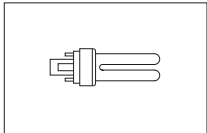

Compact fluorescent lamp				
Des.	P (W)	(lm)	l (mm)	d (mm)
TC-D	10	600	118	12
	13	900	153	
	18	1200	173	
	26	1800	193	
Cap: G24		Lamp life 8000 h		

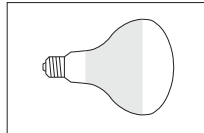

Mercury reflector lamp				
Des.	P (W)	(lm)	l (mm)	d (mm)
HMR	80	3000	168	125
	125	5000		
Cap: E27		Lamp life 8000 h		

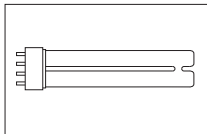

Compact fluorescent lamp				
Des.	P (W)	(lm)	l (mm)	d (mm)
TC-L	18	1200	225	17
	24	1800	320	
	36	2900	415	
	40	3500	535	
	55	4800	535	
Cap: 2G11		Lamp life 8000 h		

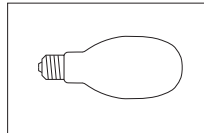

Self-ballasted mercury lamp				
Des.	P (W)	(lm)	l (mm)	d (mm)
HME-SB	160	3100	177	75
Cap: E27		Lamp life 5000 h		

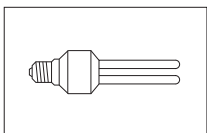

Compact fluorescent lamp				
Des.	P (W)	(lm)	l (mm)	d (mm)
TC-DEL	9	400	127	
	11	600	145	
	15	900	170	
	20	1200	190	
	23	1500	210	
Cap: E27		Lamp life 8000 h		

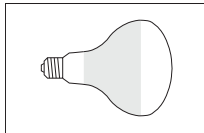

Self-ballasted mercury reflector lamp				
Des.	P (W)	(lm)	l (mm)	d (mm)
HMR-SB	160	2500	168	125
Cap: E27		Lamp life 5000 h		

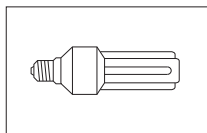

Compact fluorescent lamp				
Des.	P (W)	(lm)	l (mm)	d (mm)
TC-DEL	15	900	148	58
	20	1200	168	
	23	1500	178	
Cap: E27		Lamp life: 8000 h		

Compact fluorescent lamps in the standard shapes TC, TC-D and TC-L, and with integral electronic ballast and E 27 cap: TC-DEL.

High-pressure mercury lamps and self-ballasted mercury lamps, both lamp types with an ellipsoidal outer envelope and as a reflector lamp. Choice of power for interior lighting including data on lamp description; power P, luminous flux Φ , length of lamp l and lamp diameter d.

2.3 Light and light sources
2.3.2 Discharge lamps

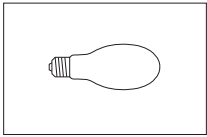

Metal halide lamp				
Des.	P (W)	(lm)	l (mm)	d (mm)
HIE	75	5500	138	54
	100	8500	138	54
	150	13000	138	54
	250	17000	226	90
Cap: E27/E40		Lamp life 5000 h		

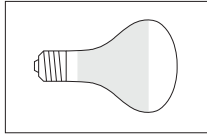

Metal halide reflector lamp				
Des.	P (W)	(lm)	l (mm)	d (mm)
HIR	250	13500	180	125
Cap: E40		Lamp life 6000 h		

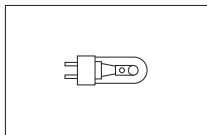

Metal halide lamp				
Des.	P (W)	(lm)	l (mm)	d (mm)
HIT	35	2400	84	26
	70	5200		
	150	12000		
Cap: G12/PG12		Lamp life 5000 h		

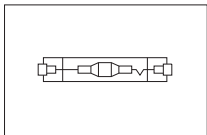
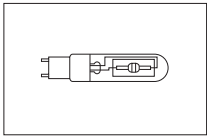

Metal halide lamp				
Des.	P (W)	(lm)	l (mm)	d (mm)
HIT-DE	75	5500	114	20
	150	11250	132	23
	250	20000	163	25
Cap: RX7s		Lamp life 5000 h		

Metal halide lamp, as an ellipsoidal and reflector lamp and as single and double-ended versions. Choice of standard wattages for interior lighting.

High-pressure sodium lamp, ellipsoidal plus tubular, single-ended and double-ended versions. Choice of standard wattages for interior lighting.

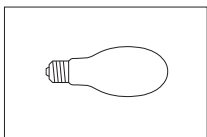

High-pressure sodium lamp				
Des.	P (W)	(lm)	l (mm)	d (mm)
HSE	50	3500	156	70
	70	5600	156	70
	100	9500	186	75
	150	14000	226	90
	250	25000	226	90
Cap: E27/E40		Lamp life 10000 h		

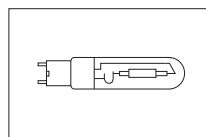

High-pressure sodium lamp				
Des.	P (W)	(lm)	l (mm)	d (mm)
HST	35	1300	149	32
	70	2300		
	100	4700		
Cap: PG12		Lamp life 5000 h		

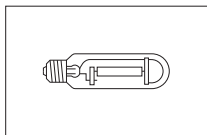

High-pressure sodium lamp				
Des.	P (W)	(lm)	l (mm)	d (mm)
HST	50	4000	156	37
	70	6500	156	37
	100	10000	211	46
	150	17000	211	46
	250	33000	257	46
Cap: E27/E40		Lamp life 10000 h		

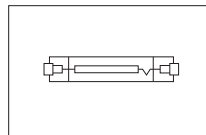

High-pressure sodium lamp				
Des.	P (W)	(lm)	l (mm)	d (mm)
HST-DE	70	7000	114	20
	150	15000	132	23
	Cap: RX7s		Lamp life 10000 h	

Compact fluorescent lamp with integral ballast and screw cap. This lamp is mainly used domestically as an economic alternative to the incandescent lamp

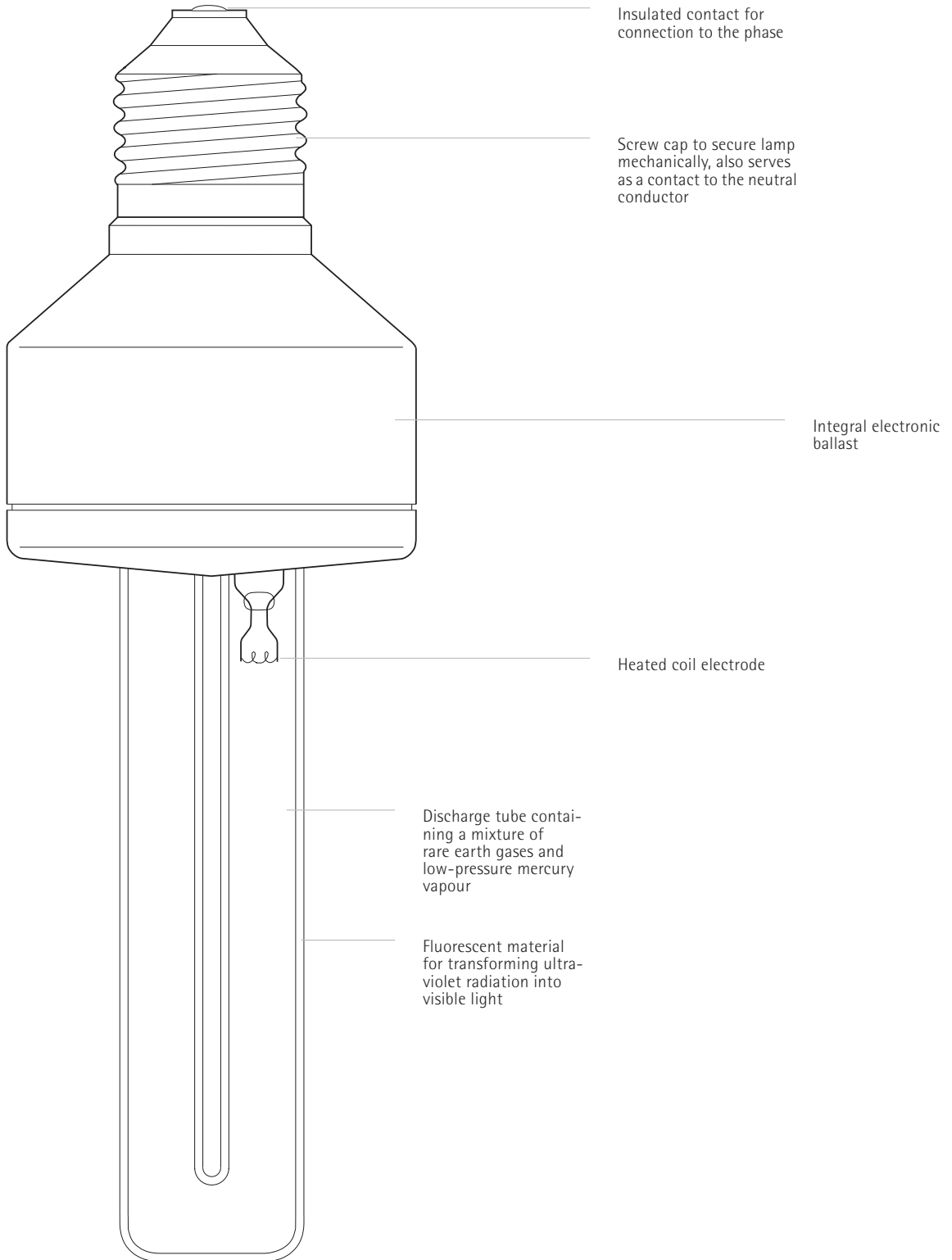

Control gear and control equipment

In addition to lamps and luminaires supplementary equipment is often required in order for a lighting installation to function. The most important additional equipment is control gear, which is necessary for the operation of many lamp types.

Lighting control equipment, on the other hand, is not required to operate the luminaires. It is used to switch luminaires on and off and to control their brightness – and sometimes also other luminaire characteristics.

2.4.1 Control gear for discharge lamps

Typical of all discharge lamps is their negative current versus voltage characteristic, i.e. the lower the voltage the higher the operating current. In contrast to incandescent lamps, where the filament acts as a current limiting device, the operating current in the case of discharge lamps is constantly on the increase due to the avalanche ionisation effect of the inert gas, which if left uncontrolled would result in the destruction of the lamp.

To operate discharge lamps it is therefore necessary to use a ballast to limit the current. In their simplest form these are ohmic current limiters. This type of current limiting device is not frequently used, however, since it tends to heat up, which in turn leads to substantial energy consumption; they are occasionally used for self-ballasted mercury lamps, which use a filament as an ohmic current limiter.

Current limitation using super-imposed capacitors – i.e. via capacitive reactance – reduces the loss of energy, but decreases the lamp life, so is similarly not a popular solution. In practice, current limitation is mainly effected via the application of inductive current limiting devices such as lag ballasts or transformers, especially as this kind of ballast has the added advantage that it can be used to produce the striking voltage to ignite the lamp. High-frequency electronic control gear is gaining importance alongside inductive ballasts. Besides their function as current limiting devices electronic ballasts also serve as ignitors and ensure that the lamp operates more effectively.

The ignition voltage of discharge lamps is well above their operating voltage and usually also above the mains voltage provided. Special equipment is therefore required to ignite the lamps. This may be a matter of auxiliary electrodes built into the lamp that ionise the gas in the lamp via a luminous discharge. However, ignition is usually effected via a voltage surge, which can be produced inductively by the starter and the ballast, but a leakage transformer or an ignitor is required in the case of higher ignition voltages.

More recently both electronic starters and electronic ignition devices have become available.

2.4.1.1 Fluorescent lamps

Fluorescent lamps can be operated on a *conventional ballast* (CB) and a starter. In this case the ballast functions as an inductive resistor; it comprises a lag ballast which consists of a laminate iron core and a copper-wire winding.

Conventional ballasts are the cheapest kind of ballasts, but they do give rise to significant losses of energy due to the generation of heat.

Low loss ballasts (LLB) are comparable to conventional ballasts, except that their core material is of a higher quality and they have thicker copper wires to reduce the loss of energy in the control gear. Low loss ballasts are only slightly more expensive than conventional ballasts, so they are frequently used in lieu of the latter.

Electronic ballasts (EB) differ in weight, form and function from conventional, inductive ballasts. They consist of a filter, which prevents any reactive feedback onto the mains supply, a rectifier and a high-frequency inverter.

Electronic ballasts have an integrated ignition device, which means that no additional ignitor is required. They ensure a flicker-free start and switch off automatically if the lamp is defective, which prevents the ignitor being activated time and again; switching and operation are as trouble-free as with incandescent lamps.

Operating the lamps at 25–40 kHz presents a number of advantages, above all, enhanced luminous efficacy. This in turn means that the luminous power is achieved, but at a lower energy consumption. At the same time there is considerably less power loss. The high operating frequency of the lamps also prevents stroboscopic and flicker effects, and magnetic interference and humming, all of which are associated with conventional ballasts.

Electronic ballasts are to a large extent insensitive to voltage and frequency fluctuations. They can be operated at both 50 and 60 Hz and over a voltage range of between 200 and 250 V. As they are also designed to be run on direct current, fluorescent lamps with EBs can be operated on batteries, should there be a current failure, thereby simplifying the provision of emergency lighting. Electronic ballasts are, however, more expensive than inductive ballasts.

If fluorescent lamps are operated using inductive ballasts it is necessary to provide a separate starter. The starter first preheats the lamp electrodes. Once the electrodes are sufficiently heated the starter breaks the circuit. This induces a voltage surge in the ballast which in turn ignites the lamp. The simplest form of ignitors are *glow starters*. They comprise bimetal electrodes

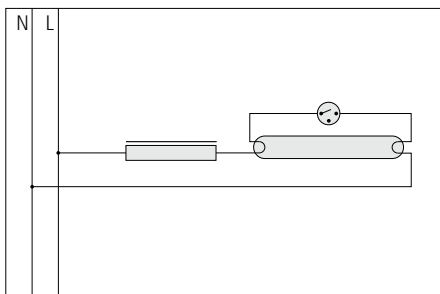

Circuit diagram of a fluorescent lamp with an inductive ballast and ignition device (not power-factor corrected).

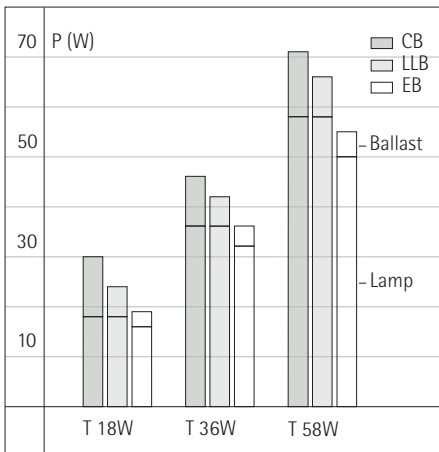

Power consumption P (lamp power and power loss of ballast) of standard fluorescent lamps run on conventional (CB), low-loss (LLB) and electronic ballasts (EB).

encased in a glass tube filled with inert gas. Switching the lamp on produces a luminous discharge between the electrodes in the starter, which in turn heats up the electrodes. During this process the bi-metal electrodes bend inwards until they touch, thereby closing the heater or filament circuit of the fluorescent lamp. After a short time the starter electrodes cool down and separate. This disconnection induces a voltage surge in the ballast which in turn ignites the lamp. When the lamp has been ignited it is only the operating voltage of the lamp that is applied to the starter. This is insufficient to produce a luminous discharge in the starter. The electrodes therefore remain open, which avoids the lamps being permanently heated.

Glow starters are the starters most frequently used and they are the most economical. They do have one drawback: they repeatedly try to ignite the lamp in the event of it being defective. This gives rise to noise and flickering lamps. Moreover, ignition problems may arise in the case of undervoltage or low ambient temperatures due to the fact that the preheating times are inadequate.

Safety starter switches are similar to glow starters. They switch off automatically after repeated attempts to ignite the lamp, thereby ensuring that defective lamps are not subjected to continuous ignition. To operate the starter again it is necessary to reset the safety switch manually.

Thermal starters have contacts that are normally closed when the lamp is switched on. The contacts are disconnected by means of an additional heating element which heats up a bimetal strip or dilating wire. The starter only opens when it has been sufficiently preheated and since the preheating time is prolonged if the temperature or the voltage conditions are not ideal, ignition is not always trouble-free. As there is no need for an initial warm up period to the point of contact, the result is that thermal starters ignite faster than glow starters. Thermal starters are more expensive than glow starters. Some versions require a separate heating current supply through the ballast.

Electronic starters open and close the pre-heating circuit without any mechanical contacts. They ensure a quick and safe start under a much wider range of conditions; in the case of defective lamps the re-ignition process is terminated.

2.4.1.2 Compact fluorescent lamps

Compact fluorescent lamps are operated on the same ballasts as conventional fluorescent lamps. In the case of lamps with a bipin base the starter is integrated,

so they can be operated on inductive ballasts without an additional ignition device. Lamps with four-pin bases can be operated on an inductive ballast with a separate starter or on an electronic ballast.

2.4.1.3 High-voltage fluorescent tubes

High-voltage fluorescent tubes require an operating voltage that is considerably higher than mains voltage. They are therefore run on a leakage transformer, which handles the ignition with its high open potential, and then reduces the voltage during the operation of the lamp. Additional starters or ignition devices are not necessary.

Special regulations have to be observed in Germany (VDE 0128, 0713, 0250) for high-voltage fluorescent tubes run at 1000 V and above. Planners prefer to opt for installations comprising shorter high-voltage fluorescent tubes and voltages below 1000 V, which only have to meet the requirements laid down for low-voltage installations (VDE 0100).

2.4.1.4 Low-pressure sodium lamps

Some linear type low-pressure sodium lamps – similar to fluorescent lamps – can be run on chokes or inductive ballasts with an additional starter. As a rule, ignition and operating voltage are so high, however, that a leakage transformer is used to handle ignition and current limitation.

2.4.1.5 High-pressure mercury lamps

High-pressure mercury lamps are ignited using a glow discharge through an auxiliary electrode. Additional starters or ignition devices are therefore not required. Current limitation is controlled via inductive ballasts, as for fluorescent lamps. These ballasts must, however, be designed to handle the higher operating current.

2.4.1.6 Metal halide lamps

Metal halide lamps are run on inductive ballasts. An extra ignition device is generally required (e.g. impulse generator).

Instant re-ignition of the lamps after a power failure is required in the case of the lighting of certain traffic installations and meeting places. Double-ended metal halide lamps are equipped with special ignitors which supply the necessary high ignition voltages that make an instant restart possible.

Electronic control gear is also available for metal halide lamps. They have similar properties and advantages to the electronic ballasts for fluorescent lamps, while at the

same time allowing an instant restart after power failure.

2.4.1.7 High-pressure sodium lamps

High-pressure sodium lamps are operated on inductive ballasts. An ignition device is required due to their high ignition voltage.

Some double-ended lamps do allow an instant restrike when the lamps are still warm. As with metal halide lamps, a special ignitor is necessary for these lamps to handle the required high ignition voltages and the installation must be designed to take these voltages. Electronic ballasts are also available for high-pressure sodium lamps.

2.4.2 Compensation and wiring of discharge lamps

Inductive ballasts produce a certain amount of idle current due to the phase shift of the voltage with respect to the current – they have a power factor ($\cos \varphi$) substantially below 1. Since idle current loads the mains, power supply companies require the idle current to be compensated – i.e. to a power factor to approach unity – in the case of large-scale lighting installations. Compensation is effected by means of capacitors, which balance the phase shift caused by the reactance. It is possible to compensate individual luminaires, groups of luminaires or an entire installation. Compensation is not necessary in the case of electronic ballasts, as they effectively have a unity power factor.

Fluorescent lamps that are run on inductive ballasts can be compensated via capacitors that are connected in parallel to or in series with the ballast.

If a compensating capacitor is connected in series with the ballast, we talk about a capacitive circuit. The power factor in this case is well above unity and so this type of circuit is referred to as an over-compensated circuit. Circuits of this kind allow a second lamp with a non-compensated ballast to be operated at the same time. Such circuits are known as twin-start circuits. The advantage of a twin-start circuit is that both lamps are out-of-phase. This means that stroboscopic or flickering effects at workplaces with rotating machine parts, for example, are avoided. Sequential connection of the lamps to a three-phase supply network will also minimize these effects.

Ballasts without compensating capacitors are referred to as *inductive circuits*. Compensation can be effected in this case using a parallel capacitor.

With a suitably designed ballast it is possible to operate two fluorescent lamps in series; this type of circuit is known as a *tandem circuit*.

Discharge lamps and the control gear they require may give rise to various disturbance factors in both the supply network and their environment.

This consists primarily of radio interference, which is caused by ignition devices and by the discharge lamp itself. Radio interference can be suppressed by the use of suitably rated radio-interference capacitors.

Depending on their application control gear and luminaires must meet certain minimum requirements with regard to radio interference (in Germany, Limiting Value Category B, VDE 0875, for example) and bear the seal of approval. Retroactive effects on the supply network due to harmonic oscillations have to be below stated minimum values (VDE 0712).

In the hospital environment, for example, the operation of ECG and EEG equipment may suffer interference from electric and magnetic fields induced by lighting installations – particularly by cabling, ballasts and transformers. For this reason there are special regulations (VDE 0107) for electrical installations in doctors' practices, hospitals and similar environments.

Audio frequency energy control devices such as those that control night storage heaters and street lighting systems may cause interference from ballasts with parallel compensation. To avoid interference of this kind specially designed inductive ballasts can be wired in series with the compensating capacitors.

Circuit diagrams for fluorescent lamps. Compensating circuit: power factor correction by a capacitor in parallel (above).

Capacitive circuit: power factor is over-compensated by a series capacitor (centre).

Twin-start circuit: combination of a non-compensated and an over-compensated circuit (below).

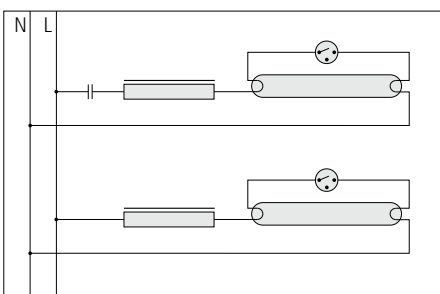
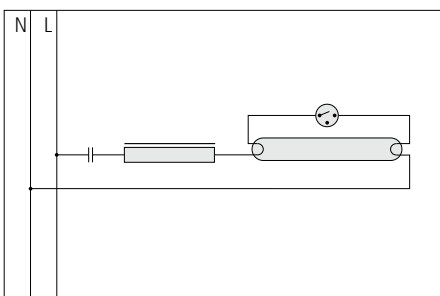
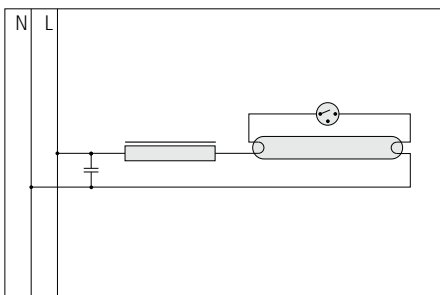

2.4.4 Transformers for low-voltage installations

In addition to ballasts and ignition devices for discharge lamps low-voltage installations also require transformers as part of their control gear.

The low voltage required for such installations, generally below 42 V (mostly 6, 12 or 24 V) is taken from the mains voltage using transformers. Transformers may be an integral part of the luminaire or may be installed separately and supply one or more luminaires.

Transformers form an interface between mains voltage and low voltage, for which certain safety regulations apply. To guarantee that a low-voltage installation is never subject to mains voltage, in the case of technical faults, in Germany for example, safety transformers compliant with VDE 0551 must be used.

If transformers are mounted on inflammable surfaces, they are required – as are luminaires – to bear an additional ∇ or $\nabla \nabla$ symbol. These transformers contain a thermal protection switch, which ensures that they do not overheat.

Transformers for low-voltage installations must have fuses that can handle primary voltage (230 V). Slow-blow fuses are used for this, as currents up to 20 times above the rated current can occur when the lamp is switched on.

It must be noted that significant voltage drops may occur in the connecting cables when dealing with low-voltage installations. This is due to the high current values that occur with low voltages. This can be compensated for, if appropriate cable diameters are used and the connections are kept short; many transformers have both primary and secondary voltage tapping devices, which means that in the case of longer connection cables, excessive voltage drop can be avoided.

Electronic transformers are comparable to electronic ballasts from the point of view of their properties and functions: in particular, the way they operate at high frequencies, the fact that they are smaller and lighter, and that they allow low power loss. Electronic transformers supply voltage that is to a large extent independent of the load. They are therefore suitable for handling small partial loads. As with electronic ballasts, d.c. operation for emergency lighting is also possible. Electronic transformers are also more expensive than conventional transformers.

Fluorescent lamp circuits. Tandem circuit: operation of two lamps connected in series to one ballast (parallel compensation).

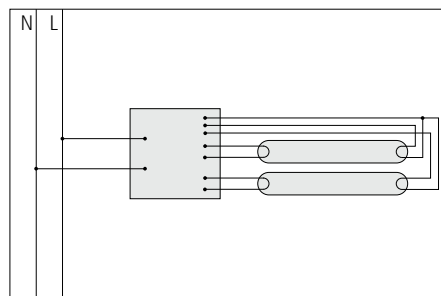
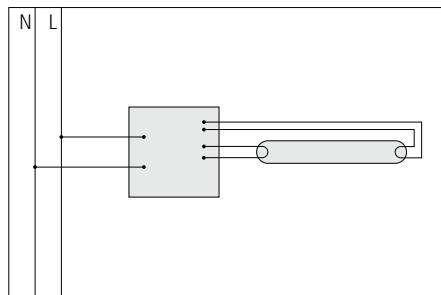
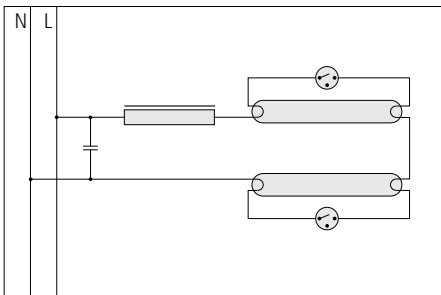

Circuit diagrams for fluorescent lamps. Operation on an electronic ballast: starter and compensating capacitor are not required. Single lamp (above) and twin-lamp circuit (below).

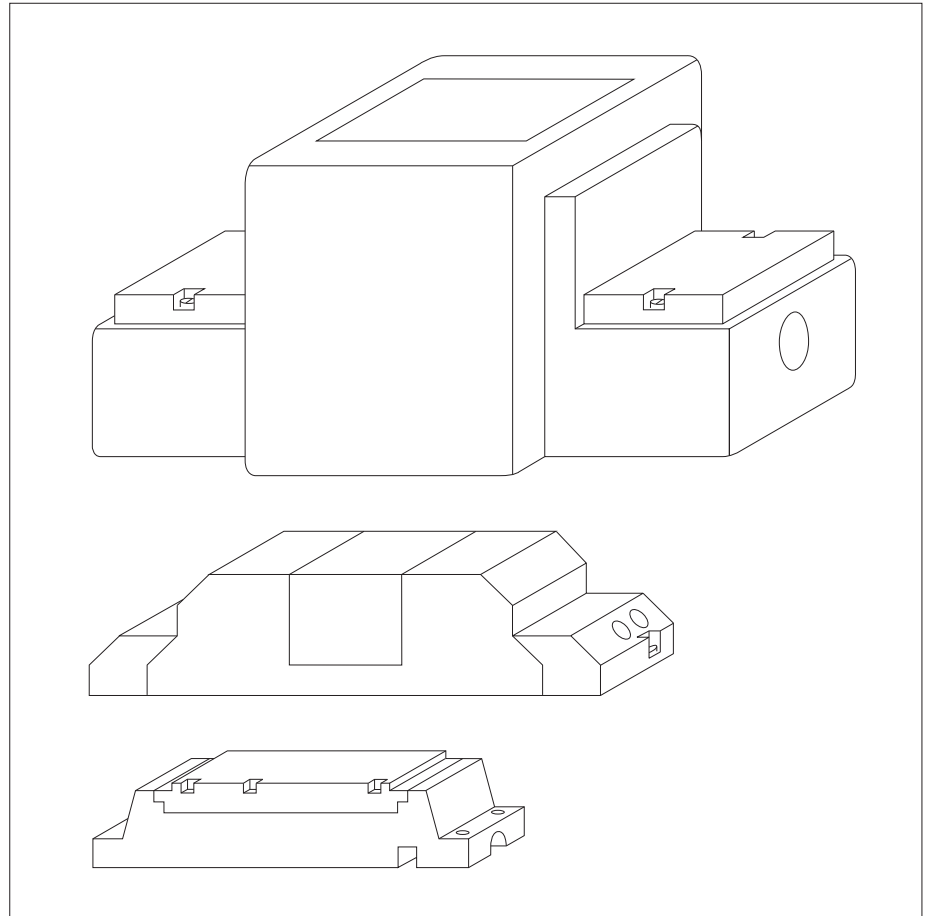

Comparison of sizes of transformers for low-voltage installations: 600 W safety transformer (above) and 100 W version (centre), 100 W electronic transformer (below).

P_n (W)	Wt. (kg)	l (mm)	w (mm)	h (mm)
20	0.5	120	56	50
50	1.0	155	56	50
100	1.8	210	56	50
150	2.6	220	90	90
300	5.5	290	150	130
600	9.2	310	150	130

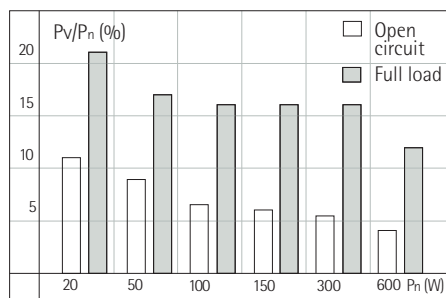

Relative power loss (P_v/P_n) of transformers of varying rated power P_n in the case of standard safety transformers (above) and electronic transformers (below). Data provided for open circuit and full-load operation.

P_n (W)	Wt. (kg)	l (mm)	w (mm)	h (mm)
50	0.2	155	45	30
100	0.2	155	45	30

Rated power (P_n), weight (Wt.) and dimensions (l, w, h) of standard safety transformers (above) and electronic transformers (below).

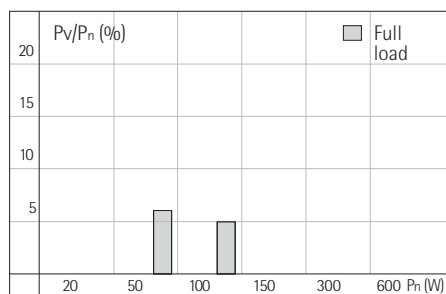

$$\Delta U = 0.035 \cdot \frac{l \cdot I}{A}$$

$$[\Delta U] = V$$

$$[I] = A$$

$$[l] = m$$

$$[A] = mm^2$$

Voltage drop ΔU for copper cable, depending on current, length and diameter of cable.

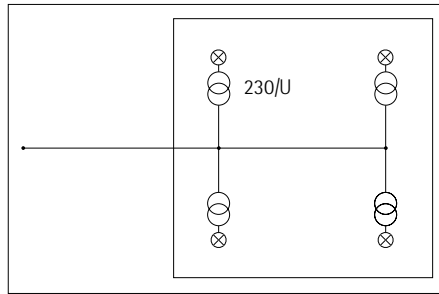

Low-voltage installation with individual transformers. The wiring from transformer to luminaire is as short as possible to keep voltage drop to a minimum; the transformer may also be an integral part of the luminaire.

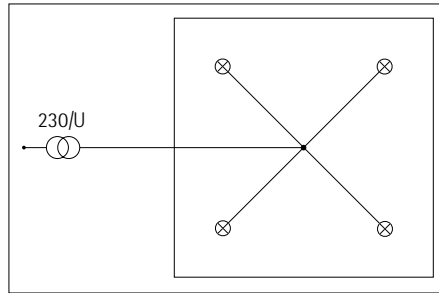

Low-voltage installation with a single transformer. Star-shaped wiring to ensure the same wiring lengths between transformer and fixtures: this guarantees that all lamps receive the same applied voltage.

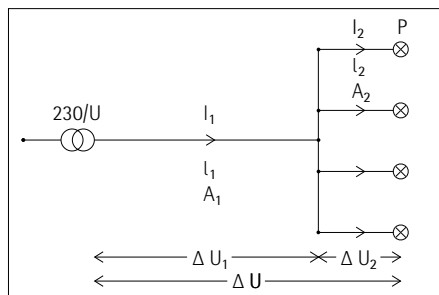

The overall voltage drop ΔU of a low-voltage installation with a star-shaped wiring layout and single transformer is a result of the sum of the individual voltage drops

$\Delta U_1 + \Delta U_2$. Individual voltage drops are calculated according to the set formula, whereby I_1 is the result of all lamps $4P/U$ and I_2 of P/U .

Voltage drop ΔU per 1 m of cable in relation to current I and lamp power P for various cable diameters A . Applies to 12 V installations.

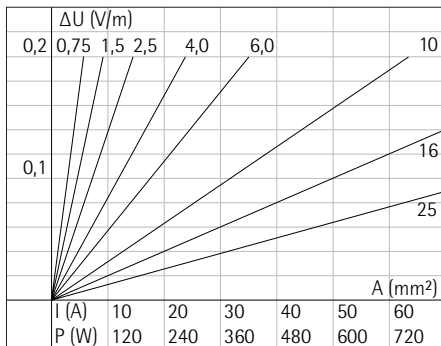

A (mm ²)	I (A)
0.75	12
1.0	15
1.5	18
2.5	26
4.0	34
6.0	44
10.0	61
16.0	82
25.0	108

Limiting current I of multi-core conductors with diameter A .

A (mm ²)	n	d (mm)
1.5	2	10
	3	10
	5	11
2.5	2	11
	3	11
	5	13
4.0	3	13
	5	15

Outer diameter d of sheathed cables of various cable diameters A with number n of cores.

2.4.5 Controlling brightness

There are a number of applications where it is practical to not only be able to switch a lighting installation or individual groups of luminaires on and off, but also to control their brightness. This means that the lighting can be adjusted to suit the use of the space and the ambient conditions; there is also a considerable saving in energy due to the virtually loss-free leading edge dimmers. The ways and means of controlling brightness largely depends on the type of light source installed.

2.4.5.1 Incandescent lamps and halogen lamps

Conventional incandescent lamps and halogen lamps for mains voltage are the easiest light sources to dim. Simple leading edge dimmers are all that are required to control the brightness of these sources.

Incandescent lamps can be dimmed almost 100 per cent. A slight reduction in operating current results in considerable changes in the characteristics of the light source; the luminous flux reduces dramatically, lamp life increases considerably and there is a colour shift to the warmer colours of the spectrum. As we are familiar with this gradual changing of colour temperature through natural phenomena (sunset, a fire burning out), we find the change of luminous colour pleasant when incandescent lamps are dimmed.

2.4.5.2 Low-voltage halogen lamps

Low-voltage halogen lamps behave in a similar way to conventional incandescent lamps when dimmed. The reciprocal interaction of dimmer and transformer means that these control gear components are subject to increased stress. Conventional dimmers can, therefore, not be applied in this case. Special dimmers for low-voltage installations are required. The transformers used must also be approved as compatible with dimming gear and equipped with fuses that are designed to cope with the high starting current. Dimming is basically effected by controlling mains voltage. Conventional dimmers can sometimes be used together with electronic transformers, some makes still require specially adapted dimmers.

2.4.5.3 Fluorescent lamps

The brightness of fluorescent lamps can also be controlled, but the dimming behaviour of fluorescent lamps is considerably different to that of incandescent lamps.

At this stage it should be noted that there is a virtual linear correlation of lamp current and luminous flux. Whereas the luminous flux of an incandescent lamp is

reduced to approx. 50 % at a decrease in lamp current of 10 %, to attain this level of dimming in fluorescent lamps the lamp current also has to be reduced by 50 %. Fluorescent lamps do not change their luminous colour when dimmed.

Special dimmers are required to control the brightness of fluorescent lamps. Some fluorescent lamp dimmers do not allow dimming to low illuminance levels, however. This must be taken into account in lecture halls, for example, where especially low dimming levels are required when slides and videos are shown.

Much of the dimming equipment available for fluorescent lamps requires an additional fourth conductor for the heating of the electrodes. Such systems cannot be used for fluorescent lamps that are operated on power tracks, as standard tracks only have three circuits.

During the dimming process the cables between the dimmer and the luminaire are subject to a considerable load of idle current that cannot be compensated, since the installation can only be compensated from outside the dimmed circuit. This idle current must be taken into account when dimensioning cables and control gear.

Controlling the brightness of fluorescent lamps can be effected in different ways, depending on the type of lamp, ballast and dimmer used.

26 mm lamps operated on inductive ballasts require a heating transformer with an electronic starter. Special electronic ballasts can also be used for controlling the brightness of 26 mm fluorescent lamps. They usually have to be supplied together with suitable dimmers, or they can be operated with all other kinds of dimmers designed for use with fluorescent lamps. In addition, each fixture has to be equipped with a special filter choke or a conventional ballast designed to function as a filter choke. Some of these means of controlling brightness require a three-wire connection, which makes them suitable for application with track systems. When electronic ballasts are used there are none of the disturbing flicker effects that can occur when dimming at mains frequency.

The way the dimming of 38 mm lamps operated on inductive ballasts was formerly effected is no longer of any real significance. It required special lamps with ignition aids and heating transformers for the permanent heating of the lamp electrodes.

2.4 Control gear and control equipment

2.4.6 Remote control

2.4.7 Lighting control systems

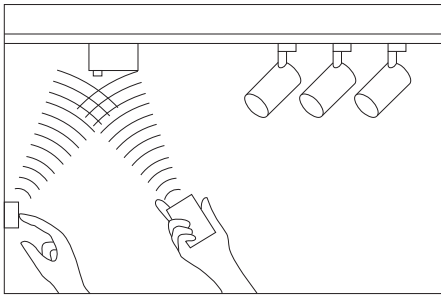

Track system with 3-channel remote control. The receiver can be controlled via a manual device or a wall-mounted unit.

Example of the remote control of a three-circuit track system by switching and dimming of individual circuits.

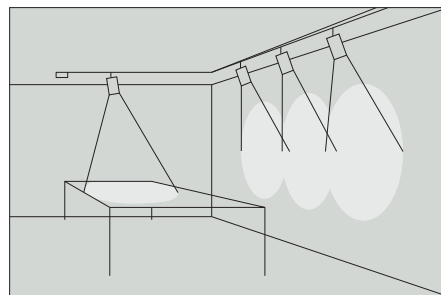
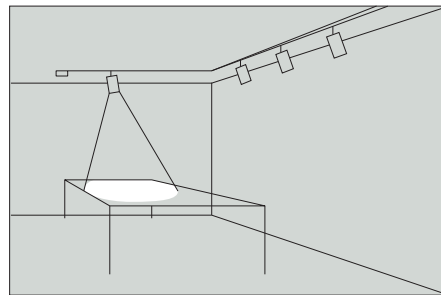
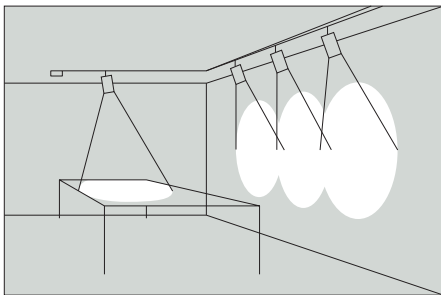
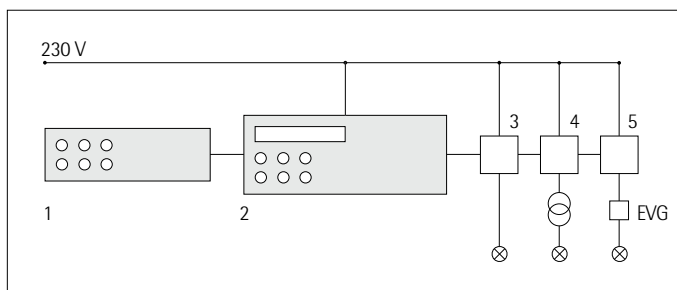

Diagram showing a programmable lighting control system. Preset panels (1) installed in the respective space allows pre-programmed light scenes to be called up. The switching and dimming sequences for the

specific light scenes are programmed and saved in the central control unit (2). Various dimming modules allow the dimming of incandescent lamps (3), low-voltage halogen lamps (4) and fluorescent lamps (5).



2.4.5.4 Compact fluorescent lamps

Compact fluorescent lamps with a two-pin base (integral starter) cannot be dimmed. Lamp types with four-pin bases are dimmed in the same way as conventional 26 mm fluorescent lamps.

2.4.5.5 Other discharge lamps

As a rule high-pressure discharge lamps and low-pressure sodium lamps are not dimmed, because it cannot be guaranteed that the lamps will continue to burn consistently and dimming has a deteriorating effect on the properties of the lamp.

2.4.6 Remote control

Remote control systems provide the opportunity to control individual luminaires or circuits with the aid of a remote control unit. Receivers have to be installed in the fixtures, lighting installations or distributor boxes; these receivers switch or dim the fixtures they are connected to through an infrared signal. By coding signals it is possible to address a number of fixtures or circuits separately. Remote control systems can be used to control the lighting from any position within a space using a hand-held controller. The great advantage of such systems is the fact that an individual circuit can be subdivided into several, separately controllable units.

There are special receivers available for operation on tracks. These receivers can control all the track circuits. This means that – especially in the case of old buildings with only one circuit available per room – it is possible to install differentiated lighting into a room easily and economically.

2.4.7 Lighting control systems

The task of a lighting installation is to create optimum visual conditions for any particular situation. Good lighting must enable the users of the space to perform the necessary visual tasks and move safely from room to room. Furthermore, it should also take into consideration the aesthetic and psychological effects of the lighting, i.e. provide an aid for orientation, accentuate architectural structures and support the architectural statement. One only has to consider the simplest of lighting tasks to understand that the requirements cannot be fulfilled by one lighting concept alone. The lighting has to be adjusted to meet the changing conditions in the environment – the conditions for night lighting are different from the supplementary lighting required during the day. The requirements of a lighting installation are substantially different when it comes to the uses of the space, e.g. the change of

events in a multi-purpose hall, the change of exhibitions in a museum or even the way a standard office space can be transformed into a conference room.

To meet such changing requirements a lighting installation has to be able to be dimmed and switched in a variety of ways to create different light scenes. The prerequisite is that luminaires or groups of luminaires can be switched separately and their brightness controlled, so that the illuminance level and lighting quality in specific areas of the space can be adjusted to particular situations. The result is an optimum pattern of switched luminaires and brightness levels, a light scene that complies with the use of the room or creates specific ambient conditions. If large numbers of luminaires are to be controlled accurately, it is a good idea to store the light scenes electronically so that any scene may be called up as required.

The main task of a lighting control system is to store a series of light scenes – each comprising the switching and dimming status required for the various circuits – and to call them up when required. Using a programmed lighting control system it is, however, possible to create more complex processes than a simple change of scenes. A change of scene can be programmed to be effected instantaneously or in the form of a seamless transition, for example. It is also possible to raise or lower the overall brightness level of a light scene without re-programming.

The transition from one scene to another can be effected manually using a preset panel. It is also possible to have a change of scenes controlled automatically. In this case the lighting control is usually dependent on the amount of daylight available or what day of the week it is and what time of day/night.

Due to the miniaturisation of electronic components lighting control systems are so compact that some of them can be installed in existing distribution boxes or fuse boxes, although large-scale systems will require their own cabinet. Lighting control systems consist of a central control unit for digital storage and control, a series of load modules (dimmers or relays), which are each allocated to a circuit, and one or more preset panels. Depending on the application, other modules for time or daylight-related control and for the lighting control in a number of different spaces are required. Via special switching arrangements or by incorporating lighting control systems into building management programmes lighting control systems can also control and supervise other technical equipment besides the lighting (e.g. sun-blinds or projection screens).

2.4.7.1 Lighting control systems for theatrical effects

Unlike stage lighting whose task it is to create illusions, architectural lighting concentrates on human visual requirements and on defining our real surroundings. In spite of this basic difference some stage lighting methods have been adopted in the field of architectural lighting. Lighting concepts that comprise theatrical effects are becoming increasingly popular. These include stark contrasts between light and dark, the application of coloured light – using spotlights and colour filters, contour lighting using coloured neon tubes – and gobo projections.

Besides creating specific effects on stage it is the way that stage lighting changes that plays a decisive role; a change of scenes in this case no longer serves as a method for adjusting to existing requirements, but becomes a design element in its own right. Changes in the lighting are not merely related to switching groups of lights on and off and changing the level of brightness; they also include distribution characteristics, beam direction and colour.

Stage lighting control systems therefore have to meet considerably more stringent requirements than conventional lighting control systems. With the increasing trend to apply theatrical lighting effects in architectural spaces architectural lighting designers now require lighting control systems that are not only able to switch and dim fixtures, but are also able to change their position, colour and distribution characteristics.

Example of a pre-programmable lighting control system: preset panel (centre) for 6 scenes with On/Off switches for controlling the brightness of the overall installation. Central control unit with LCD display (above). Circuit module (below) with programmed address and On/Off switches for testing purposes.

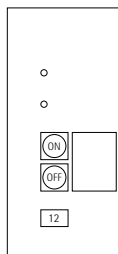
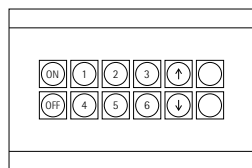
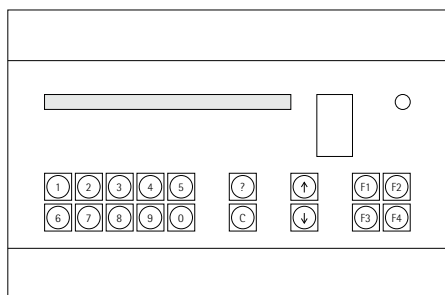

Light Qualities and features

Up to now visual perception and the production or generation of light have been treated as two separate topics. We will now consider the area where light and perception meet – and describe the qualities and features of light. The intention is to show how specific qualities of light create different perceptual conditions and thereby influence and control human perception. Illuminance plays as great a part as light distribution, beam direction, the colour quality of a lighting installation or glare limitation.

A comprehensive set of regulations exist for workplaces which define the optimum lighting conditions for specific visual tasks to ensure that visual tasks can be performed correctly and without causing fatigue. The standards only relate to establishing good working practice regarding working conditions. Broader concepts are required to take into consideration the architectural and psychological requirements of the visual environment.

2.5.1 Quantity of light

The basis for any lighting installation is the quantity of light available for a specific visual task in a given situation. Every-one knows that light is a prerequisite for visual perception. Up to around a hundred years ago we were dependent on the amount of light available through constantly changing daylight conditions or weak artificial light sources, such as candles or oil lamps. Only with the development of gas light and electric light did it become possible to produce sufficient amounts of light and thus to actively control lighting conditions.

There then followed the evaluation of the amount of light that was appropriate in each situation, establishing the upper and lower illuminance and luminance limits in specific situations. Much investigation went into lighting conditions in the working environment to establish illuminance levels for optimum visual performance. By visual performance we mean the ability to perceive and identify objects or details, i.e. visual tasks with given contrast between the object viewed and the surrounding area.

Visual performance generally improves when the illuminance level is increased. This effect improves more slowly from 1000 lux upwards, however, and decreases rapidly at extremely high illuminance levels due to glare effects.

In the case of simple visual tasks adequate visual performance can be attained at low illuminance levels, whereas complex visual tasks require high illuminance levels. 20 lux is the threshold value at which a person's facial features can be recognised. At least 200 lux is required for continuous work, whereas complicated

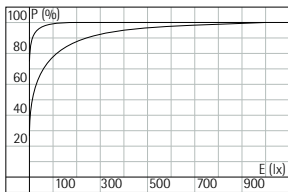

Influence of illuminance E on the relative visual performance P for simple (upper curve) and complicated visual tasks (lower curve).

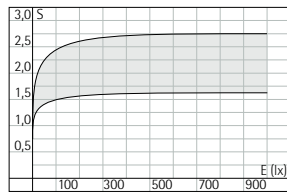

Influence of illuminance E on the visual acuity S of normal-sighted observers.

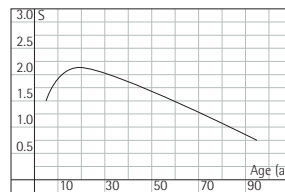

Visual acuity S in relation to age (average values).

The Landolt ring for determining visual acuity. The visual task is to determine the position of the opening in the ring. The gap is 1/5 of the ring's diameter.

The angle of vision α is calculated from the width of the opening of the smallest detectable Landolt ring and the distance of the viewer from the image. Visual acuity S is its reciprocal value. A visual acuity of 1 is recorded when the gap in the ring can be recognised at an angle of vision of $\alpha = 1'$ ($1/60^\circ$).

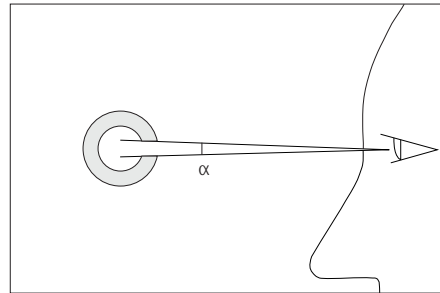
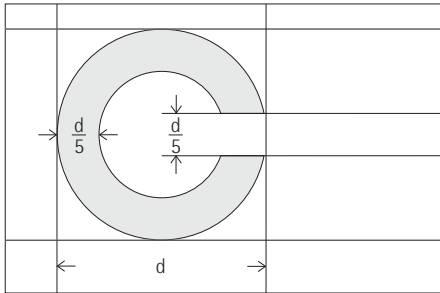

S					
0,5					
1					
2					
3					

Table for determining the reader's visual acuity S from a distance of 2 m.

$$S = \frac{1}{\alpha}$$

$$[\alpha] = \text{min}$$

visual tasks require up to 2000 lux, in special cases, e.g. in operating theatres, up to 10000 lux. The preferred illuminance level at the workplace ranges between 1000 and 2000 lux.

International guidelines for illuminance levels range in values from 20 to 2000 lux and are therefore within the above-mentioned framework. The recommended illuminance levels are mainly a consequence of the degree of difficulty of the visual task in contrast to the immediate environment, whereby extremely detailed visual tasks, where there is little contrast to the surrounding area, require the highest illuminance levels.

Following a set of fixed rules for overall illuminance levels as laid down in the standards for the lighting of workplaces, which is generally what lighting design amounts to in practice, includes minimal consideration regarding actual perception. It is not the luminous flux falling on a given surface – illuminance – that produces an image in the eye. It is the light that is emitted, transmitted or reflected by the surfaces. The image on the retina is created entirely by the luminance pattern of the perceived objects, in the combination of light and object.

Recommendations have also been laid down for luminance levels, that is to say for maximum luminance contrasts between visual task and surrounding area. Likewise for absolute luminances that are not to be exceeded, for example of luminous ceilings or luminaires in spaces equipped with VDT workstations. The object is again is to optimise visual performance at the workplace.

In addition to these guidelines there is also a set of general recommendations for luminance distribution in the entire space. It is assumed that a space with low luminance contrasts will appear to be monotonous and uninteresting and a space with stark contrasts restless and irritating.

For some time now more systematic approaches to comprehensive lighting design have been made based on the results of research on luminance distribution. In Waldram's "designed appearance" concept or Bartenbach's idea of "stable perception", in particular, there have been attempts to control the visual appearance of the overall environment (mood, atmosphere) through the purposeful arrangement of luminances.

Any attempt to design a lighting installation based on quantitative data is bound to lead to problems. This applies to overall illuminance stipulations and luminance scales as well as to sets of given luminance patterns.

Visual perception is a process which allows us to gain information about objects in the world around us using the medium of light. A process that is there-

E (lx)	
20	Minimum value in interior spaces, excluding working areas Illuminance level required for recognising facial features
200	Minimum illuminance for workplaces in continuous use
2 000	Maximum illuminance at standard workplaces
20 000	Illuminance level for special visual tasks e.g. in operating theatres

Typical illuminance levels E in interior spaces.

E (lx)	
20–50	Paths and working areas outdoors
50–100	Orientation in short-stay spaces
100–200	Workrooms that are not in continuous use
200–500	Simple visual tasks
300–750	Visual tasks of average degree of difficulty
500–1000	Difficult visual tasks, e.g. office work
750–1000	Complicated visual tasks, e.g. precision assembly work
1000–2000	Extremely complicated visual tasks, e.g. inspection and control
> 2000	Additional lighting for difficult and complicated tasks

Recommended illuminance levels E according to the CIE for various activities.

fore basically influenced by three factors: light, object and perceiving being. A design concept that is restricted to fixed illuminance criteria is only concerned with the aspect of the light. Illuminance is therefore inadequate as a basis for predicting visual effect, especially as it is not itself perceptible.

When planning luminance distribution it is not only the light that is taken into consideration, but the correlation of the light with the objects in the space. Luminance is the basis of the brightness we perceive, which means that the perceptual process is taken into account, at least up to the moment an image is projected onto the retina.

But luminance and luminance distribution do not provide an adequate basis for the planning of visual impressions – attention has yet to be paid to the perceiving individual. The pattern of luminances projected onto the retina is not the end product, but simply forms the basis for a complex process at the end of which is the image we actually see. This involves innumerable aspects: laws of gestalt, constancy phenomena, expectations and the information content of the object that is being perceived.

The aim of perception is not just to register luminous phenomena, but to gain information about the environment. It is not the luminances produced by an accumulation of objects that are interesting, but rather the information about the quality of these objects and about the lighting conditions under which this quality can be perceived.

This is why the image that we actually perceive is not identical to the pattern of luminances on the retina, although it is based on this luminance pattern. A white body has different luminance qualities depending on the lighting situation. Even so, it is always perceived as being uniformly white, because the lighting situation is registered and taken into account when the image is being processed. The formation of shadows on a spatial body – its luminance pattern – is not interpreted as being unevenly lit, but as a feature of a three-dimensional form. In both cases the characteristics of the object and the type of lighting are interpreted from the perceived luminance pattern simultaneously. These simple examples are clear evidence of the important part psychological processing has to play in the creation of the final perceived image.

When a lighting design concept purposefully strives to achieve specific visual effects it must involve all factors related to the perceptual process. Lighting design cannot be restricted to the observance of illuminance or luminance levels, of light and object alone, even when this approach effectively results in optimum per-

ceptual conditions at workplaces, for example. Apart from considering the qualities of the light to be applied lighting design must – as an integral part of the design of the environment – also take into account the interaction of light source, object and perceiver, as governed by the laws of perceptual psychology, in each respective situation.

2.5.2 Diffuse light and directed light

Having dealt with light quantity, consideration must be given to the quality of light, the difference between diffuse light and directed light being one of the most important aspects. We are familiar with these different forms of light through our everyday experience with daylight – direct sunlight when the sky is clear and diffuse light when the sky is overcast. Characteristic qualities are the uniform, almost shadowless light we experience under an overcast sky, in contrast to the dramatic interplay of light and shade in bright sunlight.

Diffuse light is produced by extensive areas that emit light. These may be extensive, flat surfaces, such as the sky in the daytime, or, in the field of artificial lighting, luminous ceilings. In interior spaces diffuse light can also be reflected from illuminated ceilings and walls. This produces very uniform, soft lighting, which illuminates the entire space and makes objects visible, but produces reduced shadows or reflections.

Directed light is emitted from point light sources. In the case of daylight this is the sun, in artificial lighting compact light sources. The essential properties of directed light are the production of shadows on objects and structured surfaces, and reflections on specular objects. These effects are particularly noticeable when the general lighting consists of only a small portion of diffuse light. Daylight, for example, has a more or less fixed ratio of sunlight to sky light (directed light to diffuse light) of 5:1 to 10:1.

In interior spaces, on the other hand, we can determine the ratio of directed and diffuse light we require or prefer. The portion of diffuse light decreases when ceiling and walls receive too little light, or when the light falling on a surface is absorbed to a large extent by the low reflectance of the environment. This can be exploited for dramatic effects through accent lighting. This technique is often applied for the presentation of objects, but is only used in architectural lighting when the concept intends to create a dramatic spatial effect.

Directed light not only produces shadows and reflections; it opens up new horizons for the lighting designer because of the choice of beam angles and aiming directions

that he has at his disposal. Whereas the light emitted by diffuse or exposed light sources always has an effect on the entire space, in the case of tightly controlled light, the effect of the light relates directly to the position of the luminaire.

Here lies one of the most progressive aspects of lighting technology. Whereas in the era of the candle and the oil lamp the light was bound to the immediate vicinity of the luminaire, it is now possible to use light in other parts of the space at any distance from where the light source is located. It is possible to use lighting effects at specific illuminance levels on exactly defined areas from practically any location within a space. This means that a space can be purposefully lit and the lighting modulated. The relative local illuminance level can be adjusted to suit the significance of a particular part of a space and the perceptual information it contains.

2.5.2.1 Modelling

Another basic feature of the world around us, and one that we take absolutely for granted, is its three-dimensional quality. One essential objective regarding visual perception must therefore be to provide information about this aspect of our environment. Three-dimensionality comprises a number of individual areas, from the extension of the space around us to the location and orientation of objects within the space, down to their spatial form and surface structure.

Perception of the three-dimensional character of our environment involves processes that relate to our physiology and perceptual psychology. The shaping of our environment through light and shade is of prime importance for our perception of spatial forms and surface structures. Modelling is primarily effected using directed light. This has been referred to, but the significance for human perception must be analysed.

If we view a sphere under completely diffuse light we cannot perceive its spatial form. It appears to be no more than a circular area. Only when directed light falls on the sphere – i.e. when shadows are created, can we recognise its spatial quality. The same applies to the way we perceive surface structures. These are difficult to recognise under diffuse light. The texture of a surface only stands out when light is directed onto the surface at an angle and produces shadows.

Only through directed light are we able to gain information about the three-dimensional character of objects. Just as it is impossible for us to retrieve this information when there is no directed light at all, too much shading can conceal information. This happens when intensely

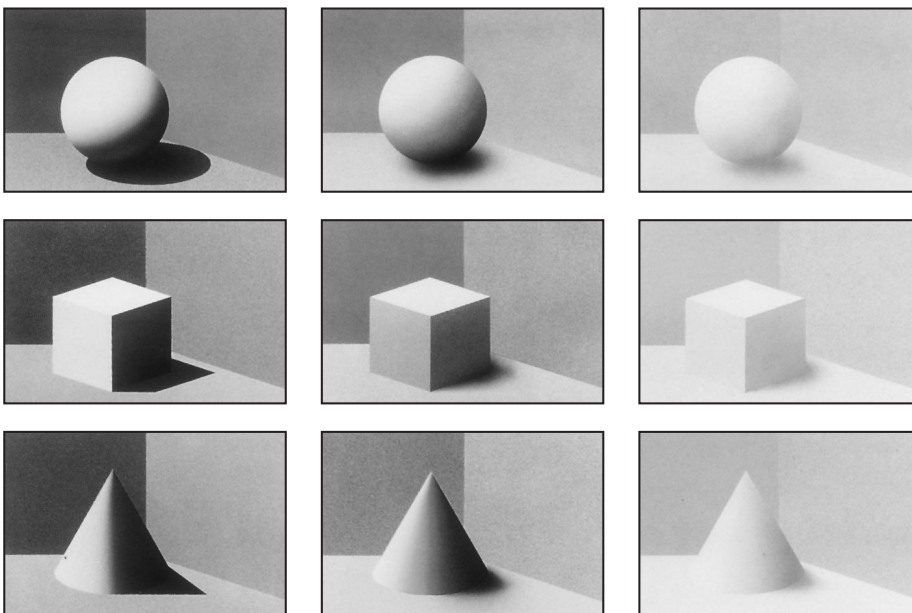

Perception of three-dimensional forms and surface structures under different lighting conditions. Directed light produces pronounced shadows and strong shaping effects. Forms and surface structures are accentuated, while details can be concealed by the shadows.

Lighting that consists of both diffuse and directed lighting produces soft shadows. Forms and surface structures can be recognised clearly. There are no disturbing shadows.

Diffuse lighting produces negligible shadowing. Shapes and surface structures are poorly recognisable.

directed light casts such stark shadows that parts of an object are concealed by the darkness.

The task of lighting design is therefore to create a suitable ratio of diffuse light to directed light to meet the requirements of each individual situation. Specific visual tasks, where the spatial quality or the surface structure is of prime importance, require lighting that emphasises shapes and forms. Only in situations where spatial quality and surface structure are of no importance, or if they are disturbing factors, can completely diffuse lighting be used.

As a rule suitable proportions of diffuse light and directed light are required. Well balanced portions provide good overall visibility of the environment and simultaneously allow spatial appreciation and vivid perception of the objects.

In some standards for workplace lighting there is a criterion for the modelling effect of a lighting installation. It is referred to as the modelling factor, which is defined as the ratio of cylindrical illuminance to horizontal illuminance.

When planning the application of directed and diffuse light it is advisable to rely on our fundamental experience of daylight with regard to the direction and colour of the light. Direct sunlight either comes from above or from the side, but never from below. The colour of sunlight is clearly warmer than that of diffuse sky light. Consequently, lighting that comprises directed light falling diagonally from above with a lower colour temperature than the diffuse general lighting will be felt to be natural. It is, of course, possible to apply light from other directions and with other colour temperature combinations, but this will lead to effects that are especially striking or strange.

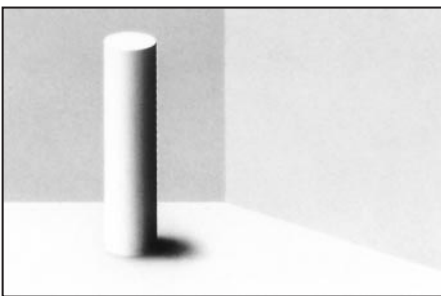
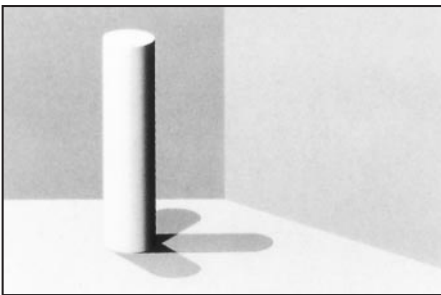

It is possible to create uniform lighting in a space by using several point light sources. Due to the fact that each light beam is directed, objects within the space will cast multiple shadows.

In the case of uniform lighting with diffuse light the shadows are softer and far less distinct.

2.5.2.2 Brilliance

Another feature of directed light alongside its modelling effect is brilliance. Brilliance is produced by compact, point light sources and is most effective when applied with an extremely low proportion of diffuse light. The light source itself will be seen as a brilliant point of light. A good example of this is the effect of a candlelight in evening light. Objects that refract this light are perceived as specular, e.g. illuminated glass, polished gems or crystal chandeliers. Brilliance is also produced when light falls on highly glossy surfaces, such as porcelain, glass, paint or varnish, polished metal or wet materials.

Since sparkling effects are produced by reflections or refraction, they are not primarily dependent on the amount of light applied, but mostly on the luminous intensity of the light source. A very compact light source (e.g. a low-voltage halogen lamp) can create reflections of far

greater brilliance than a less compact lamp of greater luminous power.

Brilliance can be a means of attracting attention to the light source, lending a space an interesting, lively character. When applied to the lighting of objects brilliance accentuates their spatial quality and surface structure – similar to modelling – because sparkling effects are mainly evident along edges and around the curves on shiny objects.

Accentuating form and surface structure using brilliance enhances the quality of the illuminated objects and their surroundings. Sparkling effects are in fact generally used in practice to make objects or spaces more interesting and prestigious. If an environment – a festival hall, a church or a lobby – is to appear especially festive, this can be achieved by using sparkling light sources: candlelight or low-voltage halogen lamps.

Directed light can also be applied with sparkling effect for the presentation of specific objects – making them appear more precious. This applies above all for the presentation of refractive or shiny materials, i.e. glass, ceramics, paint or metal. Brilliance is effective because it attracts our attention with the promise of information content. The information we receive may only be that there is a sparkling light source. But it may also be information regarding the type and quality of a surface, through the geometry and symmetry of the reflections. The question still has to be raised, however, whether the information our attention has been drawn to is really of interest in the particular situation. If this is the case, we will accept the sparkling light as pleasant and interesting. It will create the feeling that the object of perception, or the overall environment, is exclusive.

If the brilliance possesses no informative value, then it is found to be disturbing. Disturbing brilliance is referred to as glare. This applies in particular when it arises as reflected glare. In offices, reflections on clear plastic sleeves, computer monitors or glossy paper are not interpreted as information (brilliance), but as disturbing glare, disturbing as it is felt that the information we require is being concealed behind the reflections.

2.5.3 Glare

An essential feature of good lighting is the extent to which glare is limited. There are two aspects to glare: the objective depreciation of visual performance, and the subjective disturbance felt by individuals through excessive luminance levels or stark contrasts in luminance levels within the field of vision.

In the case of objective depreciation in visual performance the term *physiological glare* is applied. In this case the light from a glare source superposes the luminance pattern of the visual task, thereby reducing visibility. The reason for this superimposition of the luminous intensities of visual task and glare source may be the direct overlay of the images on the retina. Superimposition of scattered or disturbing light, which arises through the dispersion of the light from the glare source within the eye, is often enough to reduce visual performance. The degree of light scattering depends primarily on the opacity of the inner eye. The latter increases with age and is the reason why older people are considerably more sensitive to glare.

The most extreme case of physiological glare is disability glare. This arises when luminance levels of more than 10^4 cd/m^2 are evident in the field of vision, e.g. when we look directly at artificial light sources or at the sun. Disability glare does not depend upon the luminance contrast in the environment. It cannot be eliminated by increasing the luminance level. Disability glare seldom presents a problem in architectural lighting. Here it is more a question of relative glare, whereby the reduction of visual performance is not caused by extreme luminances, but by high luminance contrasts within the field of vision.

If the glare source is not the cause of a reduction in visual performance, but merely a subjective interference factor the term *discomfort glare* is used. Discomfort glare occurs when an individual is involuntarily or unconsciously distracted by high luminance levels within the field of vision. The person's gaze is constantly being drawn away from the visual task to the glare source, although this area of increased brightness fails to provide the expected information. A glare source is also frequently referred to as visual noise, and as such can be compared with a disturbing sound that continually attracts our attention and undermines our perception.

Repeatedly having to adjust to various brightness levels and the distance between the visual task and the glare source eventually leads to eye strain, which is considered to be unpleasant or even painful. Although visual performance may objectively remain unchanged, discomfort

glare can lead to a high degree of unease, which in turn will have an effect on the person's overall performance at his/her workplace.

In contrast to disability glare, which can be explained irrespective of the specific situation as the exceeding of given luminance or luminance contrast values, discomfort glare is a problem that concerns the processing of information, which cannot be described out of context – the information content of the visual environment and the perceptual information we require in a given situation. Although there may be considerable luminance contrasts occurring within the field of vision, discomfort glare does not become a problem, if these contrasts are expected and provide valuable information, e.g. the sparkling light of a crystal chandelier or an appealing view out of a window. On the other hand, even slight differences in luminance levels can give rise to discomfort glare, if these contrasts overlay more important information and themselves provide no information; e.g. in the case of reflections on glossy paper, when we look at a uniformly overcast sky or at a luminous ceiling. Disability and discomfort glare both take two forms. The first is *direct glare*, where the glare source itself is visible in the field of vision of the visual task. In this case the degree of glare depends mainly on the luminous intensity of the glare source, its luminance contrast to the visual task, its size and proximity to the visual task.

The second form of glare is *reflected glare*, in which the glare source is reflected by the visual task or its ambient field. This form of glare depends on the above-mentioned factors and the specular quality and position of the reflecting surface.

Discomfort glare caused by reflected light creates considerable problems for persons reading texts printed on glossy paper or working at computer monitors, as the eye is continually straining to accommodate to the visual task, which is at close range, and the distraction of the reflected glare source, which is located at some distance away.

The evaluation of luminances and luminance contrasts that may lead to unwanted glare is predominantly dependent on the type of environment and the requirement that the lighting aims to fulfil. The rules that govern a festive or theatrical environment are entirely different from those for workplaces; what may be desired brilliance in one case may be considered to be unwanted glare in another. The predominant directions of view also play a significant role; lighting that may be glare-free for a person sitting upright in a chair may constitute glare if that same person leans back.

There is a set of formalised rules that apply to glare limitation in the field of lighting at workplaces; as a rule, they are

In the case of physiological glare the retinal image of the object being viewed (1) is superimposed by luminances that occur in the eye from the dispersion (2) of the light produced by a glare source (3).

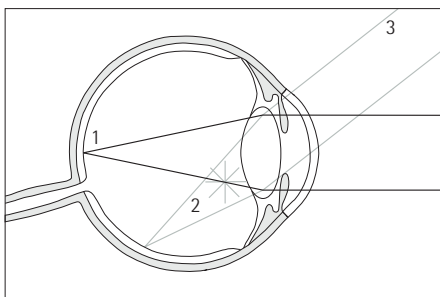

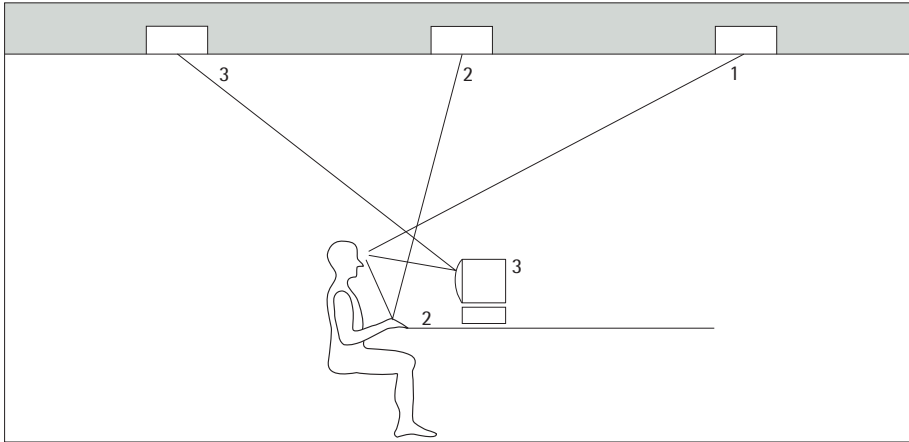

With regard to glare a distinction is made between direct glare, caused primarily by luminaires (1), reflected glare in the case of horizontal visual tasks (2) and reflected glare in the case of vertical visual tasks, e.g. at VDT workstations (3).

The luminance of luminaires that cause reflections on conventional computer monitors should not exceed 200 cd/m^2 above a critical angle γ_G . Normally γ_G values lie between 50° and 60° .

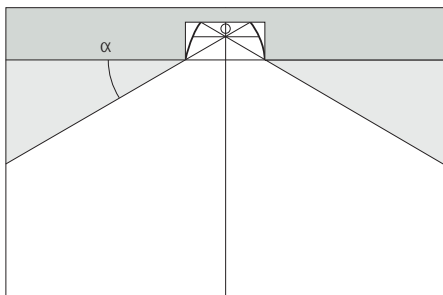

Glare limitation at VDT workstations: for areas with VDT workstations a cut-off angle α of at least 30° is recommended.

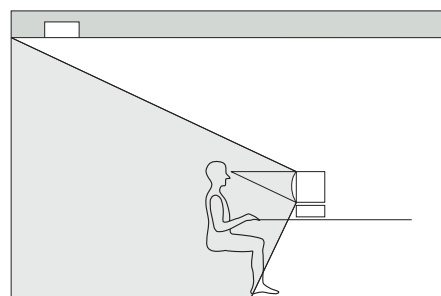
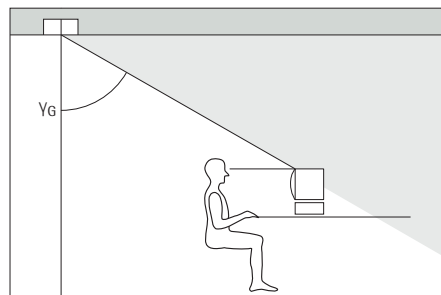

Luminance levels of walls that produce reflections on monitors should not exceed 200 cd/m^2 on average, or 400 cd/m^2 as a maximum. The reflection of windows on computer monitors should basically be avoided.

based on a person working seated at a desk with louvred luminaires providing the lighting. From the height of the sitting position and the preferred direction of view areas can be defined in which light sources will tend to produce the most glare. Apart from glare through windows glare is mainly produced by luminaires located in specific parts of the ceiling.

In the case of direct glare this is the area of ceiling in front of the seated person and perceived at angles lower than 45° . In the case of reflected glare, the glare is caused predominantly by luminaires located in the ceiling area directly in front of the person. Reflected glare on VDTs, that is to say on practically vertical surfaces, presents a special case. In this case glare is mainly caused by glare sources in the ceiling area behind the person. Glare can be minimised by reducing luminance contrasts – for example, by raising the ambient luminance or lowering the luminance of the glare source. Glare can also be avoided by suitably arranging the luminaire geometry. Continuous rows of louvred luminaires should not be installed cross-wise to the direction of view, for example, but parallel to the direction of view and between the workplaces.

Suitable glare limitation can be achieved by the correct choice of luminaires. Especially developed reflectors can guarantee that luminaires positioned above the critical angle do not produce any unacceptable luminances. By installing luminaires that emit only minimal direct light downwards can also make a substantial contribution towards limiting reflected glare.

In Germany DIN 5035 is used for the evaluation of glare limitation at the workplace. It describes a specific process for checking that limiting values between comfort and direct glare are not exceeded. The luminance of the installed luminaires is determined at angles of 45° – 85° and entered in a diagram. Depending on the rated illuminance, the type of luminaires and the required visual comfort the lighting installation aims to meet, luminance limiting curves can be drawn on the diagram that are not to be exceeded by the luminance curve stipulated for the luminaire installed.

In the case of direct glare there is the quantitative method of evaluating luminance limiting curves. Reflected glare can only be evaluated according to qualitative criteria, however. For reflected glare in the case of horizontal reading, writing and drawing tasks there is a process that describes the degree of reflected glare in quantitative terms via the contrast rendition factor (CRF). The contrast rendition factor in this case is defined as the ratio of the luminance contrast inherent to a visual task under totally diffuse standard

Minimum cut-off angle of luminaires with different light sources, in relation to the glare limitation category.

Lamp type	Glare limitation category			
	A	B	C	D
	Very low	High	Average	Low
Fluorescent lamp	20°	10°	0°	0°
Compact fluorescent lamp	20°	15°	5°	0°
High-pressure lamp, matt	30°	20°	10°	5°
High-pressure lamp, clear	30°	30°	15°	10°

lighting conditions to the luminance contrast of the same visual task under the given lighting conditions.

The contrast rendition factor (CRF) is based on a reflection standard comprising one light (high reflectance) and one dark (low reflectance) ceramic disc with standardised reflectance for various directions and angles of illumination. For completely diffuse lighting the reference contrast is known.

The CRF can be measured in an actual lighting installation on the basis of the given reflection standard or calculated on the basis of the reflectance data. The CRF is then classified into one of three CRF categories.

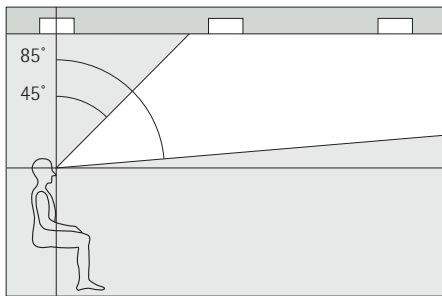

To evaluate direct glare the luminance of the luminaires within the range 45° to 85° is considered.

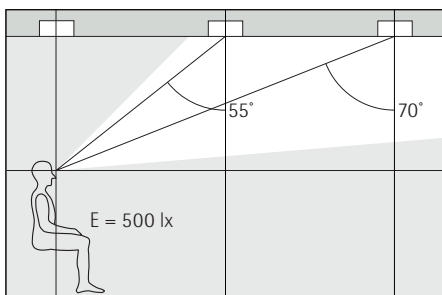

Category	Mean illuminance (lx)				
	A	1000	750	500	-
1	2000	1500	1000	750	500

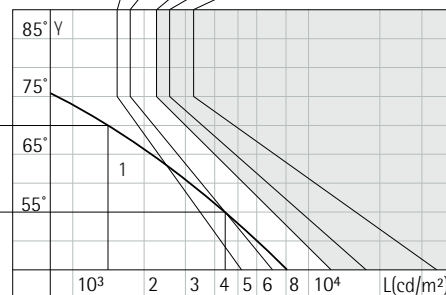

Example of how to apply glare limitation to an illuminance level of 500 lx and category A. From the geometry of the space the viewing angle for the first luminaire is 55°, for the second luminaire 70°. The corresponding luminances can be read off luminance curve 1 in the diagram.

The luminance curve does not exceed the limiting curve, the luminaire therefore meets the requirements laid down for glare limitation.

Luminance limiting curves (for luminaires without luminous side panels). They identify values for average luminance L of the luminaire at angles γ between 45° and 85°, which are not to be exceeded by the luminaire in question for the given mean illuminance and for the required glare limitation category.

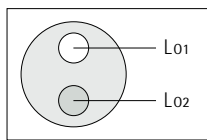
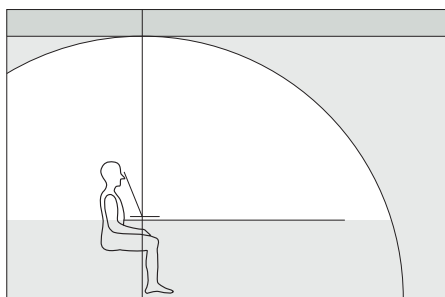

$$C_0 = \frac{L_{01} - L_{02}}{L_{01}}$$

$$C_0 = 0,91$$

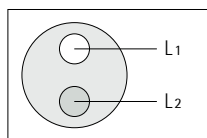
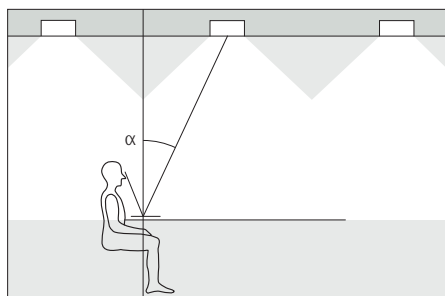

$$C = \frac{L_1 - L_2}{L_1}$$

$$CRF = \frac{C}{C_0} = \frac{C}{0,91} = \frac{L_1 - L_2}{0,91 \cdot L_1}$$

Evaluating the contrast rendition factor (CRF): in the case of a completely diffuse reference lighting situation (idealised representation of a light hemi-sphere, above left) the reference value for standard reflectance according to Bruel + Kjaer is C_0 (above right).

In the case of an actual lighting situation (below left) the contrast value for standard reflectance with a viewing angle α is C (below right).

Contrast rendition factor CRF is a criterion for contrast perception at viewing angle α . $CRF < 1$ indicates that the lighting has lost part of its contrast rendering quality due to reflections. $CRF > 1$ indicates that the lighting situation exceeds the quality of the reference lighting with regard to contrast rendition.

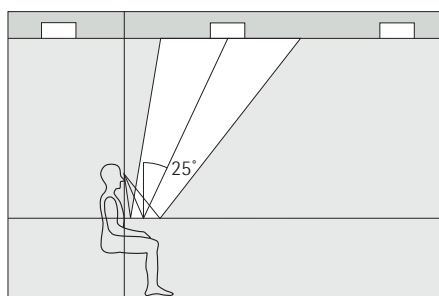

By projecting the field of vision onto the ceiling surface it is possible to define the area in which the luminaires may have a negative influence on contrast rendering. For the basic planning of a lighting installation the CRF value is generally only calculated for the primary viewing angle of 25°.

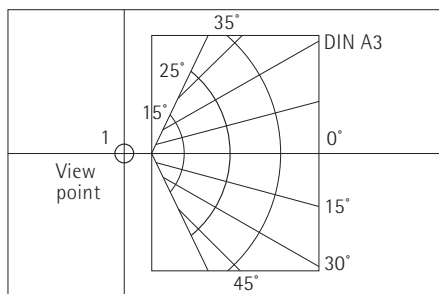
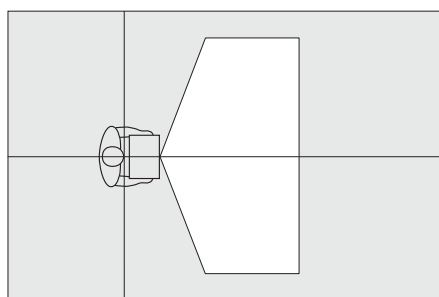

Grid for calculating the contrast rendition factor, taking as a basis an A3 format area of view at viewing position (1), 50 mm in front of and 400 mm above the front edge of the area under consideration.

Recommendations for average and minimum CRF values depending on the type of visual task and CRF rating.

Visual task	Contrast rendering	CRF cat.	CRF av. value	CRF min. value
Predominantly glossy	High	1	$1.0 \leq CRF$	≥ 0.95
Matt with a soft sheen	Average	2	$0.85 \leq CRF < 1.0$	≥ 0.7
Matt	Low	3	$0.7 \leq CRF < 0.85$	≥ 0.5

2.5.4 Luminous colour and colour rendering

Apart from luminance, which is perceived as brightness, the eye also registers an impression of colour based on the spectral composition of the perceived light. The light itself can also be seen as being coloured (luminous colour). Colour is, however, also produced through the capacity of various materials to absorb specific spectral ranges, thereby changing the spectral composition of the light which they reflect (object colour).

There are various systems by which colours are described.

The Munsell system or the DIN colour chart arrange object colours according to brightness, hue and saturation, which produces a comprehensive colour atlas in the form of a three-dimensional matrix. Brightness is referred to in this case as the reflecting coefficient of an object colour; hue is the colour tone, and the term saturation refers to the degree of colour strength from pure colour to the non-coloured grey scale.

In the CIE's standard chromaticity diagram object colours and luminous colour are, however, not arranged according to a three-dimensional catalogue. They are calculated or measured according to the spectral composition of the illuminant for luminous colours, or the reflectance or transmittance of the object for object colours, and presented in a continuous two-dimensional diagram. This system disregards brightness as a dimension, with the result that only hue and saturation can be determined using this diagram.

The CIE chromaticity diagram represents a plane that comprises all actual colours and satisfies a number of other conditions. The plane is surrounded by a curved borderline, along which the colour loci of the saturated spectral colours lie.

The point of lowest saturation is located in the centre of the plane, and is referred to as the white point. All degrees of saturation of a colour on the saturation scale can now be found on the lines that run between the white point and the spectral colour loci. Additive combinations of two colours also lie along the straight lines that link the respective colour loci.

A curve can be drawn inside the coloured area to show the luminous colour of a Planckian radiator (black body) at different colour temperatures; this curve can be used to describe the luminous colour of incandescent lamps. To be able to describe the luminous colour of discharge lamps, a series of straight lines of correlated colour temperatures is entered on the graph, starting from the Planckian radiator curve. With the aid of this array of lines it is also possible to allocate luminous colours that are not present on this curve to the colour temperature of a

The CIE's chromaticity diagram. The spectrum locus links the colour loci of all saturated spectral colours. The purple boundary forms the line between the long-wave and short-wave spectral range. The white point E marks the point of least

saturation. The borderlines that separate the different colour regions fan out from the white point. The chromaticity of any real colour can be defined using the x/y coordinates in the chromaticity diagram.

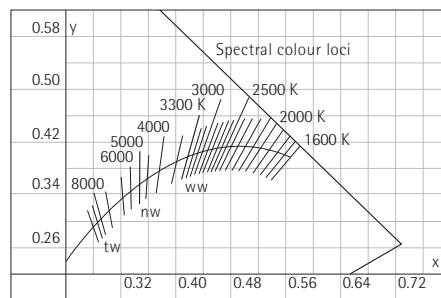
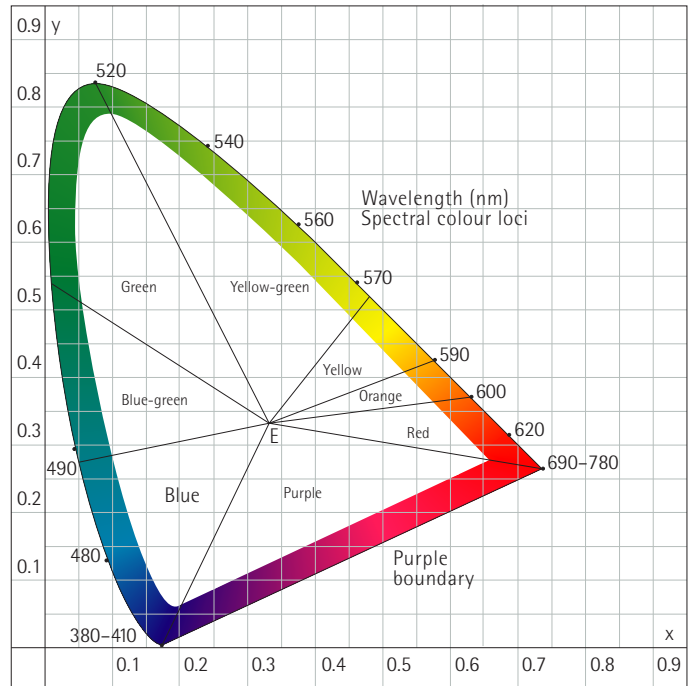

Section of the chromaticity diagram with the curve relating to the Planckian radiator and the series of straight lines marking the colour loci of the same correlated colour temperature between 1600 and 10000 K. The ranges given are the luminous colours of warm white (ww), neutral white (nw) and daylight white (dw).

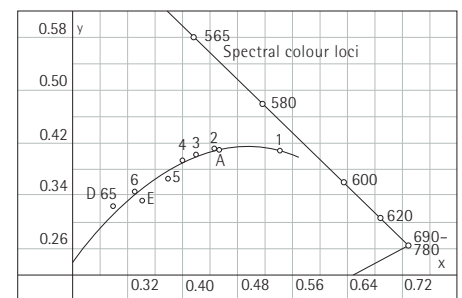

Section of the chromaticity diagram with the curve relating to the Planckian radiator and the colour loci of standard illuminants A (incandescent light) and D 65 (daylight) plus the colour loci of typical light sources: candle-light (1), incandescent lamp (2), halogen lamp (3), fluorescent lamps in ww (4), nw (5) and dw (6).

2.5 Light

2.5.4 Luminous colour and colour rendering

thermal radiator. It is possible to differentiate between three main groups of luminous colours here: the warm white range which resemble most closely colour temperatures below 3300 K, the neutral white range between 3300 and 5000 K and the daylight white range which resemble most closely colour temperatures above 5000 K.

The colour of illuminated objects is the result of the spectral composition of the light falling on a body and the ability of the body to absorb or transmit certain components of this light and only reflect or absorb the remaining frequency ranges.

In addition to the resulting, objective calculable or measurable colour stimulus the colour adaptation of the eye also plays a role in our actual perception of things around us. The eye is able to gradually adapt to the predominant luminous colour – similar to the way it adapts to a luminance level – which means that in the case of a lighting situation that comprises different luminous colours virtually constant perception of the scale of object colours is guaranteed.

The degree of deviation is referred to as the colour rendering of the light source. Colour rendering is defined as the degree of change which occurs in the colour effect of objects through lighting with a specific light source in contrast to the lighting with a comparative reference light source. It is therefore a comparison of the similarity of colour effects under two types of lighting.

Since the eye can adapt to different colour temperatures, colour rendering must be determined in relation to luminous colour. One single light source cannot therefore serve as the source of reference; the standard of comparison is rather a comparable light source with a continuous spectrum, be it a thermal radiator of comparable colour temperature, or daylight.

To determine the colour rendering of a light source the colour effects of a scale of eight object colours are calculated under the types of lighting to be evaluated as well as under comparison standard lighting, and the two then compared. The quality of the colour rendering established is expressed as a colour rendering index, which can be related to both general colour rendering (R_a) as well as the rendering of individual colours. The maximum index of 100 represents optimum colour rendering, and lower values correspondingly less adequate colour rendering.

The quality of colour rendering is divided into four categories, in Germany according to DIN standards. These stipulate the minimum requirements for colour rendering for lighting in workplaces. Colour rendering categories 1 and 2 are further sub-

divided – into A and B – to allow a differentiated evaluation of light sources.

Colour rendering category 1 is required for tasks which involve the evaluation of colours. For the lighting of interior spaces, offices and industrial workplaces with demanding visual tasks the minimum colour rendering category required is 2, whereby colour rendering category 3 is sufficient for industrial workplaces. Colour rendering category 4 is only permitted when the lowest of requirements are to be met at illuminance levels of up to 200 lux.

The colour rendering quality is an important criteria when choosing a light source. The degree of colour fidelity, therefore, by which illuminated objects are rendered in comparison to reference lighting. In some cases the index for the rendering of a specific colour has to be taken into account, e.g. in the field of medicine or cosmetics, when skin colours have to be differentiated.

Apart from the rendition quality the choice of luminous colour is also of critical importance for the actual effect of colours. Blue and green colours will appear grey and dull under incandescent light despite its excellent colour rendering properties. The same colours will be seen as clear and bright under daylight white fluorescent light – although its colour rendering properties are not so good. The same applies the other way round for the rendition of yellow and red colours.

The lighting designer's decision as to which light source to select therefore depends on the given situation. Some investigations indicate that a warm colour appearance is preferred at low illuminance levels and in the case of directed light, whereas cold colour appearances are accepted for high illuminance levels and diffuse lighting.

In the case of display lighting the colours of the illuminated objects can be made to appear brighter and more vivid through the purposeful application of luminous colour – if necessary, using average colour rendering. This way of purposefully emphasizing colour qualities can also be applied in retail lighting.

The lighting under which a customer decides which articles he wishes to purchase should not deviate significantly from the lighting conditions the customer is accustomed to.

Spectral distribution $S_e(\lambda)$ of standard illuminants A (incandescent light, above) and D 65 (daylight, below).

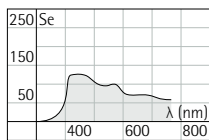
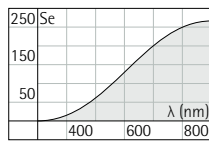

Correlated colour temperature T of typical light sources.

Light source	T (K)
Candle	1900–1950
Carbon filament lamp	2100
Incandescent lamp	2700–2900
Fluorescent lamps	2800–7500
Moonlight	4100
Sunlight	5000–6000
Daylight (sunshine, blue sky)	5800–6500
Overcast sky	6400–6900
Clear blue sky	10000–26000

Colour rendering Category	R_a index
1 A	$R_a > 90$
1 B	$80 \leq R_a \leq 90$
2 A	$70 \leq R_a < 80$
2 B	$60 \leq R_a < 70$
3	$40 \leq R_a < 60$
4	$20 \leq R_a < 40$

Colour rendering categories and their inherent R_a indices.

Controlling light

Luminaires have a number of functions. The first is to accommodate one or more lamps plus any necessary control gear. Mounting, electrical connection and servicing must be as easy and safe as possible.

The construction of the luminaires guarantees that the user is protected from contact with live components (electric shock) and that there is no danger of surrounding surfaces and objects overheating (fire prevention). Luminaires that are to be applied under specific operating conditions – e.g. rooms where there is a danger of an explosion, or damp or humid spaces – must be designed to meet the more stringent requirements. Besides these electrical and safety aspects luminaires also have an aesthetic function as an integral part of the architectural design of a building. It is equally important that the form and arrangement of the luminaires and the lighting effects are appropriate.

The third and perhaps most essential task the luminaire has to fulfil is to control the luminous flux. The aim is to produce a light distribution in accordance with the specific functions the luminaire is required to fulfil, utilizing energy as effectively as possible.

Even in the days of the first artificial light source, the flame, luminaires were developed to ensure that the light source could be mounted and transported safely. With the advent of considerably stronger light sources – first gas lighting and later electric lamps – it became more important to construct luminaires that could control luminance and ensure that the light was distributed as required.

Luminaire technology was first confined to providing a shielding element for the lamp and reducing the luminous intensity of the lamp by means of diffusing lampshades or canopies. This was one way of limiting glare, but did not control the distribution of the light, which was absorbed or able to scatter in undefined directions. You will still find this combination of lamp and lampshade today – especially in the decorative market – in spite of their being relatively inefficient.

The introduction of reflector and PAR lamps, which were used widely in the USA, marked the first step towards controlling light purposefully and efficiently. In these light sources the light is concentrated by the reflectors that form an integral part of the lamp and efficiently directed as required in defined beam angles. In contrast to luminaires with exposed lamps, the lighting effect was therefore no longer confined to the vicinity of the luminaire. It became possible to accentuate specific areas from almost any point within the space. The reflector lamp took on the task of controlling the light;

the luminaire only served as a device to hold the lamp and as a means for limiting glare.

One disadvantage of reflector lamps was the fact that every time you replaced the lamp you also replaced the reflector, which meant high operating costs. Apart from that, there were only a few standardised reflector types available, each with different beam angles, so for special tasks – e.g. asymmetrical light distribution in the case of a washlight – there was frequently no suitable reflector lamp available. The demand for more differentiated lighting control, for enhanced luminaire efficiency and improved glare limitation led to the reflector being taken from the lamp and integrated into the luminaire. This means that it is possible to construct luminaires that are designed to meet the specific requirements of the light source and the task which can now be applied as instruments for differentiated lighting effects.

2.6.1 Principles of controlling light

Various optical phenomena can be used in the construction of luminaires as a means for controlling light:

2.6.1.1 Reflection

In the case of reflection, the light falling onto a surface is fully or partially reflected, depending on the reflecting coefficient of this surface. Besides reflectance the degree of diffusion of the reflected light is also significant. In the case of specular surfaces there is no diffusion. The greater the diffusing power of the reflecting surface, the smaller the specular component of the reflected light, up to the point where only diffuse light is produced.

Specular reflection is a key factor in the construction of luminaires; the purposeful control of light can be achieved through specially designed reflectors and surfaces, which also define the light output ratio.

2.6.1.2 Transmission

Transmission describes how the light falling on a body is totally or partially transmitted depending on the transmission factor of the given body. The degree of diffusion of the transmitted light must also be taken into account. In the case of completely transparent materials there is no diffusion. The greater the diffusing power, the smaller the direct component of the transmitted light, up to the point where only diffuse light is produced.

Transmitting materials in luminaires can be transparent. This applies to simple front glass panels, or filters that absorb certain spectral regions but transmit others,

2.6 Controlling light
2.6.1 Principles

Luminous intensity distribution I (top left) and luminance distribution L (top right) in the case of diffuse reflection. The luminance distribution is the same from all angles of view. Luminous intensity distribution in the case of mixed reflection (centre) and specular reflection (below).

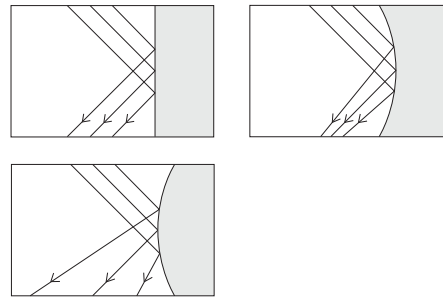
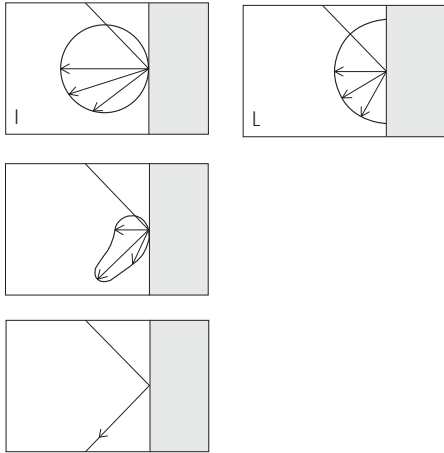

Specular reflection of parallel beams of light falling onto a flat surface (parallel path of rays), concave surface (converging rays) and convex surface (diverging rays).

Reflection factor of common metals, paint colours and building materials.

Metals	
Aluminium, highly specular	0.80–0.85
Aluminium, anodised, matt finish	0.75–0.85
Aluminium, matt finish	0.50–0.75
Silver, polished	0.90
Copper, polished	0.60–0.70
Chrome, polished	0.60–0.70
Steel, polished	0.50–0.60

Paint finish	
White	0.70–0.80
Pale yellow	0.60–0.70
Pale green, light red, pale blue, light grey	0.40–0.50
Beige, ochre, orange, mid-grey,	0.25–0.35
dark grey, dark red, dark blue, dark green	0.10–0.20

Building materials	
Plaster, white	0.70–0.85
Gypsum	0.70–0.80
Enamel, white	0.60–0.70
Mortar, light	0.40–0.50
Concrete	0.30–0.50
Granite	0.10–0.30
Brick, red	0.10–0.20
Glass, clear	0.05–0.10

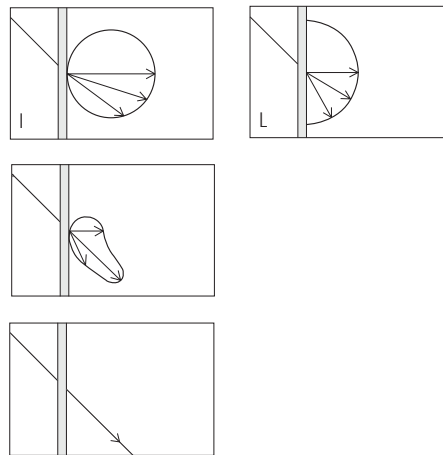

Luminous intensity distribution I (top left) and luminance distribution L (top right) in the case of diffuse transmission. The luminance distribution is the same from all angles of view. Luminous intensity distribution in the case of mixed transmittance (centre) and direct transmittance through transparent material (below).

thereby producing coloured light or a reduction in the UV or IR range. Occasionally diffusing materials – e.g. opal glass or opal plastics – are used for front covers in order to reduce lamp luminance and help to control glare.

2.6.1.3 Absorption

Absorption describes how the light falling on a surface is totally or partially absorbed depending on the absorption factor of the given material.

In the construction of luminaires absorption is primarily used for shielding light sources; in this regard it is essential for visual comfort. In principle, absorption is, however, not wanted, since it does not control, but rather wastes light, thereby reducing the light output ratio of the luminaire. Typical absorbing elements on a luminaire are black multigrooved baffles, anti-dazzle cylinders, barn doors or louvres in various shapes and sizes.

2.6.1.4 Refraction

When beams of light enter a clear transmitting medium of differing density – from air into glass and vice versa from glass into the air, for example – it is refracted, i.e. the direction of its path is changed. In the case of objects with parallel surfaces there is only a parallel light shift, whereas prisms and lenses give rise to optical effects ranging from change of radiation angle to the concentration or diffusion of light to the creation of optical images. In the construction of luminaires refracting elements such as prisms or lenses are frequently used in combination with reflectors to control the light.

2.6.1.5 Interference

Interference is described as the intensification or attenuation of light when waves are superimposed. From the lighting point of view interference effects are exploited when light falls on extremely thin layers that lead to specific frequency ranges being reflected and others being transmitted. By arranging the sequence of thin layers of metal vapour according to defined thicknesses and densities, selective reflectance can be produced for specific frequency ranges. The result can be that visible light is reflected and infrared radiation transmitted, for example – as is the case with cool-beam lamps. Reflectors and filters designed to produce coloured light can be manufactured using this technique. Interference filters, so-called dichroic filters, have a high transmission factor and produce particularly distinct separation of reflected and transmitted spectral ranges.

When transmitted from one medium with a refractive index of n_1 into a denser medium with a refractive index of n_2 rays of light are diffracted towards the axis of incidence ($\epsilon_1 > \epsilon_2$). For the transition from air to glass the refractive index is approx. $n_2/n_1 = 1.5$.

$$\frac{\sin \epsilon_1}{\sin \epsilon_2} = \frac{n_2}{n_1}$$

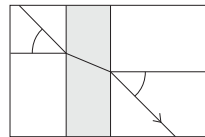
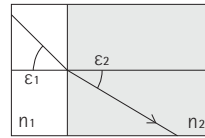

When transmitted through a medium of a different density, rays are displaced in parallel.

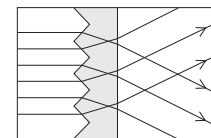
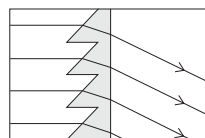

Typical ray tracing through an asymmetrical prismatic panel (top left), symmetrical ribbed panel (top right), Fresnel lens (bottom left) and collecting lens (bottom right).

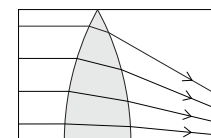
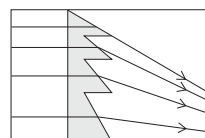

$$\sin \epsilon_G = \frac{n_2}{n_1}$$

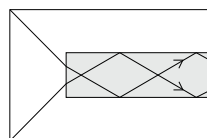
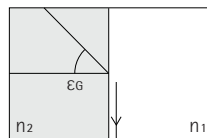

There is an angular limit ϵ_G for the transmission of a ray of light from a medium with a refractive index of n_2 into a medium of less density with a refractive index of n_1 . If this critical angle is exceeded the ray of light is reflected into the denser medium (total reflection). For the transition from glass to air the angular limit is approx. $\epsilon_G = 42^\circ$. Light guides function according to the principle of total internal reflection (below).

2.6.2 Reflectors

Reflectors are probably the most important elements in the construction of luminaires for controlling light. Both reflectors with diffusely reflecting surfaces – mostly white or with a matt finish – and highly specular surfaces are used. These reflectors were originally made of glass with a mirrored rear surface, which led to the term which is still used today: mirror reflector technology. Anodized aluminium or chrome or aluminium-coated plastic are generally used as reflector material today. Plastic reflectors are reasonably low-priced, but can only take a limited thermal load and are therefore not so robust as aluminium reflectors, whose highly resistant anodized coating provides mechanical protection and can be subjected to high temperatures.

Aluminium reflectors are available in a variety of qualities, ranging from high-quality super-purity aluminium to reflectors with only a coating of pure aluminium. The thickness of the final anodised coating depends on the application; for interior applications it is around 3–5 µm, for luminaires to be used in exterior spaces or chemically aggressive environments up to 10 µm. The anodising process can be applied to the aluminium coil (coil anodising) or on the finished reflectors (stationary anodising), which is more expensive.

The surfaces of the reflectors can have a specular or matt finish. The matt finish produces greater and more uniform reflector luminance. If the reflected light beam is to be slightly diffuse, be it to attain softer light or to balance out irregularities in the light distribution, the reflector surfaces may have a faceted or hammered finish. Metal reflectors may receive a dichroic coating, which can control light luminous colour or the UV or IR component.

Light distribution is determined to a large extent by the form of the reflector. Almost all reflector shapes can be attributed to the parabola, the circle or the ellipse.

Circle (1), ellipse (2), parabola (3) and hyperbola (4) as the sectional planes of a cone (above). Diagram of the sectional planes and sections (below).

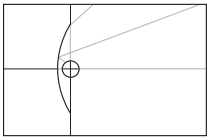
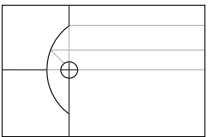
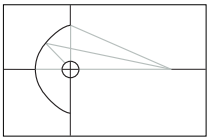
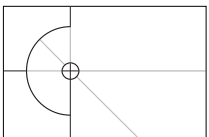
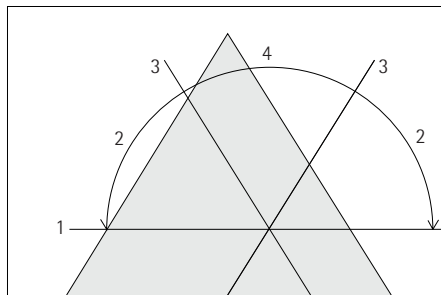
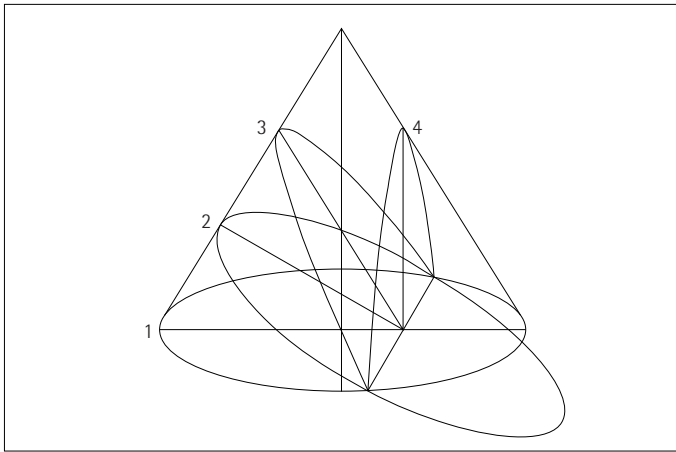

Ray tracing from a point light source when reflecting on circle, ellipse, parabola and hyperbola (from top to bottom).

Parabolic reflector with short distance between focal point and apex of the reflector; reflector acts as a cut-off element.

Parabolic reflector with greater distance between focal point and apex of the reflector; no shielding for direct rays.

Parabolic reflector with greater distance between focal point and apex of the reflector, spherical reflector as a shielding element.

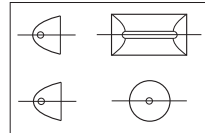
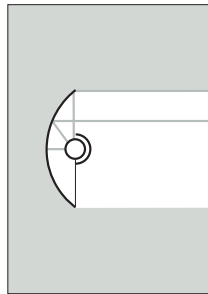
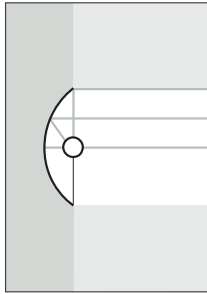
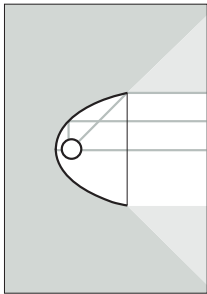

Parabolic contours of rectangular reflectors and rotationally symmetrical reflectors.

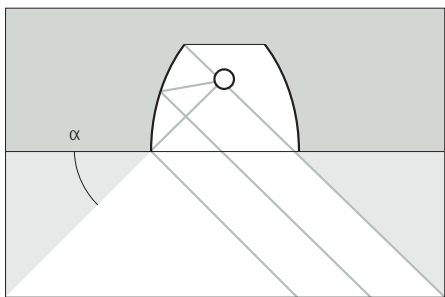
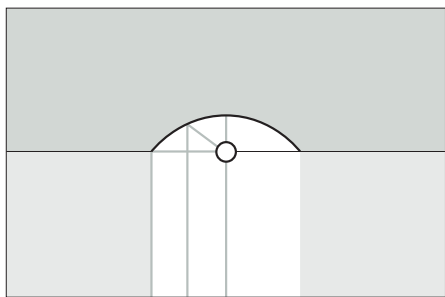

Parabolic reflector with intense directional light (above). Wide-angle parabolic reflector with cut-off angle α (below).

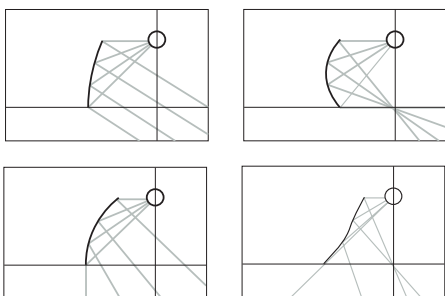

Parabolic reflector for glare limitation for flat and linear light sources. When the focal point is located at the nadir (1) of the opposite parabolic segment no light is radiated above the cut-off angle α .

Reflector contours for parallel rays / parabola (top left), converging rays / ellipse (top right), diverging rays / hyperbola (bottom left) and converging-diverging rays (bottom right).

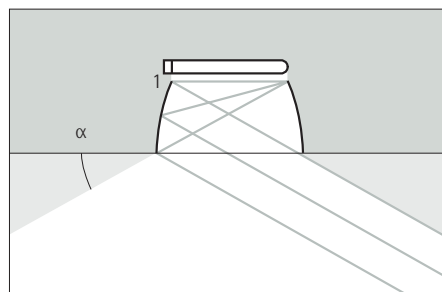

2.6.2.1 Parabolic reflectors

The most widely used reflectors are parabolic reflectors. They allow light to be controlled in a variety of ways – narrow-beam, wide-beam or asymmetrical distribution, and provide for specific glare limitation characteristics.

In the case of parabolic reflectors the light emitted by a light source located at the focal point of the parabola is radiated parallel to the parabolic axis. The more the light source deviates from the ideal point source – in relation to the diameter of the parabola – the more the rays of light emitted will diverge.

If the reflector contour is constructed by rotating a parabola or parabolic segment around its own axis, the result is a reflector with narrow-beam light distribution. In the case of linear light sources a similar effect is produced when rectangular reflectors with a parabolic cross section are used.

If the reflector contour is constructed by rotating a parabolic segment around an axis, which is at an angle to the parabolic axis, the result is a reflector with wide-beam to batwing light distribution characteristics. Beam angles and cut-off angles can therefore basically be defined as required, which allows luminaires to be constructed to meet a wide range of light distribution and glare limitation requirements.

Parabolic reflectors can also be applied with linear or flat light sources – e.g. PAR lamps or fluorescent lamps, although these lamps are not located at the focal point of the parabola. In this case the aim is not so much to produce parallel directional light but optimum glare limitation. In this type of construction the focal point of the parabola lies at the nadir of the opposite parabolic segments, with the result that no light from the light source located above the reflector can be emitted above the given cut-off angle. Such constructions are not only possible in luminaires, but can also be applied to daylight control systems; parabolic louvres – e.g. in skylights – direct the sunlight so that glare cannot arise above the cut-off angle.

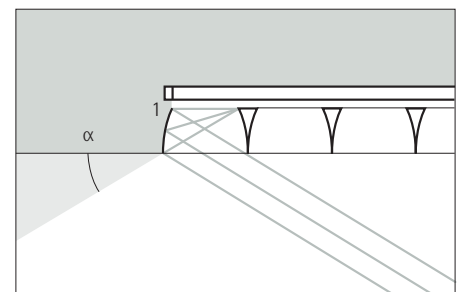

2.6 Controlling light

2.6.2 Reflectors

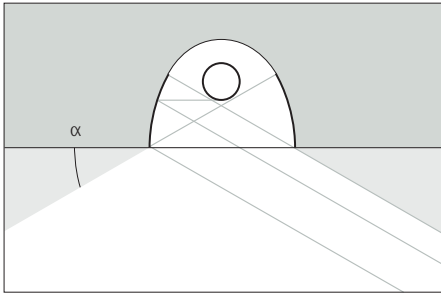

Darklight technology. By using reflectors with a variable parabolic focal point no light is radiated above cut-off angle α , especially in the case of volume radiating sources.

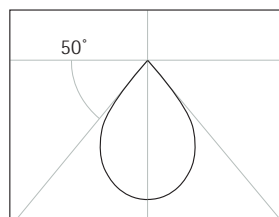
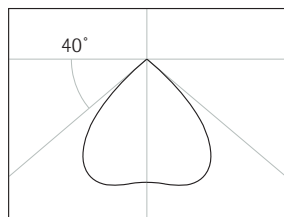
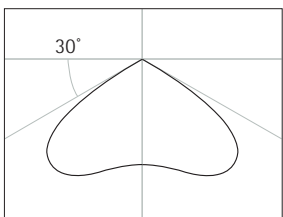
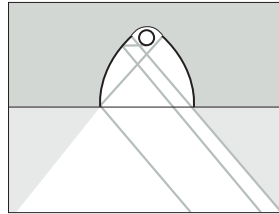
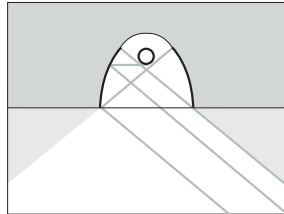
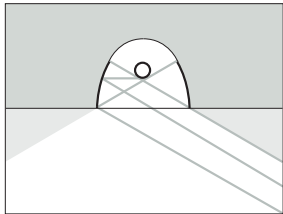

Through the calculation of specific reflector contours various cut-off angles and distribution characteristics can be obtained for the same ceiling opening and lamp geometry.

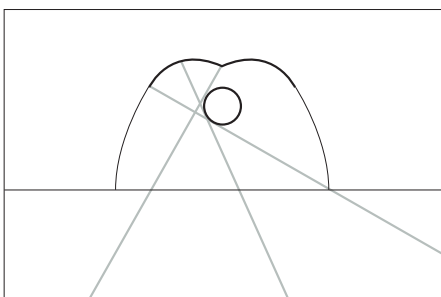

Involute reflectors: light radiated by the lamp is reflected past the light source.

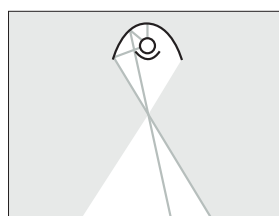
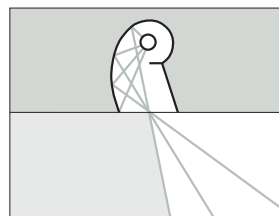
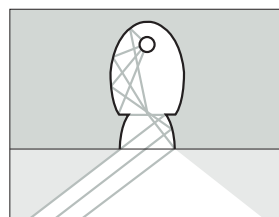

Elliptical reflectors in double-focus downlights (above), wall-washers (centre) and spotlights (below).

2.6.2.2 Darklight reflectors

In the case of the above-mentioned parabolic reflectors clearly defined light radiation – and effective glare limitation – is only possible for exact, point light sources. When using larger radiating sources – e.g. frosted incandescent lamps – glare will occur above the cut-off angle; glare is visible in the reflector, although the lamp itself is shielded. By using reflectors with a variable parabolic focal point (so-called darklight reflectors) this effect can be avoided; brightness will then only occur in the reflector of larger radiating sources below the cut-off angle, i.e. when the light source is visible.

2.6.2.3 Spherical reflectors

In the case of spherical reflectors the light emitted by a lamp located at the focal point of the sphere is reflected to this focal point. Spherical reflectors are used predominantly as an aid in conjunction with parabolic reflectors or lens systems. They direct the luminous flux forwards onto the parabolic reflector, so that it also functions in controlling the light, or to utilize the light radiated backwards by means of retroreflection back towards the lamp.

2.6.2.4 Involute reflectors

Here the light that is emitted by the lamp is not reflected back to the light source, as is the case with spherical reflectors, but reflected past the lamp. Involute reflectors are mainly used with discharge lamps to avoid the lamps over-heating due to the retro-reflected light, which would result in a decrease in performance.

2.6.2.5 Elliptical reflectors

In the case of elliptical reflectors the light radiated by a lamp located at the first focal point of the ellipse is reflected to the second focal point. The second focal point of the ellipse can be used as an imaginary, secondary light source.

Elliptical reflectors are used in recessed ceiling washlights to produce a light effect from the ceiling downwards. Elliptical reflectors are also ideal when the smallest possible ceiling opening is required for downlights. The second focal point will be an imaginary light source positioned at ceiling level; it is, however, also possible to control the light distribution and glare limitation by using an additional parabolic reflector.

2.6 Controlling light

2.6.3 Lens systems

2.6.3 Lens systems

In contrast to prismatic louvres, lenses are used practically exclusively for luminaires for point light sources. As a rule the optical system comprises a combination of one reflector with one or more lenses.

2.6.3.1 Collecting lenses

Collecting lenses direct the light emitted by a light source located in its focal point to a parallel beam of light. Collecting lenses are usually used in luminaire constructions together with a reflector. The reflector directs the overall luminous flux in beam direction, the lens is there to concentrate the light. The distance between the collecting lens and the light source is usually variable, so that the beam angles can be adjusted as required.

2.6.3.2 Fresnel lenses

Fresnel lenses consist of concentrically aligned ring-shaped lens segments. The optical effect of these lenses is comparable to the effect produced by conventional lenses of corresponding shape or curvature. Fresnel lenses are, however, considerably flatter, lighter and less expensive, which is why they are frequently used in luminaire construction in place of converging lenses.

The optical performance of Fresnel lenses is confined by aberration in the regions between the segments; as a rule the rear side of the lenses is structured to mask visible irregularities in the light distribution and to ensure that the beam contours are soft. Luminaires equipped with Fresnel lenses were originally mainly used for stage lighting; in the meantime they are also used in architectural lighting schemes to allow individual adjustment of beam angles when the distance between luminaires and objects varies.

2.6.3.3 Projecting systems

Projecting systems comprise an elliptical reflector or a combination of spherical reflector and condenser to direct light at a carrier, which can be fitted with optical accessories. The light is then projected on the surface to be illuminated by the main lens in the luminaire.

Image size and beam angle can be defined at carrier plane. Simple aperture plates or iris diaphragms can produce variously sized light beams, and contour masks can be used to create different contours on the light beam. With the aid of templates (gobos) it is possible to project logos or images.

In addition, different beam angles or image dimensions can be selected depen-

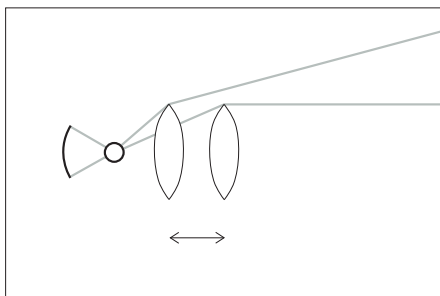

Collecting lens (above) and Fresnel lens (below). The beam angle can be varied by changing the distance between lens and light source.

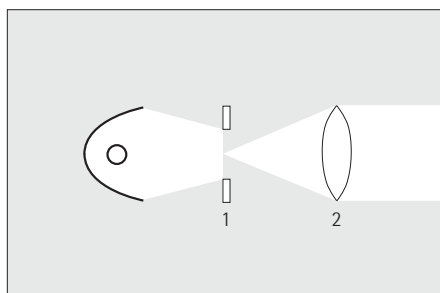
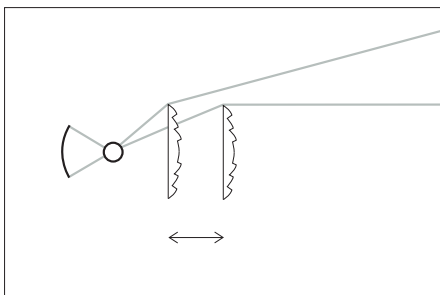

Projector with projecting system: a uniformly illuminated carrier (1) is focussed via a lens system (2). The ellipsoidal projector (above) with high light output, and the condenser projector (below) for high quality definition.

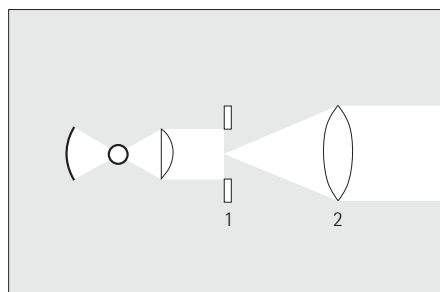

2.6 Controlling light
 2.6.4 Prismatic systems
 2.6.5 Accessories

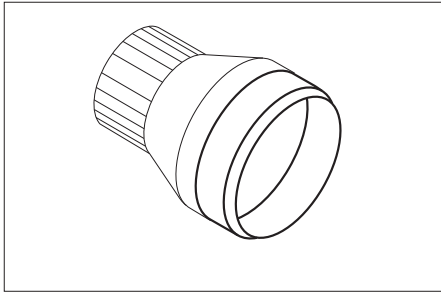

Light head of a spot-light to which various accessories can be fitted.

Accessories (from the top down): flood lenses to widen the light beam. Sculpture lens to produce an oval light beam. Multigroove baffle and honeycomb anti-dazzle screen to control the light beam and reduce glare.

Typical light distribution of a fluorescent lamp equipped with prismatic optics.

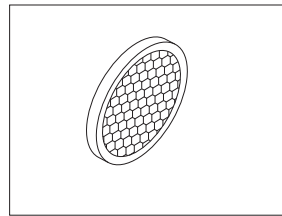
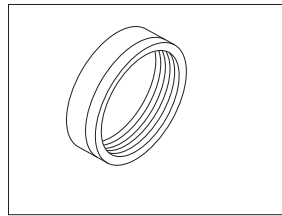
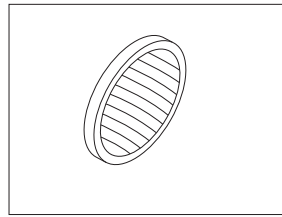
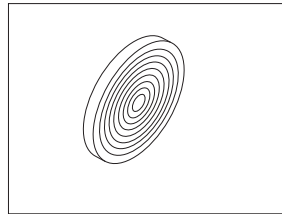
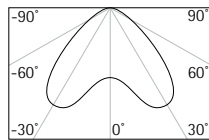
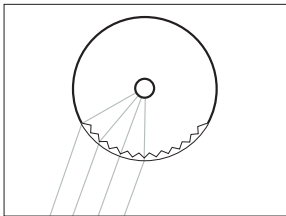

ding on the focal length of the lenses. In contrast to luminaires for Fresnel lenses it is possible to produce light beams with sharp contours; soft contours can be obtained by setting the projector out of focus.

2.6.4 Prismatic systems

Another optical means of controlling light is deflection using prisms. It is known that the deflection of a ray of light when it penetrates a prism is dependent on the angle of the prism. The deflection angle of the light can therefore be determined by the shape of the prism.

If the light falls onto the side of the prism above a specific angle, it is not longer refracted but reflected. This principle is also frequently applied in prismatic systems to deflect light in angles beyond the widest angle of refraction.

Prismatic systems are primarily used in luminaires that take fluorescent lamps to control the beam angle and to ensure adequate glare limitation. This means that the prisms have to be calculated for the respective angle of incidence and combined to form a lengthwise oriented louvre or shield which in turn forms the outer cover of the luminaire.

2.6.5 Accessories

Many luminaires can be equipped with accessories to change or modify their photometric qualities. The most important are supplementary filters, which provide coloured light, or reduce the UV or IR component. Filters may be made of plastic foil, although glass filters are more durable. Apart from conventional absorption filters there are also interference filters (dichroic filters) available, which have high transmission and produce exact separation of transmitted and reflected spectral components.

Wider and softer light distribution can be achieved using flood lenses, whereas sculpture lenses produce an elliptical light cone. Additional glare shields or honeycomb anti-dazzle screens can be used to improve glare limitation. In the case of increased risk of mechanical damage, above all in sports facilities and in areas prone to vandalism, additional protective shields can be fitted.

Spectral transmission $\tau(\lambda)$ for conventional filters.

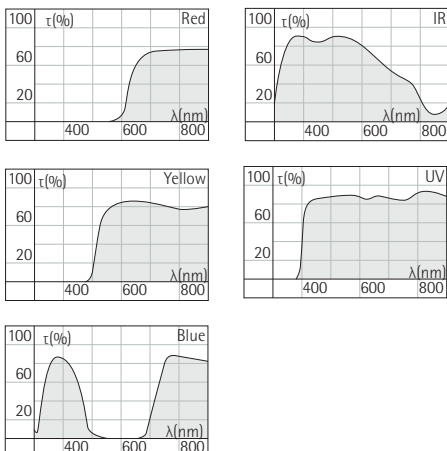

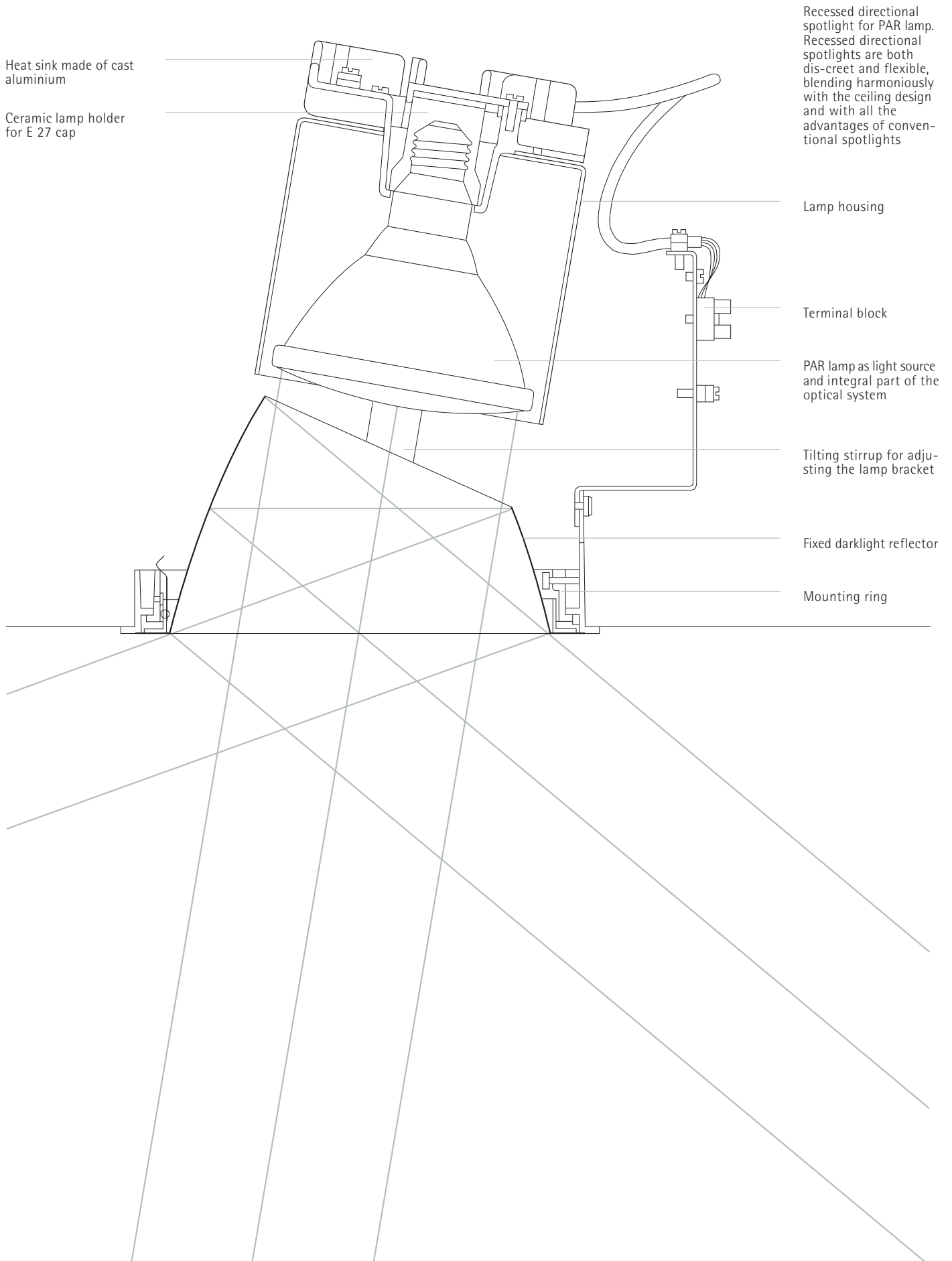

Luminaires

There are various types of luminaires available. One main group comprises decorative luminaires, where outward appearance is more important than the light they produce. We will not be dealing with this type of luminaire in depth. This book is more concerned with luminaires with clearly defined photometric qualities that can be applied in the field of architectural lighting. This sector also comprises a wide range of luminaire types, which can be classified according to different criteria. For our purposes we have divided these into three main groups: stationary luminaires, movable luminaires and light structures.

2.7.1 Stationary luminaires

Stationary luminaires are an integral part of the architecture. Occasionally it is possible to vary light direction, but rigid mounting usually means that the light direction is also fixed. Stationary luminaires can be further subdivided according to luminaire characteristics and design.

2.7 Luminaires

2.7.1 Stationary luminaires

2.7.1.1 Downlights

As the name implies, downlights direct light predominantly downwards. Downlights are usually mounted on the ceiling. They may be recessed, which means that they are hardly visible as luminaires and only effective through the light they emit. Downlights are, however, also available as surface or pendant luminaires. A special version, which is found more in hallways or exterior spaces, is the wall-mounted downlight.

In their basic form **downlights** therefore radiate light vertically downwards. They are usually mounted on the ceiling and illuminate the floor or other horizontal surfaces. On vertical surfaces – e.g. walls – the light patterns they produce have a typical hyperbolic shape (scallops).

Downlights are available with different light distributions. Narrow-beam downlights only light a small area, but give rise to fewer glare problems due to their steep cut-off angle. Some downlight forms have supplementary louvre attachments in the reflector aperture as an extra protection against glare. In the case of downlights with darklight reflectors the cut-off angle of the lamp is identical to the cut-off angle of the luminaire, thereby producing a luminaire with optimal wide-angle light distribution and light output ratio.

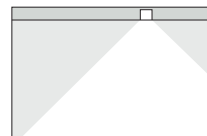
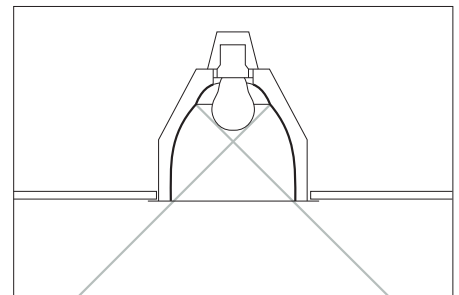

Recessed downlight for incandescent lamps. Darklight technology, where the cut-off angle of the lamp is identical to the cut-off angle of the luminaire.

Different reflector shapes produce different cut-off angles from the same ceiling aperture.

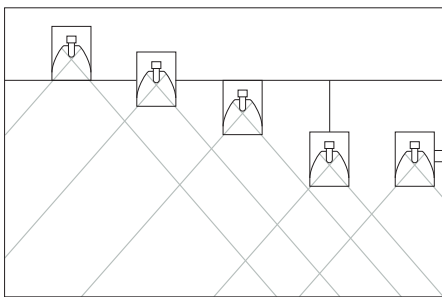
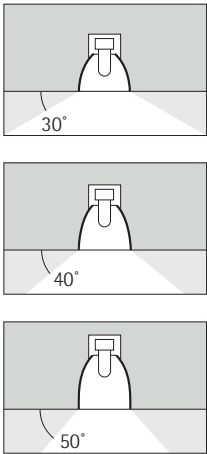

Mounting options for downlights: recessed, semi-recessed, surface, pendant and wall mounting.

Recessed downlight for high-pressure discharge lamps. Lamp and reflector are separated by a safety glass cover.

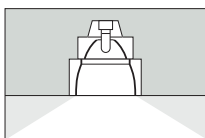

Recessed downlights for compact fluorescent lamps, versions with integrated and separate control gear (above) and with cross-blade louvre (below).

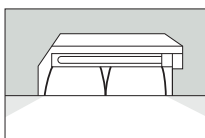
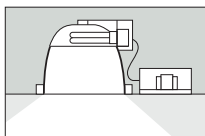
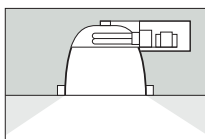

Double-focus downlights have similar properties to conventional downlights, but the special form of the reflector allows high luminous efficiency even though the ceiling aperture is small.

Double-focus downlight with ellipsoidal reflector and additional parabolic reflector with especially small ceiling aperture.

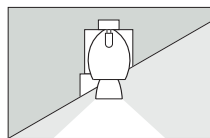
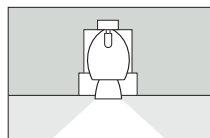
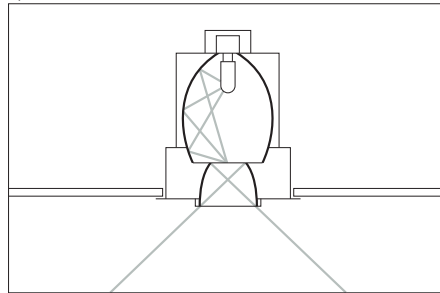

Installation of double-focus downlights in horizontal and inclined ceilings.

Washlights have asymmetrical lighting distribution, which not only directs the light vertically downwards, but also directly onto vertical surfaces. They are used to achieve uniform illumination over wall surfaces as a complement to horizontal lighting. Depending on the type used washlights are designed to illuminate a section of a wall, the corner of a space or two opposite sections of wall.

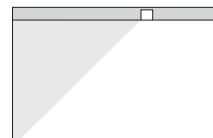
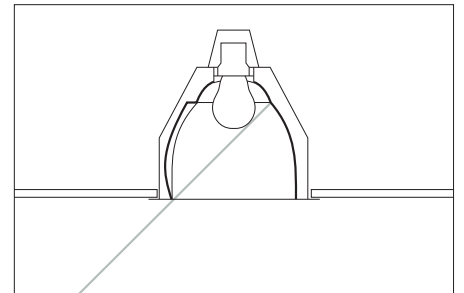

Washlights with dark-light reflectors and additional ellipsoidal segment for the wall lighting.

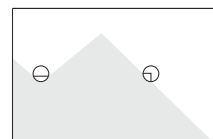
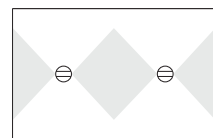
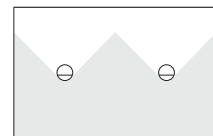

Symbolic representation in plan view: washlights, double washlights and corner washlights.

Directional spotlights provide accent lighting of specific areas or objects. By redirecting the light beam they can be used for different lighting tasks. Their light distribution is narrow to medium.

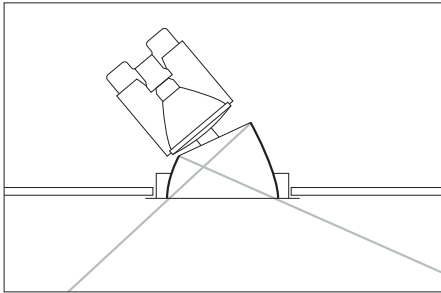

Directional spotlight with adjustable reflector lamp and darklight reflector. Directional spotlights can generally be rotated 360° and inclined to 40°. This means that the directional spotlight can be directed at both horizontal and vertical surfaces.

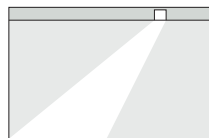
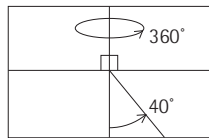

Directional spotlight with darklight reflector.

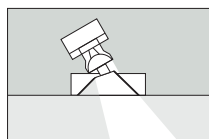
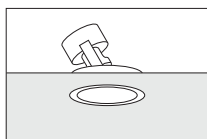

Directional spotlight with anti-dazzle mask.

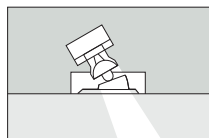
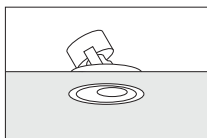

Directional spotlight with cardanic suspension.

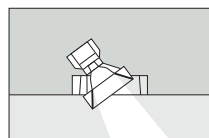
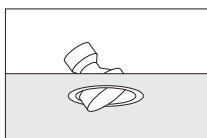

Directional spotlight, spherical version.

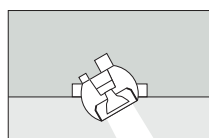
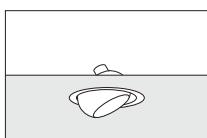

Air-handling downlights are available as air-return and air-handling luminaires. They represent a dual function solution comprising lighting and air-conditioning and make for harmonious ceiling design. Air-handling luminaires can be provided with connections for fresh air supply, for air return or for both air-supply and air-return.

Downlights are available for a wide range of lamps. Those most frequently used are compact light sources such as incandescent lamps, halogen lamps, high-pressure discharge lamps and compact fluorescent lamps.

Air-handling downlight designed for an incandescent lamp. The convection heat produced by the lamp is removed with the air flow.

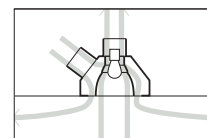
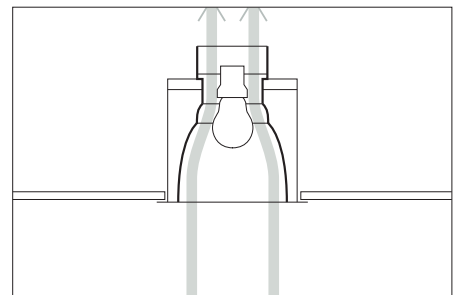

Downlight with combined air-supply and air-return.

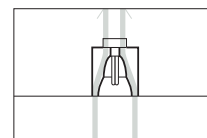

Downlight with air-return function, designed for a compact fluorescent lamp. The return air is dissipated separately, because the cooling effect of the return air may influence the performance of the light source.

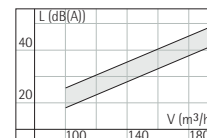

Noise level range L in relation to volume of return air flow V. Typical values for downlights.

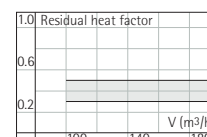

Residual heat factor in relation to volume of return air flow V. Typical values for downlights.

2.7.1.2 Uplights

In contrast to downlights, **uplights** emit light upwards. They can therefore be used for lighting ceilings, for indirect lighting by light reflected from the ceiling or for illuminating walls using grazing light. Uplights can be mounted on or in the floor or wall.

Up-downlights combine a downlight and an uplight in one fixture. These luminaires are applied for the simultaneous lighting of floor and ceiling or for grazing lighting over a wall surface. They are available in wall and pendant versions. .

Wall-mounted combined uplight and downlight for PAR lamps.

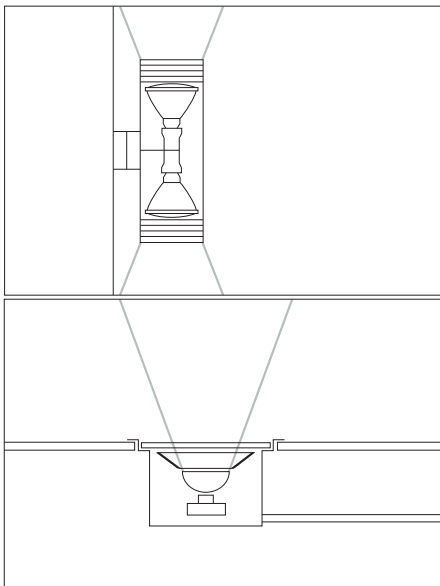

Sectional drawing of a recessed floor luminaire for halogen reflector lamps.

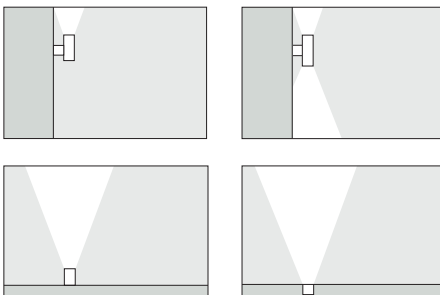

Mounting options for uplights and combined uplight/downlight: wall mounting, floor mounting, recessed floor mounting.

2.7.1.3 Louvred luminaires

Louvred luminaires are designed for linear light sources such as fluorescent lamps or compact fluorescent lamps. Their name derives from their anti-dazzle attachments that may be anti-glare louvres, light controlling specular reflectors or prismatic diffusers.

Being fitted with linear light sources of low luminance louvred luminaires produce little or no modelling effects. They generally have wide-beam light distribution, with the result that louvred luminaires are predominantly used for lighting wide areas.

Louvred luminaires are usually long and rectangular in shape (linear fluorescents); square and round versions are also available for compact fluorescent lamps. Similar to downlights, they are available for recessed or surface mounting or as pendant fixtures.

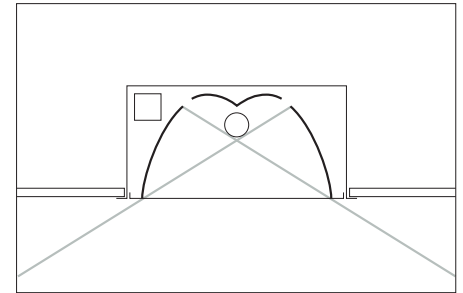

Louvred luminaire for fluorescent lamps with darklight reflector and involute upper reflector. Louvred luminaires can be rectangular, square or round.

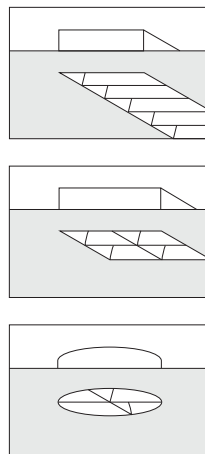

	30	60	90	I (cm)	T [W]	TC-L [W]
						18
						24
					18	36, 40, 55
					36	
					58	

	30	60	90	I (cm)	T [W]	TC-L [W]
						18
						24
						36, 40, 55

Comparison of shapes and sizes of louvred luminaires for different lamps.

	30	60	90	I (cm)	T [W]	TC-L [W]
						18
						24
						36

In their basic form louvred luminaires have axially symmetrical light distribution. They are available with cut-off angles of 30° to 40° and a variety of beam characteristics, so light distribution and glare limitation can be selected to suit the respective requirements. If a reduction in reflected glare is required, louvred luminaires with batwing distribution can be used. They emit light at predominantly low angles with the result that very little light is emitted in the critical reflecting range. Direct glare caused by louvred luminaires can be controlled in a number of ways. The simplest is the application of anti-dazzle louvres to limit the distribution angle. Enhanced luminaire efficiency is best achieved by light-controlling louvres. These louvres can have a highly specular or matt finish. Louvres with a matt finish provide uniform surface luminance in line with the luminance of the ceiling. In the case of highly specular reflectors, the louvre within the cut-off angle can appear to be dark, but they do sometimes lead to unwanted reflections in the louvre. A further means for controlling light in louvred luminaires is by using prismatic diffusers.

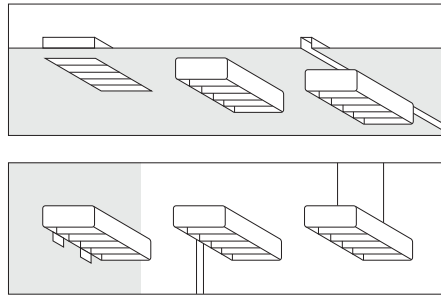

Mounting options for louvred luminaires: recessed ceiling, surface, mounting on tracks, walls, floor-standing or pendant mounting.

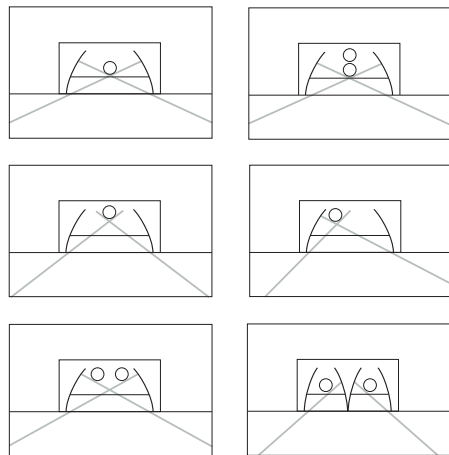

Lamp arrangement in louvred luminaires: standard arrangement above the transverse louvres (top left). Lamp position to increase the cut-off angle (centre left). Twin-lamp version with lamps arranged horizontally and vertically (below left and top right). Lateral position for asymmetrical light distribution (centre right). Twin-lamp version with twin-louvre (below right).

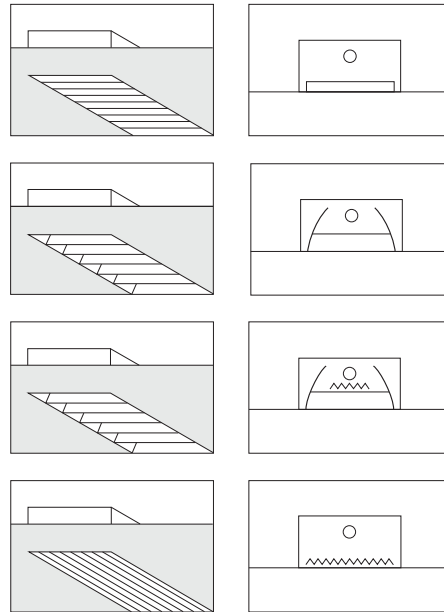

Different versions of louvred luminaires (from the top downwards): luminaire with transverse louvres, luminaire with parabolic louvres, luminaire with parabolic louvres and prismatic lamp diffuser for improving contrast rendition, luminaire with prismatic louvre.

Asymmetric louvred luminaires predominantly radiate light in one direction only. They can be used for the uniform lighting of walls or to avoid glare caused by light projected onto windows or doors.

VDT louvred luminaires are designed for use in spaces with computer workstations. In Germany they must have a cut-off angle of at least 30° along both main axes and must not exceed an average luminance of 200 cd/m² above the cut-off angle. They are therefore generally equipped with highly specular louvres. When using positive contrast monitors higher luminances are permissible, in critical cases a cut-off angle of 40° may be required.

Direct-indirect louvred luminaires are suspended from the ceiling or mounted on the wall. They produce a direct component on horizontal surfaces beneath the luminaire and at the same time light the ceiling and provide diffuse ambient lighting.

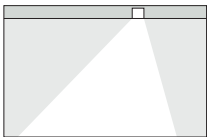
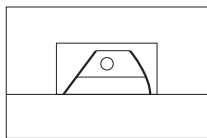
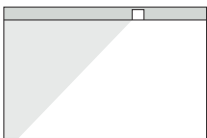
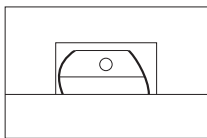
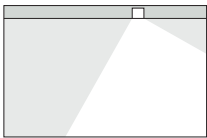
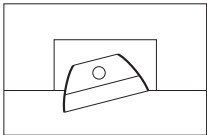

Asymmetric louvred luminaires (from the top down): the wall can be lit by tilting the symmetrical reflector, lighting using a wall-washer with an elliptical side reflector. Lighting without a wall component (e.g. in the vicinity of a window) using a luminaire with a flat side reflector.

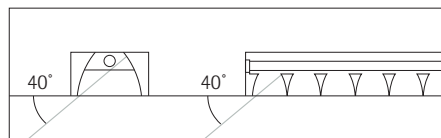
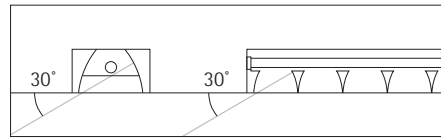

Cut-off angle of 30° (limiting angle 60°) along both main axes (above), cut-off angle of 40° (limiting angle 50°) along both main axes (below).

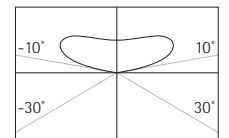
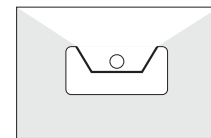
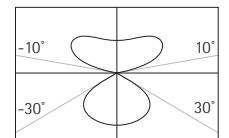
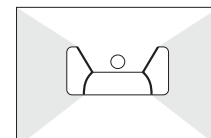
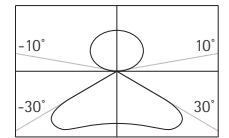
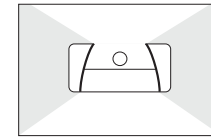
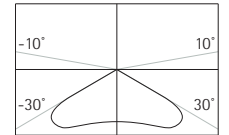
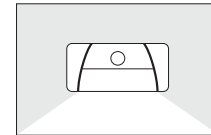

Typical light distribution curves for louvred luminaires: direct luminaire, direct-indirect luminaire with a predominantly direct component, direct-indirect luminaire with a predominantly indirect component, indirect luminaire.

Air-handling louvred luminaires are designed to handle supply air and return air and provide a more harmonious ceiling layout. Air-handling louvred luminaires can be provided with connections/outlets for supply air, return air, or both supply air and return air.

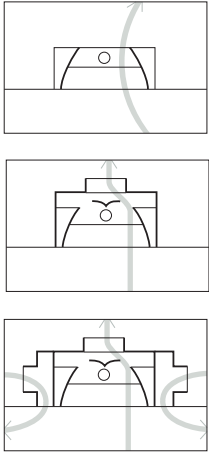

Louvred luminaires with air-return component for negative pressure ceilings, for funnelling return air off into extract air ducts and for combined supply air and return air handling.

2.7.1.4 Washlights

Washlights are designed to provide uniform lighting over extensive surfaces, mainly walls, ceilings and floors, therefore. They are included in the group downlights and louvred luminaires, although washlights do have their own luminaire forms.

Wallwashers illuminate walls and – depending on how they are designed – also a part of the floor. Stationary wallwashers are available as recessed and surface-mounted luminaires.

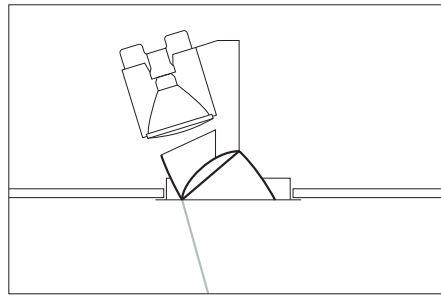

Wallwashers for reflector lamps with a lens to spread the light beam and a darklight reflector. Very little light is directed onto the floor, the wall lighting is especially uniform.

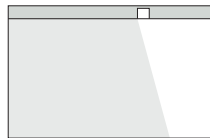

Wallwasher for compact fluorescent lamps.

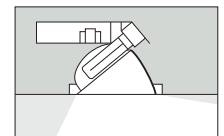
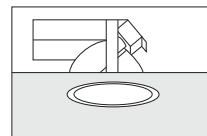

Wallwasher with ellipsoidal reflector for halogen lamps.

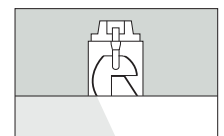
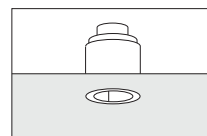

Wallwasher with sculpture lens and reflector attachment for reflector lamps.

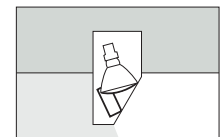
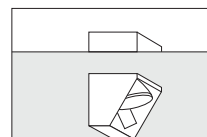

Wallwasher for fluorescent lamps. The direct light component is cut off, the reflector contour produces especially uniform lighting over the wall surface. In the diagram below a supplementary prismatic diffuser below ceiling level provides light directly from the top of the wall.

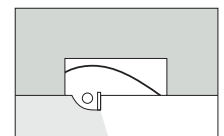
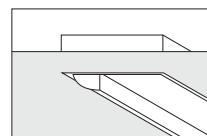
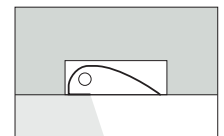
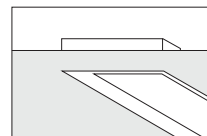

Cantilever-mounted wallwasher.

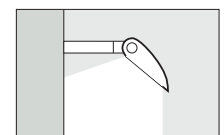
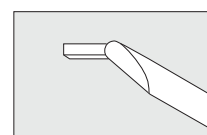

Ceiling washlights are designed for brightening or lighting ceilings and for indirect ambient lighting. They are installed above eye height on the wall or suspended from the ceiling. Ceiling washlights are generally equipped with tungsten halogen lamps for mains voltage or with high-pressure discharge lamps.

Floor washlights are mainly used for lighting hallways and other circulation zones. Floor washlights are mounted in or on the wall at relatively low levels.

2.7.1.5 Integral luminaires

Some forms of lighting use the architectural elements as controlling components of the lighting. Typical examples are luminous ceilings, cove lighting or concealed cornice lighting. Standard luminaires, e.g. for fluorescent lamps or high-voltage tubular lamps can be used for such applications.

As a rule, lighting that is integrated into the architecture is inefficient and, from a lighting engineering point of view, difficult to control. For this reason it does not play a significant role in the effective lighting of spaces. Luminaires can be integrated into the architecture in order to accentuate architectural elements, e.g. to reveal contours. For this purpose they are excellent.

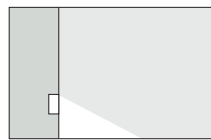
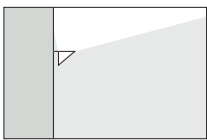
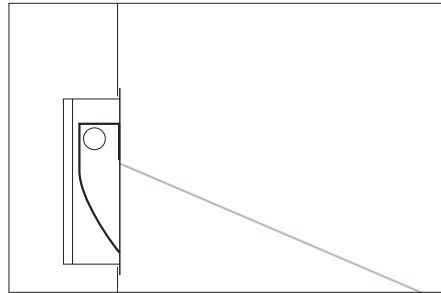
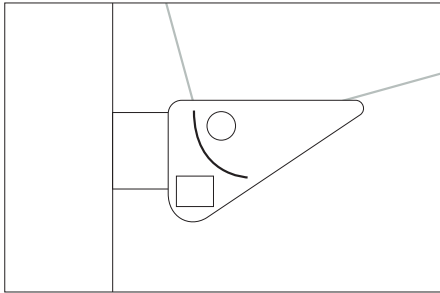

Wall-mounted ceiling washlight. The reflector contours produce uniform ceiling lighting.

Wall-mounted floor washlight. The direct light component is restricted, the reflector shape produces uniform lighting of the floor.

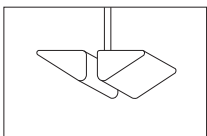
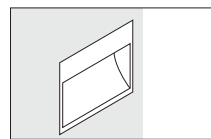
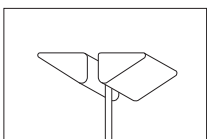
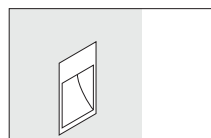
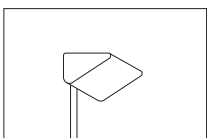
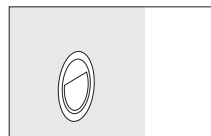
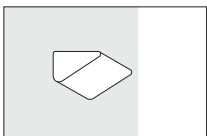

Different versions of ceiling washlights: wall-mounted, free-standing luminaire or pairs of luminaires mounted on a stand and suspended version.

Different versions of floor washlights: round and square versions for incandescent lamps or compact fluorescent lamps, rectangular version for fluorescent lamps.

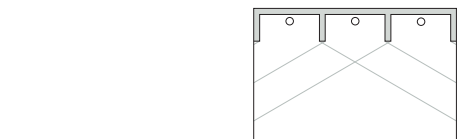
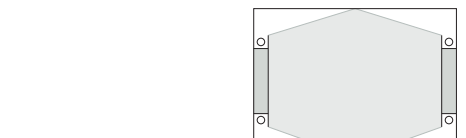
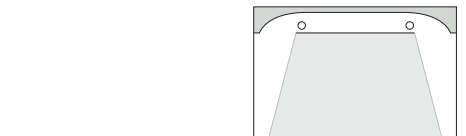
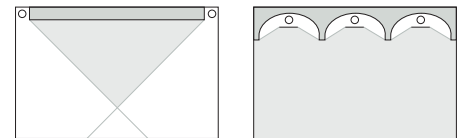
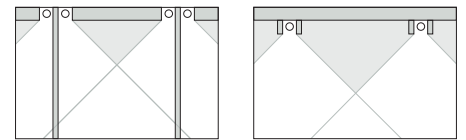

Luminaires integrated into the architecture, e.g. suspended ceiling elements, coffered ceilings and vaulted constructions.

2.7.2 Movable luminaires

In contrast to stationary luminaires movable luminaires can be used in a variety of locations; they are generally used in track systems or in light structures. Movable luminaires usually also allow changes in light direction, they are not confined to a fixed position, but can be adjusted and repositioned as required.

2.7.2.1 Spotlights

Spotlights are the most common form of movable luminaires. They illuminate a limited area, with the result that they are rarely used for ambient lighting but predominantly for accent lighting. In view of their flexibility with regard to mounting position and light direction, they can be adjusted to meet changing requirements.

Spotlights are available in a variety of beam angles. Their narrow-beam light distribution provides for the lighting of small areas from considerable distances, whereas the wider light distribution inherent in wide-beam spotlights means that a larger area can be illuminated using a single spotlight.

Spotlights are available for a wide range of light sources. Since the aim is generally to produce a clearly defined, narrow beam, designers tend to opt for compact light sources such as incandescent lamps, halogen lamps and high-pressure discharge lamps, occasionally also compact fluorescent lamps. Wide-beam spotlights are mainly designed for larger lamps, such as double-ended halogen lamps and high-pressure discharge lamps or compact fluorescent lamps, whereas point sources, such as low-voltage halogen lamps or metal halide lamps provide an especially concentrated beam of light.

Spotlights can be equipped with reflectors or reflector lamps. Some models can be equipped with converging lenses or Fresnel lenses to vary the beam angle. Spotlights with projecting systems allow a variety of different beam contours by the use of projection of masks or templates (gobos).

Another characteristic of spotlights is that they can be equipped with a wide range of accessories or attachments, such as flood or sculpture lenses, colour filters, UV or infrared filters and a range of anti-dazzle attachments, such as barn doors, anti-dazzle cylinders, multigroove baffles or honeycomb anti-dazzle screens.

In the case of spotlights designed for accent lighting the beam angle can be varied by selecting from a range of reflectors or reflector lamps. A distinction is made between narrow beam angles of approx. 10° (spot) and wide-beam angles of approx. 30° (flood).

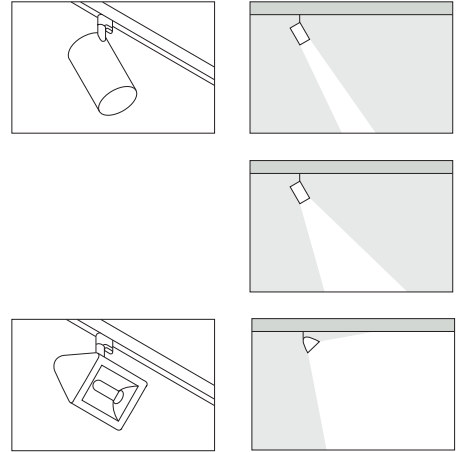

An especially wide beam angle of approx. 90° is characteristic for floodlights designed for the lighting of wall surfaces.

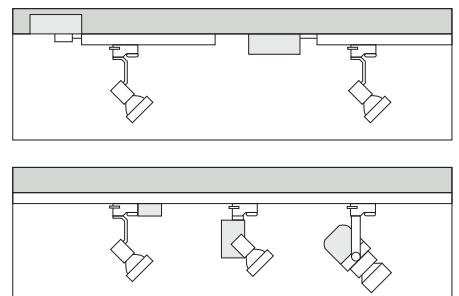

Spotlights for low-voltage halogen lamps can be operated on low-voltage tracks; the transformer can be mounted on the ceiling or be in an exposed position on the track (above). When operating on mains voltage tracks the transformer is usually integrated into the adapter or mounted on the luminaire (below).

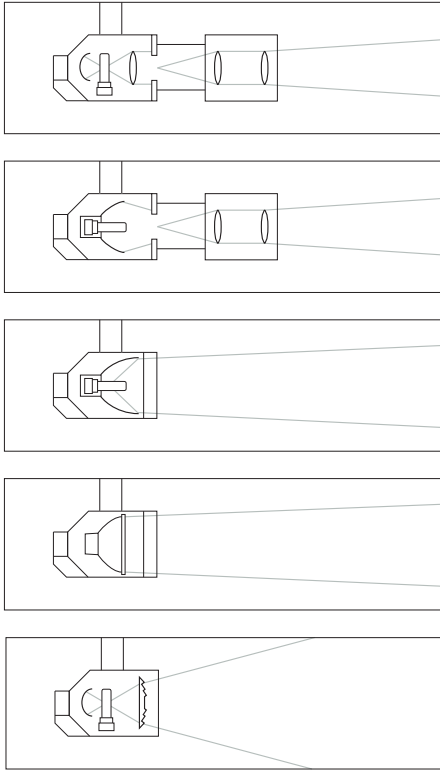

Different versions of stage-type projectors (from the top downwards): condenser projector and ellipsoidal projector with optical systems for projecting images, parabolic projector, projector for reflector lamps and Fresnel projector with variable beam angle.

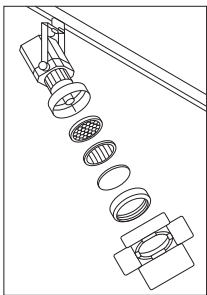

Accessories for spotlights and projectors: honeycomb anti-dazzle screen, sculpture lens, filter, anti-dazzle cylinder, barn doors.

2.7.2.2 Wallwashers

Wallwashers are not only available as stationary luminaires, but also as movable luminaires. In this case it is not so much the light direction that is variable, but the luminaire itself. On track, for example, movable wallwashers can provide temporary or permanent lighting on vertical surfaces. Movable wallwashers are generally equipped with halogen lamps for mains voltage, metal halide lamps or with fluorescent lamps (linear and compact types).

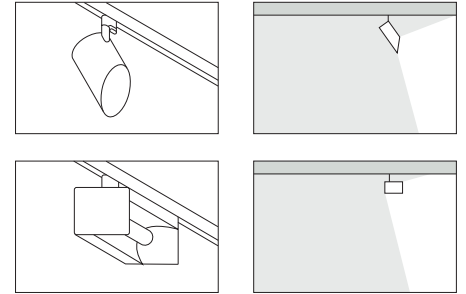

Different versions of movable wallwashers. They can be adjusted to different wall heights and distances.

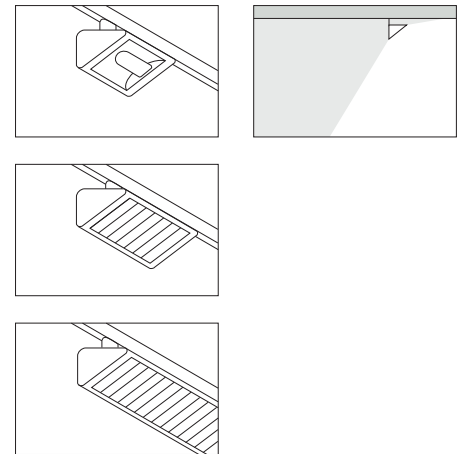

Wallwashers for halogen lamps, compact fluorescent lamps and linear fluorescent lamps.

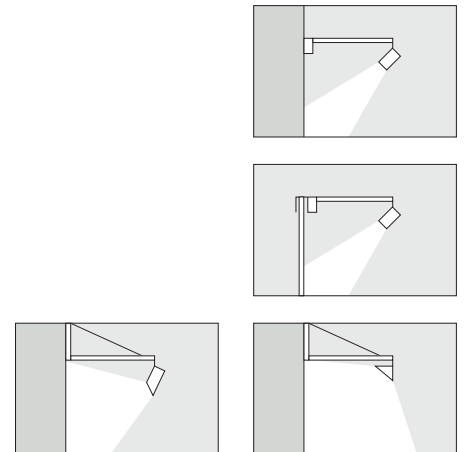

Cantilevers with integral transformer for low-voltage spotlights; wall-mounted (above) and mounted on a partition wall (centre). Cantilevers for the mounting of light structures and individual luminaires (below).

2.7.3 Light structures

Light structures are systems comprising modular elements that take integrated luminaires. Movable luminaires, e.g. spotlights, can be mounted and operated on light structures. They therefore allow a combination of stationary and movable luminaires.

Light structures can be formed of track, lattice beams, tubular profiles or panels. Their main feature is that they are modular systems, comprising standardised basic elements and a selection of connectors that allow the construction of a wide variety of structures – from linear arrangements to extensive grids. Light structures can therefore be incorporated into the surrounding architecture or themselves create architectural structures; they are designed to be highly functional lighting installations blending in harmoniously with their surroundings.

One sub-group of light structures are **carrier systems** with integral power supply. They are designed exclusively for the mounting and operation of movable luminaires. They can be track or tubular or panel systems with integral track.

Carrier systems can be mounted directly onto walls and ceilings, or suspended from the ceiling. Carrier systems with a high load-bearing capacity are also available as large-span structures.

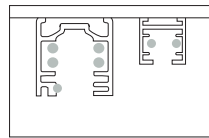

Three-circuit track for mains voltage and single-phase low-voltage track.

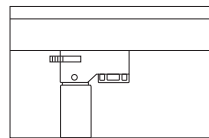

Adapter with phase selection switch for three-circuit track.

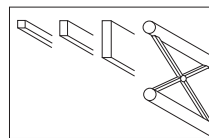

Different types of light structures: from track to large-span structures.

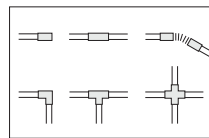

End cap, connector, flexible connector, L-connector, T-connector and X-connector for track.

Carrier system with downlight (top left), louvred luminaire (top right), ceiling washlights (bottom left) and uplight (bottom right).

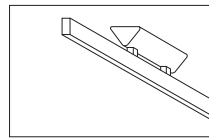
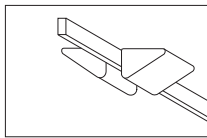
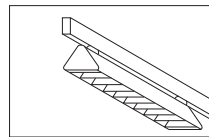
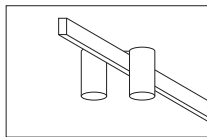

In the strict sense of the word **light structures** are characterised by the fact that they contain integral luminaires; if they also contain track or a series of connection points, they are also able to take movable luminaires, as required. They consist of tubular or panel elements and are usually suspended from the ceiling.

Light structures frequently consist of elements with integral louvred luminaires, which can be used for direct lighting and for indirect lighting by light reflected off the ceiling. For accent lighting elements with integral downlights or directional luminaires (frequently equipped with low-voltage lamps) can be used; decorative effects can be produced by elements with exposed incandescent or halogen lamps. Other elements can take information signs.

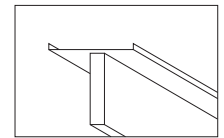
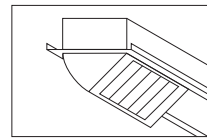
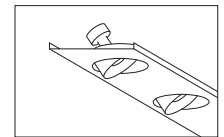
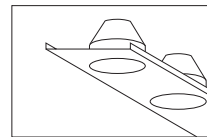
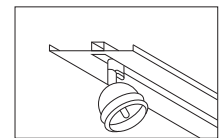
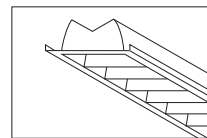
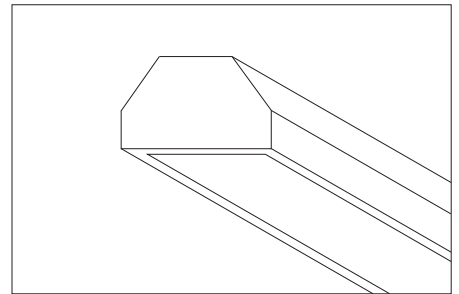

Light structure; empty profile with variety of attachments: louvred luminaires, downlights (also loudspeakers, connection points, etc., if required), wall-washers, track, directional spotlights and information signs.

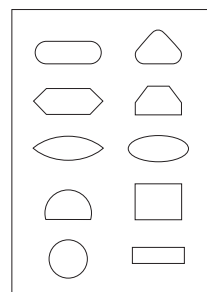

Cross sections of light structures showing a variety of profile designs.

2.7.4 Secondary reflector luminaires

The widespread use of personal computer workstations in modern-day office spaces has led to a greater demand for improved visual comfort, above all with regard to limiting direct glare and discomfort glare. Glare limitation can be provided through the use of VDT-approved luminaires, or through the application of indirect lighting installations.

Exclusively indirect lighting that provides illumination of the ceiling will avoid creating glare, but is otherwise ineffective and difficult to control; it can produce completely uniform, diffuse lighting throughout the space. To create differentiated lighting and provide a component of directed light, it is possible to combine direct and indirect lighting components in a two-component lighting system. This may consist of combining task lighting with ceiling washlighting, or the use of direct-indirect trunking systems.

The use of secondary reflectors, which is a relatively new development, makes for more comprehensive optical control. This means that the ceiling, which represents an area of uncontrolled reflectance, is replaced by a secondary reflector which is integrated into the luminaire and whose reflection properties and luminance can be predetermined. The combination of a primary and a secondary reflector system produces a particularly versatile luminaire, which is able to emit exclusively indirect light as well as direct and indirect light in a variety of ratios. This guarantees a high degree of visual comfort, even when extremely bright light sources such as halogen lamps or metal halide lamps are used, and while still being possible to produce differentiated lighting.

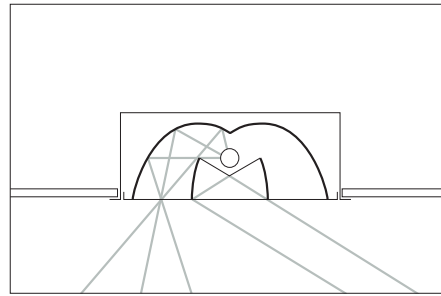

Secondary reflector luminaire with a parabolic reflector for the direct component and involute secondary reflector for the control of the indirect component.

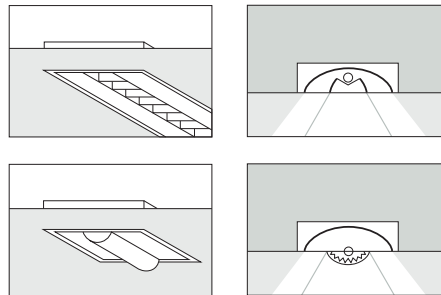

Secondary reflector luminaire; rectangular and square versions.

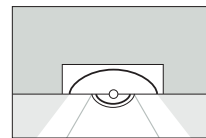

Direct-indirect and indirect secondary reflector luminaire.

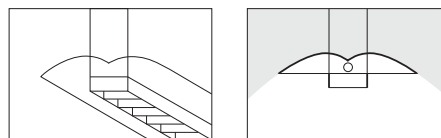

Pendant direct-indirect secondary reflector luminaire.

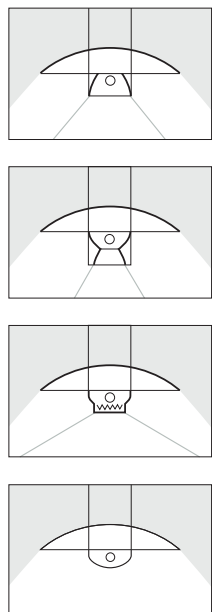

Rotationally symmetrical secondary reflector luminaire for point sources (e.g. high-pressure discharge lamps). Illustrated versions with parabolic reflector or lens system for the direct component, and a luminaire with a secondary reflector only.

2.7.5 Fibre optic systems

Light guides, or optical fibres, allow light to be transported at various lengths and around bends and curves. The actual light source may be located at a considerable distance from the light head. Optical fibres made of glass are now so well developed that adequate amounts of luminous flux can now be transmitted along the fibres for lighting applications.

Fibre optics are used above all in locations where conventional lamps cannot be installed due to size, for safety reasons or because maintenance costs would be exorbitant. The especially small-dimensioned fibre ends lend themselves perfectly to the application of miniaturised downlights or for decorative starry sky effects. In the case of showcase lighting, glass display cases can be illuminated from the plinth. Thermal load and the danger of damaging the exhibits are also considerably reduced due to the fact that the light source is installed outside the showcase.

In the case of architectural models several light heads can be taken from one strong central light source, allowing luminaires to be applied to scale.

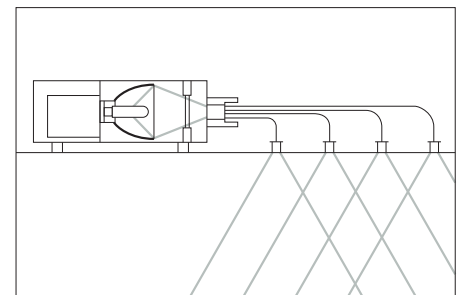

Fibre optic system comprising projector, flexible light guides and individual light heads for the ends of the fibres. Inside the projector the light emitted by a low-voltage halogen lamp is focussed onto the Common End of the bundle of fibres by means of an elliptical reflector. The light is then conveyed along the individual light guides, and emitted at the ends of the fibres through the attached light heads.

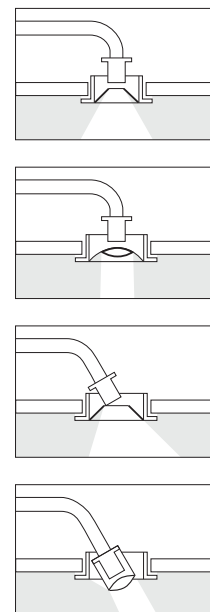

Typical light guide fixtures (from the top downwards): downlight with reflector, downlight with lens optics, directional spotlight with reflector, directional spotlight with lens optics.

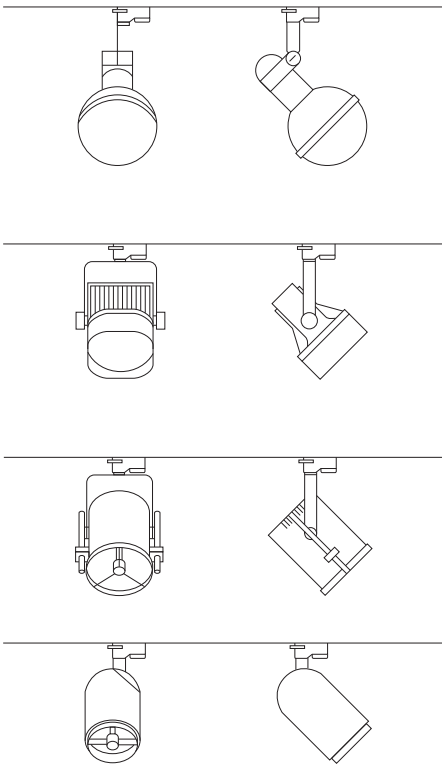

Spotlights of different designs and technical performance.

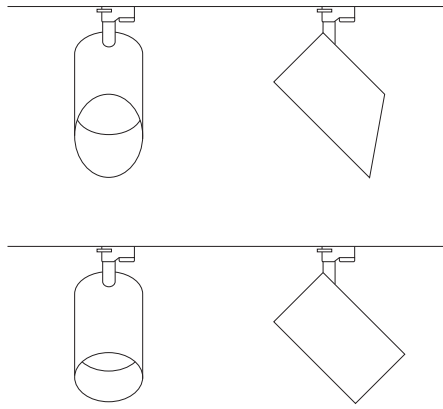

Spotlights and washlights whose design is based on fundamental geometrical forms.

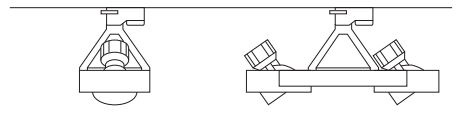
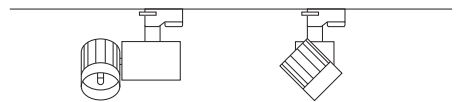
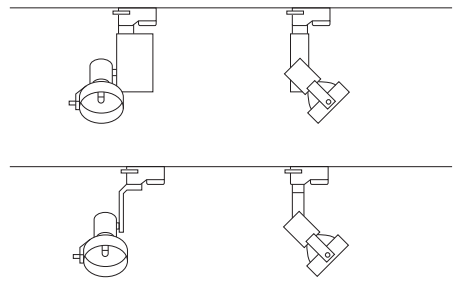
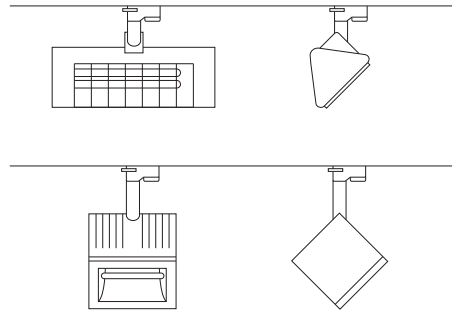

The development of low-voltage halogen lamps allows the design of luminaires of especially compact dimensions, in particular for spotlights for low-voltage track.

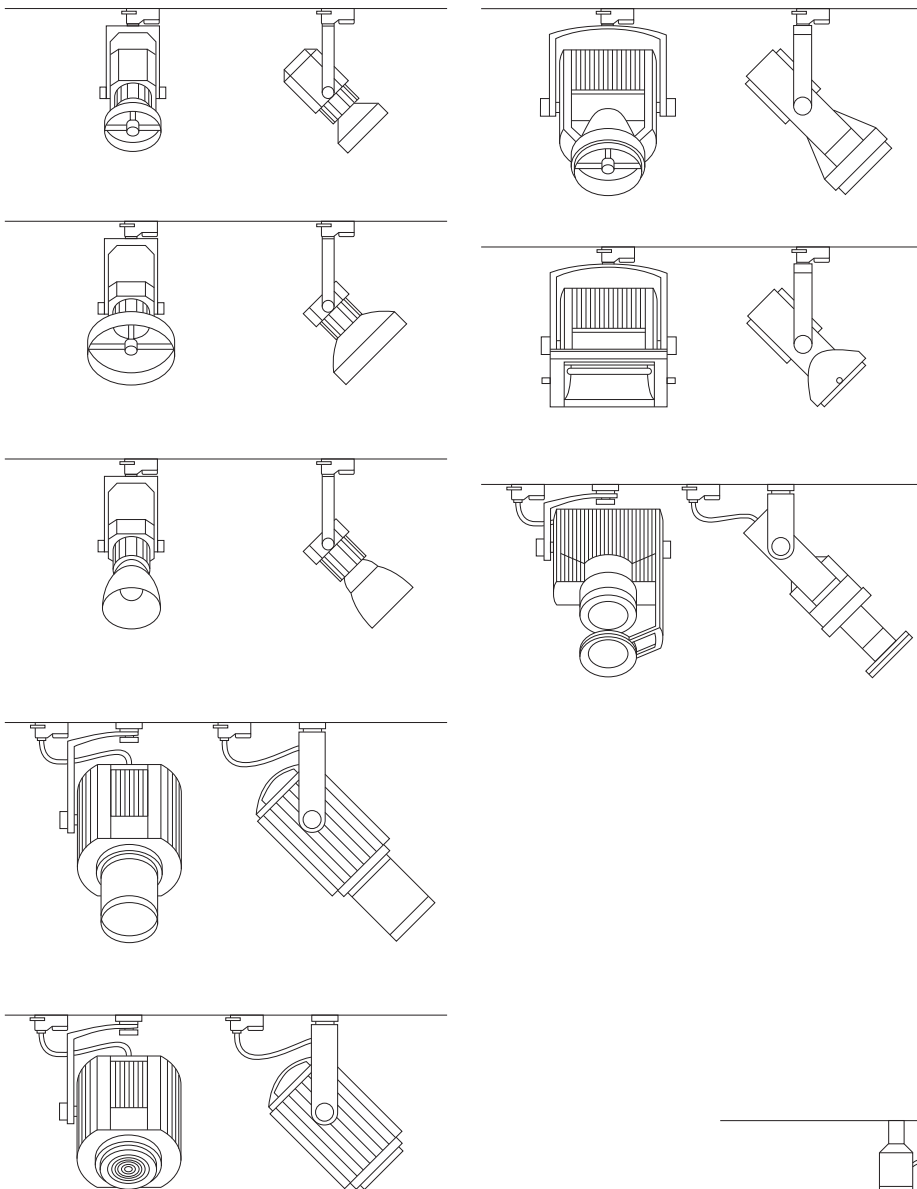

Within a uniform design concept the construction of luminaires for a variety of light sources and lighting tasks leads to a wide range of designs.

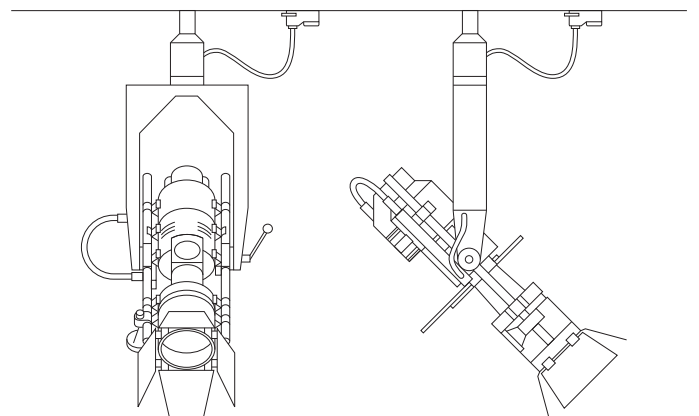

Stage projectors can be used for creating dramatic lighting effects, such as colour effects and projections in large spaces.

3.0

Lighting design

3.1

Lighting design concepts

3.1 Lighting design concepts 3.1.1 Quantitative lighting design

The scientific application of artificial lighting is a relatively young discipline. In contrast to daylighting, which looks back on a tradition that developed gradually over several thousand years, the need to develop concepts for artificial lighting only became a requirement in the last century or two. Just 200 years ago planning using artificial light sources was confined to deciding where best to position the few candles or oil lamps available. Not really what might be referred to as adequate lighting design. Only in the last one hundred years, with the rapid development of efficient light sources, has lighting design acquired the tools that allow artificial lighting to be produced with adequate illuminance levels. This development is accompanied, however, by the task of defining the objectives and methods behind this new discipline, of deciding on the criteria by which the artificial light that is now available is to be applied.

3.1.1 Quantitative lighting design

The first and to date most effective concept has given rise to a set of standards or criteria for the lighting of workplaces. While decisions with regard to lighting in the private sector can be limited to the choice of suitably attractive luminaires, there is a clear interest in the field of the lighting of workplaces to develop effective and efficient forms of lighting. The main concern is which illuminance levels and types of lighting will ensure optimum visual performance, high productivity and safety at operating costs which are affordable.

Both aspects of this task were examined in detail, i.e. both the physiological question of the correlation of visual performance and lighting, and the technical question of establishing criteria by which the quality of a lighting installation can be measured. The concept of quantitative lighting design with illuminance as the central criterion, followed by uniformity, luminous colour, shadow quality and the degree of glare limitation, developed at a relatively early stage. Taking such criteria as a basis, standards were compiled containing minimum illuminance levels on the relevant working area for a wide variety of activities, plus the minimum requirements for the other quality criteria.

In practice, this would appear to require uniform, mostly horizontally oriented lighting over the entire space, which could best be effected by a regular arrangement of luminaires, e.g. continuous rows of fluorescent linear luminaires or louvred downlights. The illuminance level in each case is designed – in accordance with the demand for uniform lighting – to meet the requirements of the most complicated visual tasks that can be expected in the given space. The inevitable result is that

Type of lighting	Area of activity	Guideline E (lx)
General lighting in short-stay spaces	Circulation routes	50
	Staircases and short-stay spaces	100
	Rooms not continually in use – lobbies, public circulation	200
General lighting in working spaces	Office with daylight-oriented workplace	300
	Meeting and conference rooms	300
	Office space, data processing	500
	Open-plan office, technical drawings and design office	750
	Complicated visual tasks, precision assembly, colour testing	1000
Additional lighting for very complicated visual tasks		2000

Guide values for illuminance E for various areas of activity in accordance with CIE recommendations.

3.1 Lighting design concepts

3.1.1 Quantitative lighting design

the overall lighting is far too bright for all the other activities which will occur in the area.

There is no doubt that quantitative lighting design concepts of this kind are successful within the framework of the task that has been set, as explained above. There is a proven correlation between the quality of the light and visual performance; this corresponds to the definable effect which the quality of the lighting has on efficiency and safety at the workplace.

It is therefore justified to maintain that the standard lighting conditions recommended for a technical office must be different from those for a warehouse. But when consideration is given to the lighting required for working areas with different or changing activities the limits of quantitative lighting design concepts soon become apparent. If the task is to light a drawing board and a CAD workstation, for example – nowadays a frequent constellation – it soon becomes clear that the high illuminance level required for the drawing board is disturbing to the person working at the computer, indeed that the vertical light component required for work at the drawing board may make it impossible to work at the computer.

More light is therefore not always necessarily better light. Similarly, it is impossible to put other lighting qualities into any kind of basic order of importance – the measures taken to limit direct glare may not work at all to limit reflected glare; the light required to be able to read small print might be unbearable for reading texts printed on glossy paper. The frequently encountered idea that an overall illuminance level of 2000 lux with optimum glare limitation and colour rendering will be the end of complaints from office staff, is based on what can only be described as inadmissible simplification. Optimum lighting of different workplaces cannot be effected by raising the overall "quantity" or brightness of the light, but only by orienting the planning towards the requirements of the individual areas, in other words, by relaxing the requirement for lighting to be uniform.

As can be readily appreciated, the limits of quantitative lighting design soon become apparent in the actual field of application it was intended for, the lighting of workplaces. Questionable though it is, this kind of lighting philosophy is widespread and is generally adopted as the standard for architectural lighting. On closer investigation it is apparent that quantitative lighting design is based on an extremely simplified perception model. Our entire environment is reduced to the term "visual task"; all architectural considerations, the information content and aesthetic quality of the visual environment are disregarded. The same applies to the definition of the perceiving person, who is

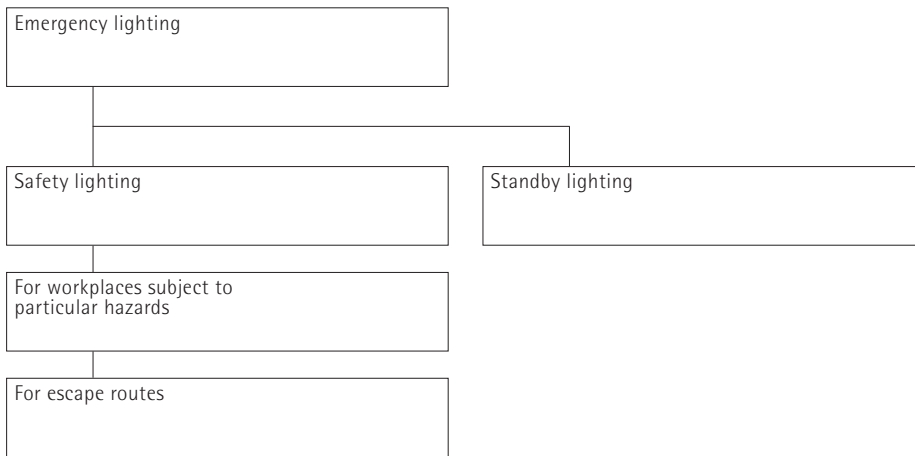

Safety lighting

Safety lighting allows people to leave rooms and buildings (safety lighting for escape routes), or to complete activities and leave rooms with workplaces that are exposed to hazards.

Regulations laid down in ASR 7/4 DIN 5035, Part 5, DIN 57108, VDE 0108.

Standby lighting

Standby lighting (usually 10% of the rated illuminance) takes over from the artificial lighting to maintain continued operation for a defined period of time, used to limit damage and loss of production, in particular.

Regulations laid down in DIN 5035, Part 5.

Safety lighting	Escape routes
Workplaces exposed to hazards	Escape routes
$E_{min} = 0.1 E_n$ at least 15 lx E_n acc. to DIN 5035, Part 2	$E_{min} \geq 1 \text{ lx}$ (0.2 m above floor level) $\frac{E_{min}}{E_{max}} \geq \frac{1}{40}$
$\Delta t \leq 0.5 \text{ s}$	$\Delta t \leq 15 \text{ s}$ (workplaces) $\Delta t \leq 1 \text{ s}$ (meeting places, business premises)
$\Delta t \geq 1 \text{ min}$, at least for the period people are subjected to danger	$t = 1 \text{ h}$ (workplaces) $t = 3 \text{ h}$ (meeting places, business premises)

Requirements to be met by safety lighting for escape routes: minimum illuminance E_{min} , uniformity E_{min}/E_{max} , change-over time Δt and operating time t .

Requirements to be met by safety lighting in workplaces exposed to hazards: minimum illuminance E_{min} , changeover time Δt and operating time t .

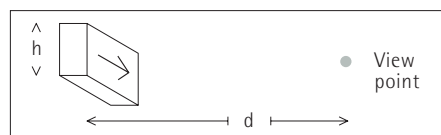

Min. height h of emergency exit signs in escape routes in accordance with maximum viewing distance d (acc. to DIN 4844).

Emergency exit sign, backlit

$$h = \frac{d}{200}$$

Illuminated emergency exit sign

$$h = \frac{d}{100}$$

effectively considered to be a walking camera – the only aspect that is taken into account is the physiology of our vision; the psychology of perception is disregarded altogether.

Design concepts based on these principles, which only serve to ensure safety and a sound working economy, and ignore any other requirements the perceiving person may have of his visual environment, can lead to problems at the workplace. Outside the working environment the user would inevitably find such lighting inadequate; the lighting solution will remain clearly inferior to the feasible possibilities.

3.1.2 Luminance-based design

A quantitative lighting design concept that is oriented primarily towards providing a recommended illuminance level, lacks the criteria to develop a concept that goes beyond the requirements that would ensure productivity and safety to meet the needs of the architecture and the persons using the architectural space.

In response to this problem a new kind of lighting philosophy is developed, as represented in Waldram's "designed appearance" and Bartenbach's "stable perception" models, for example. The aim of this approach is a process that not only provides adequate lighting for visual tasks but is also able to describe and plan the optical effect of an entire space.

To be able to plan the visual effect of an environment the central reference quantity has to be changed. Instead of illuminance, which describes only the technical performance of a lighting installation, it is luminance that becomes the basic criteria – a dimension that arises from the correlation of light and lit environment, thereby forming the basis for human perception. Changing the central quantity to luminance means that brightness and contrast ratios can be established for the entire perceived space, be it between visual task and background, between individual objects or between objects and their surroundings.

This change of criteria does not make much difference to the lighting of visual tasks at the workplace, since the effect of different contrast ratios on visual performance are known and have been taken into consideration according to the degree of difficulty defined for the specific visual tasks. This does not apply for the lighting effect in the entire space. Considering luminance levels in this way means that brightness ratios produced by a lighting installation in correlation with the architecture and the illuminated objects can be ascertained and lighting concepts developed based on the distribution of brightness.

Designing concepts based on luminance levels is therefore not so much a question

of simply changing reference criteria, but more of expanding the design analysis to the entire space. Whereas up to now an overall illuminance level was planned for the whole space based on the visual requirements for the most complicated visual task, the approach now is to plan luminance levels for all areas of a visual environment.

This means that it is now possible to differentiate between the various visual tasks performed in a space, to define room zones where the lighting is adjusted to the specific activities carried out in these areas. At this stage it is possible to refer to the standards and recommendations laid down for quantitative lighting design when planning the lighting for the individual visual tasks.

Design concepts based on luminance levels are, however, not confined to ascertaining spatial zones, which in turn would only lead to splitting a space up into a series of conventionally lit areas. The main feature of this kind of planning is that it is not directed towards the lighting for visual tasks, but towards the brightness ratio between the visual tasks and their respective surroundings, the balance of all luminances within one zone. This presumes that the lighting for one zone only allows optimum "stable" perception when the luminance contrasts do not exceed, or fall below, certain values. The aim is to create a constellation within which the visual task forms the brightest area in the environment, thereby holding the attention of the viewer. The luminance level of the surroundings should therefore be lower so as not to distract the person's view, but remain within a defined range of contrast. The permissible scale of contrasts is a result of the state of adaptation of the eye while perceiving the visual task – in a "stable" environment the eye retains a constant state of adaptation, whereas an "unstable" environment leads to continuous, tiring adaptation through too low or too high background luminances.

When planning a "stable" spatial situation with controlled luminance distribution it is no longer possible to base concepts on a standardised lighting installation. Just as luminance is a result of the correlation of the illuminance and reflectance of the surfaces, the lighting installation and the material qualities must be planned together when designing concepts based on luminance levels. The required luminance contrasts cannot only be achieved by varying the lighting, but also by determining surrounding colours. The most prominent example is the lighting for the Museum of Art in Berne, where the especially intense and bright appearance of the paintings on display is not achieved by increased illuminance levels, but through the grey colour of the walls. In this situation the paintings have a higher luminance than the relatively dark surrounding area, which makes their

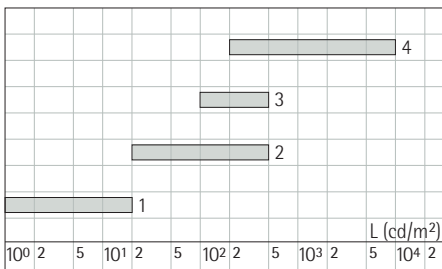

Ranges of typical luminances L in interior spaces: luminances outside working spaces (1), luminances of room surfaces (2), luminances of visual tasks at the workplace (3), tolerance luminances of luminaires (4).

3.1 Lighting design concepts

3.1.2 Luminance technology

colours appear particularly intense – similar to projected slides or lighting using framing projectors.

At first glance this appears to be a promising concept, which avoids the weak points of quantitative lighting design and provides criteria for a perception-oriented design theory. Considerable doubts have arisen from the perceptual psychology sector, however, as to whether luminance and luminance distribution are suitable criteria for a lighting design theory based on human perception.

Luminance is indeed superior to illuminance in as far as it forms the basis for perception – light itself is invisible. It can only be perceived when it is reflected by objects and surfaces. Luminance, however, is not identical to the brightness we actually perceive; the luminance pattern on the retina only provides the basis for our perception, which is completed through complex processes in the brain. This also applies to luminance scales that are adjusted to the state of adaptation of the eye or the conversion into equidistant grades of brightness – there is no direct correlation between the image actually perceived and the luminance pattern on the retina.

If luminance were the only factor that determined our perception, we would be helplessly exposed to an array of confusing patterns of brightness produced by the world around us. We would never be in a position to distinguish the colour and reflectance of an object from different lighting levels, or perceive three-dimensional forms. It is nevertheless exactly these factors of constancy, the forms and material qualities around us, that our perception is aimed at; changing luminance patterns only serve as an aid and a starting point, not as the ultimate objective of vision.

Simplified correlation between illuminance E, reflectance φ and luminance L in working places with visual task I, working surface A, ceiling D, wall W and partition walls S.

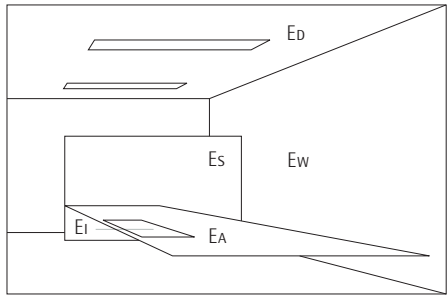

$E_I = 500 \text{ lx}$
 $E_A = 500 \text{ lx}$
 $E_D = 50 \text{ lx}$
 $E_W = 200 \text{ lx}$
 $E_S = 200 \text{ lx}$

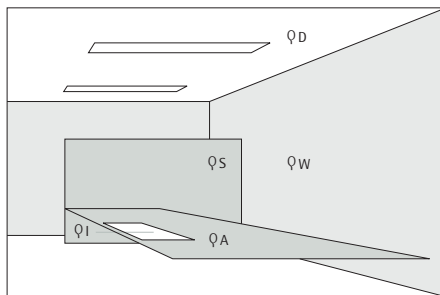

$\varphi_I = 0,7$
 $\varphi_A = 0,3$
 $\varphi_D = 0,7$
 $\varphi_W = 0,5$
 $\varphi_S = 0,3$

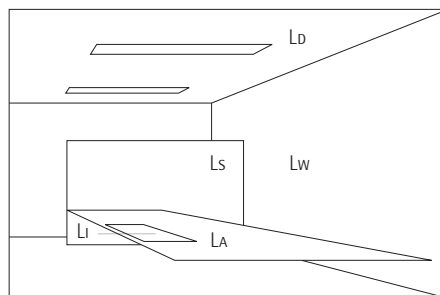

$L_I = 111 \text{ cd/m}^2$
 $L_A = 48 \text{ cd/m}^2$
 $L_D = 11 \text{ cd/m}^2$
 $L_W = 32 \text{ cd/m}^2$
 $L_S = 19 \text{ cd/m}^2$

Calculation of luminance L from the illuminance E and the reflectance φ . The formula only applies in the case of completely diffuse reflection, but generally produces good approximate values in practice.

$$L = \frac{E \cdot \varphi}{\pi}$$

Only with knowledge of the lighting conditions and with the aid of constancy phenomena can interpretations be made of the luminance pattern on the retina, and a familiar three-dimensional image arise from the mass of confusing parts. The brightness ratios that we actually perceive may deviate considerably from the underlying luminance pattern. In spite of its higher luminance a grey, overcast sky seen above a field of snow will appear to be darker than the snow. The decline in luminance over a wall surface lit from an angle is likewise ignored, whereas it has an increased effect on the sides of a cube. Colour ratios and grey values are thus corrected in differently lit areas, with the result that we perceive a consistent scale.

In every case, the registering of luminances is deferred in favour of the constant qualities of objects, which is inherent to our perception: the acquisition of information about a given environment clearly has higher priority than mere optical images. This central aspect of the way we process information cannot be taken into consideration by a theory of perception based on luminance, however. Similar to quantitative lighting design, luminance technology adheres to a purely physiological concept, which reduces the perceptual process to the creation of optical images in the eye, ignoring all other processes that take place beyond the retina. The information content of our perceived environment and the interest this environment awakens in the perceiving being cannot be explained by this model - but it is this very interplay of information and interests that allows the perceived image to be processed, the relativity of luminances to be apprehended and the luminance patterns in the eye to be reinforced or ignored.

If the aim of perception is to process information, and if it takes place depending on the information provided, it cannot under any circumstances be examined irrespective of the information content provided by or inherent in a specific environment. In the light of this fact, any attempt to define a set of general rules for lighting that are not based on a concrete situation is of doubtful validity. This also applies to the attempt to make an abstract definition of "stable" lighting situations, which is what luminance-based design strives to do.

A general definition of the conditions required for the development of psychological glare - the most extreme form of an "unstable", disturbing lighting situation - will fail due to the fact that the information content pertaining to the relevant glare sources is not available. It becomes apparent that glare does not only depend on stark luminance contrasts, but also on lack of information content with regard to the surface producing the glare. It is not the window with a view over the sun-

lit countryside that gives rise to glare, but - in spite of its lower luminance factor - the pane of opal glass that prevents this very view; a blue summer sky with a few clouds is not a source of glare, but the uniform grey-white sky of a dull day in November.

If it is not possible to find an abstract definition for an "unstable" milieu, the attempt to describe ideal luminance patterns out of context is unsound. Maximum luminance contrast values of 1:3 or 1:10 between the object of attention and the proximate or broader ambient field have been laid down that confine the lighting designer's range of expression to a dull average. Phenomena such as brilliance and accentuated modelling, which play a considerable role in imparting information about materials in our environment, are practically excluded; luminance situations such as we experience on any sunny day or on a walk in the snow, are considered to be unreasonable. But you can only decide whether a lighting situation is pleasing or unreasonable when you experience a specific situation; luminance contrasts on the beach are not too stark for someone taking a stroll, but they will bother someone who is trying to read a book.

Just as the brightness we actually perceive cannot be derived from luminance, it is impossible to conclude the exact lighting conditions which are necessary to ensure good perception simply by examining the contrast range of a lit environment; the lighting designer is obliged to examine each specific situation, the information it provides and the perceptual requirements of the users of the space.

The difficult aspect to evaluating the quality of lighting concepts is the exceptionally vast adaptability of the human eye: a perceptual apparatus that is able to provide usable results at 0.1 lux on a clear night or 100 000 lux on a sunny day, is not substantially disturbed in its performance by luminance contrasts of 1:100, and is entirely capable of balancing the effects of inadequate lighting design. It is therefore not surprising that lighting installations that do not take into account the essential requirements of the perceiving person generally meet with acceptance. Dissatisfaction with the lighting at a workplace, for example, is frequently not recognised by the person concerned as a result of poor lighting design - criticism is usually aimed in the direction of the innocent "neon lamp".

Progress made in the field of lighting design can therefore not be evaluated by simply differentiating between inadequate and optimum, or clearly correct or incorrect lighting solutions. In the case of the lighting of workplaces a quantitative design concept may prove to be clearly successful, even when the lighting is exclusively adjusted to optimising visual

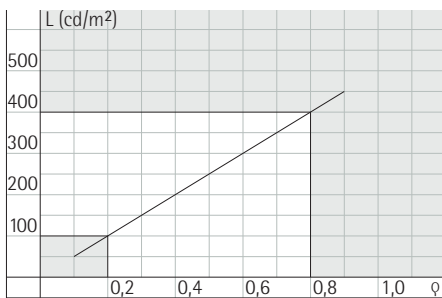

Preferred luminance L for visual tasks as a function of reflectance ρ of the visual task. The luminances preferred in the experiment are in proportion to the reflectance factor; they result when the illuminance level remains constant. Consequently, in the case of the perception of visual tasks, in comparison to luminance, illuminance is a prime criterion.

performance. Luminance technology can also be regarded as a step in the right direction; the expansion of the design analysis from the visual task to the entire space and the development of zone-oriented lighting design all make for progress, and in turn have a positive effect on the quality of the lighting.

Even if lighting solutions can be achieved using quantitative processes that are acceptable within the broad spectrum of visual adaptability, it does not mean to say that lighting has been designed that will comply with all essential perceptual requirements. Both quantitative lighting design and luminance technology remain at the level of purely physiologically oriented design, which does not provide any reliable criteria apart from the isolated consideration of visual tasks. Luminance technology is equally not able to keep both promises – the designer's prediction of what the visual effect will be and the creation of (perceptually speaking) optimum, "stable" lighting situations; it is therefore not realistic to lay down a set of abstract criteria for brightness distribution that do not relate to a specific situation.

3.1.3 The principles of perception-oriented lighting design

The main reason for our dissatisfaction with lighting concepts based on quantitative lighting design or luminance technology is the fact that they adhere strictly to a physiologically oriented view of human perception. Man is only seen as a mobile being for processing images; his visual environment is reduced to the mere "visual task", at the best to an overall perceptual understanding of "table" and "wall", "window" and "ceiling". Seen from this angle, it is only possible to analyse a minor portion of the complex perceptual process, which comprises the eye and an abstract comprehension of the world around us; no attention is paid to the person behind the eye and the significance of the perceived objects.

Only when we begin to go beyond the physiology of the eye and take a closer look at the psychology of perception can the conditions required for the processing of visual information be fully understood and all the factors involved in the correlation between the perceiving being, the perceived objects and light as a medium for allowing perception to take place be taken into account. In a concept that understands perception as more than a process for handling information, the visual environment is more than just a configuration of optically effective surfaces. In this way both information content and the structures and aesthetic qualities of a piece of architecture can be analysed adequately. Man is no longer seen as merely recording his visual environment, but

as an active factor in the perceptual process – an acting subject, who can construct an image of a visual environment based on a wide variety of expectations and needs.

Only when two main factors are correlated – the structural information provided by a visual environment and the needs of a human being in the given situation – does the so-called pattern of significance of a space develop. Only then is it possible to analyse the ranking of importance which relate to individual areas and functions. On the basis of this pattern of significance it is possible to plan the lighting as the third variable factor in the visual process and to design it accordingly. The need for orientation aids varies radically depending on the type of environment – light applied for guiding people through spaces can be of prime importance in a congress centre with constantly changing groups of visitors, whereas this task is considerably less important in familiar environments. The decision whether to graze the surface structure of a wall with light depends on whether this structure presents essential information, e.g. about its character as a mediaeval stone wall or whether such lighting will only reveal the poor quality of the plaster work.

Perception-oriented lighting design, which is directed at the human being and his needs, can no longer be directed in primarily *quantitative* terms relating to illuminance and the distribution of luminance. To achieve lighting that is suitable for a given situation it is necessary to develop a set of *qualitative* criteria, an entire vocabulary of terms, which can describe the requirements a lighting installation has to meet and comprise the functions of the light with which these requirements can be fulfilled.

3.1.3.1 Richard Kelly

A significant part of this task – a basic description of the various functions of light as a medium for imparting information – was developed in the fifties by Richard Kelly, a pioneer of qualitative lighting design.

Kelly describes the first and basic form of light as *ambient light*. This is the light that provides general illumination of our environment. It guarantees that the surrounding space, plus the objects and persons in it, are visible. This form of overall, uniform lighting ensures that we can orient ourselves and carry out general tasks. It is covered to a large extent by the ideas underlying quantitative lighting design, except that ambient light in the Kelly sense is not the aim of a lighting concept, but only a basis for further planning. The aim is not to produce overall lighting of supposedly optimum illuminance, but differentiated lighting that can be developed taking ambient light as the basic level of lighting.

To achieve differentiation, a second form of lighting is required that Kelly refers to as *focal glow*. This is the first instance where light becomes an active participant in conveying information. One important aspect that is taken into account here is the fact that our attention is automatically drawn towards brightly lit areas. It is therefore possible to arrange the mass of information contained in an environment via the appropriate distribution of brightness – areas containing essential information can be emphasized by accent lighting, information of secondary importance or disturbing information toned down by applying lower lighting levels. This facilitates the fast and accurate flow of information, the visual environment, with its inherent structures and the significance of the objects it contains, is easily recognised. This also applies to orientation within the space – e.g. the ability to distinguish quickly between a main entrance and a side entrance – and for the accentuation of objects, as we find in product displays or the emphasizing of the most valuable sculpture in a collection.

The third form of light, *play of brilliance* is a result of the realization that light not only draws our attention to information, but that it can represent information in itself. This applies above all to specular effects, such as those produced by point light sources on reflective or refractive materials; the light source itself can also be considered to be brilliant. This “play of brilliance” can lend prestigious spaces in particular life and atmosphere. The effect produced traditionally by chandeliers and candlelight can be achieved in modern-day lighting design through the purposeful application of light sculptures or the creation of brilliance from illuminated materials.



Richard Kelly, one of the pioneers of modern lighting design. In projects designed by leading architects, e.g. Mies van der Rohe, Louis Kahn or Philip Johnson, he developed the basic principles of differentiated lighting design, influenced by stage lighting.

3.1.3.2 William Lam

With his differentiation between the basic functions of light Kelly made a substantial contribution towards the theory behind qualitative lighting design. He provides a systematic presentation of the means available. The question that still remains open is: according to what criteria are these means to be applied? The lighting designer is obliged to continue to depend on his own instinct, experience and the inadequate support provided by the quantitative criteria laid down in the standards when it comes to analysing the particular lighting context – determining the special features of the space, how it is utilized and the requirements of the users.

Two decades pass, however, before William M. C. Lam compiles the missing catalogue of criteria: systematic, context-related vocabulary for describing the requirements a lighting installation has to meet. Lam, one of the most dedicated advocates of qualitative lighting design, distinguishes between two main groups of criteria.

He first describes the group of *activity needs*: the needs for information related to specific conscious activities. To understand these needs it is essential to know the characteristics of the various visual tasks to be performed; analysing activity needs is therefore in line with the criteria laid down for quantitative lighting. As far as the aims of lighting design are concerned, there is general agreement on this point; the aim is to design functional lighting that will provide optimum visual conditions for the specific task – be it work, movement through a space, or leisure activities.

In contrast to the advocates of quantitative lighting design Lam objects strongly to uniform lighting aligned to the respective most difficult visual task; he proposes a far more differentiated analysis of all the activities that will take place according to location, type and frequency.

Even more important than this new evaluation of a group of criteria that already existed, is what Lam calls his second complex, which comprises *biological needs*. In contrast to activity needs, which are derived from man's occupations with specific tasks, biological needs covers the psychological need for information, the more fundamental aspects of the human relation to the visual environment. Whereas activity needs arise from specific conscious activities and are aimed at the functional aspects of a visual environment, biological needs comprise mainly unconscious needs, which allow us to evaluate a situation from an emotional point of view. They are concerned with our feeling of wellbeing in a visual environment.

In his definition of biological needs Lam presumes that our attention is only dedicated to one visual task in moments of greatest concentration. Man's visual attention is almost always extended to observe his entire surroundings. Any changes are perceived immediately, behaviour can be adjusted without delay to adapt to the changed situation.

The emotional evaluation of a visual environment does not only depend on whether it provides the required information in a clear fashion or whether it withholds it from the observer – the feeling of unease that arises in confusing situations. We have all experienced the feeling of being disoriented in the mass of visual information at an airport or when looking for a specific office in a local authority building.

For Lam the first of the basic psychological needs for environmental information is the need for orientation. Orientation can be understood in this case first in a spatial sense. It refers to how well destinations and routes can be identified: the spatial location of entrances, exits and what the environment specifically offers. This may be a reception, a special office or the individual departments of a department store. But orientation also comprises information about further aspects of the environment, e.g. the time of day, the weather or what is happening around us. If this information is missing, as may be the case in closed spaces in department stores or in the corridors of large buildings, for example, we feel the environment to be unnatural and even threatening; only when we have left the building can we suddenly make up for the information deficit – we establish that it has become dark and started to rain, for example.

A second group of psychological needs is targeted at how well we can comprehend surrounding structures. It is important that all areas of the spaces are sufficiently visible. This is a decisive factor in our feeling of security in a visual environment. If there are niches and corridors we cannot see into or parts of a space are poorly lit, we feel uncomfortable and unsafe. Dark corners, e.g. in subways or dark corridors in hotels at night, may contain danger, in the same way as overlit areas.

Comprehension of our surroundings does not mean that absolutely everything has to be visible, it comprises an element of structuring, the need for a clearly structured environment. We feel that a situation is positive when the form and structure of the surrounding architecture is clearly recognizable, and when important areas are designed to stand out against the given background. Instead of a confusing and possibly inconsistent flow of information the space thus presents itself as a clearly structured whole.



William Lam, lighting designer and dedicated theoretician of qualitative lighting design.

When accentuating specific areas it is not only visual tasks that traditionally receive attention that should be underlined. A view outside or the presence of other points of interest, e.g. a work of art, can be equally effective.

architecture: in the form of a light structure, an alignment of spotlights or a light sculpture, the lighting installation itself can become an architectural element that can purposefully change the appearance of the space.

A third area consists of the balance between man's need for communication and his right to clearly defined private spaces. Both extremes, complete isolation and complete public exposure, are felt to be negative; a space should promote contact to other persons, while at the same time allowing private spaces to be defined. A private space can be created by defining an area with light: a seated area or a conference table within a large room, for example, and making it stand out from its surroundings.

3.1.3.3 Architecture and atmosphere

Both main groups of William Lam's criteria describe man's needs, his needs for a functional and perceptually sound environment. Besides this analysis, which is based on the needs of man as a perceiving being, it must not be forgotten that light and luminaires also make a substantial contribution towards the aesthetic effect of architectural design. When Le Corbusier describes architecture as "the correct and magnificent play of masses brought together in light", he underlines the significance of lighting on the design of buildings.

Lam's demand for a clearly structured visual environment comes very close to fulfilling this task, but does not cover all aspects. It is certainly possible to structure a space according to the psychological needs of the users by applying different forms of lighting. Any decision to go for one of these approaches implies a decision to create a different aesthetic effect, a different atmosphere in the space. Apart from merely considering the needs of the perceiving being it is also necessary to plan the interplay of light and architecture.

As with user-oriented lighting design, light also has a supporting function in architecture. It is a tool for rendering the given architectural structures visible, and contributes towards their planned effect. Lighting can go beyond this subordinate role and itself become an active component in the design of the space. This applies in the first place for light that is not only able to render architecture visible, but also to enhance the intended appearance. This applies primarily to luminaires and their arrangement. Luminaires can be discreetly integrated into the architecture – e.g. via recessed mounting in the ceiling. The fixture itself is not visible, it is only the light that has effect. But luminaires can also be added to

Qualitative lighting design

Light plays a central and manifold role in the design of a visual environment. Work and movement are only possible when we have light to see by; architecture, people and objects are only visible if there is light. Apart from simply making our surroundings visible light determines the way we perceive an environment, influences the way we feel and the aesthetic effect and atmosphere in a space. You only have to enter a Baroque church with its bright and inspiring atmosphere to see and feel what effects light can have in architecture, or, to the other extreme, look at Piranesi's paintings of dungeons with their dark labyrinths, where the shadows conceal a never-ending source of horror.

Due to the adaptability of the eye elementary perception can take place at minimum lighting levels or under difficult visual conditions, while for optimum conditions at the workplace and for a piece of architecture to be accepted and found to be aesthetically pleasing it is necessary to create lighting whose qualities, illuminance and luminance distribution are in harmony with the particular situation.

One of the most frequent sources of error in lighting design is to separate light from its complex associations with human psychology and human activities as well as with the surrounding architecture. Simplified, unilateral lighting design can provide easily comprehensible concepts, but often leads to unsatisfactory results by overlooking essential aspects. This applies to both purely quantitative lighting design, which might produce optimum working conditions but forgets the perceiving being, and to primarily design-oriented lighting, which furnishes spaces with stylish luminaires without regard for the lighting effects these fixtures produce.

What is really required is lighting design that meets all the lighting requirements – design concepts that form an integral part of the overall architectural design and produce a visual environment that supports various activities, promotes a feeling of well-being and is in line with the architectural design. The quantitative design approach with its scientifically sound calculations and processes is actually a great help here; when designing lighting for workplaces this planning process itself may even become the primary objective. The main criterion for lighting design is never a figure displayed on measuring equipment, but the human being – the deciding factor is not the quantity of light, but the quality, the way a lighting scheme meets the visual needs of the perceiving person.

3.2.1 Project analysis

The basis for every lighting design concept is an analysis of the project; the tasks the lighting is expected to fulfil, the conditions and special features. A quantitative design concept can follow the standards laid down for a specific task to a large extent. Standards dictate the illuminance level, the degree of glare limitation, the luminous colour and colour rendering. When it comes to qualitative planning, it is necessary to gain as much information as possible about the environment that is to be illuminated, how it is used, who will use it, and the style of the architecture.

3.2.1.1 Utilisation of space

A central aspect of project analysis is the question of how the spaces that are to be illuminated are used; it is important to establish what activity or activities take place in the environment, how often and how important they are, if they are associated with specific parts of the space or specific periods of time.

This will first give rise to a series of global answers that outline the lighting task, will frequently also indicate standard stipulations, and form a framework for the lighting design concept. This comprehensive analysis of the task – e.g. the lighting of a sales space, an exhibition, an office space or the wide range of functions related to a hotel – gives rise to a series of individual visual tasks, the characteristics of which must in turn also be analysed.

Two criteria relating to a visual task are the size and contrast of the details that have to be recorded or handled; there then follows the question of whether colour or surface structure of the visual task are significant, whether movement and spatial arrangement have to be recognized or whether reflected glare is likely to be problem. The position of the visual task within the space and the predominant direction of view may also become central issues – visibility and glare limitation have to be handled differently in different environments. In a gymnasium, for example, the direction of view of people playing volleyball is upwards, or in an art gallery on the vertical, or for visual tasks in offices on the horizontal.

Apart from the qualities of the illuminated objects the visual performance of the user must also be taken into account, especially in the case of older people – the eye becomes less efficient with age, and older people are more sensitive to glare. In individual cases, the lighting of old people's homes in particular, special attention must be paid to these increased demands on illuminance and glare limitation.

Three-circuit track for mains voltage: luminaires for mains voltage and low-voltage fixtures with an integral transformer can be operated on track; three separate groups of luminaires can be switched or dimmed.

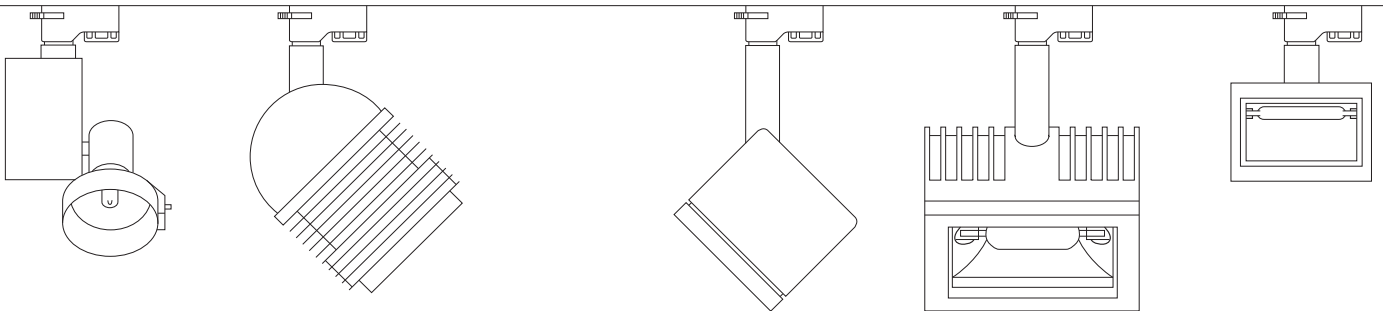

Spotlights for low-voltage halogen lamps with adjustable light heads on an electronic transformer. Compact electronic transformers allow the design of especially small luminaires.

Spotlights for low-voltage halogen lamps with integral electronic transformer.

Washlights for double-ended halogen lamps, washlight for metal halide lamps with integral control gear, wall-washer for double-ended halogen lamps.

Low-voltage track:
low-voltage spotlights
without transformers
can be operated on the
track. Power supply is
effected via an external
transformer.

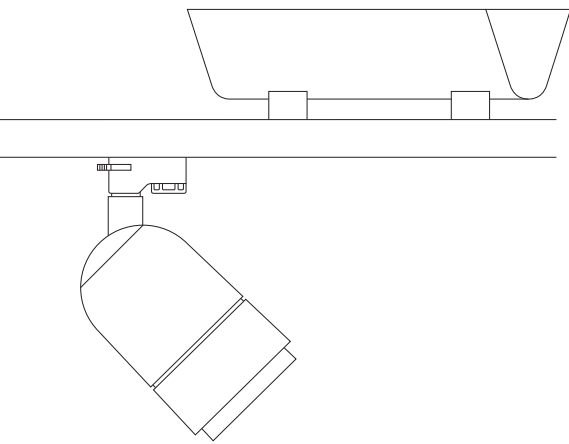

Spotlight for low-voltage halogen lamps with integral, conventional transformer.

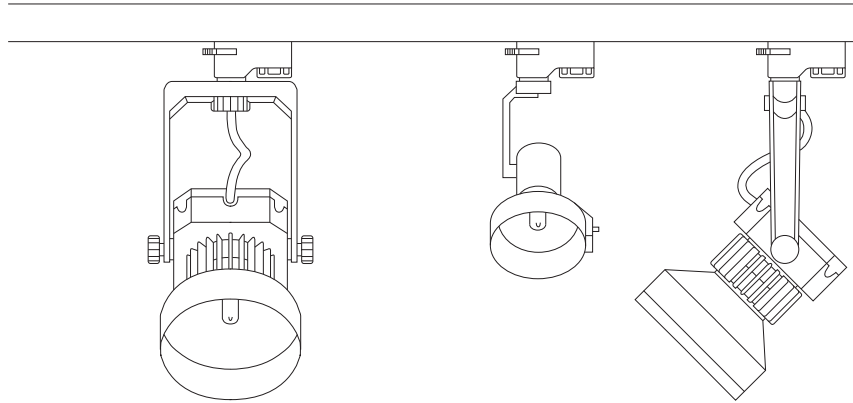

Uplighter for compact fluorescent lamps or halogen lamps.

Spotlight for low-voltage halogen lamps. The extremely small dimensions of the lamp and the use of an external transformer allow the design of compact spotlights. Larger reflectors make for enhanced optical control and increased luminous intensity.

3.2.1.2 Psychological requirements

Besides the objective requirements which result from the activities performed in a visual environment, attention must also be paid to the demands that stem from the users themselves. Many of these are concerned with the possibility of gaining better views of their surroundings. This applies to the need for information about time of day and weather, about what is going on in the rest of the building, and sometimes also the need for orientation within the environment. One special case is the utilisation of sunlight in atriums or through skylights and light wells. The latter do not necessarily offer a view outside but do provide information about the weather and the progress of time is maintained – a changing patch of sunlight can contribute to the feeling of life inside a building.

Apart from the need for daylight and views outside, which depends on the individual project to a large extent, there is a changing need for orientation aids. In extensive buildings, where there are continually different groups of users, the need for optical systems that guide people through spaces becomes a central issue. In some cases it is only necessary to underline a number of focal locations. In buildings with simple spatial structures that are constantly in use the need for orientation aids is of secondary importance. It is therefore essential to find out how important the need for orientation is in each specific case and which routes and areas demand special attention.

Another psychological need that has to be fulfilled is the creation of a clearly structured environment. This is especially important in areas that are potentially subjected to danger, i.e. where the structure of the space must be easily legible. In general, it can be said that a clearly structured environment contributes to our feeling of well-being in a visual environment. In reality this means accentuating the structure of the space, the materials applied and the most significant parts of the space, and above all the type and arrangement of the room limits that are to be illuminated and the information signs that are to be emphasized.

The last factor is the need for defined spatial zones; the expectation that you can recognize and distinguish between areas with different functions from the lighting they receive. This mainly concerns the lighting of functional areas that we accept as typical and which is in line with previous experience, e.g. the application of higher colour temperatures and uniform, diffuse lighting in working spaces, but warmer, directed light in prestigious spaces. The need for clearly defined private areas also falls in this category; lighting can be applied especially effectively in the conversation areas or waiting zones within larger spaces to create a feeling of privacy.

3.2.1.3 Architecture and atmosphere

Besides the requirements that arise from how a space is used and the needs of the users, lighting design also has to address the requirements of architecture and atmosphere. In the first place the architectural building is regarded as an object of lighting – it is to be rendered visible, its qualities accentuated, its atmosphere underlined, and if necessary its effect modified. Furthermore, the architectural concept also defines the basic conditions for the design of user-oriented lighting.

Detailed information about the architecture is of particular importance for the design of demanding lighting. This primarily concerns the overall architectural concept – the atmosphere the building creates, the intended effect indoors and out by day and night, the utilization of daylight, and the question of budget and the permissible energy consumption.

Along with this basic information about the project, the structures and qualities of the building itself are important. Quantitative lighting design also requires information about the dimensions of the spaces to be lit, the type of ceiling and the reflectance of the room surfaces. Other factors to be taken into consideration are the materials applied, colour scheme and planned furnishings.

As in the case of a clearly structured environment, architectural lighting is concerned with lighting that underlines the structures and characteristic features of the building, not only from the point of view of optimised perception, but involving the aesthetic effect of the illuminated space. The special features and main characteristics of an environment also present an important issue, above all the question of the formal language of the building – the design of the spaces and how they are subdivided, what modules and rhythms they contain, and how light and luminaires are to be aligned to underline these aspects.

3.2.2 Project development

The result of the project analysis is a series of lighting tasks that are allocated to specific areas within the space or specific times of day, all of which form a characteristic matrix of requirements for a visual environment. The next phase following the project analysis is the development of a qualitative concept that outlines an idea of the qualities the lighting should possess, without giving exact information as to the choice of lamps and luminaires or how they are to be arranged.

The first task concept development has to deal with is the allocation of specific lighting qualities to the lighting tasks defined as a result of the project analysis; to define the lighting conditions that are to be achieved in specific locations at specific times. To begin with, this concerns the quantity and the various other criteria of the light in the individual areas, plus the order of importance of these individual aspects within the overall lighting concept.

The pattern of requirements acquired in the course of the project analysis thus gives rise to a pattern of lighting qualities, which in turn provides information about the various forms of lighting and the required spatial and temporal differentiation. This is the first indication of whether the lighting is to be uniform or differentiated to match different areas, whether the lighting installation is to be fixed or flexible and whether it is a good idea to include lighting control equipment for time-related or user-related lighting control.

The allocation of lighting qualities to the individual lighting tasks in a project gives rise to a catalogue of design objectives, which takes into account the different requirements the lighting has to fulfil, without consideration for the conditions required to realise the lighting scheme or instructions on how to effect a consistent lighting design concept.

A practice-oriented design concept must therefore first describe how the desired lighting effects can be realised within the basic conditions and restrictions inherent to the project. The design concept may be required to correspond to specific standards, and it must keep within the budget with regard to both the investment costs and the operating costs. The lighting concept must also be coordinated with other engineering work to be effected on the project, i.e. air-conditioning and acoustics, and, of course, harmonize with the architecture. It is important to clarify the significance of individual aspects of the lighting for the overall concept; whether one particular form of lighting can justify preferential treatment, e.g. the demand for adequate room height in the case of an indirect lighting installation, whether the lighting

design must submit to acoustic engineering requirements or whether integral solutions, e.g. a combination of lighting and an air-handling system, are possible.

The real challenge behind qualitative lighting design lies in the development of a concept that is able to fulfil a wide range of requirements by means of a lighting installation that is both technically and aesthetically consistent. In contrast to quantitative concepts, which derive one general set of lighting qualities from the given profile of requirements for a project, which almost inevitably leads to a uniform and thereby standard design using light and luminaires, qualitative lighting design must come to terms with complex patterns of required lighting qualities. This cannot mean, however, that the designer responds to an unstructured set of lighting requirements with an equally unstructured variety of luminaires. The well-meant consideration of a wide range of lighting tasks frequently leads to an unsystematic distribution of a wide variety of luminaire types or to a conglomeration of several lighting systems. Such a solution may provide an adequate distribution of lighting qualities, but the value of such costly installations from the point of view of perceptual psychology and aesthetics is questionable owing to the lack of harmony on the ceiling.

From a technical, economic and design point of view the aim of lighting design should be to find a solution that does not go for the overall uniform lighting effect and equally not for a confusing and distracting muddle of lighting fixtures designed to cover a wide variety of lighting requirements, but a concept that produces a clearly structured distribution of lighting qualities by means of a consistent lighting scheme. The degree of complexity that has to be accepted depends on the specific lighting task. It may be that the main requirements set by the lighting task allow general lighting throughout the space, or that differentiated lighting can be achieved using integral systems such as light structures or the comprehensive range of recessed ceiling luminaires. Or in a multifunctional space that a combination of different luminaire systems may be necessary. Nevertheless, the most convincing solution is a concept that achieves the required result with the least amount of technical equipment and the highest degree of design clarity.

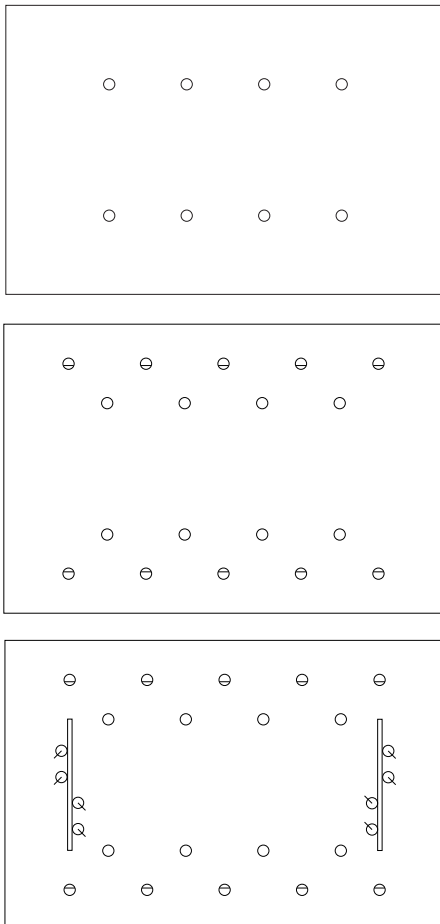

Example of the development of a differentiated lighting concept (from the top downwards): general lighting provided by downlights in accordance with the identified visual tasks, supplemented by wall-washers for the architectural lighting and track-mounted spots for the accentuation of special features.

Lighting for the restaurant beneath the dome of the atrium. Wall-mounted luminaires (1) provide both indirect lighting of the dome and direct lighting of the restaurant.

Pendant luminaires (2) with a decorative component continue the direct lighting in the restaurant inside the actual space.

Lighting of the cafeteria. A ceiling-mounted luminaire (3) provides uniform lighting over this level.

The lighting components for the general lighting in the atrium (4) are mounted on pillars on the walls of the atrium. They radiate light upwards. The light is then reflected by ceiling reflectors or by the atrium ceiling, thereby providing indirect lighting. The pillars are simultaneously accentuated by grazing light directed downwards.

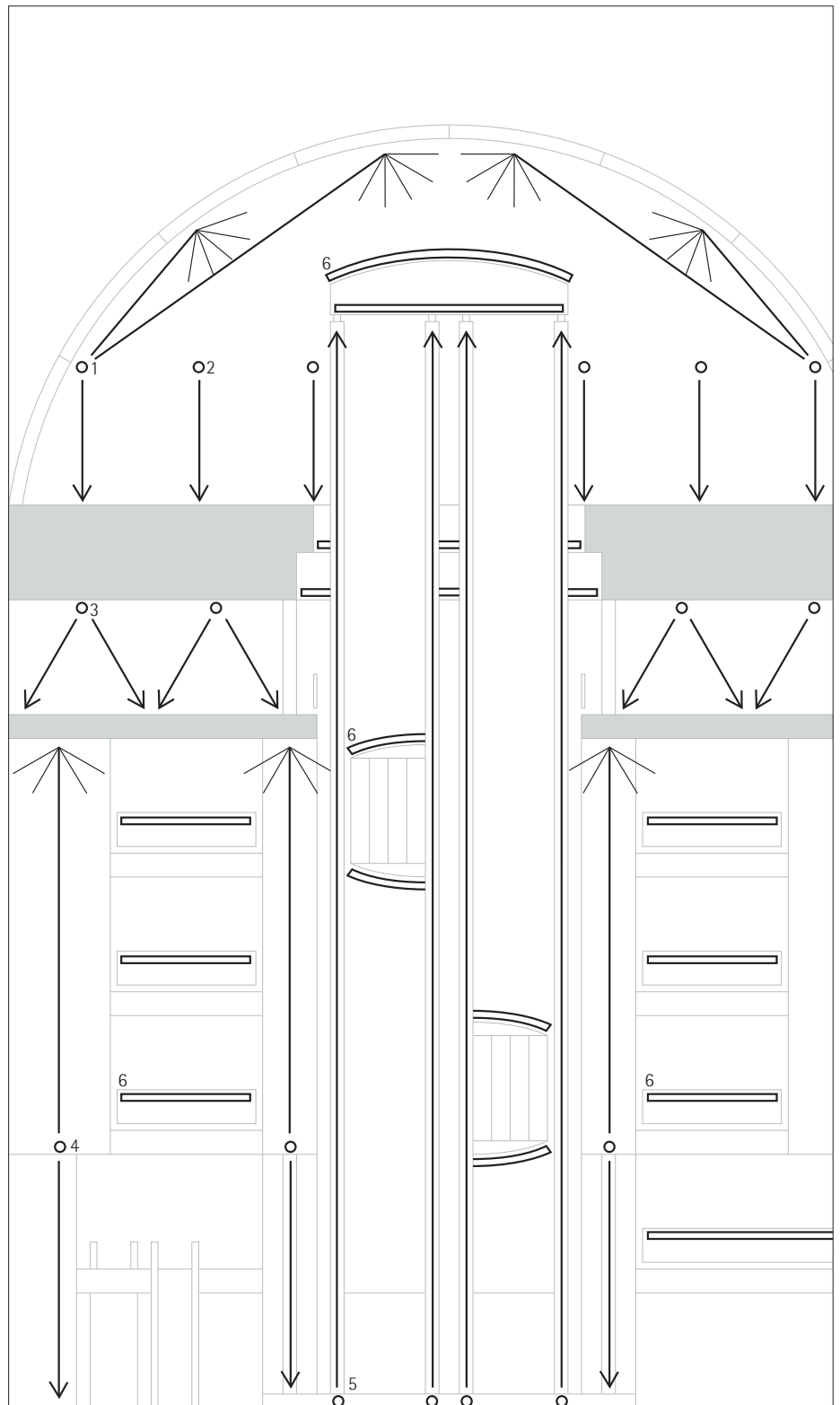

The free-standing panoramic lift is accentuated by grazing light from below (5).

Individual architectural elements, e.g. the balastrades of the adjoining sales floors, the lift car, the upper wall of the lift shaft and the opening of the atrium are accentuated by a decorative, linear lighting components (6).

3.2 Qualitative lighting design
3.2.1 Project development

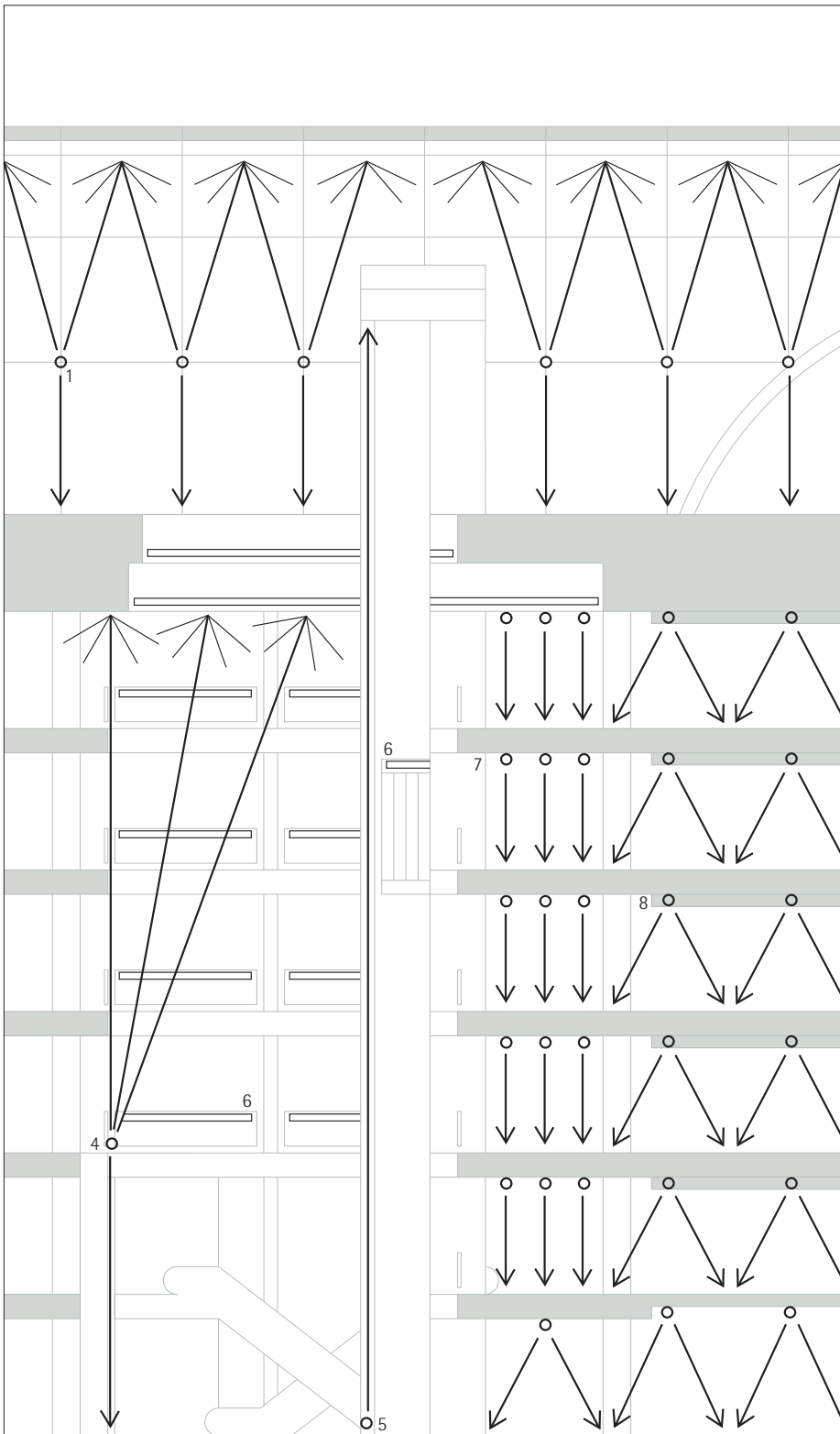

Development of a lighting concept for the atrium of a large department store. The representations show two vertical sections set at right angles to each other through the atrium with a central panoramic lift. The aim of a lighting concept is to determine the positions of the luminaires and the lighting quality, without defining luminaire types or illuminance levels.

The walkways leading from the individual sales floors to the lifts receive a curtain of light from the direct luminaires arranged closely together along the wall (7).

A series of recessed ceiling downlights (8) provide general lighting in the adjoining sales spaces.

Practical planning

Wallwashers equipped with (from the top downwards) halogen lamps, metal halide lamps and compact fluorescent lamps: the same luminaire types with identical distribution characteristics produce different luminous flux, luminous colour and colour rendering qualities depending on the lamp used.

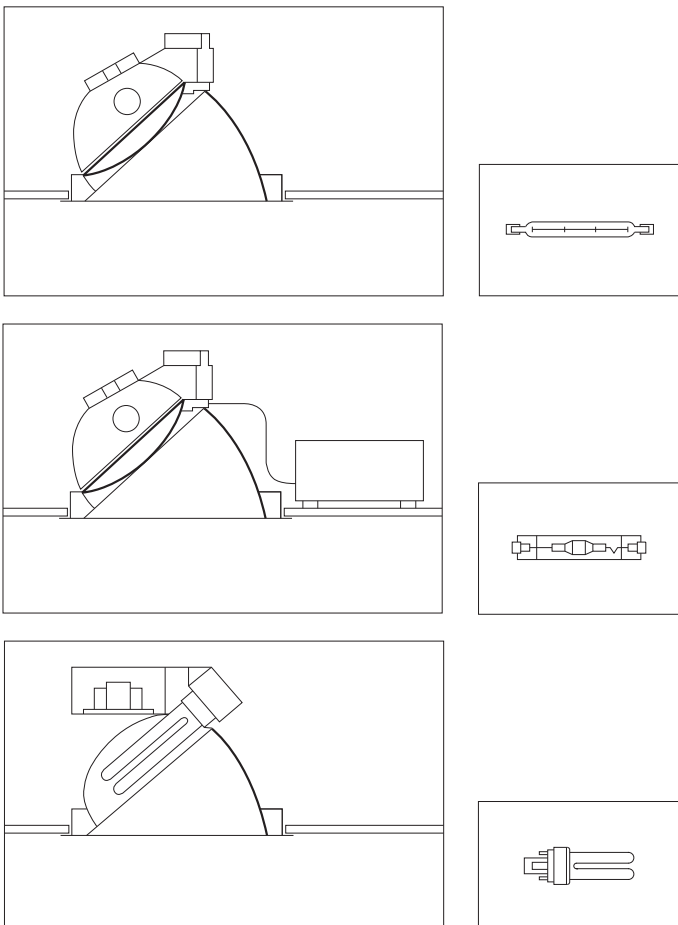

Having completed the project analysis and developed a lighting concept the next phase entails practical planning: decisions regarding the lamps and luminaires to be used, the arrangement and installation of the luminaires, their control gear and the lighting control equipment required. A detailed design can be developed from a concept based primarily on lighting qualities, which will allow both illuminances and costs to be calculated to a reliable degree.

Similar to the earlier planning phases, it is also not possible at this stage in the planning process to stipulate a fixed or standard sequence of planning steps – it may be possible to decide on a lamp type at the beginning of a project, but it may equally not be possible until an advanced stage in the planning process; the lighting layout may be the consequence of the choice of a particular luminaire or, alternatively, the basis for the choice of luminaire. Lighting design should be regarded as a cyclical process, which always allows the solutions that have been developed to be aligned to the stated requirements.

3.3.1 Lamp selection

The choice of light sources has a decisive influence on the qualities of a lighting installation. This applies first and foremost to the technical aspects of the lighting; the costs for control gear that may be required, the possibility of incorporating a lighting control system and, above all, the operating costs for the lighting installation, depend almost entirely on the choice of lamps. It also applies similarly to the quality of light the lighting designer is aiming to achieve, e. g. the choice of luminous colour to create the atmosphere in specific spaces, the quality of colour rendering or the brilliance and modelling necessary for display lighting. The effect of the lighting does not depend solely on the decision to use a specific lamp type, however; it is the result of the correlation of lamp, luminaire and illuminated environment. Nevertheless, the majority of lighting qualities can only be achieved with the correct choice of light source. It is just as impossible to create accent lighting using fluorescent lamps as it is to obtain acceptable colour rendering under sodium lamps.

The decision to select a particular light source is therefore not to be taken lightly, but is dependent on the criteria defined by the required lighting effect and basic conditions pertaining to the project. From the wide range of lamp types available there will only be a limited number which will fulfil the specific requirements.

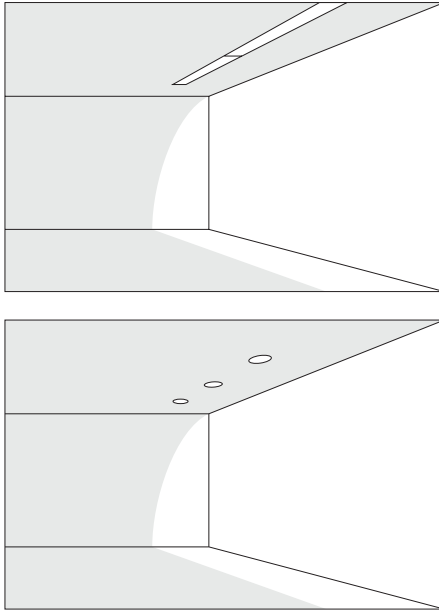

Wallwashers for fluorescent lamps (above) and halogen lamps (below). Uniform wall-washing can be achieved with the diffuse light produced by the fluorescent lamps or with the directed light from the halogen lamps.

3.3.1.1. Modelling and brilliance

Modelling and brilliance are effects that can be most easily achieved using directed light. Compact light sources are the most suitable, as their light intensity can be increased significantly by using reflectors.

The *modelling* of three-dimensional objects and surfaces is emphasized by the shadows and luminance patterns produced by directed light. Modelling is required when the material qualities emphasized (spatial form and surface structure) have an informative value - be it to check the quality of the material itself, for the lighting of a sculpture, the presentation of goods or the illumination of interestingly structured room surfaces.

Modelling can only be effected by directed light coming predominantly from one direction. To produce modelling effects it is therefore only possible using effectively point light sources, where the intensity of light is frequently increased using reflectors or other control systems. For this reason the first choice is compact lamps with rotationally symmetrical reflector systems. Linear light sources are not suitable for producing modelling, the longer the lamp, the less suitable it is, since the significant diffuse component lightens shadows.

If extremely dramatic modelling is required in confined areas low-voltage halogen lamps, which are very compact in form, are usually the most appropriate or, if increased luminous power is required, then metal halide lamps. To produce modelling effects there are a variety of compact lamp types which can be used: from general service lamps, reflector lamps and halogen lamps for mains voltage to high-pressure discharge lamps, whereby the modelling effect will inevitably be reduced as the size of the light source increases. Compact fluorescent lamps can produce a reasonable degree of modelling, e.g. when they are used in downlights. Conversely, linear fluorescent lamps produce predominantly diffuse light.

Brilliance is produced by points of light of extremely high luminance. These may be the light sources themselves, but brilliance is also produced when the light sources are reflected on glossy surfaces or when the light is refracted in transparent materials. Specular effects are frequently applied in display lighting or in prestigious environments to emphasize the transparency or sparkling quality of the illuminated materials to enhance their value or to create a festive atmosphere. Producing brilliance and specular effects demands more from the light source than producing modelling effects: it requires concentrated, practically point light sources. The sparkling effect depends predominantly on the lamp luminance. It is relati-

vely independent of the luminous flux emitted by the lamp.

In contrast to lighting that produces modelling effects, brilliance does not require the light to be directed from one particular direction. It only requires the lamps to be point light sources. It is therefore not necessary to control the light using reflectors - exposed light sources can be used to create brilliance, in which case the light source itself and its effect on the illuminated material is perceived as being brilliant.

Low-voltage halogen lamps are primarily used for the creation of brilliance, as they are extremely compact light sources with high luminance. Metal halide lamps can also be used to produce brilliance, although their high luminous power may undermine the creation of specular effects because the overall environment is generally brighter.

Brilliance can also be produced by clear versions of halogen lamps for mains voltage. Larger light sources with light-diffusing surfaces, such as frosted incandescent lamps are less suitable, fluorescent lamps and compact fluorescent lamps not suitable at all.

3.3.1.2. Colour rendering

A light source can be said to have good colour rendering properties when there are only slight deviations in colour between a comprehensive range of colours illuminated by the lamp in comparison to a standardised reference light source of a corresponding colour temperature. Any statement made or data given on colour rendering therefore refers to a specific colour temperature. A colour rendering value that is valid for all luminous colours does not exist. Colour rendering is an important factor in lighting projects where it is important to be able to judge the quality and effect of colours, e.g. for matching colours, for the lighting of works of art or for the presentation of textiles. There are standards that stipulate the minimum colour rendering requirements for the lighting of workplaces.

The colour rendering quality of a light source depends on the composition of the specific lamp spectrum. A continuous spectrum provides optimum colour rendering, whereas line or band spectrums mean poorer colour rendering. The spectral distribution of the light is also of significance for colour rendering. Spectral distribution that differs from that of the reference light source will also have a deteriorating effect on colour rendering values due to the fact that only specific colour effects are emphasized.

The highest colour rendering index (Ra 100), i.e. colour rendering category 1A, is obtained from all forms of incandescent lamps, including halogen lamps, since they represent the reference light source

3.3 Practical planning

3.3.1 Lamp selection

for the warm white range. De-Luxe versions of fluorescent lamps, plus some metal halide lamps have a colour rendering index above 90 and are classified as colour rendering category 1A. The remaining fluorescent lamps and metal halide lamps are classified as colour rendering category 1B or, as the luminous efficacy increases at the expense of colour rendition, fall into colour rendering categories 2A or 2B. High-pressure mercury and sodium lamps with enhanced colour rendering are classified at category 2B, with standard versions classified as category 3. Category 4 only contains low-pressure sodium lamps.

3.3.1.3 Luminous colour and colour temperature

Similar to colour rendering, the luminous colour of a light source is dependent on the spectral distribution of the light emitted by the lamp. In the case of incandescent lamps this distribution is a result of the temperature of the filament, hence the reference to colour temperature. In the case of discharge lamps, however, a comparative value must be used as a guideline – the most similar colour temperature. In practice it is not customary to provide exact colour temperature data. Luminous colour is roughly categorized into warm white, neutral white and daylight white. Through the specific combination of luminous substances it is possible, in the case of discharge lamps, to create a further range of special luminous colours, which cannot be adequately described using colour temperature classification.

The luminous colour of a lamp affects the colour spectrum of illuminated objects. Warm white lamps emphasize the red and yellow ranges of the spectrum, daylight white the blue and green, i.e. cold colours. Luminous colour can be applied as a design factor for the presentation of objects which have defined colour ranges, for example. Some luminous colours are expressly blended for the presentation of specific types of articles. Luminous colour also affects our subjective appreciation of a lighting situation; colder luminous colours at high illuminances and from diffuse lighting are comparable to the light of the sky, warm colour appearances at lower illuminances in the form of directed light are comparable to candlelight and considered to be pleasant. Recommended luminous colours are included in the published standards for the lighting of workplaces.

Light sources with exclusively warm white luminous colour comprise all forms of incandescent lamps plus high-pressure sodium lamps. There are also fluorescent lamps, metal halide lamps and high-pressure mercury lamps available that are classified as being warm white. Light

sources with neutral white luminous colour include fluorescent lamps, metal halide lamps and high-pressure mercury lamps. Daylight white light sources include fluorescent lamps and metal halide lamps. Fluorescent lamps are the only light sources available in special luminous colours. The luminous colour of a lamp can, in fact, be manipulated, either by providing the outer envelope with a special coating, as is the case for daylight quality incandescent lamps, or by applying a conversion filter.

3.3.1.4 Luminous flux

The luminous flux of a lamp is especially important if the number of lamps with which the lighting is to be created has been predetermined. It may be that the lighting is being designed using only a few high output lamps, or that a large number of low light output lamps are to be used. The objective is not to select a few lamps of average luminous intensity, but to vary between large and small "lumen packages". Low-voltage halogen lamps, conventional incandescent lamps and compact fluorescent lamps are examples of small lumen packages. Halogen lamps for mains voltage, fluorescent lamps and high-pressure discharge lamps have higher luminous power. Metal halide lamps have the highest values.

3.3.1.5 Efficiency

The efficiency of a lighting installation depends largely on the choice of lamps. The influence of other aspects, e.g. the choice of control gear and control equipment is of less importance. When selecting lamps on the basis of their efficiency there are a number of criteria that may be of primary importance, irrespective of the basic conditions inherent in the lighting task.

The *luminous efficacy* of a lamp is important when maximum luminous power, and illuminance, is to be achieved using a minimum of electric power. Incandescent lamps and halogen lamps have the lowest luminous efficacy at around 10-20 lm/w. The luminous efficacy of fluorescent lamps, high-pressure mercury lamps and metal halide lamps is higher at 40-100 lm/w. The exceptionally high luminous efficacy of sodium lamps (up to 130 lm/w in the case of high-pressure lamps) is achieved at the expense of colour rendering.

The *rated life of a lamp* is always important when maintenance of the lighting installation results in considerable expense or if conditions make maintenance difficult, e.g. in the case of particularly high ceilings or in rooms that are in continual use. The rated life of incandescent

Colour rendering cat. Quality	Applications
1A Optimum	Textile, paint and printing industry Prestigious spaces Museums
1B Very good	Meeting rooms Hotels Restaurants Shop windows
2A Good	Administration buildings Schools Sales spaces
2B Acceptable	Industrial manufacturing plants Circulation zones
3 Adequate	Exterior lighting Warehouses
4 Low	Industrial halls Exterior lighting Floodlighting

Allocation of colour rendering categories in accordance with the CIE and the colour rendering qualities of lamps and their typical lighting tasks.

3.3 Practical planning

3.3.1 Lamp selection

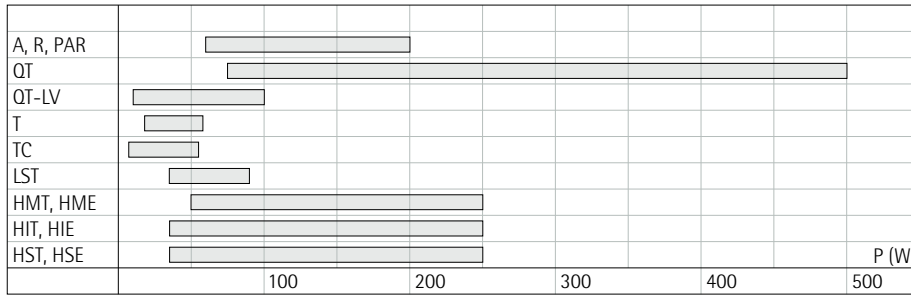

Range of power P for various lamp types.

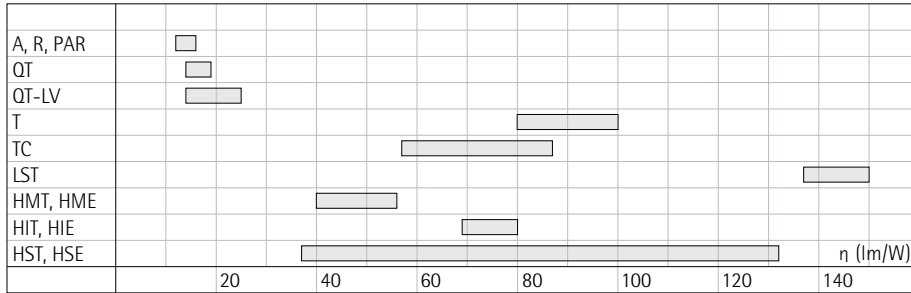

Ranges of luminous efficacy η for various lamp types.

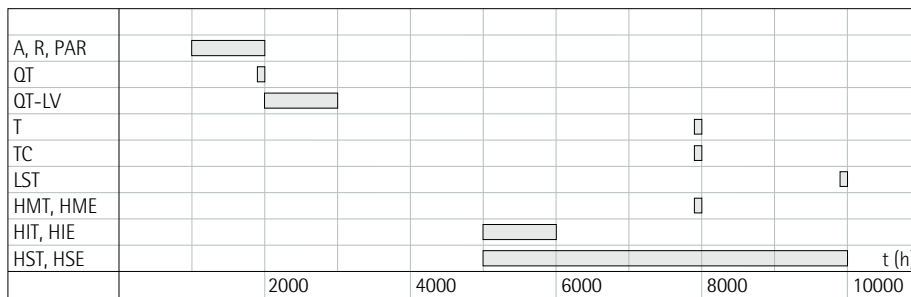

Service life t of various lamp types.

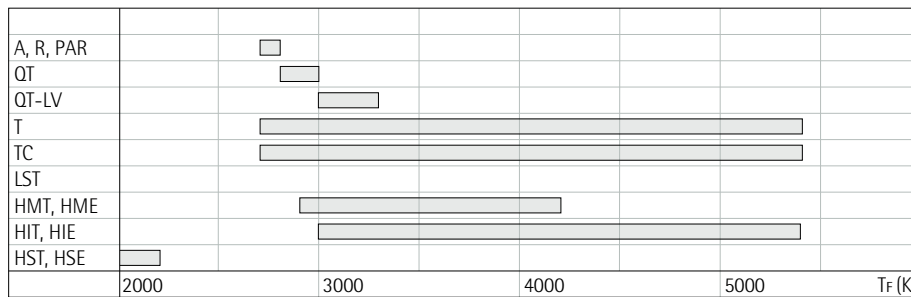

Colour temperature ranges T_F for various lamp types.

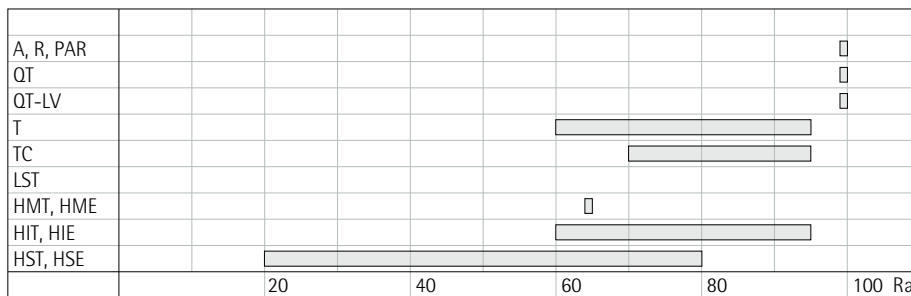

Colour rendering index R_a ranges for various lamp types.

lamps is given as the average lamp life after the failure of 50 % of the lamps; in the case of discharge lamps the values refer to lamp life in terms of light output, i.e. when there is a reduction in luminous flux of up to 80 %. The actual rated life is, however, also affected by site conditions. In the case of incandescent lamps the operating voltage has a critical influence on the life of the lamp. In the case of discharge lamps it is switching frequency that affects the rated life.

Incandescent lamps and halogen lamps have the shortest rated life at 1000 - 3000 h. The rated life of fluorescent lamps and metal halide lamps is considerably higher at 8000 h and 6000 h, respectively. Sodium lamps have a rated life of 10 000 h, high-pressure mercury lamps over 8000 h.

Lamp costs are another aspect of the efficiency of a lighting installation. They vary between values that can be ignored when compared with costs for power and maintenance, to values that are as high as these costs. The most economical lamps are conventional incandescent lamps, followed by fluorescent lamps and halogen lamps. Prices for high-pressure discharge lamps are substantially higher.

3.3.1.6 Brightness control

The dimming quality of light sources is important for the lighting of spaces with changing activities and for environments where different atmospheres are required. Dimmable lamps can also be used to adjust the lighting to changing environmental conditions, e.g. day and night-time lighting.

Conventional incandescent lamps and halogen lamps for mains voltage can be dimmed easily and economically. Low-voltage halogen lamps and fluorescent lamps are technically more difficult to handle, but are also dimmable. From a technical point of view high-pressure discharge lamps should not be dimmed.

$$K = \left(\frac{K_{La}}{\Phi \cdot t} + \frac{P \cdot a}{\Phi \cdot 1000} \right) \cdot 10^6$$

$$[K] = \frac{DM}{10^6 \text{ lm} \cdot \text{h}}$$

$$[K_{La}] = DM$$

$$[P] = W$$

$$[\Phi] = \text{lm}$$

$$[t] = \text{h}$$

$$[a] = \frac{DM}{\text{kW} \cdot \text{h}}$$

Formula for calculating the operating costs of a lighting installation on the basis of specific lamp costs K (DM/10⁶ lmh). To calculate the costs the lamp price K_{La} , the wattage P , the luminous flux Φ , the

service life t and the cost per unit of electricity a are required. Depending on lamp type and power the specific costs can be between DM 3 and DM 30 per 10⁶ lmh.

3.3.1.7 Ignition and re-ignition

Lamp behaviour when lamps are switched on and re-switching after power failure may be of significance in the design. For many applications it is essential that the light sources provide sufficient luminous flux immediately after switching (e.g. when a person enters a room). In the majority of cases there is no time to allow a cooling phase before reigniting lamps that have been switched off or are off due to power failure. For the lighting of large meeting spaces and sports facilities there are statutory requirements stipulating that the instant re-ignition of lamps must be ensured.

Incandescent lamps and halogen lamps pose no problems here. They can simply be switched on at any time. The same applies to fluorescent lamps, which can be ignited in a cold or warm state with negligible delay. High-pressure discharge lamps require a substantial run-up period. Re-ignition is only possible without special equipment, after a specific cooling time. If high-pressure lamps are to allow instant re-ignition, double-ended versions equipped with special ignitors must be installed.

3.3.1.8 Radiant and thermal load

When dimensioning air-conditioning plants the lighting load has to be taken into account. This is due to the fact that the power used by the lighting equipment is, in fact, converted into heat, either directly through air convection or when light-absorbing materials heat up. The thermal load of a space increases, the lower the efficacy of the light sources, since in the case of low efficacy for a given lighting level more energy exists in the infrared range.

In the case of some special lighting tasks limiting the radiant load on objects is a prime concern. This applies to accent lighting on heat-sensitive objects. Radiation problems occur most frequently in exhibition lighting, however. In the exhibition environment light, infrared and ultraviolet radiation, can all result in damage due to the acceleration in the ageing of materials and fading of colours.

High proportions of infrared radiation and convection heat are emitted by light sources with predominantly low luminous efficacy, such as incandescent lamps and halogen lamps. In the case of linear and compact fluorescent lamps infrared radiation is considerably lower.

Ultraviolet radiation is theoretically emitted predominantly by high-pressure discharge lamps. As the UV component is always reduced by obligatory front glass covers, the highest ultraviolet load in practice is produced by halogen lamps which

3.3 Practical planning

3.3.1 Lamp selection

Optical radiation	λ (nm)
UV-C	$100 \leq \lambda < 280$
UV-B	$280 \leq \lambda < 315$
UV-A	$315 \leq \lambda < 380$
Light	$380 \leq \lambda < 780$
IR-A	$780 \leq \lambda < 1400$
IR-B	$1400 \leq \lambda < 3000$
IR-C	$3000 \leq \lambda < 10000$

Wavelength ranges of ultraviolet radiation (UV), visible radiation (light) and infrared radiation (IR). UV and IR radiation are further subdivided into A, B and C categories, in accordance with DIN 5031 Part 7.

Lamp	Φ_e (W/klm)		
	UV	Light	IR
A, R, PAR	0.05–0.10	5–7	35–60
QT	0.10–0.15	5–6	25–30
T, TC	0.05–0.15	3–5	6–10
HME	0.20–1.00	2–3	10–15
HIT	0.20–1.00	2–5	6–10
HSE	0.01–0.05	2–3	4–6

Relative radiation flux Φ_e of different lamp types in relation to a luminous flux of 10^3 lm, classified according to the different wavelength ranges: UV (280 nm–380 nm), light (380 nm–780 nm), IR (780 nm–10000nm).

$$E_e = \Phi_e \cdot \frac{E}{1000}$$

$$[E_e] = \frac{W}{m^2}$$

$$[\Phi_e] = \frac{W}{klm}$$

$$[E] = lx$$

Correlation of the irradiance E_e on an exhibit at a given illuminance E and the relative radiation performance of a lamp Φ_e .

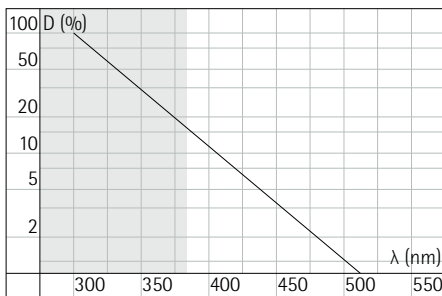

Relative damage factor D of optical radiation as a function of wavelength λ . Damage decreases exponentially through the wavelengths including the majority of the range of visible radiation.

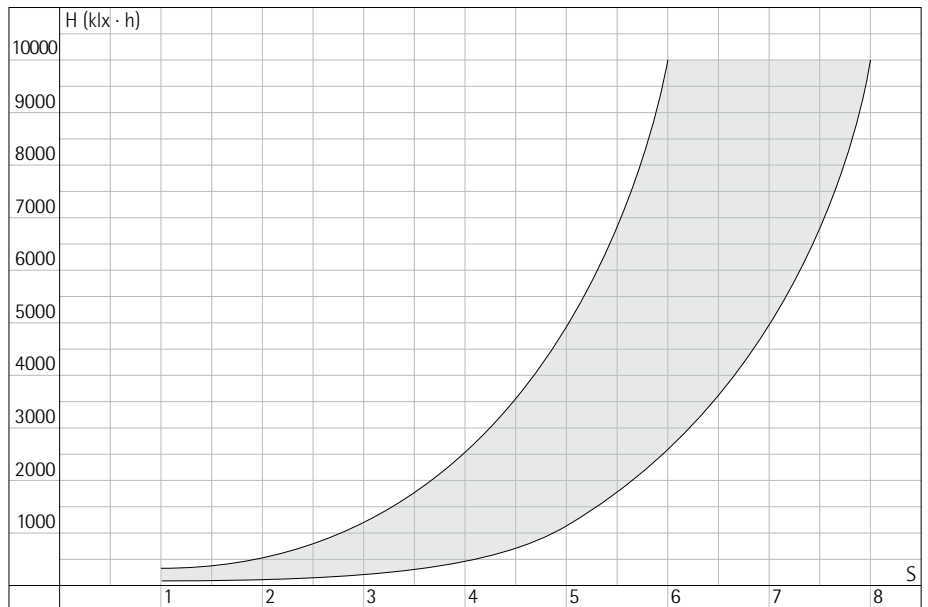

Range of exposure H as the product of illuminance E (klx) and exposure time t (h) for the visible fading of an exhibit as a function of the light fastness S of the exhibit (in accordance with DIN 54004) and the type of light source used. The upper tolerance curve applies to incandescent lamps,

the lower one to daylight. Halogen lamps and discharge lamps lie within the band. Example: an exhibit classified as light fastness category 5 shows initial evidence of fading after approx. 1200 klxh under daylight, after approx. 4800 klxh under incandescent light.

do not have an outer envelope. They emit minimal ultraviolet radiation, emitting this freely through their quartz glass outer envelopes. Disturbing infrared or ultraviolet components produced by the selected lamps can in practice be reduced substantially through the use of suitable reflectors or filters.

Both infrared and ultraviolet radiation load on persons or objects produced by light sources used for interior lighting is negligible. The limit set for connected load is approximately 50W/m², above which the effect of the thermal load will have a noticeable effect on the subjective feeling of well-being in the local area.

An exception exists in the case of special fluorescent lamps, so-called "full spectrum lamps", whose spectral distribution is very similar to the global radiation of the sun and daylight, producing a "natural" light. The UV and infrared components are increased at the expense of the visible radiation. There is no documentary evidence on the advantages of these lamps with regard to health or technical benefits in the quality of light.

3.3.2 Luminaire selection

The choice of light sources outlines the technical qualities of the lighting design concept and the limits to the lighting qualities that can be achieved. The lighting effects that can be obtained within this range depend on the choice of luminaires in which the lamps are to be used. The choice of lamp and luminaire is therefore closely related. Opting for a particular light source will reduce the choice of luminaire, and vice versa, the choice of luminaire will restrict the choice of lamp.

3.3.2.1 Standard product or custom design

In most cases the choice of luminaires will be confined to the standard products available, because they can be supplied at reasonably short notice, have clearly defined performance characteristics and have been tested for safety. Standard luminaires can also be used in special constructions, such as lighting installations that are integrated into the architecture (e.g. cove lighting or luminous ceilings). In the case of large-scale, prestigious projects consideration may also be given to developing a custom designed solution or even a new luminaire. This allows the aesthetic arrangement of luminaires in architecture or in a characteristically designed interior and the solution of specific lighting tasks to be effected in closer relation to the project than if only standard products are chosen.

Additional costs for development and time considerations must be included in the calculation of overall costs for the project.

3.3.2.2 Integral or additive lighting

There are two basic contrasting concepts for the arrangement of luminaires in an architectural space, which can allocate different aesthetic functions to the lighting installation and provide a range of lighting possibilities. On the one hand, there is the attempt to integrate the luminaires into the architecture as far as possible, and on the other hand, the idea of adding the luminaires to the existing architecture as an element in their own right. These two concepts should not be regarded as two completely separate ideas, however. They are the two extremes at either end of a scale of design and technical possibilities, which also allows mixed concepts and solutions.

In the case of integral lighting the luminaires are concealed within the architecture. The luminaires are only visible through the pattern of their apertures. The planning does not focus on the application of the luminaires themselves as design elements, but on the lighting effects produced by the luminaires. Integral lighting can easily be applied in a variety of environments and makes it possible to coordinate luminaires entirely with the design of the space.

Integral lighting generally presents a comparatively static solution. The lighting can only be changed using a lighting control system or applying adjustable luminaires. There are therefore limits to adapting integral lighting to meet the changing uses of a space. Integral lighting also requires certain conditions relating to the installation. This may mean a suspended ceiling to allow recessed mounting, or the provision of apertures for recessed mounting into ceilings or walls in new buildings. The most extreme cases are forms of lighting that use architectural elements to create lighting effects. These include luminous ceilings, cove lighting or backlit elements. Recessed ceiling luminaires, i.e. the entire spectrum of downlights, from recessed downlights to washlights, recessed directional spotlights and specific louvred luminaires, are specifically designed as integral lighting elements. Floor and ceiling washlights in particular can be integrated into walls.

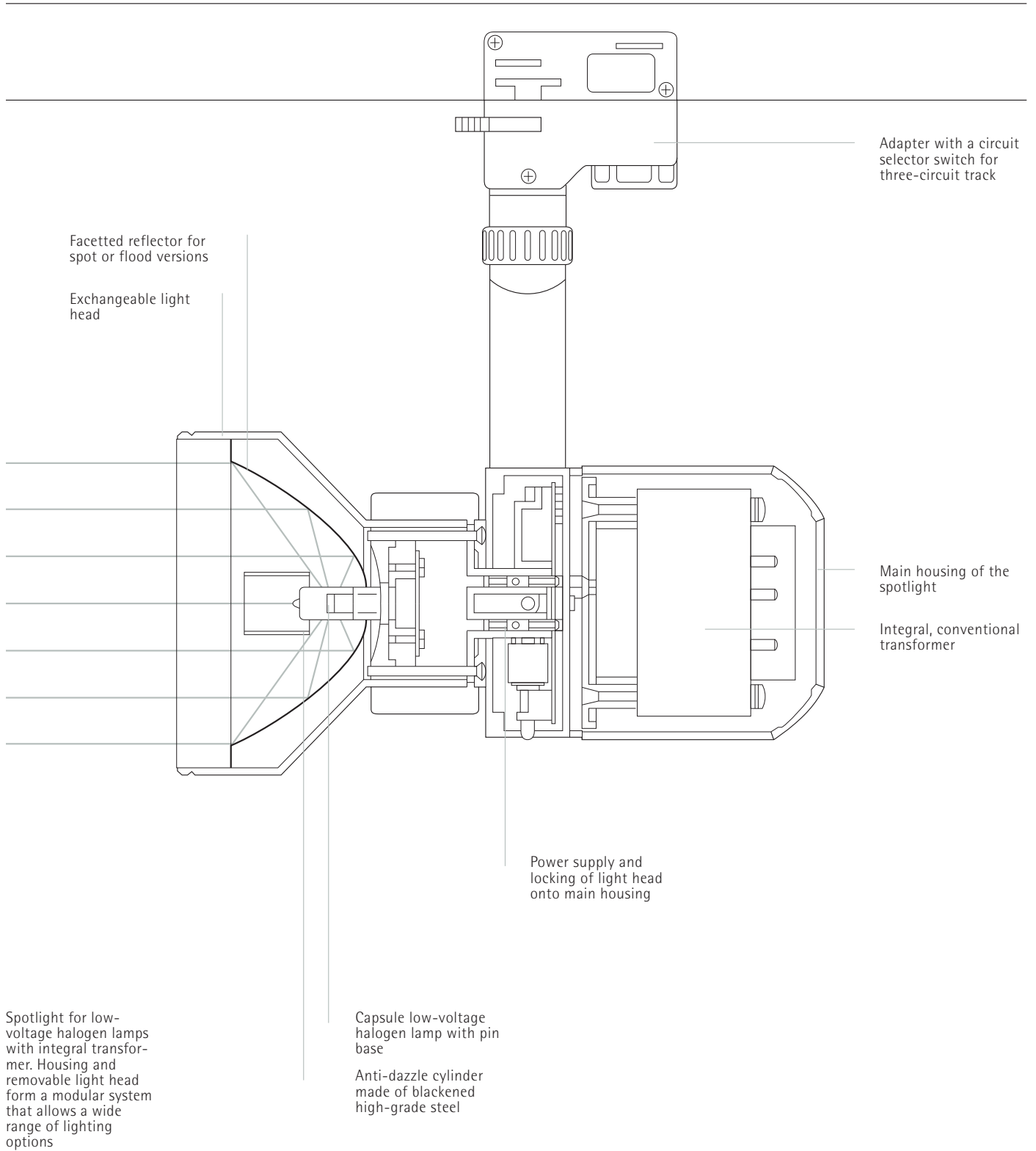

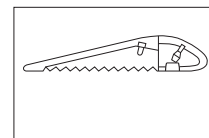
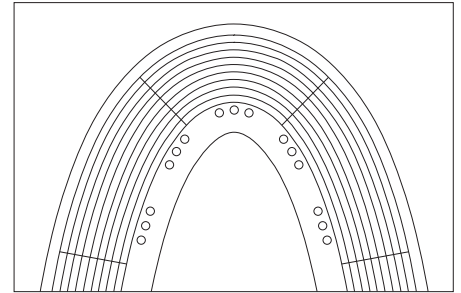
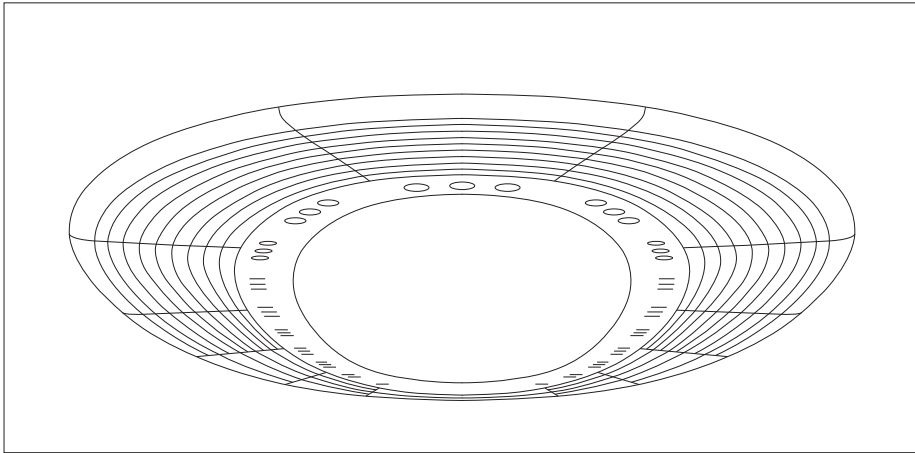

Custom designed luminaire for the boardroom in the Hongkong and Shanghai Bank. The elliptical luminaire (9.1 x 3.6 m) corresponds to the form of the conference table. The inner ring of the luminaire contains a series of directional spotlights, which are aligned to the seating. The outer ring contains a prismatic diffuser, which provides ambient lighting and some specular effects.

Custom designed luminaire for the coffer ceiling in the new entrance to the Louvre. Fluorescent lamps (1) illuminate the sides of the coffers and provide indirect lighting as an integral ceiling element. An additional spotlight (2) can be used for accent lighting.

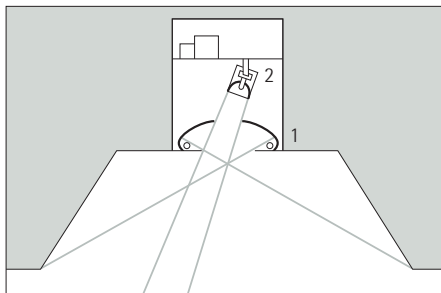

Custom designed luminaire based on a standard product: the optical system of a conventional louvred luminaire (below) is used as the direct element within a linear secondary reflector luminaire (above).

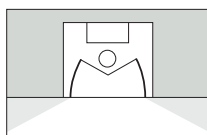
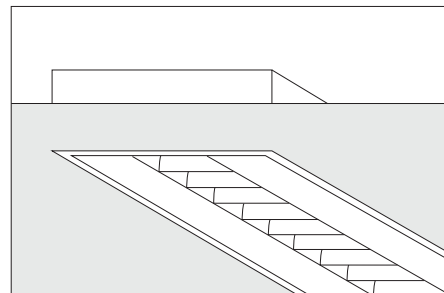
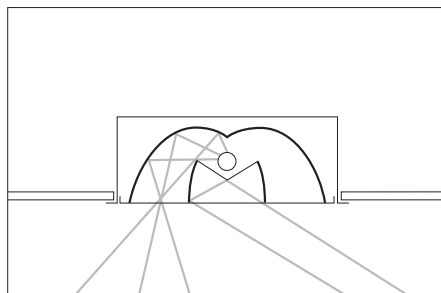

In the case of additive lighting the luminaires are not integrated into the architecture, but appear as elements in their own right. Besides planning the lighting effects which are to be produced by these luminaires, the lighting designer has to specify the luminaire design and plan the lighting layout in accordance with the architectural design. The range of planning possibilities extends from harmonizing luminaires with available structural systems to selecting luminaires that will have an active influence on the overall visual appearance of the space.

Luminaires typically used for additive lighting are light structures, spotlights and surface-mounted downlights. Due to the fact that they are a separate element from the ceiling, light structures offer wide scope for a variety of applications: they allow both direct and indirect or combined direct-indirect lighting. Spotlights, which can be mounted directly onto the ceiling or onto suspended trunking systems, are especially suitable when flexible lighting is required, e.g. for display and exhibition purposes. What is gained in flexibility is offset by the task of harmonizing the visual appearance of the lighting installation with the environment and avoiding visual unrest through the mixing of different luminaire types or by a confusing arrangement of light structures.

There are numerous intermediate options between the extreme forms of completely integral lighting and totally additive lighting. Integral lighting using downlights comes close to an additive lighting concept if semi-recessed, surface-mounted or pendant downlights are installed. The lighting requirements met by spotlights in an additive lighting concept can also be met by using recessed directional spotlights. Lighting design and the luminaire selection are therefore not bound by the decision to opt for a distinctly integral or additive lighting solution. Within the available options a decision can be made on a concept that corresponds to the architectural, aesthetic and lighting requirements.

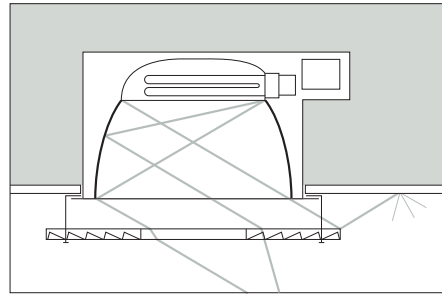
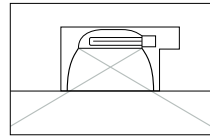

Custom designed luminaires based on standard products: a prismatic panel mounted at a specific distance below the ceiling aperture of a standard downlight controls luminance distribution. The ceiling is illuminated and the shielding of the lamp is improved.

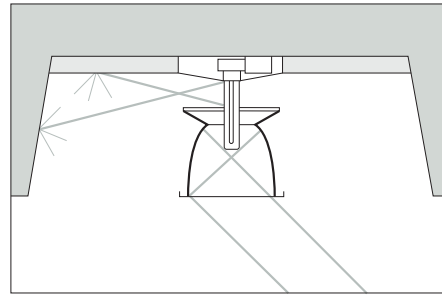
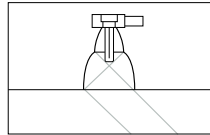

The darklight reflector in a conventional downlight is used as the direct element in a rotationally symmetrical secondary reflector luminaire.

Integral and additive lighting: identical lighting effects produced by recessed downlights and downlights mounted on a light structure.

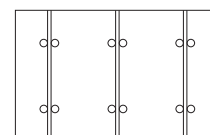
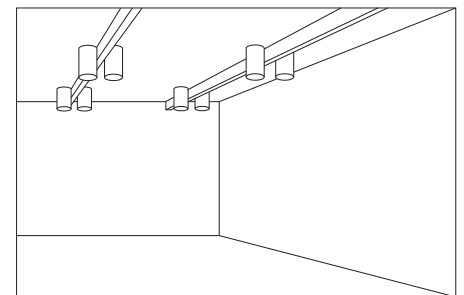
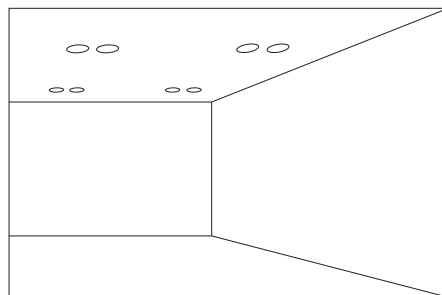

3.3.2.3 Stationary or movable lighting

The decision to opt for a stationary or variable lighting installation overlaps the decision to go for an integral or additive solution; it is determined by the lighting requirements the installation has to meet rather than by design criteria.

There are different ways of making a lighting installation flexible. Time-related or spatial changes can be produced in all permanently fitted systems, whether they consist of recessed luminaires, surface-mounted luminaires or suspended structures, by using a lighting control system. Individual luminaires or groups of luminaires can be dimmed or switched to adjust the lighting to suit the changing uses of the space. The next step towards increased flexibility is the application of permanently fitted luminaires that can be directed, such as directional spotlights or spotlights installed on singlets. The highest degree of flexibility, as required for the lighting of temporary exhibitions and display lighting, is provided by movable spotlights mounted on track or trunking systems. This means that the lighting can be adjusted using a lighting control system, completely rearranged, realigned or individual luminaires substituted. In the decision to go for a more static or a variable lighting system there is a seamless transition between the extremes, which allows the lighting to be adjusted to suit the specific requirements.

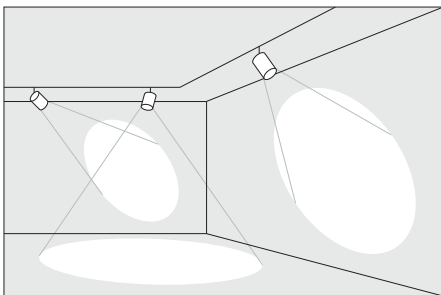
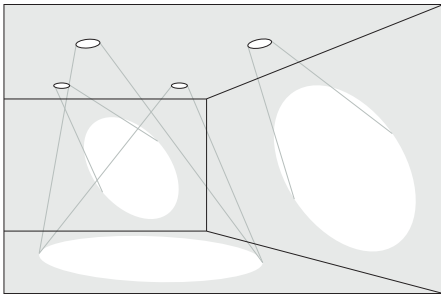

Stationary and movable luminaires: identical lighting produced by directional spotlights and track-mounted spotlights.

sufficient to provide ambient light – general lighting can therefore be produced by accent lighting. This shows that there are no longer any grounds for dividing general lighting and accent lighting into distinctly different forms of lighting. Both areas overlap, in fact, the two are no longer separate, the one can now be combined with the other.

Luminaires with wide-angle distribution are most suitable for general lighting, especially louvred luminaires and light structures designed for fluorescent lamps, as found in a majority of installations designed for work-places. Uniform lighting can be equally well effected using indirect lighting provided by ceiling washlights, wallwashers or secondary luminaires. Above all, for the lighting of prestigious spaces, such as lobbies or large meeting rooms, a close arrangement of narrow-beam downlights recessed in the ceiling is appropriate.

The choice of luminaires for accent lighting is less extensive and limited to luminaires that are able to produce concentrated, directed beams of light. Downlights are generally used for the static lighting of horizontal lighting tasks, the more variable version being recessed directional spotlights. Movable spotlights on track or light structures offer the maximum flexibility in beam direction and variability.

3.3.2.4 General lighting and differentiated lighting

The decision to design predominantly uniform general lighting or more distinctly differentiated accent lighting depends on the lighting task – it only makes sense to emphasize individual areas using light if there is a noteworthy difference in the information content between significant areas or objects and their surroundings. If the distribution of lighting tasks and information content is uniform across an area, correspondingly general lighting will be appropriate.

Whereas uniform general lighting usually means a standard lighting design concept, which is generally the case for the lighting of workplaces, a lighting design concept that aims to create isolated accents may be regarded as an exception. As a rule, accent lighting will always contain a general lighting component to allow the viewer to perceive the spatial arrangement of illuminated objects and provide for orientation within the space. This general lighting can be produced by certain luminaires, the ambient light they produce providing a background against which significant areas can be picked out using accent lighting to produce "focal glow". Scattered light from the areas illuminated by accent lighting is frequently

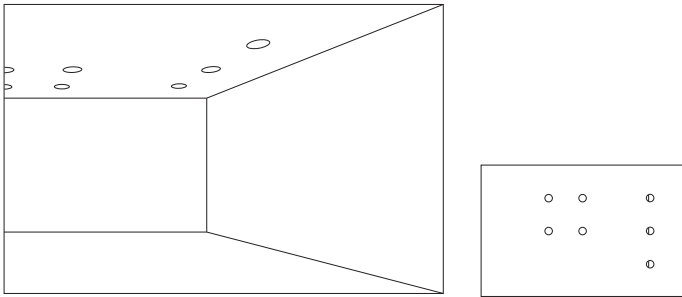
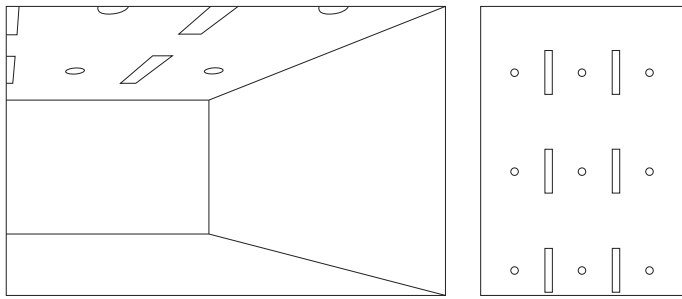

General lighting and differentiated lighting: general lighting provided by a regular arrangement of louvred luminaires and downlights. Both components can be switched and dimmed separately to produce a timed differentiation (above). Spatial differentiation is achieved by the arrangement of wall-washers and the grouping of downlights (below).

3.3.2.5 Direct or indirect lighting

The decision whether to plan direct or indirect lighting affects the proportion of directed or diffuse lighting in the space significantly. This decision results in a lighting concept which, in the case of indirect lighting, is designed to produce diffuse general lighting, whereas a direct lighting concept may comprise both direct and diffuse light and both general and accent lighting.

Indirect lighting provides the advantage that it produces very uniform, soft light and creates an open appearance due to the bright room surfaces. Problems arising from direct and reflected glare do not occur, making indirect lighting an ideal solution for critical visual tasks, such as work at VDTs.

It should be noted, however, that indirect lighting alone produces very poor modelling and spatial differentiation. In addition, there is no accentuation of the architecture or the illuminated objects. The result may be a flat and monotonous environment.

Indirect lighting is achieved by the light from a primary light source being reflected by a substantially greater, mostly diffuse reflecting surface, which in turn adopts the character of a large-scale secondary reflector luminaire. The reflecting surface may be the architecture itself: the light may be directed onto the ceiling, the walls or even onto the floor, from where it is reflected into the room. There is an increase in the number of so-called secondary reflector luminaires which are being developed. They consist of a primary light source with its own reflector system and a larger secondary reflector. This design allows improved optical control of the emitted light.

Direct lighting, mostly using louvred luminaires, can also be used to produce general lighting with a predominant diffuse component. It may well also have a component of directed light. This gives rise to distinctly different lighting qualities, above all considerably enhanced modelling and more clearly defined surface structures.

A lighting design concept based on direct lighting means that individual areas within the space can be purposefully lit from almost any location. This allows a greater degree of freedom when designing the luminaire layout.

Direct and indirect lighting: direct lighting using downlights (above), indirect lighting using wall-mounted ceiling wash-lights (below).

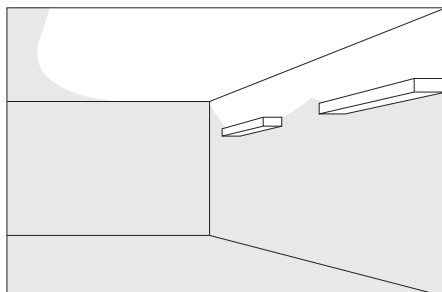
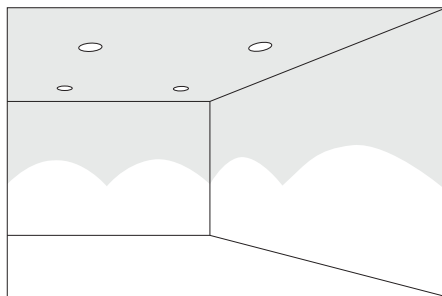

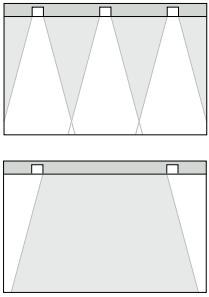

Horizontal and vertical lighting: the same luminaire layout can be used for downlights for horizontal lighting as well as for wall-washers for vertical lighting.

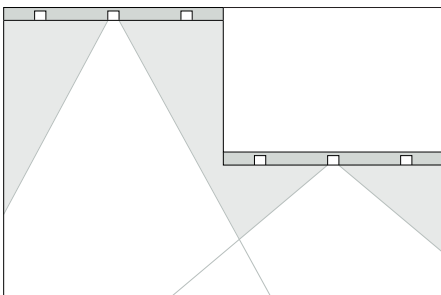

Horizontal general lighting from different ceiling heights: as a rule, narrow-beam luminaires are used for high ceilings and wide-beam luminaires for low ceilings to ensure that the light beams overlap.

3.3.2.6 Horizontal and vertical lighting

In contrast to the decision to opt for an integral or additive lighting installation, or for a static or variable concept, the extreme forms of exclusively horizontal or vertical lighting are hardly significant in practice: a portion of the missing form of lighting is almost always automatically produced through the reflections on room surfaces and illuminated objects. In spite of this interdependence the character of a lighting installation is predominantly determined by the emphasis laid on either horizontal or vertical lighting.

The primary decision to provide horizontal lighting is frequently in line with the decision to plan functional, user-oriented light. This is especially true in the case of lighting for workplaces, where the lighting is predominantly designed as uniform lighting for horizontal visual tasks. In such cases vertical lighting components are predominantly produced by the diffuse light that is reflected by the horizontal illuminated surfaces.

The decision to plan vertical lighting may also be related to the task to fulfil functional requirements, especially in the case of the lighting of vertical visual tasks, e.g. the reading of wall charts or the viewing of paintings. However, vertical lighting frequently aims to present and create a visual environment; in contrast to horizontal, purely functional lighting, vertical lighting is intended to emphasise the characteristic features and dominant elements in the visual environment. This applies first and foremost to architecture, whose structures can be clearly portrayed by purposefully illuminating the walls, as well as to the accentuation and modelling of objects in the space. Vertical lighting is also essential in order to facilitate communication, to ensure people's facial expressions are not concealed by the heavy shadows produced by single-component horizontal lighting.

3.3.2.7 Lighting working areas and floors

One of the most common lighting tasks is the illumination of horizontal surfaces. This category includes the majority of lighting tasks regulated by standards for workplaces and circulation areas. This may be the lighting of the working plane (0.85 m above the floor) or the lighting of the floor itself (reference plane 0.2 m above the floor).

The illumination of these planes can be effected by direct light, and a large number of luminaires are available for this task. A variety of lighting effects can be achieved depending on the choice of luminaires. Louvred luminaires or light structures for fluorescent lamps produce uniform general lighting, which is primarily required for workplaces. Conversely,

by using downlights, especially those designed for incandescent lamps, directed light can be produced that accentuates the qualities of materials more intensely and produces greater differentiation in the lighting of a space; this can be used effectively for the illumination of prestigious spaces and for display lighting. A combination of both luminaire types is possible to create spatially differentiated lighting or to increase the portion of directed light in general.

The illumination of horizontal surfaces can also be provided using indirect light. In this case the walls, or preferably the ceiling, are illuminated to produce uniform, diffuse ambient lighting using these surfaces to reflect the light. Indirect light consists of vertical components to provide a bright atmosphere in the space and horizontal components for the actual lighting of the working area or floor. This can be used for the lighting of corridors, for example, to create a spacious impression in spite of low illuminances. Indirect lighting is glare-free, which makes it especially suitable for lighting visual tasks that can be easily undermined by disturbing reflected glare, e.g. at workstations. If more modelling is required to enhance the three-dimensional quality of illuminated objects or to accentuate architectural features indirect lighting can be supplemented by directed lighting, which provides the required accentuation. In some cases very little modelling is required, which means that indirect lighting provides an optimum solution. It should be noted that energy consumption for an indirect lighting installation may be up to three times higher than that for a direct lighting system due to restricted reflection factors.

In future, a combination of direct and indirect lighting will gain in significance as opposed to exclusively direct or indirect lighting, in which case the indirect component will provide general lighting with a high degree of visual comfort, and the direct component accent lighting for the working area and inherent visual tasks.

Besides the combination of direct and indirect luminaires, either as individual luminaires or as integral luminaires in light structures, secondary luminaires can also be used. They emit both direct and indirect light and allow optical control of both.

3.3.2.8 Wall lighting

Wall lighting can fulfil a variety of tasks. It can be directed at vertical visual tasks on the walls, e.g. textual information on charts or posters, objects such as paintings, or retail goods, architectural structures or the wall surface itself. Wall lighting may also be intended to present the wall in its function as a room surface; finally, wall lighting can be a means for providing indirect general lighting in a space.

To accentuate certain areas of wall or objects on the wall spotlights and recessed directional spotlights are particularly suitable, depending on the degree of flexibility required. In the case of reflecting surfaces, e.g. oil paintings or pictures framed behind glass, attention must be paid to the angle of incidence of the light to avoid disturbing reflections that may arise in the observer's field of vision, if the angle is too low, or heavy shadows that may occur, e.g. shadows of the picture frames on the pictures, if the angle of incidence is too steep.

Grazing light provided by downlights is especially suitable for accentuating surface structures. This type of lighting can also be used exclusively for illuminating walls, if a scallop effect is required. In corridors and exterior spaces in particular grazing light on walls can be effected using uplights or combined uplight and downlights. In any case the distribution of the scallops over the wall should be in line with the proportions of the space and follow a regular rhythm. Asymmetrical spacing, which may be required due to special features of the particular wall surface, e.g. the positions of doors or objects, is also possible.

If the wall is not to be revealed as a room surface as such, but an open impression of a wall is required, then uniform, transitionless lighting should be used. Washlights are the most appropriate luminaires in this case. There are various models available, including fixtures for linear walls, for walls with recesses and corners, and for parallel walls in narrow spaces such as corridors. Washlights have a special reflector segment that produces distinctly more uniform illumination of the wall than downlights in their basic form.

Totally uniform wall lighting is obtained using wallwashers, which, like washlights, are available for recessed or surface mounting or for mounting on track or trunking systems. Lighting walls using wallwashers or washlights also provides uniform lighting of vertical visual tasks as well as indirect general lighting.

Illumination of working areas in an office: different lighting concepts can be applied, depending on the type of room and how it is used.

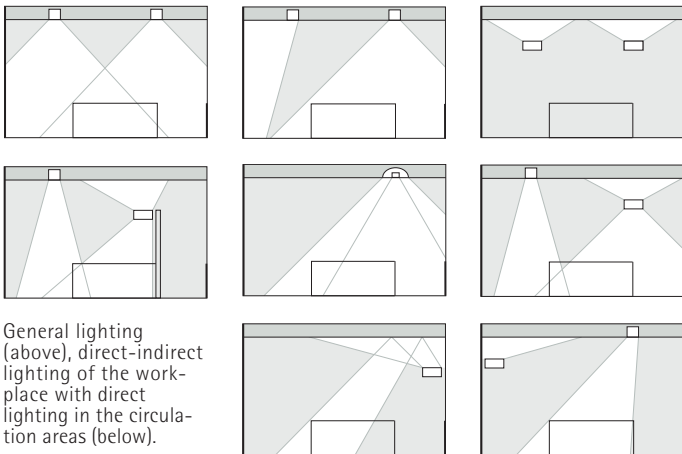
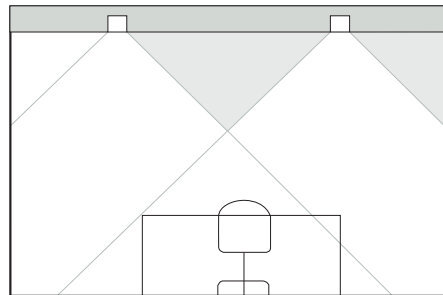

General lighting (above), direct-indirect lighting of the workplace with direct lighting in the circulation areas (below).

Direct light on the working area together with wall lighting (above), secondary reflector luminaires provide light on the working plane (centre), indirect general lighting and lighting for the workplace using the ceiling as a reflector (below).

Indirect general lighting (above), direct-indirect lighting of the workplace with direct lighting in the circulation areas (centre), directed light on the working plane with indirect lighting in the circulation areas (below).

The greater the cut-off angle, the greater the visual comfort provided by the luminaire due to improved glare control. The same lighting layout will produce different distributions on the walls. As the cut-off angle increases, so the beam spread will decrease, as is the case for the combinations shown for the 30°, 40° and 50° angles illustrated.

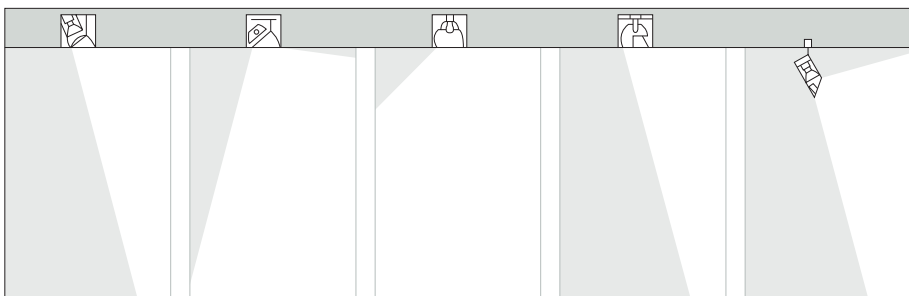
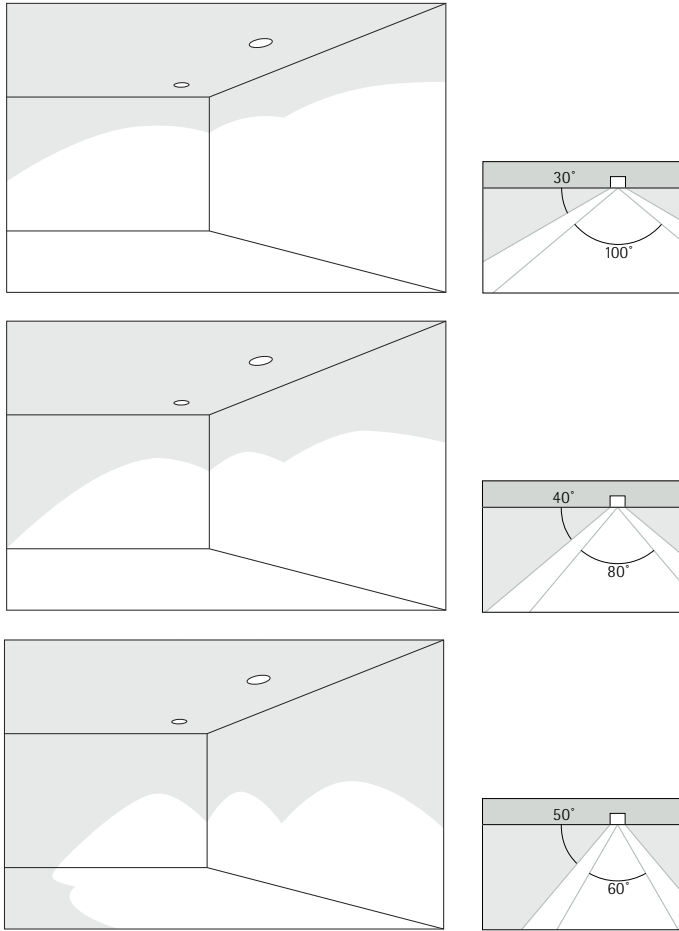

Wall lighting using rotatorially symmetrical luminaires (from left to right): lens wall-washer, directional washlight, washlights, wallwasher, track-mounted wallwasher.

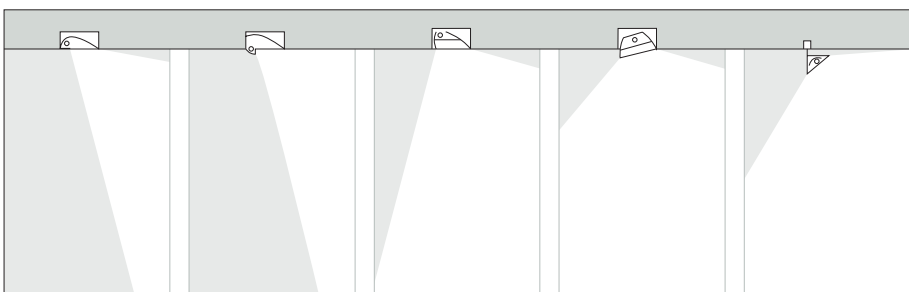

Wall lighting using linear luminaires (from left to right): wall-washer for fluorescent lamps, wallwasher with prismatic element, wallwasher with louvred reflector, adjustable wallwasher, track-mounted wallwasher.

3.3.2.9 Ceiling lighting

Ceiling lighting can be the sole purpose of lighting this room surface, especially when the ceiling has an informative value of its own due to paintings or architectural structures. Ceiling lighting is generally used as a means for providing indirect general lighting of a space. This means that the ceiling becomes the brightest room surface and as such does not correspond to the relative information content. When users spend longer periods of time in the space the ceiling luminance – like an overcast sky – can therefore be felt to be disturbing or is ultimately a source of glare; this applies to luminous ceilings in particular, where it is not the ceiling that is illuminated, but where the ceiling itself becomes an extensive luminaire.

Ceiling lighting can be created using ceiling washlights for mounting on or into the wall; a particularly relevant form of ceiling lighting is cove lighting. If it is not possible to install luminaires on the walls, as is often the case in historical buildings, then free-standing ceiling washlights can be installed. Ceilings can also be illuminated using pendant luminaires or light structures that light the upper half of the space. This option is only applicable if there is sufficient room height, as all luminaires must be mounted above head height to avoid direct glare and they must be installed at a suitable distance from the ceiling to ensure uniform light distribution. If certain areas of the ceiling are to be accentuated, this can be achieved using uplights; this method is also suitable for rooms with low ceilings.

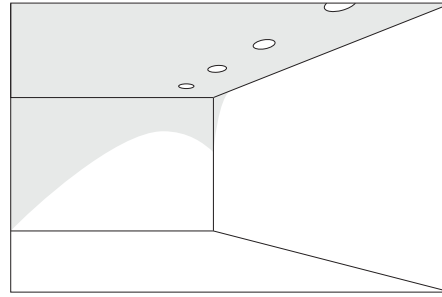

Wall lighting using washlights (above) and wallwashers (below).

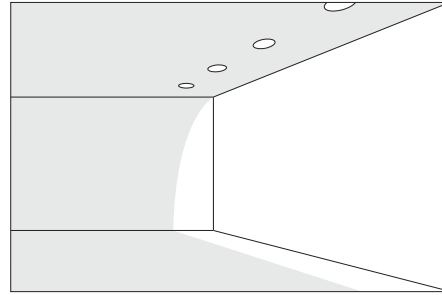

Application of narrow-beam downlights for grazing wall lighting with decorative scallops.

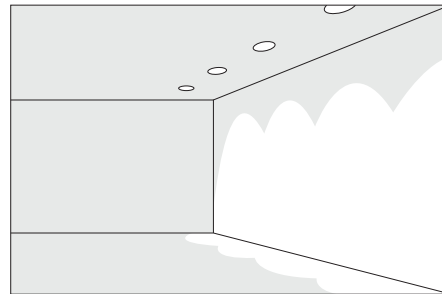

3.3.2.10 Luminance limitation

The question of how to control glare varies depending on whether the luminaires are stationary or movable. In the case of directional luminaires, such as recessed directional spotlights, glare does depend on the light distribution of the luminaire. The glare primarily occurs if the luminaire is not adjusted correctly and the light source becomes visible, either in the luminaire itself or through a reflection of the lamp from specular room surfaces.

In the case of stationary luminaires, such as downlights, louvred luminaires or light structures it is necessary to distinguish between the elimination of direct glare and reflected glare. In the case of direct glare the quality of glare limitation depends on the light distribution of the luminaire. Standards exist for the lighting of workplaces, which stipulate minimum cut-off angles or highest permissible luminances in the cut-off range. For workstations with VDTs there are specific requirements.

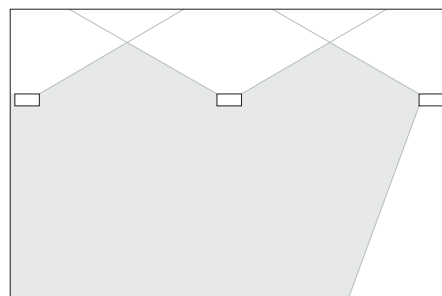

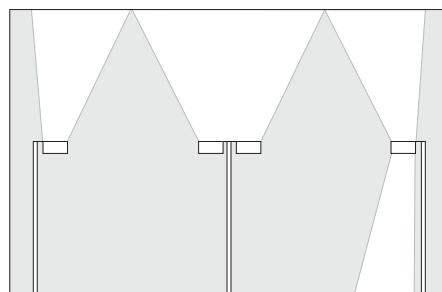

Ceiling lighting using wall-mounted ceiling washlights, pendant indirect luminaires and a wall-mounted direct-indirect luminaire (from left to right).



Free-standing luminaire providing asymmetrical indirect lighting, free-standing luminaire providing symmetrical indirect lighting, free-standing luminaire providing asymmetrical direct-indirect lighting (from left to right).

To ensure that luminaires are electrically safe they are required to meet specific safety standards. These standards require all metal parts which users can touch not to be live if a fault occurs. The protection class indicates the measures of safety provided.

Protect. class		Protection measures
I		The luminaire has a connection point for an earthed conductor, to which all metal parts with which users may come into contact must be connected. Connection to the mains earth conductor is imperative.
II		The luminaire is insulated such that there are no metal parts which users can touch that may be live if a fault occurs.
III		There is no earth conductor. The luminaire is operated on low-voltage up to 42 V, supplied via safety transformers or batteries.



Luminaires are protected against the ingress of foreign bodies and water. The Mode of Protection (IP) is an internationally recognised system comprising two digits XY, whereby X refers to protection against foreign bodies and Y protection against water. The minimum requirements laid down for luminaires in interior spaces is IP 20.



X	Degree of protection against foreign bodies	Y	Degree of protection against water
		0	No protection
		1	Drip-proof: water/spray from above
2	Protection against foreign bodies > 12 mm (protection against manual contact)	2	Drip-proof: water from an angle (up to 15° to the vertical)
3	Protection against foreign bodies > 2.5 mm	3	Protected against spray (up to 15° to the vertical)
4	Protection against foreign bodies > 1.0 mm	4	Protected against spray from all directions
5	Protection against dust	5	Protected against jets of water from all directions
6	Dust-proof	6	Water-proof: flooding
		7	Water-proof: immersible
		8	Water-proof: may be submerged

Conventional IP XY classification for luminaires.

X														
6						•			•				•	
5	•		•	•	•									
4	•		•	•										
3														
2	•		•	•										
	0	1	2	3	4	5	6	7	8	Y				

Symbols used to indicate special qualities and safety requirements.

	Luminaire with discharge lamp, suitable for mounting on parts of buildings comprising materials with an ignition point of >200°C (e.g. wooden ceilings)
	Luminaire with discharge lamp with a limited surface temperature, suitable for installation in areas exposed to dust or containing inflammable materials or in danger of explosion
	Luminaire suitable for installation in or surface mounting on furniture made of standard inflammable material (coated, veneered or painted wood)

	Luminaire suitable for installation in or surface mounting on furniture with unknown inflammable properties
	Safety distance (X) in the direction of beam

In the case of luminaires with mirror reflectors direct glare control improves the greater the cut-off angle, i.e. narrow beam spreads. The standard cut-off angles are 30° and 40°. It is not possible to limit reflected glare by increasing the cut-off angle, however. Correct positioning of the luminaires is essential in order to avoid reflected glare. Any luminaire installed in the critical area of the ceiling over a workplace is a potential source of reflected glare. The critical area can be defined as that portion of the ceiling which is seen by the user in a mirror covering the working area.

3.3.2.11 Safety requirements

Luminaires are required to meet the safety requirements in all cases; in Germany this is usually guaranteed through the provision of a VDE seal of approval. In some cases there are other requirements that have to be met and the luminaires marked accordingly. This applies primarily to fire safety when luminaires are installed in or on furniture or other inflammable materials. Special requirements also have to be fulfilled by luminaires that are to be operated in damp or dusty atmospheres, or in rooms where there is a danger of explosion.

Luminaires are classified according to their Mode of Protection and Protection Class, whereby the protection class indicates the type of protection provided against electric shock, and the Mode of Protection its degree of protection against contact, dust and moisture. Luminaires for application in environments exposed to danger of explosion must meet a further set of requirements.

To ensure safety against fire, luminaires designed for discharge lamps, which are to be mounted on inflammable or easily inflammable materials, must meet the criteria to be marked with the ∇ symbol.

Luminaires to be mounted on furniture require the ∇ seal of approval if they are to be installed on or in inflammable materials. If the flammability of the materials is not known, the $\nabla\nabla$ symbol is required.

3.3.2.12 Relation to acoustics and air conditioning

The acoustics are of primary importance in concert halls, theatres, auditoriums and multipurpose spaces. Acoustical criteria are therefore treated with priority when the ceiling is designed; this may have an influence on the choice and arrangement of the luminaires. Recessed downlights have been proven to be the most suitable for this kind of lighting task, as they have the smallest surface area which may be acoustically significant.

Air-conditioning similarly gives rise to a number of questions; requirements laid down by the lighting and the air-conditioning have to be coordinated to ensure that the ceiling design is harmonious and no conflicts arise in the organisation of ducting. Air-handling luminaires result in a considerable reduction of ceiling apertures and contribute towards creating a uniform ceiling layout. Depending on their design these luminaires can handle air supply, air return, or both air supply and return. If more luminaires are required than for air-conditioning purposes, air-handling dummies can be used that are identical in appearance to the air-handling luminaires, but are not connected to the ventilation system. Air-handling versions of both louvred luminaires and downlights are available.

3.3.2.13 Accessories

A wide variety of luminaires can be equipped with accessories to change their lighting or mechanical properties. These include filters to change the luminous colour or to reduce the UV or infrared radiation, spread lenses to change distribution characteristics, anti-dazzle equipment or mechanical shields, e.g. for protection relating to ball games. For further details, refer to section 2.6.5.

3.3.2.14 Lighting control and theatrical effects

Theatrical effects are increasingly being applied in the field of architectural lighting. These include dramatic contrasts, the use of coloured light and projections using masks and gobos.

Some of these effects can be obtained using conventional luminaires, through striking qualities such as coloured light, or by dramatic modelling, by using accent lighting to divide up the space or by using suitable lighting control. Some luminaires can be equipped with filters and lens systems that allow distribution characteristics to be changed and projections of effects using masks and gobos which are particularly suitable for such lighting tasks.

If a high degree of flexibility is required along with the possibility to control lighting effects with respect to time and location, then special luminaires are required that allow colour changing and the variability in light distribution, or possibly even direction control by remote control. Such luminaires, which have been used primarily for show lighting to date, are now being developed for interior and exterior architectural lighting.

3.3.3 Lighting layout

Depending on the specific lighting project, there may be a number of conditions that determine the lighting layout. The first is related to the particular lighting tasks. Differentiated lighting for different parts of the room or functional areas may result in the luminaires having to be arranged accordingly, e.g. the arrangement of downlights above a seating area or the positioning of downlights and floodlights in a modern control room. Uniform lighting will require the luminaires to be arranged regularly across the area.

The lighting layout may also depend on the form of the ceiling; existing ceiling grids and modules, but also ceiling joists or other ceiling shapes form structures that have to be taken into account when planning the lighting layout. In some cases it is also necessary to coordinate planning with the engineers responsible for air-conditioning and acoustics to ensure that the cabling installation is carried out safely and that the ceiling appearance is acceptable.

The lighting layout should not be based entirely on technical or functional conditions; in spite of all the preconditions there is wide scope for arranging the luminaires in accordance with the design concept. The lighting should not be confined by purely technical considerations, but also take into account the aesthetics of ceiling design. In quantitative lighting design it has become common practice to

plan the lighting layout of ceiling-mounted luminaires to produce a completely uniform grid, with the aim of providing uniformly distributed lighting. By superimposing light distribution patterns it is possible to produce uniform lighting also by means of a differentiated lighting layout. On the other hand, differentiated lighting can also be achieved with a uniform arrangement of various luminaires. Consequently, there is no direct link between lighting layout and lighting effect; by exploiting the wide range of luminaires available it is possible to achieve a designed pattern of lighting effects using a variety of lighting layouts. The lighting design should make use of this scope producing ceiling designs that combine functional lighting with an aesthetic lighting layout that relates to the architecture.

It is neither possible nor practical to present a comprehensive formal language for the design of lighting layouts; the ceiling design of a lighting installation is developed in each specific case from the correlation of lighting tasks, technical prerequisites, architectural structures and design ideas. It is, however, possible to describe a series of basic concepts which show some general approaches to the form and design of luminaire patterns on ceiling surfaces.

One approach is to consider the point as a basic design element. In the broadest sense the point can be any individual luminaire, or even any compact and spatially isolated group of luminaires. This category of design elements not only includes downlights, but also larger luminaires such as louvred luminaires and even groups of these individual elements, provided that their total surface area is small in relation to the overall surface of the ceiling.

The simplest layout of these points is a regular grid, in a parallel or staggered arrangement. A regular pattern of identical luminaires can easily result in a monotonous ceiling appearance, plus the fact that differentiated lighting is practically out of the question. An alternating grid of different individual luminaires or luminaire combinations can produce more interesting arrangements; in this case luminaires of the same or different types can then be purposefully combined. The use of different luminaire types, by alternating positioning or through combinations, allows the lighting qualities of a visual environment to be carefully controlled. A further step towards more complex design forms is the linear arrangement of point sources. In contrast to simple lighting layouts in grid patterns, the ceiling design in this case relates more closely to the architecture of the space – the ceiling is no longer simply covered with a grid of luminaires, but is designed along the lines dictated by the architectural

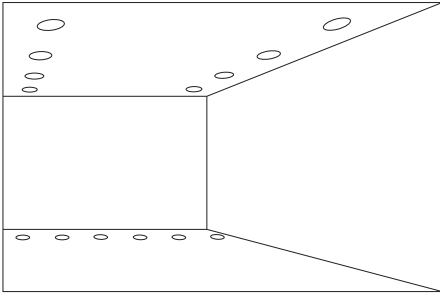

Linear arrangement of ceiling luminaires follows the length of the long walls. The end wall is illuminated separately, by a linear arrangement of recessed floor luminaires.

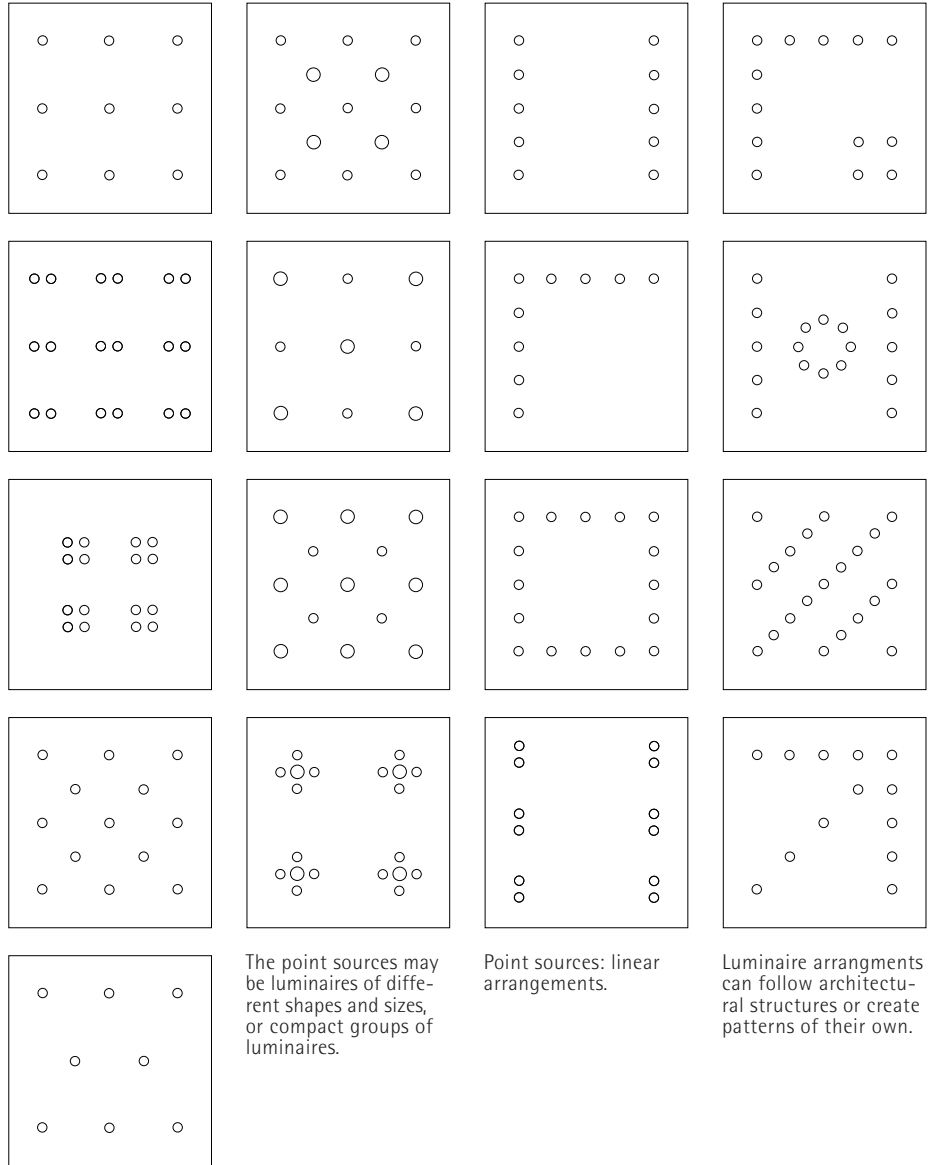

Point sources: regular and staggered layouts.

The point sources may be luminaires of different shapes and sizes, or compact groups of luminaires.

Point sources: linear arrangements.

Luminaire arrangements can follow architectural structures or create patterns of their own.

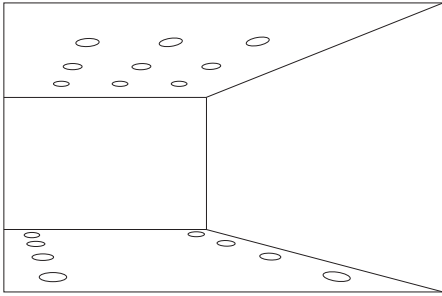

A regular arrangement of ceiling luminaires provides the ambient lighting in the space. The long walls are accentuated separately by recessed floor luminaires.

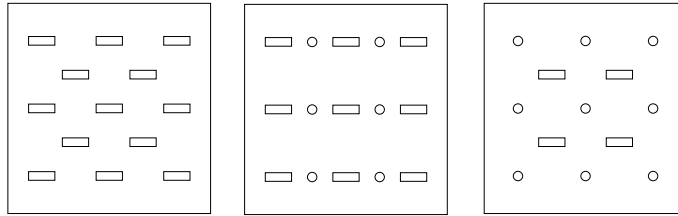
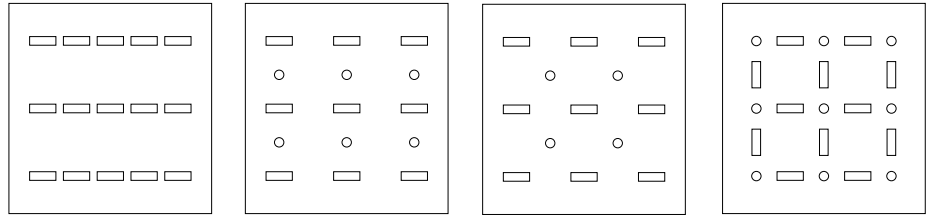
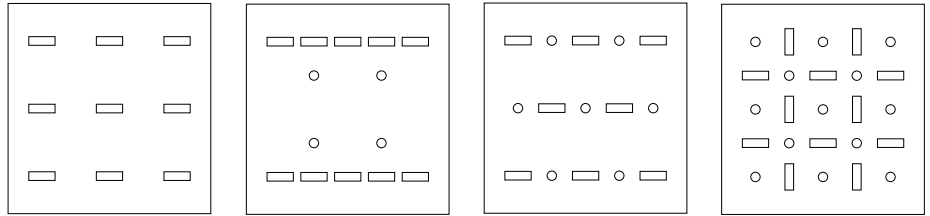

The combination of different elements gives rise to a broad range of design possibilities, including decorative solutions.

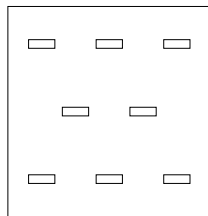

Linear and point elements: regular and staggered arrangements.

Linear elements: regular and staggered arrangements.

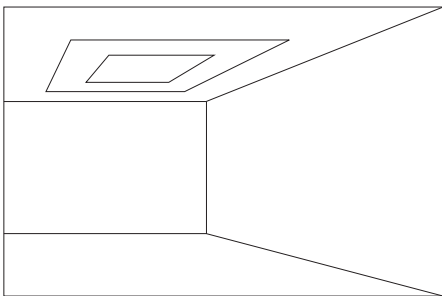

The rectangular arrangement of track is in line with the form of the space. This allows flexible lighting of all wall surfaces and accentuating of objects in the space.

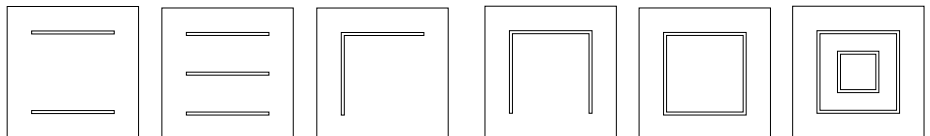

Linear structures: linear and rectangular arrangements of track.

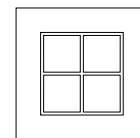

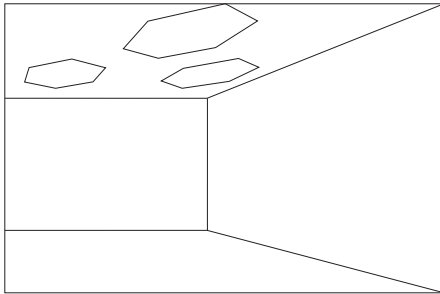

An arrangement of several hexagonal light structures subdivides the ceiling area irrespective of the surrounding architecture and becomes an active design element in the space.

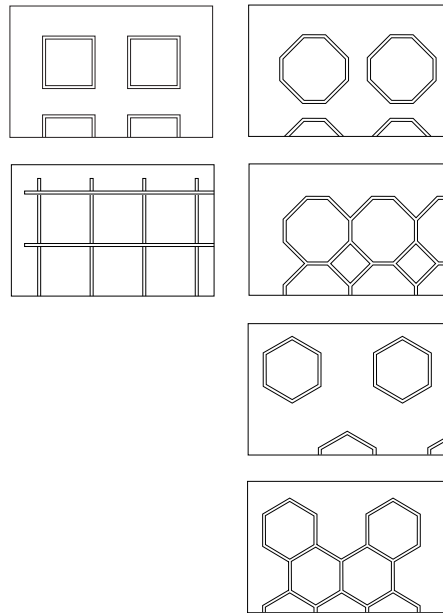

Light structures using 90°, 135° and 120° angles in arrangements: individual and combined structures.

form of the space. This may involve following the existing lines or purposefully arranging the luminaires in contrast to the existing formal language. Linear arrangements allow greater design scope, but do entail more stringent design requirements. As the linear arrangement of the luminaires does not necessarily relate to an actual line – the course a wall follows, ceiling projections or joists – the luminaire arrangement can only be created on the basis of the perception of gestalt. These laws of gestalt must receive special attention during the planning phase. The crucial criteria are the proximity of the luminaires and their equidistance.

Whereas linear arrangements consisting of series of points are only produced indirectly by the perception of the gestalt, they can be directly formed of linear elements. These linear elements can be particular types of luminaires, e.g. louvred luminaires, or even trunking systems. Continuous systems, light structures and almost all track arrangements or other trunking systems belong in this design category.

The formal language of linear arrangements is identical to that of rows of points. As the visual forms produced when linear luminaires are used are real and not only implied, more complex arrangements can be planned with no danger of distortion through perception. Creative

design allows both the alternating application of different luminaire forms and the use of spotlights on lighting structures or trunking systems. This allows differentiated lighting without individual luminaires disturbing the intrinsic form of the structure.

The application of linear elements also allows the transition from linear arrangements to more planar layouts. Light structures and trunking systems are particularly suitable in this regard. The formal language of such networking depends primarily on the connectors available for the specific structures. Adjustable connectors allow specially variable design. In general, connectors are available with fixed angles of 90° and 45°, 120° and 60°. Each of these angles can produce a wide range of forms, from rectangular forms at angles of 90° to honeycomb-shaped arrangements at angles of 120°.

Apart from basic design concepts it is possible to compile a set of general rules for some aspects of lighting layouts; in the case of regular lighting layouts this applies above all for the distances between the luminaires and from the walls.

For ceiling-mounted downlights the distance to the wall should be about half the distance between the downlights. In the case of wallwashers the recommended distance to the wall is around one third of the room height, the distance be-

tween the wallwashers should not exceed one and a half times the distance to the wall.

When illuminating paintings or sculptures using spotlights, the luminaires should be arranged so that the angle of incidence of the light is approximately 30°, the so-called "museum angle"; this produces maximum vertical lighting and avoids reflected glare that may disturb the observer.

3.3 Practical planning

3.3.3 Lighting layouts

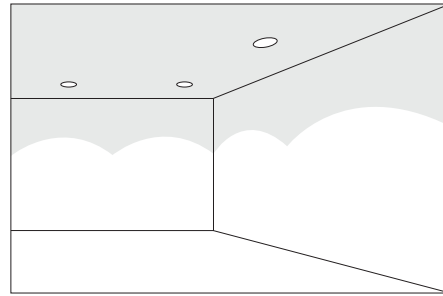
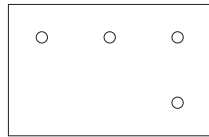

The recommended distance of downlights to the wall is generally half the distance between the downlights. Corner-mounted luminaires should be mounted on the 45° line to produce identical scallops on both walls.

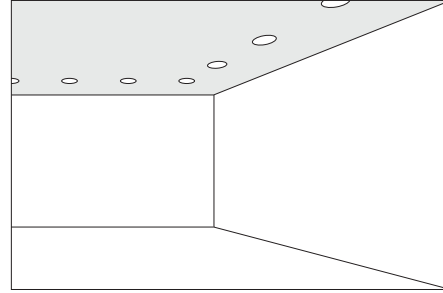
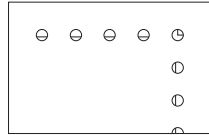

The distance of wall-washers and washlights from the wall should be 1/3 of the room height; the distance between the luminaires themselves should not exceed one and a half times the distance to the wall.

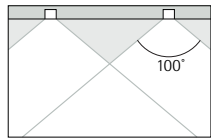
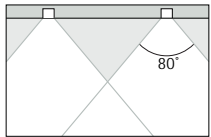
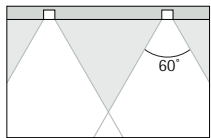

Overlapping light beams (beam spreads 60°, 80° and 100°) on the working plane at a spacing to height to height ratio of 1:1.

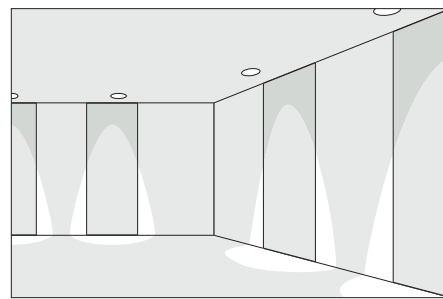
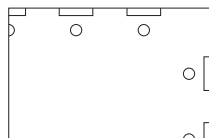

In spaces with dominant architectural features the lighting layout should harmonize with the architectural elements.

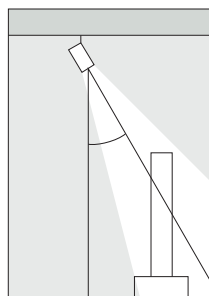
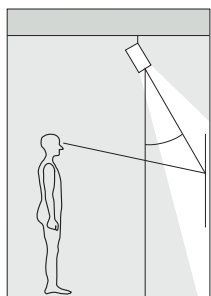

The optimum angle of incidence for the illumination of paintings and sculptures is 30°.

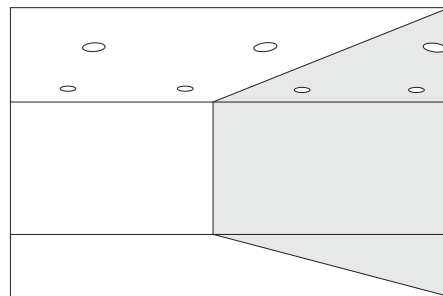

In the case of mirror walls the lighting layout should be planned such that the arrangement of luminaires appears consistent in the mirror image.

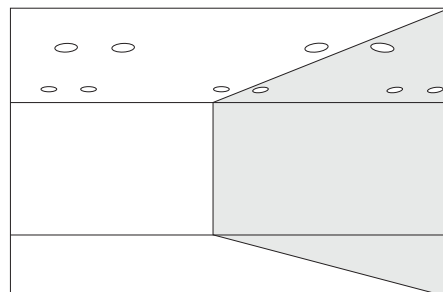

Critical areas (excluded zones) for VDT workstations (left), horizontal visual tasks (centre) and vertical visual tasks (right). Luminances falling on the visual tasks from the zones indicated result in reflected glare.

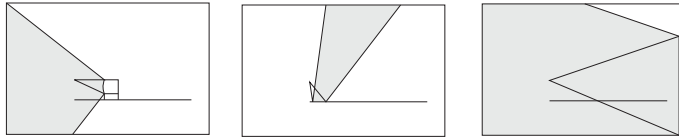

Lighting solutions for horizontal visual tasks free of reflected glare: direct lighting using luminaires positioned outside the excluded zone, indirect lighting.

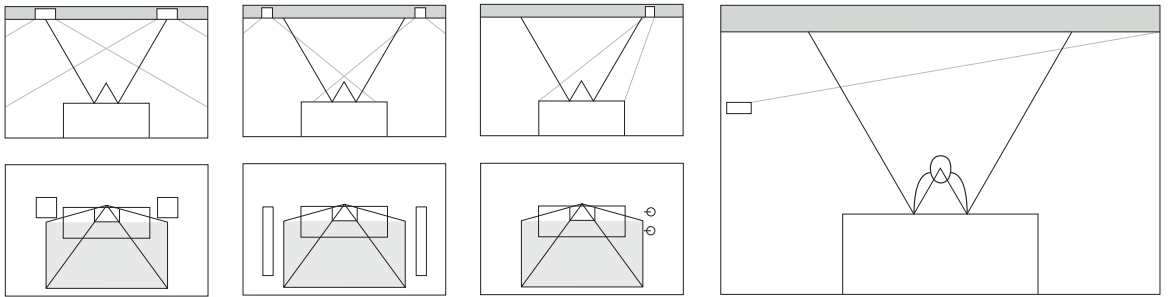

Lighting solutions for vertical visual tasks free of reflected glare: (from left to right): if the reflective surface is arranged transversely, the luminaires can be mounted in front of the excluded ceiling zone. If the reflective surface is arranged vertically, then next to

the excluded ceiling zone (centre). If the entire wall surface is reflective, the luminaires must be mounted within the excluded zone; the cut-off angles must be planned such that the observer is not disturbed by reflected light.

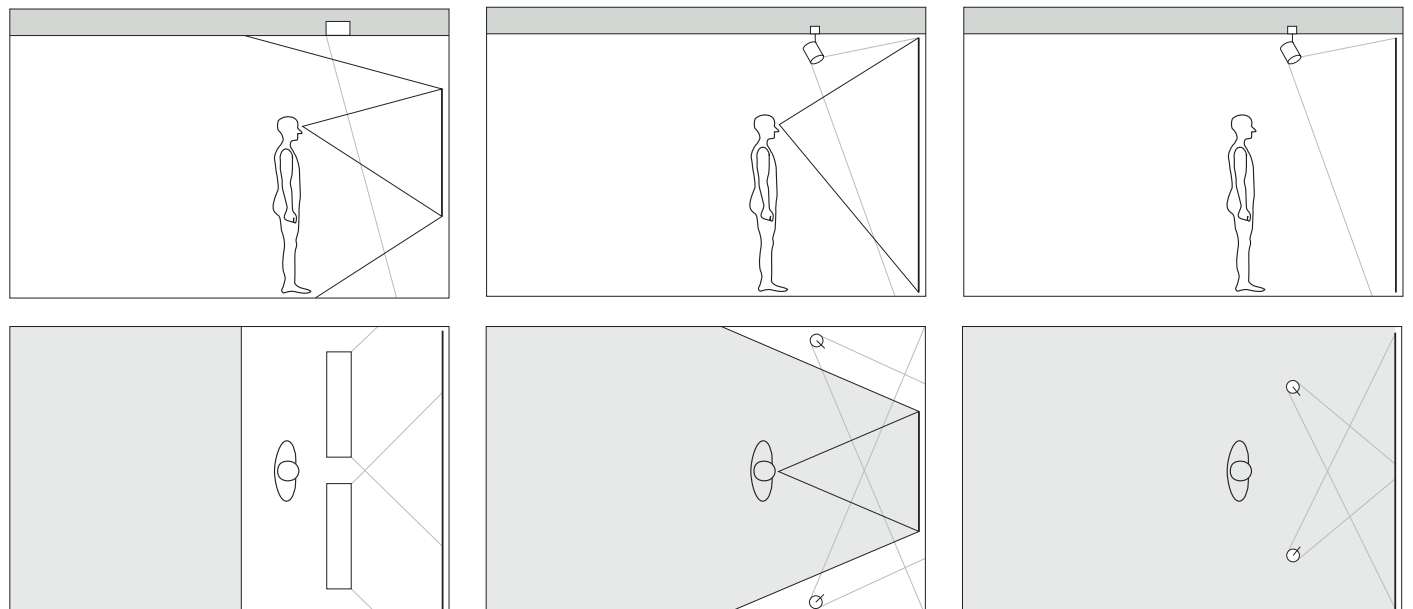

3.3.4 Switching and lighting control

In the simplest case a lighting installation may consist of a single circuit. An installation of this kind can only be switched on and off and therefore only produces one lighting arrangement. Lighting frequently has to meet changing requirements, however, which means that additional control options must be provided.

Even if the space is always used in the same way, daylight conditions change radically during the course of the day. In the daytime artificial lighting must compete with sunlight, and our perception is adapted to high levels of brightness on the room surfaces. In the evening and at night lower illuminances and pools of light are accepted. This fact presents a significant planning criterion for a wide range of lighting tasks. In some cases, e.g. the lighting of exclusive restaurants, it is likely to be a prime consideration and require a lighting installation to meet both environmental situations.

As the use of the space changes, so the demand for variability and flexibility will increase. For example, the lighting provided in lecture rooms should consist of accent lighting for podium discussions with comparatively high levels of lighting in the auditorium; the lighting installation should also be suitable for slide presentations, where the speaker is seen in accent lighting and the ambient light is just sufficient for the people in the audience to take notes. If films or videos are to be shown, lighting control requirements will be extended accordingly.

In many cases, the creation of a differentiated lighting installation cannot be restricted to the development of a concept that meets a clearly defined set of requirements with an equally fixed, exclusively spatially differentiated lighting layout. Changing environmental conditions and different uses may demand the creation of temporal differentiation – that is to say, the transitions from a fixed lighting situation to a series of optional light scenes that are dependent on the time of day or given situations.

The first way of creating a light scene is to arrange individual luminaires in an installation to form groups that can be switched separately. These groups may consist of lighting arrangements that are completely independent of one another and designed to fulfil different lighting tasks, and individual components of an overall installation, which may be operated separately or together.

As a rule, the definition of a light scene does not simply cover the simple switching of groups of luminaires, but also involves varying the levels of brightness. Besides the switching of separate circuits, dimming equipment is required for the separate groups of luminaires.

Once the required level of brightness has been identified, it is then possible to plan differentiated lighting to meet specific requirements. The potential range of light scenes increases considerably even if the number of luminaires and the switching remains the same. The distribution and level of brightness of the lighting can be accurately controlled in individual areas within the space and the overall level of a light scene adjusted to the changing requirements – e.g. to the time of day or the daylight available.

The switching and dimming of individual groups of luminaires can be controlled manually, either using conventional switches and controllers or by infrared remote control, which allows groups of luminaires to be controlled even if there are only a minimal number of circuits.

This method still makes it difficult to reproduce defined light scenes or to adjust them at a fixed rate. If the requirements the lighting control has to meet are complex, or if a larger number of groups of luminaires are to be controlled, it is advisable to use an electronic control system. This allows precisely defined light scenes to be recalled at the touch of a button, or a change of light scene to be programmed to take place over a given period of time. It is also possible to control the light in accordance with daylight or the use of the spaces using sensors; other functions apart from lighting can also be operated by coupling the lighting control system with the building management system.

Further developments in lighting control can also be used to create theatrical effects in architectural lighting. Besides controlling brightness, this may include changing luminous colour, beam spread or even the direction of the luminaires.

Diagram of the lighting layout in a multifunctional space with the luminaires allocated to different circuits.
Circuits: 1 wall lighting; 2, 3 general lighting; 4 decorative components; 5-10 track.

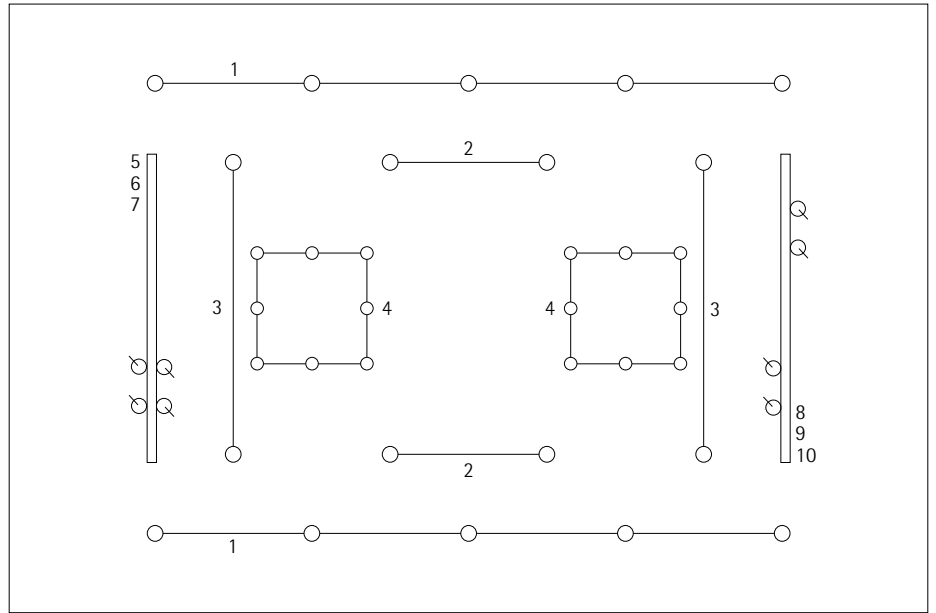

Switching and dimming status of circuits 1-10 for different light scenes:

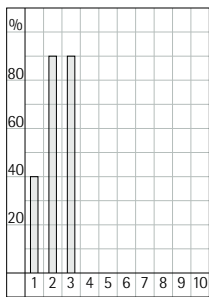

Conference: high level of horizontal general lighting, average level on walls.

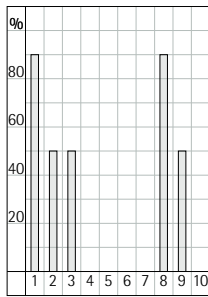

Lecture: reduced general lighting, emphasis of wall surfaces, accent light on speaker.

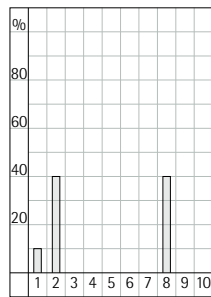

Slide presentation: general lighting reduced for people to take notes by, minimum wall lighting, accent light on speaker.

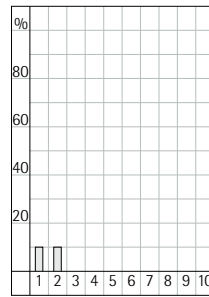

Film or video projections: minimum general lighting.

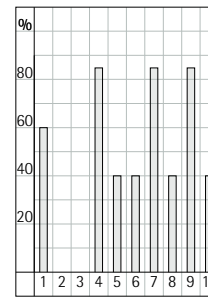

Dining: low wall lighting, festive atmosphere produced by decorative components 4, accentuation of points of interest on tables and buffet using track-mounted spotlights.

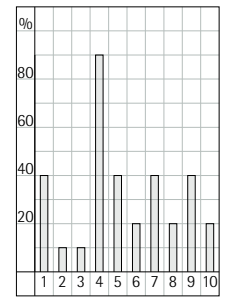

Reception: room proportions are emphasised by the wall lighting, festive atmosphere due to decorative components 4, accentuation of points of interest in the space using track-mounted spotlights.

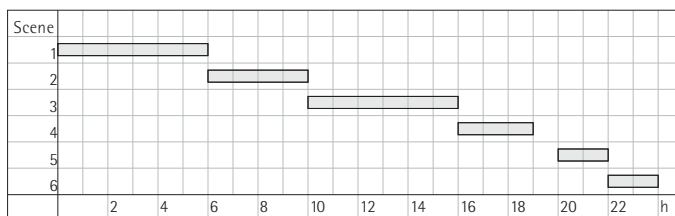

Time-related light scenes in a hotel foyer. Transition between light scenes with fading times of up to 15 mins.

Scene 1
Reduced night-time lighting
Scene 2
Morning lighting
Scene 3
Daylight-related lighting to supplement daylight

Scene 4
Warm early evening lighting
Scene 5
Festive lighting for the evening
Scene 6
Reduced festive lighting

3.3.5 Installation

A wide range of luminaire types – e.g. spotlights, combined uplights-downlights and light structures – are exclusively designed to be installed as additive elements. They may be mounted on track or carrier systems, suspended from the ceiling (pendant luminaires) or surface mounted onto the wall or ceiling. The range of downlights and louvred luminaires available is so vast and their designs differ substantially, which means that numerous modes of installation are required. In the case of wall or floor mounting the luminaires may be surface-mounted or recessed into the fabric of the building. Ceiling mounting allows a variety of possibilities: pendant mounting, surface mounting, semi-recessed or recessed mounting. Light structures can be handled in a similar way, i.e. depending on their design, they can either be surface-mounted or recessed.

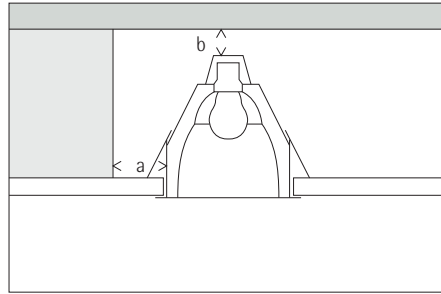

Installation of recessed luminaires according to the European standard (EN 60598): the minimum distance a between the sides of the luminaires and building surfaces must be 50–75 mm. Between the upper surface of

the luminaire and building surfaces b there must be at least 25 mm. In the case of luminaires with an ∇ mark no gap is required between the upper surface and the building surface.

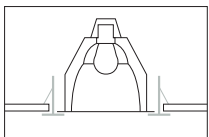
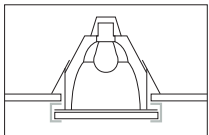
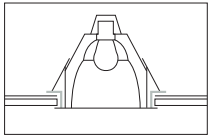

Methods of mounting recessed luminaires (from the top downwards): mounting into plaster ceilings using a plaster ring, mounting into dry ceilings with luminaire attachment, mounting from above with mounting ring.

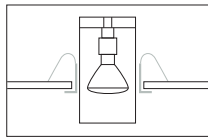
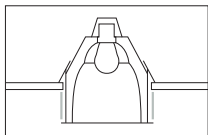

Semi-recessed mounting using a spacer ring (above), or surface-mounted luminaires using a mounting ring (below).

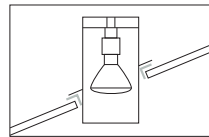
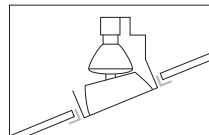
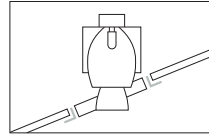

Mounting recessed luminaires in inclined ceilings: tiltable double-focus downlight (above), recessed directional spotlight (centre) and downlight with special accessories (below).

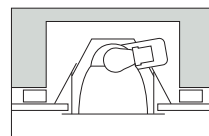
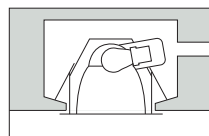
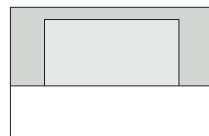
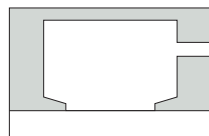

Mounting recessed luminaires using a concrete housing (left), with a polystyrene block and a substructure (right).

3.3.5.1 Ceiling mounting

Luminaires can be recessed into concrete ceilings or suspended ceilings; the mode of recessing depends essentially on the specific ceiling type.

For recessed mounting into concrete ceilings the luminaire apertures are created when the ceiling is cast. One method for providing the apertures is to fix polystyrene blocks in the form of the required space onto the concrete shuttering; when the ceiling has been cast the blocks are removed, providing apertures of the required size. Another possibility is to install prefabricated housings, which are also attached onto the concrete shuttering and remain in the ceiling. It is essential to check that the planned lighting layout is compatible with the structure of the ceiling, whether specific installation locations must be avoided, for example, due to concealed joists or whether the reinforcement of the ceiling should be coordinated with the lighting layout.

Shaped concrete ceilings, e.g. moulded coffer ceilings, can be used as effective lighting elements. This may be to produce indirect lighting components and glare-free lighting, and will inevitably accentuate the ceiling structure. The luminaires can be installed in the coffers; to illuminate the sides of the coffers; the more conventional method is to install the luminaire in the coffer as a pendant fitting, providing direct lighting in the space and indirect lighting through the illumination of the ceiling coffer.

The recessed mounting of luminaires into suspended ceilings varies depending on the type of ceiling system.

In the case of flat suspended ceilings, e.g. plasterboard ceilings, the luminaires can almost always be arranged irrespective of the suspended ceiling grid. The luminaires are fixed firmly in the ceiling apertures provided; if necessary, the weight of the luminaire must be carried by additional suspensions fixed onto or in close proximity to the luminaire. If the ceiling is to be plastered, plaster rings are required for the luminaire apertures.

There are various versions of suspended ceilings available made of individual panels. They vary according to the material, grid dimensions and load-bearing capacity. The ceiling grid will automatically determine the possible layout, which is to be taken into account when positioning the luminaires.

Smaller luminaires, such as downlights, can be installed in ceiling panels, following the same mounting instructions as for flat ceilings. Larger luminaires, especially louvred luminaires, can be installed in place of individual ceiling panels; different modes of installation are required for mounting into different ceiling types. Metal plank ceilings present a special case: luminaires are not only installed between the ceiling panels, but also from the carrier system. Suspended ceilings made of individual panels may require the luminaires to have additional brackets to take the weight of the luminaires.

For open grid ceilings and honeycomb-grid ceilings there are recessed cassettes available complete with suitable apertures for the recessed mounting of downlights. The cassettes are dimensioned to suit the respective ceiling grids. They can replace a ceiling panel or allow the installation of luminaires between ceiling panels which would otherwise not be suitable to take the static load.

Semi-recessed mounting of luminaires is similar to recessed mounting, with the recessed depth naturally being shallower. Some luminaire types are specifically designed for semi-recessed mounting. With specially developed recess accessories, luminaires for both recessed and surface mounting can be adapted for semi-recessed mounting.

Pendant mounting can be effected in a variety of ways. Light-weight luminaires are usually suspended by the connecting cable. Heavier luminaires require a separate suspension device. This may take the form of a stranded wire cable or a pendant tube, which generally contains the connecting cable.

Recessed mounting of louvred luminaires into various ceiling systems (from the top downwards): recessed mounting into ceilings with exposed and concealed profiles, recessed mounting into flat, suspended ceilings and panelled ceilings.

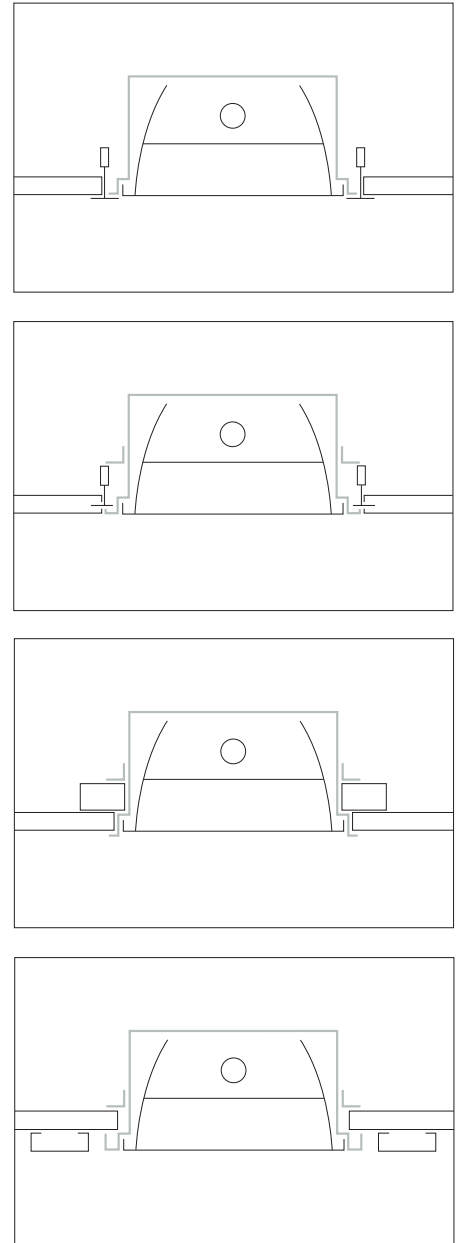

Pendant mounting of louvred luminaires: with two suspension points, four suspension points, two and four suspension cables connected to one ceiling mounting plate.

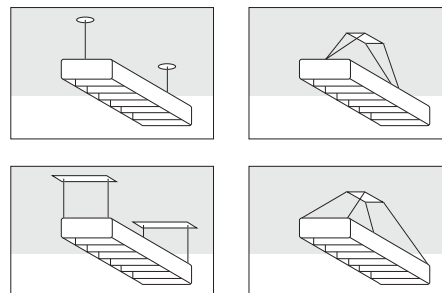

3.3 Practical planning

3.3.6 Calculations

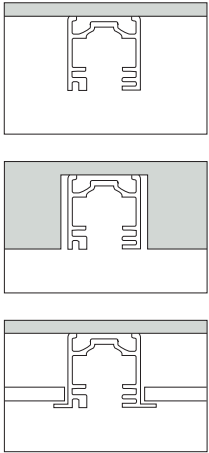

Mounting track (from the top downwards): surface-mounted, for recessed mounting into solid ceilings, suspended flanged track with ceiling panels.

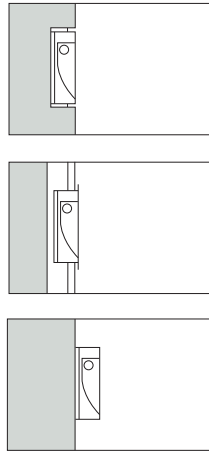

Mounting of wall luminaires (from the top downwards): recessed mounting into masonry, hollow walls, surface-mounting onto walls.

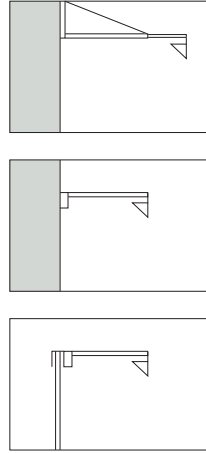

Luminaires mounted on wall brackets (from the top downwards): cantilever bracket, bracket with integral transformer, bracket for partition walls.

3.3.5.2 Wall and floor mounting

Luminaires can be mounted onto wall surfaces or recessed into the wall. The latter can be in either concrete or hollow walls. Installation of floor-mounted luminaires can only be recessed. The luminaire cover must be robust and provide protection against the ingress of moisture.

3.3.5.3 Suspension systems

Suspension systems are generally designed for pendant mounting from the ceiling, in the same way as for luminaires using wire cables or pendant tubes. In some cases it is also possible to mount carrier systems onto walls by means of cantilever brackets.

Track can be mounted in a variety of ways. It can be suspended from the ceiling or mounted directly onto walls or ceiling. Recessed mounting into walls or ceiling is also possible in the case of certain versions or it can be used as part of a carrier system in a suspended ceiling.

Wide-span carrier systems are a special case. They can be suspended from the ceiling, spanned between two walls or erected as a free-standing structure.

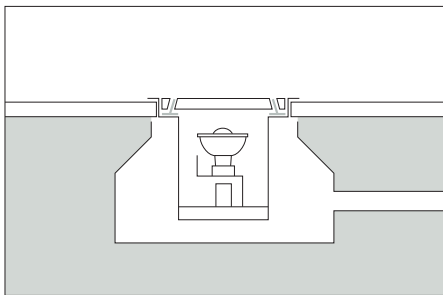

Installation of recessed floor-mounted luminaires: the housing is inserted into the floor. The luminaire itself is secured into the housing and is flush with the floor surface.

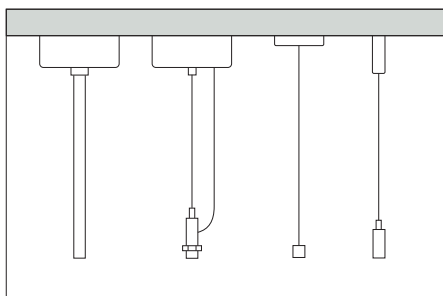

Pendant mounting of track and structural systems (from left to right): pendant tube with ceiling canopy for electrical connection, wire suspension with ceiling canopy for electrical connection, wire suspension with adjustable height, wire suspension with adjustable height.

3.3.6 Calculations

When planning a lighting installation it is necessary to perform a series of calculations. In general, these refer to the average illuminance required or exact illuminance levels in specific parts of the space. It may also be of significance to calculate the luminance of specific parts of the space, or different lighting qualities, such as shadow formation and contrast rendition, or the costs for a lighting installation.

3.3.6.1 Utilisation factor method

The utilisation factor method is used to acquire a rough estimation of the dimensioning of a lighting installation; it allows the designer to determine the number of luminaires required to produce the defined illuminance on the working plane, or, vice versa, the illuminance on the working plane produced by a given number of luminaires. This method does not provide exact illuminances at specific points in the space, which means that other methods must be applied to calculate the uniformity of a lighting installation or to determine illuminance levels at specific points. The utilisation factor method is based on the fact that the average horizontal illuminance for a space of a given size can be calculated from the overall luminous flux produced by the luminaires installed, the light output ratio and the utilisation. In general terms, it describes

the portion of luminous flux emitted by the light sources, which falls on the working plane after interaction with luminaires and room surfaces. The deciding factor in this calculation is the utilisation, which is derived from the geometry of the space, the reflectance of the room surfaces and the efficiency and the distribution characteristics of the luminaires used.

To be able to calculate the appropriate utilisation in each individual case, there are tables available, which contain the utilisation of a standardised space with changing room geometry, changing reflection factors and luminaires with a variety of distribution characteristics. The basic, idealised space is presumed to be empty and of regular shape and proportions, i.e. rectangular and having the ratio of length to width approx. 1.6 to 1. The luminaires are presumed to be arranged in a regular pattern on the ceiling, either mounted directly onto the ceiling or suspended from the ceiling. These standardised values have a decisive influence on the accuracy of the calculations for the application. If the conditions inherent in the basic concept are in line with those in the model space, the results will be reasonably accurate. The more the basic conditions deviate from the standardised conditions, e.g. if the lighting layout is distinctly asymmetrical, it must be accepted that an increasing number of errors will occur in the calculation.

When using the utilisation factor method an appropriate utilisation table has to be used for each type of luminaire. The corresponding standard luminaire classification table can be used for this purpose. Luminaire classification in accordance with DIN 5040 and the German Lighting Engineering Society is made up of one letter and two digits, a combination indicates a number of luminaire qualities. The letter defines the luminaire class and indicates whether a luminaire emits light primarily in the upper or lower part of the space, i.e. direct or indirect lighting. The first digit refers to the proportion of luminous flux falling onto the working plane in the lower part of the space. The second digit indicates the corresponding value for the upper part of the space. It is often not necessary to use the standard table of luminaire classification, as exact tables are supplied by the lighting manufacturers.

$$E_N = V \cdot \frac{n \cdot \Phi \cdot \eta_R \cdot \eta_{LB}}{a \cdot b}$$

$$n = \frac{1}{V} \cdot \frac{E_n \cdot a \cdot b}{\Phi \cdot \eta_R \cdot \eta_{LB}}$$

Utilisation factor method: formula for calculating the nominal illuminance E_N for a given number of luminaires or the number of luminaires n for a given illuminance.

E_N (lx)	Nominal illuminance
n	Number of luminaires
a (m)	Length of space
b (m)	Width of space
Φ (lm)	Luminous flux per luminaire
η_R	Utilance
η_{LB}	Light output ratio
V	Light loss factor

$$\eta_{LB} = \frac{\Phi_{Le}}{\Phi_{La}}$$

Light output ratio η_{LB} : ratio of the luminous flux emitted by a luminaire Φ_{Le} under operating conditions to the luminous flux of the lamp Φ_{La} .

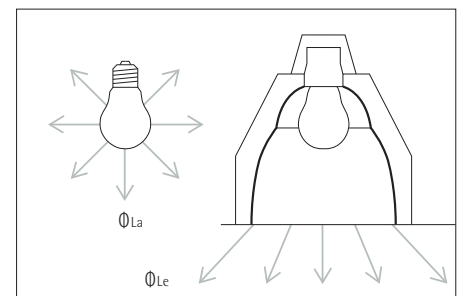

Typical light output ratios η_{LB} for direct luminaires with various cut-off angles and lamp types.

Luminaire	Lamp type	η_{LB}
Louvred luminaire 30°	T26	0.65–0.75
Louvred luminaire 40°	T26	0.55–0.65
Louvred lumin. square	TC	0.50–0.70
Downlight 30°	TC	0.60–0.70
Downlight 40°	TC	0.50–0.60
Downlight 30°	A/QT	0.70–0.75
Downlight 40°	A/QT	0.60–0.70

3.3 Practical planning

3.3.6 Calculations

$$k = \frac{a \cdot b}{h(a+b)}$$

$$k = 1.5 \cdot \frac{a \cdot b}{h'(a+b)}$$

The room index k describes the influence of the room geometry on the utilisation. It is calculated from the length and width of the room, and the height h above the

working plane under direct luminaires (room index k) and height h' above the working plane under predominantly indirect luminaires (room index k').

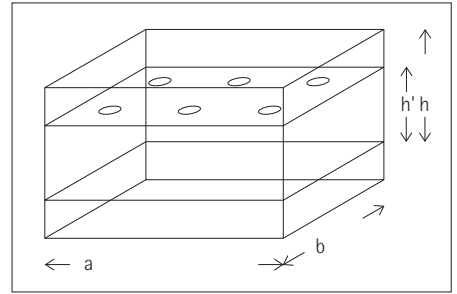

Utilance values η_R for typical interior luminaires (from the top downwards): narrow-beam luminaires (A 60, DIN 5040)

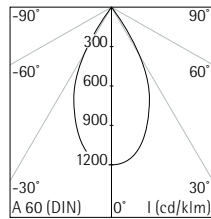

η_R	φ_C	0.70	0.70	0.70	0.70	0.70	0.50	0.50	0.20	0.00
	φ_W	0.70	0.50	0.50	0.20	0.20	0.50	0.20	0.20	0.00
	φ_F	0.50	0.20	0.10	0.20	0.10	0.10	0.10	0.10	0.00
k										
0.60		1.04	0.86	0.84	0.81	0.80	0.84	0.80	0.80	0.78
1.00		1.17	0.95	0.92	0.90	0.88	0.91	0.88	0.87	0.85
1.25		1.26	1.06	0.98	0.98	0.95	0.97	0.95	0.94	0.92
1.50		1.30	1.04	1.00	1.00	0.97	0.99	0.97	0.96	0.94
2.00		1.35	1.07	1.02	1.04	1.00	1.01	0.99	0.98	0.97
2.50		1.38	1.09	1.03	1.06	1.02	1.02	1.01	0.99	0.97
3.00		1.41	1.11	1.05	1.08	1.03	1.03	1.02	1.00	0.99
4.00		1.43	1.11	1.05	1.09	1.03	1.03	1.02	1.00	0.98

Wide-beam luminaires (A 40, DIN 5040)

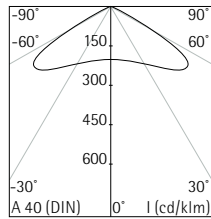

η_R	φ_C	0.70	0.70	0.70	0.70	0.70	0.50	0.50	0.20	0.00
	φ_W	0.70	0.50	0.50	0.20	0.20	0.50	0.20	0.20	0.00
	φ_F	0.50	0.20	0.10	0.20	0.10	0.10	0.10	0.10	0.00
k										
0.60		0.63	0.43	0.42	0.31	0.31	0.41	0.31	0.30	0.26
1.00		0.87	0.63	0.61	0.51	0.50	0.59	0.49	0.49	0.44
1.25		0.99	0.73	0.70	0.62	0.61	0.68	0.60	0.59	0.55
1.50		1.06	0.79	0.76	0.69	0.67	0.74	0.66	0.65	0.61
2.00		1.17	0.88	0.83	0.79	0.76	0.81	0.75	0.73	0.70
2.50		1.23	0.93	0.89	0.86	0.82	0.86	0.81	0.79	0.76
3.00		1.29	0.98	0.92	0.91	0.87	0.90	0.86	0.84	0.81
4.00		1.34	1.02	0.96	0.96	0.91	0.94	0.90	0.88	0.85

Indirect luminaires (E 12, DIN 5040)

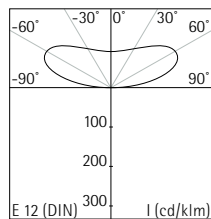

η_R	φ_C	0.70	0.70	0.70	0.70	0.70	0.50	0.50	0.20	0.00
	φ_W	0.70	0.50	0.50	0.20	0.20	0.50	0.20	0.20	0.00
	φ_F	0.50	0.20	0.10	0.20	0.10	0.10	0.10	0.10	0.00
k'										
0.60		0.27	0.14	0.14	0.07	0.07	0.11	0.05	0.03	0
1.00		0.43	0.25	0.25	0.15	0.15	0.19	0.11	0.05	0
1.25		0.50	0.31	0.30	0.20	0.20	0.23	0.14	0.07	0
1.50		0.56	0.36	0.35	0.25	0.24	0.26	0.18	0.08	0
2.00		0.65	0.43	0.42	0.32	0.31	0.30	0.22	0.10	0
2.50		0.71	0.49	0.47	0.38	0.37	0.34	0.26	0.11	0
3.00		0.76	0.53	0.51	0.43	0.41	0.36	0.29	0.12	0
4.00		0.82	0.58	0.55	0.49	0.47	0.40	0.34	0.14	0

The appropriate utilance is calculated from the specific room index k (k') and the combination of the reflectance factors of ceiling (φ_C), walls (φ_W) and floor (φ_F).

V	Degree of Deterioration
0.8	Normal deterioration
0.7	Increased deterioration
0.6	Heavy deterioration

Light loss factor V in relation to the degree of deterioration in the space.

When the appropriate table has been drawn up, the room index k can be determined from the room geometry. The utilisation can then be read off the table from the column showing the corresponding room index and line showing the appropriate combination of reflectance factors or, for greater accuracy, calculated through interpolation. The average horizontal illuminance is the result of the total luminous flux produced by all the lamps installed per room surface in the space, corrected by the light output ratio (which is provided by the lighting manufacturer), by the calculated utilisation and light loss factor V , which takes into account the ageing of the lighting installation and is usually taken to be 0.8. Should a lighting installation consist of several types of luminaire of varying classification, e.g. wide-beam lighting provided by louvred luminaires and a narrow-beam component provided by downlights for incandescent lamps, then the illuminance has to be calculated separately for each component and then added.

There are computer software programs available for calculating the utilisation factor. They not only calculate the illuminance, but also locate the appropriate tables and can handle the complex interpolation between the individual tables or values contained in the tables, if required.

3.3.6.2 Planning based on specific connected load

Another method of providing the rough dimensioning of a lighting installation derived from the utilisation factor method is based on the specific connected load available. This method allows the calculation of the required connected load for an average illuminance provided by a given luminaire and light source, or vice versa, the average illuminance that can be obtained given a specific connected load and a light source.

Planning a lighting installation based on a specified connected load relies on the fact that every type light source has a specific luminous efficacy practically irrespective of the power consumption. When using the utilisation factor method it is possible to substitute the overall luminous flux by the connected load corrected by the respective luminous efficacy. Taking this as a basis it is possible to calculate the connected load per m^2 which is required for a given combination of luminaire and light source to obtain an average illuminance of 100 lx in a space with standardised room geometry and reflectance factors. Values obtained in this way only apply with accuracy to the particular standard room. A correction factor must be included in the calculations to take account of conditions that deviate from the standard.

$$n = \frac{1}{f} \cdot \frac{P^* \cdot E_N \cdot a \cdot b}{100 \cdot P_L}$$

$$E_N = f \cdot \frac{100 \cdot n \cdot P_L}{P^* \cdot a \cdot b}$$

Lighting calculations based on a specific connected load of lamps (P^*). Formulae for calculating the nominal illuminance E_N for a given number of luminaires, or the number of luminaires required n for a given illuminance.

E_N (lx)	Nominal illuminance
n	Number of luminaires
P_L (W)	Connected power for one luminaire incl. control gear
P^* (W/m ² · 100 lx)	Specific connected load
f	Correction factor
a (m)	Length of room
b (m)	Width of room

Lamp	P^* (W/m ² · 100 lx)
A	12
QT	10
T	3
TC	4
HME	5
HIT	4

Standard values for specific connected load P^* for different lamp types in direct luminaires.

f	A (m ²)	h (m)	ϱ_C	ϱ_W	ϱ_F
			0.70	0.50	0.00
			0.50	0.20	0.00
			0.20	0.10	0.00
	20	≤ 3	0.75	0.65	0.60
	50		0.90	0.80	0.75
	≥ 100		1.00	0.90	0.85
	20	3–5	0.55	0.45	0.40
	50		0.75	0.65	0.60
	≥ 100		0.90	0.80	0.75
	50	≥ 5	0.55	0.45	0.40
	≥ 100		0.75	0.60	0.60

Correction factor f takes into account the effect of the room geometry and the reflectance factors on the illuminance or number of luminaires. The appropriate value

is calculated from the basic area A , the room height h and the reflectance factor of the ceiling (ϱ_C), walls (ϱ_W) and floor (ϱ_F).

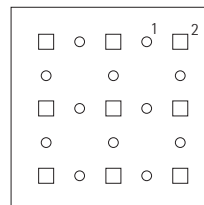

Room data

Length $a = 10$ m
Width $b = 10$ m
Height $h = 3$ m
 $\varrho = 0.5/0.2/0.1$
 $f = 0.9$

Example of a rough calculation of the illuminance for a room with a combination of two different luminaire types.

Luminaire type 1 (A)

$$n = 12$$

$$P_L = 100 \text{ W}$$

$$P^* = 12 \cdot \frac{\text{W}}{\text{m}^2 \cdot 100 \text{ lx}}$$

Luminaire type 2 (TC)

$$n = 9$$

$$P_L = 46 \text{ W}$$

$$(2 \cdot 18 \text{ W} + \text{ballast})$$

$$P^* = 4 \cdot \frac{\text{W}}{\text{m}^2 \cdot 100 \text{ lx}}$$

$$E_{N1} = 90 \text{ lx}$$

$$E_{N2} = 93.2 \text{ lx}$$

$$E_{\text{com}} = 183.2 \text{ lx}$$

Calculating illuminance at specific points. The relation between illuminance E at a specific point and the luminous intensity I of one luminaire (from the top downwards): horizontal

illuminance E_h directly below a luminaire. Horizontal illuminance E_h at an angle α to the luminaire. Vertical illuminance E_v at an angle α to the luminaire.

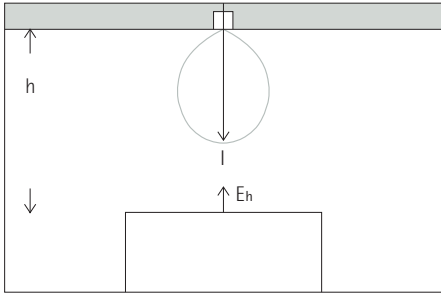

$$E_h = \frac{I}{h^2}$$

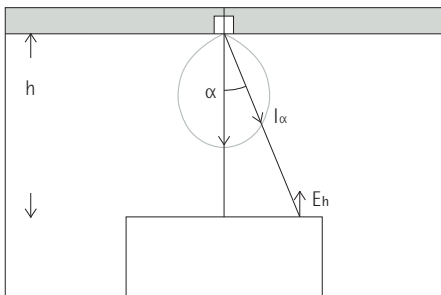

$$E_h = \frac{I_\alpha}{h^2} \cdot \cos^3 \alpha$$

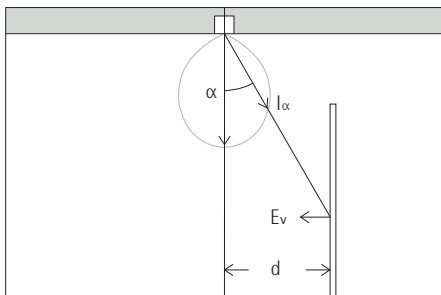

$$E_v = \frac{I_\alpha}{d^2} \cdot \cos^3 (90 - \alpha)$$

- [E] = lx
- [I] = cd
- [h] = m
- [d] = m

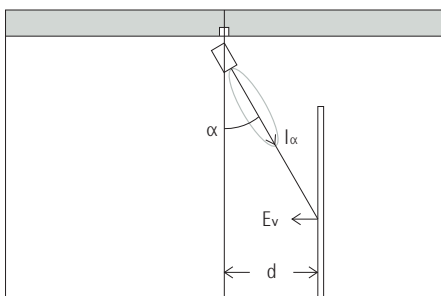

Formula for the rough calculation of the indirect illuminance components (E_{ind}). Using the overall luminous flux produced by all the luminaires installed in the space Φ_{Le} , the average reflectance φ_M and the sum A_{com} of all room surfaces.

$$E_{ind} = \frac{\Phi_{Le}}{A_{ges}} \cdot \frac{\varphi_M}{1 - \varphi_M}$$

A by-product of this method of calculation is that for each lamp type a typical value can be defined for the specific connected load. This means, for example, that a luminous flux of around 20000 lm can be obtained from conventional incandescent lamps with a connected load of 1500 W, without strict regard for whether ten 150 W lamps, fifteen 100 W lamps or twenty 75 W lamps are used. The connected power required for specific lamp types can be used for rough planning and, above all, to enable a quick comparison to be made of different light sources.

3.3.6.3 Point illuminance

In contrast to the utilisation factor method, which only allows average illuminances for an entire space to be calculated, using the inverse square law illuminance levels can be calculated for specific points in the space. The results in this case are very exact, errors only arise if light sources are incorrectly presumed to be point sources. Indirect components are not included in the calculation, but can be included through an additional calculation. The calculation of illuminance at specific points can be carried out for the lighting provided by one single luminaire or for situations where the contribution of several luminaires is to be taken into account.

The manual calculation of point illuminance at specific points can be applied for the lighting design of confined spaces illuminated by individual luminaires; calculations for numerous points within the space and a large number of luminaires take too much effort and are not justified. Computer software is generally used for calculating the illuminances for an entire space.

The basic function provided by these programs is the calculation of illuminances for all room surfaces, working planes or clearly defined zones, in which indirect lighting components are included in these calculations. Using this basic data it is possible to derive further values, such as the luminance of the illuminated areas, shadow formation or contrast rendition factors at specific points in the rooms.

Programs of this kind usually offer a variety of possibilities for the graphic presentation of the results, ranging from isolux diagrams and isoluminance diagrams for individual room surfaces or zones to three-dimensional renderings.

$$E_h = \frac{L \cdot A}{h^2} \cdot \cos^4 \epsilon$$

- [E] = lx
- [l] = cd/m²
- [h] = m
- [A] = m²

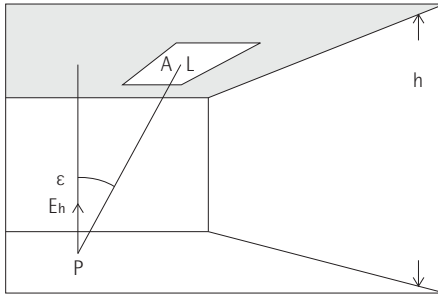

Horizontal illuminance E_h at point P, produced by luminous surface A of luminance L at angle ϵ .

$$E_h = \pi \cdot L \cdot \sin^2 \alpha$$

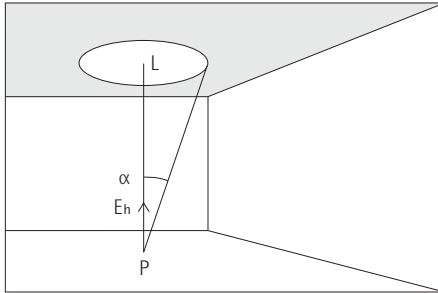

Horizontal illuminance E_h at point P, produced by a circular luminous surface of luminance L, whereby the surface extends to an angle 2α .

Calculating illuminances from the luminance of flat light sources.

$$E_h = \pi \cdot L$$

$$E_v = \frac{\pi}{2} \cdot L$$

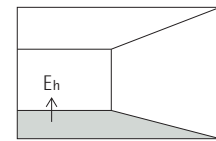

Horizontal illuminance E_h , produced by luminance L from one half of the space.

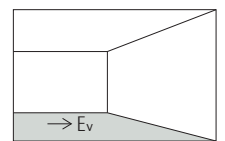

Vertical illuminance E_v , produced by luminance L from one half of the space.

3.3.6.4 Lighting costs

When calculating the costs for a lighting installation it is necessary to differentiate between the fixed costs and the variable costs. The fixed costs do not apply to the operating time of the lighting installation, they comprise the amortised costs for the luminaires, for their installation and cleaning. The variable costs are dependent on the operating time. They comprise costs for energy, material and wages for staff carrying out lamp replacement. On the basis of these values it is possible to calculate the different qualities of a lighting installation.

The annual costs of a lighting installation are of particular interest. It is often advisable to compare the economic efficiency of different lamp types in the planning phase. This data can be calculated either as annual costs or as costs for the production of a specific quantity of light. The pay-back time is important in both completely new projects and refurbishment projects, that is to say the period of time within which the operating costs that have been saved can be set off against the investment costs for the new installation.

Formula for calculating the costs of a lighting installation K from the fixed costs K' and the annual operating costs K'' .

$$K = K' + K''$$

$$K' = n (p \cdot K_1 + R)$$

$$K'' = n \cdot t_b \left(a \cdot P + \frac{K_2}{t_{La}} \right)$$

$$K = n \left[p \cdot K_1 + R + t_b \left(a \cdot P + \frac{K_2}{t_{La}} \right) \right]$$

Formula for calculating the pay-back time t of a new installation.

$$t = \frac{K_1(\text{new})}{K''(\text{old}) - K''(\text{new})}$$

Comparison of the pay-back time t of two new installations, whereby installation B has higher investment costs and lower operating costs.

$$t = \frac{K_1(B) - K_1(A)}{K''(A) - K''(B)}$$

a (DM/kWh)	Energy costs
K (DM/a)	Annual costs for a lighting installation
K' (DM/a)	Fixed annual costs
K'' (DM/a)	Annual operating costs
K ₁ (DM)	Costs per luminaire incl. mounting
K ₂ (DM)	Costs per lamp incl. lamp replacement
K ₁ (DM)	Investment costs (n · K ₁)

n	Number of luminaires
p (1/a)	Interest payments for the installation (0.1–0.15)
P (kW)	Wattage per luminaire
R (DM/a)	Annual cleaning costs per luminaire
t (a)	Pay-back time
t _b (h)	Annual operating time
t _{La} (h)	Service life of a lamp

3.3.7 Simulation and presentation

Visual presentations of lighting installations and the effects they produce in the architectural space play a significant part in lighting design. There is a wide range of possibilities for presenting a lighting concept ranging from technically oriented ceiling plans to graphic illustrations of varying complexity to computer-aided renderings and three-dimensional architectural models or models of the lighting installation.

The aim of such presentations is to provide information. This may be by way of the technical qualities of a lighting installation, the spatial design or the lighting effects in the luminous environment. Computer-aided renderings and models can also be used to simulate the lighting effects of a planned installation and to gain new information.

One of the first forms of presentation of lighting installations are technical drawings and diagrams. The reflected ceiling plan is the most important. It provides exact information about the type and arrangement of luminaires. This documentation can be supplemented by illuminance values entered on the ceiling plan or isolux diagrams, or additional drawings showing different perspectives of the luminous environment. All these help to illustrate the lighting layout and its effect in the space.

Graphic material of this kind allows the lighting designer to derive technical information about the installation and gain a realistic impression of the lighting effects produced. This cannot be expected of other persons involved in the planning process who are not so experienced in technical or lighting matters. It is therefore advisable not always to place too much reliance on technical documentation when presenting a lighting concept.

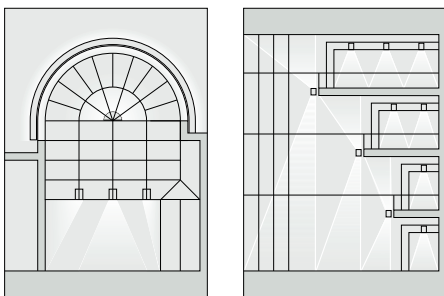

Graphic presentation of a lighting concept.

To illustrate a lighting concept it is therefore better to opt for presentation material that reflects the architecture and the lighting installation and the lighting effects that can be expected. From the point of view of drawings, simple sketches may suffice. The larger the project, the more detailed the graphic presentation will have to be to show the differentiated lighting effects in the luminous environment.

With the exception of drawings that are based on existing installations or simulations, even the more complex forms of representation will reproduce lighting effects in the form of diagrams, which do not demonstrate the complexity of the actual lighting effects. This need not necessarily be a disadvantage; when explaining an overall concept a simple yet effective sketch can illustrate the intended lighting effects much better than an apparently realistic representation with artificially staggered luminance levels. In most

cases a drawing is an economical way of presenting an idea, is adaptable and can be prepared quickly.

Graphically, lighting effects can best be illustrated in the form of beams of light, which either appear as an outline of the beam, as a coloured area or in a shade of grey that will allow them to stand out against a background colour. If luminance patterns are also to be represented, this can be produced using special shading techniques or by free-hand drawings using pencil or chalks. If more contrast is required in the drawing to be able to represent a greater range of luminances, this can be produced using hand-drawn white lines against a grey shaded background. For greater differentiation a method using backlit transparent paper, a collage of foils with different transmittance qualities provides an extremely broad scale of luminances from black to the luminance of the lightest source applied.

Besides drawings, it is also possible to use computer programs to illustrate lighting installations and the effects produced. Lighting calculations programs generally comprise simple spatial representations with different illuminance levels represented by black/white shading. That is to say, besides producing lighting data in tables and diagrams computer programs are also able to give a rough visual impression of the lighting concept. Creating more complex computer graphics with a more differentiated representation of luminances, colour and the furnishings in the luminous environment requires advanced hardware and software.

Similar to a drawing, computer graphics only provide a simplified picture of the actual lighting effects; grading luminances too strictly will often give rise to a rigid, artificial impression. In contrast to drawings, computer graphics do not produce a subjective idea of the lighting effects that can be expected, but are based on complex calculations; they are therefore not only a presentation aid, but also an effective means of simulation.

Although it does take some time to enter the data concerning the architecture, lighting installation and possibly furniture, this may be justified because it does allow more flexibility to try out different luminaire types and lighting concepts. It is frequently advisable to do without detailed computer graphics to illustrate the effect of the light in a given space and to make drawings based on the lighting data produced by the computer calculations instead.

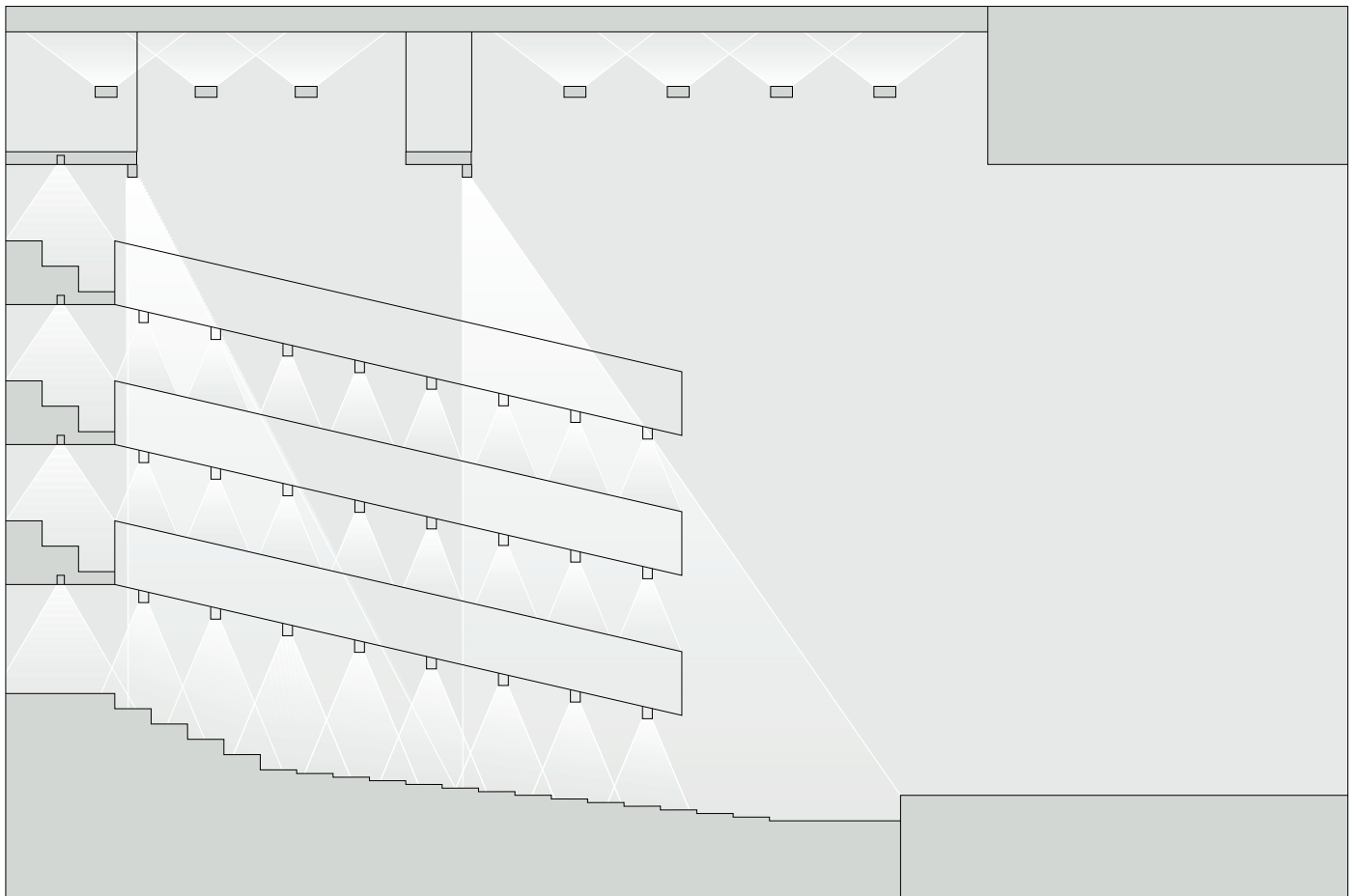

A graphical representation of the lighting concept for the auditorium of a theatre. The light beams are represented by hand-drawn white lines against a grey background. The presentation is confined to the representation of luminaire positions, beam directions and beam spreads.

It conveys a qualitative overall impression of the distribution of light in the space and deliberately provides no quantitative data.

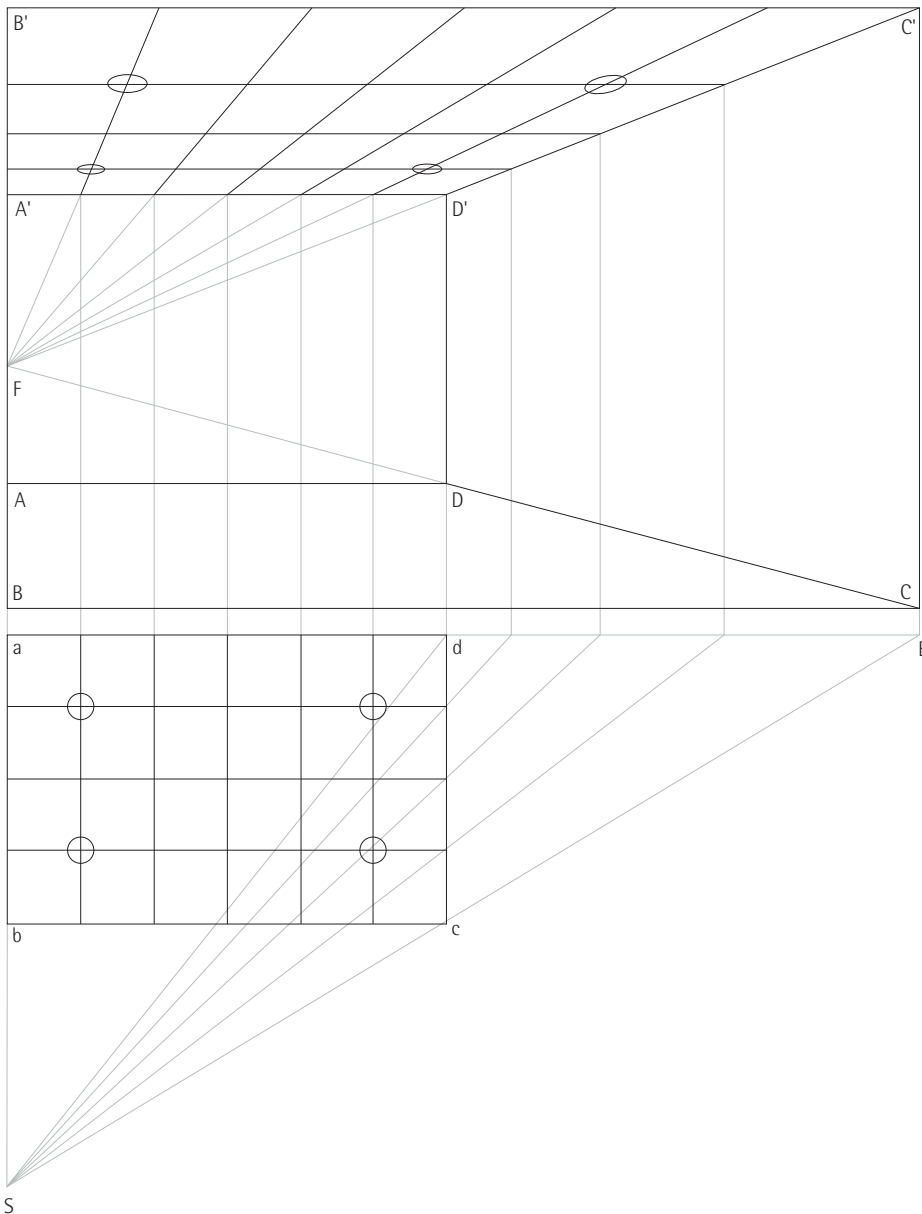

Central perspective: a perspective drawing is to be created from the plan a, b, c, d and the lighting layout entered. First, the observation point S and perspective plane E are selected. For reasons of simplification, the perspective plane is identical to the rear wall of the space, so that heights and distances can be entered to scale on the rear wall of the perspective; the observation point is located on the extension of the left-hand wall. The verticals of the perspective are the result of the projection of points a, b, c, d on the perspective plane. Then the base line AD of the rear wall is selected in the perspective and the room height AA', DD' and the height of

the vanishing point AF (in this case eye height of a person seated) are entered to scale. This in turn defines the rear wall. By extending the vanishing lines FD and FD' the right-hand side wall DC and D'C' is defined. The horizontals BC and B'C' complete the perspective as the front base and ceiling lines. Ceiling grid and luminaire positions in the perspective are derived from the straight lines drawn from vanishing point F and from the projection of wall points from observation point S on the perspective plane E.

Perspective construction of a lighting structure (dual-point perspective): observation point S and perspective plane E are also selected first, for reasons of simplification the perspective plane once again lies at the furthest point to the rear of the plan a, b, c, d. The verticals of the perspective are derived from the projection of points a, b, c, d on the perspective plane, the verticals of the vanishing points from the points of intersection of the parallels to the edges of the plan ba

and bc with the perspective plane. Base-line G is then selected and entered to scale in line with vanishing points F₁ and F₂ (eye height of a person standing) together with the height of point D. Lines DA and DC are defined by extending the vanishing lines F₁D and F₂D. The last point in the perspective, B, is defined by extending the vanishing lines F₁A and F₂C.

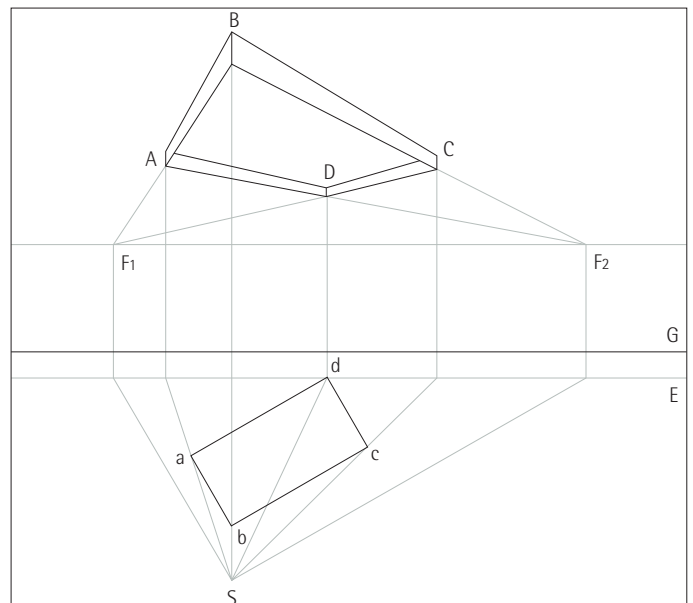

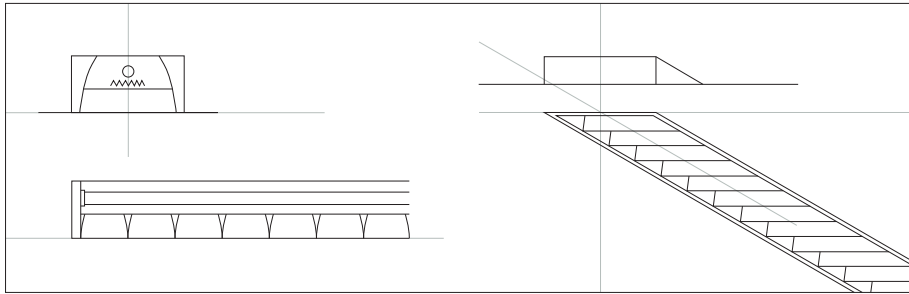

Linear, rectangular recessed ceiling luminaire. Cross section and longitudinal section with ceiling connection, 0°/30° isometric view from below.

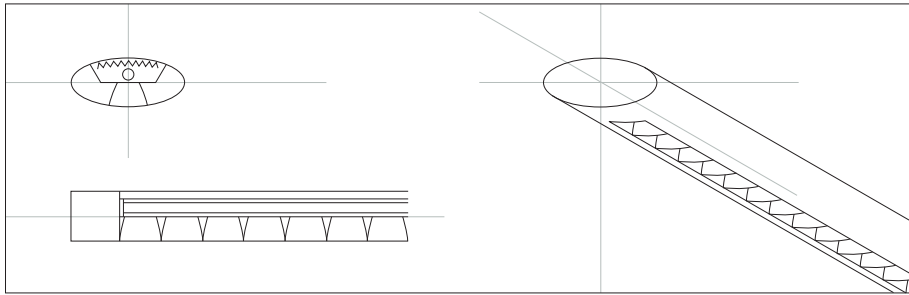

Linear, suspended luminaire or light structure element. Cross section and longitudinal section, 0°/30° isometric view.

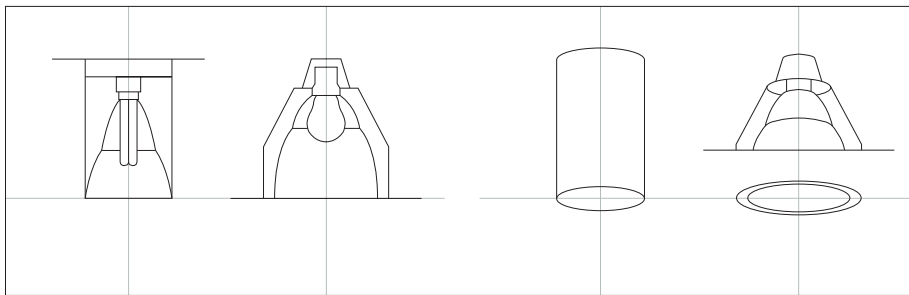

Circular luminaires. Cross section and isometric view of recessed and surface-mounted ceiling luminaires.

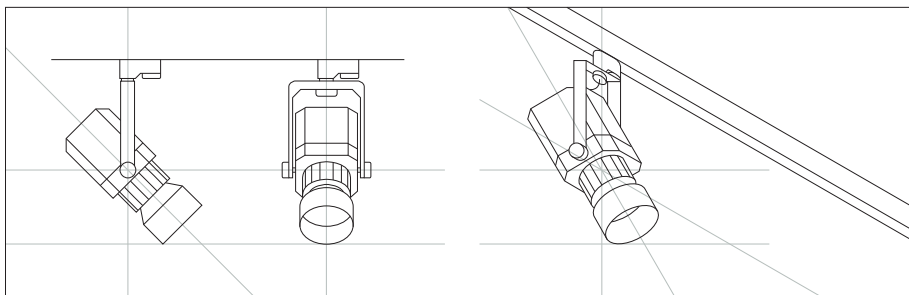

Side and front view of a spotlight inclined at an angle of 30°, 0°/30° isometric view.

Illustrations of luminaires for technical purposes and presentation drawings. In detailed drawings of luminaires cross sections illustrate the

technical construction and function of the luminaire, whereas the isometric drawings illustrate the design and visual impression of the luminaire.

Illustration of lighting effects in technical descriptions and presentation drawings: diameters of light beams on the floor are the result of the beam spread β , whereas scallops can be created on the walls by using the cut-off angle β . If only one value is known, beam spread and cut-off angle can be derived approxi-

mately from one another; between α and β the resulting angle is usually 10° .

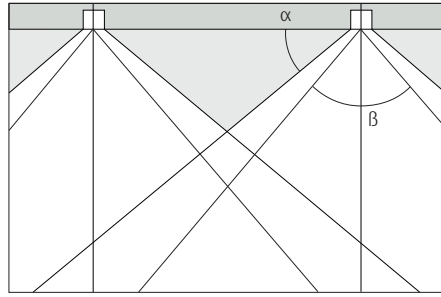

Cross section of the room on the luminaire axis showing cut-off angle α and beam spread β of the luminaires.

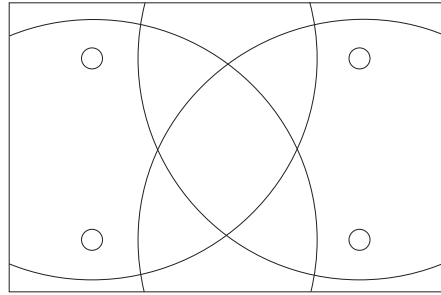

Plan of the space with reflected ceiling plan and diameters of light beams, which are defined by the beam spread of the luminaires.

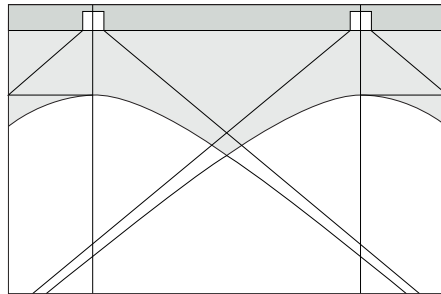

Wall elevation with scallops, the height and pattern defined by the cut-off angle of the luminaires.

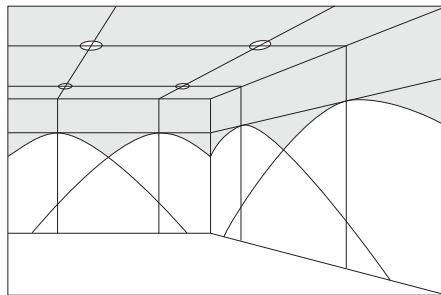

Perspective drawing of the space with luminaires and lighting effects on the room surfaces.

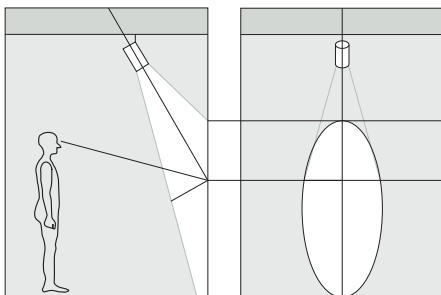

Sectional drawing and wall elevation showing a light beam with a particular beam spread.

Calculation and visualisation of lighting data using a computer.

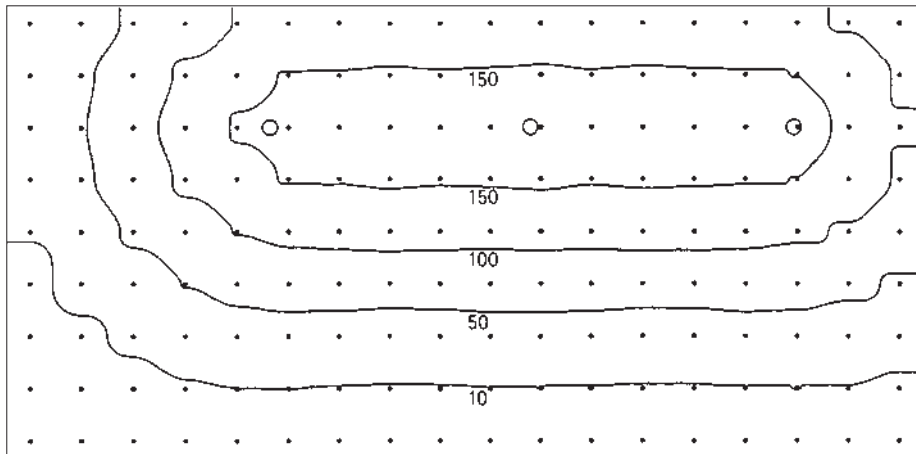

Plan of the room with reflected ceiling plan and calculation points. Calculation results represented by curves of identical illuminance on the working plane (isolux curves).

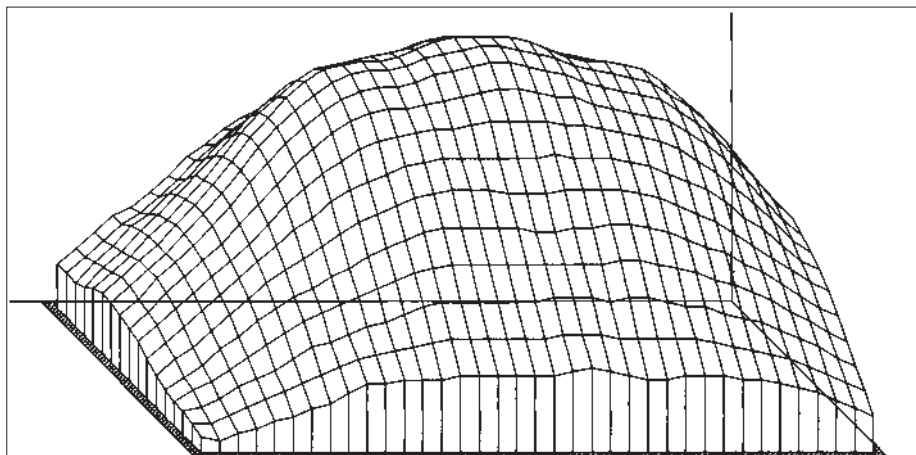

Graphic representation illustrating illuminance distribution in the space by means of an isometric drawing with illuminance relief representation.

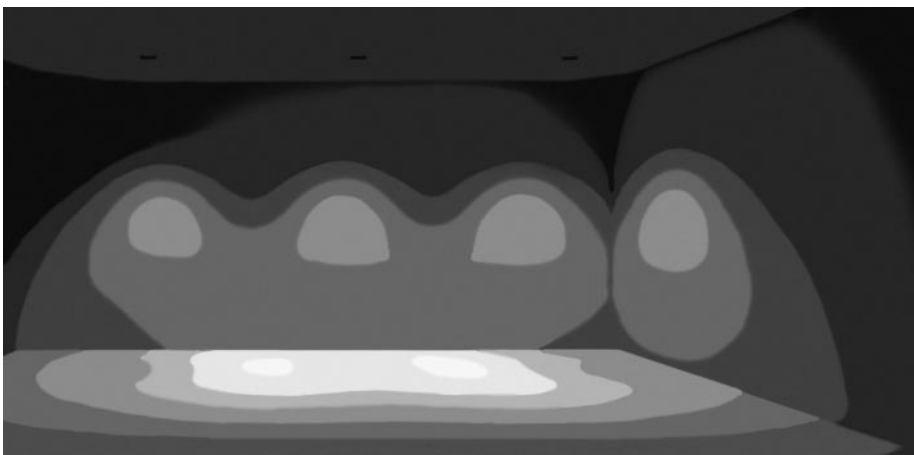

Graphic representation of illuminance distribution on the room surfaces by means of a perspective representation with isolux curves illustrated in shades of grey. Taking reflectance factors into account, similar representations can be created to indicate luminance distribution.

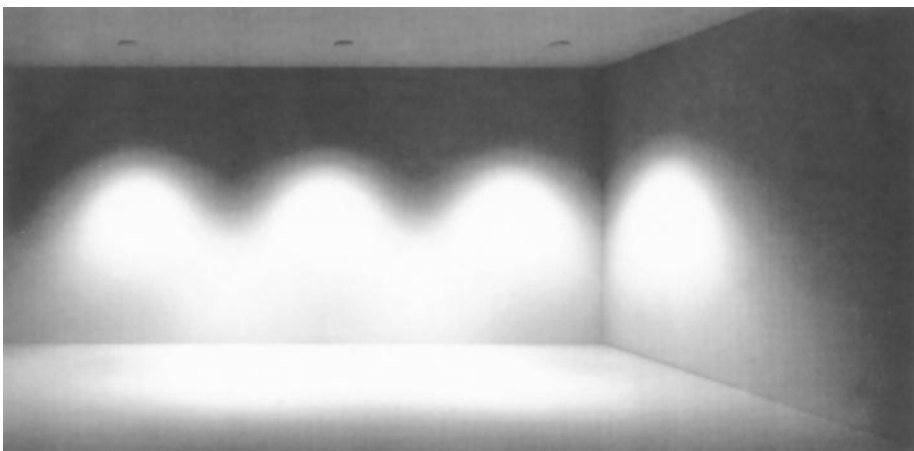

Simulation of lighting effects in the space based on the spatial distribution of luminance. A photo-realistic luminance pattern is achieved through the fine gradation of the luminance values.

3.3 Practical planning
3.3.7 Simulation and presentation

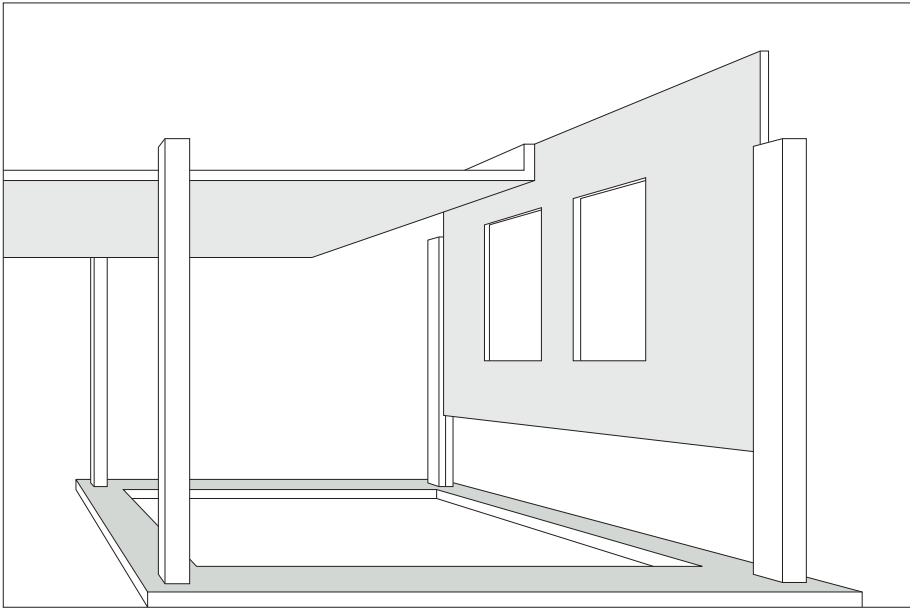

Principle of a modular system for creating simulation models with variable room geometry (1:10, 1:20). With the aid of support pillars ceilings and walls can be arranged as required. Models of this type are used for daylight simulation and for the simulation of artificial lighting. The base of the model is open to allow light-meters, endoscopes and micro-video cameras to be inserted.

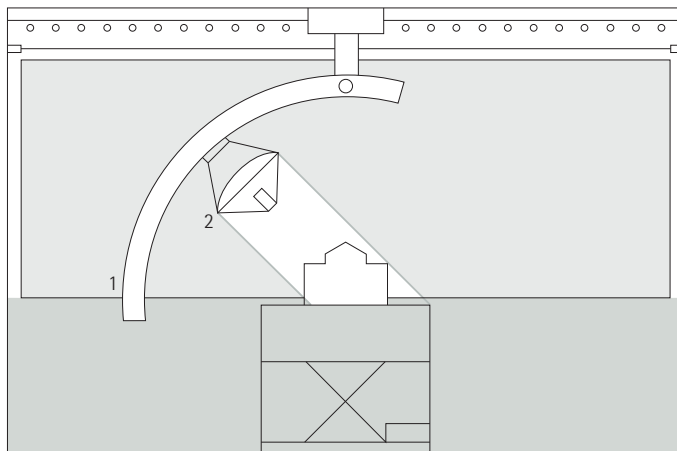

Daylight and sunlight equipment in ERCO's lighting laboratory, simulation takes place in a 5 x 5 x 3 m space with a central adjustable table. A textile ceiling illuminated from behind by fluorescent lamps together with a surrounding mirrored wall serve to simulate diffuse daylight; the illumination level can be continuously controlled. Directed sunlight is simulated by means of

an adjustable parabolic halogen projector (2) attached to a rotating swivel arm (1), which is computer-controlled to take up the position of the sun for any location or time of day or year, or follow the continuous path of the sun over the course of one day at any given location and time of year.

Adjustable table (3) for variable positioning of models for sunlighting tests. With the aid of an integral coordinate desk (1) luxmeter elements, endoscopes and micro-video cameras (2) can be computer-controlled to take up any position and direction.

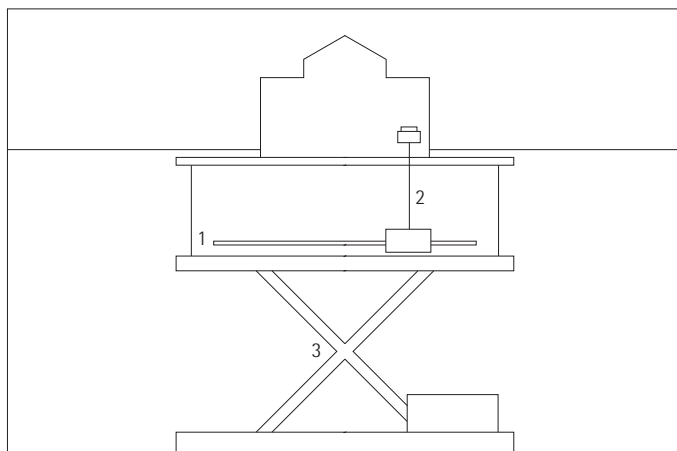

In addition to drawings and computeraided techniques the construction of models is a practical way of demonstrating a lighting installation and the lighting effects it creates. Similar to computer graphics, the model can be used for presentation and simulation purposes.

The clear advantage of models is that lighting effects are not only illustrated, but they can actually be shown and observed in all their complexity. The degree of accuracy of the simulation is only limited by the size and degree of accuracy of the proportions of the model. The most realistic simulations are made on mock-up models on a 1:1 scale.

The scale chosen for the model depends on the purpose of the test and the degree of accuracy the simulation is to present. Models made to scales of 1:100 or even 1:200 only allow observation of the daylight effect on the entire building, whereas with 1:20 to 1:10 models it is possible to observe detailed lighting effects in individual areas.

The most critical detail, especially on small-scale models, is generally the luminaire itself, because even small deviations have a direct effect on the lighting effect. There are similarly limits to the accuracy with which luminaires can be represented due to the dimensions of the light sources available. Through the application of optical fibres, which convey the light from an external light source to several luminaire models, a higher degree of accuracy is possible. When evaluating the effect of a specially developed luminaire or luminaires that are integrated into the architecture, it is advisable to create a mock-up of the luminaire, or of the specific architectural element on a 1:1 scale. This is usually possible without too great an expense, whereas it is only justified for entire rooms in the case of large-scale projects.

The use of models for daylight simulations is particularly widespread. In this case the problem of recreating luminaires to scale does not arise; sunlight and daylight are readily available if the model is taken outside. The alternative is an artificial sky and a sunlight simulator, which can be used to produce the required effect. In the case of daylight simulation in the open air, an instrument similar to a sundial is used to position the model to correspond to a specific geographical location at a specific time of day and year at a specific angle of incident sunlight. If sunlight simulation equipment is used, the sun is represented by a movable, artificial sun. In both cases it is possible to carry out accurate observations of the effect of the light in and on the building on small-scale models and make constructive designs for solar protection and daylight control. Observations can be recorded using endoscope cameras, while micro video cameras allow the documentation of changes in the lighting conditions over the course of the day or year.

An artificial sky can be used to simulate lighting conditions under an overcast sky and also allows daylight factors to be measured (according to DIN 5034).

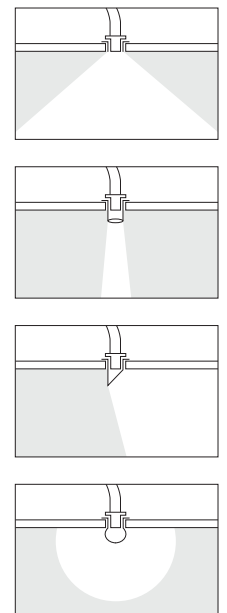

Fibre optic system used to simulate artificial lighting in models of interior spaces. The ends of the fibres represent the individual luminaires in the model. By using special constructions on the ends of the fibres different luminaire types can be simulated (wide and narrow-beam downlights, directional spotlights, wallwashers and exposed lamps).

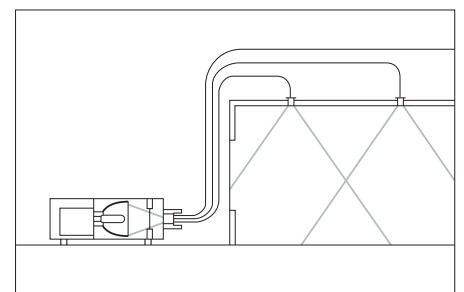

3.3.8 Measuring lighting installations

Measuring the lighting qualities of a lighting installation can serve a number of purposes. In the case of new installations measurements are taken to check that the planned values have been obtained. Measurements recorded on existing installations help the planner to decide what maintenance or renovation work is required. Measurements can also be taken during the planning process for the evaluation and comparison of lighting concepts. The factors that are measured are initially illuminance and luminance. Other values, such as shadow formation or the contrast rendering factor (CRF) can be obtained using appropriate techniques.

To ensure that results of measurements taken are usable the measuring equipment must be of a suitably high quality. In the case of equipment for measuring illuminance this applies predominantly to the correct measurement of inclined incident light (cosine-corrected photometer) and the $V(\lambda)$ correction of the photometer.

When measuring a lighting installation, a series of parameters have to be taken into account and documented in a report. This initially involves the recording of specific qualities of the environment, such as reflectance factors and colours of room surfaces, the time of day, the amount of daylight and the actual mains voltage. Features of the lighting installation are then recorded: the age of the installation, the lighting layout, the types of luminaires, the type and condition of the lamps and the overall condition of the installation. The type of measuring equipment and the class of accuracy of the measuring device has to be recorded.

To record illuminances for an entire space (in accordance with DIN 5035, Part 6) a floor plan is made of the space and has to include furniture. The arrangement of luminaires and the points at which measurements are to be taken are then entered. The measuring points are the central points on a 1-2 m grid, in the case of high rooms up to a 5 m grid. Measurements can also be taken at individual workplaces, in which case an overall tight measuring grid is created for the area. Horizontal illuminances are measured at the individual measuring points at the height of the working plane of 0.85 m or 0.2 m respectively, cylindrical illuminances for determining the formation of shadows on a 1.2 m plane of reference. Luminance measurements for calculating glare limitation are carried out at workplaces in offices at eye level (1.2 or 1.6 m).

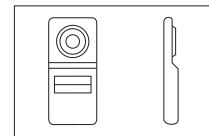
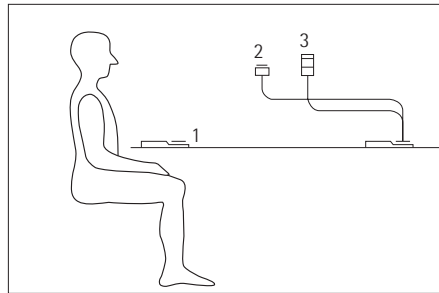

Measuring horizontal illuminance on the working plane using measuring equipment with an integral photo-cell (1).

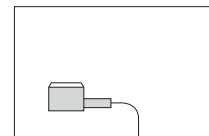

Measuring horizontal illuminance using measuring equipment with a separate photo-cell (2)

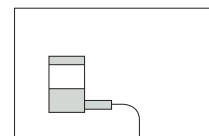

Measuring cylindrical illuminance using measuring equipment with a separate photo-cell (3)

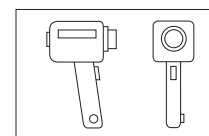
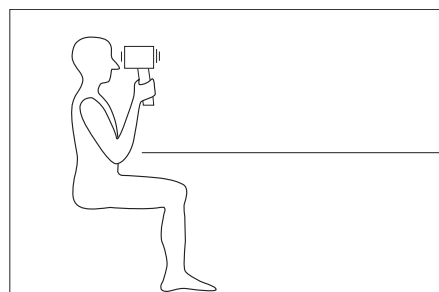

Measuring the luminance of luminaires or room surfaces using measuring equipment with an integral view finder.

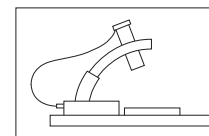
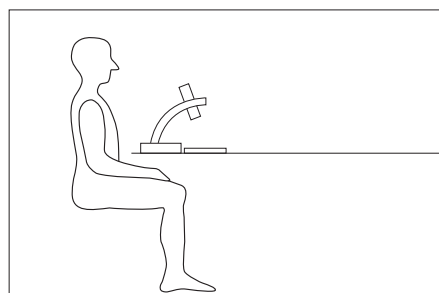

Measuring the contrast rendering factor (CRF) for the evaluation of reflected glare at workplaces on the basis of a standard reflection value.

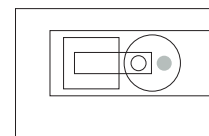

$$\bar{E} = \frac{1}{n} \cdot \sum_{i=1}^n E_x$$

$$g = \frac{E_{\min}}{\bar{E}}$$

Formula for calculating the average illuminance \bar{E} from a measuring grid with n measuring points and the measured values E_x . Calculating the uniformity g of a lighting installation from the lowest value E_{\min} and the average illuminance \bar{E} .

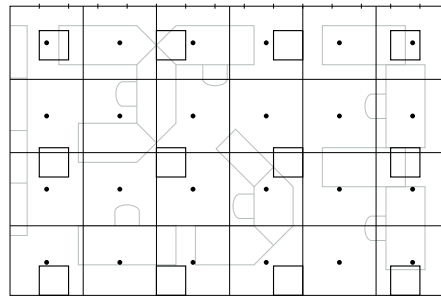

Measuring illuminances on the working plane in empty or open furnished spaces is made according to a regular grid of 1 to 2 metres.

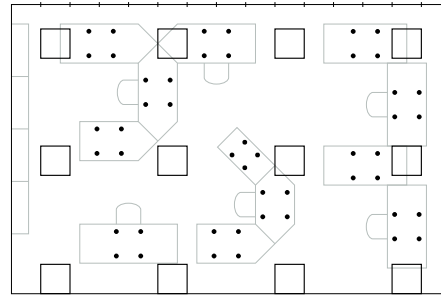

Measuring points for the measurement of illuminances at workplaces.

3.3.9 Maintenance

The maintenance of a lighting installation generally comprises lamp replacement and the cleaning of the luminaires, and possibly also re-adjustment or realignment of spotlights and movable luminaires.

The main objective of maintenance is to ensure that the planned illuminance is maintained, i.e. to limit the unavoidable reduction of luminous flux of a lighting installation. The reasons for the reduction in luminous flux may be defective lamps and the gradual loss of luminous flux by the lamps or a decrease in light output due to soiling of the reflectors or attachments. In order to avoid a reduction in luminous flux and illuminance below a given level all lamps must be replaced and luminaires cleaned at regular intervals. It is practical to effect both maintenance procedures at the same time, since time and technical equipment, such as lifting trucks and cleaning equipment, are essential costly factors in maintenance.

By stipulating a light loss factor when planning the lighting, the intervals at which maintenance is to be carried out can be controlled. By keeping light loss factors low the lighting level will initially be higher and the period during which luminous flux is gradually reduced to below the critical value extended. Using the light loss factor, lamp replacement and the cleaning of luminaires can be timed to take place simultaneously. In dusty environments, for example, a low light loss factor can be stipulated (e.g. 0.6 instead of the customary 0.8) to extend the intervals between the cleaning of the lumi-

naires and co-ordinate them with the service life of the lamps.

It is advisable to have an adequate supply of the required lamp types, both for regular and individual lamp replacement. This will ensure that only lamps of the same power, luminous colour and with the same technical qualities will be used in the lighting installation. In the case of specific lamp types, e.g. halogen lamps for mains voltage, the products supplied by different manufacturers deviate so greatly from one another that uniform lighting effects can only be obtained if the luminaires are all equipped with the same brand.

Besides quantitative issues there are a number of qualitative aspects that may be decisive for maintenance. When one lamp fails in a geometric arrangement of downlights, or in a continuous row of luminaires, it may have little effect on the overall illuminance in the space, but the interruption in a pattern of bright luminaires may be visually disturbing. This also applies to the effects created by the luminaires; a missing beam of light in a series along one wall is just as disturbing as an abrupt drop in luminance due to a defective wallwasher. It is therefore more practical in this case not to wait until the regular lamp replacement is due, but to replace the defective lamp immediately. The adjustment of luminaires is also classified as maintenance in the interest of the qualitative aspects of the lighting installation. In the field of display lighting luminaires frequently have to be re-aligned to emphasise specific areas to accommodate the layout of a new arrangement, or the repositioning of stands, shelves or showcases in retail spaces.

The task of the lighting designer is to draw up a maintenance plan that meets the requirements of the given situation and to provide the necessary information for the maintenance staff. The maintenance plan should enable the operator to service the installation at regular intervals, checking whether the technical requirements are being met and the lighting is performing as planned.

4.0

Examples of
lighting concepts

In the preceding chapters qualitative lighting design has been depicted as a complex process involving the consideration of functional, psychological and architectural requirements appertaining to specific tasks. When dealing with project-related design concepts the scope and limits of a set of standard design examples soon become apparent.

In fact, standard solutions should be avoided at all costs. They may appear to be easy to transfer to any kind of lighting project, but they can never meet the requirements of individual, task-related solutions.

Analysing designs that have already been implemented is equally not easy. It is admittedly possible to demonstrate the various aspects of a differentiated, purposefully planned solution taking a specific project as an example, but it is practically out of the question to transfer this concept onto another set of task-oriented criteria.

If a handbook of qualitative lighting design concepts is to do more than provide the technical basics and a list of planning requirements, it must limit itself to presenting general concepts as examples of applications, which will serve as a basis and a source of ideas for planning of greater relevance relating to specific situations.









The examples of lighting concepts given in this chapter intentionally avoid going into detail. This would only be valid for a defined room situation and a prescribed set of tasks. This applies above all to the provision of illuminance levels and exact lamp data. With a few exceptions, floor plans and sections are on a 1:100 scale to provide comparable dimensions of the spaces and lighting installations. The choice of luminaires is purposefully limited to the standard equip-







ment applicable to architectural lighting. Decorative luminaires and custom designed fixtures, as frequently applied within the framework of individual concepts, are only found in a few cases.

The aim of presenting these examples is to provide a series of basic concepts which may serve as a basis for a wide variety of unique solutions. Consideration has only been given to the general requirements to be observed for a particular area of planning, which nevertheless includes the aspects that deserve special attention regarding planning functional, architectural or perception-oriented lighting. Taking this as a basis, a range of alternative design concepts have been proposed that comprise the selection of appropriate light sources and luminaires and arrangement of equipment in accordance with the lighting requirements and the architectural design.

The task of lighting design is to align the stated concepts to the required lighting quality, the conditions laid down by the users of the space and the architectural design in every specific case, to modify them or expand them through the application of decorative luminaires and lighting effects – in short, to use general basic concepts to create individual lighting solutions.

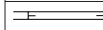
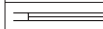
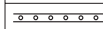
Luminaire symbols used in the reflected ceiling plans in the chapter: Examples of design concepts.

	Downlight
	Spotlight, directional spotlight
	Track-mounted spotlight
	Downlight, asymmetrical wallwasher, washlight
	Double washlight
	Corner washlight
	Square luminaire
	Square luminaire, asymmetrical
	Louvred luminaire

	Louvred luminaire, asymmetrical
	Light structure
	Light structure with track
	Light structure with louvred luminaire
	Light structure with point light sources
	Downlight with emergency lighting
	Square luminaire with emergency lighting
	Louvred luminaire with emergency lighting
	Singlet

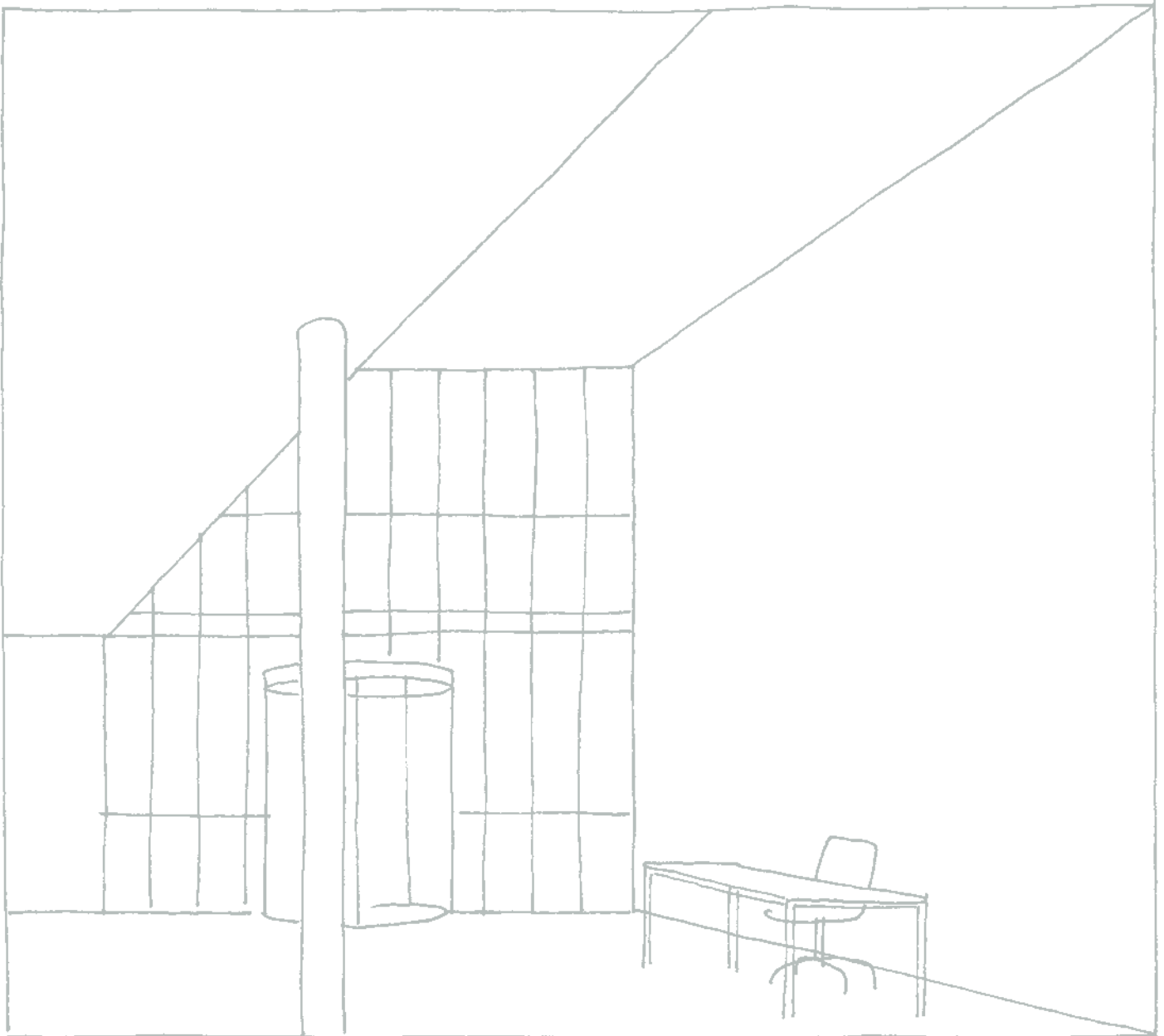

4.1 Foyers

Foyers are spaces that link a building with the outside world; they serve as entrance area, reception and waiting areas, and also provide access to internal areas of the building. As foyers are usually unfamiliar environments, one of the main tasks of the lighting is to provide clear orientation.

This means providing calm, non-dramatic ambient lighting to elucidate the architectural structure of the space and avoid accentuating additional structures, which may cause confusion. The next task is to draw attention to essential focal areas.

The first of these is the entrance. Attention can be drawn to this area via increased illuminance levels. It is also possible to use a different luminous colour here or an individual arrangement of luminaires in the ceiling. Other areas to be accentuated are the reception desk and waiting areas, entrances to corridors, staircases and lifts.

As a transition zone between the outside world and the interior of the building a foyer should also coordinate the diffe-

rent lighting levels inherent to these two areas. It may be practical to install a lighting control system that can be programmed to handle daytime and nighttime requirements. Systems adjusted to the availability of daylight or user frequency can also contribute to the economic efficiency of an installation.

If the foyer has an image function, the required atmosphere can be achieved via the purposeful selection of light sources and luminaires, or by providing decorative sparkle effects and light sculptures. Clear views through the space should not be hampered by confusing structures or an excess of competing visual stimuli.

4.0 Examples of lighting concepts

4.1 Foyers

Daytime and night-time lighting are clearly different. During the daytime pendant downlights supplement the daylight pouring in through the glazed facade and roof. The entrance is accentuated by integral downlights; there is no additional accent lighting on the reception desk or in the waiting area.

After dark the architectural structures are emphasized by wall-mounted combined uplight and downlights and ceiling washlights. The ambient lighting is produced by reflected light, with accent lighting on the entrance.

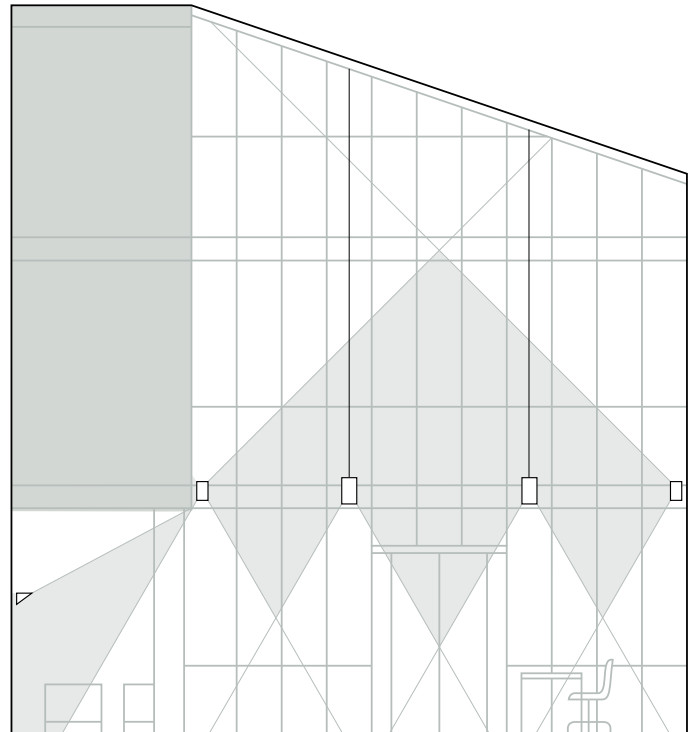
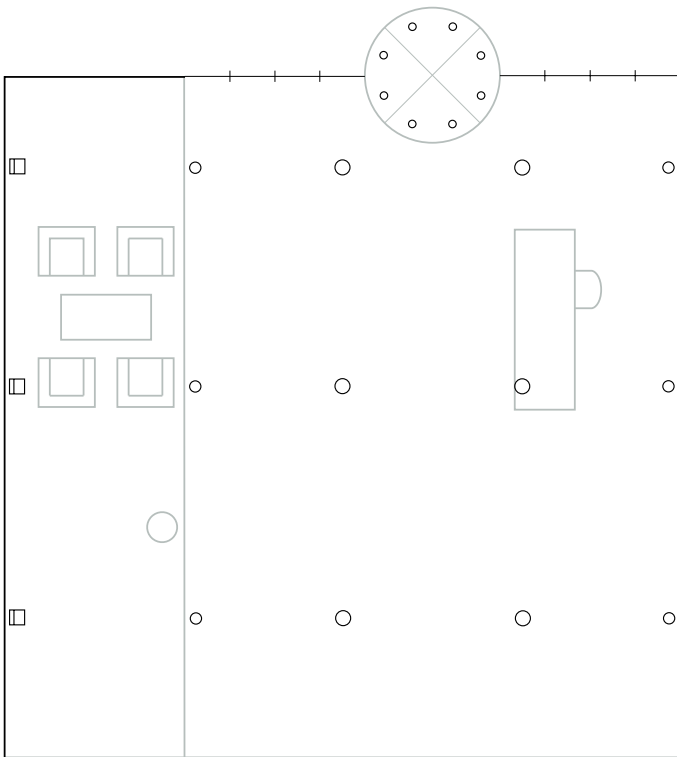

Pendant downlight for HIT lamps.

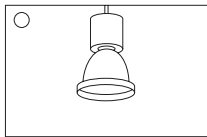

Combined uplight/downlight for halogen lamps or compact fluorescent lamps.

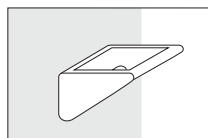
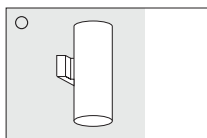

Ceiling washlights for halogen lamps or compact fluorescent lamps.

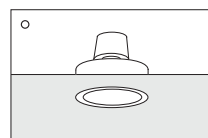

Recessed downlights for low-voltage halogen lamps.

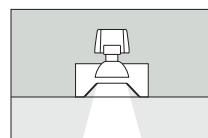

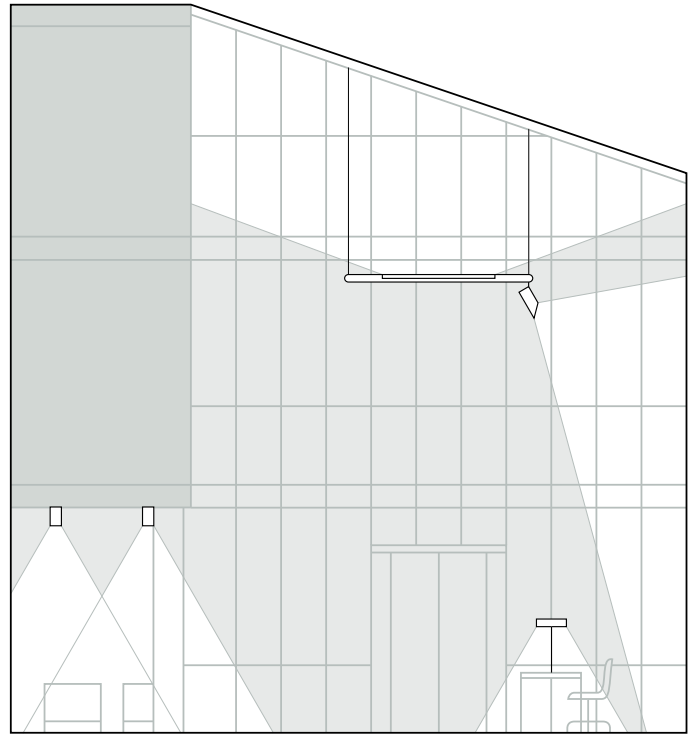
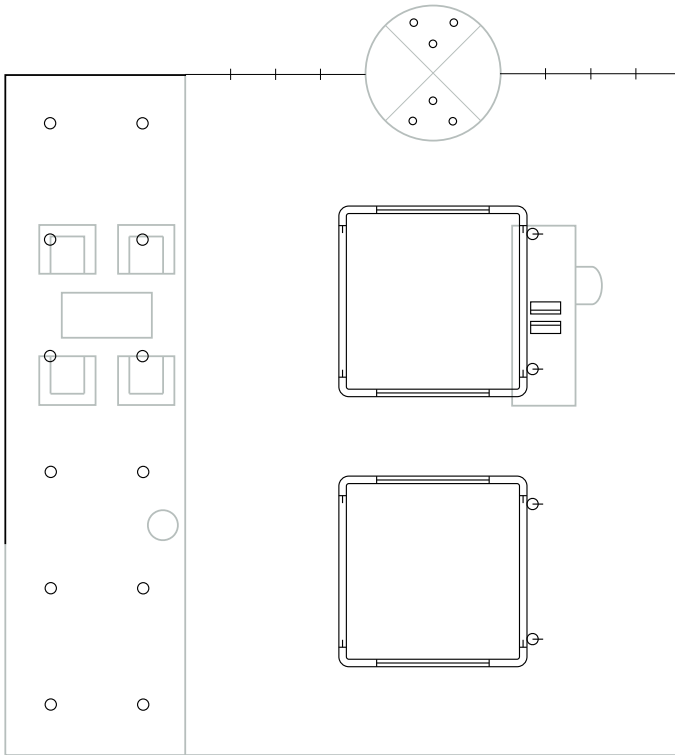

A suspended light structure carries the lighting equipment. During the daytime the lobby is lit by daylight, with the wall behind the reception desk illuminated by wallwashers and the entrance accentuated by downlights. The area beneath the first floor ceiling is illuminated using surface-mounted downlights.

The accent lighting is maintained at night, and is supplemented by an illumination of the room surfaces by indirect luminaires mounted on the light structure. The reception desk has received individual lighting from task lights.

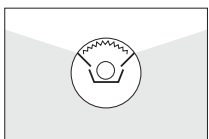
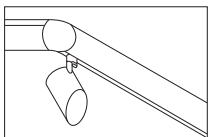

Light structure with integral indirect luminaires for fluorescent lamps and integral track to take wallwashers.

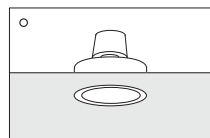
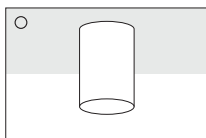

Recessed downlight for low-voltage halogen lamps.

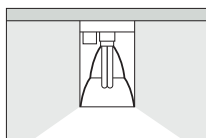

Surface-mounted downlight for compact fluorescent lamps.

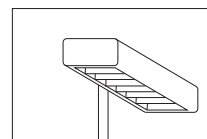

Task light for compact fluorescent lamps.

The luminaires are mounted on a load-bearing lattice beam with integral track. The reception desk is accentuated by spotlights, the entrance by downlights. Ambient lighting and the accentuating of architectural structures is effected by flush-mounted ceiling panels with wall-washers. The waiting area beneath the first floor ceiling is illuminated by wall-washers mounted on a track recessed in the ceiling.

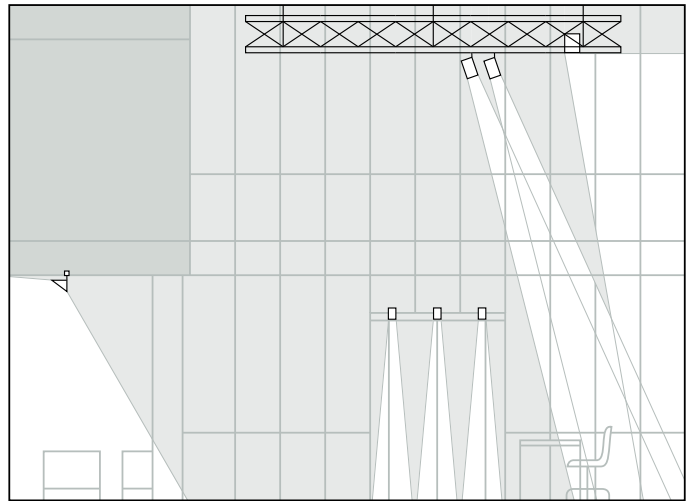
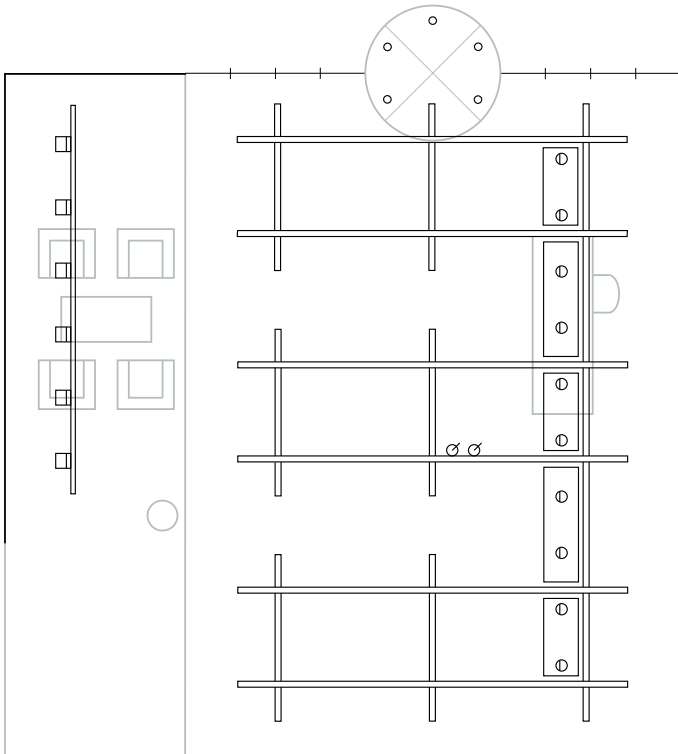

Load-bearing lattice beam with integral track to take spotlights or panels with wall-washers equipped with PAR 38 reflector lamps.

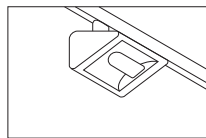
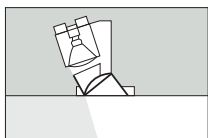
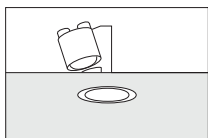
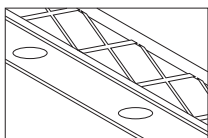
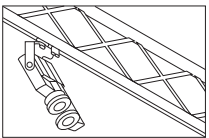

Track for wallwashers for halogen lamps.

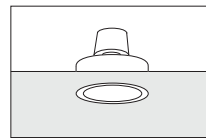

Recessed downlight for low-voltage halogen lamps.

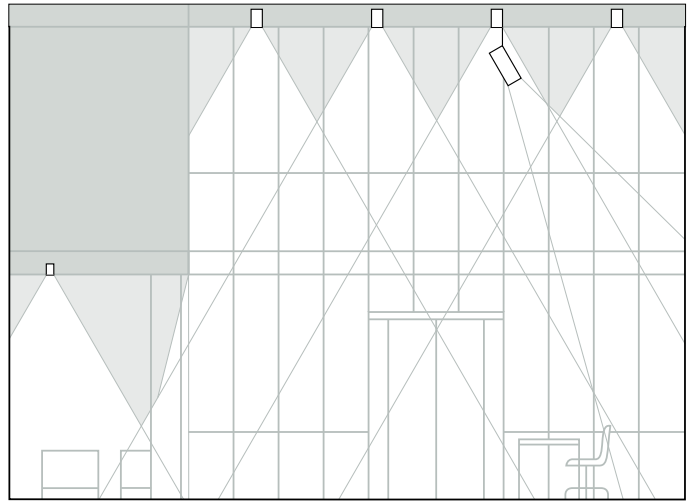
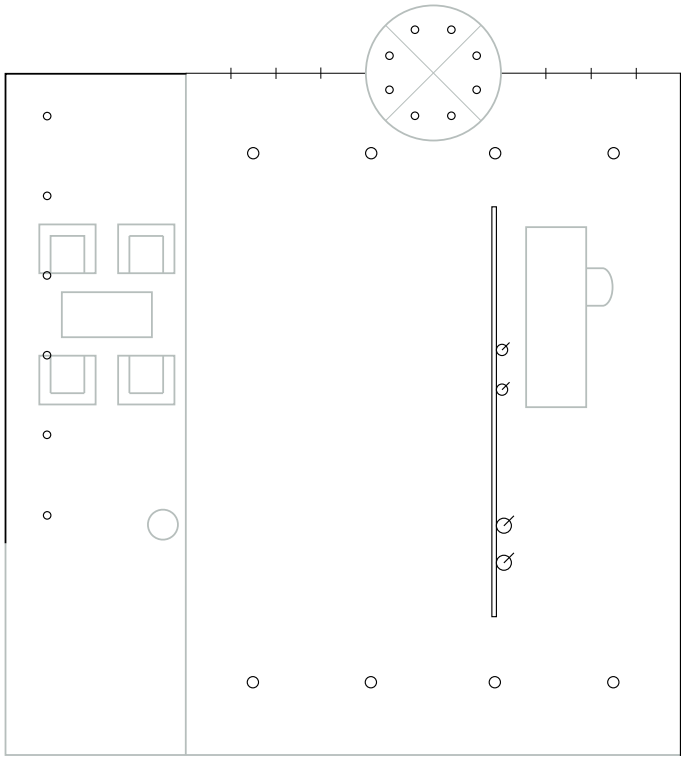

Recessed double focus downlights along both end walls provide ambient lighting. The entrance is accentuated by recessed downlights, the reception desk by track-mounted spotlights; projectors are used to create lighting effects on the wall. The area beneath the first floor ceiling is illuminated by recessed downlights.

Double-focus downlight for metal halide lamps or halogen lamps.

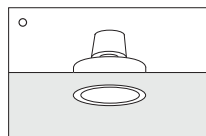
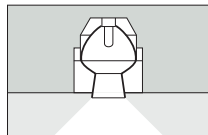
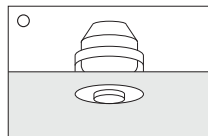

Recessed downlight for low-voltage halogen lamps.

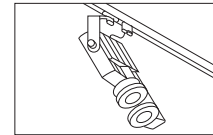

Track with spotlights and projectors.

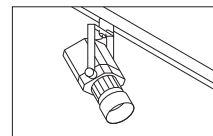

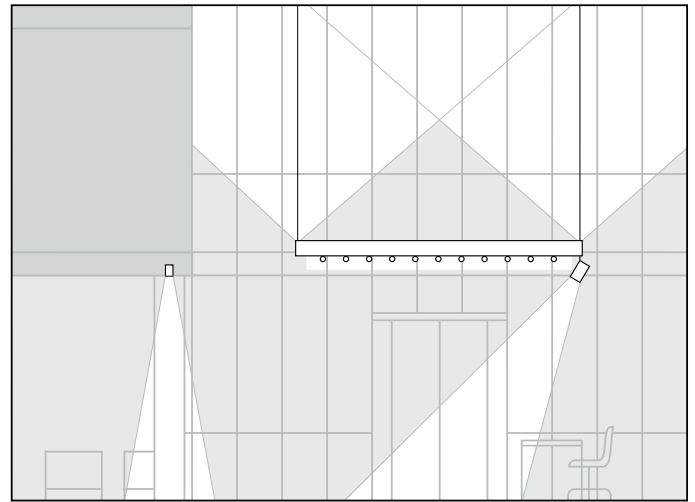
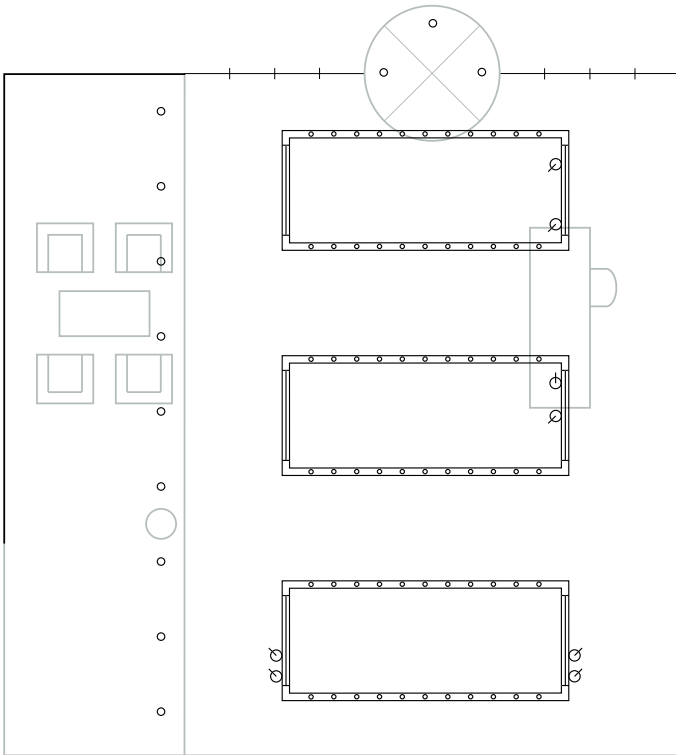

The luminaires are mounted on a wide-span lighting structure. A series of miniature low-voltage halogen lamps make for specular effects on the lower side of the structure. After dark the architecture is accentuated by integral, indirect luminaires, with additional accent provided by spotlights. Downlights accentuate the entrance and the edge of the first floor ceiling.

Wide-span system with track-mounted spotlights, miniature low-voltage lamps on the lower side of the structure and integral indirect luminaires for fluorescent lamps.

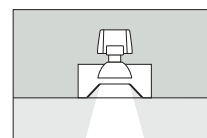
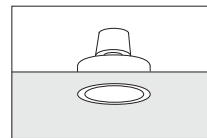
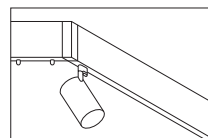

Recessed downlight for low-voltage halogen lamps.

Recessed wallwashers illuminate the long walls, with reflected light creating the ambient lighting. The reception desk has received individual lighting using task lights. Additional accentuation of the entrance is effected by downlights. The area beneath the first floor ceiling is illuminated by recessed washlights.

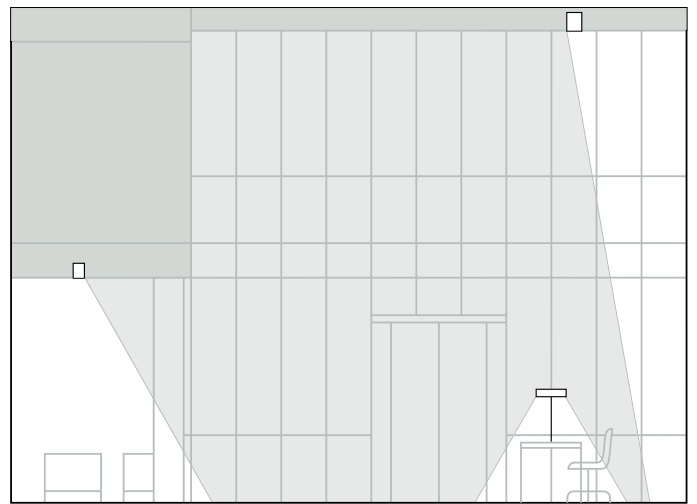
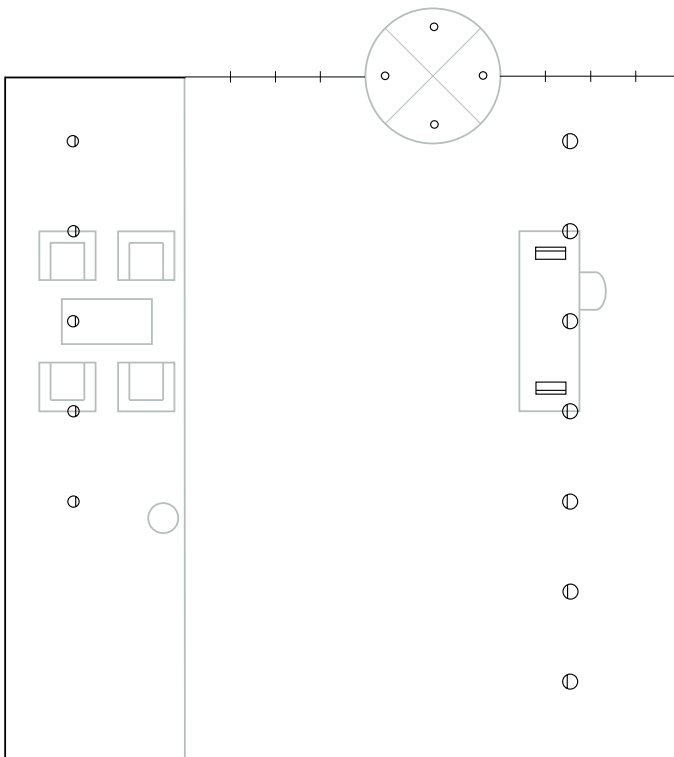

Task light for compact fluorescent lamps.

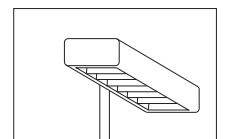

Decorative recessed downlight for low-voltage halogen lamps.

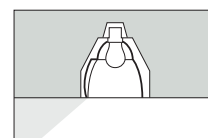
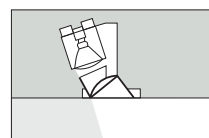
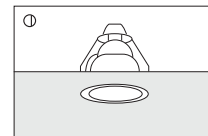
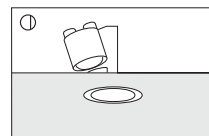
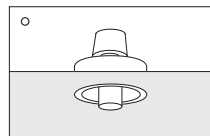

Recessed wallwasher for PAR 38 reflector lamps.

Recessed washlight for general service lamps.

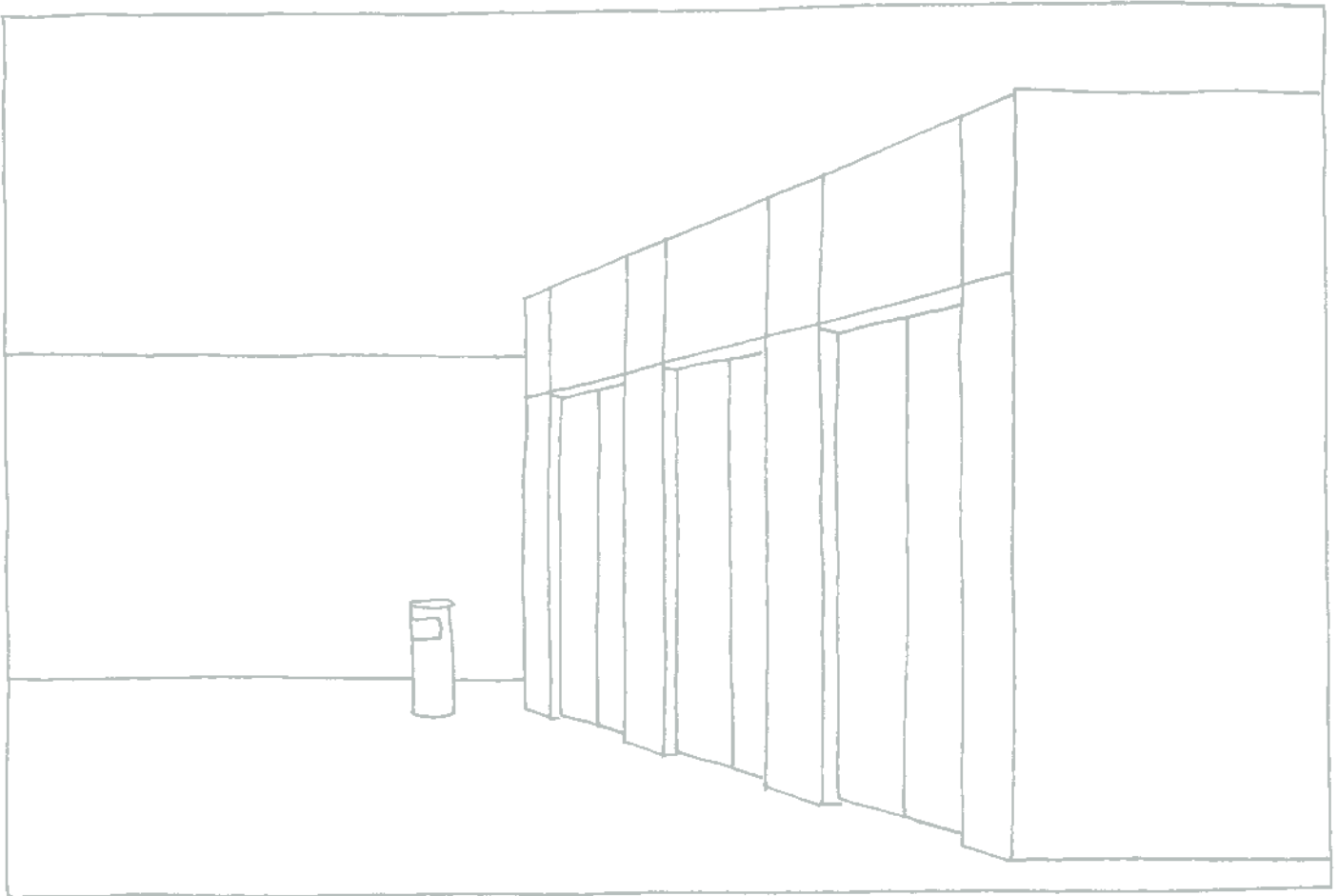

4.2 Lift lobbies

People have to be able to find lifts quickly, which is why lift lobbies should be illuminated so that they stand out from their surroundings. Accentuation can be effected by means of independent lighting elements or by concentrating larger numbers of the elements that provide the lighting in the surrounding area around the lift lobby. The lighting inside the lift car should also harmonize with the overall lighting concept to avoid glare or any unreasonable changes in brightness when entering or leaving the lift.

The lighting in lift lobbies and lifts should provide an adequate vertical component to facilitate communication and recognition when the doors open. Vertical lighting components should be achieved using wide-beam luminaires with adequate cut-off angles or by indirect lighting; this presumes that there is adequate reflectance from the room surfaces, especially the walls.

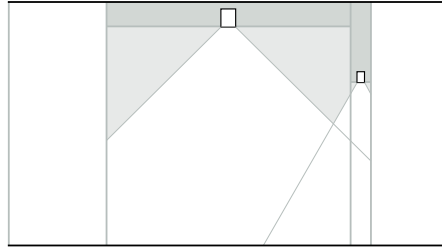
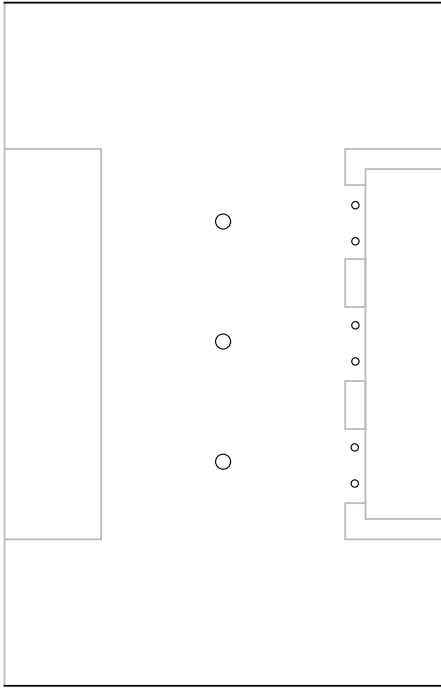

Downlights for compact fluorescent lamps provide economically efficient general lighting. Low-voltage downlights have been used to accentuate the lift lobby. The downlights provide horizontal lighting and produce effective grazing light over the lift doors.

Recessed downlight for compact fluorescent lamps.

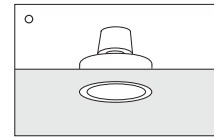
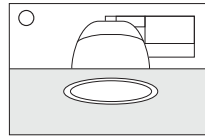

Recessed downlight for low-voltage halogen lamps.

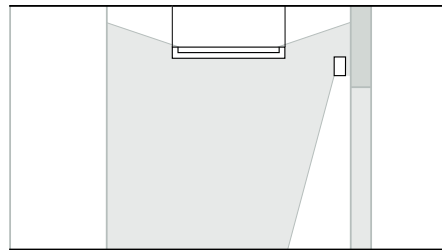
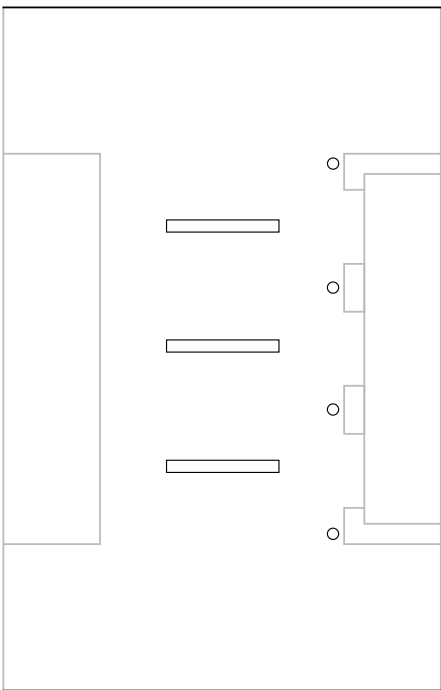
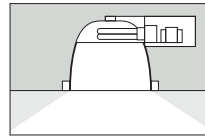

Indirect luminaires illuminate the lift lobby. The area directly in front of the lifts is accentuated by wall-mounted downlights. The grazing light over the walls creates an interesting architectural feature and provides diffuse lighting.

Pendant indirect luminaire for fluorescent lamps.

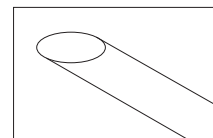

Wall-mounted downlight for halogen reflector lamps.

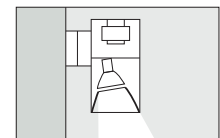
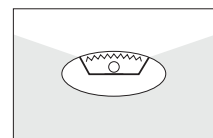
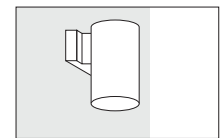

4.0 Examples of lighting concepts
 4.2 Lift lobbies

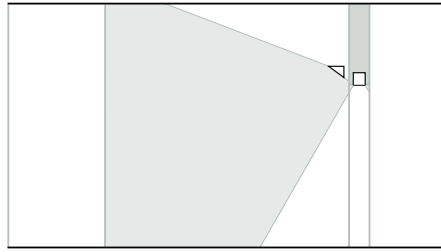
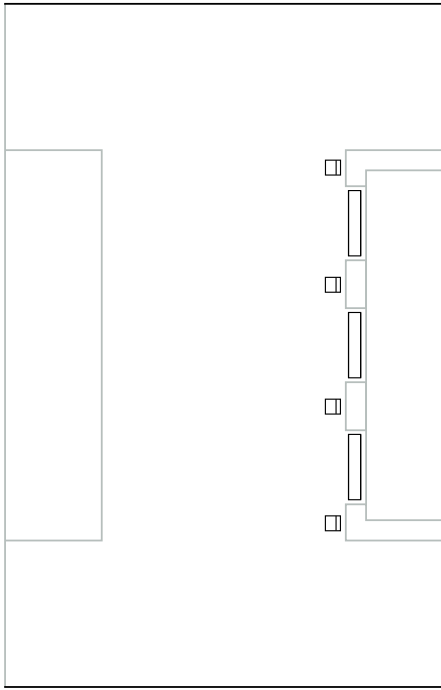

General lighting is provided by wall-mounted ceiling washlights. The lift doors are accentuated using recessed louvred luminaires for fluorescent lamps.

Louvred luminaire for fluorescent lamps.

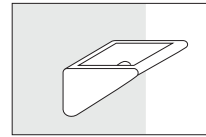
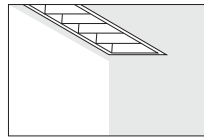

Wall-mounted ceiling washlight for compact fluorescent lamps or halogen lamps.

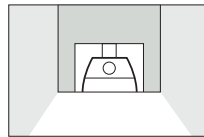

The objective is to create a prestigious atmosphere. The area directly in front of the lifts is accentuated by means of specular effects produced by a series of miniature lamps and downlights arranged in pairs. Both lighting components are mounted on a suspended track system.

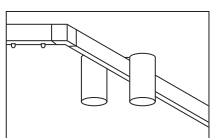
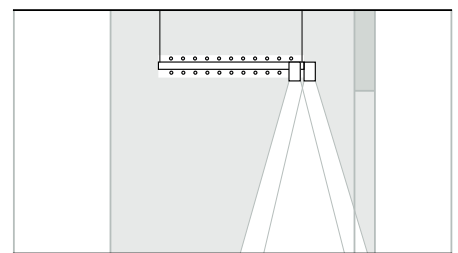
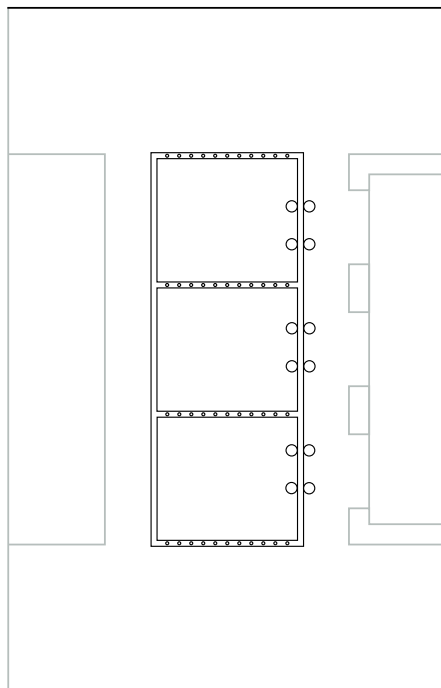

Track system with miniature lamps and a double row of downlights for halogen reflector lamps.

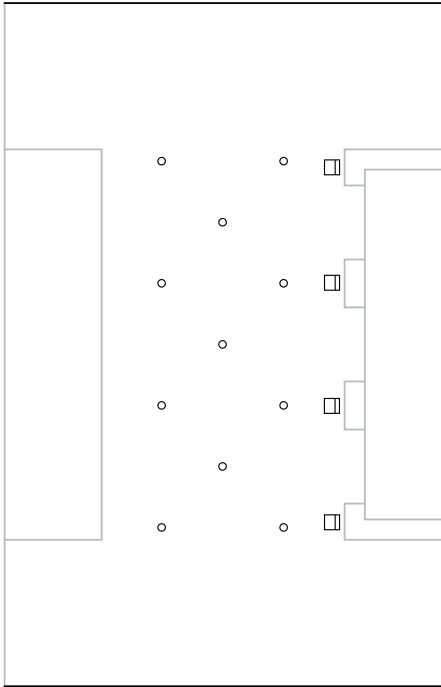

General lighting is provided by a staggered arrangement of decorative downlights, which produce adequate illuminance levels and attractive specular effects. In addition, lighting at floor level is provided by a series of floor washlights.

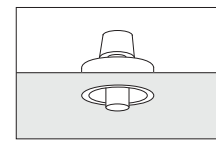
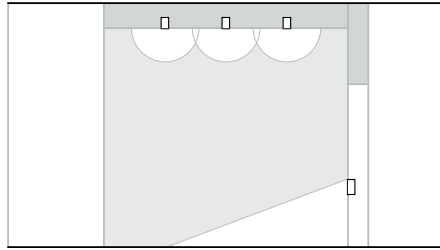

Decorative recessed downlight for low-voltage halogen lamps.

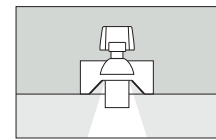

Recessed floor washlight for compact fluorescent lamp.

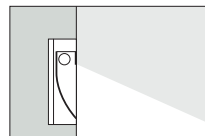
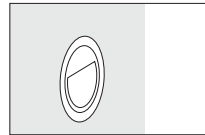

4.3 Corridors

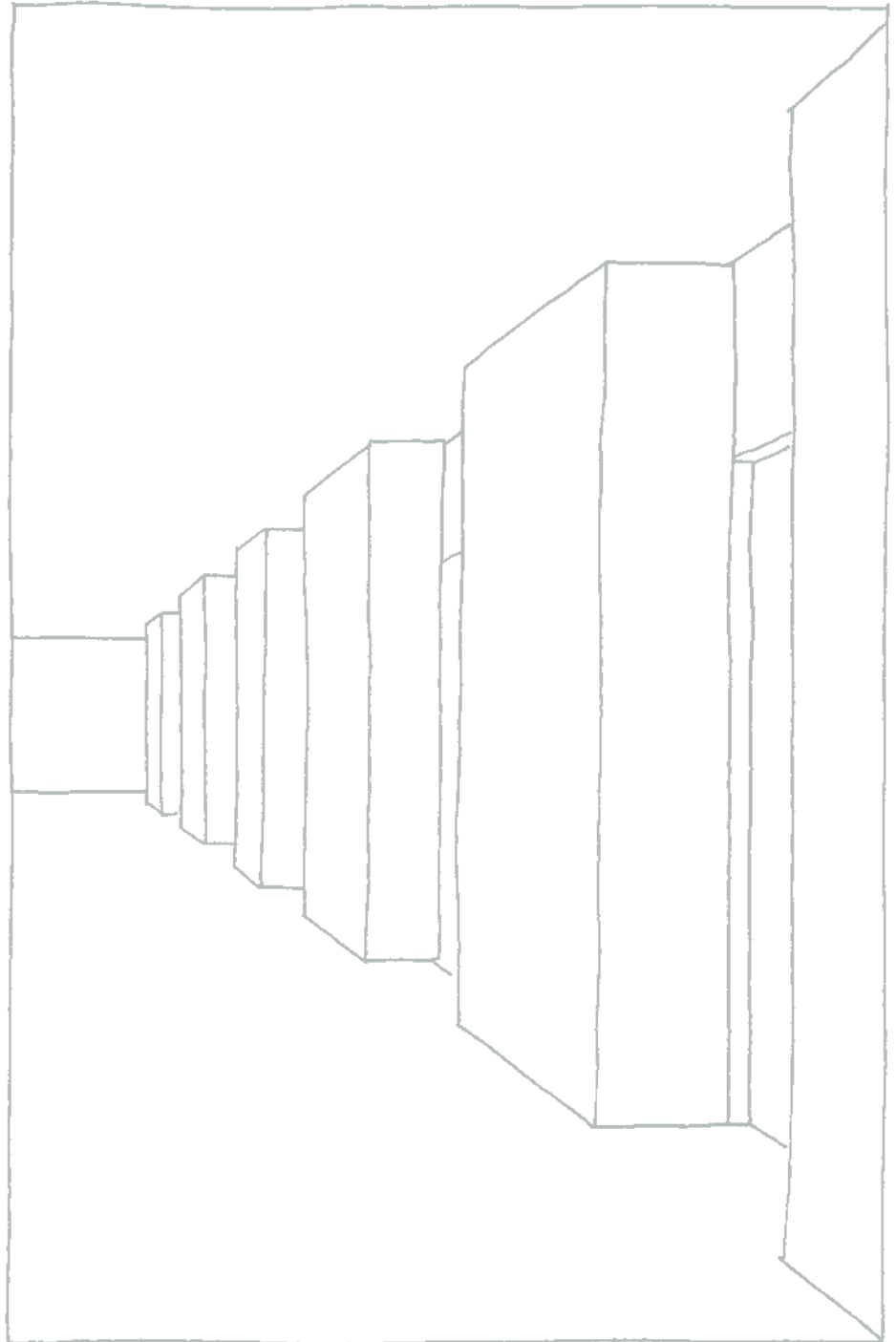

Corridors provide access to different rooms or constitute a link between parts of buildings. They may receive daylight through windows or skylights, but frequently run through the interior of buildings and have to be lit artificially all day.

One of the main tasks of the lighting in corridors, like foyers, is to provide clear orientation. Non-dramatic, communicative lighting is required here to express the architectural structure of the space. Central points of interest, such as entrance, exit and doors to adjacent rooms should receive additional accentuation to ensure that the user is supplied with the necessary information. If the design of the building is such that it is difficult to find

the way from place to place, it is advisable to assist orientation by means of information signs, symbols or colours.

Corridors located in the interior of a building are often dark or appear the same. This effect can be counteracted by illuminating the walls and providing lighting that structures the space, making it more easily legible. In such corridors it is advisable to arrange luminaires in accordance with the architectural design. Accent lighting can also contribute towards removing the feeling of monotony in the space, by dividing it up into sections or views.

Continuous lighting in corridors inevitably leads to long switching times, which

means that ways have to be found to save energy. One means is the use lamps with high luminous efficacy, such as fluorescent lamps. In buildings where corridors also have to be lit at night, it is advisable to include night lighting in the design concept, and reduce the lighting level for times of when the corridors are less frequently used. This may be effected by dimming, switching specific groups of luminaires off or by installing a specially designed night lighting system.

Recessed downlights provide general lighting in the corridor of a hotel with staggered arrangement of doors. The area around the doors is accentuated by recessed louvred luminaires.

Washlights for recessed mounting illuminate the circulation zones. The extremely diffuse light they produce lends the space a bright and friendly atmosphere. Downlights are positioned above the doors to accentuate the area around the doors.

General lighting is provided by floor washlights. The areas around the doors are accentuated by downlights mounted on the side walls. This produces a clear contrast between the horizontal lighting in the circulation zone and the vertical lighting in the area around the doors.

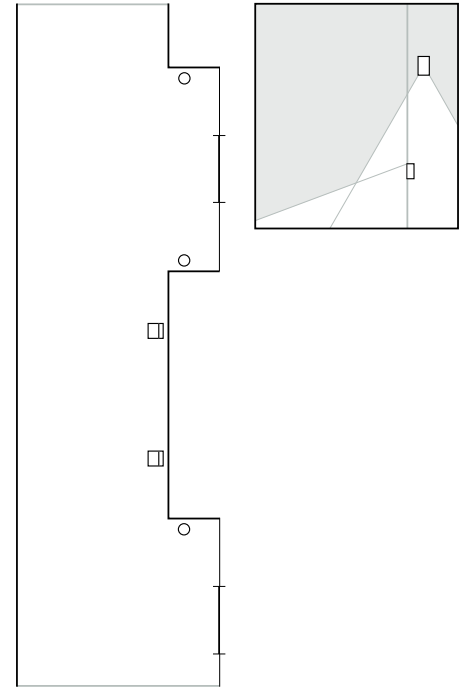
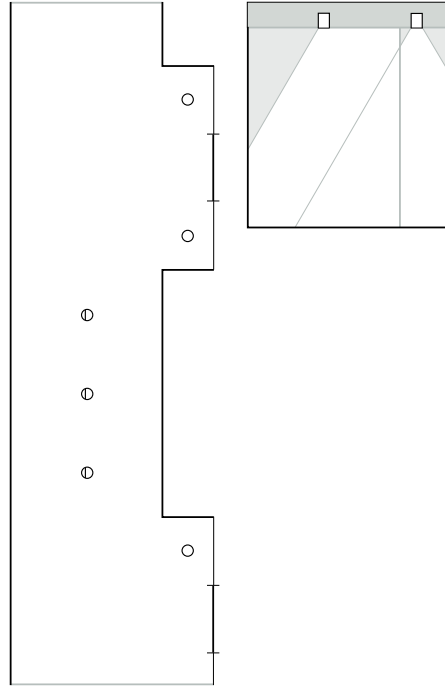
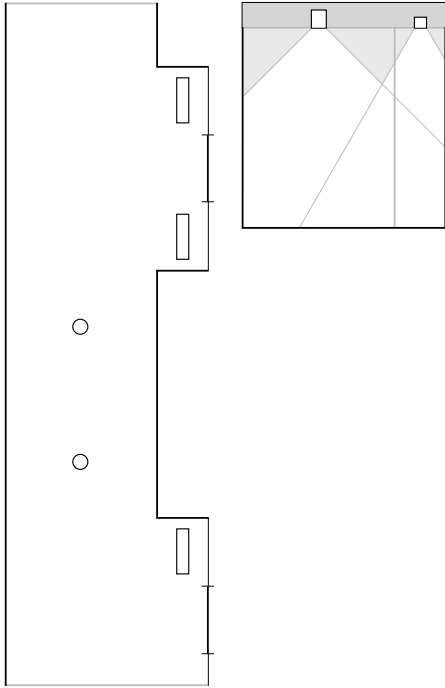

Recessed washlights for halogen lamps.

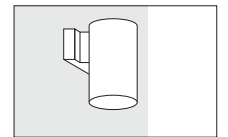
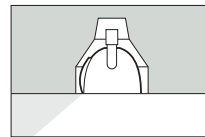
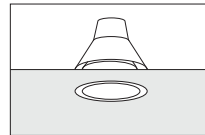

Wall-mounted downlight for compact fluorescent lamps.

Recessed downlight for compact fluorescent lamps.

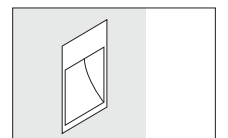
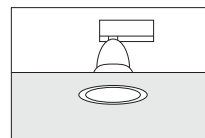

Recessed downlight for compact fluorescent lamps.

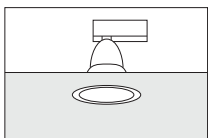

Recessed louvred luminaire for fluorescent lamps.

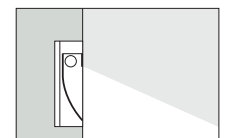
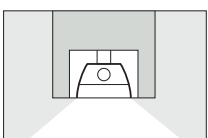
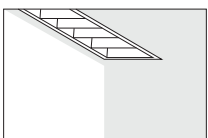

Floor washlight for compact fluorescent lamps.

Wall-mounted ceiling washlights provide uniform, indirect lighting in the corridor, which makes for a bright and friendly atmosphere.

The corridor lighting in an administration building is provided by a matching series of bracket-mounted wallwashers. These provide both indirect ambient lighting via the light reflected by the walls and direct lighting of information signage.

A light structure spanned between the walls provides indirect light for the ambient lighting. The luminaires are arranged so that an information sign can be aligned to each door.

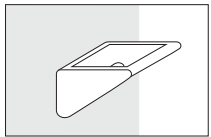
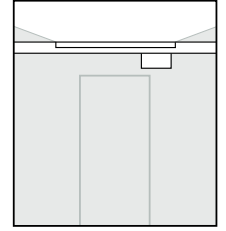
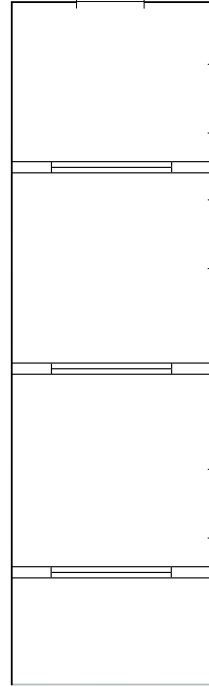
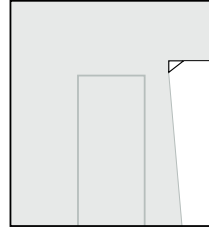
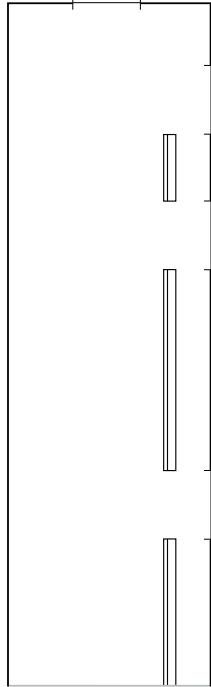
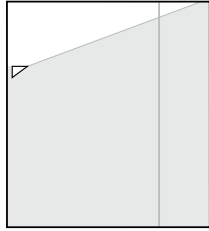
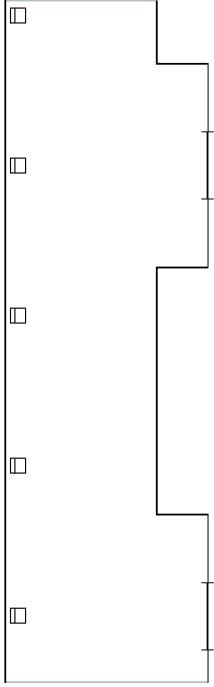

Wall-mounted ceiling washlights for compact fluorescent lamps or halogen lamps.

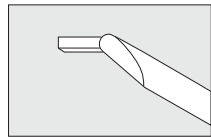

Bracket-mounted wallwashers for fluorescent lamps.

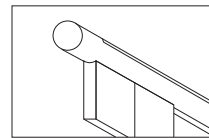
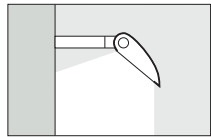

Light structure with indirect luminaires for fluorescent lamps, and information signs.

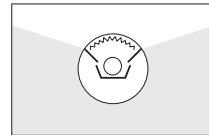

Economically efficient corridor lighting by means of a regular arrangement of louvred luminaires equipped with compact fluorescent lamps.

The lighting components are mounted on a multifunctional trunking system that runs the length of the corridor and takes direct luminaires, sections of track for spotlights to accentuate specific wall areas, plus loudspeakers and emergency lighting.

Recessed louvred luminaires make for uniform, efficient lighting. The luminaires are arranged crosswise to the length of the corridor.

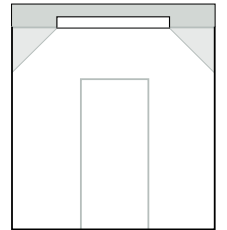
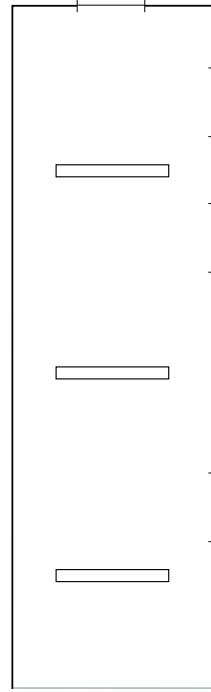
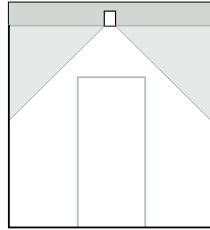
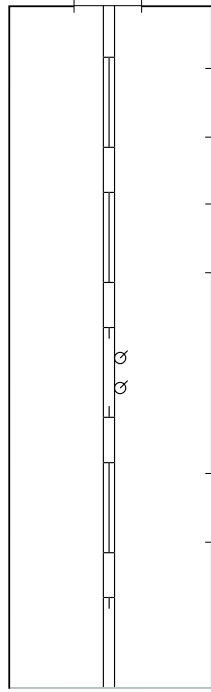
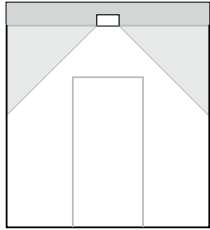
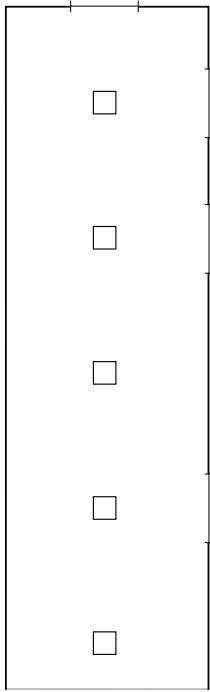

Trunking system with recessed louvred luminaires for fluorescent lamps, and track-mounted spotlights.

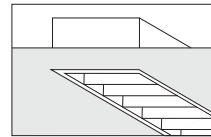
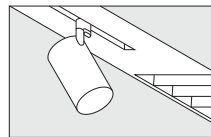

Recessed louvred luminaire for fluorescent lamps.

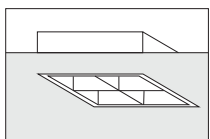

Recessed louvred luminaire for compact fluorescent lamps.

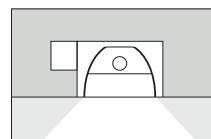

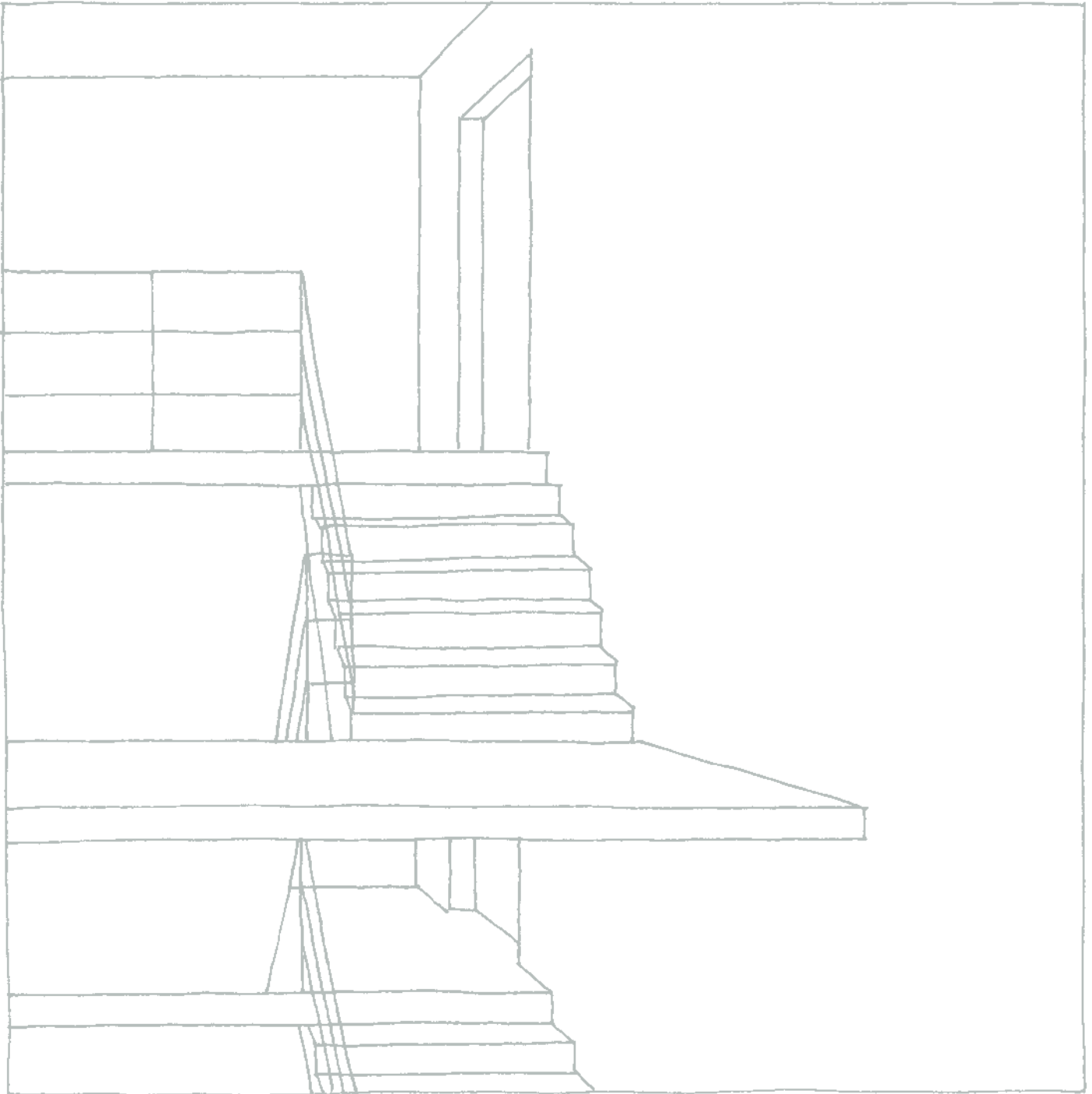

4.4 Staircases

The primary objective of staircase lighting is to provide an aid to orientation. Light is used to make the structure of the environment legible and hazardous areas visible, without creating any additional, confusing structures. The structure of the staircase should be easily recognizable, and the individual steps clearly visible. Since staircases are usually illuminated for long periods of times, it is advisable to use energy-saving light sources.

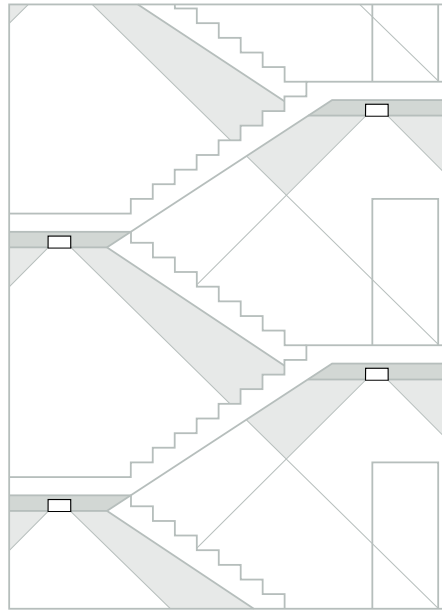
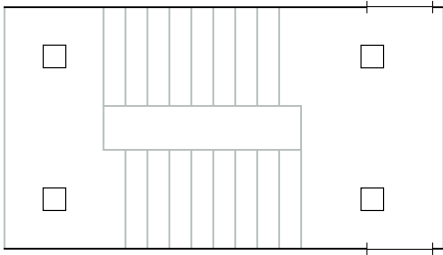

Pairs of recessed louvred luminaires illuminate the landings and flights of stairs.

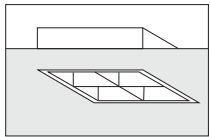

Recessed louvred luminaire for compact fluorescent lamps.

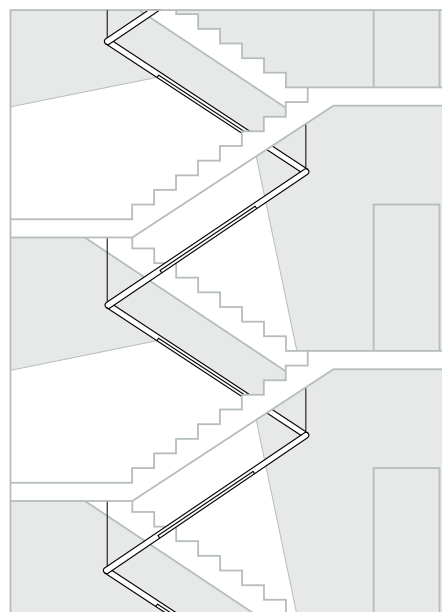
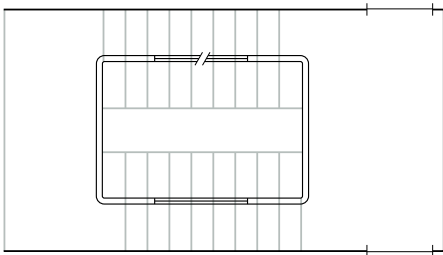

Direct and indirect luminaires in a light structure suspended in the stairwell. The structure follows the course of the staircases and crosses the landings between each flight of stairs. This avoids any complicated constructions above the centre of the landings.

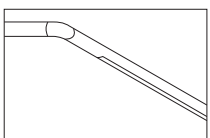

Suspended light structure with integral direct or indirect luminaires for fluorescent lamps.

4.0 Examples of lighting concepts
 4.4 Staircases

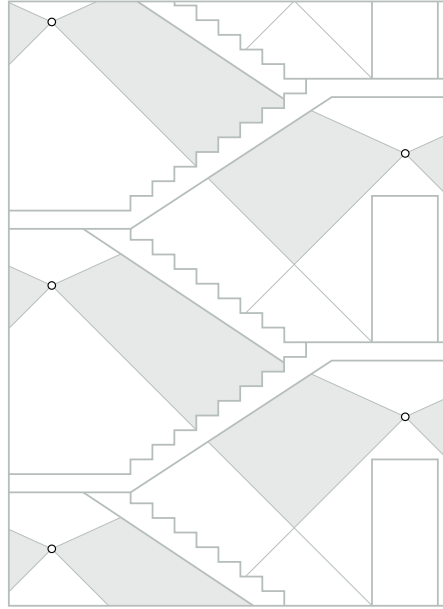
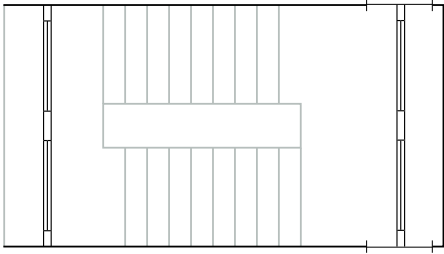

A direct-indirect light structure spanned between the walls of the stairwell above the landings provides direct and reflected light for the lighting of the adjacent flights of steps.

Light structure with integral direct-indirect luminaires for fluorescent lamps.

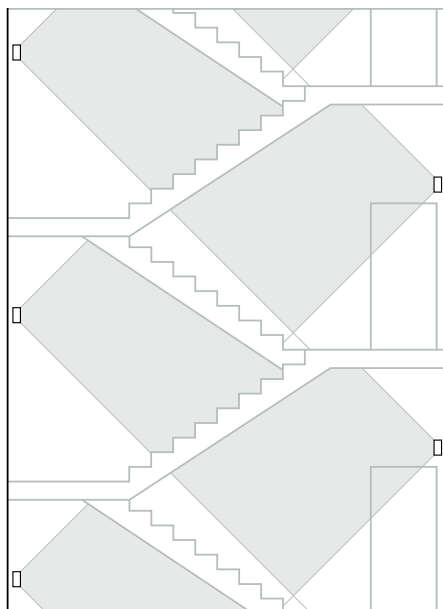
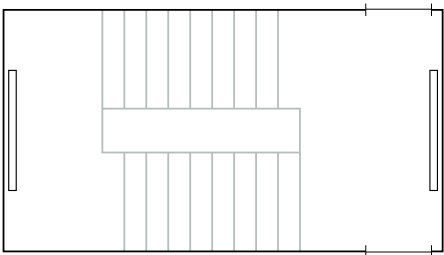
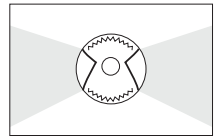
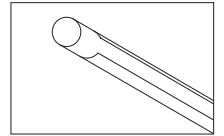

A direct-indirect wall-mounted luminaire provides adequate lighting levels on the stairs and landings.

Wall-mounted direct-indirect luminaire for fluorescent lamps.

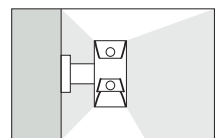
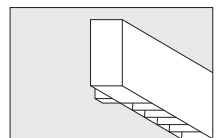

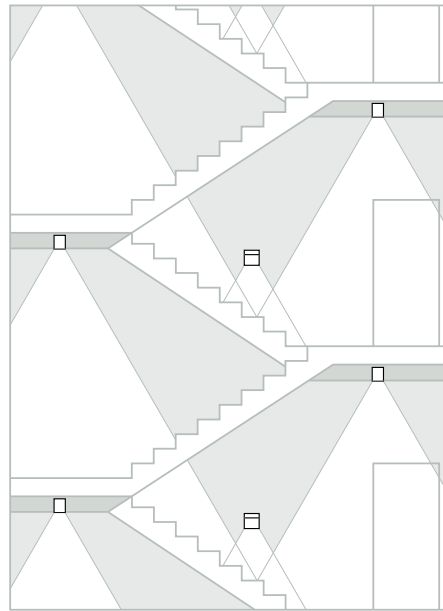
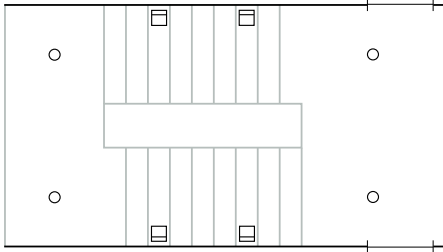

Two different types of luminaire are used to illuminate the flights of stairs and landings. Floor washlights provide the lighting for the flights of stairs, whereas the landings are illuminated by recessed downlights.

Floor washlight for compact fluorescent lamps.

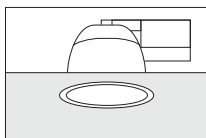
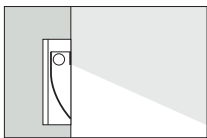
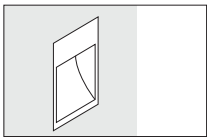

Recessed downlight for compact fluorescent lamps.

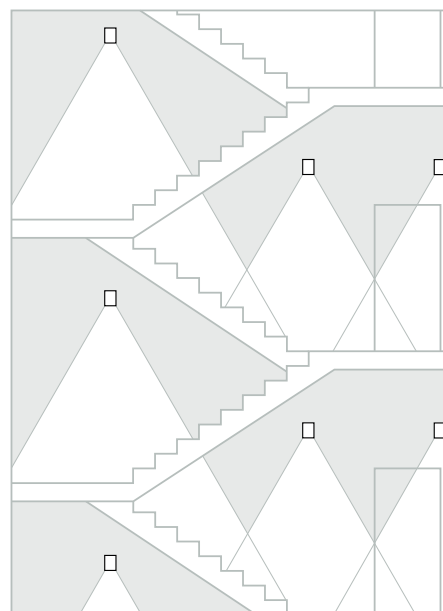
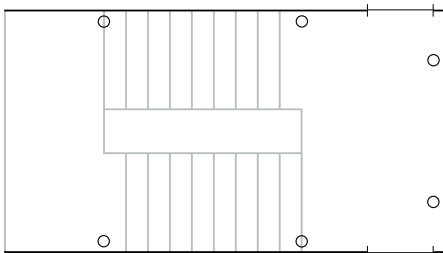

Wall-mounted downlights installed above the foot and top of each flight of stairs and above the doors on the landings illuminate the staircases. This arrangement of luminaires produces excellent visual conditions. Mounting the luminaires on the walls also makes this lighting solution suitable for open staircases, where installation can sometimes be difficult.

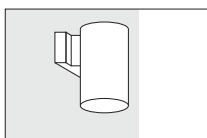

Wall-mounted downlight for compact fluorescent lamps.

4.5 Team offices

The lighting of team offices for small groups is required to fulfil a number of conditions, as laid down in the standards for the lighting of workplaces. The requirements include the following quality criteria: the level and uniformity of the lighting, luminance distribution, limitation of direct and reflected glare, the direction of light and shadow, luminous colour and colour rendering.

Other requirements that may have to be met may concern the correlation of daylight and artificial light, the presence of drawing boards, and above all the lighting of spaces with personal computers. Luminances in the space should be balanced and special attention paid to optimum glare control through the installation of suitable luminaires. The luminaires used for the lighting of spaces with personal computers are required to meet especially stringent standards to avoid reflected glare on computer screens. Luminaires constructed in accordance with the standards are referred to in Germany as VDT-approved luminaires and can be used without reservation for the illumination of such workplaces. It should be pointed out, however, that VDT-approved luminaires do have the following disadvantages in spite of their glare limiting qualities: the low vertical lighting they produce, the fact that the luminaires have to be arranged in close proximity to one another, and the increased reflected glare on horizontal visual tasks. For the lighting of spaces with positive image screens or if luminaires are installed outside the critical area of the screens, it is advisable to install wide-angle luminaires and satin finished reflectors, and to only use the VDT-approved fixtures as a solution for the most critical cases concerning the lighting of personal computers.

One way of lighting team offices is to provide uniform illumination using luminaires arranged according to a set grid, where character and glare limitation can be influenced by the choice of luminaires and whether they are direct, indirect or direct-indirect fixtures. Another possibility is to provide equally uniform, but lower ambient lighting supplemented by task lights. For team offices which are clearly subdivided into individual areas (working area, circulation zone, social area, conference area) it is possible to develop a zonal concept, lighting each area in accordance with the activity that takes place there. By switching different combinations of luminaires the lighting can be adjusted to suit the use of the space, e.g. by combining luminaires for fluorescent lamps and halogen lamps. It is also possible to provide daylight-related switching of luminaires located near windows.

For economically efficient lighting it is advisable to use conventional or compact fluorescent lamps. Efficiency can be further increased by the use of electronic control gear, which also enhances visual comfort through the avoidance of flickering effects.

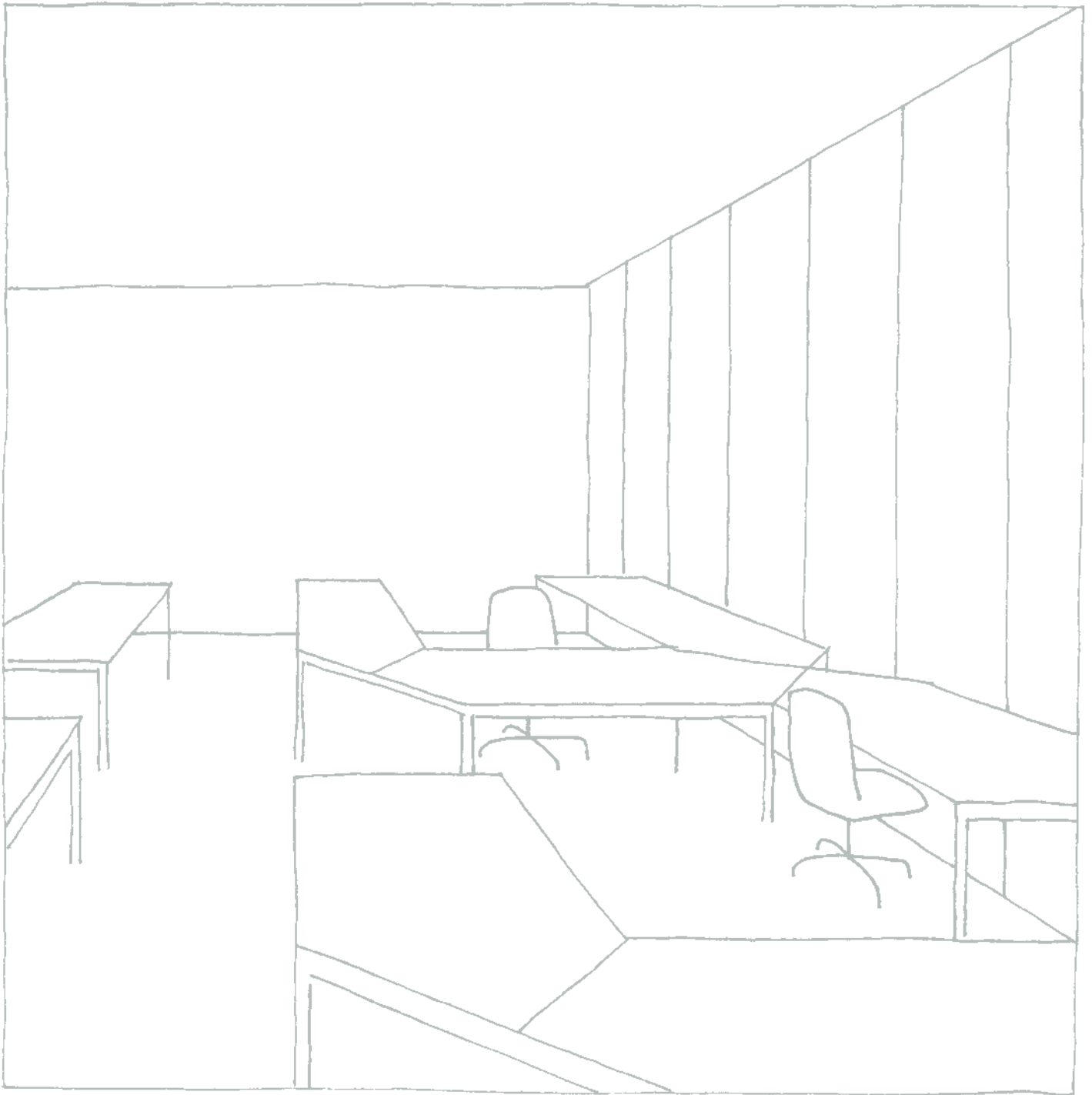

A regular arrangement of recessed louvred luminaires for the ambient lighting. The lighting is not related to individual workplaces, which means that office layouts can be changed without changing the lighting.

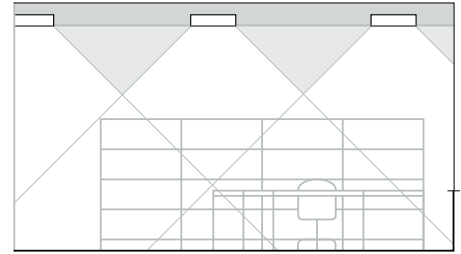
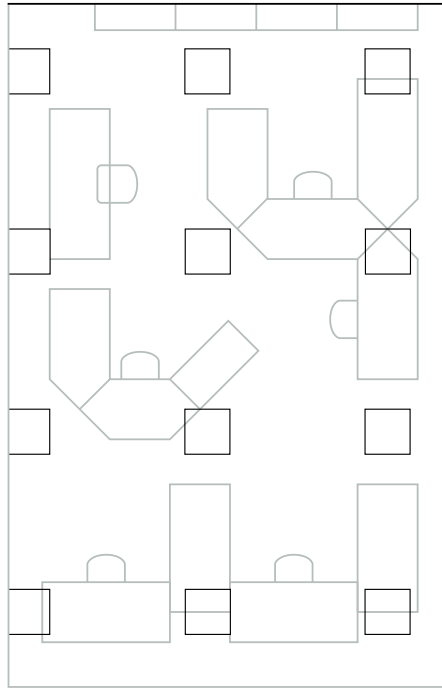

Recessed louvred luminaire for compact fluorescent lamps.

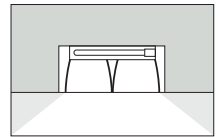
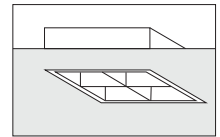

A staggered arrangement of recessed louvred luminaires provides uniform ambient lighting. A linear prismatic lens positioned in the centre of the reflector produces batwing-shaped light distribution, which completely avoids reflected glare, achieves good CRF values throughout the space and allows flexible furniture layout.

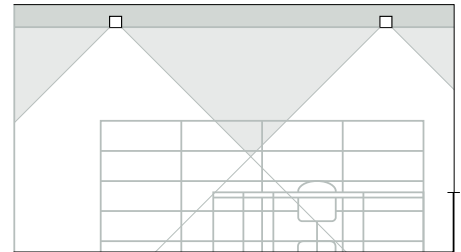
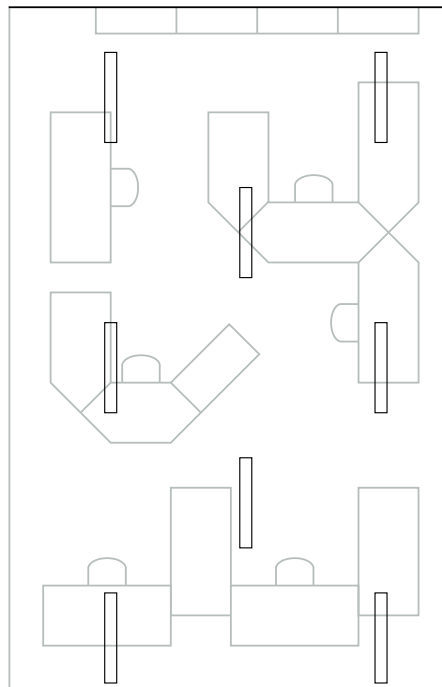

Recessed louvred luminaire for fluorescent lamps.

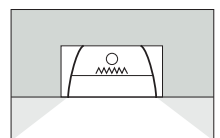
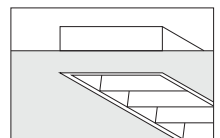

A regular arrangement of recessed downlights with cross-blade louvres provides uniform ambient lighting.

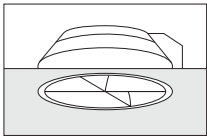
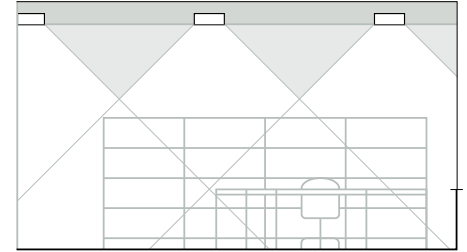
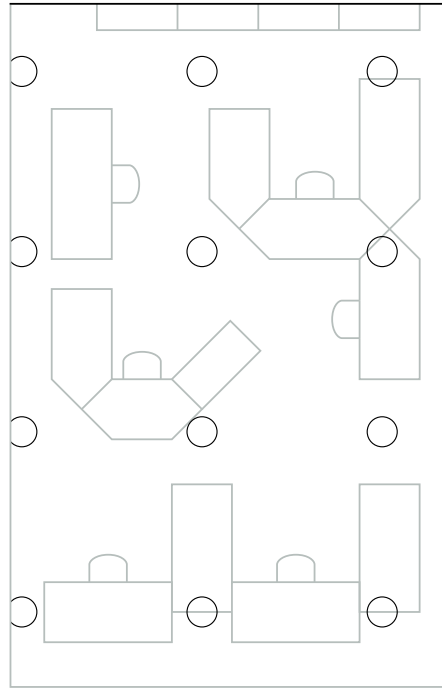

Recessed downlight with cross-blade louvre for compact fluorescent lamps.

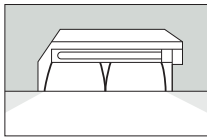

The lighting components are mounted on multifunctional channels that run parallel to the windows. They take the louvred luminaires for the ambient lighting and directional spotlights for accent lighting. Ventilation or air-handling systems can be integrated into these installation channels.

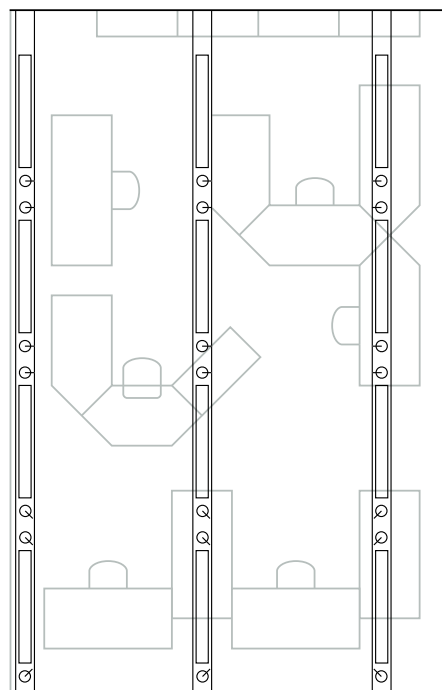

Trunking system/installation channel for louvred luminaires for fluorescent lamps and recessed directional spotlights for halogen lamps.

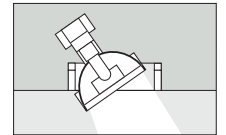
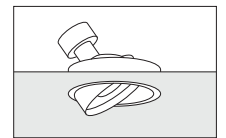
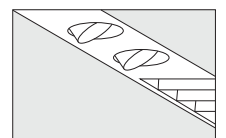

Secondary reflector luminaires are used to illuminate the office. The ratio of direct and indirect light and glare limitation can be controlled by the appropriate choice of luminaires. This will in turn produce the required atmosphere.

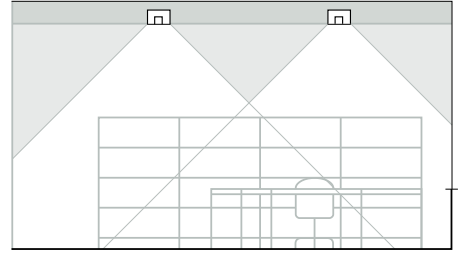
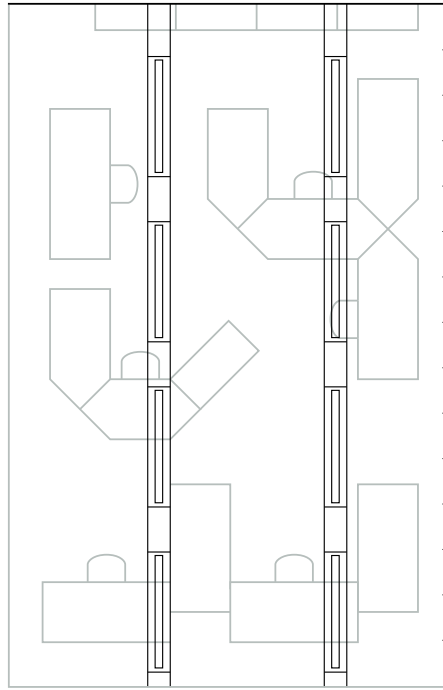

Direct-indirect secondary reflector luminaires for recessed mounting into ceilings for fluorescent lamps.

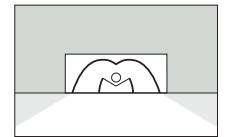
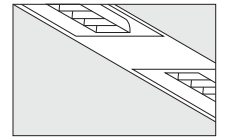

Diffuse, glare-free ambient lighting produced from free-standing ceiling washlights. In addition, each workplace has its own task light.

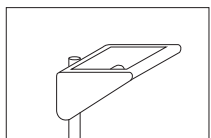

Free-standing ceiling washlight for metal halide lamps.

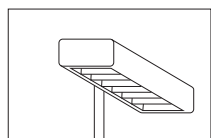

Task light for compact fluorescent lamps.

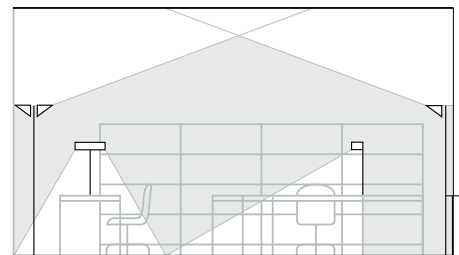
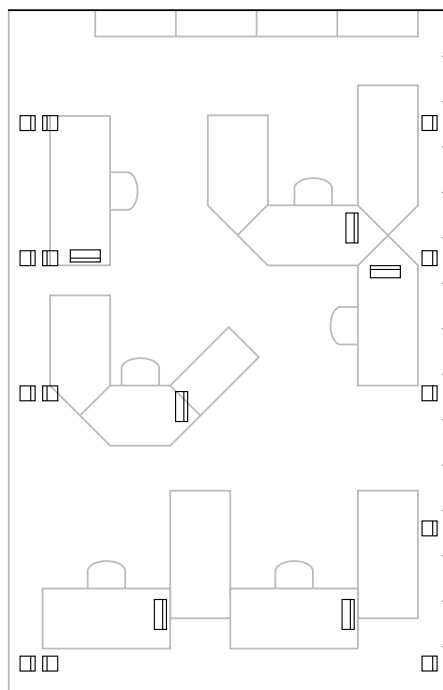

The lighting is provided by a suspended light structure, which takes both direct-indirect luminaires and downlights. This combination allows efficient lighting using fluorescent lamps for office work during the day, and low-voltage downlights for meetings that may take place at the end of the day.

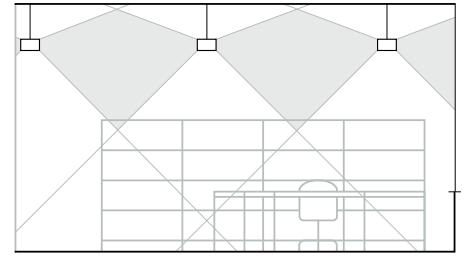
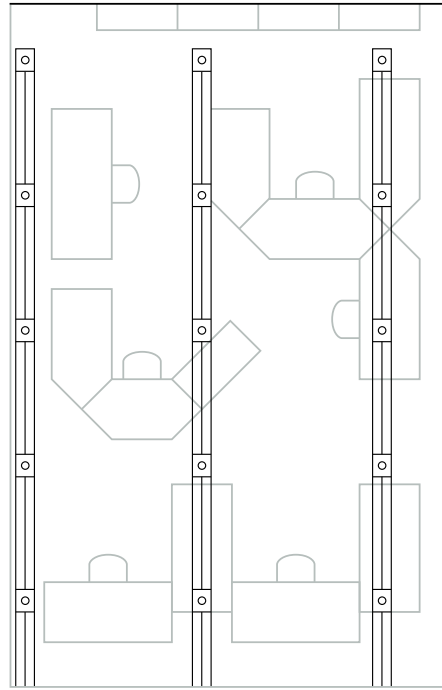

Suspended light structure with integral, direct-indirect luminaires for fluorescent lamps, and integral downlights for low-voltage halogen lamps.

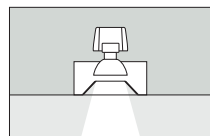
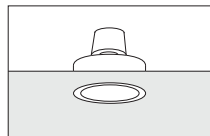
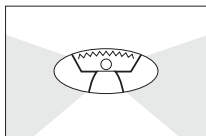
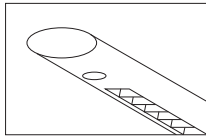

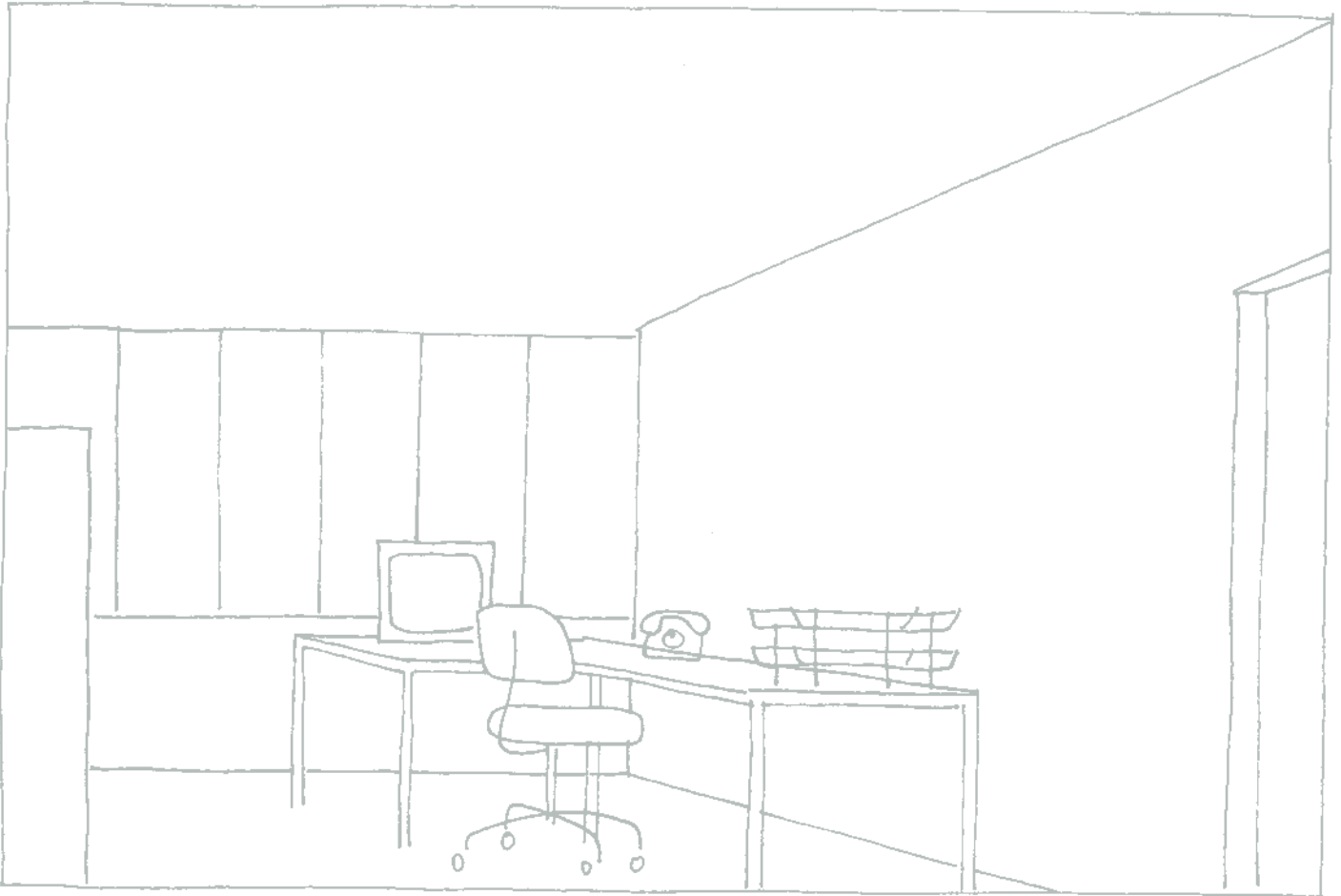

4.6 Cellular offices

The same design criteria basically apply for cellular offices as for team offices. For offices with a high daylight component lower illuminances are sufficient; it is also advisable to install the luminaires so that fixtures near the windows can be switched separately when there is sufficient daylight available.

Whereas in the case of team offices it can be of extreme importance to control the luminance of luminaires, especially in spaces with personal computers, this aspect is not so critical in cellular offices due to the geometry of the space. Disturbing glare, especially reflected glare on display screens, may however be caused by the windows.

Ambient lighting is provided by louvred luminaires for fluorescent lamps arranged parallel to the window. The lighting layout is workplace-related, with lower illuminance in the circulation area between the doors. The wide-angle luminaires make for enhanced contrast rendition; the direct light component is reduced by the linear prismatic lens.

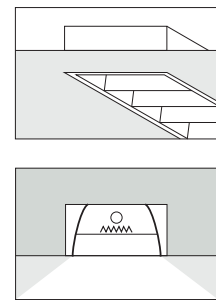
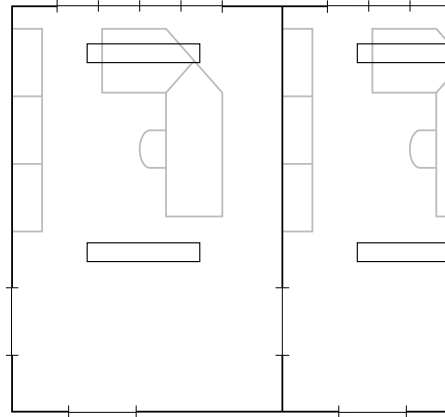

Recessed louvred luminaires for fluorescent lamps.

Integral direct-indirect luminaires for fluorescent lamps and track-mounted spotlights mounted on a light structure suspended in the space. The ambient lighting is workplace-related and is produced by the luminaires for fluorescent lamps. The spotlights are used to accent points of interest on the walls.

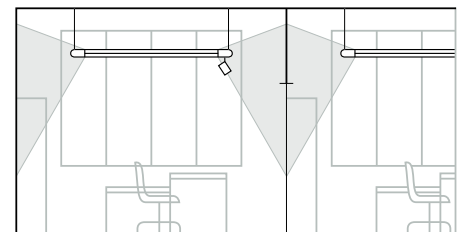
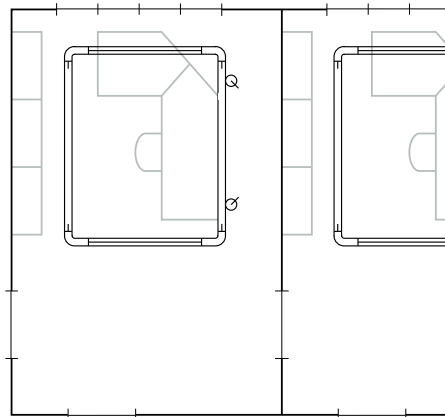

Suspended light structure with integral direct-indirect luminaires for fluorescent lamps and integral track-mounted spotlights.

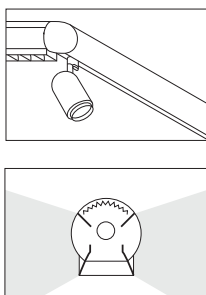

General lighting is provided by recessed secondary reflector luminaires. The ratio of direct and indirect light and glare limitation can be controlled by the appropriate choice of luminaires, which in turn produces the required atmosphere.

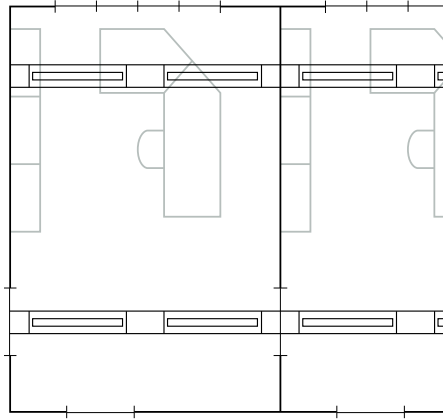

Secondary reflector luminaire for recessed mounting for fluorescent lamps.

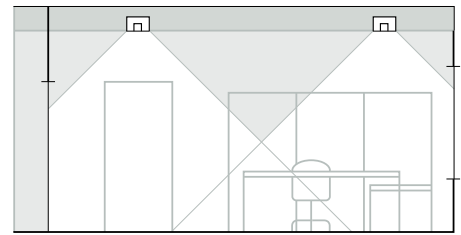
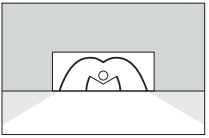
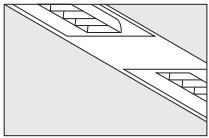

Ambient lighting is provided by a precisely positioned group of four downlights with cross-blade louvres for compact fluorescent lamps.

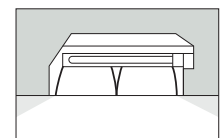
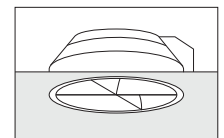
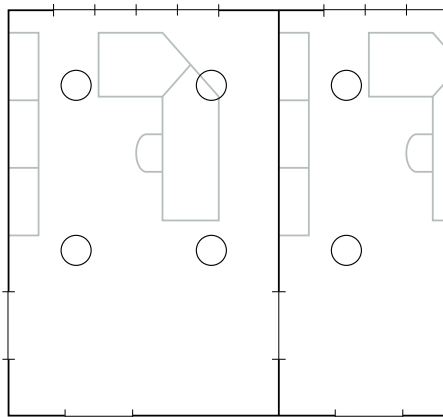

Recessed downlight with cross-blade louvre for compact fluorescent lamps.

Office lighting using louvred luminaires for compact fluorescent lamps. A linear prismatic lens can be inserted above the cross-blade louvre. This produces batwing light distribution, which in turn leads to enhanced contrast rendition.

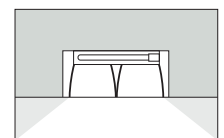
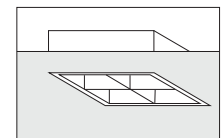
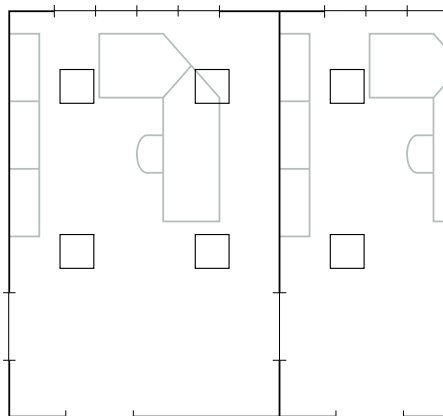

Recessed louvred luminaire for compact fluorescent lamps.

Wall-mounted ceiling washlights provide indirect ambient lighting and create a bright and friendly atmosphere in the space. A task light on the desk provides direct light on the working plane when required.

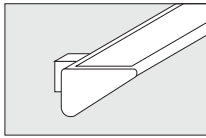
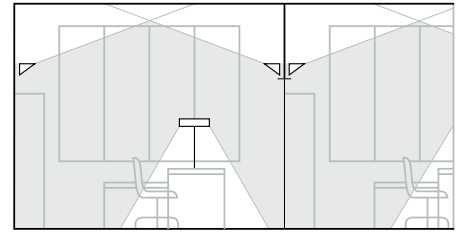
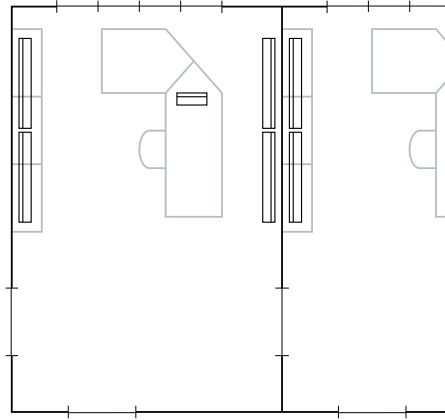

Wall-mounted ceiling washlight for fluorescent lamps or compact fluorescent lamps.

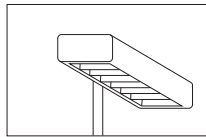

Task light for compact fluorescent lamps.

Track system spanned from wall to wall with low-brightness luminaires as well as spotlights for the accentuation of specific points of interest or importance.

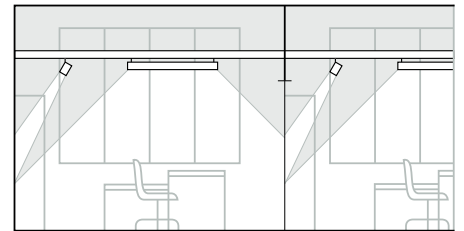
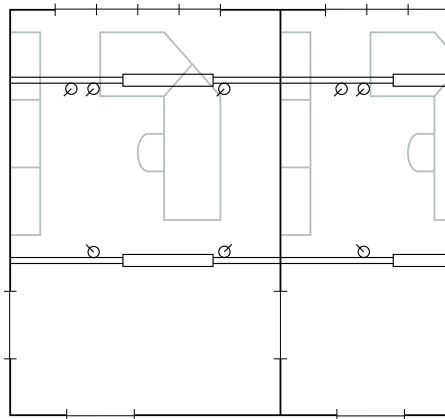

Track system with low-brightness luminaires for fluorescent lamps, and spotlights.

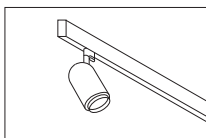
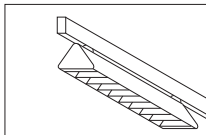

The ambient lighting in the office is provided by four recessed indirect secondary reflector luminaires. The indirect component is reflected into the space by the satin finished reflector. The luminaire layout is workplace-related with lower illuminance in the circulation area.

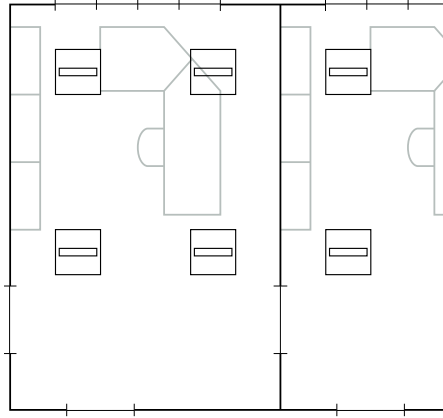

Recessed secondary reflector luminaires for compact fluorescent lamps.

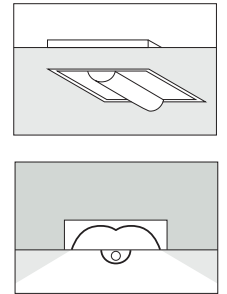

Office lighting illuminance is provided by two suspended light structure elements parallel to the windows, with integral direct-indirect luminaires and integral directional luminaires to accentuate the desk and other points of interest.

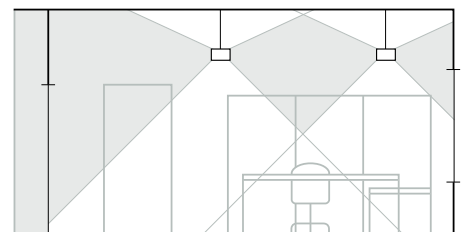
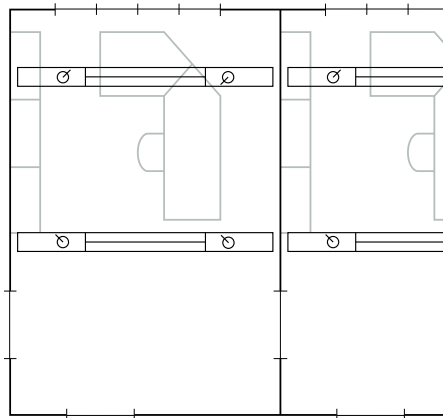

Light structure with integral direct-indirect luminaires for fluorescent lamps and downlights for low-voltage halogen lamps.

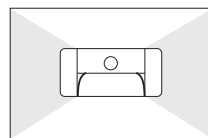
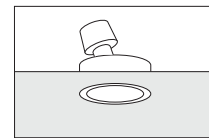
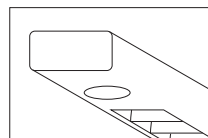

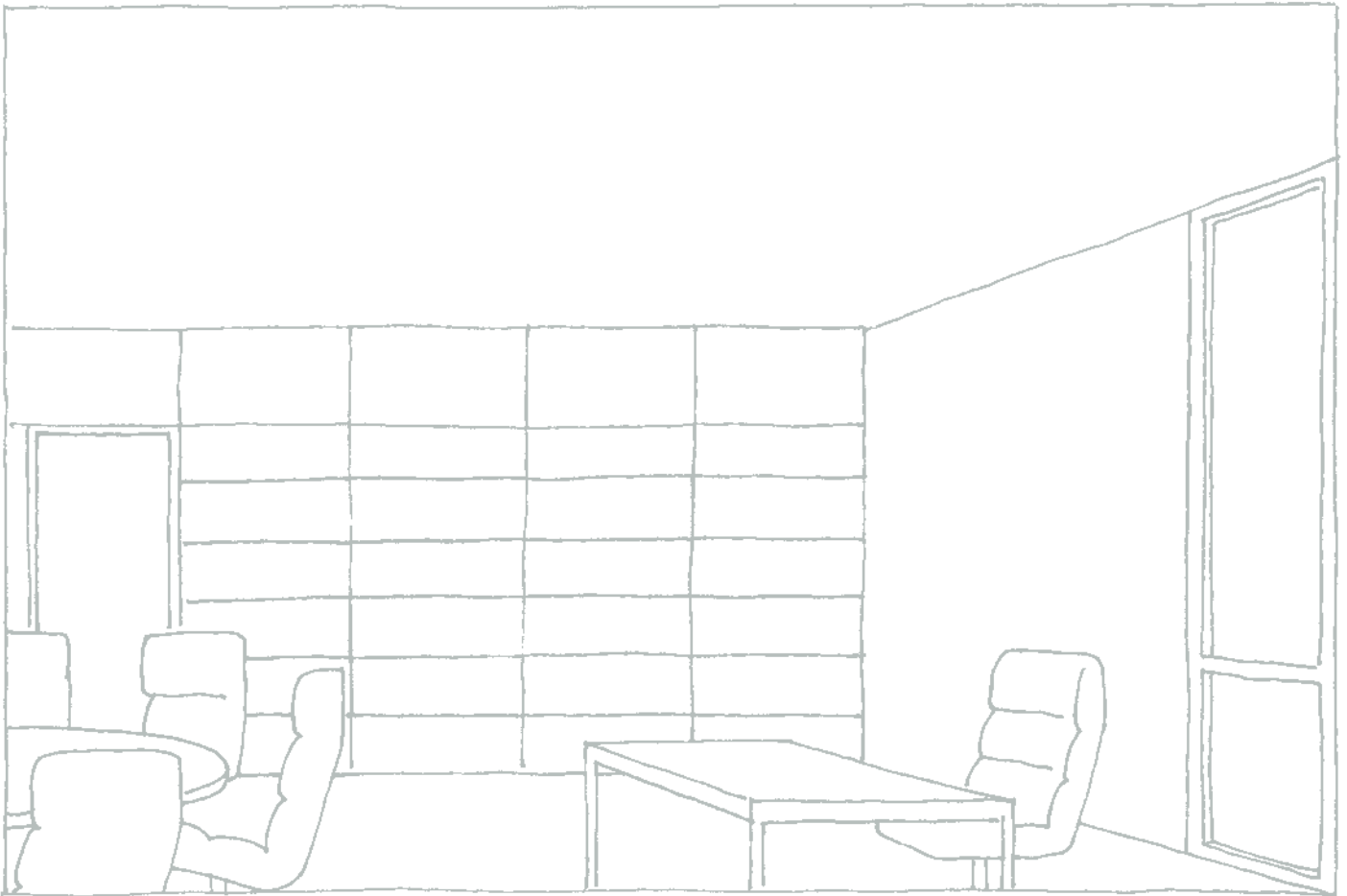

4.7 Executive offices

An office of this kind may be the workplace of a manager or the office of a self-employed person. It consists of a working area and conference area, each area with specific lighting requirements.

In contrast to the purely functional lighting in the other office spaces, atmosphere and prestigious effect are also important aspects in this case.

As rooms of this kind are used for a variety of activities, it is advisable to develop a design concept that allows the switching and dimming of different groups of luminaires to meet changing requirements.

Recessed downlights arranged in a rectangle around the perimeter of the room provide ambient lighting. A task light is installed on the desk.

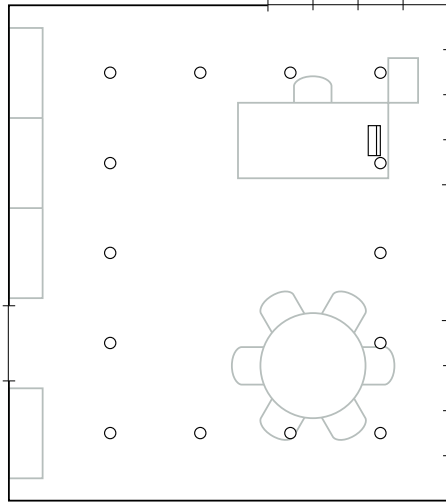

Task light for compact fluorescent lamps.

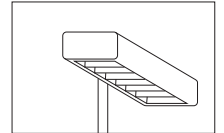

Recessed downlight for general service lamps.

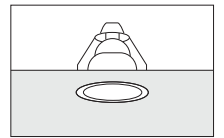

Washlights on the end walls provide the general lighting in the room. The desk receives direct light from two directional spotlights. A group of four downlights accentuate the conference table.

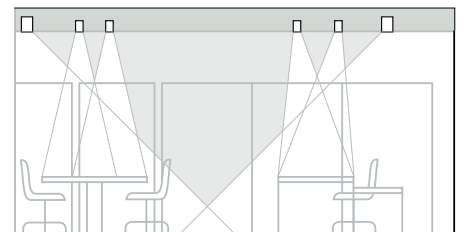
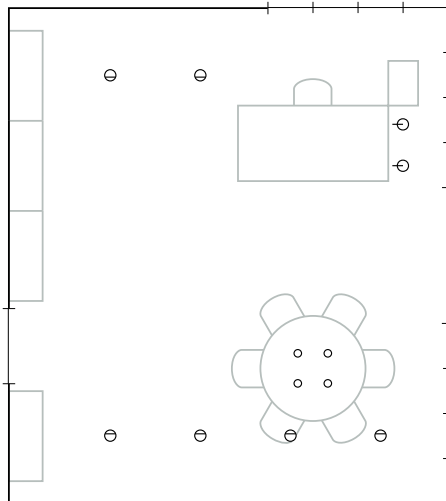

Recessed downlight for low-voltage halogen lamps.

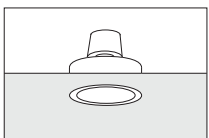

Recessed directional spotlight for halogen reflector lamps.

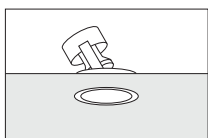

Recessed wallwasher for general service lamps.

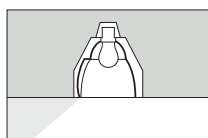
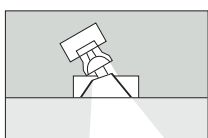
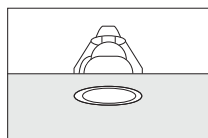

The lighting equipment is mounted on three multifunctional channels that run parallel to the windows. They contain two louvred luminaires for the lighting of the desk, downlights for the illumination of the desk and conference table and directional spotlights to illuminate the cupboards. Outlets are available for spotlights for the illumination of the remaining wall surfaces.

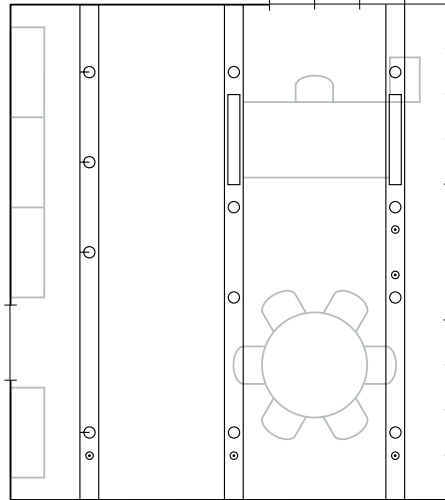

Recessed louvred luminaire for fluorescent lamps.

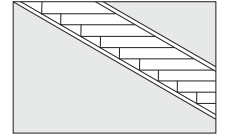

Recessed directional spotlight for halogen lamps.

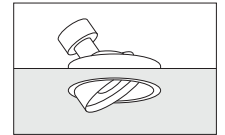

Recessed downlight for halogen lamps.

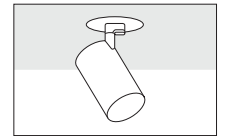
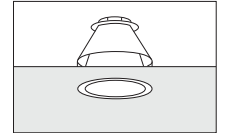

Singlet with spotlight.

Wallwashers aligned with the cupboards provide the ambient lighting. The desk has a task light, a double-focus downlight accentuates the conference table. Surface-mounted spotlights pick out points of interest on the remaining wall surfaces.

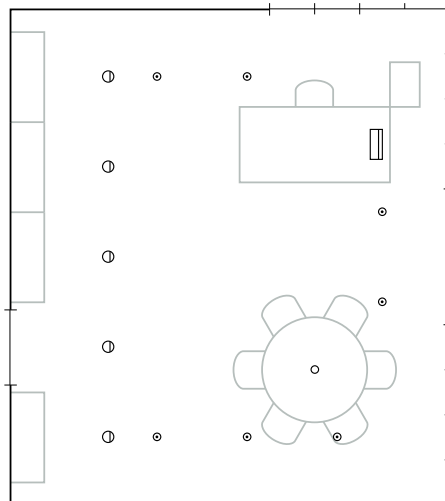

Recessed wallwasher for halogen lamps.

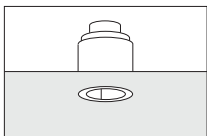

Recessed double-focus downlight for low-voltage halogen lamps.

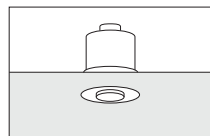

Singlet with spotlight.

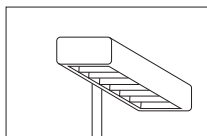
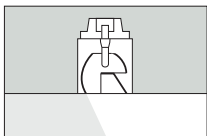
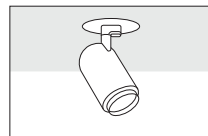

Task light for compact fluorescent lamps.

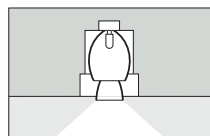

Recessed louvred luminaires illuminate desk and conference table. Track-mounted wallwashers provide vertical lighting on the end walls and produce a bright and friendly atmosphere.

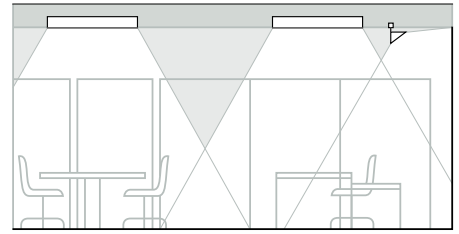
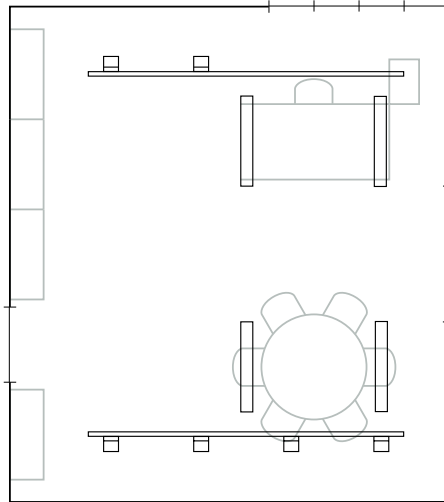

Recessed louvred luminaire for fluorescent lamps.

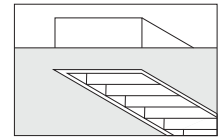

Track-mounted wallwashers equipped with halogen lamps.

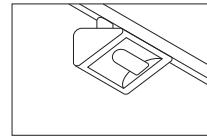

Recessed washlights provide uniform lighting of the wall lined with cupboards and one of the end walls; the reflected light also provides the ambient lighting. Desk and conference table are accentuated by spotlights mounted on a recessed track. Other points of interest are picked out by further spotlights.

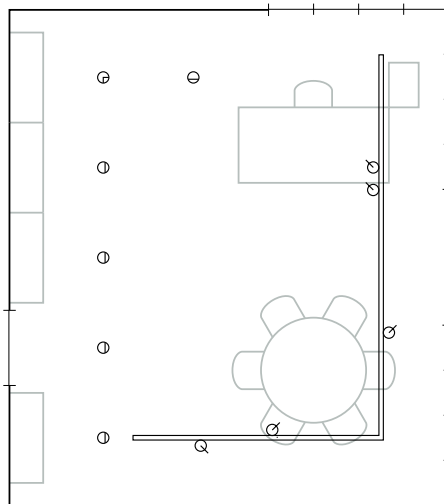

Recessed washlights and corner washlights for general service lamps.

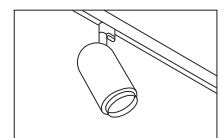
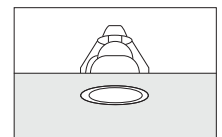

Track with spotlights.

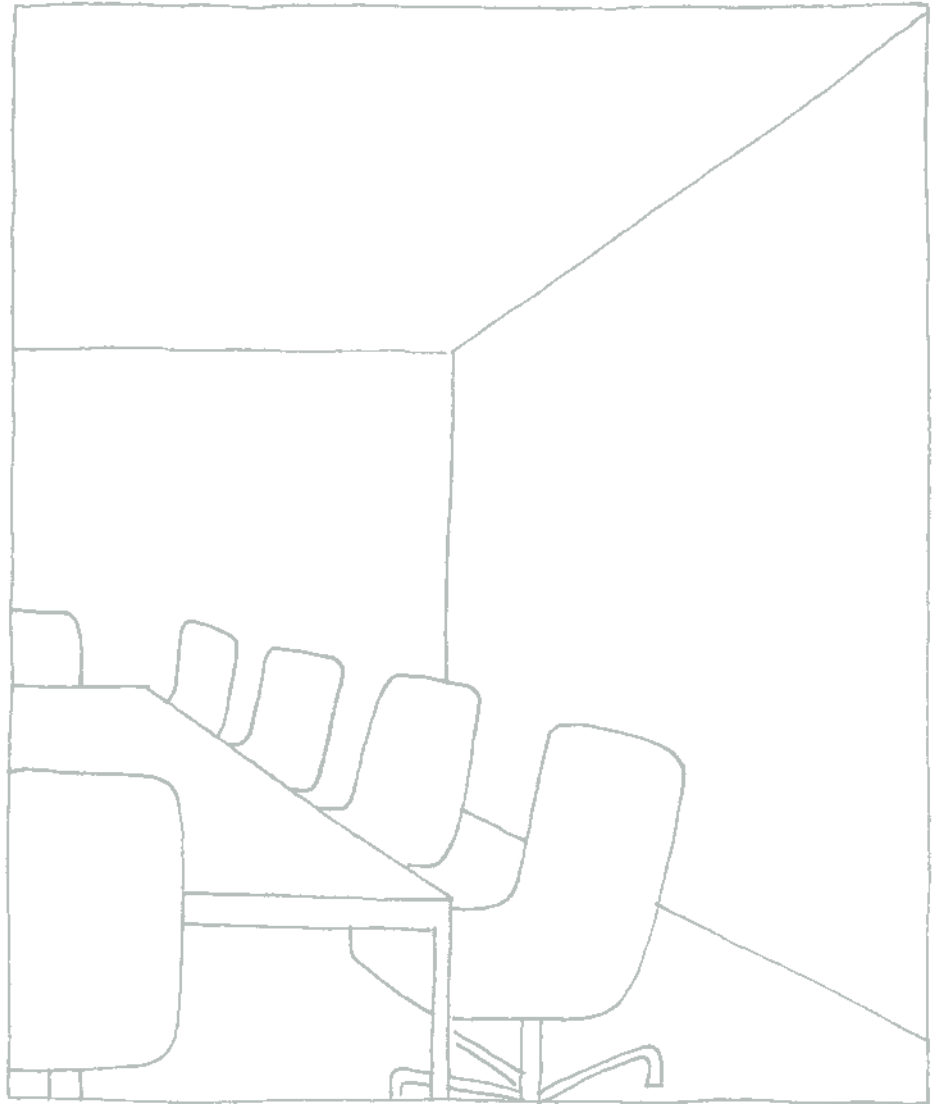

4.8 Conference rooms

Conference rooms are used for a variety of purposes: for discussions, seminars, small-scale presentations, or even a working lunch. The lighting design concept must therefore be multifunctional and include the possibility of creating a prestigious atmosphere.

Conference lighting requires a balanced ratio of horizontal and vertical lighting. Horizontal lighting makes for good shaping qualities and adequate brightness. Vertical components produce a bright and friendly atmosphere and promote communication. Extreme direct or diffuse light conditions should be avoided.

The presentation of pictures, products, notes made on the board or on a flip-chart require additional accent lighting on the end walls of the conference room. The lighting on the walls must be reduced to a suitable level to allow people to write by when slides or overhead foils are projected. It is therefore practical to plan a lighting installation comprising circuits which can be switched and dimmed separately, or even a programmable lighting control system, which allows preprogrammed scenes to be recalled at the touch of a button.

Ceiling washlights provide indirect light for the general lighting of the room. The end walls can be illuminated by track-mounted spotlights or washlights, if required. Two rows of recessed downlights provide direct light on the table, which can serve as the main lighting for a working lunch or dinner, or for people to write by when slides are being shown.

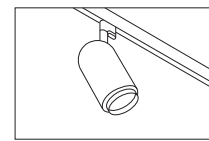
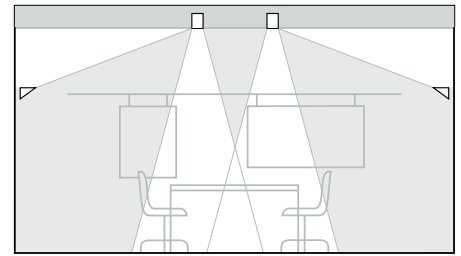
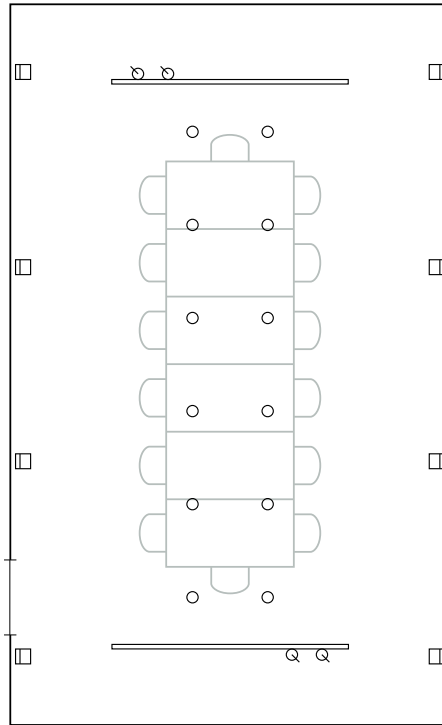

Track with spotlights.

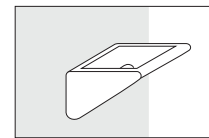

Wall-mounted ceiling washlight for halogen lamps.

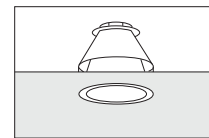

Recessed downlight for halogen lamps or general service lamps.

Secondary luminaires arranged along the side walls provide general lighting with balanced horizontal and vertical components. The luminaire design, which harmonizes with the geometry of the space makes for optimum control of direct and reflected glare. Two rows of downlights for recessed mounting in the ceiling provide direct, prestigious light on the table, which can serve as the main lighting for a working lunch or dinner, or for people to write by when slides are being shown. Track-mounted spotlights in front of the end walls can be used to accentuate visual aids.

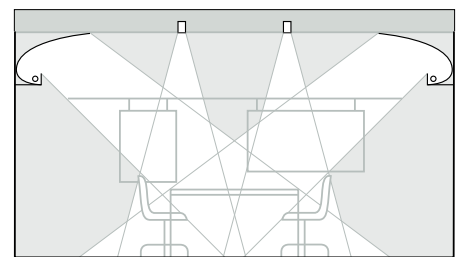
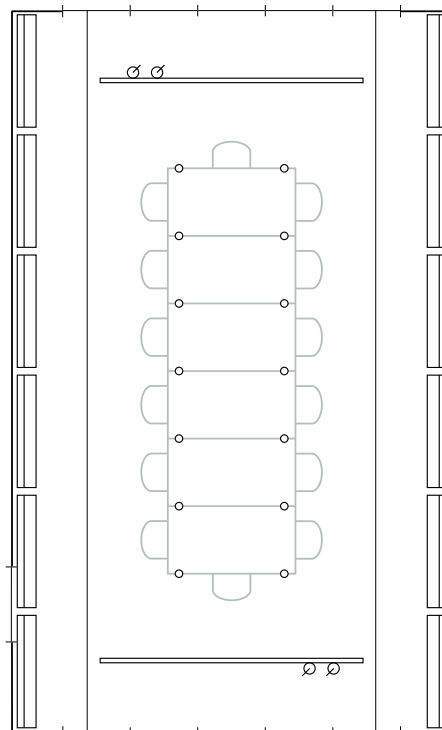

Recessed downlight for low-voltage lamps.

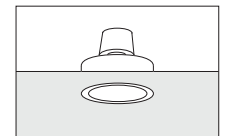

Integral secondary luminaire for fluorescent lamps.

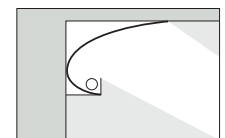

Track with spotlights.

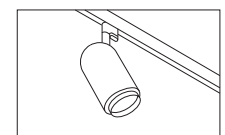

Direct-indirect luminaires suspended above the table provide ambient lighting in line with the layout or the office furniture. Downlights arranged along the side walls brighten the overall environment. The end walls can receive additional lighting via wallwashers; luminaires along the side walls can be dimmed to provide lower lighting levels, for example, for people to write by when slides are being shown.

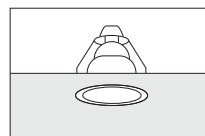
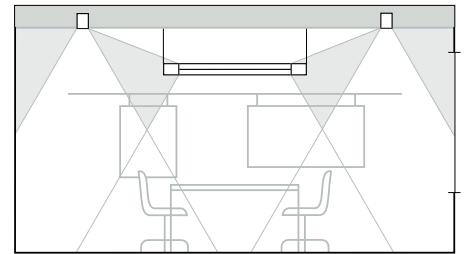
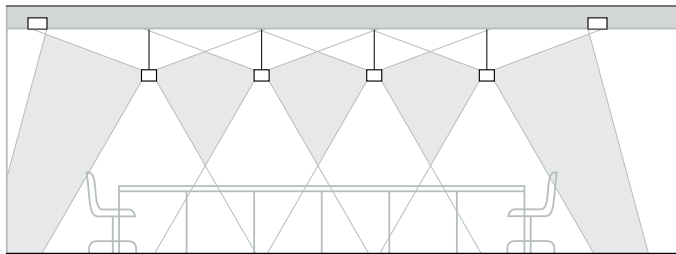
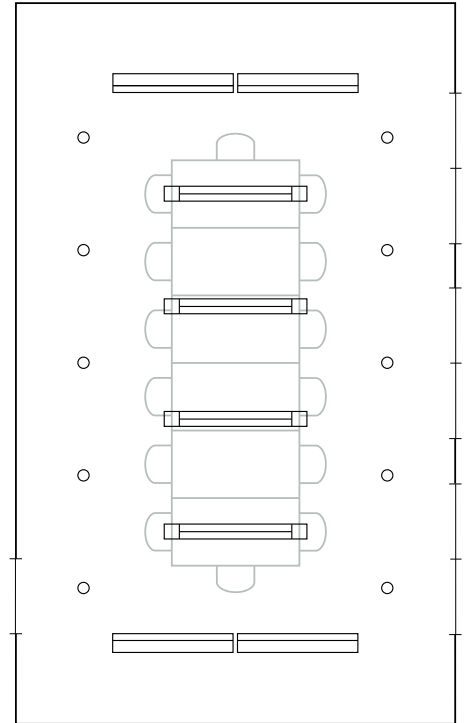

Recessed downlight for halogen lamps or general service lamps.

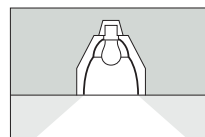

Pendant direct-indirect luminaire for fluorescent lamps.

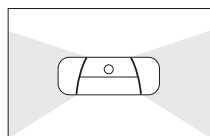
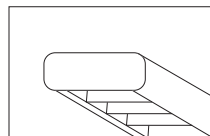

Recessed wallwasher for fluorescent lamps.

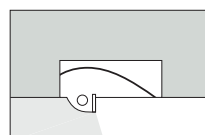
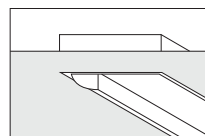

The lighting is installed in a suspended ceiling positioned at a set distance to the walls. The light consists of two rows of low-voltage downlights, which produce specular effects on the surface of the table. These downlights comprise the main lighting on representative occasions or light for people to write by in the case of slide projections. Above the edge of the ceiling there are tracks with washlights for indirect lighting, and spotlights. The spotlights and the washlights, which have fluorescent lamps, adjacent to the side and end walls can be switched and dimmed separately.

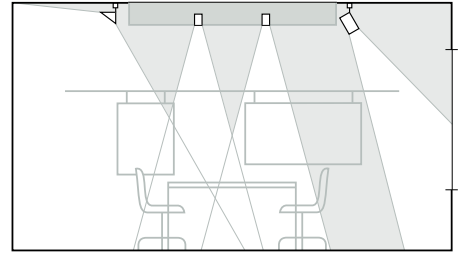
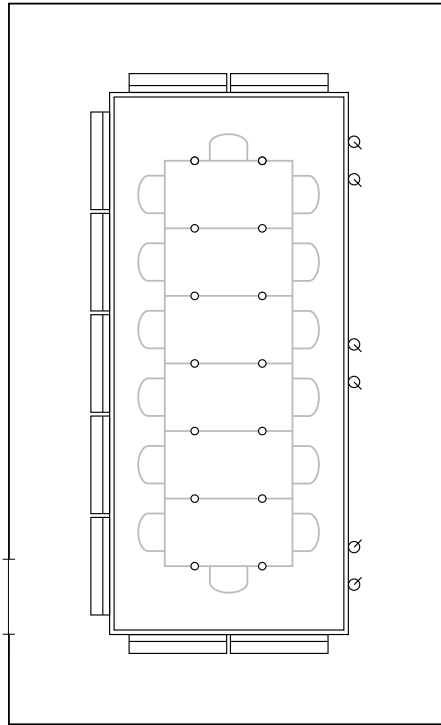

Recessed downlights for low-voltage lamps.

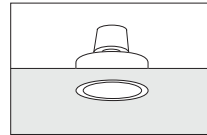

Track with spotlights and wallwashers for fluorescent lamps.

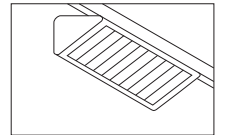
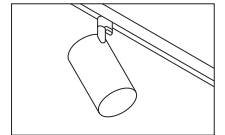

Washlights provide direct lighting over the table and ambient lighting by the light reflected by the walls. The luminaires are equipped with general service lamps, which means that they can be easily dimmed to the required lighting level; the alignment of the lighting to the seating ensures optimum visual comfort. The pairs of luminaires nearest the end walls can be switched separately for projection lighting. Tracks mounted parallel to the end walls can take spotlights for the illumination of the walls or presentations.

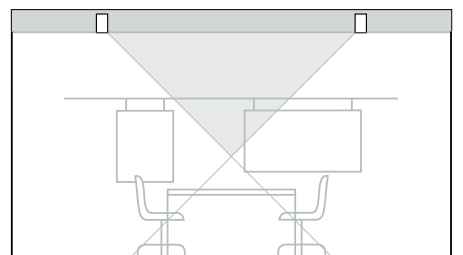
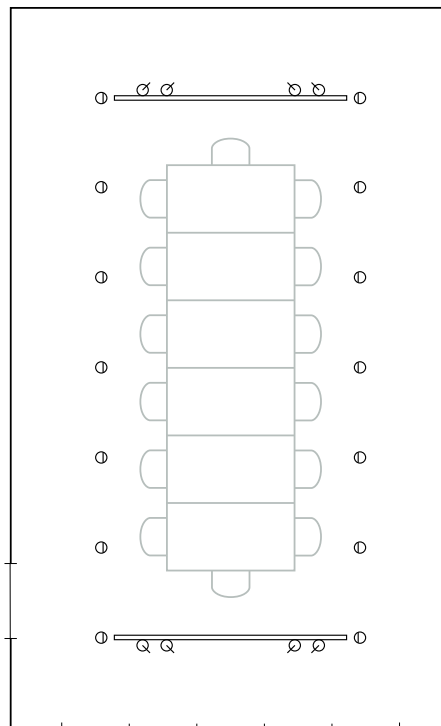

Downlight for general service lamps.

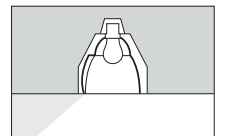
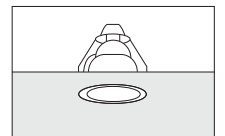

Track with spotlights.

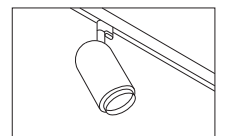

Luminaires equipped with fluorescent lamps and mounted on a suspended light structure provide the lighting over the table. Dimmable wallwashers for halogen lamps are mounted on the end sections. Spotlights accentuate points of interest on the walls. The latter can be dimmed during slides projections to provide light to write by.

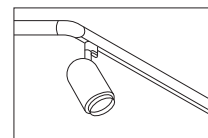
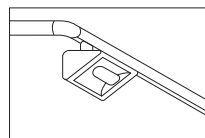
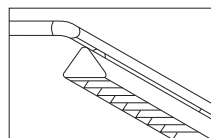
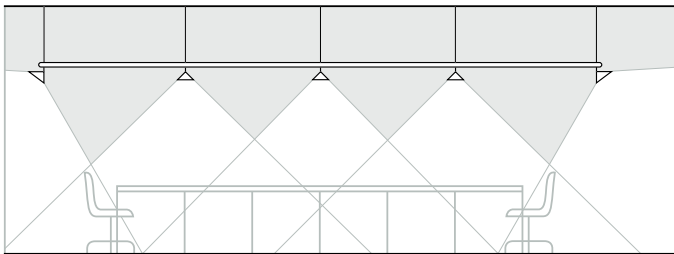
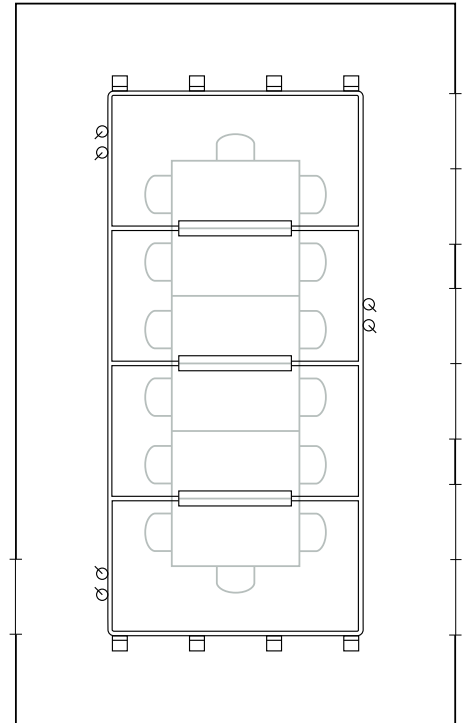

Light structure with louvred luminaires for fluorescent lamps, wallwashers for halogen lamps and spotlights.

General lighting in the conference room is provided by a series of wallwashers. Downlights equipped with general service lamps provide light to write by. Tracks mounted parallel to the end walls can take spotlights for the illumination of the walls or demonstrations.

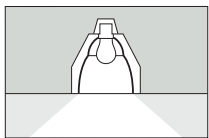
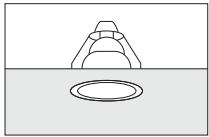
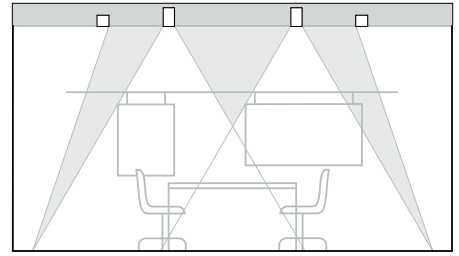
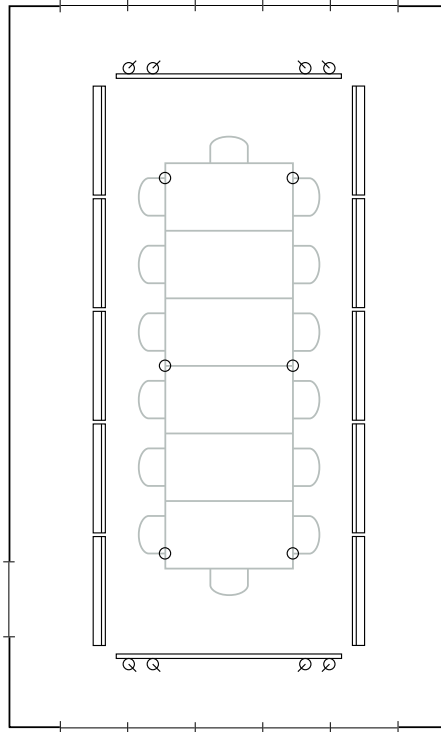

Recessed downlight for general service lamps.

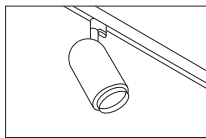

Track with spotlights.

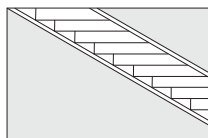

Recessed wallwasher for fluorescent lamps.

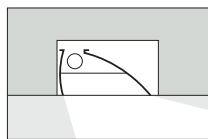

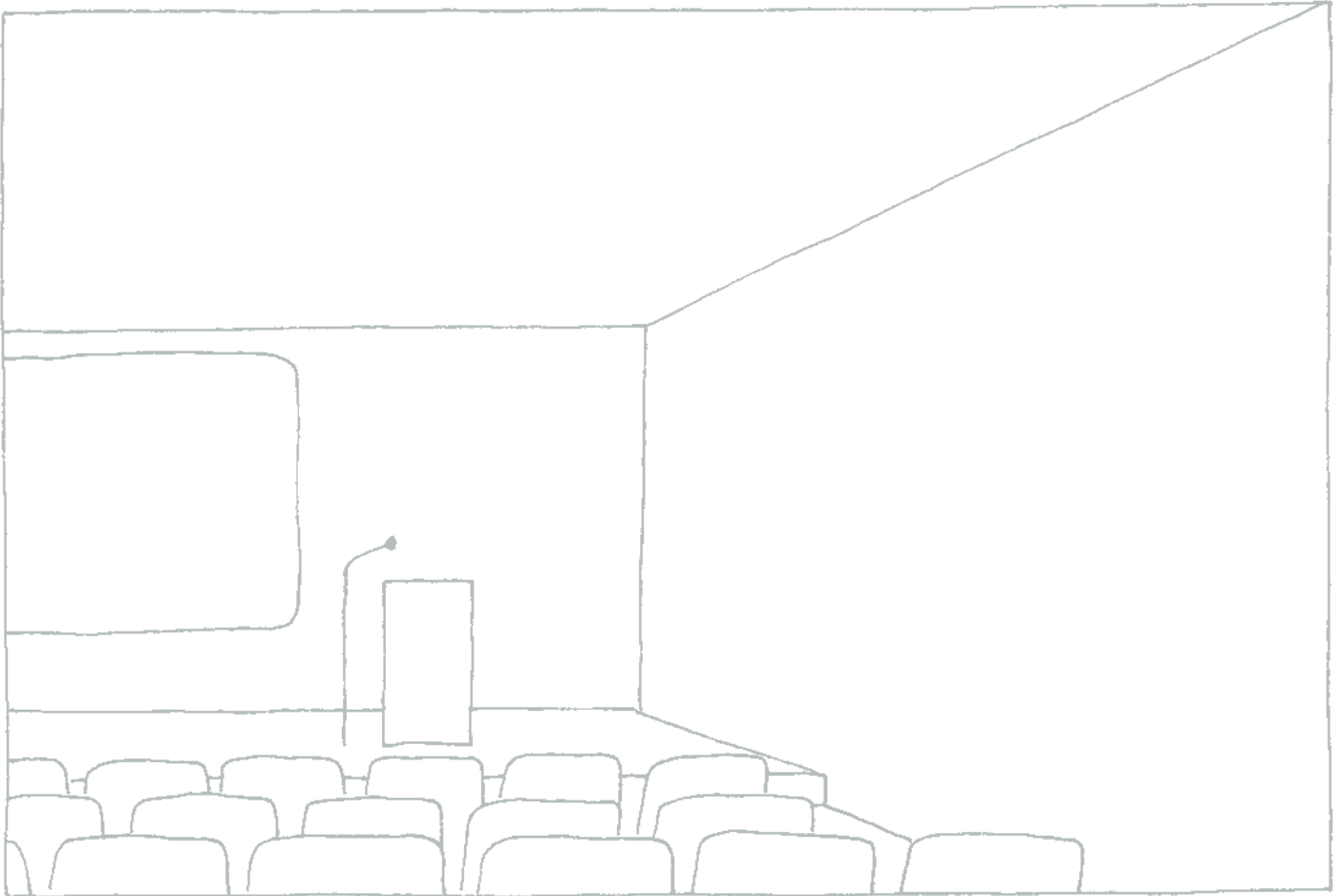

4.9 Auditoriums

Auditoriums are rooms that can be used to give a variety of talks or presentations to an audience. They may be used simply for the presentation of special papers, for talks supported by slide, film or video projectors, or overhead projectors, for experimental demonstrations and product presentations or for podium discussions and seminars. Lighting for auditoriums should therefore be based on a multi-functional concept which allows the lighting to be adapted to meet a variety of different requirements.

The main feature of the lighting in auditoriums is the functional separation of speaker's platform from the audience. On the speaker's platform the lighting is focussed on the speaker, or on the objects or experiments presented. When overhead foils, slides, films and videos are shown the lighting must be reduced – especially the vertical lighting on the end wall – so as not to interfere with the projections.

In the area where the audience are seated the lighting primarily serves the purpose of orientation and allows people to take notes. During slide projections and the like the lighting is reduced to a level for people to write by. It is important that the lighting should allow eye contact between the speakers and the audience, and between the people in the audience, to allow and promote discussion, interaction and feedback.

Recessed wallwashers illuminate the end wall of the auditorium. Downlights that can be switched and dimmed separately plus a series of singlets for additional spotlights provide accent lighting on the speaker's platform.

The lighting over the seating area consists of two components. Downlights for compact fluorescent lamps arranged in a staggered pattern provide ambient lighting during the talk. A series of dimmable downlights for halogen lamps are arranged between the first set of downlights and provide controllable lighting when slides are being shown. Both luminaire types can be operated separately or in unison.

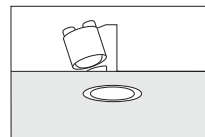
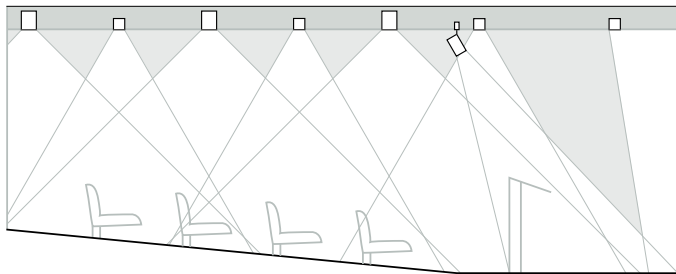
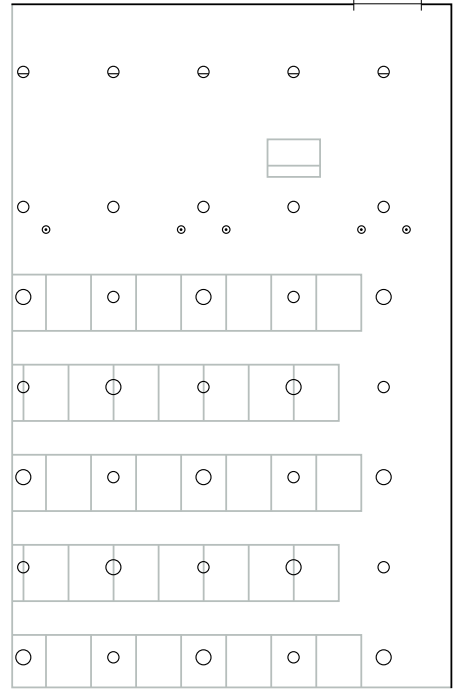

Recessed downlight-wallwasher for PAR 38 reflector lamps.

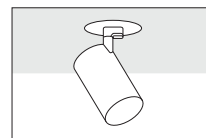
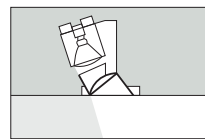

Singlet with spotlight.

Recessed downlight for compact fluorescent lamps.

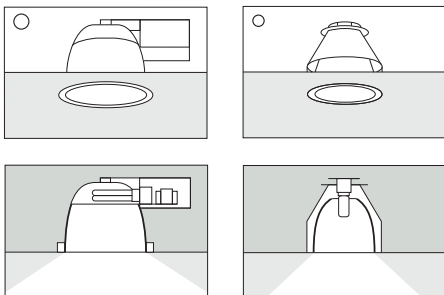

Recessed downlight for halogen lamps.

A row of wallwashers illuminate the end wall. The speaker's platform is accentuated by track-mounted spotlights.

Wallwashers arranged along the side walls provide light for orientation. There is also a series of recessed double-focus downlights for halogen lamps arranged in a regular pattern across the ceiling. This set provides lighting during the talk and can be dimmed down to allow people to take notes during slide or video projections.

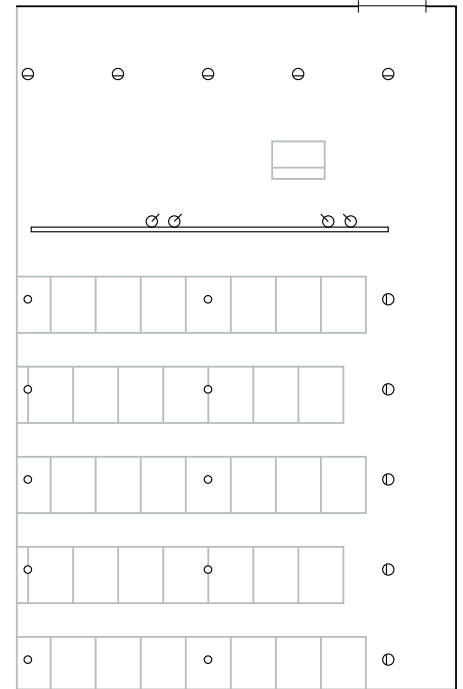

Recessed double-focus downlight for halogen lamps.

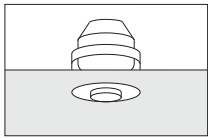

Recessed wallwasher for halogen lamps.

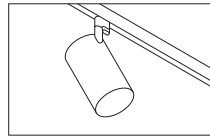
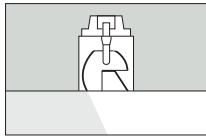
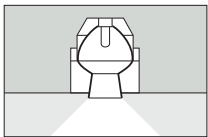
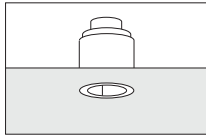

Track with spotlights.

The ambient lighting in the auditorium is provided by louvred luminaires aligned to the long side walls and a series of dimmable downlights in alternate rows between them. This pattern is continued on the speaker's platform in a condensed form. The end wall receives additional lighting from a series of wallwashers. Singlets along the side walls can take additional spotlights to accentuate special points of interest, if required.

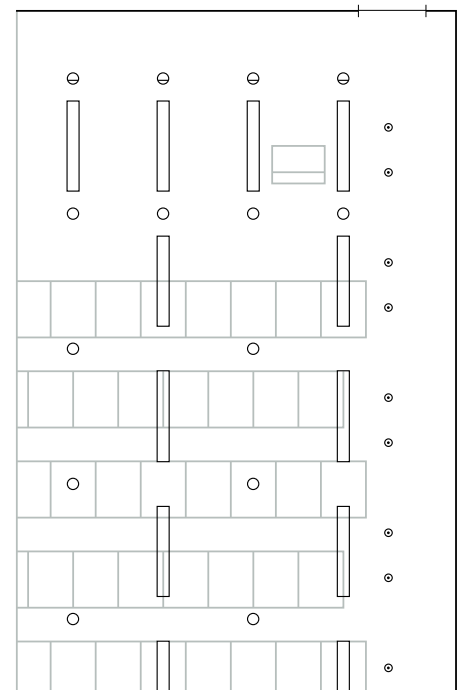

Recessed louvred luminaire for fluorescent lamps.

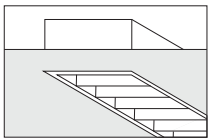

Downlight-wallwasher for general service lamps.

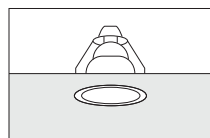
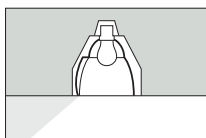
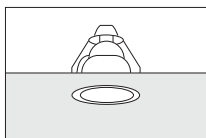

Recessed downlight for general service lamps.

Singlet with spotlight.

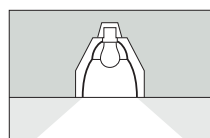
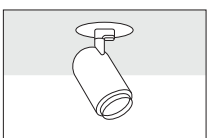

Two runs of track over the speaker's area take wallwashers for the illumination of the end wall and spotlights for accent lighting.

Floor washlights positioned along one side wall in the auditorium section provide lighting for orientation. The main lighting is provided by a suspended light structure with direct-indirect luminaires for fluorescent lamps and dimmable downlights for low-voltage halogen lamps.

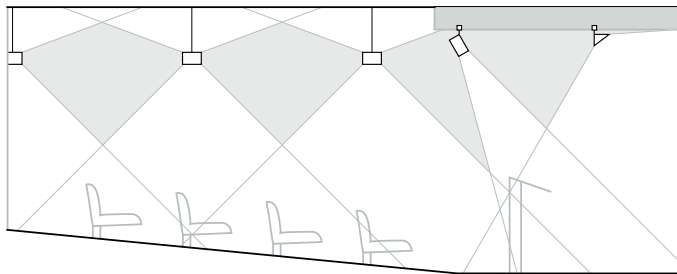
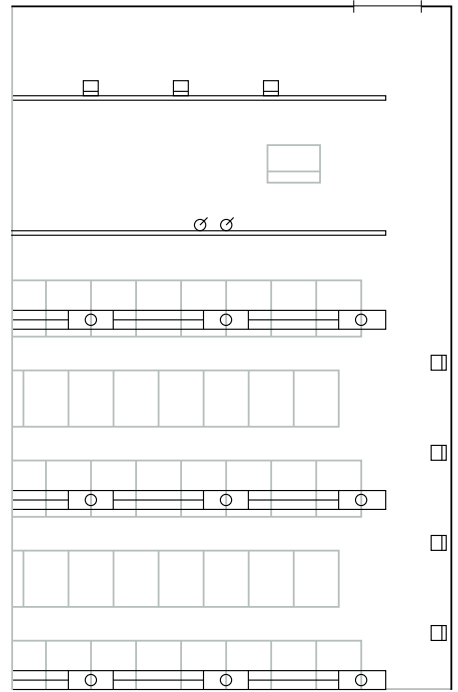

Track with spotlights and wallwashers for halogen lamps.

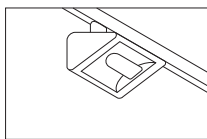
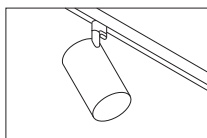

Wall-mounted floor washlight for compact fluorescent lamps.

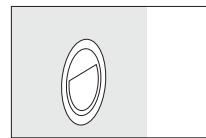
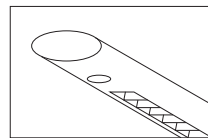

Suspended light structure with integral direct-indirect luminaires for fluorescent lamps and integral downlights for low-voltage halogen lamps.

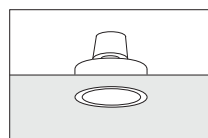
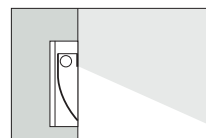
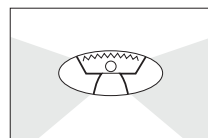

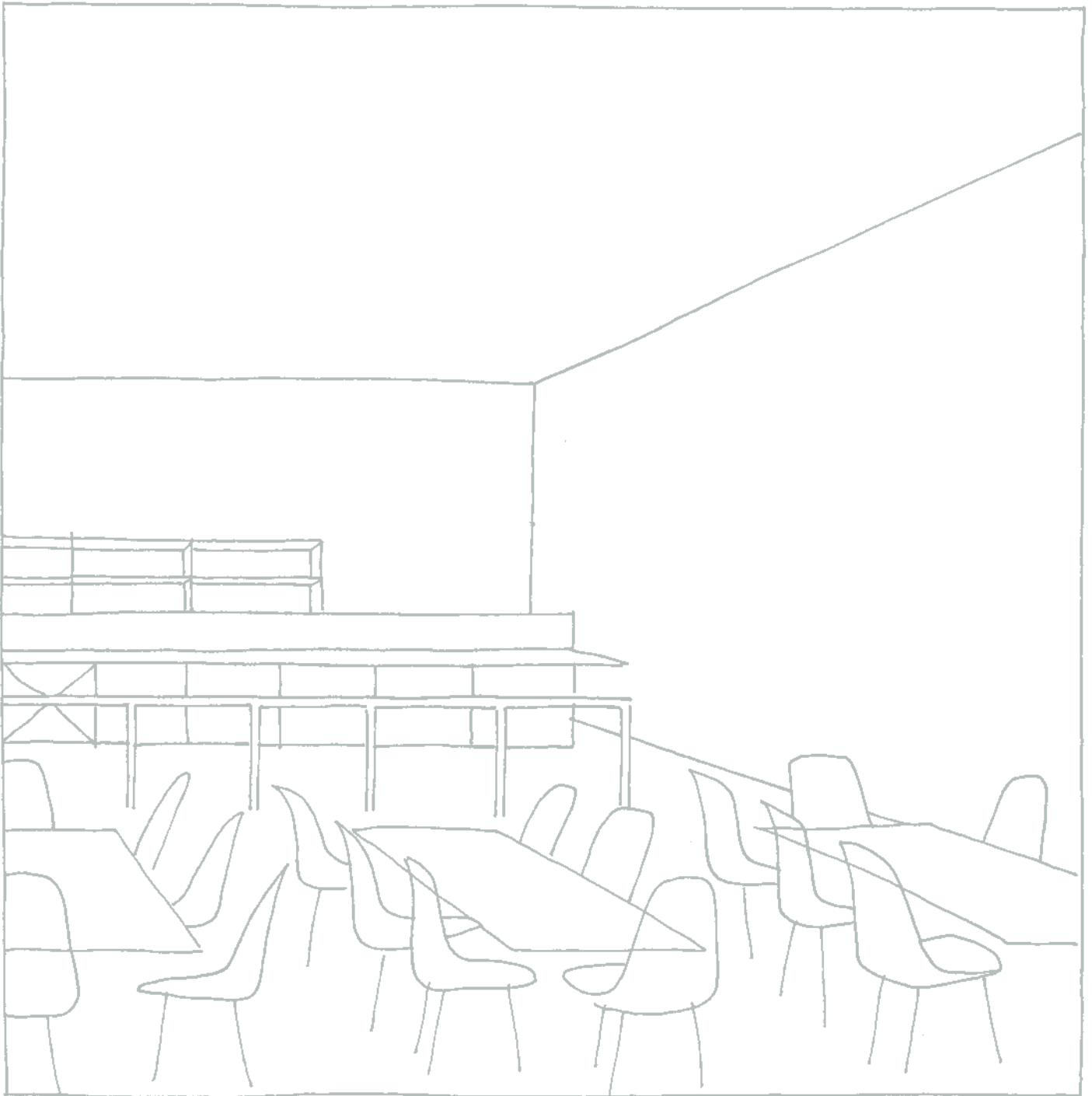

4.10 Canteens

Canteens are spaces where large numbers of people are provided with meals. The food is generally served from a counter; people eating in canteens are only there for a short period of time. The lighting design concept should also allow for the space to be used for other functions such as parties or meetings.

The prime objective is to provide an efficient lighting installation with high average illuminance levels. The atmosphere in the room should be bright and friendly with sufficient vertical lighting to make for a communicative atmosphere. It is advisable to plan a second component that can be switched separately when brilliant, warm white light is required for festive lighting for a party or a large gathering.

The lighting is provided from a suspended light structure. The ambient lighting comes from luminaires for fluorescent lamps mounted beneath the structure. Spotlights are mounted in track below the light structure to provide accent lighting over the counter.

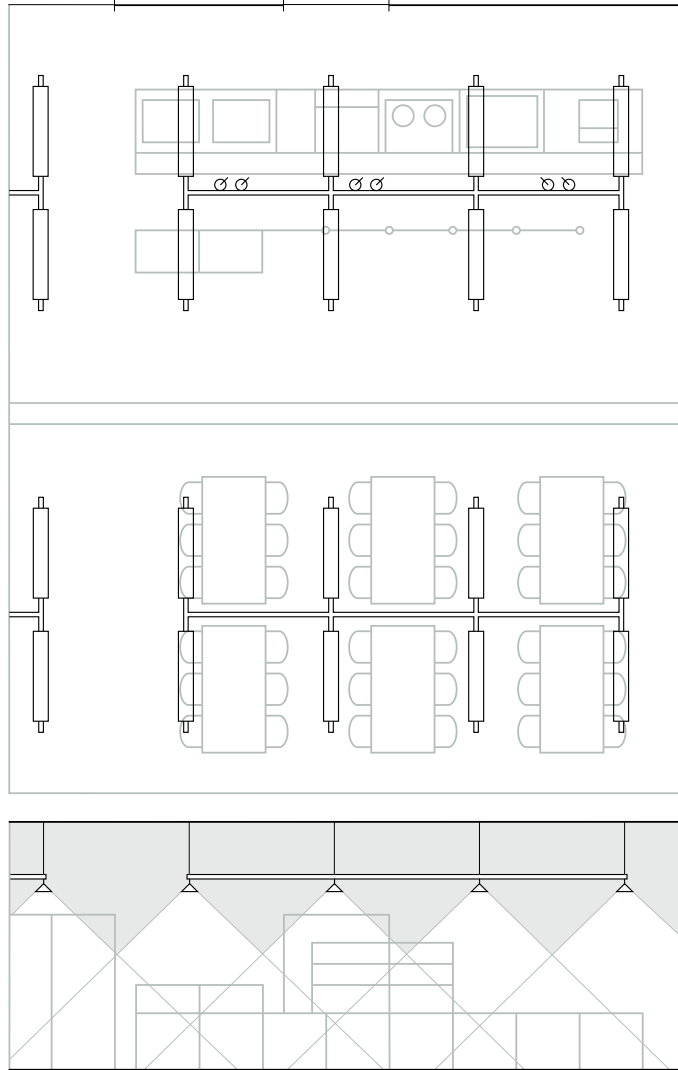

Light structure with luminaires for fluorescent lamps and integral track for spotlights.

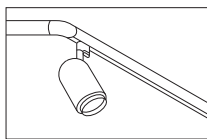
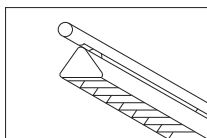

A staggered arrangement of square louvred luminaires equipped with compact fluorescent lamps provide efficient ambient lighting. A series of recessed downlights for halogen lamps arranged alternately between the louvred luminaires create a prestigious atmosphere. The louvred luminaires and the downlights can be switched separately or in unison.

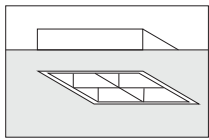

Recessed louvred luminaire for compact fluorescent lamps.

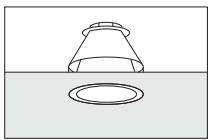

Recessed downlight for halogen lamps.

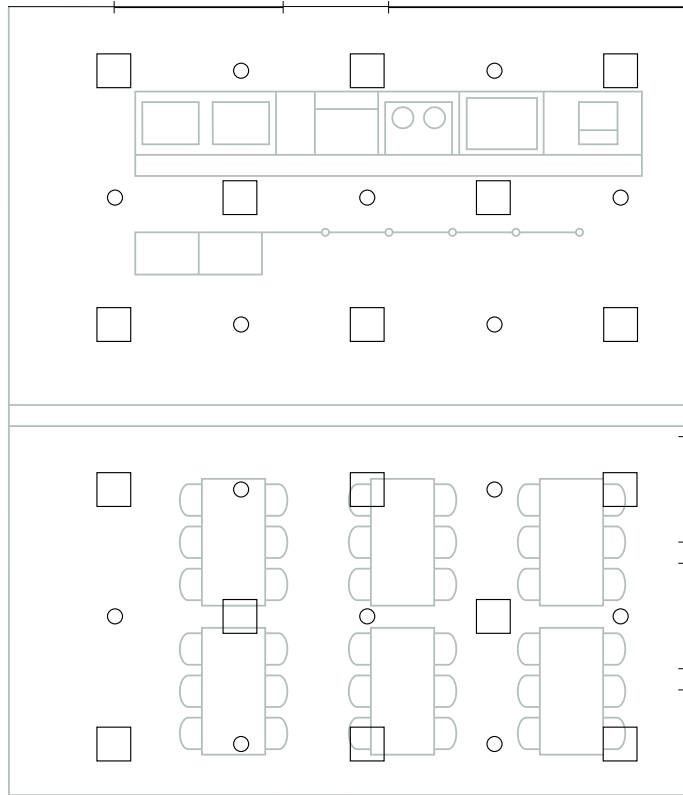

A combination of fluorescent and halogen lighting. The fixtures used are louvred luminaires equipped with conventional fluorescent lamps and arranged in parallel rows throughout the space. The counter area is accentuated by positioning the luminaires closer together.

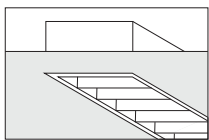

Recessed louvred luminaire for fluorescent lamps.

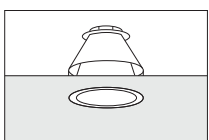

Recessed downlight for halogen lamps.

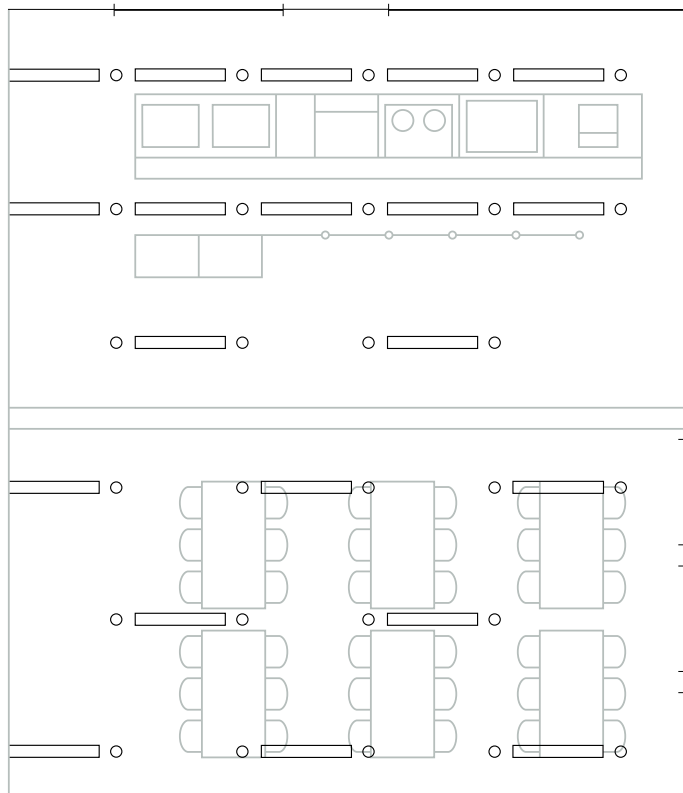

Efficient, uniform lighting of the canteen is achieved by direct-indirect luminaires equipped with fluorescent lamps and mounted on a suspended light structure arranged in parallel rows throughout the space.

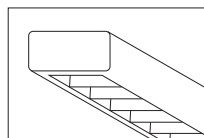
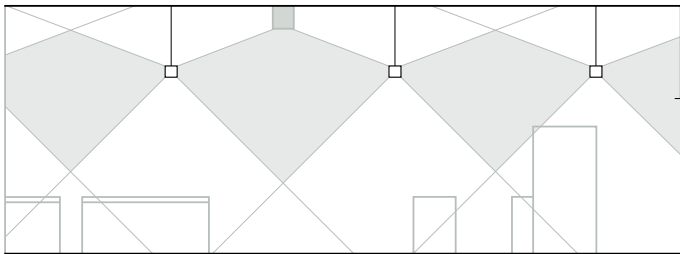
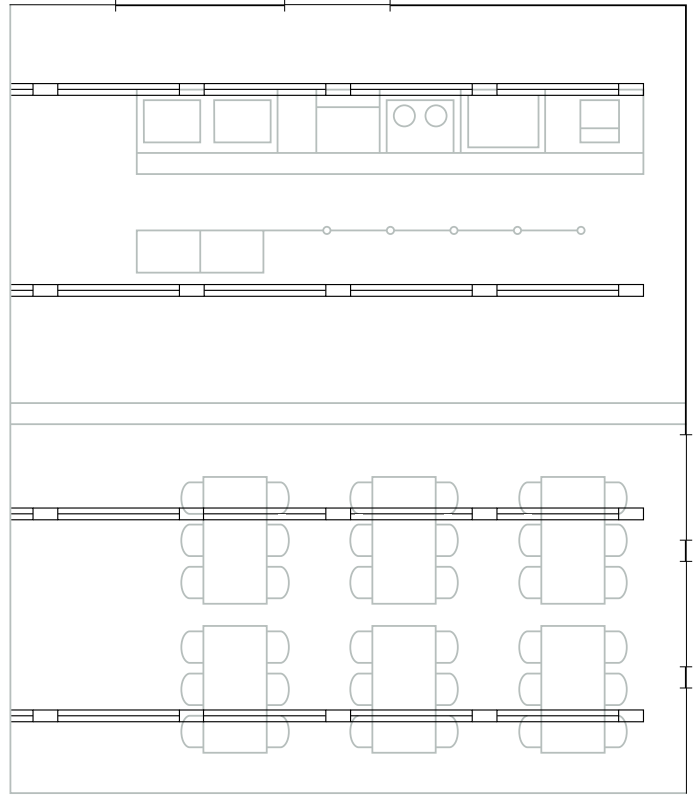

Suspended light structure with direct-indirect luminaires for fluorescent lamps.

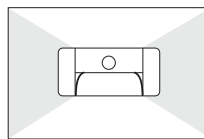

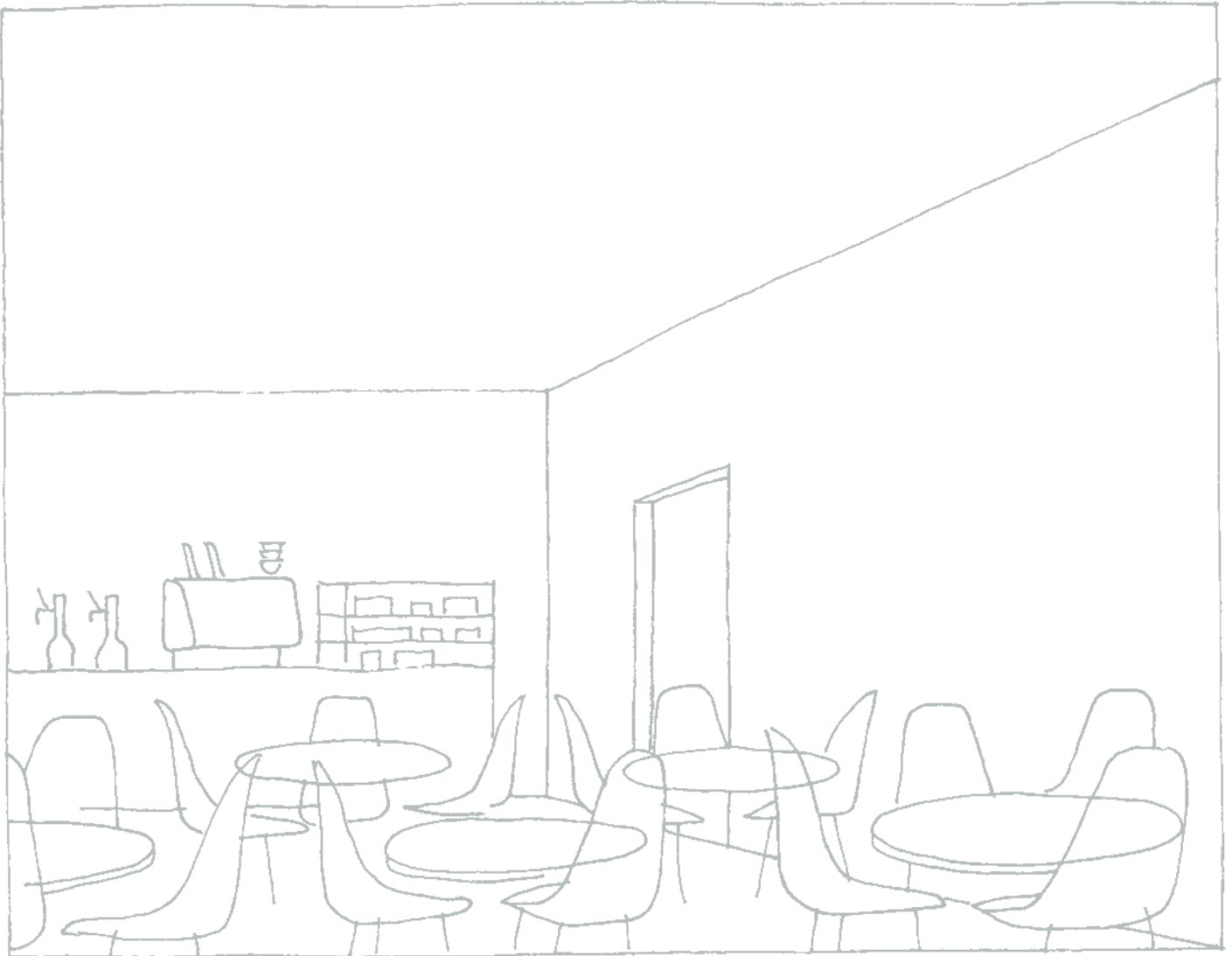

4.11 Cafés, bistros

The term café, or bistro, covers a variety of catering establishments that offer a service somewhere between the functional canteen and the up-market restaurant; a spectrum ranging from fast food restaurant to ice-cream parlours and cafés to bistros. The clientele comprises small groups who tend to stay for longer periods of time, using the establishment as a meeting place as well as somewhere to eat.

In contrast to the canteen, the lighting required in this case is of a more prestigious nature, the lighting level on the whole lower. The interior design and the accentuation of the individual tables is more important here than efficient, overall lighting. The objective nevertheless is not to produce very low ambient lighting with strongly illuminated and well defined individual areas (tables); the entire space should be generally bright and friendly and promote a communicative

atmosphere. The actual lighting design concept depends to a large extent on the required atmosphere and the target clientele. It may range from uniform lighting concepts to the integration of dramatic forms of lighting and lighting effects.

Cafés and bistros are open throughout the day, which results in different lighting requirements by day and by night. It is therefore advisable to develop a concept that allows different components to be switched and dimmed separately, or to include a programmable lighting control system.

Three rows of track are proposed to run the length of the space. Wallwashers are mounted on the track nearest the wall, producing reflected light for the ambient lighting. Spotlights are mounted on the track aligned with the position of the tables. The counter is accentuated by a row of decorative downlights installed in a suspended ceiling.

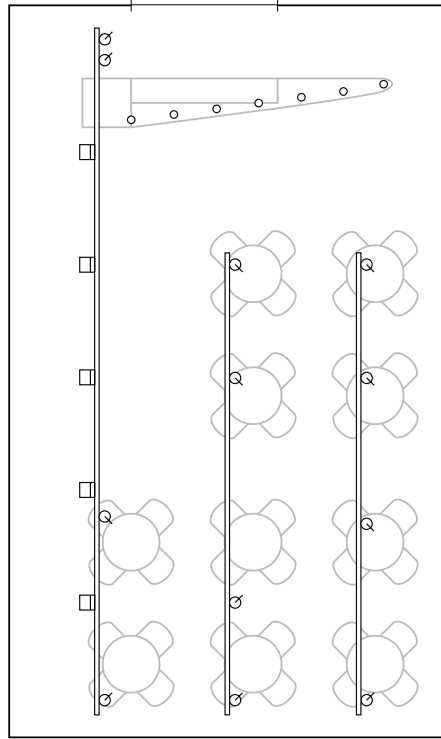

Track with spotlights and wallwashers.

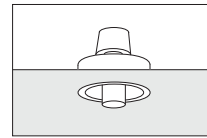
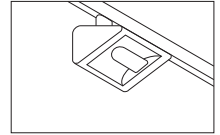
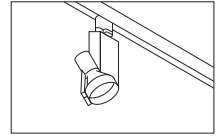

Decorative recessed downlight for low-voltage halogen lamps.

Ceiling-mounted light structure with direct luminaires arranged in a diagonal pattern across the ceiling provides the lighting on the tables. Surface-mounted downlights accentuate the counter. A series of singlets along one side wall allow the installation of spotlights to pick out focal points.

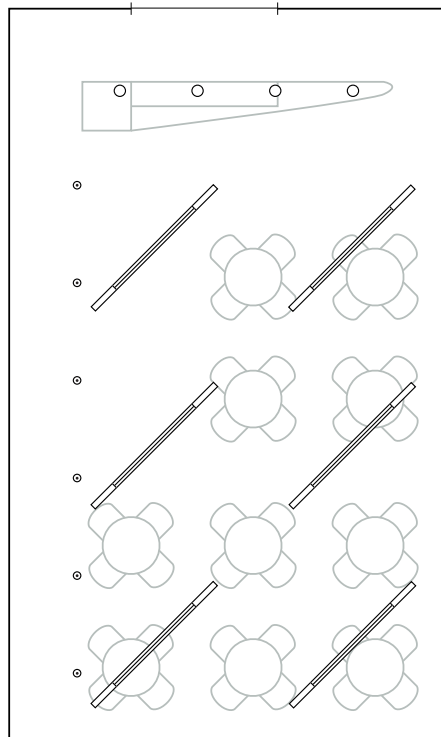

Surface-mounted downlight for halogen lamps.

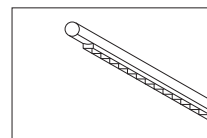
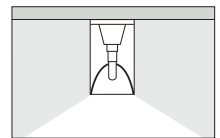
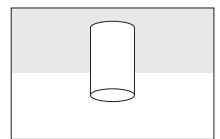

Surface-mounted light structure with direct luminaires for fluorescent lamps.

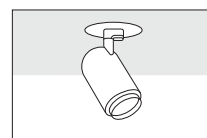

Singlet for spotlights.

A series of directional spotlights are mounted on installation channels arranged across the width of the room. These provide lighting over the individual tables and accentuate the counter.

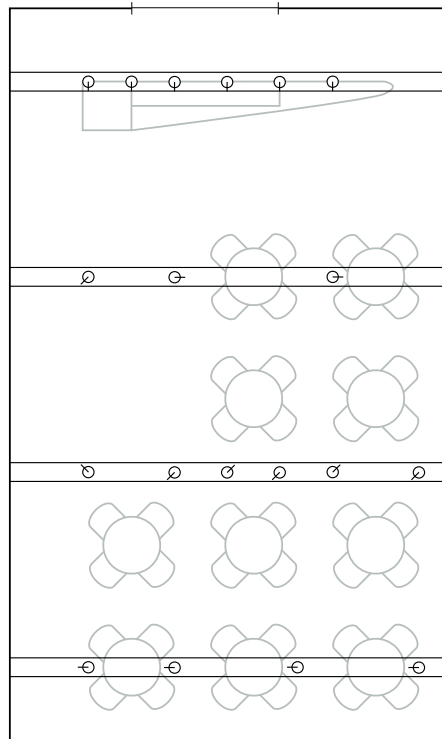

Installation channel with directional low-voltage spotlights.

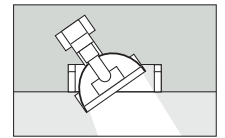
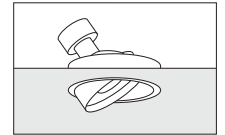
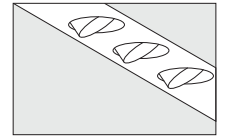

Integral directional spotlights arranged in a regular pattern across the ceiling accentuate the tables. The counter is emphasized by a linear arrangement of decorative downlights.

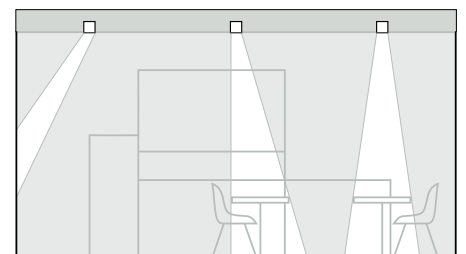
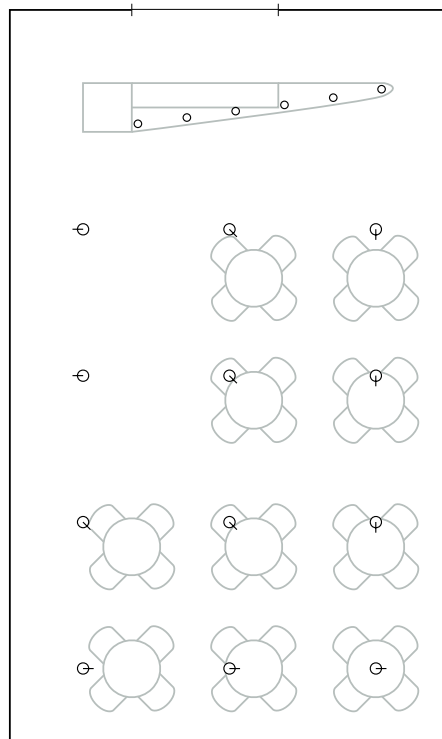

Integral directional spotlight for low-voltage halogen lamps.

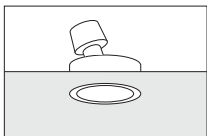

Decorative recessed downlight for low-voltage halogen lamps.

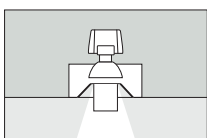
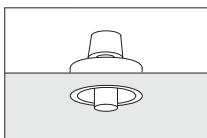
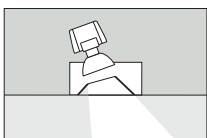

Recessed wallwashers produce reflected light for the general lighting in the space. Recessed double-focus downlights provide direct light on the tables. The two components are arranged in a regular pattern. The counter is accentuated by downlights.

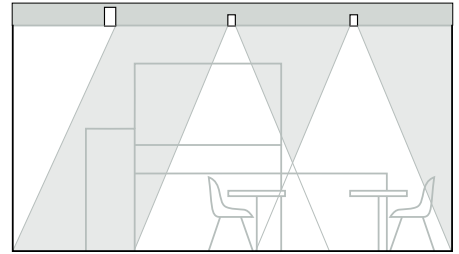
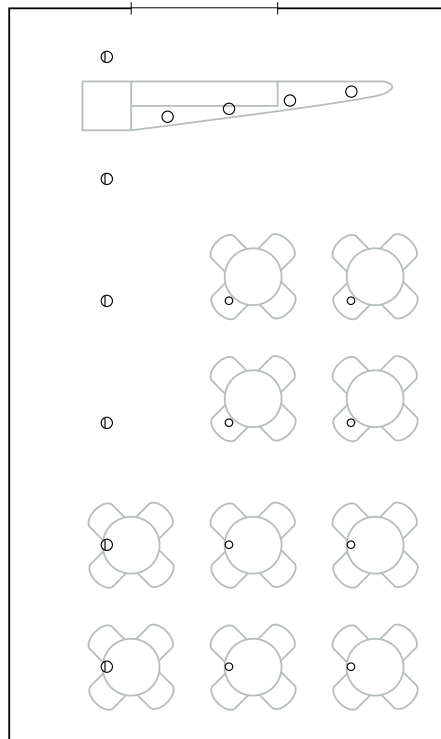

Recessed wallwasher for halogen lamps.

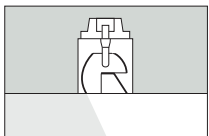
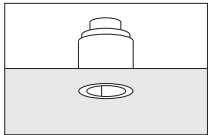

Recessed double-focus downlight for low-voltage halogen lamps.

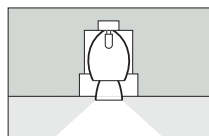
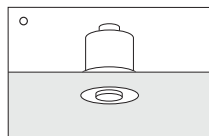

Recessed downlight for low-voltage halogen lamps.

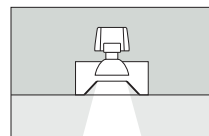
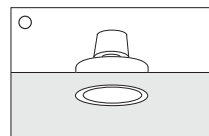

4.12 Restaurants

The difference between restaurants and cafés and bistros lies in the quality and range of food offered and in the atmosphere. Lunches and dinners comprising several courses mean that guests generally stay for longer periods of time. People dining require a pleasant, prestigious atmosphere in which to enjoy their food and conversation with friends or business colleagues. Guests also require an element of privacy in a restaurant. The interior furnishings and the lighting should be chosen and designed to limit visual and acoustic disturbance caused by occupants in other parts of the room. Each group of guests should have the feeling that they have their own private space.

The design concept should therefore aim to provide illumination that allows the surroundings, food and guests to be seen in their most favourable light.

The average illuminance level is low, the general lighting gives way to localised celebratory lighting of the individual tables. Paintings, plants or other decorative elements may be accentuated to create points of interest in the environment. "Play of brilliance" in the form of candle-light, decorative luminaires or light sculptures can also be extremely effective in the restaurant environment.

To meet the different requirements for daytime and night-time lighting, it is advisable to develop a concept that allows the switching and dimming of different groups of luminaires.

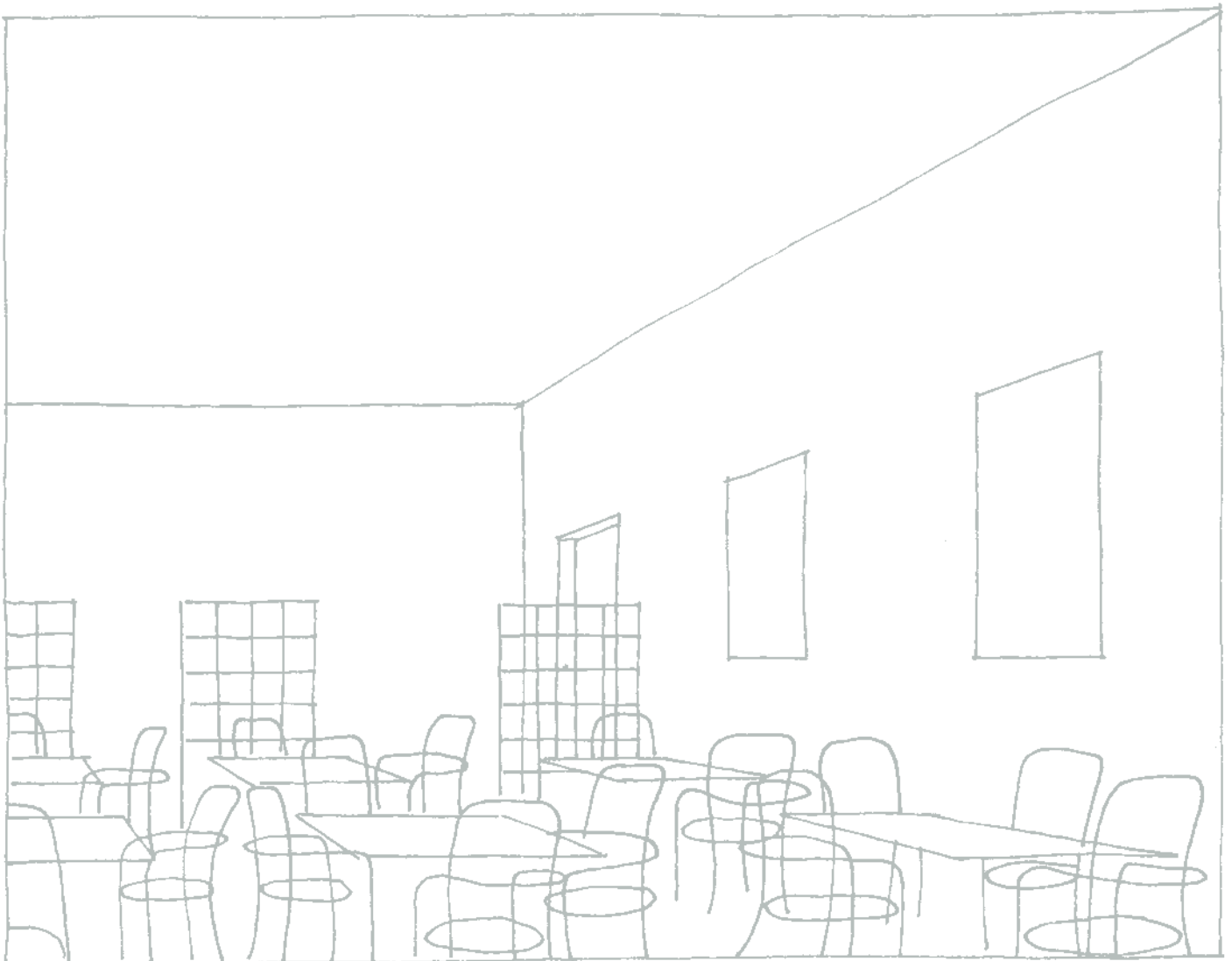

The ambient lighting in the restaurant is provided by decorative wall-mounted wallwashers. The tables are illuminated by recessed directional spotlights; decorative recessed downlights accentuate the bar and the entrance area. Uplights located between the plants project a leafy pattern on the ceiling.

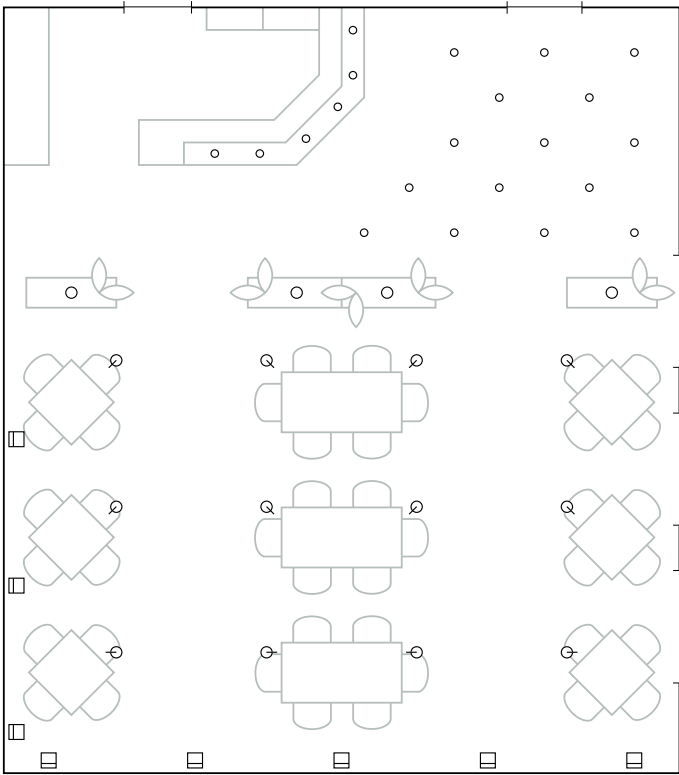

Decorative wallmounted ceiling washlight for general service lamps.

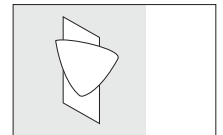

Decorative recessed downlight for low-voltage halogen lamps.

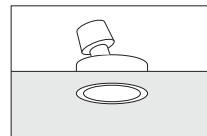
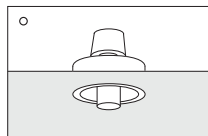

Directional spotlight for low-voltage halogen lamps.

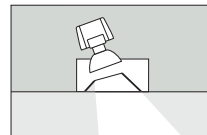
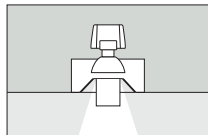

Uplight for PAR 38 reflector lamps.

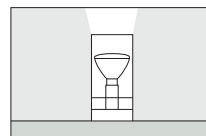
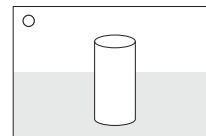

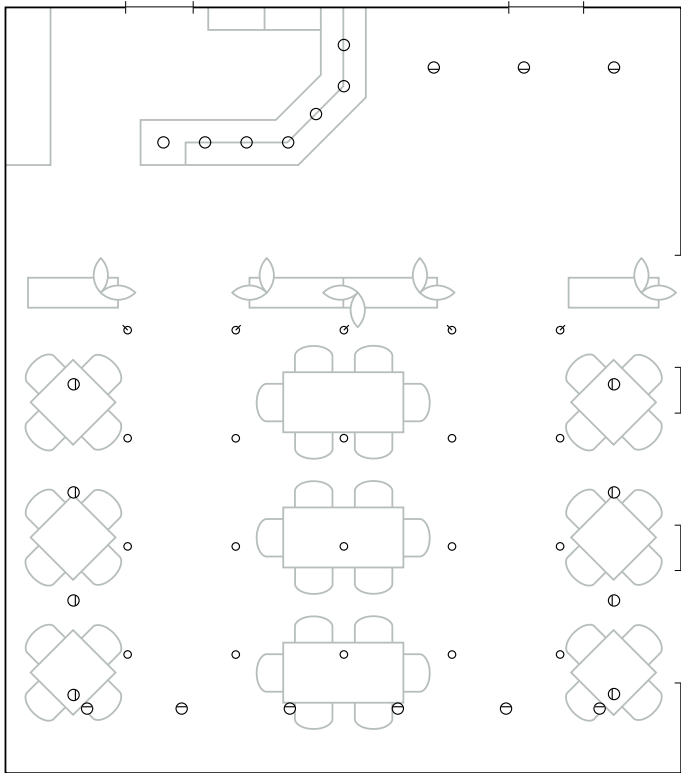

The indirect general lighting in the entrance and seating area is provided by wall-washers. A regular arrangement of double-focus downlights provide direct light throughout the main restaurant area. A supplementary row of directional spotlights illuminate the plants between the seated area and the bar. The bar is accentuated by a series of downlights that follow the shape of the bar.

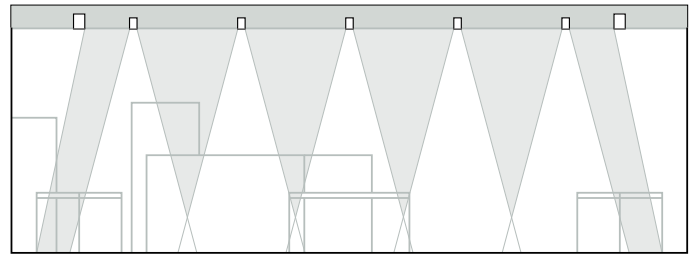

Recessed wallwasher for halogen lamps.

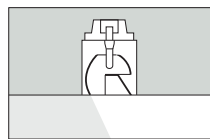
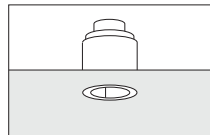

Recessed downlight for low-voltage halogen lamps.

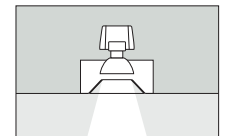
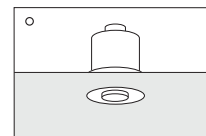
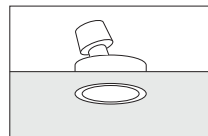
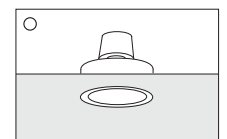

Recessed directional spotlights for low-voltage halogen lamps.

Recessed double-focus downlight for low-voltage halogen lamps.

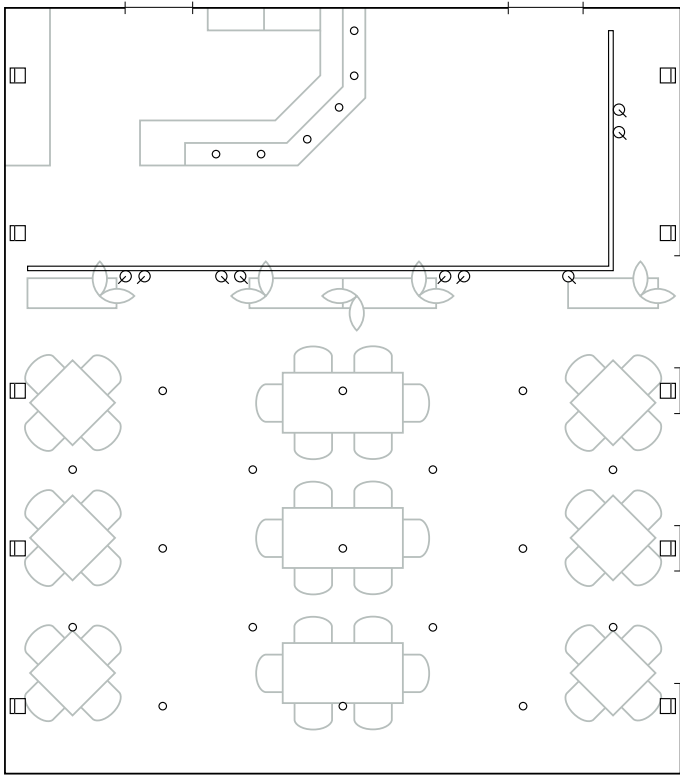

Indirect general lighting is provided by ceiling washlights arranged along the side walls. A staggered layout of decorative recessed downlights provides accent lighting on the tables and bar. Track-mounted spotlights illuminate the plants and entrance area.

Wall-mounted ceiling washlight for halogen lamps or general service lamps.

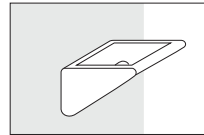

Decorative recessed downlight for low-voltage halogen lamps.

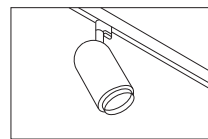
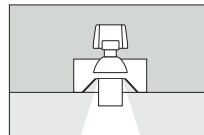
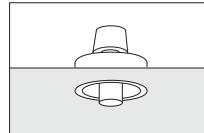

Track-mounted spotlights.

4.13 Multifunctional spaces

Multifunctional spaces are used as meeting rooms for a variety of events. They can be found in hotels and congress centres, in public buildings and on industrial premises. They are most frequently used for conferences and seminars, but also for receptions and parties. A multifunctional space can often be divided by means of a removable partition, which allows a number of small meetings or events to take place simultaneously; this requires a lighting layout that is symmetrically aligned to the dividing line, in relation to both the overall space and to the potential individual spaces.

The lighting should be variable to correspond to the multifunctional nature of the space. It should be both functional and prestigious. The lighting installation will generally comprise several components, which can be switched or electronically controlled separately or in unison. Functional, efficient ambient lighting can

be provided by louvred luminaires equipped with fluorescent lamps, for example, with adjustable spotlights for the presentation of products or teaching aids and downlights for general service lamps for accent lighting or dimmed lighting. Depending on the design of the space, decorative luminaires may be used for effect.

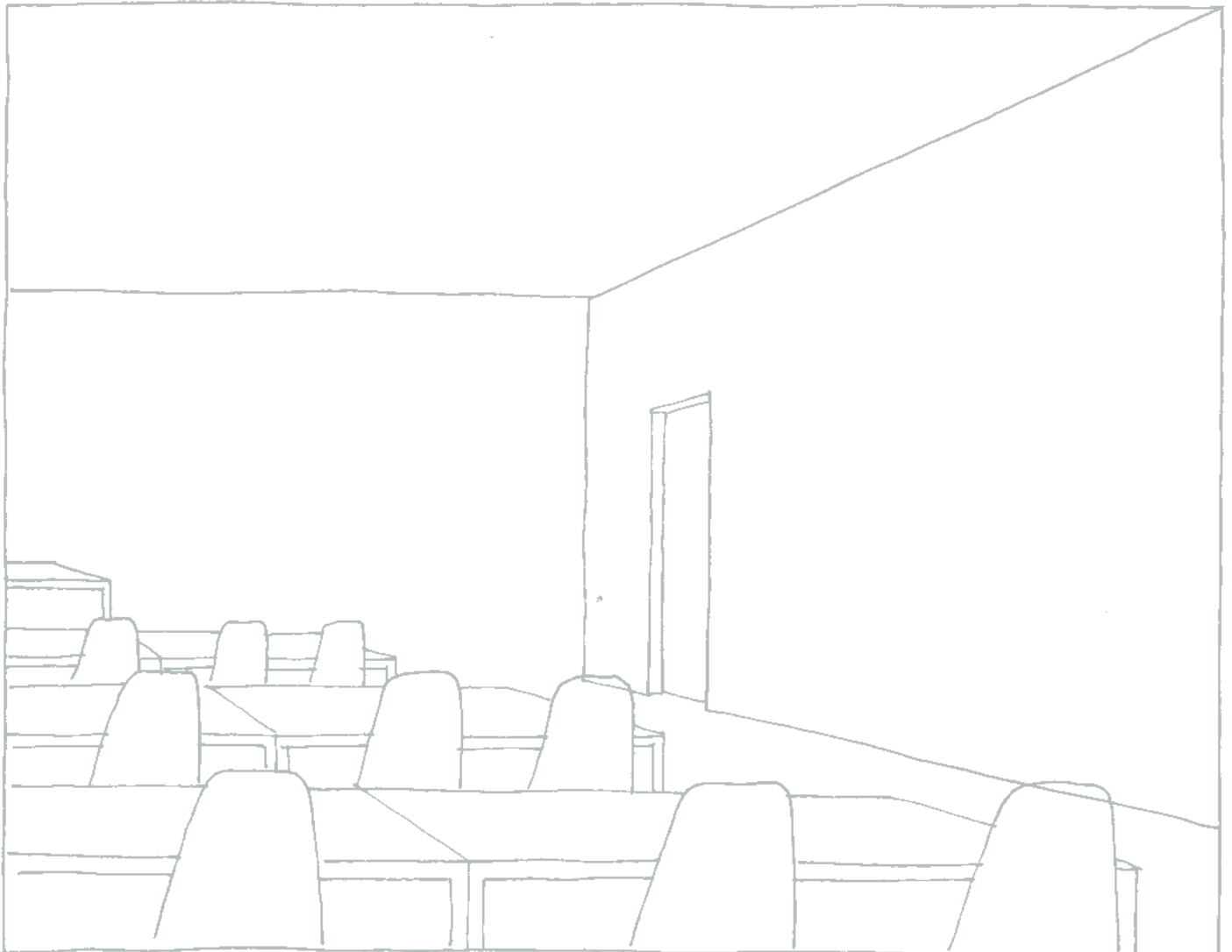

Multifunctional spaces are used for a variety of events. The lighting in these spaces is not only expected to be functional, but also suitable for presentations and festive occasions. Rooms that can be divided require special attention when designing the lighting installation.

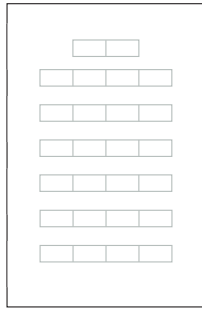

Seminar.

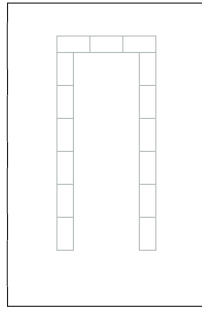

Conference.

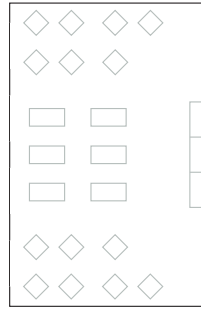

Gala dinner with individual tables and buffet.

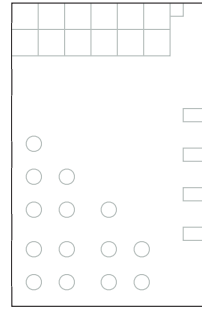

Gala event with cabaret and dance floor.

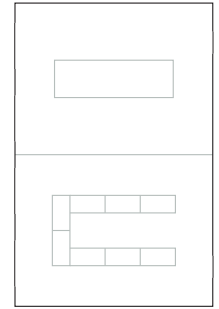

Simultaneous use: small party and meeting.

Two lighting layouts comprising square louvred luminaires designed for compact fluorescent lamps and downlights equipped with halogen lamps produce both efficient and accentuated, dimmable lighting.

Two runs of track mounted flush with the ceiling at both ends of the room take spotlights for lighting presentations or a stage area. The twin lighting layout allows the room to be divided and both parts used separately.

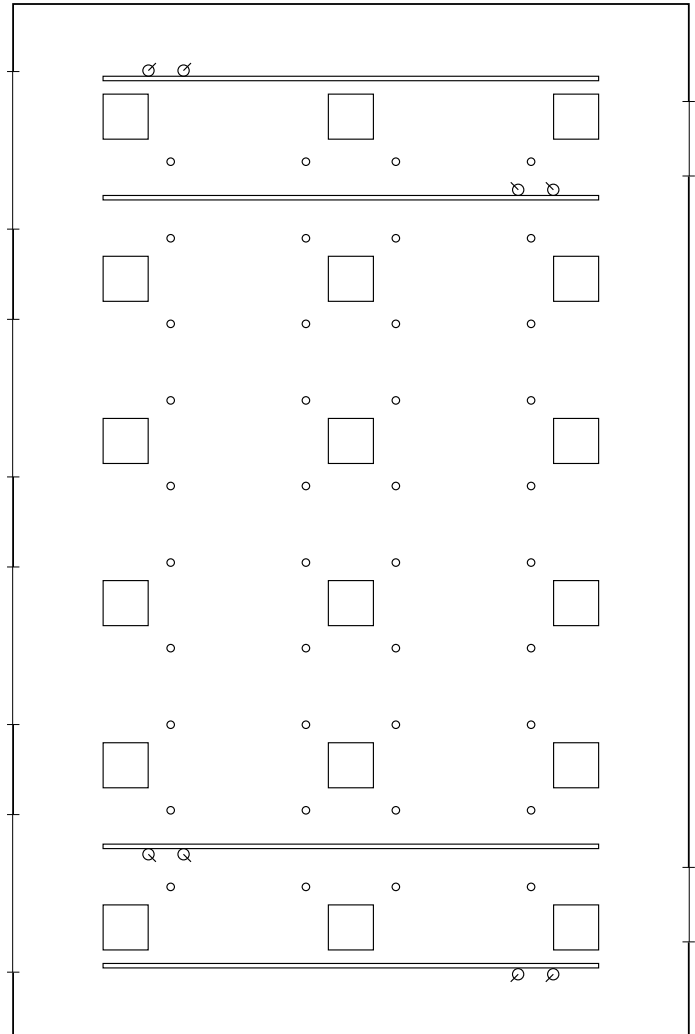

Recessed louvred luminaire for compact fluorescent lamps.

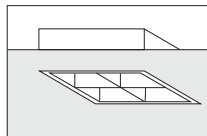

Double-focus downlight for halogen lamps.

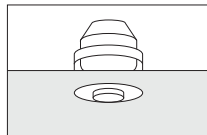

Track with spotlights.

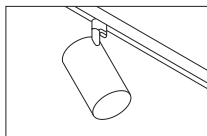

The ambient lighting in the multifunctional space is produced by a symmetrical arrangement of luminaires in both parts of the room. Downlights equipped with compact fluorescent lamps and pairs of double-focus downlights with halogen lamps are arranged in a uniform pattern. The fluorescent downlights provide efficient lighting for functional events, whereas the dimmable halogendownlights are used for lighting festive occasions and provide lighting for people to take notes during slide or video presentations.

Recessed track with spotlights for presentation lighting or accent lighting.

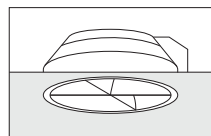
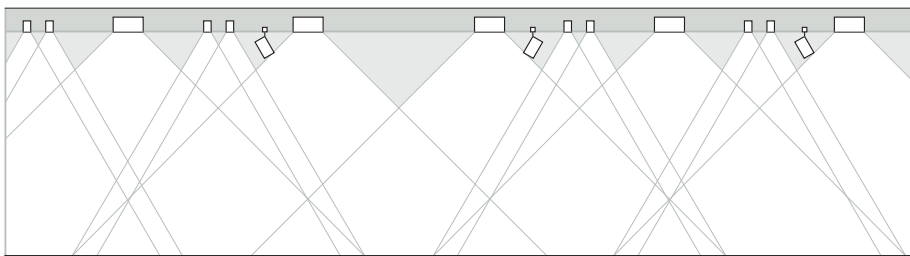
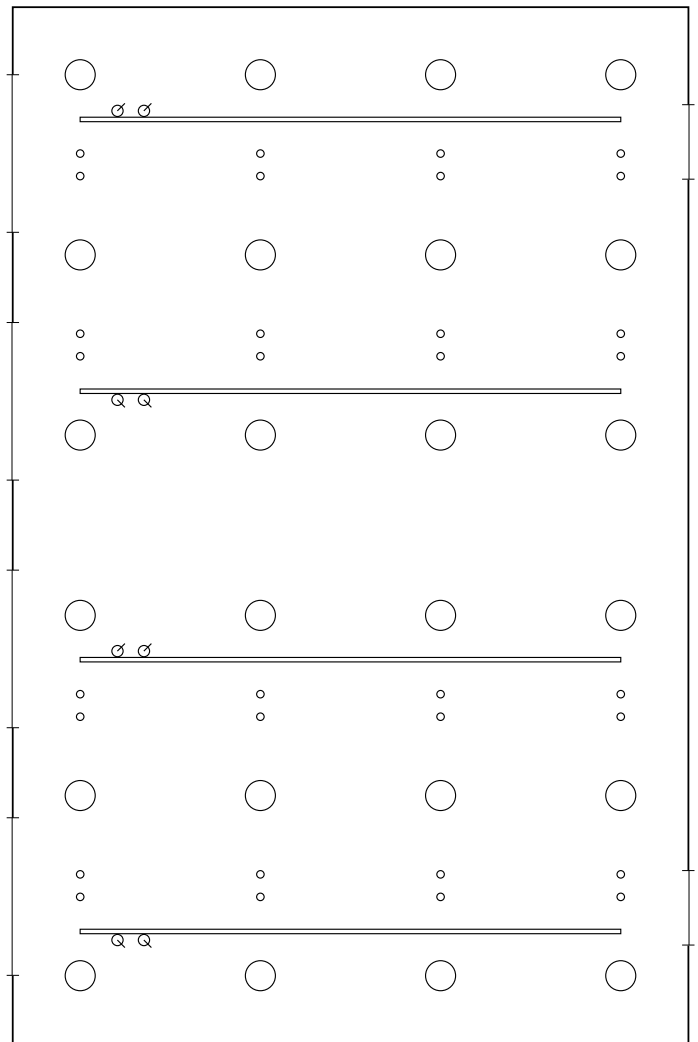

Recessed downlight with cross baffles for compact fluorescent lamps.

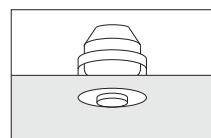

Recessed double-focus downlight for halogen lamps.

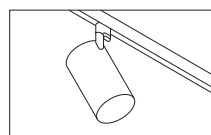

Track with spotlights.

The ambient lighting in the multifunctional space is produced by three parallel lines of luminaires that run the length of the room and consist of an alternating arrangement of louvred luminaires equipped with fluorescent lamps and downlights with general service lamps. Wallwashers located along the end walls provide lighting over the wall surfaces. Four downlights are arranged along the walls, combined with two singlets for additional spotlights for accent lighting.

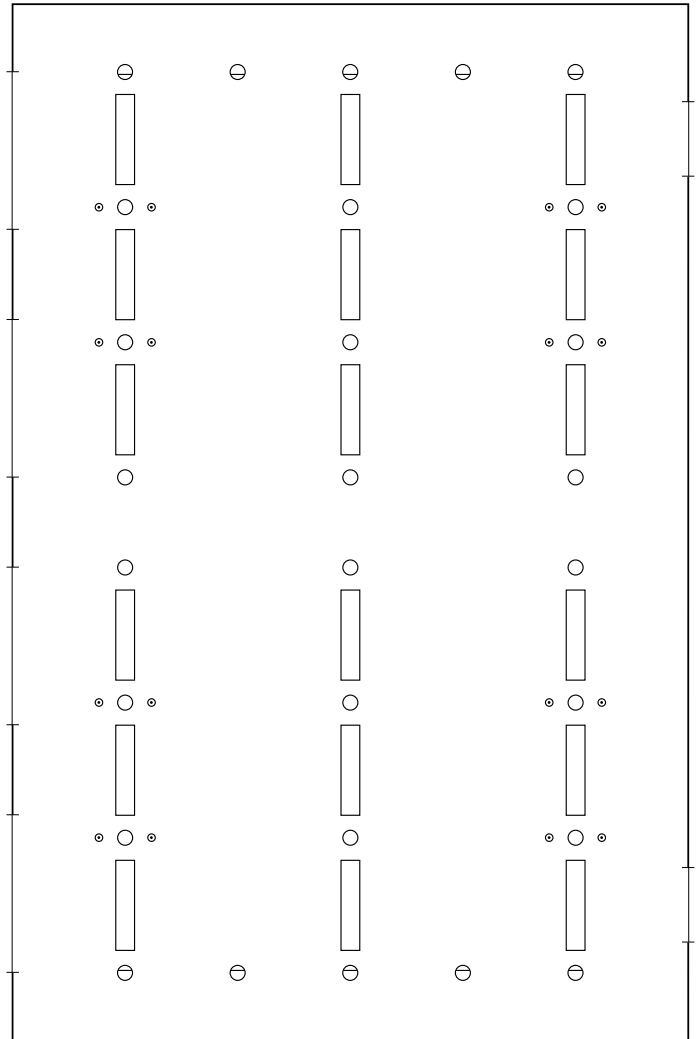

Recessed louvred luminaire for fluorescent lamps.

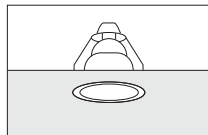
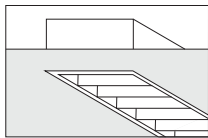

Recessed downlight for general service lamps.

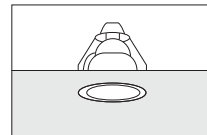

Recessed wallwasher for general service lamps.

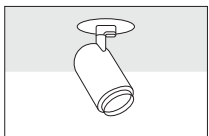

Singlet with spotlight.

The lighting is carried on four rectangular, symmetrically aligned suspended light structures. The ambient lighting is produced by uplights, with direct light on the tables and floor produced by pairs of downlights. Spotlights can also be mounted on the structure, if required, to emphasize focal points on the walls.

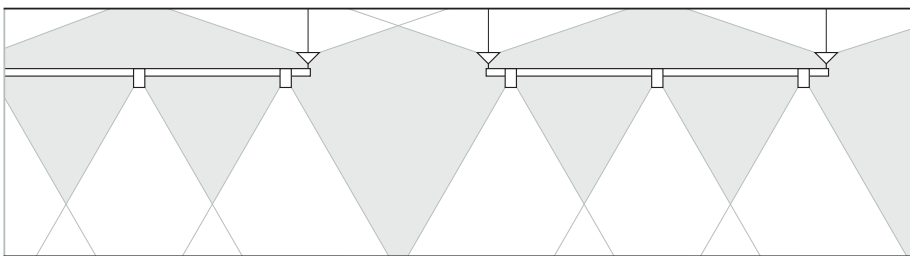
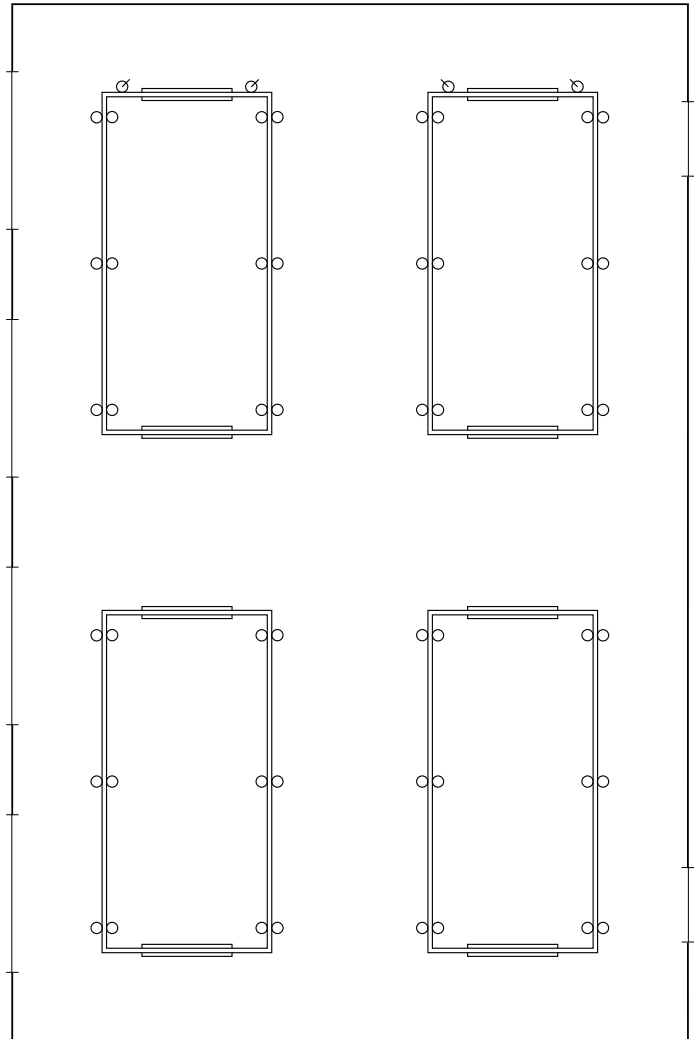

Light structure with uplights designed for compact fluorescent lamps, downlights for halogen lamps, and track-mounted spotlights.

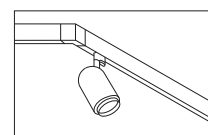
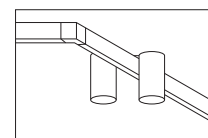
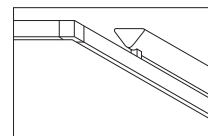

Ambient lighting in the multifunctional space is produced by indirect luminaires mounted on six linear light structures installed across the width of the space. Downlights for halogen lamps are arranged between the suspended structures. These downlights can be dimmed for special occasions or for people to take notes during slide or video presentations. Singlets arranged along the side walls take spotlights for accent lighting, if required.

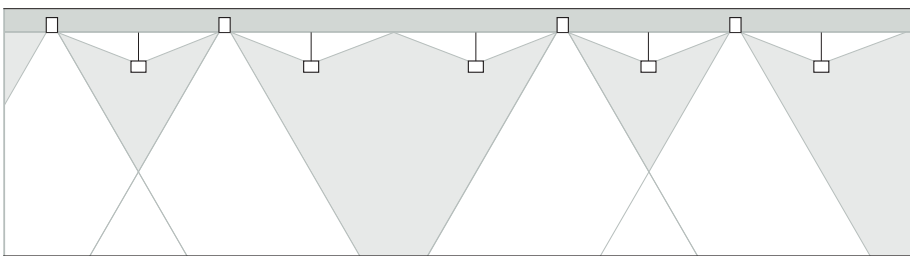
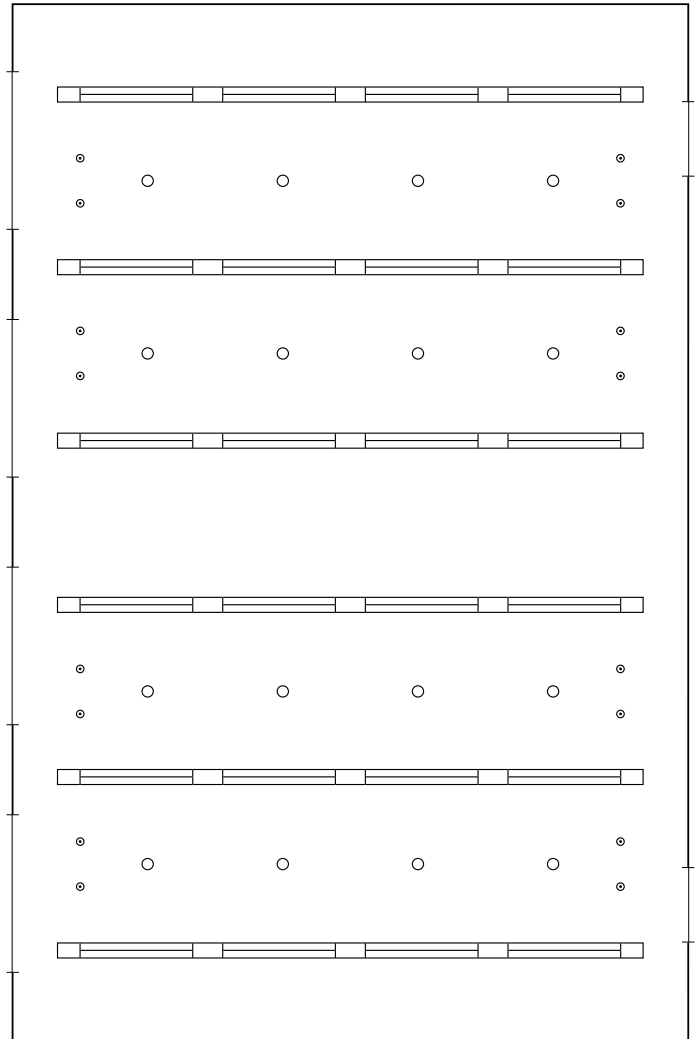

Suspended light structure with indirect luminaires for fluorescent lamps.

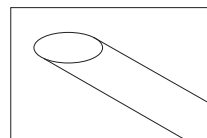

Recessed downlight for halogen lamps.

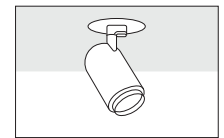
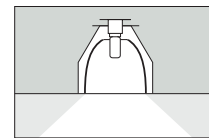
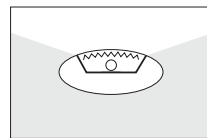
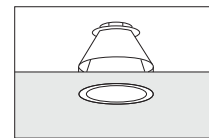

Singlet with spotlight.

The lighting layout in this multifunctional space is based on a regular grid, with downlights illuminating the centre of the space and washlights arranged along the end walls. The track installed between the rows of luminaires take additional spotlights for accent lighting. The downlights and washlights are equipped with halogen lamps, which makes for a prestigious atmosphere; individual groups of luminaires can be dimmed to allow the lighting to be adjusted to different requirements.

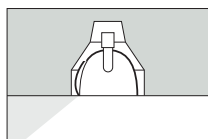
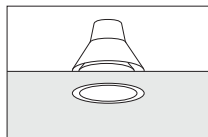
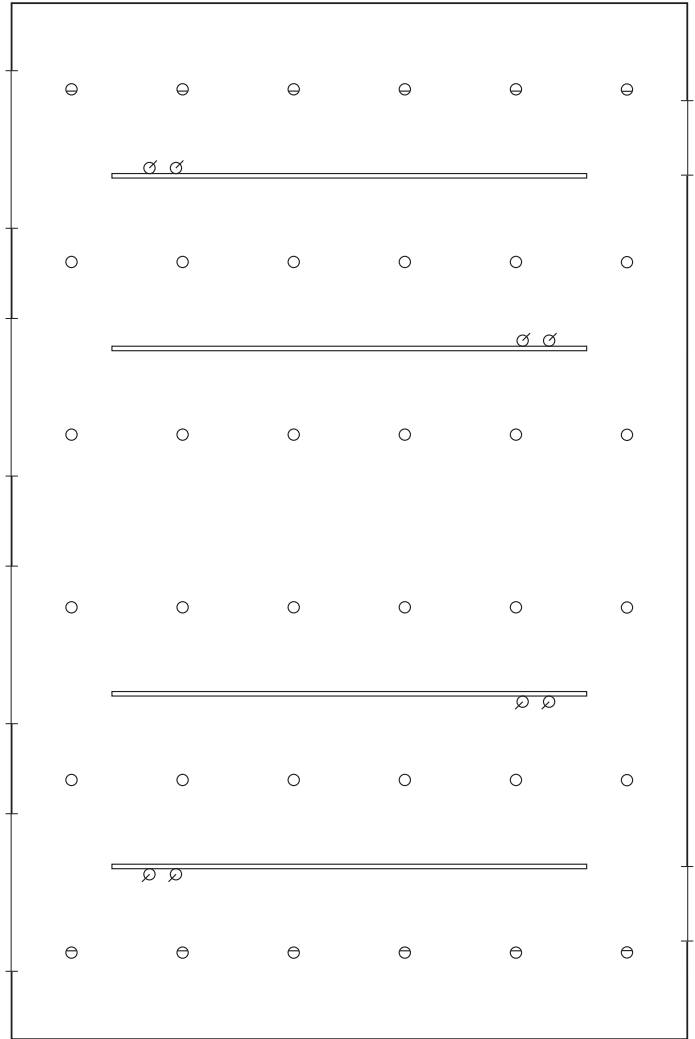

Recessed washlight for halogen lamps.

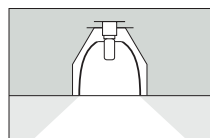
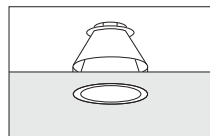

Recessed downlight for halogen lamps.

Track-mounted spotlights.

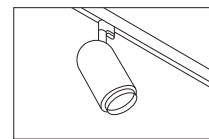

4.14 Museums, showcases

In many museums, especially those where archaeological, ethnological or scientific information is presented, the exhibits are primarily displayed in showcases. When developing the lighting design concept the showcases must be treated as the priority. The architectural lighting in this case is of secondary importance. It is important to avoid creating competition to the objects on display by over-accentuating architectural elements in the surroundings.

The first task of the lighting is to illuminate the exhibits in accordance with their particular qualities. It may be the form or structure, the glossy or transparent quality of surfaces or colour that are of particular significance and therefore require purposefully designed lighting – this may involve diffuse or accent lighting, or lighting with especially good colour rendering qualities.

Apart from pure presentation, curatorial aspects also play an essential part in the development of the lighting design concept. Depending on the type of materials that are to be illuminated, choice of lamp, filtering and illuminance control must be investigated carefully so as not to accelerate the damage to the exhibits. Apart from loading damage caused by visible light, ultraviolet and infrared radiation, overheating in showcases due to convection is also an aspect to be considered; in the case of sensitive exhibits it may be necessary to install integral luminaires in a separate compartment of the showcase.

The recommended illuminance for museum lighting is 150 lx. This value refers to the lighting of oil paintings and a large number of other materials. Less sensitive materials, such as stone and metal, can be subjected to higher illuminances; to ensure that the contrast to adjacent spaces that are lit at a lower illuminance level is not too strong, it is advisable to take 300 lx as the limit. In the case of highly sensitive materials, especially books, water-colour paintings or textiles 50 lx should be regarded as the maximum; this requires careful balancing of the exhibition lighting and the ambient lighting, the latter being considerably lower.

When lighting showcases it is especially important to avoid reflected glare on horizontal and vertical glass surfaces. Careful attention must be paid to the positioning and direction of luminaires when illuminating the showcase from the outside. Potential reflected glare through windows should also be taken into account and, if necessary, eliminated by the provision of adequate shielding (e.g. vertical blinds).

High showcases can be illuminated with the aid of lighting components integrated into the case soffit. Transparent materials – e.g. glassware – can be illuminated by lighting integrated into the base of the showcase. As light sources, halogen lamps are generally used for accent lighting and compact fluorescent lamps for wide-area lighting. Fibre optic systems can also be of value if thermal load and danger to exhibits due to lamps inside the cases are to be avoided, or if the showcase dimensions do not allow the installation of conventional luminaires.

In addition to integral showcase lighting separate ambient lighting is invariably required. Depending on the required atmosphere and the illuminance laid down in curatorial stipulations ambient lighting may range from a lighting level just above the level of the showcase lighting down to orientation light produced by spill light from the showcases.

When lighting showcases from the outside, exhibition lighting and the ambient lighting both come from the ceiling. This form of lighting is especially suitable for glass showcases and flat display cases viewed from above, where it is not possible to integrate luminaires inside the cases. Both daylight and general lighting can contribute towards the illumination of exhibits, as can light from spotlights, all requiring consideration in the accentuation of specific objects. The lighting layout must be related to the position of the showcases to avoid reflected glare. Fixed luminaires can only be used in combination with fixed showcases, for example; in spaces where temporary exhibitions are held it is advisable to choose an adjustable lighting system, e.g. track-mounted spotlights.

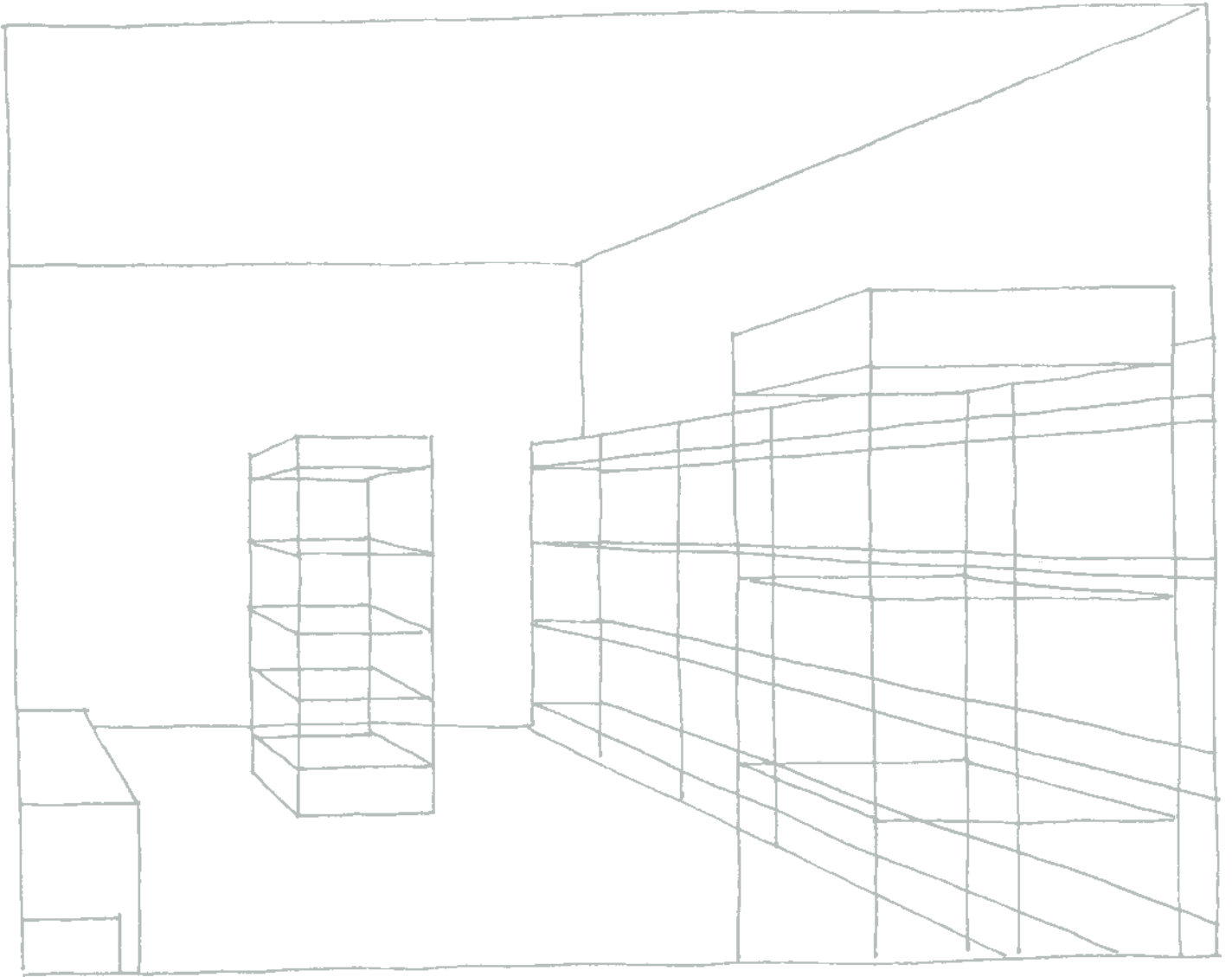

The lighting in the tall showcases is produced by integral luminaires. Recessed downlights provide ambient lighting and lighting for the flat display cases. The downlights have a narrow beam spread for better control of reflections on the glass surfaces of the cases.

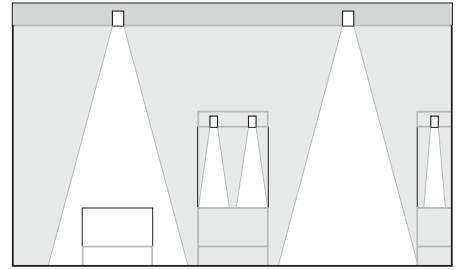
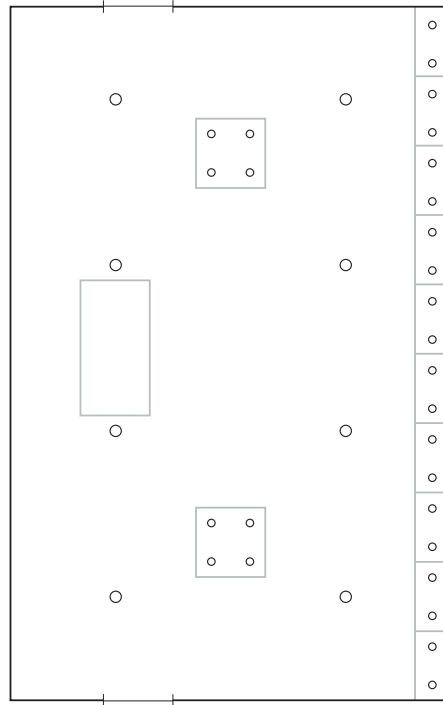

Recessed downlight for incandescent lamps or halogen lamps.

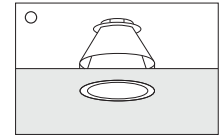
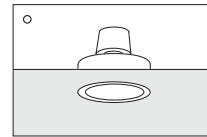

Downlight for low-voltage halogen lamps.

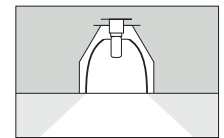
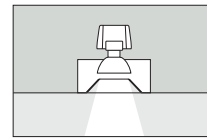

Accent lighting inside the showcase is provided by recessed low-voltage directional spotlights. The luminaires are equipped with covered reflector lamps to avoid danger to the exhibits.

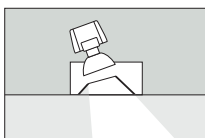
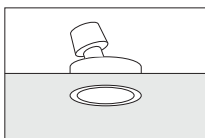
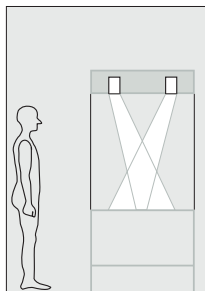

Showcase lighting using spotlights. The showcase is shielded by a filter attachment and an anti-dazzle screen. The upper section of the showcase can be ventilated separately.

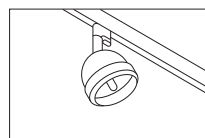
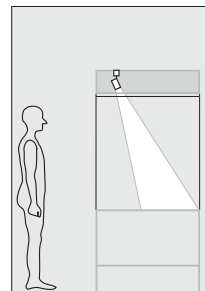

Wide-beam lighting of the showcase using a washlight for compact fluorescent lamps or halogen lamps.

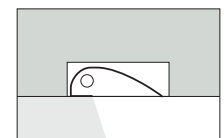
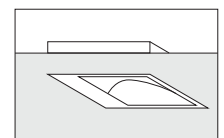
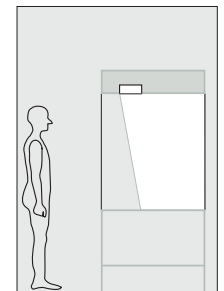

Lighting of glass showcases. A series of spotlights are mounted on a suspended light structure. This solution also provides ambient lighting.

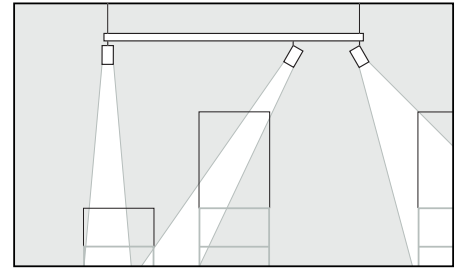
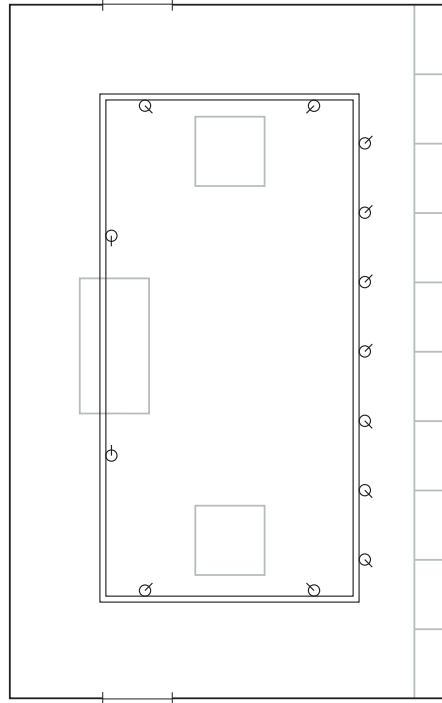

Track-mounted spotlights. The spotlights can be equipped with filters to reduce UV and IR radiation, or with a variety of anti-dazzle screens to limit glare.

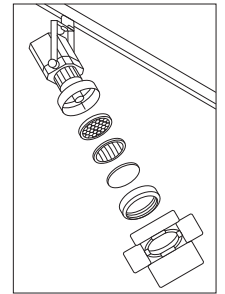

Showcase lighting using a fibre optic system. One central light source supplies a number of light heads. Integral lighting of this kind can be installed in the smallest of spaces.

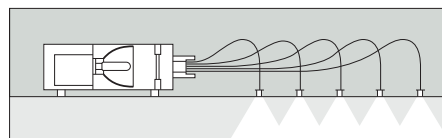
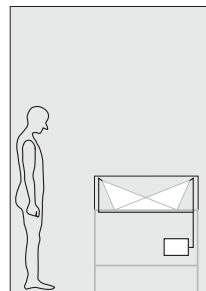
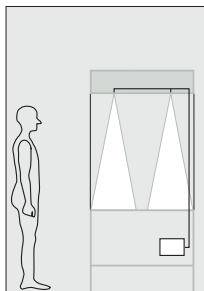

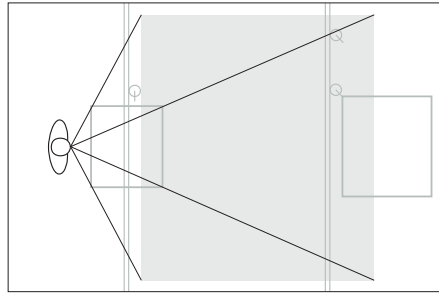
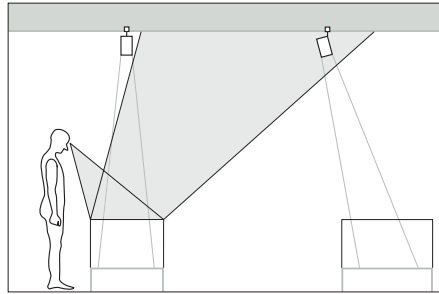

Identifying the "forbidden zones" for vertical reflecting surfaces. Windows must also be taken into account and shielded, if necessary.

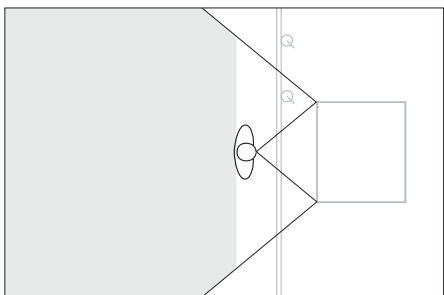
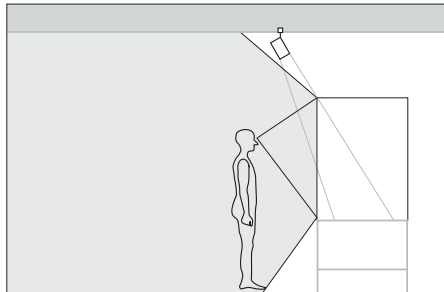

Identifying the "forbidden zones" for horizontal reflecting surfaces. No lamp luminances should be reproduced on the reflecting surfaces from these areas of the ceiling. It is acceptable to position luminaires in these areas, provided they are directed or shielded so as not to produce glare effects.

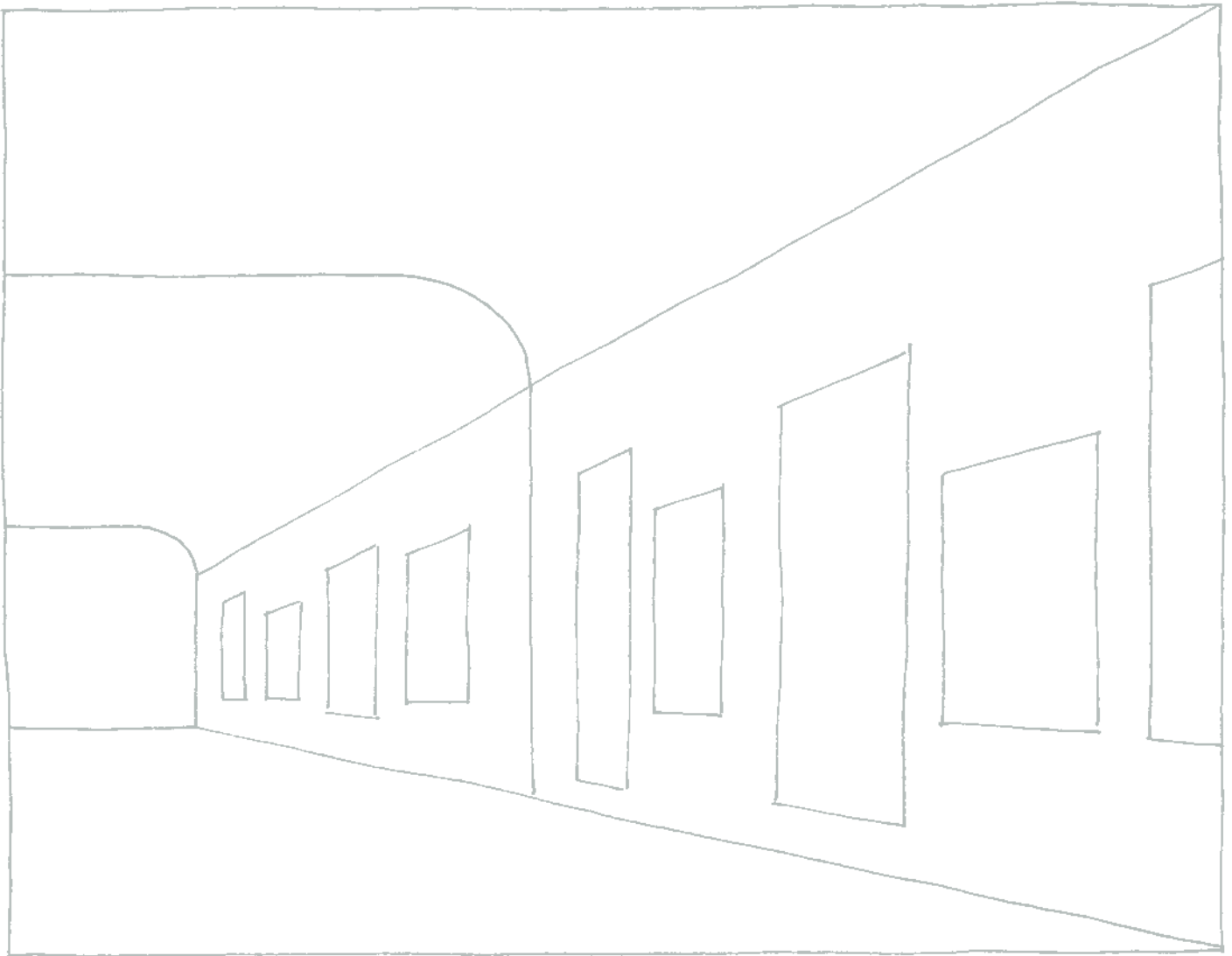

4.15 Museums, galleries

In contrast to museums which primarily exhibit objects in showcases, in galleries where paintings and sculptures are on display architectural lighting is also an essential part of the lighting design concept. In both historical buildings and modern museums the architecture is frequently in competition with the exhibits. The objective of the lighting design concept will usually be to continue to balance the importance of the art to the architecture.

Museums frequently also use daylight as well as artificial lighting. The lighting design concept must aim to control the daylight and coordinate the natural light with the artificial lighting. Daylight can be controlled by the architecture to a certain extent; supplementary devices and equipment may be necessary to control illuminance in accordance with specific curatorial stipulations. Electronic control systems are now available that allow combined control of incident daylight using adjustable louvres as well as the artificial lighting, when daylight is excessive or inadequate. The lighting system should provide appropriate levels of illuminance at all times of day and night.

The exhibits to be illuminated are mainly paintings and drawings on the walls and sculptures in the centre of the spaces. The works of art on the walls can be illuminated by wallwashers or accent lighting using spotlights. In both cases it is imperative to make sure that the angle of incidence has been calculated correctly to avoid disturbing reflections on glass or shiny surfaces. An angle of incidence of 30° to the vertical (angle of incidence for museums) has been proven to be a good guideline, because it handles reflected glare, illuminance and frame shadows optimally. Sculptures generally require directed light to reveal their three-dimensional quality and surface structure. They are usually illuminated by spotlights or recessed directional spotlights.

The lighting installation consists of a suspended light structure with uplights providing indirect ambient lighting and wallwashers providing direct lighting of the walls.

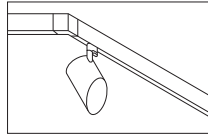
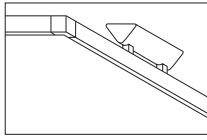

Light structure with uplights for compact fluorescent lamps or halogen lamps and wallwashers for PAR38 reflector lamps.

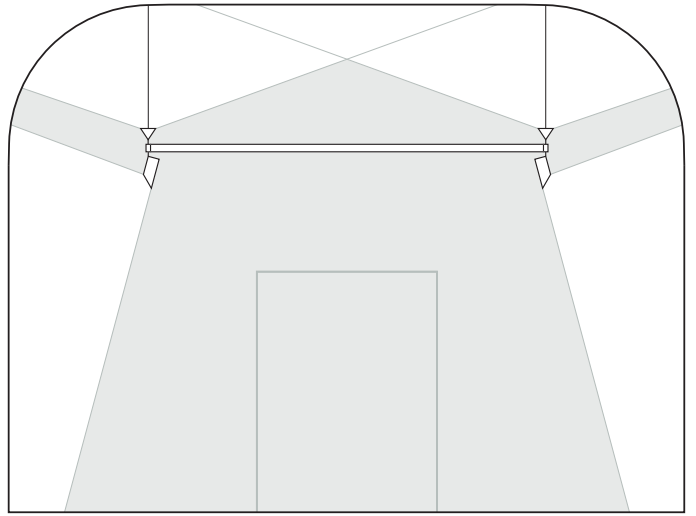

Daylit museum with a luminous ceiling. Wallwashers mounted parallel to the luminous ceiling supplement daylight and provide lighting in the hours after dark. Track-mounted spotlights allow additional accent lighting.

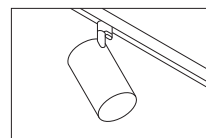
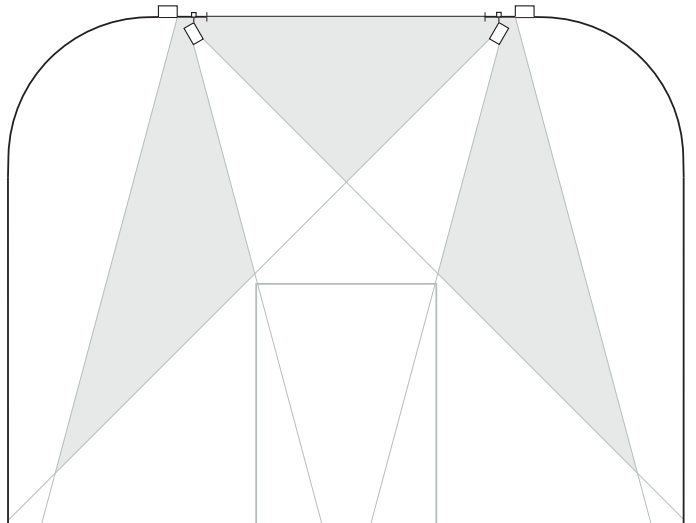
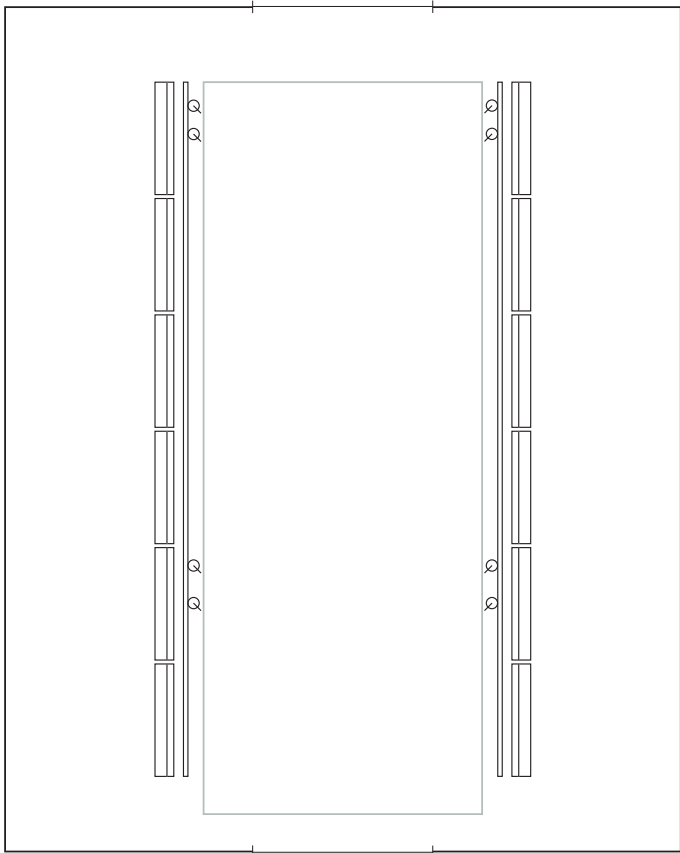

Track with spotlights.

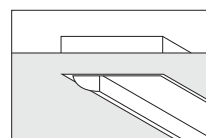

Wallwasher for fluorescent lamps.

The lighting of a historical museum building. As it is not permissible to mount luminaires on the walls or ceiling, the lighting is produced by free-standing washlights which provide lighting of the walls and the ceiling.

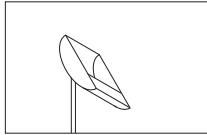

Free-standing washlight for halogen lamps.

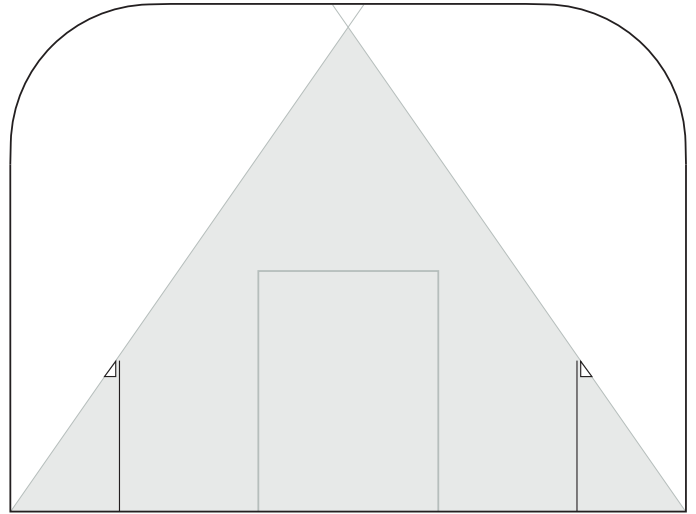
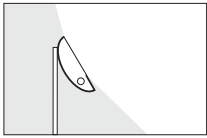

Luminaires mounted on the cornice consist of a wallwasher component and a prismatic louvre in the upper part of the luminaire, which directs light onto the ceiling.

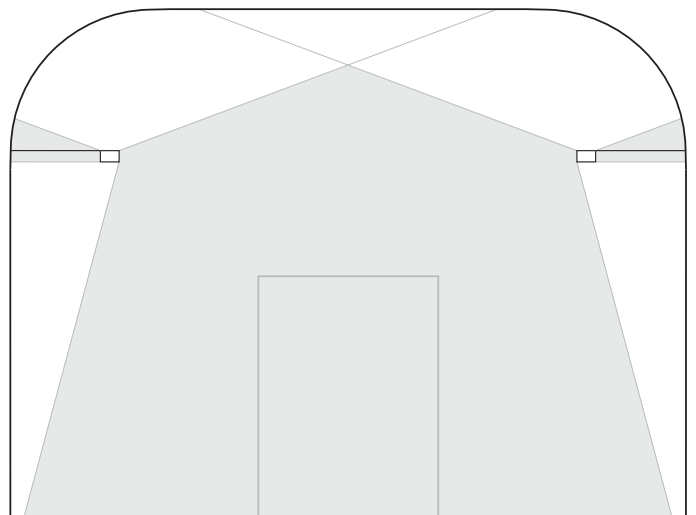

Museum luminaire for fluorescent lamps, equipped with a wallwasher reflector and prismatic louvre for the lighting of the ceiling.

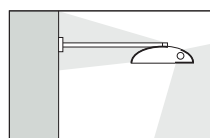
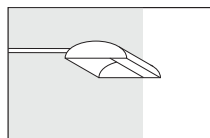

Wallwasher for halogen lamps and wallwasher for fluorescent lamps, both track-mounted.

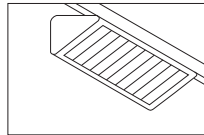
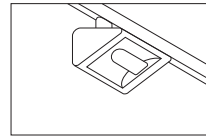

Recessed directional spotlight for reflector lamps.

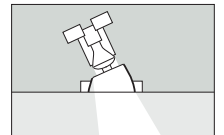
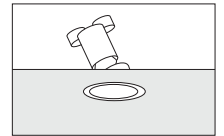

The lighting is installed in a suspended ceiling and positioned at a specific distance from the walls. Wallwashers are mounted on track behind the edge of the suspended ceiling; the alternating arrangement of wallwashers for halogen lamps and fluorescent lamps means it is possible to produce different lighting levels and lighting qualities on the walls. Recessed directional spotlights are installed in the suspended ceiling for the lighting of sculptures.

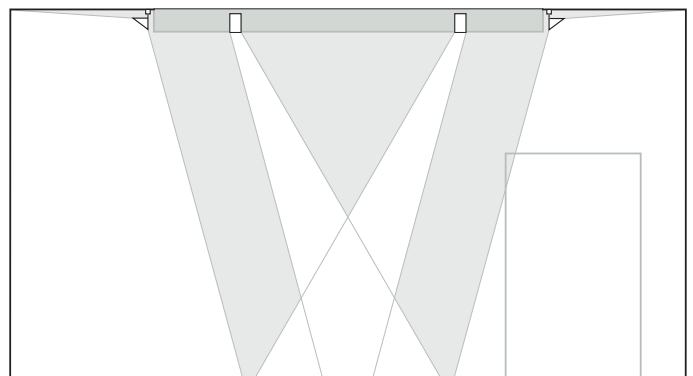
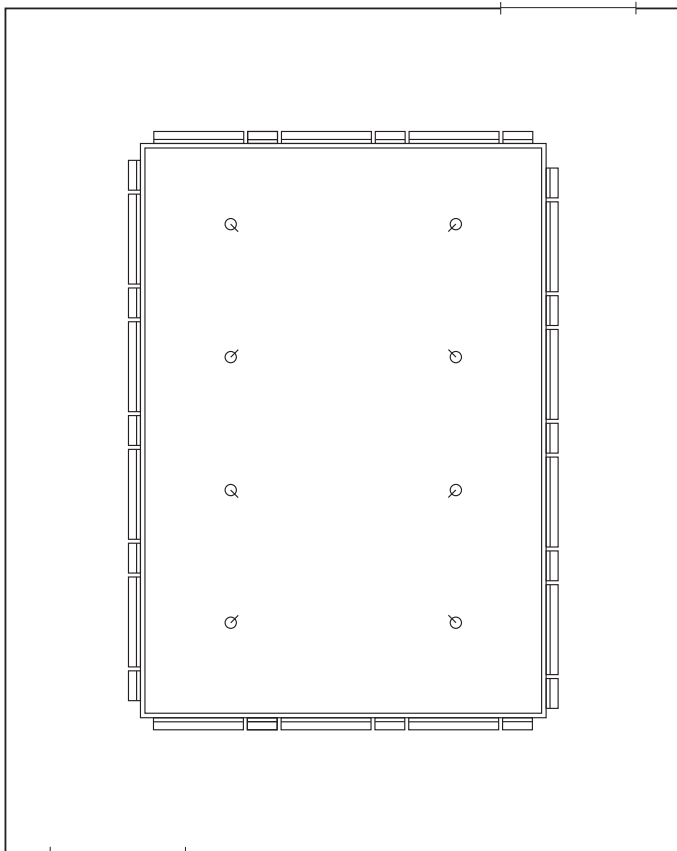

Wallwasher for fluorescent lamps.

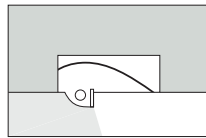
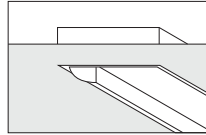

Recessed downlight for halogen lamps.

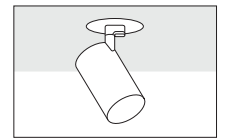
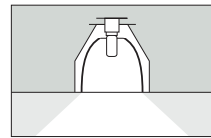
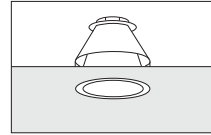

Singlet with spotlight.

The lighting is provided by a rectangular arrangement of wallwashers for fluorescent lamps, supplemented by a regular arrangement of downlights for halogen lamps. A series of singlets allow additional accent lighting using spotlights.

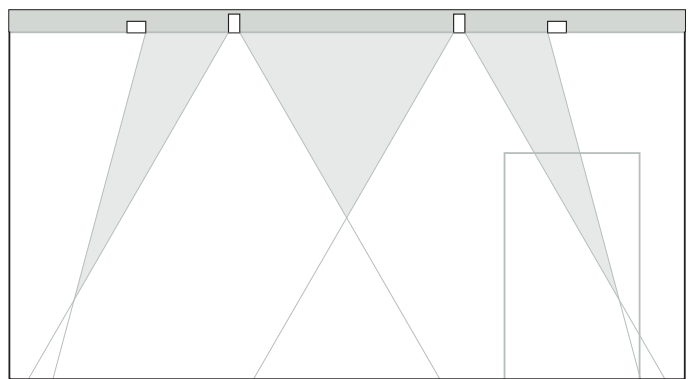
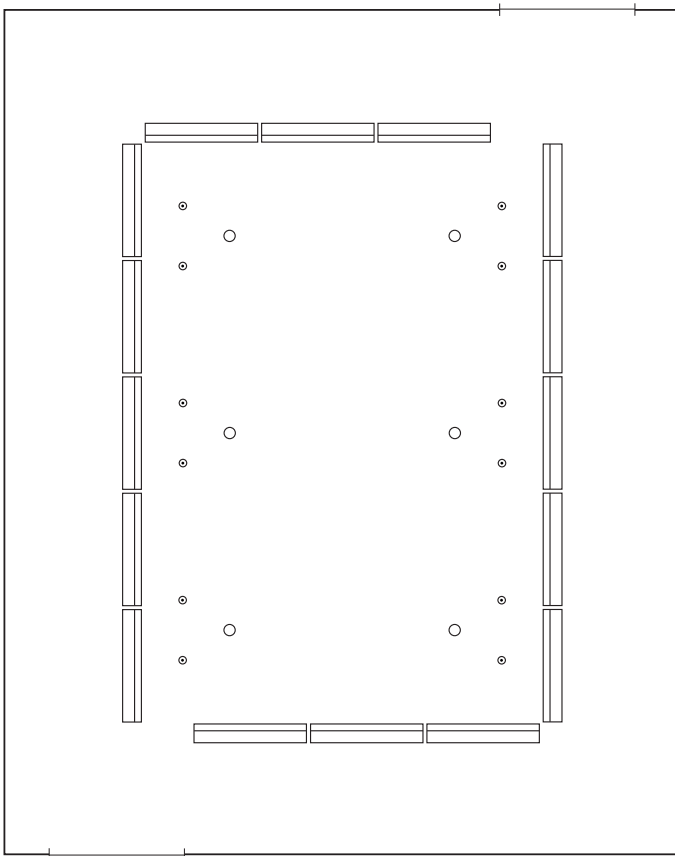

Recessed wallwasher for halogen lamps.

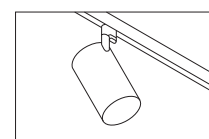
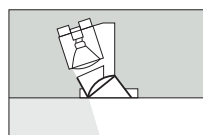
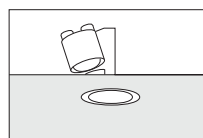

Track-mounted spotlights.

Wallwashers arranged parallel to the walls provide lighting of the walls. Track installed in a square in the central area takes spotlights for accent lighting.

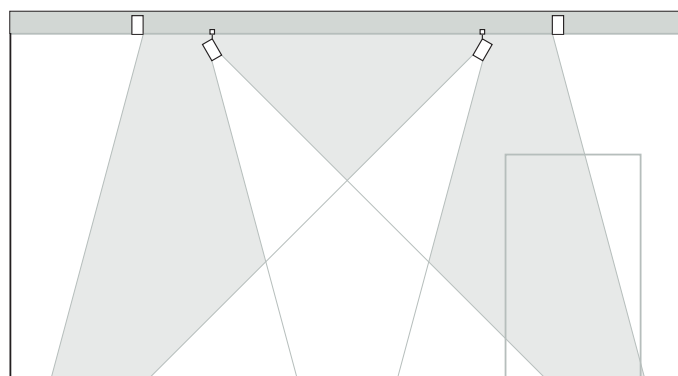
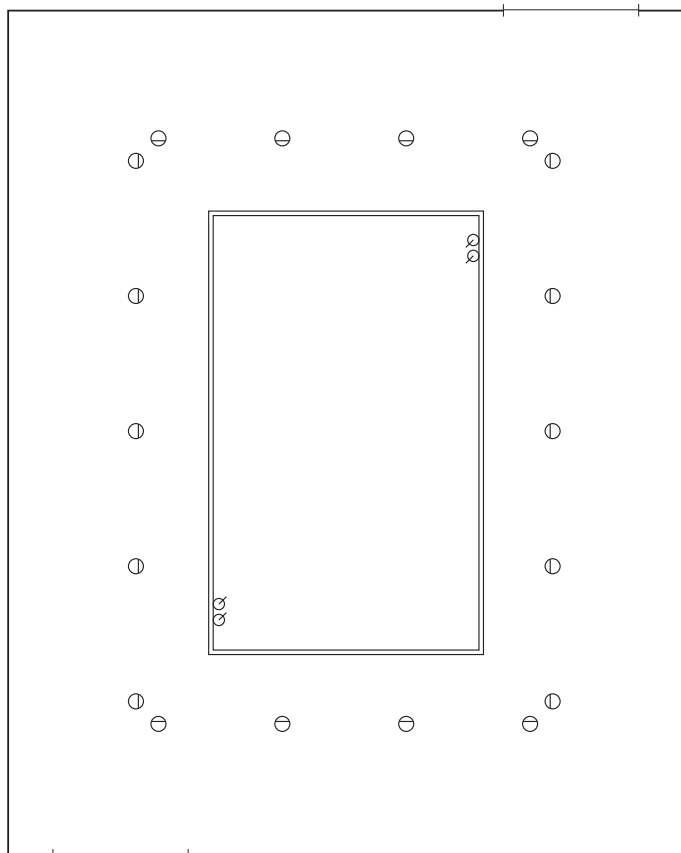

Museum lighting based on a luminous ceiling illuminated using fluorescent lamps. Track runs around the edges of the luminous ceiling and crosswise across the ceiling. This allows the lighting to be supplemented by spotlights and washlights, as required.

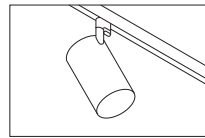

Track-mounted spotlights and washlights.

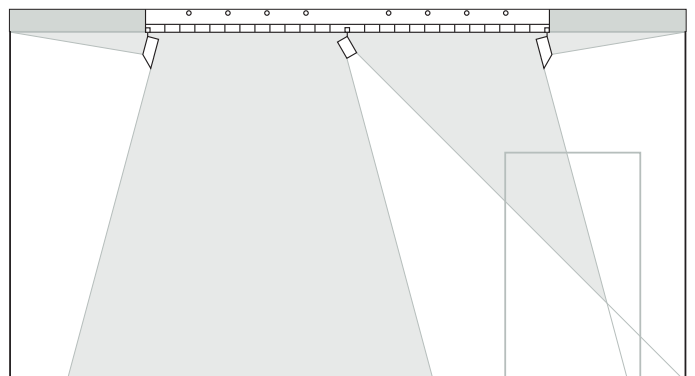
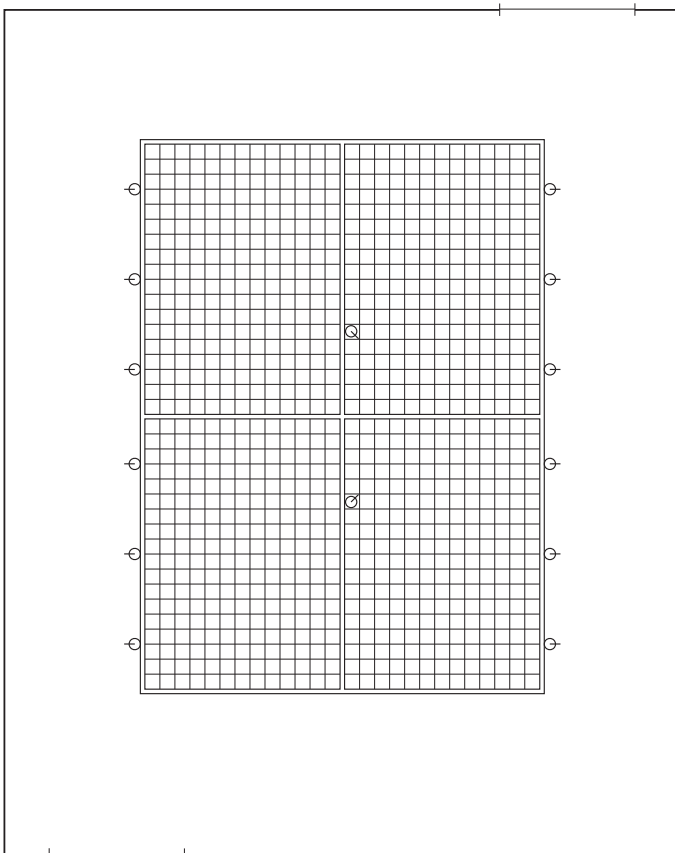
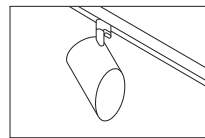

The lighting is installed on recessed track arranged in two superimposed rectangles. The outer track takes wallwashers for the uniform lighting of the walls, the inner track spotlights for the accentuation of sculptures. The alternating arrangement of wallwashers for halogen lamps and fluorescent lamps means it is possible to produce different lighting levels and lighting qualities on the walls.

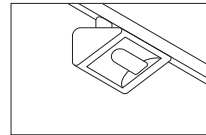

Wallwasher for halogen lamps and wallwasher for fluorescent lamps, both track-mounted.

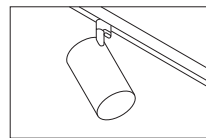
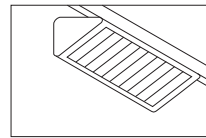

Track-mounted spotlights.

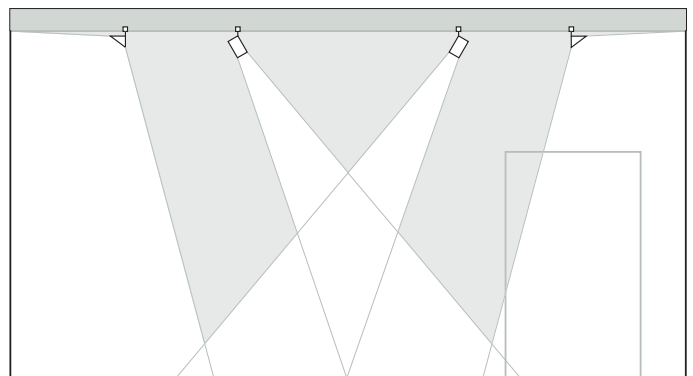
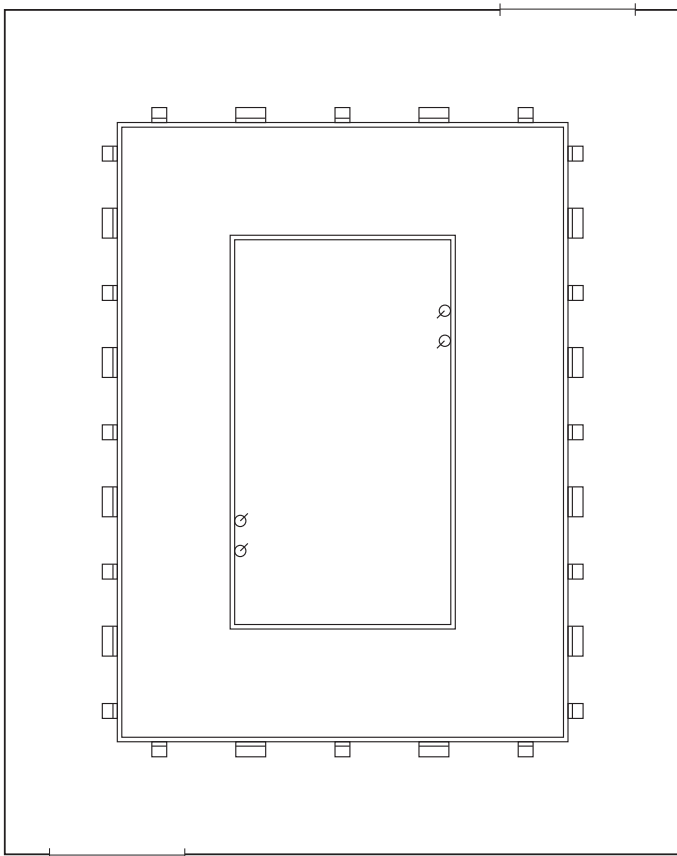

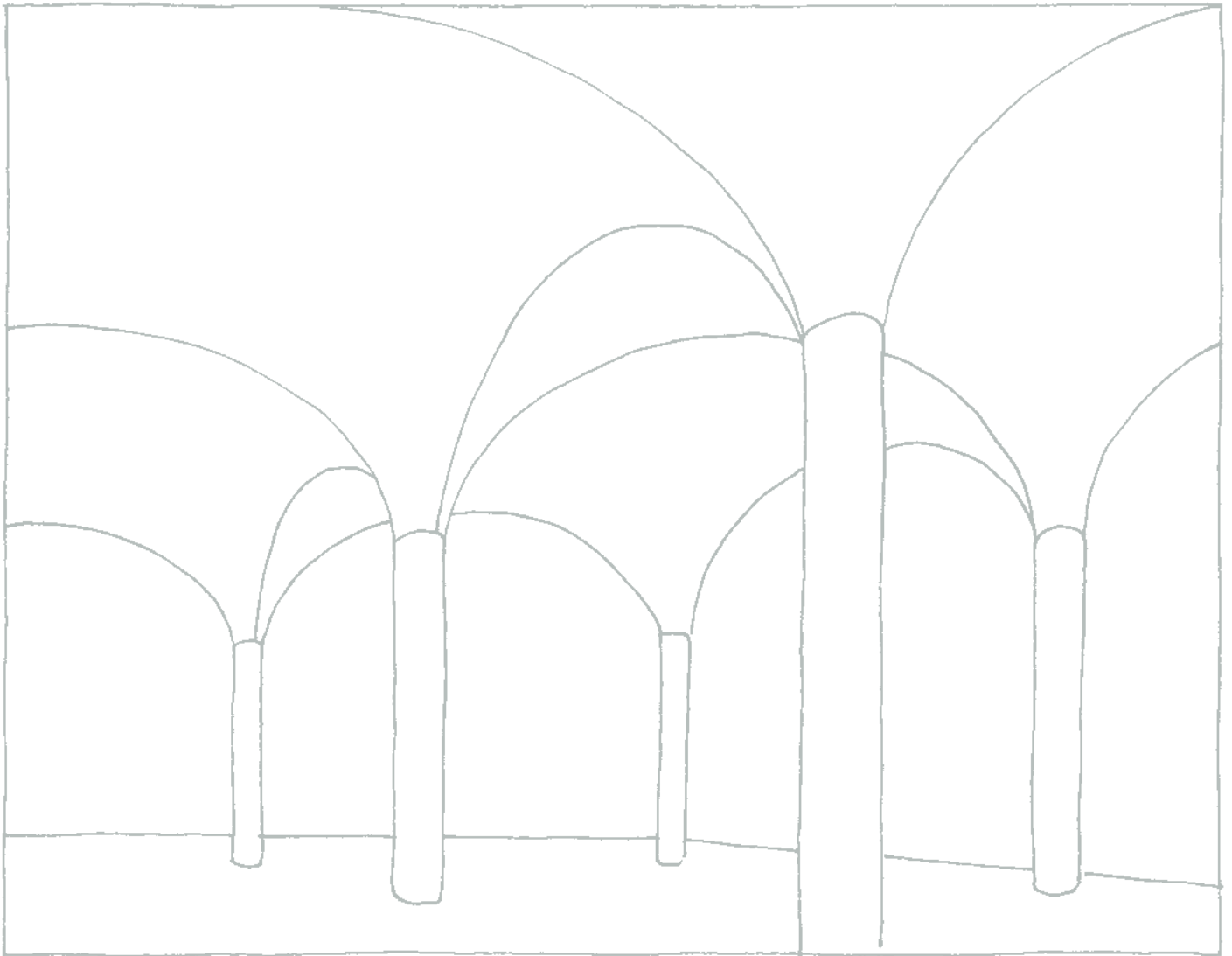

4.16 Vaulted ceilings

Vaulted ceilings are usually found in historical buildings. As a rule, one of the main tasks of the lighting, therefore, is to express the architectural design and architectural elements, e.g. by illuminating the structure of the ceiling or the frescos. The design concept will incorporate indirect or direct-indirect lighting, which will in turn serve to illuminate the architecture and provide ambient lighting.

Since penetration of the historical ceiling surfaces is to be avoided, integral lighting or systems that are complicated to install are out of the question. The lighting is therefore generally installed on pillars and walls or, alternatively, is applied in the form of pendant luminaires and light structures.

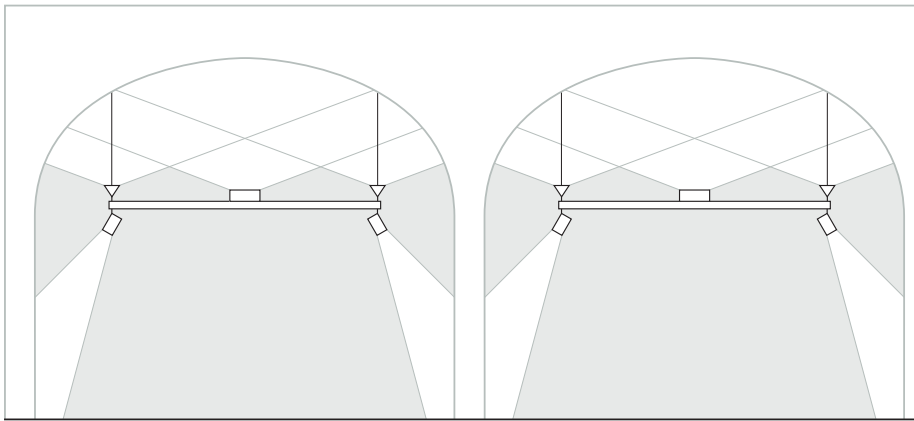
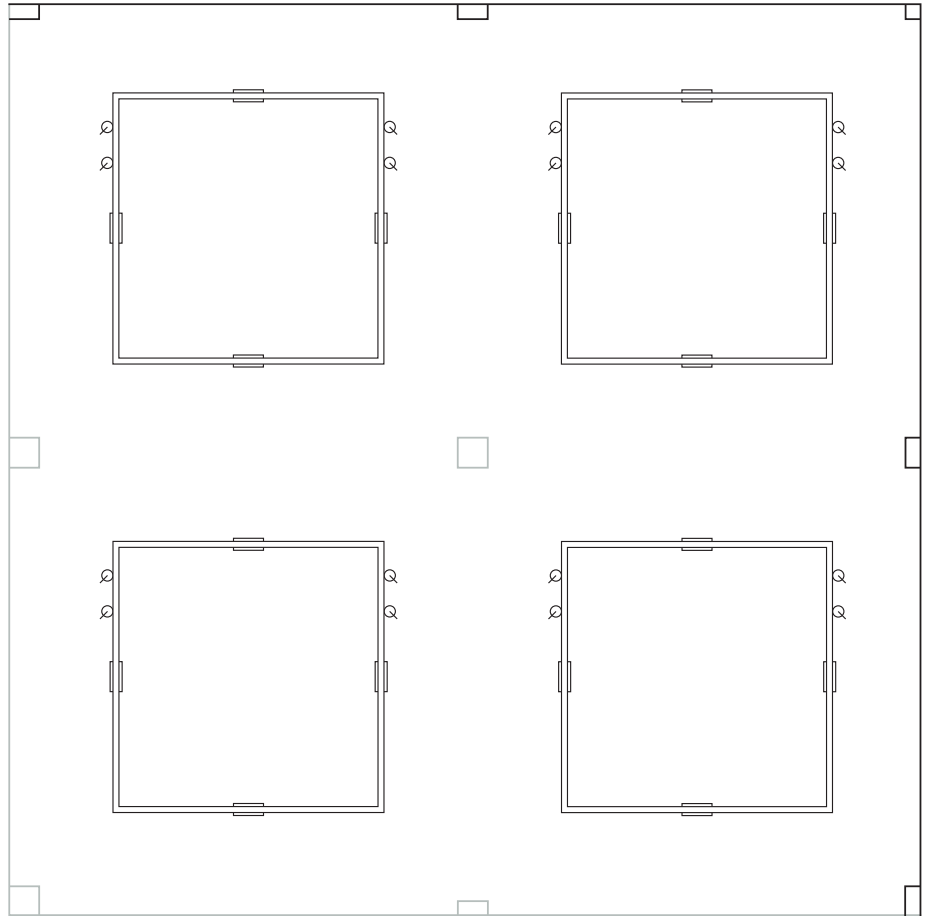

A square suspended light structure with uplights for indirect lighting is installed in each vault. Spotlights can be mounted on the lower part of the structure for accent lighting.

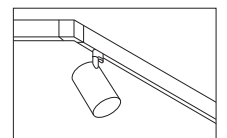
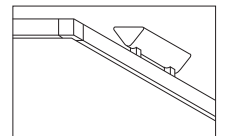

Light structure with uplights for halogen lamps and track-mounted spotlights.

4.0 Examples of lighting concepts
 4.16 Vaulted ceilings

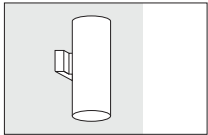

Combined up and downlight for halogen lamps.

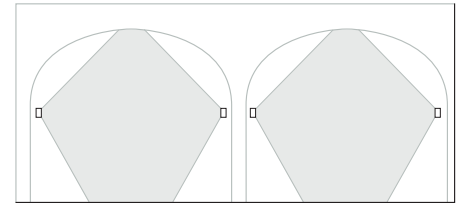
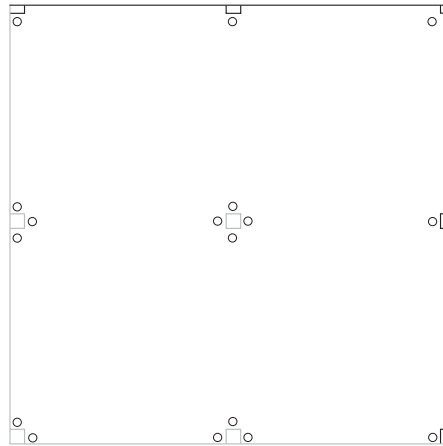

The vaulted ceiling is illuminated by combined up/downlight luminaires mounted on the pillars. Each free-standing pillar has four luminaires and each pilaster one luminaire. This provides sufficient ambient lighting to make the architecture visible, and for visitors' and users' orientation.

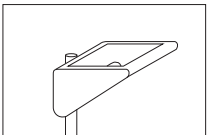

Free-standing or wallmounted ceiling washlights for halogen lamps or metal halide lamps.

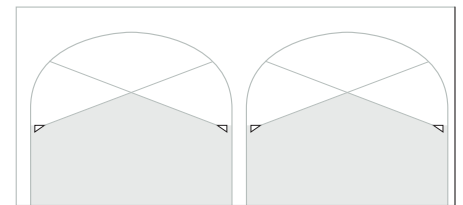
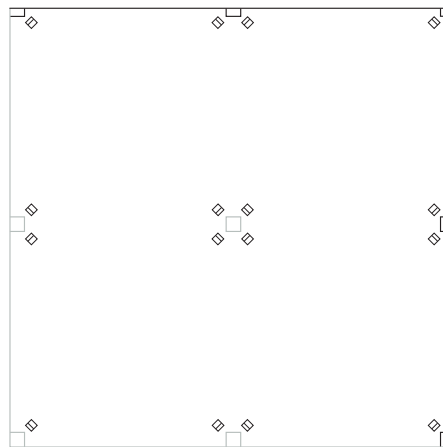
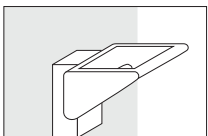

When only indirect, uniform lighting of the vaulted ceiling is required this can be achieved using ceiling washlights mounted on the pillars. If installation on the pillars presents a problem, free-standing luminaires can be used.

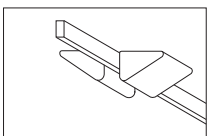

Light structure with pairs of ceiling washlights for halogen lamps plus track-mounted spotlights.

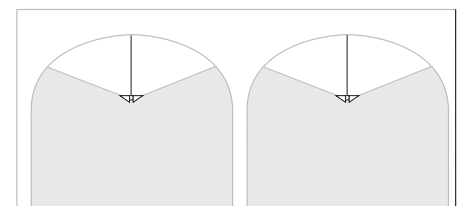
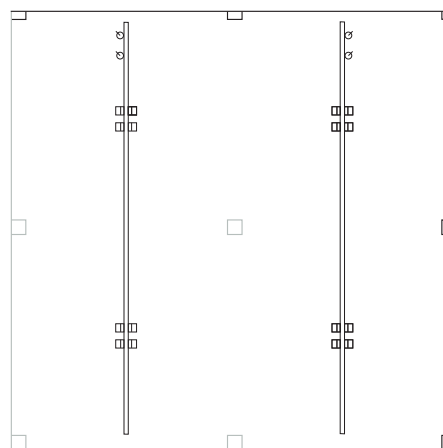
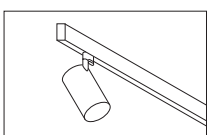

Groups of four ceiling washlights are mounted on a suspended light structure installed on the central axis of the vaults. These washlights provide indirect lighting. Spotlights can be mounted on the lower part of the structure for accent lighting purposes.

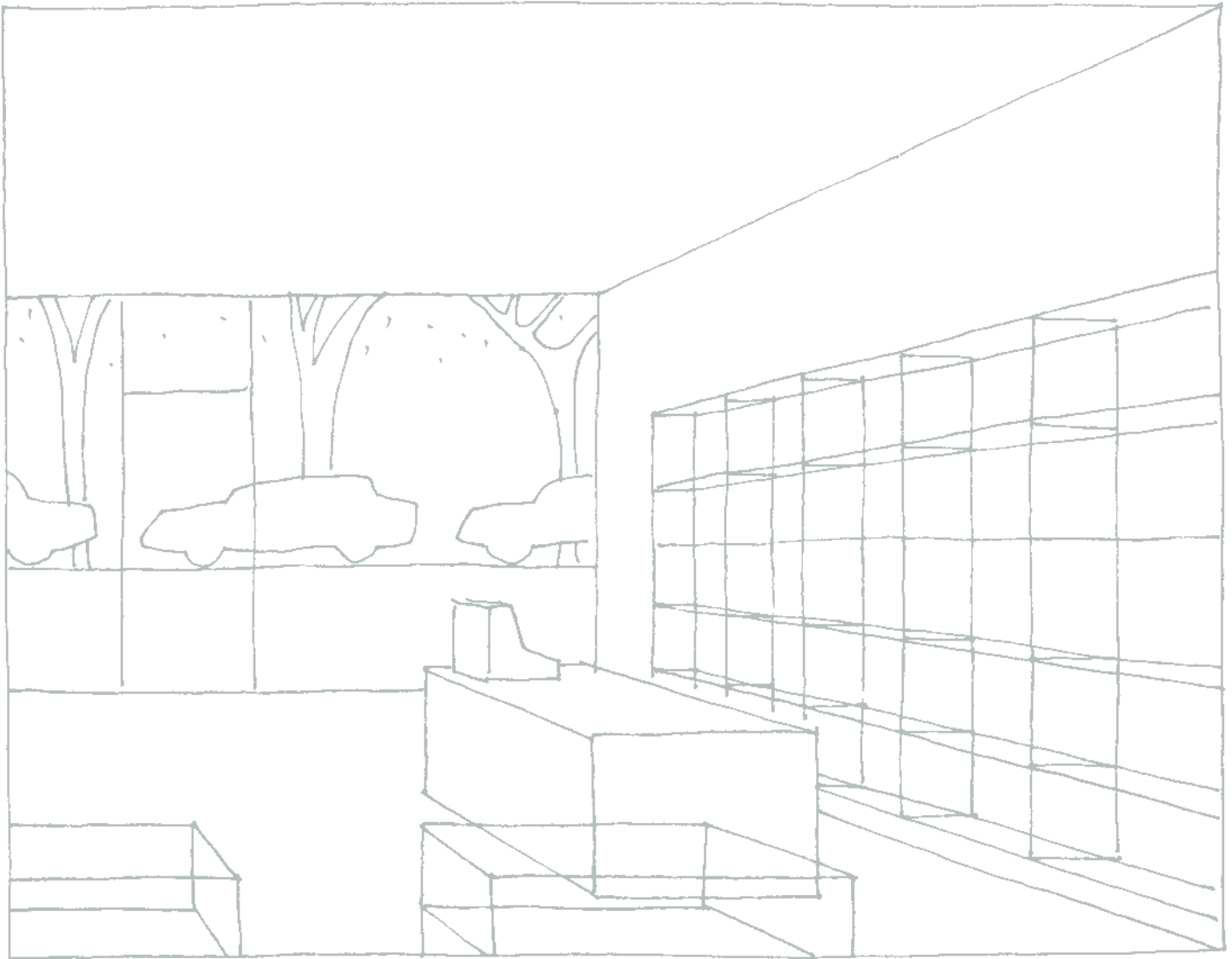

4.17 Sales areas, boutiques

When developing lighting design concepts for boutiques or similar sales areas the tasks that require attention are accent lighting for the presentation of goods, an attractive entrance area, and ambient lighting. The lighting of the cash-desk as a workplace should be treated separately.

In general it can be stated that the level of lighting increases with the quality of the goods and the more exclusive the location; at the same time the general lighting is reduced in favour of differentiated lighting. Cheaper articles can be displayed under uniform, efficient lighting, whereas high-quality goods require presentation using accent lighting.

As opposed to standard installed loads of 15 W/m^2 for ambient and accent lighting respectively, the connected load with high levels of accent lighting may amount to over 60 W/m^2 .

The lighting design concept will frequently go beyond the standard repertoire of lighting effects and luminaires in order to create a characteristic atmosphere. Dramatic lighting effects, such as coloured light or projection lighting, are also possible, as are distinctive light structures or decorative luminaires.

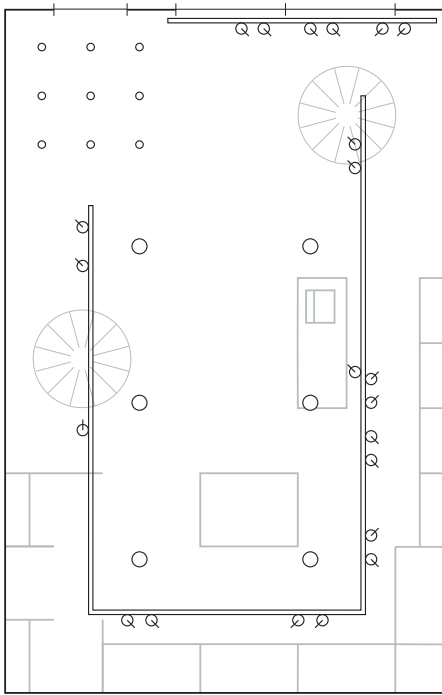

The ambient lighting in the boutique is provided by a group of six recessed downlights; low-voltage downlights arranged closely together accentuate the entrance "welcome mat". Track-mounted spotlights provide accent lighting in shop-windows, on shelves and for displays. The cash-desk, treated as a workplace, is additionally illuminated by a track-mounted spotlight, making it easier for customers to find.

Recessed downlight for metal halide lamps.

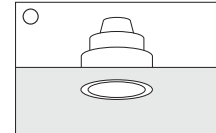

Recessed downlight for low-voltage halogen lamps.

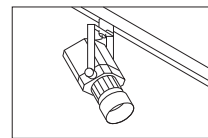
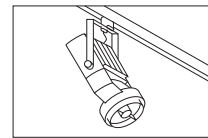
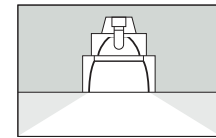
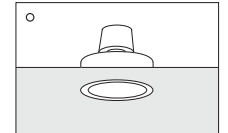

Track with spotlights for metal halide lamps and low-voltage halogen lamps.

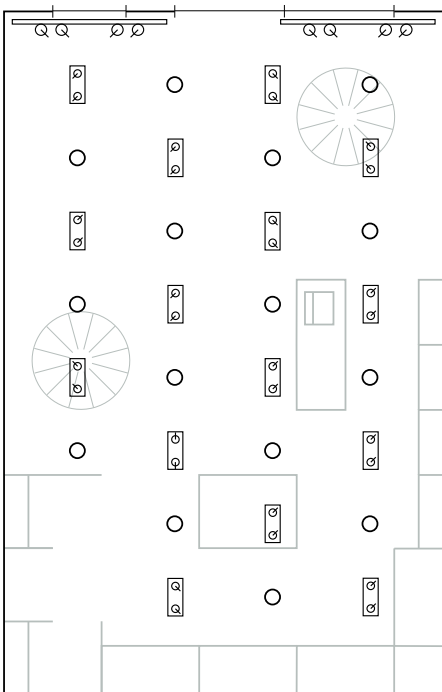

The lighting of the boutique is based on a regular layout, in which two components are arranged in a staggered pattern. The downlight component provides uniform ambient lighting, the second component consists of pairs of directional spotlights for accent lighting of the shelves and displays. The shop-window displays are illuminated separately using track-mounted spotlights.

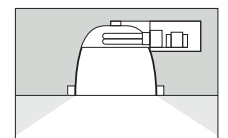
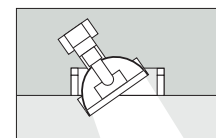
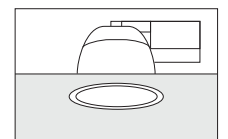
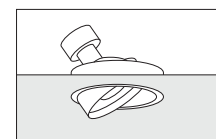

Recessed directional spotlight for low-voltage halogen lamps.

Recessed downlight for compact fluorescent lamps.

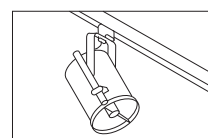

Track-mounted spotlights.

This project has been given an architectural lighting concept. Integral directional washlights are mounted in a suspended ceiling installed around the walls. In the central area are a series of light structures arranged parallel to each other with integral, indirect luminaires. Spotlights are fitted in the track for accent lighting of garments and cash-desk. Shop-window displays are illuminated by track-mounted spotlights.

Light structure with integral indirect luminaires for fluorescent lamps and spotlights mounted on integral track.

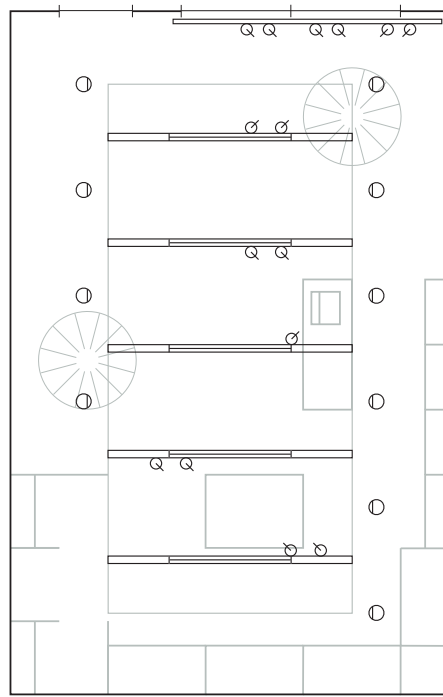
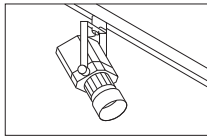
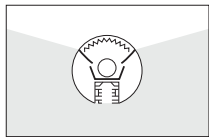
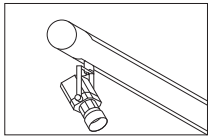

Track-mounted spotlights.

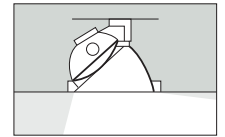
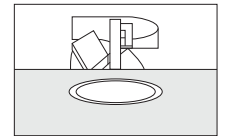
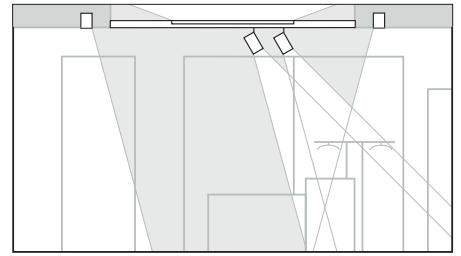

Recessed directional wallwasher for metal halide lamps, high-pressure sodium lamps or halogen lamps.

Directional spotlights are recessed into an L-shaped suspending ceiling to produce accent lighting on the walls. A double portal comprising a lattice beam structure with integral track is a main feature in the boutique and takes spotlights to accentuate displays. Shop-window displays are illuminated by track-mounted spotlights.

In the centre of the area lens projectors create special lighting effects on the wall or floor (e.g. coloured beams of light, patterns or a company logo). A series of downlights accentuate the entrance area and create a "welcome mat" effect.

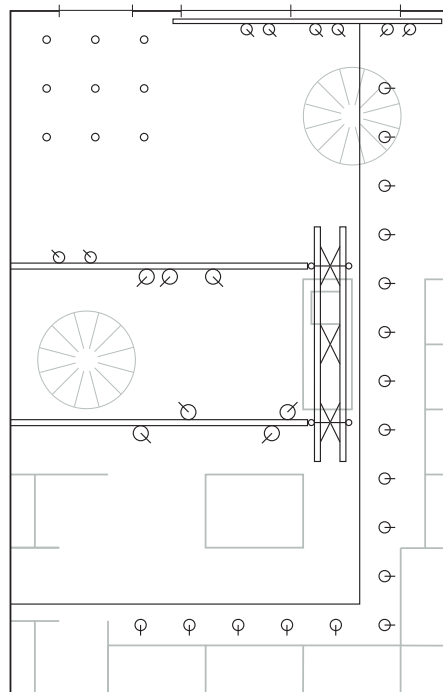

Recessed directional spotlight for low-voltage halogen lamps.

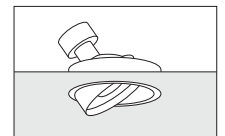

Lattice beam structure with integral track for the mounting of spotlights and lens projectors.

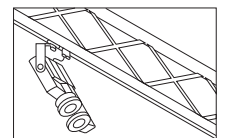

Downlight for low-voltage halogen lamps.

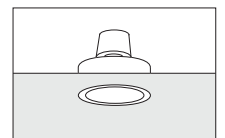

Track-mounted spotlights.

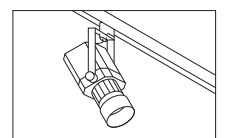

The ambient lighting in the boutique is provided by two light structures running the length of the space and equipped with indirect luminaires for the lighting of the shallow ceiling vaults. Three runs of track are recessed in the ceiling parallel to the light structures and take spotlights for accent lighting on shelves and displays. Two groups of six directional spotlights provide accent lighting in the shop-window.

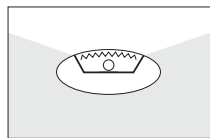
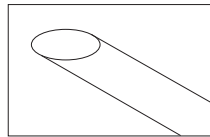
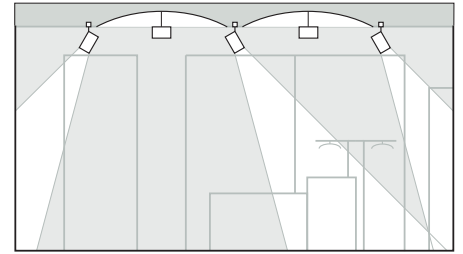
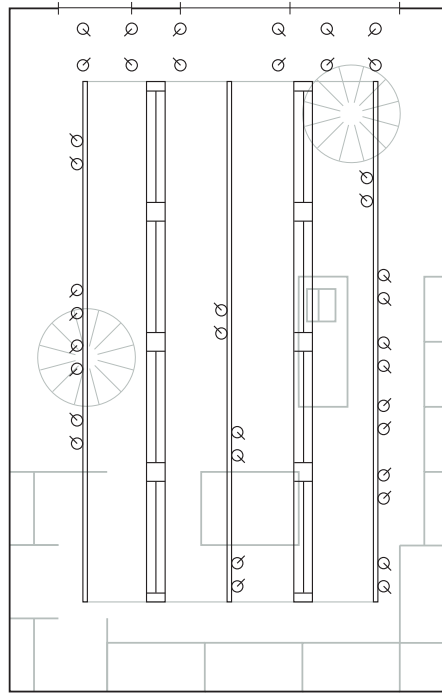

Light structure with indirect luminaires for fluorescent lamps.

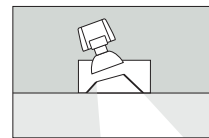
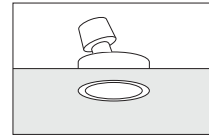

Directional spotlight for low-voltage halogen lamps.

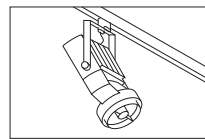
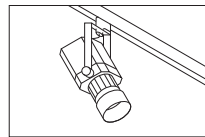

Track-mounted spotlights.

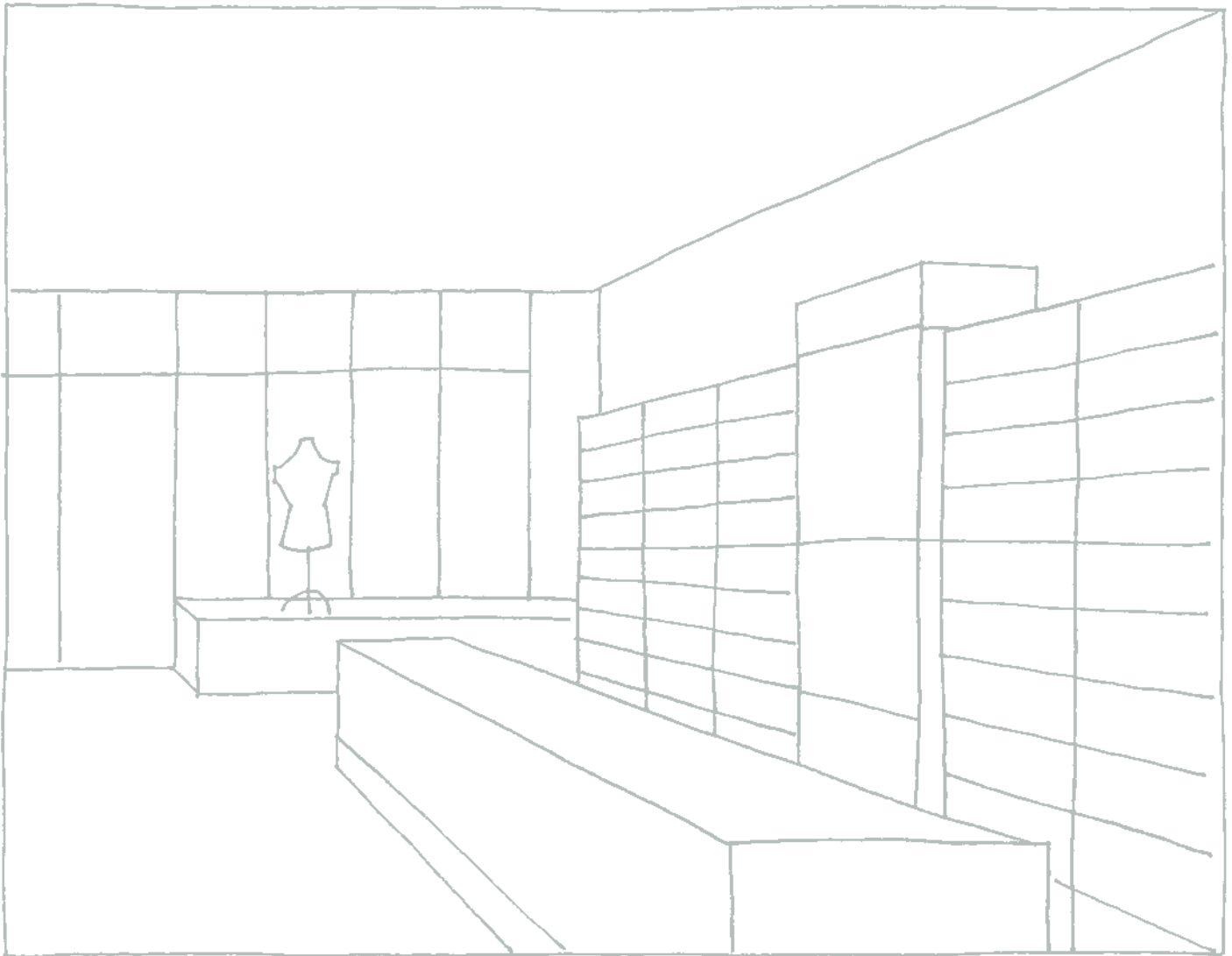

4.18 Sales areas, counters

Sales areas where customers are served by staff at counters are mainly found in retail outlets where customers require consultation, e.g. a jeweller's shop. The counter itself creates a dividing element in the space, the resulting areas each requiring their own lighting. The main circulation area requires general lighting. Shelves or showcases require vertical display lighting, the counter itself glare-free horizontal lighting.

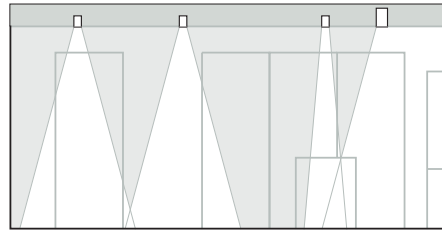
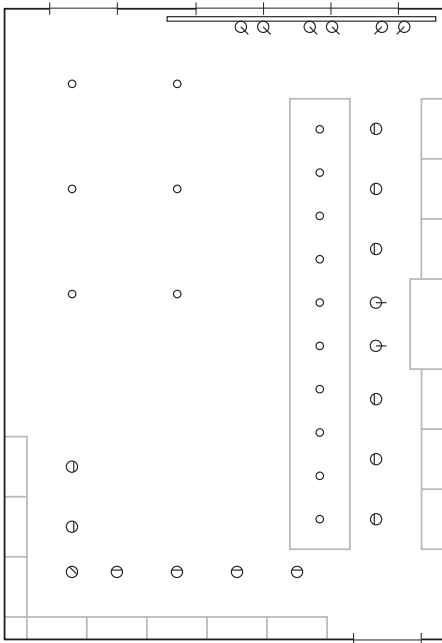

Recessed downlights with various beam angles illuminate the entrance and the counter. The shelves are accentuated by directional floodlights and directional spotlights; track-mounted spotlights provide direct lighting in the shop-window.

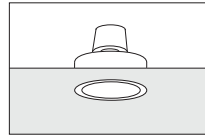

Recessed downlight for low-voltage halogen lamps.

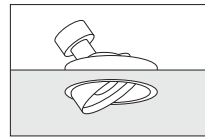

Recessed directional spotlight for halogen lamps.

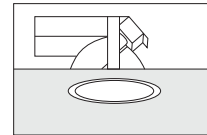

Directional floodlight for compact fluorescent lamps.

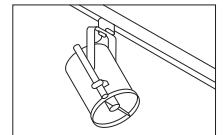

Track-mounted spotlights.

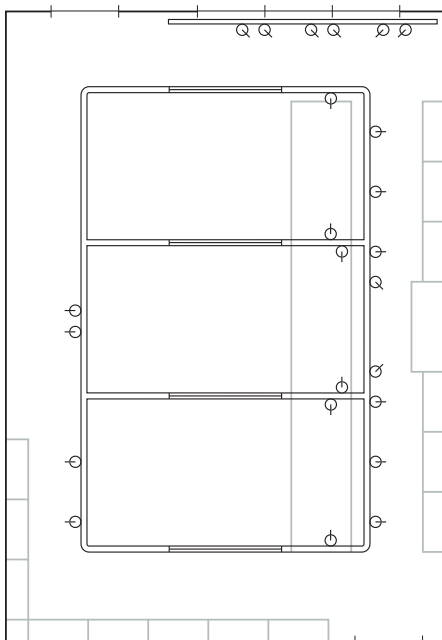
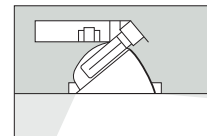

The lighting is mounted on a suspended light structure. Ambient lighting is provided by indirect luminaires. Spotlights mounted on the structure accentuate shelves and counter; spotlights mounted on a separate track provide direct lighting in the shop-window.

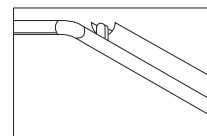

Light structure with indirect luminaires for fluorescent lamps, and spotlights.

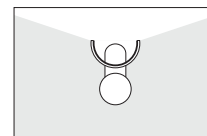

Track-mounted spotlights.

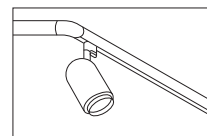
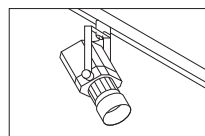

4.0 Examples of lighting concepts
 4.18 Sales areas, counters

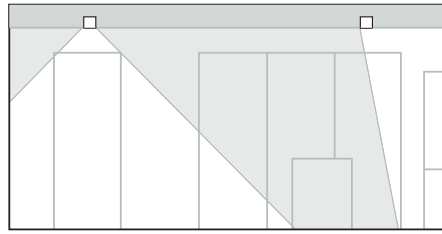
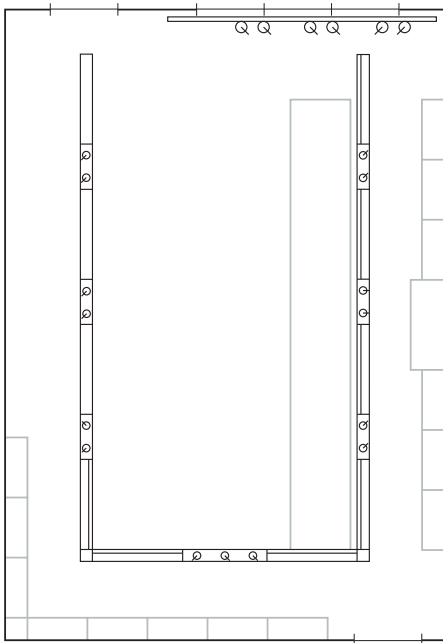

The lighting is mounted in a U-shaped installation channel. Symmetrical louvred luminaires provide the ambient lighting, asymmetrical louvred luminaires the vertical lighting of the shelves, and additional directional spotlights accent lighting on special offers. Track-mounted spotlights provide direct lighting in the shop-window.

Installation channel with direct lighting from recessed louvred luminaires for fluorescent lamps and directional spotlights for low-voltage halogen lamps.

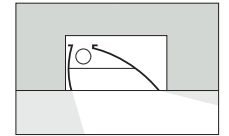
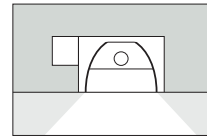
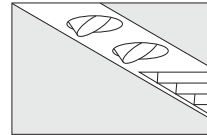

Recessed wallwasher for fluorescent lamps.

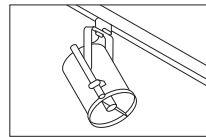

Track-mounted spotlights.

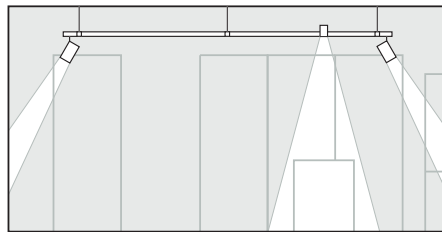
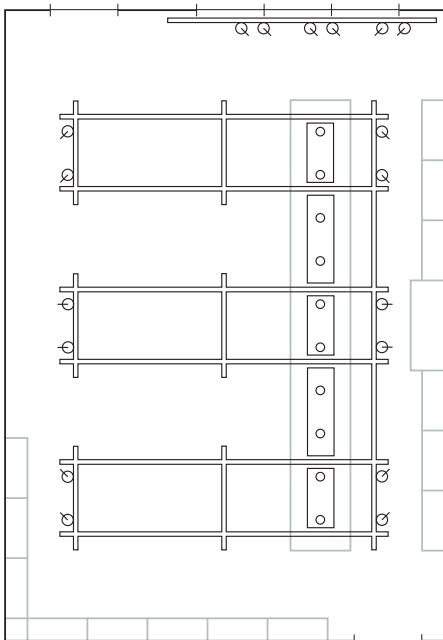
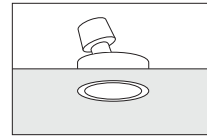

The lighting is mounted on a suspended light structure. Panels are inserted in the structure above the counter which take decorative downlights. Spotlights are used to accentuate shelves and focal points on the walls. Spotlights mounted on a separate track provide direct lighting in the shop-window.

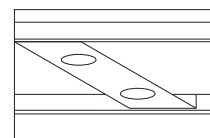

Light structure with panels, decorative recessed downlights for low-voltage halogen lamps and tracks with spotlights for low-voltage halogen lamps.

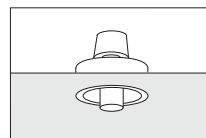

Track-mounted spotlights.

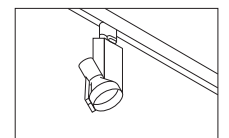
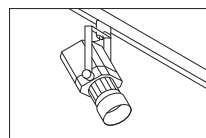

**4.19 Administration buildings,
public areas**

Spaces where office space and public areas meet can be found in a wide variety of buildings: local authorities, insurance companies or banks. There is usually a counter or a row of individual counters between the public area and the office space.

Both room areas and the counter area itself require specific lighting. The lighting in the public area can be compared with that in a lobby, whereas the lighting in the office area must meet the requirements of the workplaces. It is advisable that the lighting over the counter

matches the shape and marks it clearly. If direct access is available from the street – as is often the case with banks – the lighting of the entrance area must be treated as a separate lighting entity.

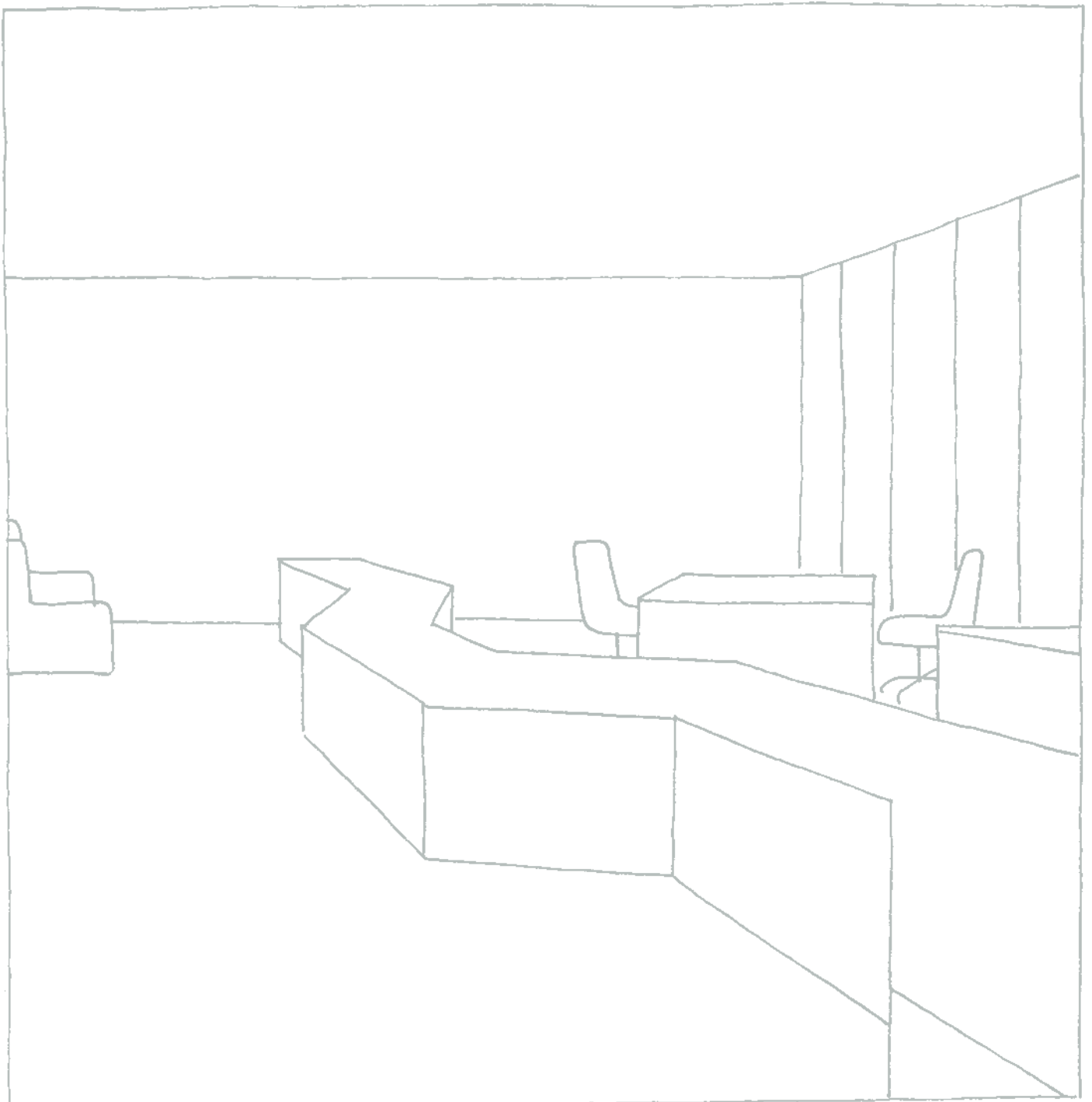

4.0 Examples of lighting concepts
 4.19 Administration buildings,
 public areas

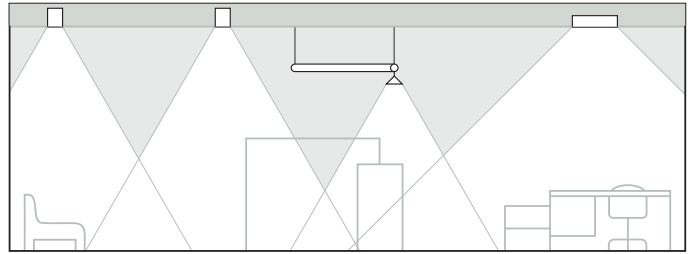
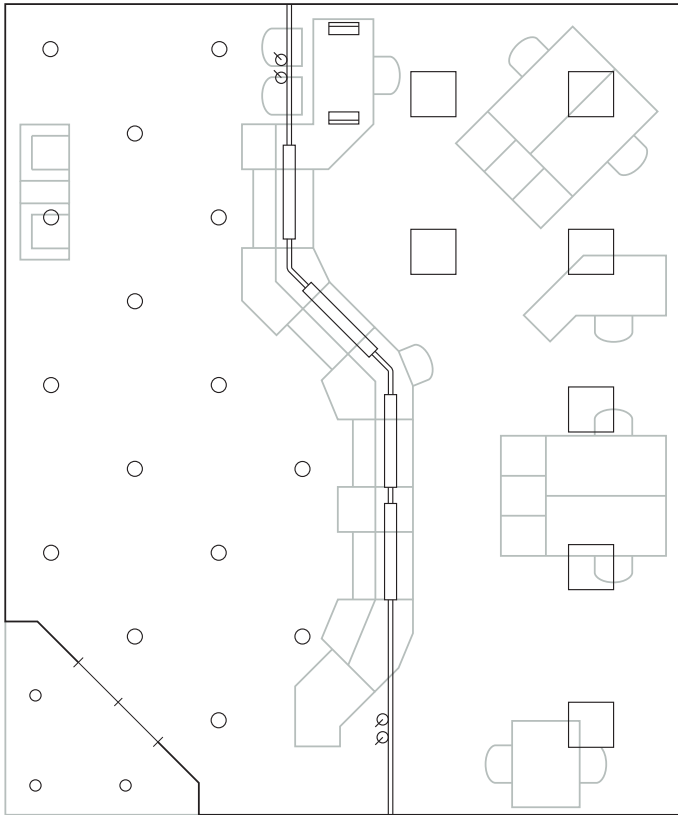

The public area is illuminated by a staggered layout of downlights. The entrance area is illuminated separately, also by downlights. Lighting for the office area is provided by square louvred luminaires arranged in a regular pattern across the ceiling. A light structure with direct louvred luminaires is suspended above the service counter; task lights provide additional lighting on the information desk. Spotlights mounted on the light structure accentuate focal points.

Recessed louvred luminaire for compact fluorescent lamps.

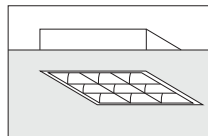

Light structure with louvred luminaires for fluorescent lamps and spotlights.

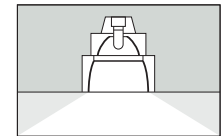
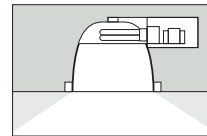
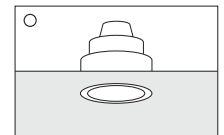
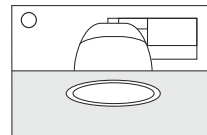
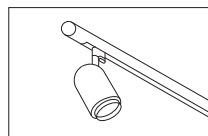
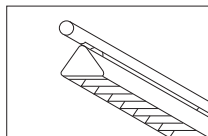

Recessed downlight for compact fluorescent lamps.

Recessed downlight for metal halide lamps.

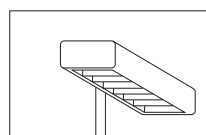

Task light for compact fluorescent lamps.

4.0 Examples of lighting concepts
 4.19 Administration buildings,
 public areas

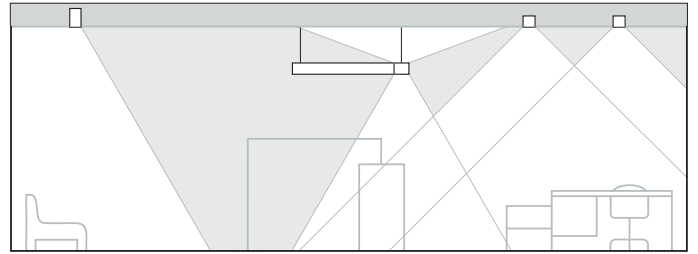
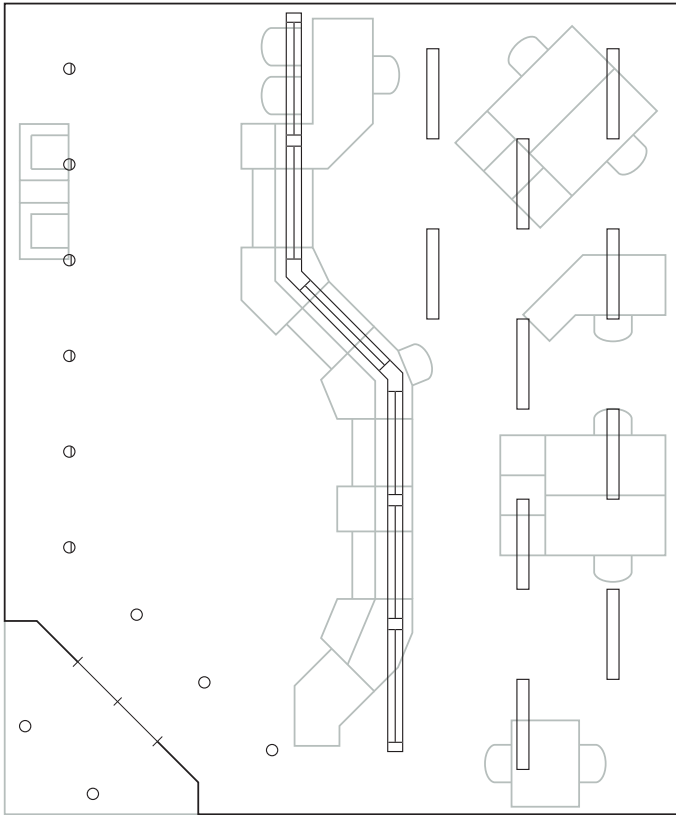

The public area is illuminated by washlights, with additional downlights accentuating the entrance. The office area is illuminated by a staggered arrangement of louvred luminaires. A light structure with direct-indirect louvred luminaires is suspended above the counter.

Light structure with direct-indirect louvred luminaires for fluorescent lamps.

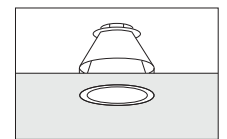
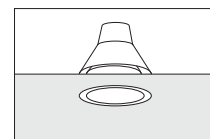
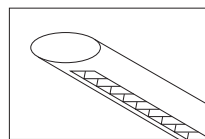

Recessed louvred luminaire for fluorescent lamps.

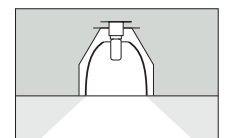
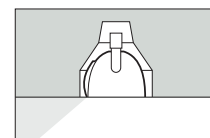
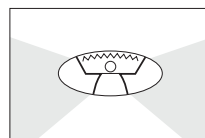
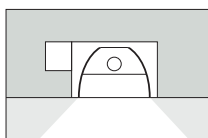
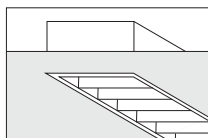

Recessed washlight for halogen lamps.

Recessed downlight for halogen lamps.

4.0 Examples of lighting concepts
 4.19 Administration buildings,
 public areas

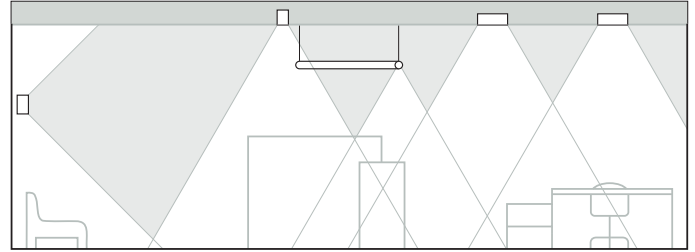
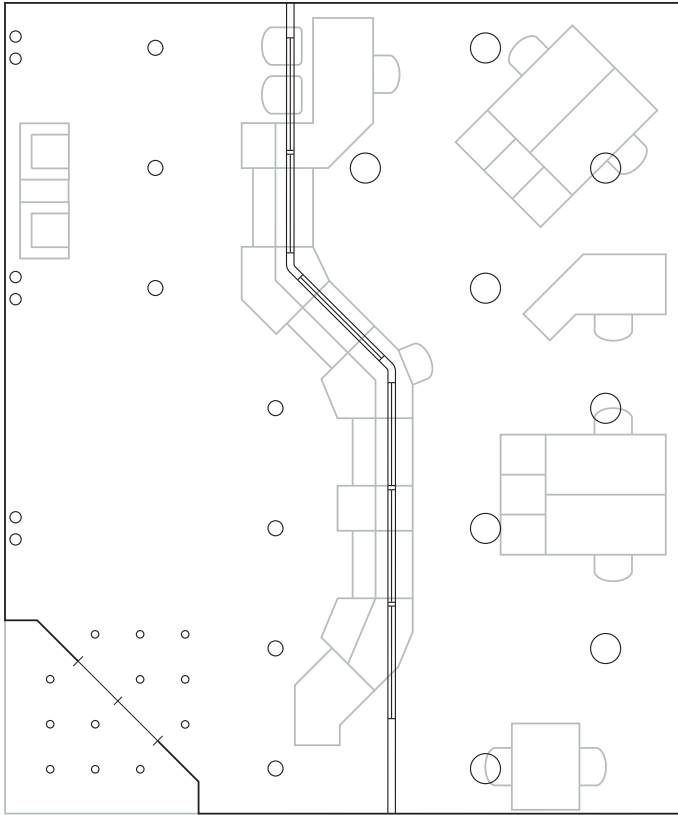

Pairs of combined up/downlights are installed along the one side wall. They provide indirect light and the beams of light they produce subdivide the wall. Downlights positioned in front of the counter produce increased illuminance. Decorative downlights create a "welcome mat" effect in the entrance area. A light structure with luminaires equipped with fluorescent lamps is suspended above the counter. The office area is illuminated by a staggered arrangement of downlights with cross baffles.

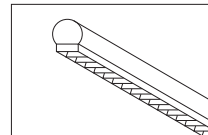

Light structure with luminaires for fluorescent lamps.

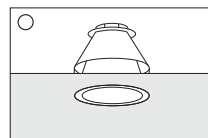

Recessed downlight for halogen lamps.

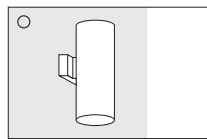

Wall-mounted combined up/downlight for PAR 38 reflector lamps.

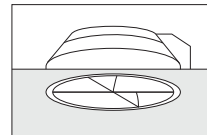

Recessed downlight with cross baffles for compact fluorescent lamps.

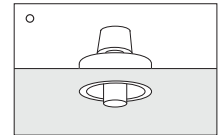

Decorative recessed downlight for low-voltage halogen lamps.

4.0 Examples of lighting concepts
 4.19 Administration buildings,
 public areas

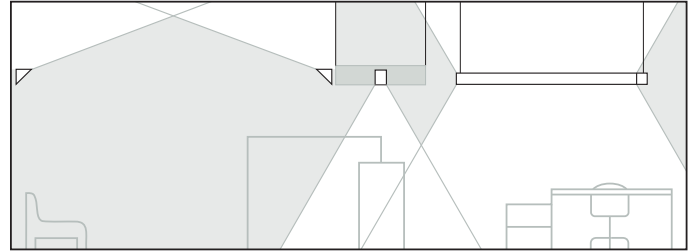
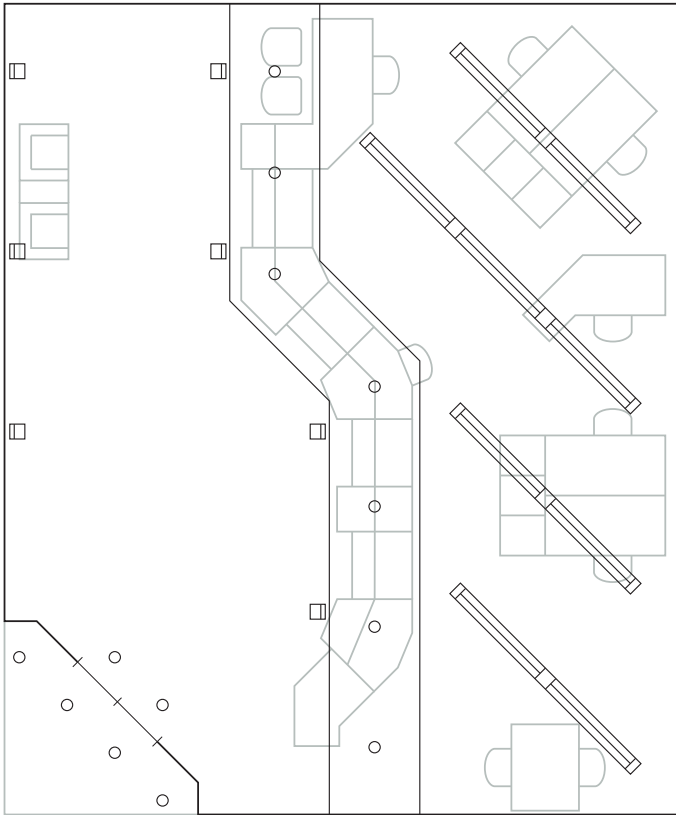

The indirect lighting in the public area is provided by ceiling washlights. A series of downlights in the entrance area create a "welcome mat" effect. A suspended ceiling with integral downlights follows the course of the counter. The office area is illuminated by a light structure arranged diagonally to the main axis and fitted with direct-indirect louvred luminaires.

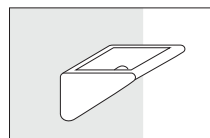

Wall-mounted ceiling washlight for halogen lamps.

Recessed downlight for low-voltage halogen lamps.

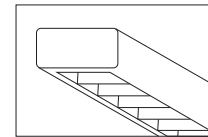
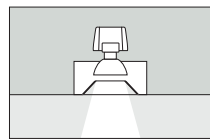
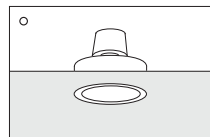

Light structure with direct-indirect louvred luminaires for fluorescent lamps.

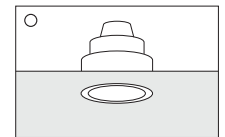

Recessed downlight for metal halide lamps.

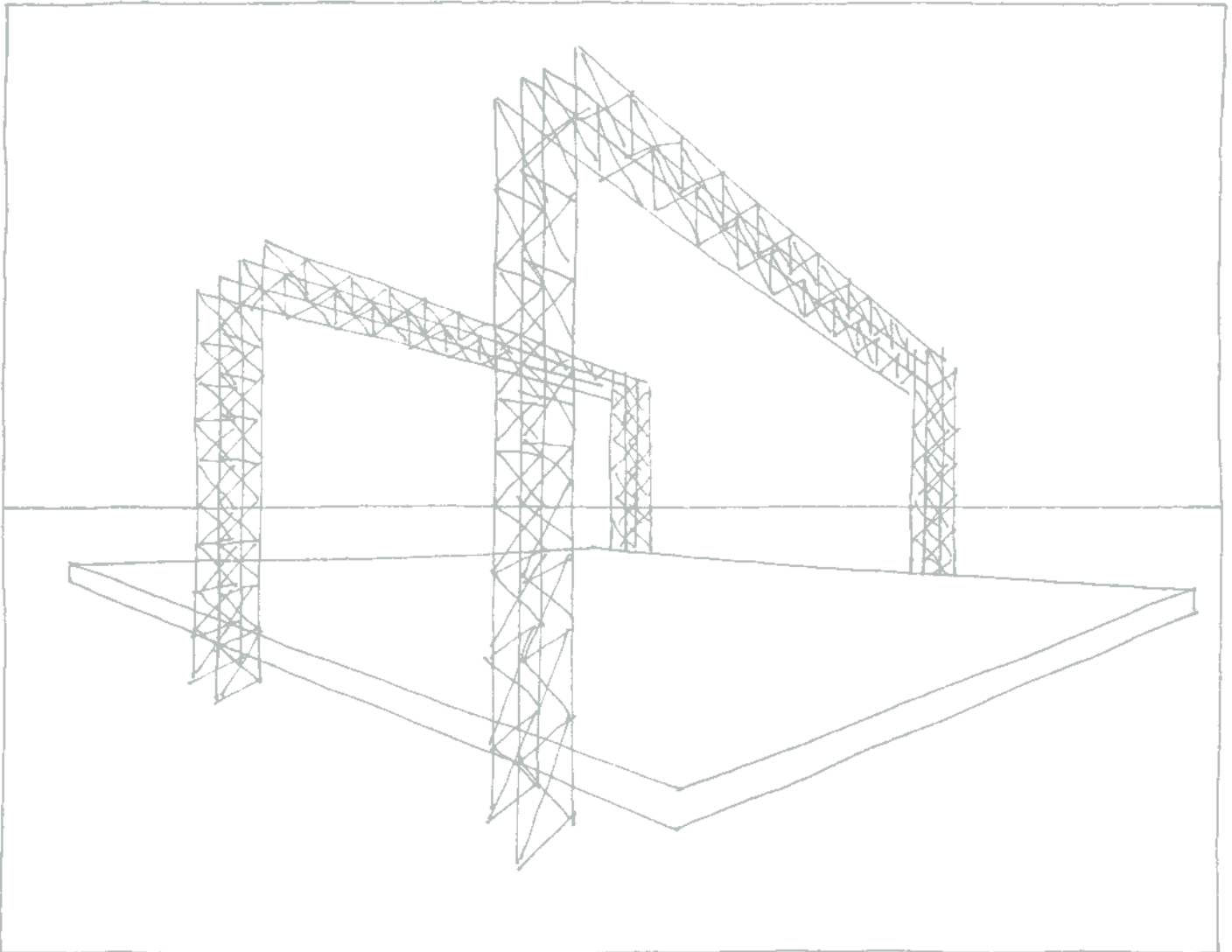

4.20 Exhibitions

A frequent task of exhibition lighting is to create defined presentation area within a larger space. This kind of lighting is frequently required in halls or pavilions at trade fairs, at airports and other travel terminals. Such areas are used for the exhibition of specific products in department stores or car showrooms, or even for fashion shows in hotels or congress centres.

Since it is usually a case of providing temporary lighting, sometimes only for a few days, it is advisable to go for a demountable, adaptable construction on which to install the lighting. Modular lattice beam structures meet these requirements best. They can be erected irrespective of the surrounding architecture, and varied in size and shape due to their modular construction. It is most customary to use load-bearing structures onto which luminaires can be mounted mechanically. Structures with integral track are practical because they save having to wire the structure; integral track allows a large number of luminaires to be mounted and controlled easily.

Power tripods present an especially versatile solution, which allows lighting to be set up quickly and easily.

As in the case of all exhibition lighting accent lighting is by far the more important component; ambient lighting that also serves as the base lighting for the surrounding architecture is usually only required on stands at trade fairs. Spotlights and projectors are the luminaires most commonly used. They produce direct light and excellent colour rendering, which emphasises the qualities of the materials on display. Stage effects can also be used for presentation lighting, e.g. coloured light or projections; the lighting design may consist of a comprehensive range of design possibilities – irrespective of the setting or the objects being presented.

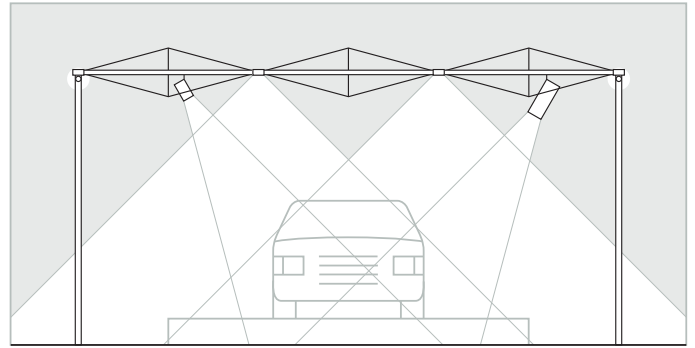
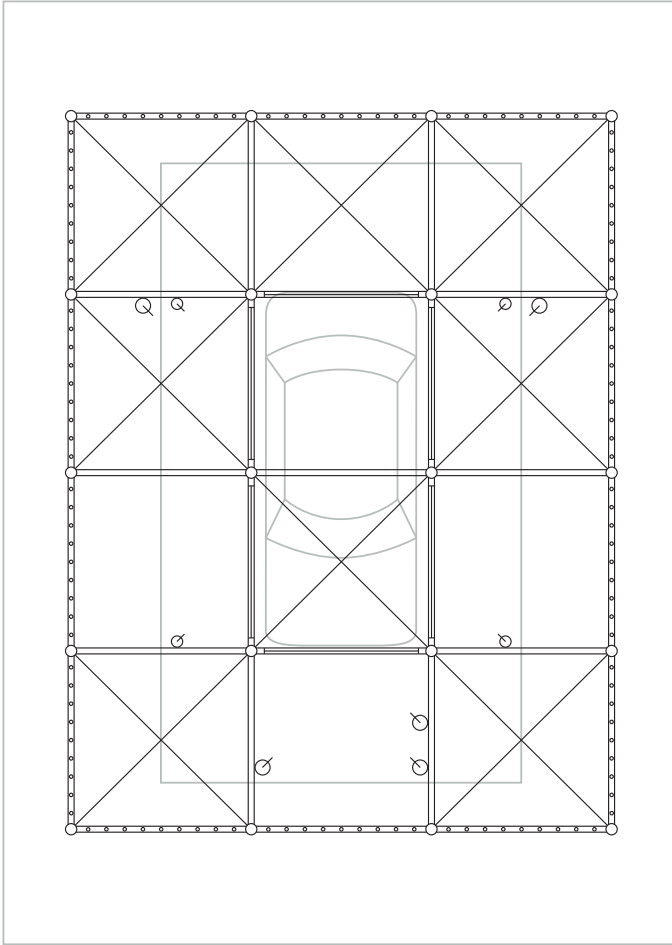

The lighting is mounted on a wide-span light structure with textile ceiling elements. The structure takes direct luminaires designed for fluorescent lamps and small decorative lamps and spotlights for accent lighting.

Wide-span light structure with luminaires for fluorescent lamps, small decorative lamps and track-mounted spotlights.

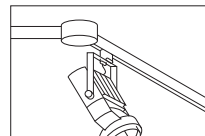
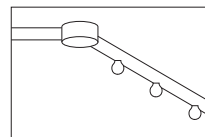
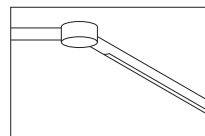

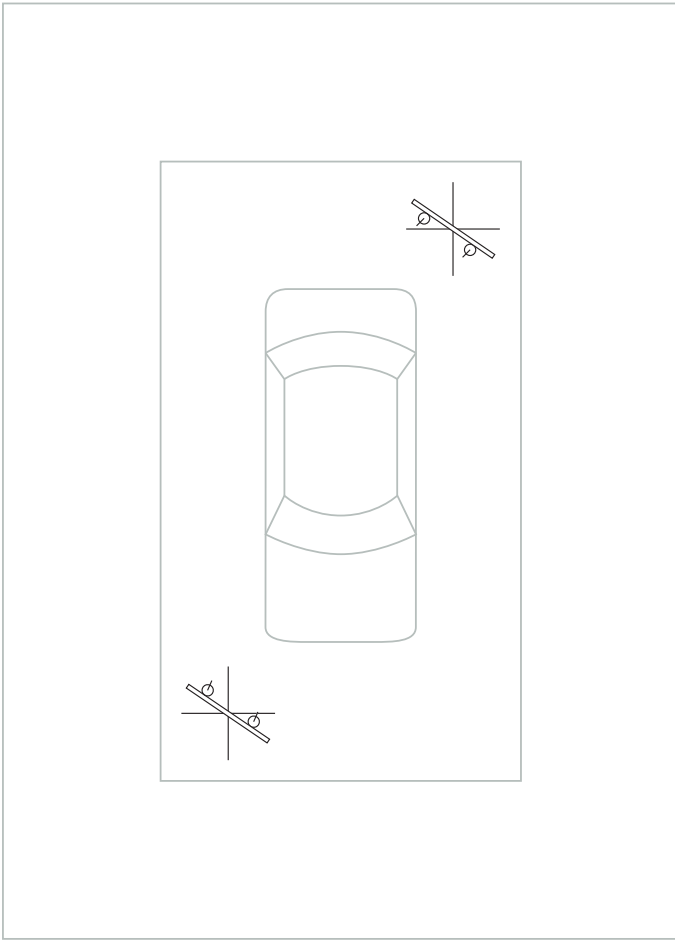

Spotlights mounted on a power tripods make for variable exhibition lighting.

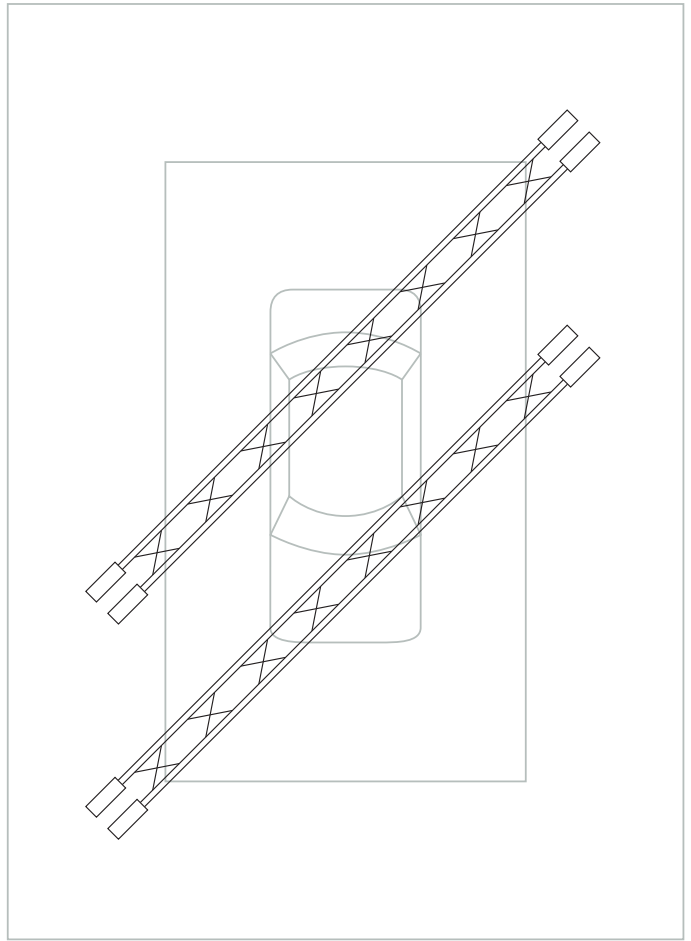

The lighting is installed on a double portal frame structure comprising lattice beams with integral tracks aligned diagonally to the presentation space. Spotlights and projectors are used for striking accent lighting, clearly defined beams and gobo projections.

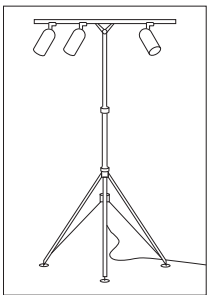

Power tripod with spotlights.

Lens projectors and spotlights mounted on lattice beams with integral tracks.

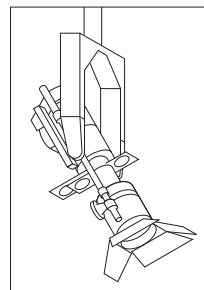
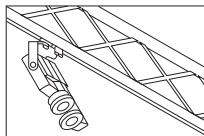

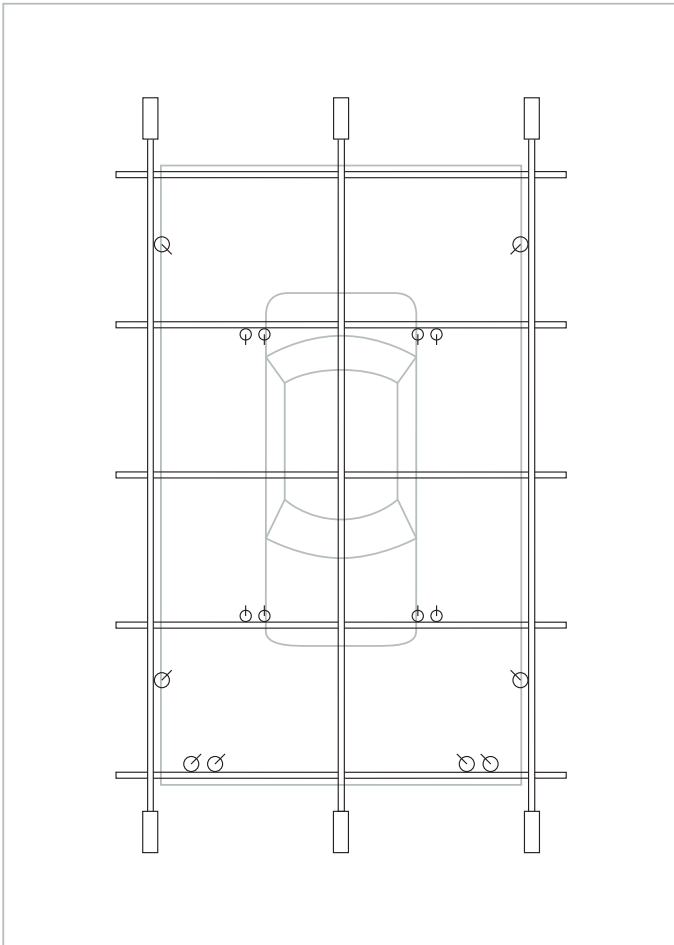

The lighting is installed on a freestanding, wide-span structure comprising lattice beams with integral tracks. Spotlights and projectors are used for striking accent lighting and clearly defined beams and gobo projections.

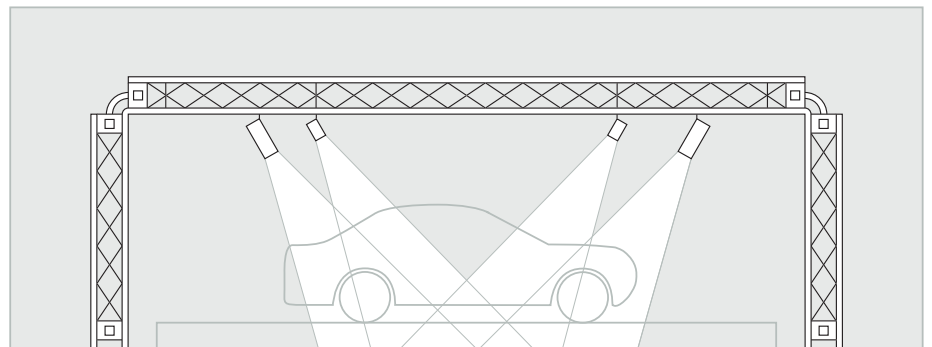

Lens projectors and spotlights mounted on lattice beams with integral tracks.

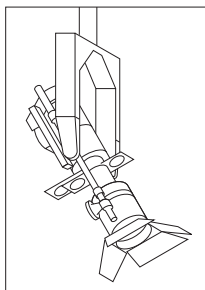
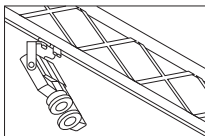

5.0

Appendix

Illuminance recommendations

Space/activity	Recommended min. illuminance E (lx)	Light source
Office	300	T, TC
Team office	500	T
Open plan office	750	T, TC
Technical drawing office	750	T, TC
Data processing	500	T, TC
CAD	200/500	A, QT, T, TC
Control room	200	TC
Corridor	50	TC
Staircase	100	T, TC
Canteen	200	A, QT, QT-LV, TC
Bathroom, WC	100	T, TC
Sales area	300	QT, QT-LV, T, TC, HST, HSE, HIT
Department store	300	QT, QT-LV, T, TC, HST, HSE, HIT
Cashdesk	500	T, TC
Supermarket	500	T, HIT
Reception	200	A, QT, QT-LV, TC
Restaurant	200	A, PAR, R, QT, QT-LV, TC
Café, bistro	200	A, PAR, R, QT, QT-LV, TC
Self-service restaurant	300	T, TC
Canteen kitchen	500	T
Museum, gallery	200	A, PAR, R, QT, QT-LV, T, TC
Exhibition space	300	PAR, R, QT, QT-LV, T, TC, HST, HSE, HIT
Trade fair hall	300	T, HME, HIT
Library, media library	300	T, TC
Reading room	500	T, TC
Gymnasium, competition	400	T, HME, HIE, HIT
Gymnasium, training	200	T, HME, HIE, HIT
Laboratory	500	T
Beauty salon	750	QT, QT-LV, T, TC
Hairdressing salon	500	T, TC
Hospital, ward - ambient lighting	100	T, TC
- reading light	200	A, QT-LV, T, TC
- examination light	300	QT, T, TC
Hospital, examination	500	T
Reception, lobby	100	QT, T, TC
Circulation area	200	QT, T, TC
Classroom	300/500	T, TC
Large classroom	750	T, TC
College hall	500	T, TC
Art studio	500	T, TC
Laboratory	500	T, TC
Lecture hall, auditorium	500	QT, T, TC
Multi-purpose space	300	QT, T, TC
Concert, theatre, festival hall	300	A, PAR, R, QT
Concert platform	750	PAR, R, QT
Meeting room	300	A, QT, TC
Church	200	A, PAR, R, QT

Recommended minimum illuminances (E) for typical interior lighting tasks. The illuminances are aimed at a lighting level appropriate to the specific visual tasks to be performed in the space or in a part of the space. They do not include architectural lighting components or other

aspects for the specific situation. The average horizontal illuminances quoted are in accordance with national and international standards. Using the light sources indicated lighting qualities can be achieved to meet the requirements of the particular visual task economically.

Classification of lamps

The ZVEI, the German Electrical Engineering and Industrial Federation, has developed a system of abbreviations for electric lamps used for general lighting purposes. Some lamp do manufacturers use different abbreviations, however.

The ZVEI system of designation consists of up to three characters. These are supplemented by further abbreviations for special models or versions, which are hyphenated.

The first letter indicates the light production.

I	Incandescent lamp
H	High-pressure discharge lamp
L	Low-pressure discharge lamp

The second letter indicates the material of the outer envelope for incandescent lamps, or the gas contained in discharge lamps.

G	Glass
Q	Quartz glass
M	Mercury
I	Metal halide
S	Sodium vapour

The third letter or combination of letters indicates the form of the outer envelope.

A	General
E	Ellipsoidal
PAR	Parabolic reflector
R	Reflector
T	Tubular
TC	Compact tubes

To complete the classification of a lamp data regarding diameter of lamp or reflector, power, colour of outer envelope, beam spread, type of cap and voltage can be added to the above identification.

General service lamp	(I) (G) A	A
Parabolic reflector lamp	(I) (G) PAR	PAR
Reflector lamp	(I) (G) R	PAR
Halogen reflector lamp	(I) Q R	QR
Halogen lamp (tubular form)	(I) Q T	QT
Mercury lamp (ellipsoidal form)	H M E	HME
Mercury lamp (reflector form)	H M R	HMR
Metal halide lamp (ellipsoidal form)	H I E	HIE
Metal halide lamp (reflector form)	H I R	HIR
Metal halide lamp (tubular form)	H I T	HIT
High-pressure sodium lamp (ellipsoidal form)	H S E	HSE
High-pressure sodium lamp (tubular form)	H S T	HST
Fluorescent lamp	(L) (M) T	T
Compact fluorescent lamp	(L) (M) TC	TC
Low-pressure sodium lamp	L S T	LST

Standard abbreviations for lamps in this book. The letters in brackets are not used in practice. The resulting abbreviations are given in the right-hand column.

Halogen lamp, double-ended	QT-DE
Halogen reflector lamp, coolbeam, without cover	QR-CB
Halogen reflector lamp, coolbeam, with cover	QR-CBC
Metal halide lamp, double-ended	HIT-DE
Compact fluorescent lamp	TC
- without starter for EB	TC-EL
- with 4 discharge tubes	TC-D
- with 4 discharge tubes, with integral EB	TC-DSE
- with 4 discharge tubes, without starter for EB	TC-DEL
- linear form	TC-L

Abbreviations for special models or versions are separated from the main abbreviation by a hyphen.

Glossary

Aberration

Defective image in the eye. A distinction is made between spherical aberration, which is a result of the different focal lengths of central and peripheral areas of the lens, and chromatic aberration, which occurs when the refraction of light of different wavelengths is changed

Absorption

The ability of materials and substances to transform light into other forms of energy (primarily heat) without reflecting or transmitting it. The degree of absorption is defined as the ratio of absorbed luminous flux to the incident flux

Accent lighting

Accenting of individual areas of a space by means of lighting that is significantly higher than the level of → the ambient lighting. → Focal glow

Accommodation

The physiological adjustment of the eye to be able to identify objects at different distances. Effected by deformation of the lens. Accommodation deteriorates with age

Adaptation

The ability of the eye to adjust to → luminances in the field of vision. Effected primarily through the enlarging or reducing of the size of the pupil, most significantly effected by changes in the sensitivity of the receptors on the retina and the change between → photopic vision and → scotopic vision

Ambient light

Ambient light provides general lighting of the visual environment. Architecture, objects and people in the environment are visible, which allows orientation, work and communication

Angle of view

Angle at which an object under view is perceived, measure for the size of the image of the object on the → retina

Anodizing

Electro-chemical oxidation of metal surfaces, mostly of aluminium. Anodized surfaces that are subsequently polished or treated chemically to produce a glossy finish are extremely durable and have high → (luminous) reflectance

Ballast

Current limiting → control gear for → discharge lamps. Current limitation is effected either inductively, using a choke, or electronically. Inductive ballasts are available as conventional ballasts (CB) or low-loss ballasts (LLB). They may require an additional ignitor or starting device. Electronic ballasts (EB) do not require additional ignitors. They do not produce disturbing humming noises or → stroboscopic effects

Barndoors

Term used to describe rectangular anti-dazzle screens used predominantly with stage projectors

Batwing characteristics

→ Light intensity distribution curve of a luminaire with especially wide-angled light intensity distribution characteristics. The name is derived from the batwing shape of the light intensity distribution curve

Beam spread

The angle between the limits from which the axial value of a → light intensity distribution curve decreases to 50%. The beam spread is the basis for calculating the diameter of light beams emitted by symmetrical luminaires

Biological needs

The biological needs a lighting concept is expected to meet depend largely on the specific activities to be performed. They are the result of basic human needs for information regarding the time of day, the weather and things that are happening. This fulfils the need for safety, spatial orientation and a clearly structured, legible environment together with the need for a balanced ratio of possible contact with other persons and a private domain

Black body

→ Planckian radiator

Brilliance

Describes the effect of light on glossy surfaces or transparent materials. Brilliance is produced by the reflection of the light source or the light being refracted; it is produced by compact, point light sources

Candela

Represented by the symbol I (cd)
Unit of → luminous intensity, the basic unit of measure in lighting technology.
1 cd is defined as the luminous intensity emitted by a monochromatic light source with a radiant power of 1/683 W at 555 nm at a solid angle of 1 steradian

Capacitive circuits

Circuits where a discharge lamp run on an inductive → ballast (CB, LLB) is compensated using a series capacitor. The circuit is then over-compensated, which means that a second lamp can be operated in parallel with the first (→ lead-lag circuit)

CB

Abbreviation for conventional → ballast

Central field of vision

The central field of vision is effectively the same as the working plane, as it consists of the visual task and its direct ambient field. The central field of vision is enclosed by the surrounding field as an extended ambient field. The concepts of central field of vision and surrounding field are used mainly in connection with luminance distribution

Chromacity coordinates

→ Standard colorimetric system

Chromacity diagram

→ Standard colorimetric system

Chromatic aberration

→ Aberration

CIE

Abbreviation for Commission Internationale de l'Eclairage, international lighting commission

Colour adaptation

The ability of the eye to adjust to the → luminous colour of an environment. Allows relatively natural colour perception even amongst different luminous colours

Colour rendering

Quality of the reproduction of colours under a given light. The degree of colour distortion in comparison with a reference light source is classified by the colour rendering index Ra, or by the colour rendering category

Colour temperature

Describes the → luminous colour of a light source. In the case of thermal radiators the colour temperature is almost equivalent to the temperature of the filament. In the case of discharge lamps, a correlated colour temperature is given. This is the temperature at which a → black body emits light of a comparable colour

Compact fluorescent lamp

→ Fluorescent lamps with especially compact dimensions due to a combination of several short discharge tubes or one curved discharge tube. Compact fluorescent lamps are single-ended lamps; starters, and sometimes also → ballasts, can be integrated into the cap

Compensation

If → discharge lamps are run on inductive → ballasts (CB, LLB), the power factor is below unity. Due to the phase shift of the voltage with respect to the current a certain amount of blind (reactive, wattless) current is produced, which loads the power mains. In the case of large-scale installations power supply companies require the blind current to be compensated by means of power factor correction capacitors

Cone vision

→ Photopic vision

Cones

→ Eye

Constancy

The ability of human perception to distinguish the constant qualities of objects (size, form, reflectance/colour) from changes in the environment (changes in distance, position within the space, lighting). The phenomenon of constancy is one of the essential prerequisites that allow the creation of a clearly structured image of reality from the changing luminance patterns on the retina

Contrast

Difference in the → luminance or colour of two objects or one object and its surroundings. The lower the contrast level, the more difficult the → visual task

Contrast rendition

Criterion for limiting reflected glare. Contrast rendition is described by the contrast rendition factor (CRF), which is defined as the ratio of the luminance contrast of the visual task under given lighting conditions to the luminance contrast under reference lighting conditions

Control gear

Control gear is the equipment required in addition to the actual lamp for the operation of the light source. This comprises generally → ballasts that regulate the current flow, → ignitors and → starting devices for the operation of discharge lamps, and transformers for the operation of low-voltage lamps

Controlling brightness

→ Dimmer

Convergence

Alignment of the optical axes of the eyes to an object, effectively parallel in the case of objects viewed at a considerable distance, meeting at an angle in the case of objects viewed at close range

Coolbeam reflector

→ Dichroic reflector which reflects mainly visible light but transmits (glass reflectors) or absorbs (metal reflectors) infrared radiation. Using coolbeam reflectors reduces the thermal load on illuminated objects. Often referred to as multi-mirror reflectors

Cove

Architectural element on the ceiling or wall that can accommodate luminaires (usually → fluorescent lamps or → high-voltage fluorescent tubes) for indirect lighting

Cove reflector

Reflector for linear light sources, by which the cross section at right angles to the longitudinal axis determines the lighting effect

Cut-off angle (lamp)

Angle above which no direct → reflection from the light source is visible in the → reflector. In the case of → darklight reflectors the cut-off angle of the lamp is identical to the cut-off angle of the luminaire. In other forms of reflector it may be less, so that reflected glare occurs in the reflector above the cut-off angle

Cut-off angle (luminaire)

The angle taken from the horizontal to the line from the inner edge of the luminaire to the edge of the light source. Together with the → cut-off angle (lamp), this angle is used to identify the glare limitation of a luminaire

Darklight reflector

→ Reflector

Daylight

Daylight consists of both direct sunlight and the diffuse light of an overcast or clear sky. Daylight illuminances are significantly higher than the illuminances produced by artificial lighting. The → luminous colour is always in the → daylight white range

Daylight factor

Ratio of the → daylight → illuminance on the → working plane in a space to the outdoor illuminance

Daylight simulator

Technical equipment for simulating sunlight and → daylight. Daylight is either simulated by a semi-spherical shaped arrangement of numerous luminaires or by the multireflection of a laylight ceiling in a mirrored room. Sunlight is simulated by a parabolic spotlight, which is moved to coordinate with the course of the sun for the duration of one day or one year. A daylight simulator allows model simulations of light and shadow conditions in planned buildings, the testing of light control equipment and measurement of → daylight factors on the model

Daylight white, dw

→ Luminous colour

Daytime vision

→ Photopic vision

Dichroic filters

→ Filters

Dichroic reflector

Reflector with a multi-layered selective reflective coating, which only reflects a part of the spectrum and transmits others. Dichroic reflectors are used primarily as → coolbeam reflectors, reflecting visible light and transmitting → infrared radiation. They are also used for inverse effect outer envelopes on lamps to increase the temperature of the lamp (hot mirror)

Diffuse light

Diffuse light is emitted by large luminous areas. The result is uniform, soft lighting which produces little → modelling or → brilliance

Dimmer

Regulating device for varying the luminous intensity of a light source. Generally in the form of a loss-free leading edge dimmer. Conventional dimmers can be used without problems for incandescent lamps run on mains voltage. Dimmers for fluorescent lamps and low-voltage lamps are technically more complicated; the dimming of high-pressure discharge lamps is technically possible, but it is also costly and is not often provided

Direct glare

→ Glare

Directed light

Directed light is emitted by point light sources. The beam direction is from one angle only, which provides → modelling and → brilliance effects. Exposed lamps also produce directed light. The variable beam directions within the space are generally aligned to produce uniformly directed beams of light. → Controlling light.

Disability glare

→ Glare

Discharge lamp

Light source that produces light by exciting gases or metal vapours. The qualities of the lamp depend on the contents of the discharge tube and the operating pressure of the lamp. A distinction is therefore made between high-pressure and low-pressure discharge lamps. Low-pressure discharge lamps have a larger lamp volume and correspondingly low lamp luminances. The light emitted comprises only narrow spectral ranges, which to a large extent restricts colour rendition characteristic. Colour rendering can be improved substantially by adding luminous substances. High-pressure discharge lamps have a small lamp volume and have correspondingly high luminance values. The high operating pressure leads to the broadening of the spectral ranges produced, which in turn leads to improved → colour rendition. Increasing the lamp pressure frequently also means an increase in luminous efficacy

Discomfort glare

→ Glare

Distribution characteristics

→ luminous intensity distribution curve

Double focus reflector

→ Reflector

EB

Abbreviation for electronic → ballast

Elliptical reflector

→ Reflector

Emitter

Material that facilitates the transfer of electrons to be converted from the electrodes into the discharge column of the lamp. To allow ignition to occur the electrodes in a large number of discharge lamps are coated with a special emitter material (usually barium oxide)

Exposure

Represented by the symbol H (lx.h)

Exposure is defined as the product of the illuminance and the exposure time through which a surface is illuminated

Eye

The eye consists of an optical system, comprising the cornea and the deformable lens which enable images of the environment to be reproduced on the retina. By adjusting the size of the aperture of the pupil the iris roughly controls the amount of incident light. The pattern of luminances on the retina is translated into nervous impulses by receptor cells. There are two kinds of receptor in the eye: the rods and the cones. The rods are distributed fairly evenly over the retina, they are extremely sensitive to light and allow wide-angled vision at low illuminances (→ scotopic vision). Visual acuity is poor, however, and colours are not perceived. The cones are concentrated in the central area around the fovea, which is located on the axis of sight. They allow colours and sharper contours to be seen in a narrow angle of vision, but require high illuminances (→ photopic vision)

Filter

Optically effective element with selective → transmission. Only a part of the radiation falling on a surface is transmitted, so that either coloured light is produced or invisible portions of radiation (→ ultraviolet, → infrared) are eliminated. Filter effects can be achieved by means of selective → absorption or → interference. Interference filters allow an especially clear division of the light that is transmitted and that which is eliminated by the filters

Flood

Usual term used for wide-beam → reflectors or → reflector lamps

Fluorescence

Fluorescence is a process by which substances are excited by means of radiation and made to produce light. The wavelength of the light emitted is always greater than the wavelength of the radiation used to excite the substances. Fluorescence is used in technical applications for → luminous substances that convert → ultraviolet radiation into visible light

Fluorescent lamp

Low-pressure → discharge lamp filled with mercury vapour. The ultraviolet radiation produced during the mercury discharge process is converted into visible light by the luminous substances on the inner wall of the discharge tube. By using different luminous substances it is possible to produce a variety of luminous colours and different colour rendering qualities. As a rule, fluorescent lamps have heated electrodes and can therefore be ignited at comparatively low voltages. Fluorescent lamps require an ignitor and a ballast, → EB

Focal glow

Focal glow refers to accent lighting. Light is used deliberately to convey information by visually accentuating significant areas and allowing insignificant areas to remain in the background

Fovea

→ Eye

Fresnel lens

Stepped lens, where the effect of a considerably thicker lens is achieved by a flat arrangement of lens segments. Optical disturbance caused by the edges of the prisms is usually corrected by producing a grained finish on the rear side of the lens. Fresnel lenses are primarily used in stage projectors and spotlights with adjustable → beam spreads

Functional requirements (Lam: activity needs)

The functional requirements a lighting concept is expected to meet are dictated by the visual tasks which are to be performed; the aim is to create optimum perceptual conditions for all activities to be performed in a specific area

Gas light

An early form of lighting using a bare gas flame to produce light

General lighting

Uniform lighting of an entire space without taking specific visual tasks into account. → Ambient lighting

General service lamp

→ Incandescent lamp

Gestalt (form) perception

Theory of perception that presumes that perceived structures are regarded as a gestalt, i.e. as complete forms, and not synthesized as individual elements. Each gestalt is classified according to a specific law of gestalt and separated from its environment

Glare

Generic term describing the depreciation of → visual performance or the disturbance felt by perceivers through excessive → luminance levels or → luminance contrasts in a visual environment. A distinction is made between disability glare, which does not depend on luminance contrast, and contrast-related relative glare. Furthermore, a distinction is made between disability glare (physiological glare), by which there is an objective depreciation of visual performance, and discomfort glare, which involves a subjective disturbance factor arising from the incongruity of luminance and information content of the area perceived. In all cases glare can be caused by the light source itself (direct glare) or through the reflection of the light source (reflected glare)

Gobo

Term used in stage lighting to describe a mask or template, which can be projected onto the set using a projector

Goniophotometer

→ Photometer

Halogen lamp

Compact incandescent lamp with additional halides in the gas compound, which prevents deposits of the evaporated filament material forming on the outer envelope. In contrast to general service lamps, halogen lamps have increased luminous efficacy and a longer service life

High-pressure discharge lamps

→ Discharge lamps

High-pressure mercury lamp

High-pressure → discharge lamp containing mercury vapour. In contrast to the low-pressure discharge process, which produces almost exclusively → ultraviolet radiation, at high pressure mercury vapour produces visible light with a low red content. Luminous substances can be added to complement the red content and improve → colour rendering. High-pressure mercury lamps require → ballasts, but no → ignitors

High-pressure sodium lamp

High-pressure discharge lamp containing sodium vapour. As aggressive sodium vapour can destroy glass at high pressures, the internal discharge tube is made of alumina ceramic and surrounded by an additional outer envelope. In contrast to → low-pressure sodium lamps colour rendition is considerably improved, but at the expense of luminous efficacy. The luminous colour is in the warm white range. High-pressure sodium lamps require → ignitors and → ballasts

High-voltage fluorescent tubes

→ Fluorescent lamps similar to low-pressure → discharge lamps, which work with unheated electrodes and accordingly require high voltages. The discharge tubes can be extremely long and have a variety of forms. They are used primarily for luminous advertising and for theatrical effect. They are filled with neon or argon gas and contain luminous substances, which can produce a large number of luminous colours. High-voltage fluorescent tubes require an → ignitor and a → ballast

Ignition aid

Equipment to facilitate ignition, e.g. in the case of → fluorescent lamps with unheated electrodes, usually an auxiliary electrode or an external ignitor system

Ignitor

→ Control gear which promotes the ignition of → discharge lamps by producing high-voltage peaks. Leakage transformers, ignition transformers, ignition pulsers and electronic ignitors can be used as ignitors

Illuminance

Represented by the symbol E (lx)
Illuminance is defined as the ratio of the amount of luminous flux falling on a surface to the area of the surface

Incandescent gas light

Form of lighting whereby an incandescent mantle coated with rare earths, originally using other solid bodies (e.g. limestone, limelight) is excited to thermoluminescence using a gas flame. The luminous efficacy is far greater and the light produced of a shorter wavelength than is the case with pure → gas light

Incandescent lamp

→ Thermal radiator, where light is produced by the heating of a wire filament (usually tungsten). The filament is contained in an outer envelope made of glass and filled with a special gas (nitrogen or inert gas) to prevent the filament from oxidizing and to slow down the vaporisation of the filament material. There are various types of incandescent lamps available: the main group comprises general purpose lamps with drop-shaped, clear or frosted outer envelopes, the reflector lamp with a variety of internal mirrors, and the PAR lamp made of pressed glass with an integral parabolic reflector

Inductive circuits

Circuit in which a non-compensated discharge lamp can be operated on an inductive → ballast (CCB, → LLB). In this case the power factor of the installation is below unity

Infrared radiation

Invisible long-wave radiation (thermal radiation, wavelength >780 nm). Infrared radiation is produced by all light sources, especially thermal radiators, where it is the major component of the emitted radiation. At high illuminance levels infrared radiation can lead to unacceptable thermal loads and damage to materials

Interference

Physical phenomenon which occurs when asynchronous waves are superimposed, which results in the selective attenuation of wavelength ranges. Interference is used in → filters and → reflectors for selective → transmission or → reflection

Interference filters

→ Filters

Inverse square law

Law that describes the → illuminance as the function of the distance from the light source. The illuminance decreases with the square of the distance

Involute reflector

→ Reflector

Isoluminance diagram

Diagram to illustrate luminance distribution, in which lines representing values of luminance are indicated on a reference plane

Isolux diagram

Diagram to illustrate illuminance distribution, in which lines representing values of illuminance are indicated on a reference plane

Lambertian radiator

Completely diffuse light source, whose → luminous intensity distribution (with regard to the cosine law) is the shape of a sphere or a circle

LDC

Abbreviation for → light distribution curve

Leading edge dimming

Method of controlling the brightness, in which the power to the lamps is controlled by cutting out the leading edge of waves of alternating current

Lead-lag circuit

Wiring of an inductive → fluorescent lamp in parallel with an over-compensated fluorescent lamp. The power factor of the overall circuit is effectively unity. Since both lamps are out-of-phase, there is less fluctuation of luminous intensity

Light control

The control of light using reflectors or lenses is used to develop luminaires with clearly defined optical qualities as instruments for effective lighting design. Different luminaire types allow lighting effects ranging from uniform lighting to the accentuation of specific areas to the projection of light patterns. Light control is extremely significant for → visual comfort. With the aid of light control the → luminance that can give rise to glare in the critical beam area can be reduced to an acceptable level

Light fastness

Is an indication of the degree by which a material will be damaged by the effect of light. Light fastness applies primarily to changes in the colour of the material (colour fastness), but may also apply to the material itself

Light loss factor

Factor (usually 0.8), which is included in illuminance calculations, e.g. when using the utilisation factor method, to take into account the reduction in performance of a lighting installation due to the ageing of the lamps and the deterioration of the light output from the luminaires

Light output ratio

→ Luminaire light output ratio

Lighting control

Lighting control allows the lighting of a space to be adjusted to meet changing uses and environmental conditions. A light scene is created for each different use, i.e. a specific pattern of switching and dimming for each circuit. The light scene can be stored electronically and recalled at the touch of button

Line spectrum

→ Spectrum

LitG

→ Abbreviation for Lichttechnische Gesellschaft e.V. (German Lighting Engineering Society)

LLB

→ Abbreviation for low-loss → ballast

Louvred luminaire

Standard term used to describe rectangular luminaires designed for linear fluorescent lamps (modular luminaires), frequently equipped with specular, prismatic or anti-dazzle louvres

Low-pressure discharge lamp

→ Discharge lamp

Low-pressure sodium lamp

Low-pressure discharge lamp containing sodium vapour. The internal discharge tube is surrounded by an outer envelope that reflects infrared radiation to increase the lamp temperature. Low-pressure sodium lamps have excellent luminous efficacy. As they emit monochromatic, yellow light, it is not possible to recognise colours under the lighting provided by these lamps. Low-pressure sodium lamps require → ignitors and → ballasts

Low-voltage halogen lamp

Extremely compact → tungsten halogen lamps operated on low voltage (usually 6, 12, 24 V). Frequently also available with metal reflectors or → coolbeam reflectors

Lumen, lm

→ Luminous flux

Luminaire classification

System for the classification of luminaire qualities according to the luminous intensity distribution curve. In the classification of the luminous intensity of a luminaire through the allocation of a letter and digits, the letter indicates the luminaire category, i.e. defines whether a luminaire emits light upwards or downwards. The first digit after that describes the portion of direct luminous flux falling on the working plane in the lower half of the room, and the second digit indicates the corresponding value for the upper half of the room

Luminaire efficiency

Luminaire light output ratio

Luminaire light output ratio

Ratio of the luminous flux emitted by a luminaire to the luminous flux of the lamp. The luminaire light output ratio is related to the actual lamp lumens in the luminaire

Luminance

Represented by the symbol L (cd/m^2)
Luminance describes the brightness of a luminous surface which either emits light through autoluminance (as a light source), → transmission or → reflection. The luminance is accordingly defined as the ratio of → luminous intensity to the area on a plane at right angles to the direction of beam

Luminance limiting curve

→ Luminance limiting method

Luminance limiting method

Method for evaluating the potential glare of a luminaire. The luminance of the luminaire with different beam spreads is entered in a diagram, in which the luminance curve must not exceed the luminance limit for the required glare limitation classification

Luminescence

General term for all luminous phenomena that are not produced by thermal radiators (photoluminescence, chemoluminescence, bioluminescence, electroluminescence, cathodoluminescence, thermal luminescence, triboluminescence)

Luminous colour

The colour of the light emitted by a lamp. The luminous colour can be identified by x, y coordinates as chromacity coordinates in the → standard colorimetric system, in the case of white luminous colours also as a colour temperature T_f . White luminous colours are roughly divided up into warm white (ww), neutral white (nw) and daylight white (dw). The same luminous colours may have different spectral distributions and correspondingly different → colour rendering

Luminous efficacy

Luminous efficacy describes the luminous flux of a lamp in relation to its power consumption, (lm/W)

Luminous flux

Represented by the symbol Φ (lm)
Luminous flux describes the total amount of light emitted by a light source. It is calculated from the spectral radiant power by the evaluation with the spectral sensitivity of the eye $V(\lambda)$

Luminous intensity

Represented by the symbol I (cd)
Luminous intensity is the amount of luminous flux radiating in a given direction (lm/sr). It describes the spatial distribution of the luminous flux

Luminous intensity distribution curve

The luminous intensity distribution curve, or light distribution curve, is the section through the three-dimensional graph which represents the distribution of the luminous intensity of a light source throughout a space. In the case of rotationally symmetrical light sources only one light distribution curve is required. Axially symmetrical light sources require two or more curves. The light distribution curve is generally given in the form of a polar coordinate diagram standardised to a luminous flux of 1000 lm. The polar coordinate diagram is not sufficiently accurate for narrow-beam luminaires, e.g. projectors. In this case it is usual to provide a Cartesian coordinate system

Lux, lx

→ Illuminance

Maintenance factor

Reciprocal value of the → light loss factor

Mesopic vision

Transitional stage between → photopic vision, i.e. daylight vision with the aid of → cones and scotopic vision, i.e. night vision with the aid of → rods. Colour perception and visual acuity have corresponding interim values. Mesopic vision covers the luminance range of 3 cd/m² to 0.01 cd/m²

Metal halide lamp

→ High-pressure discharge lamp where the envelope is filled with metal halides. In contrast to pure metals, halogen compounds melt at a considerably lower temperature. This means that metals that do not produce metal vapour when the lamp is in operation can also be used. The availability of a large variety of source materials means that metal vapour compounds can be produced which in turn produce high luminous efficacy during the discharge process, and good colour rendering

Mode of Protection

Classification of luminaires with regard to the degree of protection provided against physical contact and the ingress of foreign bodies or water

Modelling

Accentuation of three-dimensional forms and surface structures through direct light from point light sources. Can be explained by the term → shadow formation

Modular luminaires

General term used to describe rectangular luminaires designed to take tubular fluorescent lamps. As → louvred luminaires frequently equipped with specular, prismatic or anti-dazzle louvres

Monochromatic light

Light of one colour with a very narrow spectral range. Visual acuity increases under monochromatic light due to the fact that chromatic → aberration does not arise. Colour rendition is not possible

Multi-mirror

→ Coolbeam reflector

Neutral white, nw

→ Luminous colour

Night vision

→ Scotopic vision

Optical fibres, fibre optic system

Optical instrument for conveying light to required positions, including around corners and bends. Light is transported from one end of the light guide to the other by means of total internal reflection. Light guides are made of glass or plastic and may be solid core or hollow fibres

PAR lamp

→ Incandescent lamp

Parabolic reflector

→ Reflector

Perceptual physiology

Field of science concerning the biological aspects of perception, especially the way the brain receives and processes sense stimuli

Perceptual psychology

Field of science concerning the mental and intellectual aspects of perception, especially the way received sense stimuli are processed

Permanent supplementary artificial lighting, PSALI

Additional artificial lighting, especially in deep office spaces with a row of windows along one side of the space only. Permanent supplementary artificial lighting balances the steep drop in illuminance in parts of the space furthest away from the windows and contributes towards avoiding → glare by reducing the luminance contrast between the windows and the surrounding space

Photometer

Instrument for measuring photometric quantities. The primary quantity measured is → illuminance, from which other photometric quantities are derived. Photometers are adjusted to the spectral sensitivity of the eye ($V(\lambda)$ adjustment). Special, large-dimensioned photometric equipment (goniophotometers) is required for measuring the light distribution of luminaires. Measurement is carried out by moving the measuring device around the luminaire (spiral photometer) or by directing the luminous flux onto a stationary measuring device via an adjustable mirror

Photometric distance of tolerance

Minimum distance above which the influence of the size of the lamp or luminaire on the validity of the inverse square law can be ignored. The photometric distance of tolerance must be at least ten times the maximum diameter of the lamp or luminaire; in the case of optical systems the photometric distance of tolerance is established by experimentation

Photopic vision

(Daylight vision). Vision with → adaptation to luminances of over 3 cd/m^2 . Photometric vision occurs through the → cones and is therefore concentrated on the area around the → fovea. → Visual acuity is good. Colours can be perceived

Planckian radiator

(Black body). Ideal thermal radiator whose radiation properties are described in the Planck's Law

Play of brilliance

Play of brilliance is the decorative application of light. Specular effects produced by light source and illuminated materials – from the candle flame to the chandelier to the light sculpture – contribute towards creating a prestigious, festive or exciting atmosphere

Point illuminance

In contrast to average illuminance, which expresses the average level of illuminance in a space, point illuminance describes the exact level of illuminance at a specific point in the space

Point light source

Term used to describe compact, practically point-sized light source emitting direct light. Point light sources allow optimum control of the light, especially the bundling of light, whereas linear or flat light sources produce diffuse light, which increases with size

Power factor

→ Compensation

Prismatic louvre

Element used for controlling light in luminaires or for controlling daylight using refraction and total internal reflection in prismatic elements

Protection class

Classification of luminaires with regard to the rate of protection provided against electric shock

Reflected ceiling plan

The view of a ceiling plan from above, provided to show the type and arrangement of the luminaires and equipment to be installed

Reflected glare

→ Glare

Reflection

Ability of materials to redirect light. The degree of reflection is expressed in the reflection factor (reflecting coefficient). It indicates the ratio of the reflected luminous flux to the luminous flux falling on a surface

Reflector

System for controlling light based on reflecting surfaces. The characteristics of a reflector are primarily the reflecting and diffusing qualities, and in the case of mirror reflectors the contours of the cross section. Parabolic reflectors direct the light from a (point) light source parallel to the axis, spherical reflectors direct the light back to the focal point and elliptical reflectors direct the light radiated by a lamp located at the first focal point of the ellipse to the second focal point

Reflector lamp

→ Incandescent lamp

Refraction

The bending of rays of light as they pass through materials of different density. The refracting power of a medium is defined as the refractive index

Refraction of light

Bending of rays of light as they pass through materials of different density. The refraction of different parts of the spectrum to different degrees gives rise to the formation of colour spectra (prisms).

Re-ignition

The restarting of a lamp after it has been switched off or after current failure. A large number of → discharge lamps can only be re-ignited after a given cooling time. Instant re-ignition is only possible with the aid of special high-voltage → ignitors

Relative glare

→ Glare

Requirements, architectural

The architectural requirements a lighting concept is expected to meet are dictated by the structure of the architecture. The task of the lighting is to reinforce the way the space is divided up, its forms, rhythms and modules, to emphasise architectural features and support the intended atmosphere of the building. The intention of the architectural design can be underlined, and even enhanced, through the arrangement and effects of the luminaires

- Retina**
→ Eye
- Retro-reflection**
Reflection in rectangular reflector systems (triple mirrors) or transparent spheres, by which the light is reflected parallel to the incident light
- Rods**
→ Eye
- Room index**
When calculating → illuminances using the → utilisation factor method, the room index indicates the geometry of the space
- Scallop**
Hyperbolic beam shape of a beam of light. Scallops are produced by grazing wall lighting from downlights
- Scotopic vision**
(Night vision). Vision with → adaptation to luminances of less than 0.01 cd/m². Scotopic vision is effected with the aid of the → rods and comprises the peripheral area of the → retina. → Visual acuity is poor, colours cannot be perceived, sensitivity to the movement of perceived objects is high
- Secondary reflector technology**
Luminaire technology where an indirect or a direct/indirect component is not produced by lighting the room surfaces, but by the use of the luminaire's own secondary reflector. Secondary reflector luminaires frequently have a combination of primary and secondary reflectors, which allows good control of the direct and indirect → luminous flux emitted
- Self ballasted mercury discharge lamp, blended lamp**
→ High-pressure mercury lamp with an additional filament within the outer envelope which is connected in series and takes the form of a current limiter, which results in improved colour rendition. Self ballasted mercury discharge lamps need no → ignitor or → ballast, as the name suggests
- Shadow formation**
Measure for the → modelling quality of a lighting installation. Modelling can be described as the ratio of the average vertical (cylindrical) illuminance to the horizontal → illuminance at a given point in the space
- Solid angle**
Represented by the symbol Ω
Unit for measuring the angular extent of an area. The solid angle is the ratio of the area on a sphere to the square of the sphere's radius
- Spectrum**
Distribution of the radiant power of a light source over all wavelengths. The → spectral distribution gives rise to the → luminous colour and → colour rendering. Depending on the type of light produced, basic types of spectra can differ: the continuous spectrum (daylight and → thermal radiators), the line spectrum (low-pressure discharge) and band spectrum (high-pressure discharge)
- Specular louvres**
→ Reflector
- Spherical aberration**
→ Aberration
- Spherical reflector**
→ Reflector
- Spiral photometer**
→ Photometer
- Spot**
General term used to describe narrow-beam → reflectors or → reflector lamps
- Standard colorimetric system**
System for defining luminous colours and body colours numerically. The standard colorimetric system is presented in a two-dimensional diagram in which the colour loci of all colours and colour blends from their purely saturated state to white are numerically described through their x,y coordinates → chromaticity diagram. Combinations of two colours lie along the straight lines that link the respective colour loci. The luminous colour of thermal radiators is located on the curve of the Planckian radiator
- Starter**
Ignition device for → fluorescent lamps. When the lamp is switched on the lamp the starter closes a preheat circuit, which in turn heats the lamp electrodes. After a specific preheating time the electric circuit is opened, which through induction produces the voltage surge in the → ballast required to ignite the lamp
- Stepped lens**
→ Fresnel lens
- Steradian, sr**
→ Solid angle
- Stroboscopic effects**
Flickering effects or apparent changes in speed of moving objects due to pulsating light (through the supply frequency) up to apparent standstill or a change of direction. Stroboscopic effects can arise in → discharge lamps, predominantly in dimmed fluorescent lamps. They are disturbing and dangerous in spaces where people are operating machines. The effect can be counteracted by operating the lamps out of phase (→ lead-lag circuit, connection to three-phase mains) or on high-frequency electronic → ballasts
- Sun simulator**
→ Daylight simulator
- Sunlight**
→ Daylight
- Surrounding field**
→ Central field of vision

Tandem circuit

Operation of two → fluorescent lamps switched in series on one → ballast

Task lighting

Used generally to describe the illumination of workplaces in accordance with given standards and regulations. Additional lighting of the workplace which goes beyond → general lighting to meet the demands of specific visual tasks

Thermal radiator

Radiant source which emits light through the heating of a material. An ideal → Planckian radiator emits a spectrum pursuant to the Planck's Law; in the case of materials used in practice (e.g. tungsten in wire filaments) the spectrum produced differs slightly from this spectral distribution

Thermoluminescence

→ Luminescence

Transformer

→ Control gear

Transmission

Ability of materials to allow light to pass through them. This ability is expressed as a transmission factor, which is defined as the ratio of transmitted luminous flux to the luminous flux falling on a surface

Tri-phosphor lamp

→ Fluorescent lamp

Ultraviolet radiation

Invisible radiation below short-wave light (wavelength <380 nm). Light sources used for architectural lighting only emit a small portion of ultraviolet radiation. Special light sources designed to produce a higher portion of ultraviolet radiation are used for medical and cosmetic purposes (disinfection, tan effect) and in photochemistry. Ultraviolet radiation can have a damaging effect: colours fade and materials become brittle.

Utilance

Utilance is the ratio of the → luminous flux falling on the working plane to the luminous flux emitted by a luminaire. It is the result of the correlation of room geometry, the reflectance of the room surfaces and the luminaire characteristics

Utilisation factor method

Method for calculating the average → illuminance of spaces with the aid of the → light output ratio, the → utilance and the lamp lumens

VDT-approved luminaire

luminaires designed for application in offices equipped with visual display terminals

Visual acuity

Ability of the eye to perceive details. The unit of measure is the visus, which is defined as the reciprocal value of the size of the smallest detail that can be perceived (usually the position of the opening in the Landolt broken ring) in minutes of arc

Visual comfort

Visual comfort is generally understood as the quality of a lighting installation that meets a number of quality criteria. (→ illuminance, → luminance ratios, → colour rendition, → modelling)

Visual task

Expression for the perceptual performance required of the eye or for the visual qualities of the object to be perceived. The grade of difficulty of a visual task grows with diminishing colour or luminance contrast, and with the diminishing size of details

Warm white, ww

→ Luminous colour

Working plane

Standardised plane to which illuminances and luminances are related, usually 0.85 m in the case of workplaces and 0.2 m in circulation zones

Zoning

Dividing up of the space into different areas relating to their function

Bibliography

5.0 Appendix Bibliography

- Appel, John; MacKenzie, James J.: How Much Light Do We Really Need? Building Systems Design 1975, February, March
- Arnheim, Rudolf: Visual Thinking. University of California, Berkeley 1971
- Bartenbach, Christian: Licht- und Raum- milieu. Technik am Bau 1978, Nr. 8
- Bartenbach, Christian: Neue Tageslicht- konzepte. Technik am Bau 1986, Nr. 4
- Bauer, G.: Strahlungsmessung im opti- schen Spektralbereich. Friedrich Vieweg & Sohn, Braunschweig 1962
- Bedocs, L.; Pinniger, M. J. H.: Development of Integrated Ceiling Systems. Lighting Research and Technology 1975, Vol. 7 No.2
- Beitz, Albert; Hallenbeck, G. H.; Lam, William M.: An Approach to the Design of the Luminous Environment. MIT, Boston 1976
- Bentham, F.: The Art of Stage Lighting. Pitman, London 1969
- Bergmann, Gösta: Lighting the Theatre. Stockholm 1977
- Birren, Faber: Light, Color and Environment. Van Nostrand Reinhold, New York 1969
- Birren, Faber; Logan, Henry L.: The Agreeable Environment. Progressive Architecture 1960, August
- Blackwell, H. R. et al.: Development and Use of a Quantitative Method for Specifica- tion of Interior Illumination Levels on the Basis of Performance Data. Illuminating Engineering 1959, Vol. LIV
- Bodmann, H. W.: Illumination Levels and Visual Performance. International Lighting Review 1962, Vol. 13
- Bodmann, H. W.; Voit, E. A.: Versuche zur Beschreibung der Hellempfindung. Licht- technik 1962, Nr. 14
- Boud, John: Lighting Design in Buildings. Peter Peregrinus Ltd., Stevenage Herts. 1973
- Boud, J.: Shop, Stage, Studio. Light & Light- ing 1966, Vol. 59 No. 11
- Boud, J.: Lighting for Effect. Light & Light- ing 1971, Vol. 64 No. 8
- Bouma, P. J.: Farbe und Farbwahrnehmung. Philips Techn. Bücherei, Eindhoven 1951
- Boyce, Peter R.: Bridging the Gap – Part II. Lighting Design + Application 1987, June
- Boyce, P. C.: Human Factors in Lighting. Applied Science Publishers, London 1981
- Brandston, Howard: Beleuchtung aus der Sicht des Praktikers. Internationale Lich- trundschau 1983, 3
- Breitfuß, W.; Hentschel, H.-J.; Leibig, J.; Pusch, R.: Neue Lichtatmosphäre im Büro – Direkt-Indirektbeleuchtung und ihre Be- wertung. Licht 34, 1982, Heft 6
- Breitfuß, W.; Leibig, J.: Bildschirmarbeits- plätze im richtigen Licht. Data Report 15, 1980
- Brill, Thomas B.: Light. Its Interaction with Art and Antiquity. Plenum, New York 1980
- British Lighting Council: Interior Lighting Design Handbook. 1966
- Buschendorf, Hans Georg: Lexikon Licht- und Beleuchtungstechnik. VDE Verlag Berlin, Offenbach 1989
- Cakir, Ahmet E.: Eine Untersuchung zum Stand der Beleuchtungstechnik in deut- schen Büros. Ergonomic, Institut für Arbeits- und Sozialforschung, Berlin 1990
- Caminada, J. F.: Über architektonische Beleuchtung. Internationale Lichtrund- schau 1984, 4
- Caminada, J. F.; Bommel, W. J. M. van: New Lighting Criteria for Residential Areas. Journal of the Illuminating Engineering Society 1984, July Vol. 13 No. 4
- CIE: International Lighting Vocabulary. Commission Internationale de l'Eclairage, Paris 1970
- CIE: Guide on Interior Lighting. Commis- sion Internationale de l'Eclairage 1975, Publ. No. 29 (TC-4.1)
- CIE: Committee TC-3.1: An Analytic Model for Describing the Influence of Lighting Parameters on Visual Performance. Com- mission Internationale de l'Eclairage, Paris 1981, Publ. No. 19/2.1
- Council for Care of Churches: Lighting and Wiring of Churches. Council for Care of Churches 1961
- Cowan, H. J.: Models in Architecture. American Elsevier, New York 1968
- Danz, Ernst: Sonnenschutz. Hatje, Stuttgart 1967
- Davis, Robert G.: Closing the Gap. Lighting Design + Application 1987, May
- De Boer, J. B.: Glanz in der Beleuchtungs- technik. Lichttechnik 1967, Nr. 28
- De Boer, J. B.: Performance and Comfort in the Presence of Veiling Reflections. Lighting Research and Technology 1977

- De Boer, J. B.; Fischer, D.: Interior Lighting. Philips Technical Library, Antwerp 1981
- Diemer, Helen, K.; Prouse, Robert; Roush, Mark L.; Thompson, Thomas: Four Young Lighting Designers Speak Out. Lighting Design + Application 1986, March
- Egan, David M.: Concepts in Architectural Lighting. McGraw-Hill, New York 1983
- Egger, W.: Kontrastwiedergabefaktor – ein neues Qualitätsmerkmal einer Beleuchtungsanlage? Licht-Forschung 6 1984, Heft 2
- Elmer, W. B.: The Optical Design of Reflectors. Wiley, New York 1979
- Erhardt, Louis: Radiation, Light and Illumination. Camarillo Reproduction Center, Camarillo 1977
- Erhard, Louis: Views on the Visual Environment. A Potpourri of Essays on Lighting Design IES 1985
- Erhard, Louis: Creative Design. Lighting Design + Application 1987, August
- Evans, Benjamin H.: Daylight in Architecture. McGraw-Hill, New York 1981
- Feltman, S.: A Designers Checklist for Merchandise Lighting. Lighting Design + Application 1986, May Vol. 16 No. 5
- Fischer, D.: The European Approach to the Integration of Lighting and Air-Conditioning. Lighting Research and Technology 1970, Vol. 2
- Fischer, Udo: Tageslichttechnik. R. Müller, Köln-Braunsfeld 1982
- Fördergemeinschaft Gutes Licht: Hefte 1–12 div. Titel u. Sachgebiete. Fördergemeinschaft Gutes Licht, Postf. 700969, Frankfurt/M.
- Fördergemeinschaft Gutes Licht: Informationen zur Lichtanwendung. ZVEI, Frankfurt/Main 1975–80
- Frisby, John P.: Sehen. Optische Täuschungen, Gehirnfunktionen, Bildgedächtnis. Heinz Moos, München 1983
- Gibson, James J.: Wahrnehmung und Umwelt. Der ökologische Ansatz in der visuellen Wahrnehmung. Urban & Schwarzenberg, München, Wien, Baltimore 1982
- Gregory, R. L.: Eye and Brain: The Psychology of Seeing. McGraw-Hill, New York 1979
- Gregory, R. L.: Seeing in the Light of Experience. Lighting Research & Technology 1971, Vol. 3 No. 4
- Grenald, Raymond: Perception – The Name of the Game. Lighting Design + Application 1986, July
- Gut, G.: Handbuch der Lichtwerbung. Stuttgart 1974
- Hartmann, Erwin: Optimale Beleuchtung am Arbeitsplatz. Ludwigshafen 1977
- Hartmann, E.; Müller-Limmroth, W.: Stellungnahme zur Verträglichkeit des Leuchtstofflampenlichts. LiTG, Karlsruhe 1981
- Hartmann, E.; Leibig, J.; Roll, K.-F.: Optimale Sehbedingungen am Bildschirmarbeitsplatz I, II, III. Licht 35 1983, Heft 7/8, 9, 10
- Henschel, Hans-Jürgen: Licht und Beleuchtung. Hüthig, Heidelberg 1987
- Henschel, H.-J.; Roll, K.-F.: Die Indirektkomponente der Beleuchtung und optimale Leuchtdichteverhältnisse im Innenraum. Licht 36 1984, Heft 6
- Herzberg, Rose: Beleuchtung und Klima im Museum. Institut für Museumswesen, Bd. 14, Berlin 1979
- Hickish, Gerd: Lichtplanung in Kirchen. Licht 1980, Dezember, Vol. 32 No. 12
- Hilbert, J. S.; Krochmann, J.: Eine neue konservatorische Bewertung der Beleuchtung in Museen. Institut für Museumskunde, Staatliche Museen Preußischer Kulturbesitz, Berlin. Materialien Heft 5, Berlin 1983
- Hochberg, J. E.: Perception. Prentice-Hall, New Jersey 1964
- Hohausen, S.: Architectural and Interior Models. Van Nostrand Reinhold, New York 1970
- Hopkinson, R. G.: Architectural Physics: Lighting. Her Majesty's Stationery Office, London 1963
- Hopkinson, R. G.; Kay, J. D.: The Lighting of Buildings. Faber & Faber, London 1972
- Hopkinson, R. G.; Petherbridge, P.; Longmore, J.: Daylighting. Heinemann, London 1966
- Hopkins, R. G.: A Code of Lighting Quality, A Note on the Use of Indices of Glare Discomfort in Lighting Codes. Building Research Station, Garston, England 1960, April, Note No. E 999
- IES (Kaufman, John E. ed.): Illuminating Engineering Society Lighting Handbook Reference Volume. IES 1981
- IES, (Kaufman, John E. ed.): Illuminating Engineering Society Lighting Handbook Application Volume. IES 1981
- IES (Kaufman, John E. ed.): Lighting Ready Reference. IES 1985
- Institut für Landes- und Stadtentwicklungsforschung des Landes NRW: Licht im Hoch- und Städtebau. Dortmund 1979
- Ishii, Motoko: My Universe of Lights. Libro, Tokyo 1985
- Ishii, Motoko: Motoko Lights. A Selection. Motoko Ishii International Inc.
- James, William: Psychology. Fawcett, New York 1963
- Jankowski, Wanda: The Best of Lighting Design. PBC International (Hearst), New York 1987
- Jay, P. A.: Light and Lighting. 1967
- Kanisza, Gaetono: Organisation in Vision. Essay on Gestalt Perception. Praeger, New York 1979
- Keller, Max: Handbuch der Bühnenbeleuchtung. Köln 1985
- Kellogg-Smith, Fran; Bertolone, Fred J.: Bringing Interiors to Light. The Principles and Practices of Lighting Design. Whitney Library of Design, Watson-Guptill Publications, New York 1986
- Köhler, Walter: Lichttechnik. Helios, Berlin 1952
- Köhler, Walter; Wassili, Luckhardt: Lichtarchitektur. Berlin 1955
- Krochmann, Jürgen: Zur Frage der Beleuchtung von Museen. Lichttechnik 1978, Nr. 2
- Krochmann, J.; Kirschbaum C. F.: Gerät zur Ermittlung der ergonomisch notwendigen Beleuchtung am Arbeitsplatz. Forschungsbericht Nr. 355. Wirtschaftsverlag NW, Bremerhaven 1983
- Lam, William M. C.: Perception and Lighting as Formgivers for Architecture. McGraw Hill, New York 1977
- Lam, William M. C.: Sunlighting as Form-giver for Architecture. Van Nostrand Reinhold, New York 1986
- Lam, William M. C.; Beitz, Albert; Hallenbeck, G. H.: An Approach to the Design of the Luminous Environment. MIT, Boston 1976
- Lamb, C.: Die Wies, das Meisterwerk von Dominikus Zimmermann. Berlin 1937
- Lemons, T. M.; MacLeod, R. B. Jr.: Scale Models Used in Lighting Systems Design and Evaluation. Lighting Design + Application 1972, February

- LiTG: Beleuchtung in Verbindung mit Klima und Schalltechnik. Karlsruhe 1980
- LiTG: Projektierung von Beleuchtungsanlagen für Innenräume. Berlin 1988
- McCandless, Stanley: A Method of Lighting the Stage. Theatre Arts Books, New York 1973
- Metcalf, Keyes D.: Library Lighting. Associates of Research Libraries, Washington DC 1970
- Metzger, Wolfgang: Gesetze des Sehens. Waldemar Kramer, Frankfurt/M. 1975
- Moon, Parry; Eberle Spencer, Domina: Lighting Design. Addison-Wesley, Cambridge, Mass. 1948
- Moore, Fuller: Concepts and Practice of Architectural Daylighting. Van Nostrand Reinhold, New York 1985
- Murdoch, Joseph B.: Illuminating Engineering. Macmillan, New York 1985
- Ne'eman, E.; Isaacs, R. L.; Collins, J. B.: The Lighting of Compact Plan Hospitals. Transactions of the Illuminating Engineering Society 1966, Vol. 31 No. 2
- Nuckolls, James L.: Interior Lighting for Environmental Designers. John Wiley & Sons, New York 1976
- Olgay, V.; Olgay, A.: Solar Control and Shading Devices. Princeton University Press, Princeton 1963
- O'Dea, W. T.: The Social History of Lighting. Routledge and Kegan Paul, London 1958
- Pelbrow, Richard: Stage Lighting. Van Nostrand Reinhold, New York 1970
- Philips: Lighting Manual. 3rd Edition. Philips, Eindhoven 1981
- Philips: Correspondence Course Lighting Application. Bisher 12 Hefte. Philips, Eindhoven 1984 f.
- Plummer, Henry: Poetics of Light. Architecture and Urbanism 1987, December, vol. 12
- Pritchard, D. C.: Lighting. Longman, London 1978
- Rebske, Ernst: Lampen, Laternen, Leuchten. Eine Historie der Beleuchtung. Franck, Stuttgart 1962
- Reeb, O.: Grundlagen der Photometrie. G. Braun, Karlsruhe 1962
- Riege, Joachim: Handbuch der lichttechnischen Literatur. TU, Institut für Lichttechnik, Berlin 1967
- Ritter, Manfred (Einf.): Wahrnehmung und visuelles System. Spektrum der Wissenschaft, Heidelberg 1986
- Robbins, Claude L.: Daylighting. Design and Analysis. Van Nostrand Reinhold, New York 1986
- Rock, Irvin: Wahrnehmung. Vom visuellen Reiz zum Sehen und Erkennen. Spektrum der Wissenschaft, Heidelberg 1985
- Rodman, H. E.: Models in Architectural Education and Practice. Lighting Design + Application 1973, June
- SLG; LTAG; LiTG: Handbuch für Beleuchtung. W. Giradet, Essen 1975
- Santen, Christa van; Hansen, A. J.: Licht in de Architectuur – een beschouwing vor dag- en kunstlicht. de Bussy, Amsterdam 1985
- Santen, Christa van; Hansen A. J.: Zichtbarmaaken van schaduwpatroonen. Visuelle communicatie in het bouwproces. Faculteit der bouwkunde, Delft 1989
- Schivelbusch, Wolfgang: Lichtblicke. Zur Geschichte der künstlichen Helligkeit im 19. Jhd. Hanser, München 1983
- Schober, H.: Das Sehen. VEB Fachbuchverlag, Leipzig 1970 Bd. I, 1964 Bd. II
- Schober, H; Rentschler, I.: Das Bild als Schein der Wirklichkeit. Optische Täuschungen in Wissenschaft und Kunst. Moos, München 1972
- Sewig, Rudolf: Handbuch der Lichttechnik. Würzburg 1938, 2 Bände
- Sieverts, E.: Bürohaus- und Verwaltungsbau. W. Kohlhammer GmbH, Stuttgart, Berlin, Köln, Mainz 1980
- Sieverts, E.: Beleuchtung und Raumgestaltung. In: Beleuchtung am Arbeitsplatz, BAU Tb49. Wirtschaftsverlag NW, Bremerhaven 1988
- Söllner, G.: Ein einfaches System zur Blendungsbewertung. Lichttechnik 1965, Nr. 17
- Sorcar, Parfulla C.: Rapid Lighting Design and Cost Estimating. McGraw-Hill, New York 1979
- Sorcar, Praefulla C.: Energy Saving Light Systems. Van Nostrand Reinhold, New York 1982
- Spieser, Robert: Handbuch für Beleuchtung. Zentrale für Lichtwirtschaft, Zürich 1950
- Steffy, Gary: Lighting for Architecture and People. Lighting Design + Application 1986, July
- Sturm, C. H.: Vorschaltgeräte und Schaltungen für Niederspannungs-Entladungslampen. BBC, Mannheim, Essen
- Taylor, J.: Model Building for Architects and Engineers. McGraw-Hill, New York 1971
- Teichmüller, Joachim: Moderne Lichttechnik in Wissenschaft und Praxis. Union, Berlin 1928
- Teichmüller, Joachim: Lichtarchitektur. Licht und Lampe, Union 1927, Heft 13, 14
- Twarowski, Mieczyslaw: Sonne und Architektur. Callwey, München 1962
- Wahl, Karl: Lichttechnik. Fachbuchverlag, Leipzig 1954
- Waldram, J. M.: The Lighting of Gloucester Cathedral by the „Designed Appearance“ Method. Transactions of the Illuminating Engineering Society 1959, Vol. 24 No. 2
- Waldram, J. M.: A Review of Lighting Progress. Lighting Research & Technology 1972, Vol. 4 No. 3
- Walsh, J. W. T.: Photometry. Dover Publications Inc., New York 1965
- Weigel, R.: Grundzüge der Lichttechnik. Giradet, Essen 1952
- Weis, B.: Notbeleuchtung. Pflaum, München 1985
- Welter, Hans: Sportstättenbeleuchtung, Empfehlungen für die Projektierung und Messung der Beleuchtung. Lichttechnik 1974, März, Vol. 26 No. 3
- Wilson, Forrest: How we create. Lighting Design + Application 1987, February
- Yonemura, G. T.: Criteria for Recommending Lighting Levels. U.S. National Bureau of Standards 1981, March 81-2231
- Yonemura, G. T.; Kohayakawa, Y.: A New Look at the Research Basis for Lighting Level Recommendations. US Government Printing Office, NBS Building Science Series 82, Washington, D.C. 1976
- Zekowski, Gerry: Wie man die Augen eines Designers erwirbt. Internationale Licht-rundschau 1983, 3
- Zekowski, Gerry: Why I am an Perceptionist. Lighting Design + Application 1987, August
- Zekowski, Gerry: How to Grab a Footcandle. Lighting Design + Application 1986, June
- Zekowski, Gerry: Beleuchtung – Kunst und Wissenschaft. Internationale Licht-rundschau 1982, 1

- Zekowski, Gerry: The Art of Lighting is a Science/The Science of Lighting is an Art. Lighting Design + Application 1981, March
- Zekowski, Gerry: Undeification of the Calculation. Lighting Design + Application 1984, Februar
- Zieseniß, Carl Heinz: Beleuchtungstechnik für den Elektrofachmann. Hüthig, Heidelberg 1985
- Zijl, H.: Leitfaden der Lichttechnik. Philips Technische Bibliothek Reihe B, Bd. 10, Eindhoven 1955
- Zimmer, R. (Hrsg.): Technik Wörterbuch Lichttechnik (8-spr.). VEB Verlag Technik, Berlin 1977
- Standards, anonymous articles
- A Special Issue on Hotel Lighting. International Lighting Review 1963, Vol. 14 No. 6
- A Special Issue on Museum and Art Gallery Lighting. International Lighting Review 1964, Vol. 15 No. 5-6
- A Special Issue on Shop and Display Lighting. International Lighting Review 1969, Vol. 20 No. 2
- Arbeitsstättenrichtlinien ASR 7/3, (6/79)
- Besseres Licht im Büro. Licht 1985, Februar, Vol. 37 No. 1
- DIN 5034 Teil 1 (2/83), Tageslicht in Innenräumen, Allgemeine Anforderungen
- DIN 5035 Teil 1 (6/90), Beleuchtung mit künstlichem Licht; Begriffe und allgemeine Anforderungen
- DIN 5035 Teil 2 (9/90), Beleuchtung mit künstlichem Licht; Richtwerte für Arbeitsstätten in Innenräumen und im Freien
- DIN 5035 Teil 7 (9/88), Innenraumbeleuchtung mit künstlichem Licht; Spezielle Empfehlungen für die Beleuchtung von Räumen mit Bildschirmarbeitsplätzen und mit Arbeitsplätzen mit Bildschirmunterstützung
- DIN 66234 Teil 7 (12/84), Bildschirmarbeitsplätze, Ergonomische Gestaltung des Arbeitsraums; Beleuchtung und Anordnung
- Lichtarchitektur. Daidalos 1988, März, Heft 27
- Lighting Technology Terminology. BS 4727, 1972
- Lighting Up the CRT Screen – Problems and Solutions. Lighting Design + Application 1984, February

Acknowledgements

Graphic material

- Archiv für Kunst und Geschichte
17 Shop window lighting using gas light
- CAT Software GmbH
165 Illuminance distribution
165 Luminance distribution
- Daidalos 27. Lichtarchitektur. March 1988
23 Wassili Luckhardt: Crystal on the sphere
23 Van Nelle tobacco factory, Rotterdam
- Deutsches Museum, Munich
20 Goebel lamps
- ERCO
24 Ambient light
25 Focal glow
25 Play of brilliance
- Institut für Landes- und Stadtentwicklungsforschung des Landes Nordrhein-Westfalen ILS (Hrsg.): Licht im Hoch- und Städtebau. Band 3.021. S. 17. Dortmund 1980
13 The influence of light on northern and southern architectural forms
- Addison Kelly
116 Richard Kelly
- William M. C. Lam: Sunlighting as Formgiver for Architecture. New York (Van Nostrand Reinhold) 1986
117 William Lam
- Osram photo archives
20 Heinrich Goebel
- Correspondence Course Lighting Application. Vol. 2. History of Light and Lighting. Eindhoven 1984
13 Brass oil lamp
15 Christiaan Huygens
15 Isaac Newton
17 Carl Auer v. Welsbach
18 Jablochhoff arc lamps
20 Joseph Wilson Swan
20 Thomas Alva Edison
21 Theatre foyer lit by Moore lamps
23 Joachim Teichmüller
- Henry Plummer: Poetics of Light. In: Architecture and Urbanism. 12. 1987
12 Sunlight architecture
- Michael Raeburn (Hrsg.): Baukunst des Abendlandes. Eine kulturhistorische Dokumentation über 2500 Jahre Architektur. Stuttgart 1982
12 Daylight architecture
- Ernst Rebske: Lampen, Laternen, Leuchten. Eine Historie der Beleuchtung. Stuttgart (Franck) 1962
16 Lighthouse lighting using Fresnel lenses and Argand burners
17 Drummond's limelight
19 Siemens arc lamp, 1868
20 Swan lamp
- Wolfgang Schivelbusch: Lichtblicke. Zur Geschichte der künstlichen Helligkeit im 19. Jhd. München (Hanser) 1983
18 Arc lighting at the Place de la Concorde
22 American lighthouse
- Trilux: Lichter und Leuchter. Entwicklungsgeschichte eines alten Kulturgutes. Arnsherg 1987
14 Lamps and burners developed in the 2. half of the 19. century
15 Paraffin lamp with Argand burner
16 Fresnel lenses and Argand burner
17 Incandescent mantle as invented by Auer v. Welsbach
18 Hugo Bremer's arc lamp
20 Edison lamps
21 Low-pressure mercury vapour lamp developed Cooper-Hewitt
- Ullstein Bilderdienst
16 Augustin Jean Fresnel
- Sigrid Wechsler-Kümmel: Schöne Lampen, Leuchter und Laternen. Heidelberg, München 1962
13 Greek oil lamp

Index

Index

- Aberration 28, 57
- Absolute glare 79
- Absorption 87
- Accent lighting 53, 123, 126, 132, 136
- Accommodation 80
- Activity needs 112, 117, 118
- Adaptation 13, 38, 84
- Ambient light 24, 116
- Anodisation 88
- Architectural requirements 74, 119, 122

- Ballast 52, 54–60, 61, 65–68, 71
- Batwing characteristics 89, 98
- Beam spread 41, 47, 77, 85, 91, 92, 98, 102
- Biological needs 74, 117, 118, 122
- Brilliance 47, 53, 78–80, 97, 114, 117, 126, 127

- Candela, cd 41, 79, 99
- Capacitive circuit 67
- CB 65
- Chromaticity coordinates 83
- Chromatic aberration 44, 57
- CIE 83
- Colour adaptation 84
- Colour temperature 47, 52, 54, 71, 78, 83, 84, 127, 128
- Colour rendition 22, 47, 49, 52, 54, 57–60, 83, 84, 111, 119, 126–128, 130
- Compact fluorescent lamp 25, 54, 55, 66, 72, 97, 102
- Compensation 67, 71
- Cones 37
- Constancy 31
- Contrast 39, 73, 79, 144
- Contrast rendering 81, 154, 158, 168
- Control gear 49, 65, 67, 85, 126
- Convergence 80
- Coolbeam reflector 47, 50, 88
- Cove reflector 89
- Cove 141
- Cut-off angle (lamp) 89, 94
- Cut-off angle (luminaire) 94, 99

- Darklight reflector 90, 94
- Daylight 12, 15, 23, 31, 38, 47, 74, 76, 84, 122, 132, 150, 167, 168
- Daylight factor 167
- Daylight white 54, 60, 128
- Dichroic reflector 47, 49, 88
- Dichroic filters 88, 92
- Diffuse light 13, 53, 76, 85, 87, 88
- Dimmer 71, 73
- Direct glare 79–81, 98, 111, 137, 141, 143
- Direct field of vision 114
- Directed light 25, 76–78, 127, 137
- Disability glare 79
- Discharge lamp 21, 25, 43, 52, 53, 55, 60, 65, 68, 72, 83, 90, 101, 127, 128, 130, 132, 143
- Discomfort glare 79, 80
- Double-focus reflector 95

- EB 65, 66
- Ellipsoidal reflector 90
- Emitter 53
- Exposure 24, 42
- Eye 12, 24, 28, 29, 37, 38, 43, 57, 75, 79, 83, 84, 112, 114, 115

- Filter 53, 65, 87, 88, 92, 132
- Fluorescence 53
- Fluorescent lamp 21, 22, 25, 43, 53–55, 59, 65–67, 71, 72, 89, 92, 96, 97, 101–103, 127, 128, 130, 132, 136, 138
- Focal glow 24, 116
- Fovea 37

- Fresnel lens 16, 91, 92, 102
- Gas light 17, 20, 43
 General service lamp 127
 General lighting 13, 22, 24, 78, 99, 101, 102, 104, 127, 136–139, 141
 Gestalt perception 33, 34, 147
 Glare 12, 22, 39, 74, 79, 80, 89, 90, 99, 105, 114, 143
 Gobo 73, 92, 102, 144
- High-pressure fluorescent lamp 21, 55, 56, 66, 73, 123
 High-pressure mercury lamp 57, 127, 128, 130
 High-voltage fluorescent tubes 21, 55, 56, 66, 73, 123
- Ignition aid 54, 59, 71, 72
 Ignitor 58, 59, 61, 65–67
 Illuminance 15, 22–24, 31, 37, 39, 42, 71, 73–78, 84, 110, 112, 113, 115, 116, 119, 126, 128, 130, 138, 150, 154, 155, 157, 158, 168, 169
 Illuminance at a point 154, 158
 Incandescent gas light 18
 Incandescent lamp 21, 25, 43, 45, 47, 49, 50, 52–55, 58, 65, 71, 83, 96, 101, 102, 103, 104, 127, 128, 130, 132, 138, 157, 158, 169
 Inductive circuit 65–67, 71, 72
 Infrared radiation 88, 92, 132, 143
 Interference 87
 Inverse square law 42, 158
 Involute reflector 90
 Isoluminance diagram 158
 Isolux diagram 158, 160
- Lead-lag circuit 67
 Light output ratio 85, 94, 98, 155, 157, 158, 169
 Light control 15, 16, 85, 87, 90, 92, 98, 127
 Light loss factor 157, 169
 Light output ratio 154, 155, 157, 158
 Lighting control 25, 73, 126, 135, 136, 144, 150
 Line spectrum 52
 LiTG 155
 LLB 65
 Louvred luminaire 55, 80, 97–100, 104, 135–138, 143, 144, 147, 152, 153, 157
 Low-pressure sodium vapour lamp 56, 57, 66, 128
 Low-voltage halogen lamp 49, 127, 128, 130
 Lumen, lm 40, 41, 130, 158
 Luminaire classification 143
 Luminaire efficiency 154, 155, 157, 158
 Luminance limiting method 81
 Luminance 31, 37–39, 75, 76, 79, 80, 99, 112–114, 143, 160
 Luminescence 17, 18
 Luminous efficacy 17, 18, 21, 22, 40, 45, 47, 49, 52, 54–56, 58–60, 65, 128, 130, 132, 157
 Luminous colour 18, 32, 33, 45, 49, 52–54, 56–58, 60, 71, 73, 78, 83, 84, 88, 110, 119, 122, 126–128, 143, 144, 150, 169
 Luminous intensity 22, 37, 103, 119, 128
 Luminous intensity distribution 41
 Luminous flux 40, 105, 128
 Lux, lx 37, 74, 75, 84, 111, 114, 157
- Mesopic vision 37
 Metal halide lamp 43, 59, 103, 105, 127, 128, 130
 Mode of Protection 143
 Modelling 77, 78, 97, 114, 126, 127, 137, 138, 144
 Modular luminaire 97
- Neutral white 54, 60, 128
 Night vision 37
- Optical fibre 105
- Parabolic reflector 89, 90
 Perceptual psychology 24, 29, 113
 Phase angle control 71
 Photopic vision 37

- Planckian radiator 83
- Play of brilliance 24, 116
- Point light source 53, 91, 116
- Power factor 67
- Prismatic louvre 91, 92, 97, 98
- Protection class 143

- Reflected ceiling plan 160
- Reflected glare 79–81, 98, 105, 111, 119, 137, 138, 143, 147
- Reflection 12, 78, 85, 113, 127, 138
- Reflector 16, 47, 50, 80, 85, 87, 88, 91, 98, 102, 127, 132, 169
- Reflector lamp 58–60, 85, 102, 127
- Refraction 78, 87
- Refraction of light 92, 127
- Re-ignition 54, 56, 57, 59–61, 67
- Relative glare 79
- Retina 28–33, 37, 75, 76, 79, 113, 114
- Rods 37
- Room index 157

- Scallop 94, 139
- Scotopic vision 37
- Secondary reflector technology 105, 136–138
- Self ballasted mercury discharge lamp 58, 59, 65
- Shadow formation (modelling) 78, 110, 154, 158, 168
- Spherical reflector 90
- Spherical aberration 28
- Standard colorimetric system 83
- Starter 54, 55, 65, 66
- Steradian 41
- Stroboscopic effects 65, 67
- Sun simulator 167
- Sunlight 12, 13, 23, 31, 33, 37, 43, 76, 78, 89, 122, 150
- Surround field 79, 112, 114, 136

- Tandem circuit 67
- Task lighting 22, 75, 78, 80, 110, 111, 114, 128, 136, 138, 143
- Thermal radiator 43, 45, 84
- Transformer 49, 65, 67–69, 71
- Transmission 85
- Halogen lamp 25, 43, 45, 49, 50, 71, 96, 101–104, 127, 128, 130, 132, 169

- Ultraviolet radiation 45, 53, 54, 56, 87, 88, 92, 102, 132, 143
- Utilance 155, 157

- VDT-approved 99, 105
- Visual task 22, 24, 39, 72, 74, 75, 78–81, 84, 111, 112, 115, 117–119, 137–139, 141
- Visual comfort 87, 105, 138
- Visual acuity 37, 57

- Warm white 49, 54, 60, 128
- Working plane 110, 138, 154, 155, 158, 168

- Zoning 112