

STEFAN HAGEL

Ancient Greek Music

A New Technical History

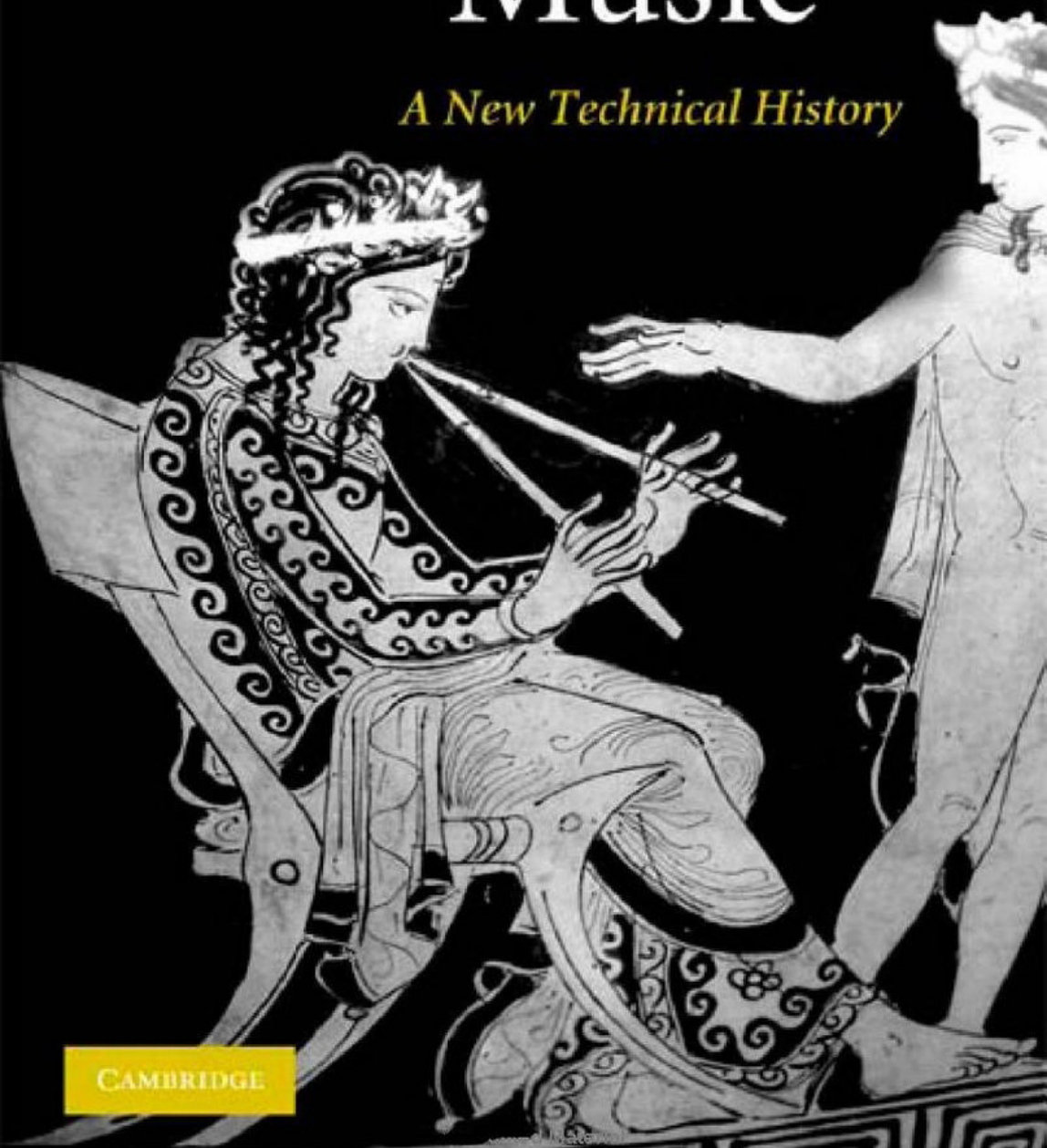

CAMBRIDGE

ANCIENT GREEK MUSIC

A NEW TECHNICAL HISTORY

This book endeavours to pinpoint the relations between musical, and especially instrumental, practice and the evolving conceptions of pitch systems. It traces the development of ancient melodic notation from reconstructed origins, through various adaptations necessitated by changing musical styles and newly invented instruments, to its final canonical form. It thus emerges how closely ancient harmonic theory depended on the culturally dominant instruments, the lyre and the aulos. These threads are followed down to late antiquity, when details recorded by Ptolemy permit an exceptionally clear perspective on the harmonic relations underlying the extant melody fragments. Dr Hagel discusses the textual and pictorial evidence, introducing mathematical approaches wherever feasible, but also contributes to the interpretation of instruments in the archaeological record and occasionally is able to outline the general features of instruments not directly attested. The book will be indispensable to all those interested in Greek music, technology and performance culture and the general history of musicology.

STEFAN HAGEL holds a research post at the Commission for Ancient Literature of the Austrian Academy of Sciences. His interests focus on ancient Greek music and metre, including reconstruction of instruments and performance techniques. He also creates dedicated software for scholarly purposes and his *Classical Text Editor* received the European Academic Software Award.

ANCIENT GREEK MUSIC
A NEW TECHNICAL HISTORY

STEFAN HAGEL

Austrian Academy of Sciences



CAMBRIDGE
UNIVERSITY PRESS

CAMBRIDGE UNIVERSITY PRESS

Cambridge, New York, Melbourne, Madrid, Cape Town, Singapore, São Paulo, Delhi, Dubai, Tokyo

Cambridge University Press
The Edinburgh Building, Cambridge CB2 8RU, UK

Published in the United States of America by Cambridge University Press, New York

www.cambridge.org

Information on this title: www.cambridge.org/9780521517645

© Stefan Hagel 2009

This publication is in copyright. Subject to statutory exception
and to the provisions of relevant collective licensing agreements,
no reproduction of any part may take place without
the written permission of Cambridge University Press.

First published 2010

Printed in the United Kingdom at the University Press, Cambridge

A catalogue record for this publication is available from the British Library

ISBN 978-0-521-51764-5 hardback

ἐπὶ κούδει σοῦ πατρός καὶ κάρτεϊ σῶ μάκαρ
πάλιν ὕμνοπολεύσω πάλι σοι μέλος ἄσω
τάχα καὶ κιθάραν πάλιν πανακήρατον ἀρμόσω.

(Synes., *Hymn* 7)

Contents

<i>List of diagrams</i>	page x
<i>List of tables</i>	xiii
<i>List of figures</i>	xiii
<i>List of abbreviations</i>	xiv
<i>Preface</i>	xv
1 The evolution of ancient Greek musical notation	1
The notation	1
The problem: Dorian marginalised	9
The evidence of the developed notation	10
Towards a diachronic approach	16
The origins of the notation	20
The introduction of <i>tónoi</i>	26
Vocal notation	29
A common top note	34
Notation in <i>tónoi</i>	38
The Mixolydian <i>tónos</i>	41
The chromatic system	44
Chromatic strokes	51
2 Notation, instruments and the voice	53
Bellermann's Second Anonymus	53
Ptolemy	56
Pollux	61
Porphyry	61
Musical practice	65
Absolute pitch	68
Vocal range	71
Lyre range	76
Ptolemy's <i>lyra</i>	77
Constructing a history of strings: Boethius and Nicomachus	80
Lyre physics	88
Conclusion	92

	Notating the cithara tunings	95
3	Notation in the handbooks	97
	Gaudentius, Alypius, Bacchius, Bellermann's Anonymi	97
	Boethius	98
4	Strings and notes	103
	Note names by 'thesis' and 'dynamis'	103
	Ptolemy	106
	The question of <i>mésē</i>	117
	The <i>hormasia</i>	122
	How to tune a lyre	133
5	Fine tuning	135
	General considerations	135
	Systematic restrictions	138
	'Philolaus'	143
	Aristoxenus and the auletic viewpoint	151
	'Pythagorean' orthodoxy	158
	Thrasyllus	159
	Nicomachus, 'Timaeus Locrus' and Boethius	160
	Minor Sources	166
	Superparticularity	169
	Archytas	171
	Eratosthenes	182
	Didymus	187
	Ptolemy	194
6	Going beyond Ptolemy?	217
	The soft diatonic and tense chromatic semitones	217
	Modality	219
	Focal notes	219
	Intervallic structure	229
	Lydian	230
	Hypolydian	245
	Hyperian	246
	Iastian	249
7	Assisted resonance	251
	The resonators described by Vitruvius	251
	Interpretation of the resonators	252
8	The extant musical documents	256
	Individual scores	256
	Conclusions	325

Contents

ix

9	Aulos types and pitches	327
	Earlier auloi and their iconography	328
	The <i>proslambanómenos</i> aulos	332
	The Hellenistic 'tónoi aulos'	343
	Roman Imperial auloi	351
	Transformation into the Roman Imperial system	361
	The <i>hýdraulis</i>	364
10	Before Aristoxenus	366
	Early notation	366
	The signs	366
	The general approach	368
	Harmonic theory	371
	Dating the Aristides scales?	390
	Early auloi	393
	The 'enharmonic' intervals	413
	Lost 'modes'	429
	Pentatonic precursors?	435
11	Synthesis	442
	Historical overview	442
	Transcribing ancient notation	452
 <i>Bibliography</i>		
	Editions quoted by page numbers	454
	Modern works	455
 <i>Indices</i>		
	Ancient passages cited	472
	Manuscripts	482
	Inscriptions	482
	Musical documents	482
	Personal names	483

Diagrams

1 The ‘Unmodulating System’ (<i>systema ametábolon</i>)	6
2 The fully developed notation system	13
3 The <i>tónoi</i> forming the circle of fifths	15
4 The ancient scales described by Aristides Quintilianus	18
5 The three-scale stage of the notation	24
6 The shift of the ‘natural’ scale to Hypolydian	29
7 The invention of the vocal notation	31
8 The notation of Aristides’ ancient scales	33
9 The Aristides scales set to their respective <i>tónoi</i>	36
10 The tonal material of Limenios’ paean	40
11 The system of seven <i>tónoi</i>	42
12 Chromatic Mixolydian notated	46
13 The notational system as consisting of an enharmonic and a chromatic half	48
14 Keys used in different periods and by different instruments (Anon. Bell. 2, § 28)	54
15 Possible connections between cithara tunings	60
16 Porphyry’s construction of Ptolemy’s tunings	62
17 Porphyry’s reference to tetrachords	64
18 Percentage of notes in musical documents as included in Ptolemy’s tunings	67
19 Mean pitch of the musical documents	69
20 Theoretical voice and lyre ranges and the distribution of extant notes	72
21 Note ranges associated with <i>tónoi</i> groups	75
22 Pitch ranges compared	93
23 Anon. Bell. § 64 as referring to the Lydian	94
24 Ptolemy’s cithara tunings notated	96
25 Purported ancient lyre tunings behind the note names	104
26 Addressing notes by cithara string (Ptol., <i>Harm.</i> 2.1)	109
27 Modulation by <i>kbrōmatiké</i>	111
28 Origin of the concepts of fixed and moving notes	114
29 Heptatonic tunings ‘by consonance’ on a lyre with ‘Dorian <i>néte</i> ’	115
30 <i>Koiné hormasta</i> , left column, as a tuning instruction	125
31 <i>Koiné hormasta</i> , left column, as a tonal structure	127
32 <i>Koiné hormasta</i> , right column	130
33 ‘Pythagorean’ diatonic and chromatic as a consequence of modulation	139
34 A possible interpretation of ps.-Plut., <i>Mus.</i> 1145d	142

35 Philolaus' tetrachord tunings according to Burkert / West	147
36 Aristoxenus' tetrachord divisions	153
37 'Ditonic', 'sweetened' and $\frac{3}{4}$ -tone enharmonic	155
38 Producing Aristoxenus' shades on a $\frac{3}{4}$ - $\frac{3}{4}$ -1 tones aulos	157
39 The division of the universal soul	162
40 Boethius' tetrachord divisions	165
41 The symmetry of the Pythagorean Perfect System (<i>Anecd. Stud.</i> , 4–7)	168
42 Archytas' tetrachord divisions	171
43 Aristoxenus' 'Archytan' divisions	172
44 Archytas' whole-tone chromatic	179
45 Eratosthenes' tetrachord divisions	183
46 Ptolemy's canon lengths for Aristoxenus' 'tense diatonic'	184
47 Didymus' tetrachord divisions	189
48 Bridge positions for Didymus' central octave	191
49 The epicentric symmetry inherent in Didymus' canon	193
50 Determinative factors in Ptolemy's cithara tunings	196
51 Ptol., <i>Harm.</i> 2.1, p.42.10–43.8	207
52 Ptol., <i>Harm.</i> 2.1, p.43.9–18	209
53 Ptolemy's tense diatonic	212
54 Ptol., <i>Harm.</i> 2.1, p.44.13–45.10	213
55 Ptol., <i>Harm.</i> 2.1, p.45.11–22	214
56 Possible harmonic-series-generated focal notes in Ptolemy's tunings	224
57 Relative frequency of individual notes before and after Ptolemy	225
58 Possible focal notes and observed note frequency AD 0–150	227
59 Evolution of Lydian note frequency	228
60 Pattern codes for intervals	230
61 Intervals in Lydian melodies AD 0–150	231
62 Harmonic structure of Lydian melodies AD 0–150	232
63 Ptolemy's instrumental and vocal <i>lydia</i>	241
64 A possible interpretation of Ptolemy's vocal <i>lydia</i>	242
65 Note frequency and repetition frequency in Lydian melodies AD 0–150	244
66 Intervals in AD Hypolydian melodies	246
67 Intervals in Hyperian melodies AD 0–150	247
68 Intervals in Hyperian melodies after AD 150	248
69 Intervals in Iastian melodies AD 0–150	249
70 Location of resonators in a large theatre (Vitruv. 5.5)	252
71 Theatre resonators vs. notes in the musical documents	253
72 Theatre resonators vs. notes, within functional octave	254
73 Melodic context of \flat	316
74 Overblowing to <i>nētē</i> and <i>hyperbolātai</i> on the Louvre aulos	321
75 <i>DAGM</i> N ^o 61 and the Berlin aulos	323
76 Pitch of iconographic aulos tubes (male players)	328
77 Pitches of iconographic aulos fingering (male players)	331

78	Finger spans for <i>DAGM</i> № 61 in Lydian pitch	339
79	Playing <i>DAGM</i> № 61.4 one-handed?	340
80	Playing <i>DAGM</i> № 61 on the Berlin aulos?	342
81	Highest playing range of a <i>tónoi</i> aulos	345
82	<i>DAGM</i> № 15 and the Conze model	348
83	The notes of the Pompeii pipes	352
84	Melodic context of $\mathbf{A} \setminus$ in extant melodies AD	353
85	Keys playable on the Pompeii pipes	355
86	The Pompeii auloi and the Berlin Papyrus	357
87	Main playing position on the Hellenistic <i>tónoi</i> aulos	362
88	The supposed range of the Aquincum organ	365
89	The Aristides scales written with early note signs	370
90	The Mixolydian disjunction	372
91	<i>Exempli gratia</i> reconstruction of a full Eratoclean diagram	377
92	The two old <i>tónoi</i> systems	380
93	Notating the 'first' <i>tónoi</i> system	386
94	Enharmonic octave species generating the Perfect System	388
95	Hypothetical single-mode aulos layouts for the Aristides scales	394
96	Hypothetical single-mode aulos measurements for the Aristides scales	395
97	Two consecutive ditones in the <i>spondeion</i> scale	401
98	Notes of <i>spondeion</i> music and the 'ancient' Dorian aulos	408
99	The hypothetical <i>spondeion</i> accompanying pipe and the Reading pipe	412
100	Proportions of moving notes in the fragments (Greater Perfect System)	439
101	The primordial <i>diesis</i>	444

Tables

1 Concordance of <i>tónoi</i> systems	8
2 The late Hellenistic revolution in <i>tónos</i> employment	50
3 Ptolemy's tunings	58
4 The <i>koinḗ hormasia</i> translated	124
5 Superparticulars in Archytas' divisions	181
6 Errors in Ptolemy's representation of Aristoxenus' shades	185
7 Harmonic context of Lydian <i>paramésē</i>	236
8 The loss of the Lydian <i>hypátē-paramésē</i> fifth	237
9 Lydian note repetitions AD 0–150	245
10 Textual and musical difficulties in Pap. Zenon 59533	273
11 Lydian and Phrygian <i>mésē</i> in <i>DAGM</i> N ^o 9	274
12 Top notes of musical documents BC and AD	344

Figures

1 The 40° Lyre	79
2 The <i>koinḗ hormasia</i> (Codex Palatinus 281, fol. 173r)	123

Abbreviations

- AGM* M.L. West, *Ancient Greek Music*. Oxford 1992.
- Anecd. Stud.* *Anecdota varia Graeca musica metrica grammatica*. Ed. G. Studemund, Berlin 1886.
- CIL* *Corpus Inscriptionum Latinarum*. Berlin 1862–2003.
- DAGM* E. Pöhlmann/M. L. West, *Documents of Ancient Greek Music*. Oxford 2001.
- DAM* E. Pöhlmann, *Denkmäler Altgriechischer Musik*. Nuremberg 1970.
- FdD* III *Fouilles de Delphes*, III: *Épigraphie*. Paris 1909–85.
- GMW* I A. Barker, *Greek Musical Writings* I. *The Musician and his Art*. Cambridge 1984.
- GMW* II A. Barker, *Greek Musical Writings* II. *Harmonic and Acoustic Theory*. Cambridge 1989.
- KAR* E. Ebeling, *Keilschrifttexte aus Assur religiösen Inhalts* I/II. *Wissenschaftliche Veröffentlichungen der Deutschen Orient-Gesellschaft* 28 (1919); 34 (1923).
- LSJ* H.G. Liddell/R. Scott, *A Greek-English Lexicon*. 9th edn with revised supplement, Oxford 1996.
- MSL* 16 *Materials for the Sumerian Dictionary* 16. The Series SIG⁷.ALAN = *Nabnītu*. Ed. I. L. Finkel with collab. of M. Civil. Rome 1982.

Preface

But *Lydia* is in Dorian. There are serious puzzles here...

(A. Barker, *GMW* II: 360)

Originality is something which we often meet in our studies of Greek music, but only too frequently it is associated with bad scholarship and freakish judgment.

(R. P. Winnington-Ingram 1958: 244)

The serious puzzles mentioned by Andrew Barker do not concern some remote niche of ancient musical studies; they have partly obscured the significance of what can rightly be called the most practical chapter of ancient music that has come down to us. This may seem perplexing after centuries of almost unbroken interest in the topic, during which many eminent scholars have devoted their genius to elucidating its more difficult aspects. The other faction, that one referred to by R. P. Winnington-Ingram, can only partly be blamed for this: those who have been considering ancient music the convenient playground for original ideas of their own, a field reasonably secure from the danger of refutation by new facts. Admittedly, some unfounded opinions, uttered enthusiastically long ago, still ripple the surface of scholarly discourse; but sober judgement now dominates it.

Even so, how can one hope to add something worthwhile to a discussion that has been based on the ever-same pieces of evidence for such a long time?

Several pitfalls are to be avoided. The most important is that of finding a possible explanation for some aspect of the evidence, and subsequently forcing the rest of it to compliance, or where this proves wholly impossible, disregarding it. We must be especially careful to acknowledge the complexity of a musical culture synchronically and diachronically, its richness in different aspects (cf. Solomon 1984: 242–4). Therefore, this book does not claim to present some new key that unlocks the doors to all secrets. Instead, it keeps very much to the paths that have been opened by previous research,

while trying to fit some previously unconnected pieces together, and in some respects suggesting (I hope) a more coherent view.

Secondly, classical music archaeology and archaeomusicology extend into fields that are usually covered by different experts: philology and archaeology, music history and ethnomusicology, all play their distinctive roles. Few researchers are at home in all of these (the present author is certainly not), so there is considerable danger of neglecting those with which one is less familiar. Sadly, one witnesses the forming of scholarly traditions largely unconnected to each other: even nowadays works on ancient music are published that take no account even of the most essential contributions by scholars of other departmental denomination; of course there are also language barriers.

Furthermore, the discourse about ancient music has often been overshadowed by an evolutionary model that would be unacceptable in ethnomusicology: the assumption that Greek music evolved from 'primitive' origins to high complexity. This approach does not become truer because it was already adopted by the Greeks themselves, who hypothesised first inventors for almost everything, thus also deducing contemporary music from supposed simplistic instruments and musical styles by gradual additions. Few of these speculations rested on evidence of any kind, and it is of the essence to consider the nature of possible channels by which genuine information about earlier music could reach the first writers of antiquarian interest at all: relics of old styles in mostly cultic context, iconography, and passages in literary works, not a few of which must have been almost as arcane to the fourth century BC as they are to us. Only from one passage, seemingly from Aristoxenus' pen, does the principle transpire which underlies serious ethnomusicological research nowadays: that according to well-applied information-theoretical standards, all musical cultures should be considered as, more or less, on an equal footing, even if complexity is achieved within different aspects (cf. e.g. Brandl 2005: 11; of course considerable variance must be allowed in relation to the amount of time that individuals spend on acquiring and exercising musical skills.):

εἴ τις καὶ περὶ τῆς ποικιλίας ὀρθῶς τε καὶ ἐμπείρως ἐπισκοποίη, τὰ τότε καὶ τὰ νῦν συγκρίνων, εὗροι ἂν ἐν χρήσει οὔσαν καὶ τότε τὴν ποικιλίαν.

(ps.-Plut., *Mus.* 1138b)

If one undertook a straight and experienced investigation of complexity, comparing former times with nowadays, they would find that complexity was also part of former practice.

This is not to imply that there was no evolution, of course; much of the present book deals with processes of transformation. But what are the 'origins' for students of Greek music were certainly not primitive, nor were they origins in any real sense – in this context the chapter on 'Progress' in Sachs (1962: 210–22) is still recommended.

There are a few issues of methodology, which are crucial for many of the conclusions presented here, and which deserve a word beforehand. Above all, I have found it essential to be acquainted with the principal instruments of classical antiquity in a very material way. Most of what I have to say on lyres and auloi is also based on practical experience with building and especially playing those instruments in various forms.

Secondly, I have employed computer techniques wherever feasible, designing special software to approach specific questions whenever necessary. In some cases this naturally led to the application of testing statistics. This kind of inference, although the basis of many sciences, is still often suspected in classical studies. Here is therefore a short guide on how to deal with significance levels. If they are well below 5 per cent it is not a good idea to resort to a strategy of "I cannot do such calculations; hence I do not believe what they say". Instead, one should accept that there is some significance in the counted or measured facts, i.e. that very, very probably, some causal connection exists between the quantified facts. But it is also not a good idea to accept an author's conclusions solely because there are figures. What is significant there might be something other than the author thinks; the numerical tendencies might result from just another mechanism than that considered (an often cited example: the statistically valid correlation between an increase of the number of TV sets and of the average life span in many countries during the last decades does not imply that watching TV will preserve you from an untimely death). But when no such alternative explanation can be found, it is a good idea after all not to reject the author's conclusions rashly.

The nature of the argument prohibited a nicely systematic arrangement of the chapters. I found it preferable, for instance, to start with the evaluation of mainly the internal evidence of ancient musical notation, even if some of the conclusions that can be reached in this way must be qualified later. In this way, I hope, the reader will find it easier to assess the plausibility of the single points; a purely chronological treatment would inevitably obscure the argument. It is also not the intention of this book to provide a general introduction to its topics for the entirely uninitiated; fortunately there are other works that serve this purpose, which must be consulted by

anyone concerned with our subject anyway, and to which I therefore often refer; above all Martin L. West's *Ancient Greek Music* and Andrew Barker's *Greek Musical Writings*.

The reader will encounter an abundance of graphical diagrams, which I hope illuminate the point made more clearly than would many paragraphs. Regarding their interpretation, suffice it to say that if pitch is involved, it ascends either from left to right, or from bottom to top, in accordance with modern Western intuition. Where modern note names refer to absolute pitch and where they merely indicate relative pitch relations will become clear from the context. In the latter case, solmisation syllables would be preferable from a methodological viewpoint; but in many countries scholars are not generally familiar with them, and when it comes to sharps and flats their systematic advantage is practically lost, too.

For the rendition of ancient melody fragments, I have abstained from stave notation, whose visual focus on thirds obscures the inherent structures, which divide the octave mostly into fourths and fifths. Instead, melodic motion is printed in lines undulating within a grid of semitones, reflecting as much of the pitch relations as we can read from the ancient notation. Note onsets are marked by circles.

Most Greek and Latin passages are translated, except where their meaning is sufficiently explained in the text and additional information can be gained only from reading the original wording. The transcription of Greek words takes vowel length and accents into regard (oxytones, however, are rendered with an acute, dismissing the sentence-internal graphical variant of the grave), but renders υ as 'u' solely within diphthongs; elsewhere the traditional 'y' is employed. In a work on music especially, hard-core spellings such as 'hyperlúdios' side by side with 'Hyperlydian' etc. may easily appear merely hyper-ludicrous. Even so, the transcription is unambiguous, whereas the duplicate rendition of 'u' reflects its differentiated pronunciation from classical Attic onwards.

My thanks go out to many kind people who took part in the long process that finally led to the publication of this book. A lot of them I would not have met, were it not for the International Study Group for Music Archaeology, founded and inspired by Ellen Hickmann. There I encountered that amalgamation of scholarly debate, good company, and music-making that made the ISGMA meetings so unique for many: John Curtis Franklin, in many hours of discussion, opened my eyes to important aspects I was in the danger of overlooking; Stelios Psaroudakēs was always extremely generous in sharing his data and expertise, and also in accepting my pipes as an ac-

companiment to his voice; of Eleonora Rocconi's kindness no mention need be made to those lucky enough to know her. Dahlia Shehata proved superbly helpful in Assyriological matters, patiently enduring my ignorance. Graeme Lawson cannot go unmentioned either, his Anglo-Saxon thumb setting standards for everybody concerned with ancient lyres.

On various occasions I had the opportunity to discuss special points with other outstanding experts in the field. My thanks are especially due to Andrew Barker, Egert Pöhlmann and Martin L. West. At the same time, I want to express my gratitude to the anonymous reviewers. One of them provided me with fifteen pages of invaluable advice; for the few instances where it did not overcome my obstinacy I must take full responsibility.

My research was only made possible by the lasting support of the Austrian Academy of Sciences (partly by its APART programme), and Christine Harrauer's pleasant matronage in the Commission for Ancient Literature. As one of its members, Cornelia Römer provided extremely welcome help especially in, but not restricted to, papyrological matters.

Without Scott Wallace and his workshop I would hardly have embarked on building a cithara; to his expertise with strings, wood, ivory and virtually everything one would like to exchange opinions about (he has also edited some of my English), combined with admirable patience in teaching the clumsy, I owe very much. When the Cambridge University Press kindly accepted this book for publication, the task of eliminating its stylistic atrocities was assumed by Linda Woodward, who made the process of being copy-edited a wholly enjoyable experience.

Often discussions with colleagues who are specialising in entirely different fields are of the highest value: among others I thank especially Hildegund Müller for her vivid interest in remote topics also; Birgitta Eder kindly shared her profound knowledge of Hellenic culture in and after the Mycenaean age. Johannes Divjak's competent helpfulness in computer issues relieved me of some of the burdens of the philologist's daily life.

Georg Danek has been accompanying my musical studies from the start; without his encouragement this new field of research would not have established itself in Vienna.

CHAPTER 1

The evolution of ancient Greek musical notation

By the middle of the third century BC, from which the first preserved documents of ancient Greek written music date,¹ musical notation was already firmly established; it had acquired much of the inner structure that emerges from the full account given in Alypius' handbook, compiled perhaps half a millennium later. Thus we are not in a position to directly observe the evolution of this system out of more primitive precursors; its origins are the object of speculation. Although some work has been done on this subject, there are several details for which no adequate explanation has been proposed so far. In the following chapter a new theory of the original conception and early evolution of ancient notation will be derived mainly from internal structural evidence. In accord with the nature of such an approach, this initial argument evolves on rather abstract lines. This might seem hardly appropriate for a musical subject, but it allows the development of a consistent view from a very limited body of evidence. It will be left to the later chapters to embed the conclusions, sometimes with modifications, into a broader, more practical and historical, picture.

THE NOTATION

Greek notation was based on letters or letter-like signs, each one designating a certain functional position within a network of musical scales. It is one of the more complex aspects of the system that this functional position cannot be determined unambiguously from any sign in question, but must be derived by reference to the musical context, i.e. from the general tonality of a given piece. Moreover, the exact pitch of a sign depended not only on

¹ For the contexts in which notation was used, cf. e.g. Pöhlmann 1976; 1986; 2005; Prauscello 2006.

positioning the scalar network within the frequency continuum (for instance by means of a ‘concert pitch’ as in the tuning of modern instruments and orchestras),² but in many cases also on the ‘genus’ and fine tuning, for which the scores provide no information.

The signs of the system come in two complete sets, which are associated with vocal and instrumental music respectively, although the extant scores do not maintain the distinction throughout.³ But the instrumental notation is obviously the older one, so it is very likely that it was originally used for vocal melodies also.⁴ Both sets employ letter-like signs. But while the vocal notation consists simply of the letters of the Ionian alphabet in their canonical order, duplicated in slightly modified form outside the central region of the system, the identification of the instrumental signs has raised difficulties. Speculations about an origin in a Semitic alphabet have been rightly rejected.⁵ Certain Greek local scripts seemed more promising; but although many identifications of signs with letters can be made plausible, others remain problematic. Above all, no meaningful series emerges. Neither are the supposed letters arranged in alphabetic order, nor does their order make any musical sense (by expressing intervallic relations, for instance), nor can they be accounted for as abbreviations for degrees of the scale,⁶ nor as meaningful numbers. So the series of instrumental note signs remains a riddle yet to be solved.

In the developed state in which we know it, the system combines two ideas: that of the regular model scale (*syntēma*), and that of keys (*tónoi* or *trópoi*), which merge into a comprehensive description of the tonal space of Greek music. The model scale is an abstract set of notes defined within a

² For arguments for the system being more or less fixed in pitch see *AGM*: 273–6; the topic is discussed in more detail below, pp. 68 ff.

³ Cf. e.g. Aristid. Quint. 1.11, p. 23.18–22; Gaud. 21, p. 350.9–11. The instrumentalist Limenios used ‘instrumental’ notation for his paean (*DAGM* № 21). Barker (1995: 48–9) argues that one major motive for developing an alternative vocal notation was probably the need to distinguish vocal and instrumental ‘parts’ within one score.

⁴ Cf. *AGM*: 263. — Throughout this book I use ‘notation’ without article for the practice of notating music and its appearance in documents; where I talk about ‘the notation’, a specific system (generally the ancient one) is meant.

⁵ Cf. West 1992a: 37, against Husmann 1957: 57–8, and Husmann 1961: 78–80.

⁶ Identification with letters from the Argive local script was favoured by West 1992a: 38–41; *AGM*: 260–3. When it comes to interpreting the series, however, West admits that “likely their meanings will remain forever hidden” (1992a: 42). The Indic and Western medieval heptatonic note names cited by him can hardly serve as parallels: can we assume that in the fifth century there existed some nomenclature for no fewer than a dozen degrees of the scale (involving, by lucky coincidence, no two or three terms with the same initial letter), which left no single trace in later treatises? On top of this, the series of notational signs did not even denote a ‘scale’ in a practical sense, as will become clear below.

skeleton of fixed intervals, against which the note material of any actual musical piece can be matched. It comes in the form of the so-called Greater Perfect System, which comprises two octaves, with the ‘middle’ note, *mésē*, at the centre. Keys, on the other hand, regulate the pitch distances between single instantiations of that scale. Changing from one key to another involves modulation. As soon as an entire set of keys comes to be regarded as more or less fixed within the frequency continuum, they can also be used for transposing a melody to a different pitch range. Although both ideas, that of the model scale and that of the key, seem inseparably entwined in the notational system, they had evolved quite independently of each other. The arrangement of *tónoi* originated in the practice of modulation,⁷ whereas the Perfect System was probably conceived somewhat later in the context of aulos making.⁸ Subsequently the regular scales could readily be imposed on an already established system of pitch relations; this was apparently not done before Aristoxenus. The work of this outstanding theoretician is, no doubt, the major landmark on the way to the fully regularised scheme, although his own ‘multi-key diagram’ (*diágramma polytropon*) did not yet display the entire Perfect System for each key.⁹

The notation in its evolved form relies on the Aristoxenian system in many respects; Aristoxenus himself, however, rather despised musical notation as contributing nothing to the understanding of the art.¹⁰ From his words it becomes clear that not all of his colleagues thought in similar ways; and we will see that the architects of the notation were always at the forefront of the musical science of their time. Still we must bear in mind that the whole process of finding a proper definition of the tonal material of ancient Greek music was perfectly possible without resort to notation. It was not until late antiquity that the note signs found their way into handbooks on music of Aristoxenian hue; writers with philosophical pretensions such as Ptolemy would not use note signs even then. And indeed in many cases the unequivocal note names were preferable over the signs, ambiguous as these were in respect both to pitch and to musical function.

⁷ Hagel 2000: 165–90.

⁸ Hagel 2005a. Aristoxenus could already refer to the tetrachords of the Perfect System as recognised entities (*Harm.* 2.40, p. 50.4–7; cf. also ps.-Plut., *Mus.* 1137d). For the aulos’ significant role in, and the story of its rejection from music theoretical discourse, cf. Wilson 1999 (with emphasis on the paradoxes associated with the instruments’ new negative image in mid-fifth century Athens); Wallace 2003. There were cities more fond of this instrument than Athens; but even there, according to Aristotle, “practically the majority of the free men” embraced its art in the earlier fifth century (*Pol.* 1341a).

⁹ Cf. Hagel 2000: 183–8. The *diágramma polytropon* is mentioned in Adrastus *ap.* Theon, *Util. math.* 64.1–4; Procl., *in Tim.* 35b, 2.170.7–12; Vitruv. 5.5,6; cf. also Plut., *De cobib. ira* 453d.

¹⁰ Aristox., *Harm.* 2.39–41, p. 49–51.

There are twelve semitones to the octave: accordingly, twelve scales arranged at semitone steps seem sufficient to account for all possible notes and tonal relations. Aristoxenus, however, devised a system of thirteen *tónoi*, so that the highest replicated the lowest at the octave. Thus the completeness of the cycle became immediately visible from the diagram; at any rate the octave must be associated with thirteen notes separated by semitones in exactly the same way as it is with eight notes of a heptatonic scale (whence its English name). Moreover, Aristoxenian theory defined a kind of ‘modulation to a scale an octave apart’,¹¹ which could be exemplified only if two such scales existed in the diagram. Such a modulation seems a nonsensical conception for those accustomed to treating notes an octave apart as functionally completely interchangeable; but this is not the way the Greeks felt about it.

In the final stage of the notation, another two keys were added to Aristoxenus’ thirteen, so that there were now not one but three pairs of scales that merely extended each other to a total range of three octaves. Perhaps this expansion was caused by musical needs, but more likely it was conceived out of purely aesthetic motives.¹² The resulting fifteen keys were renamed to form five triads, each of which associated a basic scale with neighbouring ‘Hypo-’ and ‘Hyper-’ scales one fourth below and above respectively.¹³ The relation of ‘Hyper-’ keys was apparently invented in analogy to the ‘Hypo-’ scales, which looked back on a respectable history: ‘Hypophrygian’ and ‘Hypodorian’ were already parts of pre-Aristoxenian systems,¹⁴ while ‘Hypolydian’ is Aristoxenian at the latest.¹⁵ Three triads retained the old designations as ‘Dorian’, ‘Phrygian’ and ‘Lydian’; for the remaining two, which had no comparable roots in traditional musical practice, names had to be invented. To supplement the set of ethnic designations, the old names ‘Iastian/Ionian’ and ‘Aeolian’ were adopted, which had once stood for musical styles now forgotten.¹⁶

¹¹ Cleonid. 13, p. 205.10–11.

¹² For note signs in practical use, but not part of the *tónos* system, cf. Aristid. Quint. 1.11, p. 2.4–7 together with *DAGM* N^o 41 (cf. below, pp. 300ff.): the notation could be expanded independently of the scale system.

¹³ The motivation is expressed by Aristid. Quint. 1.10, p. 2.11–4: ... ὁπως γ’ ἂν ἕκαστος βαρύτητα τε ἔχοι καὶ μεσότητα καὶ ὀξύτητα “that each participates in low, central, and high pitch”.

¹⁴ Aristox., *Harm.* 2.37, p. 47.1–13.

¹⁵ Cf. Hagel 2000: 179.

¹⁶ Cf. *AGM*: 231. Here the antibarbarian construction of Heraclides Ponticus probably played a role – he had even reserved the term *harmonía* for the Greek modes, Dorian, Ionian, and Aeolian (Ath. 62.4c, reflected in Pollux 4.65; cf. below, p. 61 n. 22 and pp. 430ff.): with the fifteen-keys system, a Greek majority was restored. Throughout this book I use the form “Iastian” rather than “Ionian”; in the sources, both are used indifferently for the respective *tónoi*.

Theorists before and after Aristoxenus contented themselves with fewer keys. Three older systems mentioned by Aristoxenus himself consist of five or six *tónoi*. Other authors refer to musical styles using seven keys, or even merely the three basic ones of Dorian, Phrygian and Lydian.¹⁷ Ptolemy, constrained mainly by the limitations of his ‘Pythagorean’ viewpoint,¹⁸ reverted to seven keys, in accordance with the seven diatonic ‘tunings’ or octave species, rejecting even an eighth that other anti-Aristoxenians had admitted. But his objections against the extended system of practical music and Aristoxenian theory do no justice to its motivation and structural foundation: to account for every possible kind of modulation.

In addition to the *tónoi*-based account, one very common type of modulation was usually described in a different way. Many theorists perceived it not as a change of key at all, but merely as the employment of two different options within the same *tónos*.¹⁹ To describe this relation, the ‘Greater Perfect System’ was combined with a ‘Lesser Perfect System’ into one tonal structure, called the ‘Unmodulating System’ (*σύστημα αμετάβολον*, Diagram 1).²⁰ Historically such a combination was purportedly favoured by the existence of two standard lyre tunings that shared their lower range from the lowest note, *hypátē*, up until the central *mésē*, from which they continued upwards with a ‘disjunctive’ whole tone or a ‘conjunct’ tetrachord respectively, ending with two different *nétai*.²¹

Modulation between the two parts of the combined system was so common that it received a name of its own: ‘modulation according to scale’, as opposed to ‘modulations according to key’, i.e. modulations that could not be described without resorting to the combination of two or more such systems, with two or more distinct *mésai*.²² Such extensive combinations were called ‘modulating systems’, which explains the name ‘Unmodulating System’ for the simple one-*mésē* type – a terminology which at first glance

¹⁷ Ps.-Plut., *Mus.* 1134ab; Ptol., *Harm.* 2.6, p. 56.4–6; Bacchius 46, p. 303.3–6; cf. also Aristid. Quint. 1.11, p. 23.1; Ath. 635c; *Frag. Cens.* 12, p. 7.4.11–12; Schol. Dion. Thrax, *Gramm. Gr.* 1.3, p. 476.33.

¹⁸ Cf. below, pp. 56f.

¹⁹ So Ptol., *Harm.* 2.6, p. 54.7–11; p. 56.3–17.

²⁰ For the accentuation of the feminine genitives plural (which are often found printed differently), cf. Hdn., *Pros. cath.* 3.1, p. 426.

²¹ Cf. Diagram 25 on p. 104 below. The terminology, which assigns the notion of ‘low’ to high pitches and ‘high’ to low pitches, is based on the physical position of the strings on the lyre in tilted playing position (cf. e.g. Baud-Bovy 1978: 164; *AGM*: 64). This is best illustrated by Plut., *Plat. quaest.* 1008e, where the analogy to the aulos makes it clear that the notion of ‘topmost and first’ applies to the entity next to the player: τὴν ὑπάτην ὄρωντας ἐν μὲν λύρα τὸν ἀνωτάτω καὶ πρῶτον [τόπον], ἐν δ’ αὐλοῖς τὸν κάτω καὶ τὸν τελευταῖον ἐπέχουσαν “seeing that the *hypátē* holds the topmost and first position on the lyre, but on the aulos the bottommost and final” (the hole for the lowest note is situated at the remote end of the wind instrument).

²² Cleonid. 11, p. 201.14–18; Aristid. Quint. 1.8, p. 14.24–6; cf. Hagel 2000: 35–8; esp. 36 n. 58.

The evolution of ancient Greek musical notation

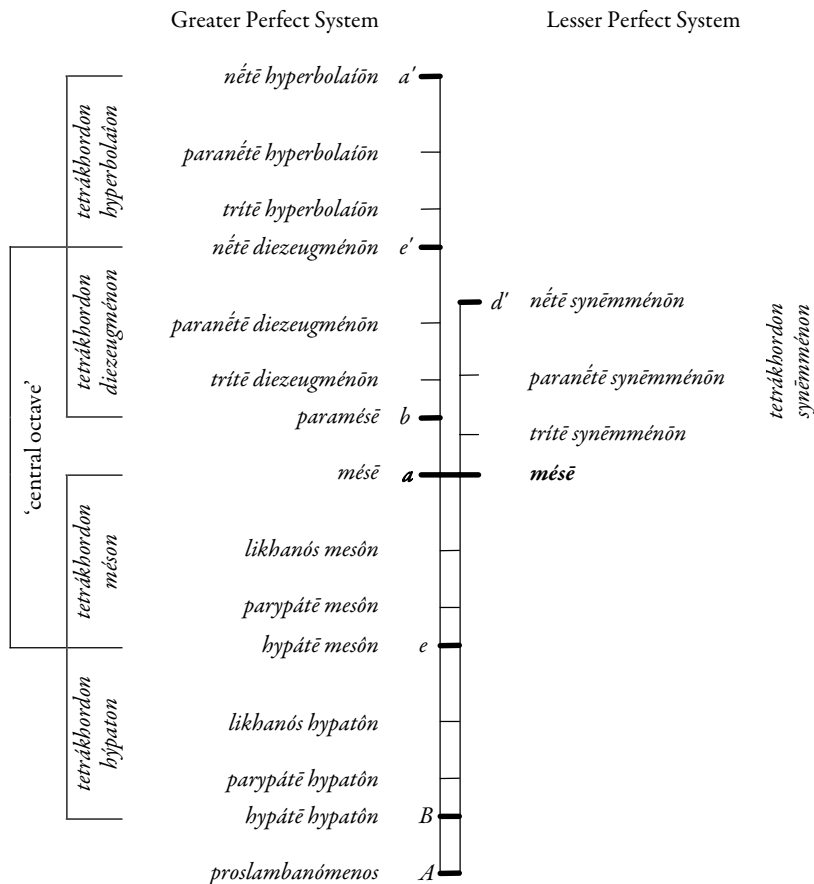
Diagram 1 The 'Unmodulating System' (*système ametábolon*)

must appear peculiar for a structure that, in our understanding, already contains a modulation.²³

Once the number of keys had been extended to the full circle of fifths, all the relations were describable by modulations between different *tónoi*. Even so, the traditional 'conjunct' scales, now entirely redundant, remained in

²³ Ptolemy, acknowledging the *synēmménōn* tetrachord as a modulating element, restricts the term *système ametábolon* to the Greater Perfect System. The *Division of the Canon* seems to preserve a pre-Aristoxenian usage where it designated merely the 'fixed' notes of the double octave (*Sect. can.* 19, p. 163.15–165.2; cf. Barker 2007: 400, and the arguments in Hagel 2005a for the importance of this scale skeleton in fourth-century BC music theory).

use. In the system of fifteen *tónoi*, the crucial ‘conjunct’ tetrachords of the five keys with plain names are part of their respective ‘Hyper-’ keys: Hyperlydian contains the ‘conjunct’ scale of Lydian, Hyperphrygian that of Phrygian, etc.

The existence of the rudimentary ‘conjunct’ approach to modulation side by side with an extended system of keys that would supersede it shows that the latter is younger. So it is not unlikely that the ancient notion of music ‘in three *tónoi*’ already refers to tonal structures with two branches such as the Unmodulating System. If so, the three keys in question would already have incorporated the most important notes of their later ‘Hyper-’ scales within their respective conjunct branches. The same holds true for seven-*tónoi* music. But here the old Dorian, Phrygian and Lydian were expressly provided with their ‘Hypo-’ counterparts also, so that all the relations of the later triads were already present. This explains the later appearance of ‘Hyper-’ keys as separate entities: thanks to the old conception of a ‘conjunct’ alternative, they had been included implicitly. Only once the complete set of modulating scales had been laid down by Aristoxenus, would it become obvious that part of them was structurally related to the conjunct branch of the old keys.²⁴ Consequently, the last revision of the nomenclature represented this relation by the invention of names with the prefix ‘Hyper-’.²⁵

As a result, the set of *tónoi* consists of several layers. Some still bear their pre-Aristoxenian names; others seem to have been implicitly present before Aristoxenus, but explicitly added as keys either by him or his successors; some were conceived and baptised by Aristoxenus, and renamed afterwards. Table 1 provides an overview of this evolution. It starts with the traditional three-*tónoi* music, for which we can already compare the famous *nómos trimelês*, attributed to the early sixth century, consisting of a Dorian, a Phrygian and a Lydian part.²⁶ The two systems mentioned by Aristoxenus are distinguished mainly by the harmonic relationship they attribute to the Mixolydian.²⁷

²⁴ They are not entirely identical, because the Lesser Perfect System, with its succession of three conjunct tetrachords without any intervening disjunctive tone, and therefore without repetition of the notes at the octave, is not compatible with the regular Greater Perfect System. To establish identity, the lowest tetrachord has to be ignored.

²⁵ Aristoxenus had used the same prefix in his ‘Hypermixolydian’, where it indicated a simple pitch relationship: the scale ‘even beyond’ the Low and the High Mixolydian. The resemblance to the later triads is only semantic (cf. the discussion below, pp. 429 ff.).

²⁶ Ps.-Plut., *Mus.* 1132 d; 1134 ab.

²⁷ Cf. n. 90 on p. 32 below.

	three <i>tónoi</i>	pre-Aristox. II I	seven <i>tónoi</i>	Aristoxenus	post-Aristoxenian
6 \flat	(✓)	✓	✓	Low Mixolydian	Hyperdorian
5 \flat	✓	✓	✓	Dorian	Dorian
4 \flat		✓	✓	Hypodorian	Hypodorian
	(✓)			Hypermixolydian	Hyperphrygian
3 \flat	✓	✓	✓	Phrygian	Phrygian
2 \flat		✓	✓	Hypophrygian	Hypophrygian
	(✓)				Hyperlydian
1 \flat	✓	✓	✓	Lydian	Lydian
–			✓	Hypolydian	Hypolydian
1 \sharp		✓		High Mixolydian	Hyperastian
2 \sharp				Low Phrygian	Iastian
3 \sharp				Low Hypophrygian	Hypoiastian
					Hyperaeolian
4 \sharp				Low Lydian	Aeolian
5 \sharp				Low Hypolydian	Hypoeolian

Table 1 Concordance of *tónoi* systems

The canonical seven *tónoi* seem to have been widely acknowledged by the time of, or not long after, Aristoxenus,²⁸ who takes it over and adds six new keys to fill in the extant semitone gaps. Four of them he labelled simply after their higher neighbours; similarly, there were two variants of Mixolydian, each reflecting one of the two older systems. There remained the highest scale, which he called ‘Hypermixolydian’: that ‘exceeding the Mixolydian’. The ultimate revision of the notation brought about two new doublet scales and the triadic terminology.

The table is arranged not according to pitch (as it commonly is in the ancient lists), but according to scalar relations: notes of similar designation in neighbouring scales are always a fourth or a fifth apart.²⁹ For each *tónos*

²⁸ Aristoxenus describes the earlier systems not to give a historical overview, but to exemplify the former disagreement about *tónos* relations. It is therefore possible that he deliberately omitted the most widely acknowledged account(s).

²⁹ Extant treatises generally give lists and/or diagrams of *tónoi* ordered by pitch. More in-depth works must have included others that displayed the inherent harmonic relations and consequently fol-

its conventional modern equivalent key is indicated by the corresponding number of flats and sharps. These correspondences between *tónoi* and modern keys have nothing to do with pitch or modality, nor are they anyhow inherent in the abstract theoretical scheme of *tónoi*. They result from structural features of the ancient notation – which are ultimately equivalent to our system of accidentals: there is a natural key, namely Hypolydian, which corresponds to the signs of the notation in much the same way as our natural key corresponds to the letters we use to designate notes, or to the white keys on the piano. Similarly, our accidentals have their counterparts in certain complications in the usage of the ancient note signs.³⁰

THE PROBLEM: DORIAN MARGINALISED

These facts are unequivocal, and they have troubled scholars quite a lot.³¹ ‘Dorian’ is in many respects central to ancient Greek music: as a lyre tuning, it was probably the first to be learnt by the novice;³² as a mode, it was most highly esteemed by both Plato and Aristotle;³³ as an octave species, it

lowed the circle of the fifths; cf. Aristid. Quint. 1.10, p. 21.8–12. A mixture of both options is Alypius’ extensive lists, where the terminological triads are kept together, while their order is governed by pitch.

³⁰ These relations were determined independently by Bellermann 1847 and Fortlage 1847. Bellermann (if I understand the principle followed by him at all) mistakenly notates Dorian with seven sharps (43) because it contains pitches only available as reverted forms (see below), which he associates with sharps. But Phrygian and Hypodorian also include reverted forms; the mere fact that the same pitches would have been available as different notes cannot justify a transcription as if these other forms had been used (cf. e.g. ΠΔ transcribed as *a*♯ on p. 39 and Beilagen Blatt 1f in “Dorisch” and “Hyperdorisch”, but as *b*♭ in “Phrygisch” etc.); on the contrary, it makes them stand out even sharper. In any case, the association of ancient keys with modern sharps and flats reflects only one aspect of the former, whereas it obscures the internal relations between the single note signs (cf. Fortlage 1847: 136 n. 1). Moreover, a one-to-one match between ancient and modern notation cannot be achieved anyway: ΠΔ should be transcribed by *b*♭ on systematic grounds in the mentioned keys, while one could argue for writing *a*♯ in chromatic Lydian; as Hypoaeolian *paramésē* the latter rendition is scarcely avoidable.

³¹ Cf. especially Riemann 1902 (followed most prominently by Düring 1934; criticised by Sachs 1925; 1924: 289 n. 1). The solution Riemann proposes is logically sound as regards a synchronous description of pitches and notational signs, but inconsistent as regards the relation of the bounding notes of the tetrachordal framework to the positions of the respective notes within the triplets of the notation; on top of this, Riemann cannot explain the evolution of the notation of his presumed original Dorian octave (according to his hypothesis, the triplets ΔEZ and NΞO would have been reserved, from the very start, for an expansion to take place only later; the Dorian *synēmménon* tetrachord, on the other hand, would not have been provided for at all, contrary to what one would expect from a Dorian-centred scheme).

³² Cf. Aristoph., *Equ.* 987–96.

³³ Plato, *Lach.* 188d; 193d; *Rep.* 399a–c; Aristot., *Pol.* 1340b; 1342ab.

gave the model for the central octave of the Greater Perfect System, between *hypátē* and *nētē*, the old limits of the octave *harmonía*. But in the notation, it is by no means the natural scale, as one should expect, but lies at the outskirts of the diagram, to be transcribed with five flats. Consequently it was suspected that there is something wrong with the notation as we have it; that it underwent a profound change after the classical period.³⁴ It is one of the major purposes of this chapter to show that nothing of that kind was the case, but that we can understand the marginalised position of the Dorian *tónos* without resorting to unfounded speculation.

THE EVIDENCE OF THE DEVELOPED NOTATION

Before we can proceed to investigate the evolution of the notation, we must first inspect the organisation it displays in its evolved state. Its structure is determined by the ancient practice of analysing the tonal material in terms of tetrachords: four-note units spanning a fourth, which could be concatenated either immediately or by means of a 'disjunctive' whole tone. The Unmodulating System of Diagram 1, for instance (above, p.6), consists of five tetrachords and two disjunctive tones. Modulations are produced by adding a conjunct tetrachord where otherwise a disjunctive tone would have been, and vice versa. This overall structure defines the cardinal points of every musical system, the so-called 'fixed' notes. The relative position of the remaining inner two notes of each tetrachord determines the 'genus' (*génos*) of the scale. An (ascending) sequence of a semitone and two whole tones gives the diatonic genus, which predates Hellenic culture considerably³⁵ and was the only one to survive into Western middle ages (e.g. *e-f-g-a*). Possibly Greek innovations were the other two genera, which are characterised by *pykná*, 'crowdings' of the notes at the lower end of the tetrachord. In the enharmonic, which flourished in the fifth century, we are told that the three notes are separated merely by quartertones (e.g. *e-e[↑]-f-a*). The chromatic, which gained prominence among the composers of the late fifth century together with extensive modulation, used semitones

³⁴ Most prominently Henderson 1957: 359–67 (cf. Winnington-Ingram 1958: 244–7).

³⁵ Diatonic music is attested in Old Babylonian cuneiform tablets, but probably goes back at least to Sumerian music; cf. e.g. Kilmer 1997; Kilmer 2001. The diatonic is acknowledged as older than the other Greek genera in Aristox., *Harm.* 1.19, p.24.20–25.4.

instead (e.g. $e-f-f^\#-a^{36}$). Thus the basic relationship of the three genera can be drawn as follows:

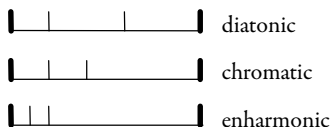

But these relationships, stated in simple parts of a whole tone, served just for a first orientation. In practice, musicians used a variety of ‘shades’. It is important for our topic that the varying sizes of *pykná* could make the distinction between the enharmonic and the chromatic appear somewhat arbitrary, as transpires from a passage from Aristoxenus:³⁷

ἀλλ’ οἱ γε διατριβόντες περὶ τὰ ὄργανα διησθάνοντο μὲν ἑκάστου τῶν γενῶν, αὐτὸ μέντοι τὸ πότε ἄρχεται ἕξ ἁρμονίας χρωμά τι γίγνεσθαι, οὐδεὶς οὐδ’ ἐπέβλεψε πώποτ’ αὐτῶν. (Aristox., *Harm.* 2.35, p. 44.15–22)

But those who employed themselves with the instruments had a clear perception of each of the genera; yet the very point where the enharmonic becomes some sort of chromatic was never focussed upon by any of them.

The triplets of notes building the individual *pykná* are reflected in the notation by triplets of signs. While these are only implicitly present beneath the smooth alphabetic surface of the vocal series, the instrumental notation exhibits them clearly: in ascending order, each fundamental sign appears in rotated and reverted form also (e.g. C⊂). In their function as lowest notes of the *pyknón*, the basic signs are naturally associated with the fixed notes of the Perfect System.

It is generally assumed that the sign triplets were originally conceived as a kind of tablature (*Griffsschrift*) for an instrument on which it was possible to raise the basic notes by any amount up to a semitone or a tone.³⁸ Since

³⁶ It is preferable to write $f^\#$ instead of g^b , if only because ancient notation frequently associates the pitch in question with the note below, but never with that above (similarly, one might want to write $e^\#$ instead of f , were it not for the sake of readability). The transcription does not imply, a priori, modern harmonic relations.

³⁷ Cf. Laloy 1904: 108–11; Barker 2000: 127 with n. 13. Rocconi 1998 attributes the full theory of genera only to Aristoxenus (cf. also Rocconi 2004). One may also compare the view of Archestratus (Porph., in *Harm.* 26.27–27.7), who seems to have classified the function of notes in accordance with their position in the *pyknón*, regardless of their actual pitch. His terminology is non-mainstream (the meanings of ‘*barýpyknos*’ and ‘*oxýpyknos*’ are inverted in comparison to other sources), his approach apparently close to the practice of notation.

³⁸ An exception is Fortlage (1847: 85), who embraced the idea of a retuning notation, turning signs corresponding to tuning pegs to be turned. This is plainly contradicted by the fact that all scales con-

lyres were not played in this way,³⁹ the instrument in question can only have been the aulos, the playing technique of which necessarily included partially opening finger holes.⁴⁰ On the other hand, the *pyknón* is such an obvious melodic and scalar feature that it might well have been embraced into a system of notation which was not devised for merely one specific instrument (although the experience of playing the aulos might have facilitated such a conception).⁴¹ The fact that the notation does not distinguish between enharmonic and chromatic *pykná* recalls Aristoxenus' criticism of the 'organologists'. It seems as if the architects of the system considered it as hopeless to account for any further distinctions within a continuum of possible *pyknón* sizes.

The details of the notation can be gleaned from Diagram 2, the layout of which is based not on pitch relations, but on equal distances between adjacent signs. It is therefore crucial to remember that these do not indicate absolute pitch nor fixed pitch relations to other signs: consequently identical vertical positions do not necessarily imply identical pitches. To find the pitch relation of any two signs of different keys, one has to determine first the interval of one of these to a fixed note (if it is not itself one), assuming a specific tuning, then follow the path of tetrachords and whole tones to some fixed note of the other key, and then to the note in question there.

tain different members of the same triplets side by side (to avoid this problem, Fortlage hypothesised a complicated history, during which the original meaning of the system changed entirely).

³⁹ Cf. Winnington-Ingram 1956, refuting the theory of pentatonic lyre tuning (cf. below, pp. 435 ff.). A new lyre tablature hypothesis was put forward by Thurn 1998. This is not the place to deal with it in detail; suffice it to say that among other doubtful interpretations, Thurn mistranslates the single passage on which his hypothesis rests, Philochorus *ap. Ath.* 637–8 μακρούς τοὺς τόνους ἐντέϊνας, by “indem er die großen Saiten einspannte”. This would call for τοὺς μακροῦς τόνους (if one follows Thurn in translating *tónoi* by “strings” at all, cf. Rocconi 2003: 143; for the passage in general cf. Barker 1982b); as it stands the Greek can hardly refer to the subset of strings required by Thurn's hypothesis. Thurn also fails to discuss the physical potentials of strings (cf. below, pp. 76 ff.); the proposed plucking technique seems highly impractical and incapable of producing the required “full sound” (φωνήν εὐογκον); finally, the suggested tuning confines the player to anhemitonic pentatonic when using the strumming technique (cf. below, pp. 435 ff.).

⁴⁰ Cf. Husmann 1957: 57; Chailley 1967: 203; *AGM*: 262; 95.

⁴¹ A correspondence between the signs of the notation and the finger holes of auloi of different sizes is proposed by Byrne (2000: 282 with figs. 8 and 9 on p. 285), although on a purely archaeological basis and without attempting to relate the alleged correlations to scales or *tónoi*: Byrne adopts, as “the earliest instrumental signs”, a very low range far below the ‘central octave’, some signs of which do not even conform to the usual rotation and reversion scheme, and almost all of which belong to the secondary, derived shapes in the vocal series.

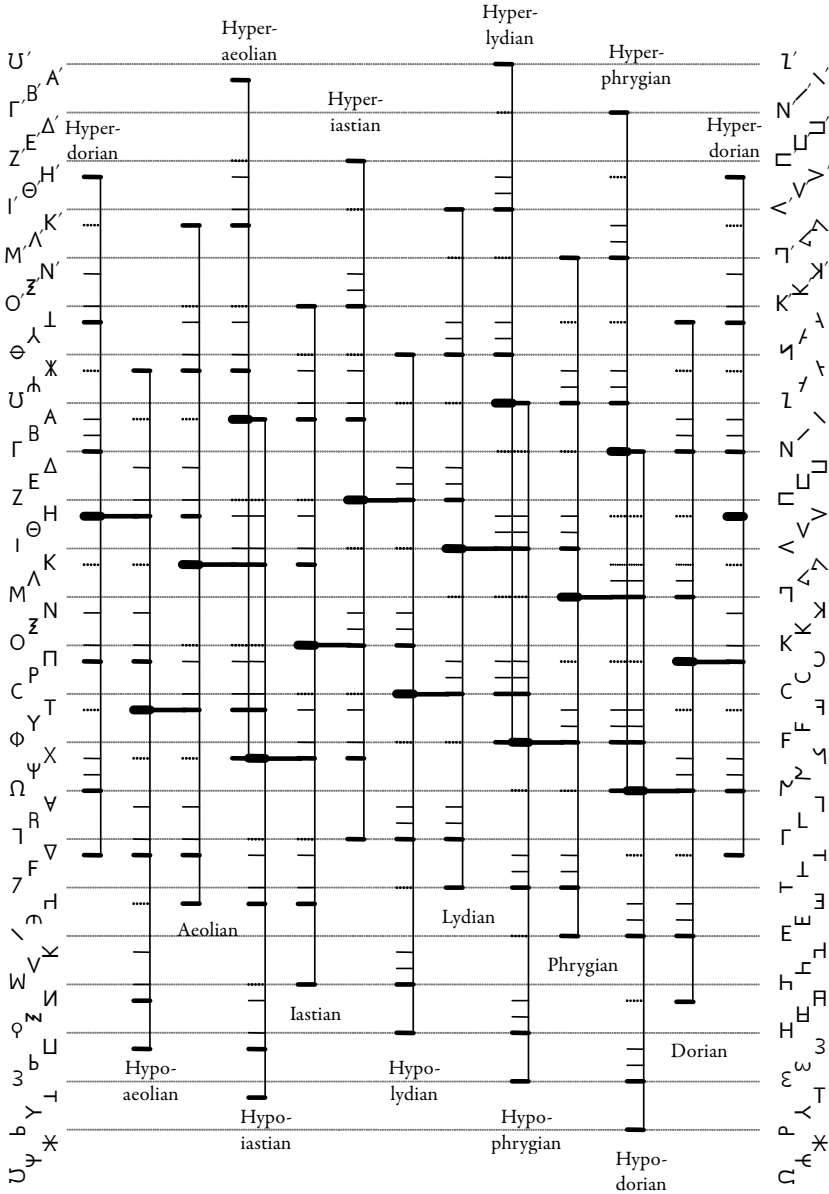

Diagram 2 The fully developed notation system
 (from Hagel 2000: 190, with adaptations and a corrected Hypophrygian *diátonos mesôn*)

In the diagram the fixed notes are printed bold, and the *mésē* of each *tónos* is marked especially. The *pykná* are represented by thin lines, so that the enharmonic and chromatic scales can be read from the continuous lines. In diatonic scales the higher movable note falls out of the range of the *pyknón*, thus needing a sign of its own; the corresponding lines are dotted. It is easily seen how these typically diatonic notes are identical to standing notes of some nearby key (namely one standing to the right of the original key). For the lower diatonic movable note the same sign is used as in the other two genera.

There are three fundamental correspondences which are fully upheld only in the central Lydian triad: that between a sign triplet and the notes of the *pyknón*; that between the fixed notes and the basic notes of the sign triplets; and that between the diatonic notes and the basic notes of the triplets. Digressions from these relations are structurally similar to our sharps and flats. All correspondences are immediately broken if we move from Hypolydian leftwards, that is, in the direction of *tónoi* that are always situated a fifth above or a fourth below the previous one. These are the keys to be transcribed with sharps, and, as a comparison with Table 1 shows, those that were added to the system of *tónoi* by Aristoxenus. Consequently they must have been integrated into the notation still later, at least as regards their deliberate systematic adoption.

On the other hand, if we proceed rightwards, to the keys located always a fourth above or a fifth below the previous one, many of the fundamental relations are upheld. Hypophrygian is still identical with Hyperlydian; in the next scales, Phrygian and Hyperphrygian/Hypodorian, it is merely the diatonic notes that are no longer designated by basic signs. It is not until Dorian that a fixed note is represented by an 'accidental'. Here the note in question, however, is nothing less than the Dorian *mésē*: the very note we should have expected to stand in the centre of the whole system. In any case, at least the Dorian *pykná* are still notated by sign triplets. Finally, Hyperdorian displays a mixture of 'correct' *pykná* and the curious ones we encounter within the left half of the diagram. Hyperdorian can be transcribed either with six flats or with six sharps; and it is the same structural law that governs the interchangeability of both scales on the modern keyboard that accounts for Hyperdorian displaying characteristics of both kinds: if the scales are regarded as a cycle – as they certainly were in Aristoxenian thought, which stands behind the developed system – then Hyperdorian stands opposite to the 'natural' Hypolydian (cf. Diagram 3).

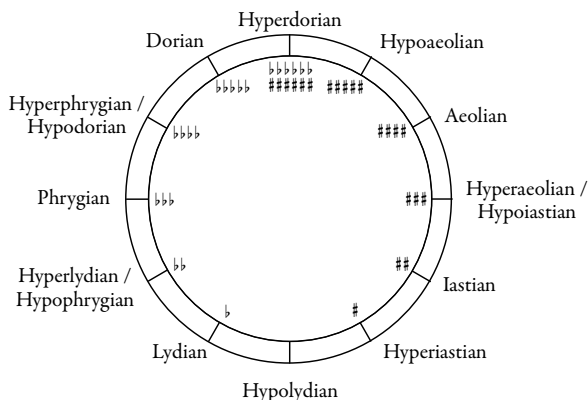

Diagram 3 The *tónoi* forming the circle of fifths

All in all, we encounter a fundamental dichotomy: on the one hand, the rather abrupt and complete loss of the basic correspondences, associated with those scales that represent late additions, on the other the steady employment of triplets for *pykná* in scales which have received the names of the traditional *tónoi*. The structural break between ‘left’ and ‘right’ scales is determined by the principles of Greek scales themselves in connection with the most basic assumptions of the notation system. Still, the mapping of *tónoi* names onto the scales is a matter of choice: certainly it would have been possible to put ‘Dorian’ in the place of, say, Lydian. But what would have been the consequences? Since the relation of Dorian to Phrygian and Lydian were fixed, the triads of the latter would then come to lie on the ‘left’ half of the diagram, and consequently the majority of the important scales would lose all basic correspondences – which would then instead be reserved for the secondary ‘Low’ scales of Aristoxenus (later incorporated into the ‘Iastian’ and ‘Aeolian’ triads).

We must conclude that the marginal position of the Dorian *tónos*, the ‘accidental’ state of its *mésē*, is the necessary consequence of a meaningful mapping of the inherited *tónos* system onto the scales provided by the notation. It would have been difficult to invent another type of notation where Dorian could have obtained a central position, and in which the crucial relations of tetrachords and *pykná* were nevertheless reflected. From a synchronic viewpoint, we can regard the arrangement of keys in the ancient notation as sufficiently explained.

TOWARDS A DIACHRONIC APPROACH

It is still unclear how such a system could evolve, however, given the apparent prominence of the Dorian at the time in question. It is barely plausible that someone designed a whole system from scratch that extended over at least six abstract keys, and then decided afterwards where to put the known *tónoi*. Therefore it is necessary to tell the story of the system's evolution, starting from a rather primitive core, and extended as needed by practical music-making.

First, however, we have to recall some evidence about earlier stages of the system that can be inferred from the sets of signs employed.⁴² At some point, the instrumental series extended merely down to H, and probably not even beyond H: the lower basic signs are already taken from the alphabetic series of the vocal notation, and in HϞϞ the principle of rotation and reversion appears to have been abandoned.⁴³ A former upper end can be determined with certainty: the three forms of NΛϞ, although forming a typical triplet by rotation and inversion, are not used for a *pyknón*, but employed for three successive basic signs. Obviously at some earlier stage there was no need for *pykná* at such a high position in the scale.⁴⁴ This might have been the same stage at which the vocal notation was devised: the first and highest triplet of the latter, ΓBA, is assigned to the basic note represented by the instrumental N. Did A and B originally correspond to Ϟ and Λ, and were then re-mapped to retain their logical position when the system was extended?⁴⁵ At any rate the coincidence of the basic notes of the first vocal triplet ΓBA and the instrumental triplet NΛϞ, which certainly once constituted the upper end, makes it very likely that the vocal system was created before the upwards extension took place. It is also probable that at the time of this first conception of the vocal signs the system was already so large that the twenty-four letters of the alphabet did not suffice for all signs needed. Therefore a second alphabetic run had to be started, with letters inverted vertically, or, where this did not yield different forms, rotated or distorted. This second run did not extend further down than 3 (and proba-

⁴² For the following, cf. *AGM*: 159–263; West 1992a: 36; Pöhlmann 1995: 1685–6; Pöhlmann 1997: 284.

⁴³ But cf. West 1992a: 40. The triplet Εω3 need not be older than the lowest two (which are only the reverted vocal forms) simply because it is still a formal triplet: vocal Λ is not only identical to its reverted form but also to instrumental Λ = vocal E: so it could not be adopted.

⁴⁴ Cf. Bellermann 1847: 46; Chailley 1967: 209.

⁴⁵ Barbour 1960: 5–6.

bly only to ϙ), because when the upwards extension took place, the last six letters were still available to designate the two newly created triplets. When it finally came to the last additions at the lower end, the same letters were used again, but had to be modified in yet another way, mainly by rotation by ninety degrees.

The origins of the notation must therefore be sought somewhere between instrumental Η and Μ, taking into account that there were no *pykná* above Ν.

In the following, it will be argued that the original conception of the system was basically independent of the evolving theory of *tónoi*. This will eventually provide us with a natural solution to the riddle of the Dorian. First we must keep in mind that the largely coherent system of Greek music theory, describing scalar systems, tetrachord tunings and all kinds of modulations, and coming up with a fully developed notation accounting for all these phenomena, is the final outcome of often rivalling but ultimately converging efforts, driven forwards by different schools of ‘theorists’ as well as by musicians and instrument makers. Different parts, such as the model scale of the Perfect System and the relations of individual scales as *tónoi* were developed more or less independently. Still they were all oriented towards the same tonal system(s) of musical reality, and so they could finally be assembled to larger paradigms, describing a greater part of the phenomena (and ultimately re-influencing contemporary composers).

Notation could be conceived as a theoretical means of defining a tonal grid, into which individual scales could be fitted. Aristides Quintilianus transmits such a system, dating probably from the times when a common underlying principle for the ‘irregular’ classical scales was still sought after.⁴⁶ Seemingly not being rooted in practice, it must have fallen into disuse once all these problems were solved within Aristoxenian theory. Completely different is the case of the notation we are dealing with. In spite of its obvious theoretical shortcomings – especially the ambiguous relation between signs and pitches – and Aristoxenus’ reservations, it appears that musicians never saw any need to create a different system. Without doubt its origins are already to be sought in the reality of music-making, in the wish to write down not tonal systems, but melodies. Absolute pitch probably did not matter at this rather early period. Therefore there was no need to cover a lot of interrelated keys, at least not at the time before exuberant

⁴⁶ Aristid. Quint. 1.7, p.12–13; cf. Bellermann 1847: 61–5; Mountford 1923; Chailley 1973; Winnington-Ingram 1973; West 1992a: 42–6.

The evolution of ancient Greek musical notation

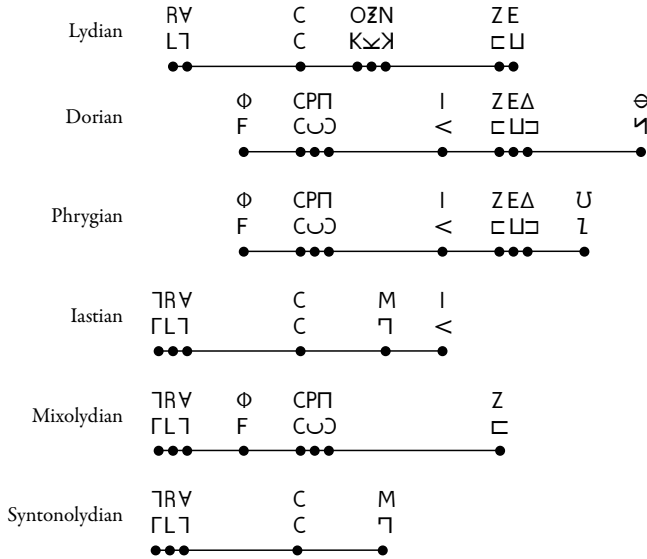

Diagram 4 The ancient scales described by Aristides Quintilianus

modulations became common. Some natural scale plus the traditional types of modulation would have sufficed.

This is not mere speculation. Two pieces of evidence for early notation confirm the picture. First there is the celebrated set of archaic-looking scales listed by Aristides Quintilianus as “the *harmoniai*”, already used by “the very ancient” and implied in Plato’s *Republic*.⁴⁷ He both describes them by means of intervals and writes them down using vocal and instrumental notation (cf. Diagram 4). And although those of Aristides’ scales that bear the names of ‘Dorian’, ‘Phrygian’ and ‘Lydian’ are clearly the fore-runners of the later ‘octave species’ and *tónoi* with the same names,⁴⁸ they are notated not in their respective *tónos*, but in the ‘natural’ central keys that we know as the Lydian triad.⁴⁹ Still this does not prove that the *tónos* approach to the notation did not yet apply at the age in question: the notated form of the scales need not date that far back. They were more probably transmitted as interval lists or verbal descriptions and transcribed

⁴⁷ Aristid. Quint. 1.9, p. 18–20. Their source is probably a lost work of Aristoxenus, rather than a commentary on Plato’s *Republic* (Barker 1982a: 183–4; *GMW* II: 419 n. 112; Barker 2007: 45–8). For a more detailed discussion of their context see below, pp. 390ff.

⁴⁸ Mountford 1920: 25–8; Winnington-Ingram 1936: 21–30; *AGM*: 227–8.

⁴⁹ Comotti (1989: 79) rightly cautions against deriving any notion of the relative pitch of these scales from their notation: “... should be referred to different pitches than those marked on the diagram”.

only later, possibly even by Aristides himself.⁵⁰ Still it is significant that whoever notated them chose Lydian notation. Aristides himself was well acquainted with the notation of all *tónoi* (his work included a full account of the system, although not all of his tables survived in manuscript tradition), and we must assume a similar knowledge for any possible source that made use of notation at all. So why would the ‘appropriate’ *tónoi* not have been used? Obviously it was felt that these were not appropriate for scales of Socrates’ times.

Whatever the history behind Aristides’ lists, they find strong support in the famous *Orestes* fragment.⁵¹ This piece of papyrus from about 200 BC bears music to Euripides’ play, and it is largely assumed to be not unlikely that the melodies go back to the poet himself.⁵² Insofar as the vocal scale can be gathered from the relatively few notes, it is identical to the ‘ancient’ Dorian or Phrygian as given by Aristides (the distinctive highest note not being present) – and it is written with the same signs of the ‘Lydian’ key as there:⁵³

Aristides’ Dorian	Φ CPΠ		ZEΔ	⊖
Aristides’ Phrygian	Φ CPΠ		ZEΔ U	
<i>Orestes</i> fragment	Φ CPΠ		ZEΔ	
The ‘Lydian’ <i>tónos</i> ⁵⁴	7 7BA Φ CPΠ		ZEΔ U ⊖ΛL	Í

Direct testimony takes us this far back in time. It will be noticed that the highest note of the Aristides scales coincides precisely with that of the system before the first upwards extension took place. These scales seem to reflect a state in the evolution of the notation when music was generally notated in the ‘basic’ key, regardless of its modal connotations. The latter were reflected in the choice of the tonal material, as for instance the highest note in the case of Dorian and Phrygian, and of course in the characteristic employment of typical tonal relations and melodic formulas. It may be significant that there is no evidence that these modal characteristics were lastingly transferred to the homonymous *tónoi*. On the contrary, there

⁵⁰ Cf. Winnington-Ingram 1936: 27–8; Chailley 1979: 110; Barker 1982a: 185; *GMW* II: 420 n. 116.

⁵¹ *DAGM* № 3.

⁵² Prauscello (2006: 154–60) makes a good case for the alternative possibility of a re-adaptation for virtuoso performance; cf. also Anderson 1994: 220–2.

⁵³ Cf. already Crusius 1894: 181–2.

⁵⁴ This is the enharmonic/chromatic series with the inclusion of *nētē synēmménōn* U and *hyperypátē* Φ, which must be regarded rather as fixed, not as diatonic movable notes; cf. *GMW* II: 205–6 nn. 65 and 71; Hagel 2000: 89–93. The presence of Φ together with the enharmonic/chromatic highest notes of the *pyknōn*, Π and Δ, which are mutually exclusive in the regular scales, establish the connection between the *Orestes* fragment and the scales from Aristides.

seems to be a distinctly ‘Dorian’ part in the First Delphic Paean, notated, however, in Phrygian;⁵⁵ and the two Delphic Paeans use largely identical modality in their respective opening sections, although they are notated in entirely different *tónoi*.⁵⁶

THE ORIGINS OF THE NOTATION

We have now collected all necessary information to make a hypothetical reconstruction of the earlier stages of the notation, and the principles behind its evolution. At the beginning there was probably not much more than the ‘central octave’, comprising the notes from *hypátē* (*mesôn*) to *nētē diezeugménōn*: the very note names, stemming from archaic lyre tunings, betray the original character of this range. Since the conception of the *pyknon* is at the heart of the system we need not necessarily assume that any other genus than the enharmonic was considered at first; Aristoxenus still accuses earlier writers on music to have neglected the other two genera.⁵⁷ The primary key is, as still found in the *Orestes* fragment, that one which was later called the ‘Lydian’. Thus the core of the system consists of more or less these signs:

C	∪	∩	<	□	∪	∩	N
<i>e</i>	<i>e</i> ¹	<i>f</i>	<i>a</i>	<i>b</i>	<i>b</i> ¹	<i>c</i>	<i>e</i>

Now that we have reduced the various instrumental signs to the plausible earliest set, their forms become clear: most of them are not letters at all. The basic signs are the simplest shapes that are open to the right, chosen for easy recognition when rotated stepwise by ninety degrees. One notices the resemblance to our three simple forms of opening and, in the case of the last members of the triplets, closing brackets: () < > []. For the highest note, which was not yet part of a triplet, the letter N seems to have been introduced as an abbreviation of the note name, *nētē*.⁵⁸ One may speculate that the original shape of this sign was the rightwards-oriented letter form N, and that the three forms of this letter were re-arranged according to their pitch once the N ∪ N triplet was complete.

⁵⁵ *DAGM* № 20.1–8 (similar *DAGM* № 21.1–7 in Lydian notation); cf. Hagel 2000: 41–2.

⁵⁶ Cf. Hagel 2000: 96–7.

⁵⁷ Aristox., *Harm.* 1.2, p. 6,6–19; cf. below, p. 375.

⁵⁸ Cf. West 1992a: 42 n. 78.

The fact that a rotating sign was used for *mésē*, too, betrays the fact that already in this earliest form a *pyknón* above this note was envisaged. Obviously the *synēmménon* tetrachord was already provided for, to account for that basic type of modulation which had been in use since very early times. Thus we have to expand the structure to the combination of the two early lyre tunings, the disjunct and the conjunct:

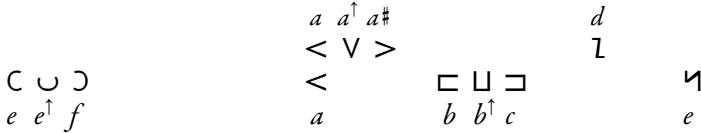

Here we are dealing with two types of *nētē*, consequently notated by two variants of the letter N (which may originally have read N and \perp^{59}).

With practical music developing towards more extended types of modulation, a further step saw the extension of the *synēmménon* tetrachord to a full scale of an octave, parallel to the first one. Two new note signs had to be introduced. Since the repertory of simple bracket-like shapes was exhausted, new paths had to be explored. The sign that was devised for the new *hypátē*, F, is still very similar to the first three signs, being open to the right and therefore easily recognisable in its position within the *pyknón*. But it is not symmetrical about the horizontal axis. The highest members of the original triplets can be seen as the result of a 180 degree rotation, or of a reversion about the vertical axis. Now a decision had to be made between these two interpretations; it fell in favour of the reversion: ∇ is more easily recognised as a variant of F than is \sqsubset .

It is in principle possible that F had already been introduced as the *hyperypátē* of the basic series: this note, literally ‘beyond *hypátē*’, lying a tone below the original lowest note of *hypátē*, was apparently baptised an-

⁵⁹ Alternatively one could suppose that the leftwards-oriented letter form ∇ was the ‘original’ *nētē diezeugménōn*, calling for a *nētē synēmménon* of the shape Σ — which would have naturally been changed to \perp , once it had come to stand between N and ∇ . But the openings of the rest of the signs clearly indicate rightwards orientation, since they must be interpreted in the context of Greek scripts, in which openings are oriented towards the direction of writing, not backwards (B Γ E F K Σ) — a characteristic inherited from the Palestinian alphabet. For the conception of rightwards opening as the normal form cf. Alypius’ $< \lambda\mu\beta\delta\alpha \ \pi\lambda\acute{\alpha}\gamma\iota\omicron\nu$ “horizontal lambda” with $> \lambda\mu\beta\delta\alpha \ \pi\lambda\acute{\alpha}\gamma\iota\omicron\nu \ \acute{\alpha}\pi\epsilon\sigma\tau\rho\alpha\mu\acute{\mu}\epsilon\nu\omicron\nu$ “horizontal lambda, facing backwards”; similarly $\sqsubset/\sqcup, \vdash/\dashv$. Finally, the sign referenced by Gaud. 22, p. 351.4–5 as $\pi\lambda\acute{\alpha}\gamma\iota\omicron\nu \ \Upsilon \ \acute{\alpha}\pi\epsilon\sigma\tau\rho\alpha\mu\acute{\mu}\epsilon\nu\omicron\nu$ καὶ $\Upsilon \ \pi\lambda\acute{\alpha}\gamma\iota\omicron\nu$, is given as $> <$ in the manuscripts at Aristid. Quint. 1.11, p. 26.16–17, in accordance with the rightwards-opening interpretation, but contrary to a mechanical application of $\pi\lambda\acute{\alpha}\gamma\iota\omicron\nu =$ ‘turned counterclockwise by 90 degrees’, as one might be inclined to generalise from the custom followed in the cases of $\Lambda \ \Pi \ \top$ (and of Φ in Alypius, but not in Gaudentius: the horizontal forms of Φ or half- Φ have no open side and therefore no well-defined orientation).

terior to the conception of an entire additional tetrachord in this position.⁶⁰ We find it both in Aristides' scales and in the *Orestes* fragment (as vocal Φ). Its shape F, however, seems devised with respect to its suitability for building a triplet, whereas there was most probably no modulating *pyknón* above *hyperypátē* in earlier times: do the origins of the system reach further back than the introduction of the *hyperypátē*?

The signs for the new *mésē* and its *pyknón* have become severely distorted in the course of the centuries, so that the shapes $\nabla\triangleleft\Delta$, in which they appear in the manuscript tradition, no longer conform to the principle of rotation and reversion. Their original design can only be guessed.⁶¹ Since the rotated form of ∇ would be hardly distinguishable from \square , it seems clear that the basic sign must have incorporated at least one of the sharp angles, which make this triplet so confusing to the human eye. It is perhaps significant that such angles and a triangular outline appear only in this group and in the triplet of the old *mésē*. Thus one might speculate that the notation of the new *mésē* might have been derived from the old one simply by adding a diacritic stroke to its upper arm.⁶² But we shall come across a more convincing explanation later on.

Further expansions were applied in two dimensions, increasing the system's ambitus as well as its fitness for modulating music. A relative chronology of these additions is difficult to establish. Most noteworthy is that the original higher notes seem to have still sufficed. Obviously the *hyperboláion* tetrachord was not yet in use. And indeed its adoption was probably the result of an organological innovation; literary evidence connects it with the avant-garde composers of the late fifth century.⁶³ The absence of this highest tetrachord from early forms of the notation – evinced by the upper limit the N triplet poses, proves that the notation is earlier than Timotheus, at least: as it was invented for, and transmitted by, professional musicians,

⁶⁰ Aristid. Quint. 1.6, p. 8.9–13; Thrasyllus ap. Theon, *Util. math.* 88.17–92.19; Boeth., *Inst. mus.* 1.20, p. 208.10–16; Cod. Vat. 192, fol. 222r (Reinach 1897: 315–16). Cf. Winnington-Ingram 1932: 206–7; Winnington-Ingram 1936: 25–8; *GMW* II: 205 n. 65.; 206 n. 71; *AGM*: 221; Hagel 2000: 89–93; Barker 2007: 398–9. Significantly, the same note, although under the designation of *hypatón diátonos*, is also present in the set of 'fixed' notes the *Division of the Canon* (probably fourth century BC) constructs as the '*système ametábolon*' (*Sect. can.* 19, p. 164.2–3).

⁶¹ Cf. West 1992a: 38. A triplet $\nabla\triangleleft\Delta$, as printed in *AGM*: 256, restores the similarity in appearance but not the structural connections.

⁶² Cf. Bataille 1961: 18. Cf. the analogous differentiation between Latin C and G.

⁶³ Ps.-Plut., *Mus.* 1142a; for its possible origin in aulos music, cf. Hagel 2005a: 84–6. The designation of the 'middle' tetrachord also makes sense only in an environment of merely three ranges of *hypátai*, *mésai*, and *nétai* (cf. Aristox. ap. ps.-Plut., *Mus.* 1135b; 1137d; Aristid. Quint. 1.11, p. 22.25; Theon, *Util. math.* 48.15–16; Orib., *Coll. med.* 6.10.23; Schol. Eurip., *Or.* 176).

we must expect that it was almost instantly adapted to reflect the most recent advances in musical style.

The deep notes of the *hýpaton* tetrachord, on the other hand, were already known to ‘the ancient’ composers (οἱ παλαιοί), i.e. those predating the innovations of the second half of the fifth century BC.⁶⁴ Accordingly, the notation was extended downwards, in both of its scales. The inventors of the new signs, it seems, followed the direction led by the conception of F: the rightwards orientation was no longer contrived by an opening, but by extensions from a vertical stroke. Starting from the template of F, and omitting its horizontals in turn, one ended up with the basic signs Γ and ⊥.

Reiterated modulation, into the *synēmménon* tetrachord of the second scale, brought about a third *nētē*, again to be notated by a variant of N. Now that there were three forms of N, they could be re-arranged (if this was necessary) to a canonical triplet. The downward extension to a full octave required the invention of a sign for a third *hypátē* as well. And it seems as if, this time, one more abbreviation was adopted: Ϻ looks as if derived from some form of the letter Υ.⁶⁵ This would be the first instance of a *pyknón* implemented by a triplet based on a letter. Certainly there are no strong objections against such an interpretation, once a letter-based triplet was established for the three *nêtai*. But another explanation is possible on the assumption that the introduction of the scalar degree of the *hyperypátē* took place just between the conception of the second and the third scale of the notation. In this case, the primary *hyperypátē* was identical to the *hypátē* of the second scale, and therefore already assigned a note, F. But a sign for the *hyperypátē* of the second scale was still missing. The adoption of an abbreviation – for *hyperypátē*, in this case – would then have posed no problem at all, since the tone in question was, at that time, not part of a *pyknón*. According to this model, the third scale would have found its *hypátē* ready for use.

Similarly, no new sign had to be devised for the *mésē* of the third scale. Since this scale came to lie two tones below the first one, and the interval between the *mésē* and the highest note of the enharmonic *pyknón* below it is a ditone, the note used for the latter could be adopted for the *mésē* of the third scale (cf. Diagram 5). That this was done sheds an interesting light on some of the underlying principles.

Firstly, it proves beyond doubt that the *pykná* of the early notation, at least at this particular stage, were indeed enharmonic *pykná*, and moreover

⁶⁴ Ps.-Plut., *Mus.* 1137d (with the subject in 1137b), doubtless quoting Aristoxenus.

⁶⁵ West 1992a: 39; 42 n. 78.

of exactly the fixed magnitude still postulated by Aristoxenus. Only a rigid identification of the size of the ditone forming the highest interval of the enharmonic tetrachord with the sum of the two tones created by reiterated modulation could lead to the identification of the notes in question.⁶⁶ The ditone of modulation is reached by alternating fourths and fifths, just as is the ditone of the 'Pythagorean' tuning, which proceeds in fourths and fifths, for instance on the strings of the lyre.⁶⁷ This is the procedure of 'taking through consonance', described by Aristoxenus as the basis for establishing the ditone with precision, and adopted for the enharmonic ditone in the pseudo-Euclidean *Division of the Canon*.⁶⁸ So we learn that when Aristoxenus insisted on the harsh 'Pythagorean' ditone instead of some 'sweeter' interval,⁶⁹ he was apparently backed by a tradition that dominated at the time when the notation of the *mésē* of the third scale was determined.

Secondly, the notation was taken as indicating definite relative pitches. This is only possible if the shades of the genera with different sizes of tones and semitones are entirely disregarded. Such a conception is compatible with the canonical enumeration of the genera, which speaks only of tones, semitones and quartertones, but not with the various tunings given by Aristoxenus as well as by several Pythagoreanising theorists from Archytas until Ptolemy.⁷⁰ A similar view is attested for the circles of pre-Aristoxe-

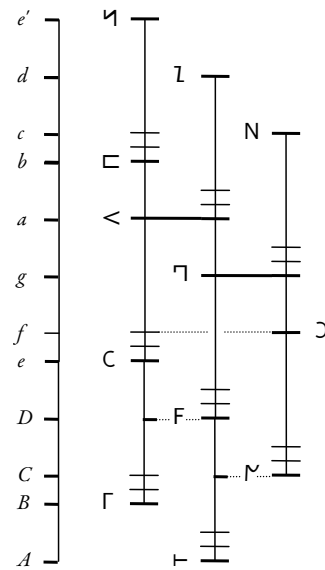

Diagram 5 The three-scale stage of the notation

⁶⁶ Accidentally, the Dorian *mésē* and the Lydian *enarmónios mesón* fall together also in one of the pre-Aristoxenian systems, which operates rather with three-quartertone *pykná* (cf. Diagram 92 on p. 380 below); but as a consequence, other crucial connections between the scales are broken.

⁶⁷ For the 'Pythagorean' diatonic tuning procedure as the basis of every kind of Greek heptatony cf. Franklin 2002b; 2002a, esp. 443; with a modified historical model in Franklin 2006a; 2006b.

⁶⁸ Aristox., *Harm.* 1.24, p. 31.1; 2.55–6, p. 68.15–70.6; *Sect. can.* 17, p. 162.1–12.

⁶⁹ Aristox., *Harm.* 1.23, p. 29.14–30.5. Cf. below, pp. 143 ff.; pp. 413 ff.

⁷⁰ For this 'standard definition', cf., apart from the musical treatises, e.g. Procl., in *Tim.* 191de, 2.168.14–20 (in spite of 'Pythagorean' reservations about semitones and quartertones), the melodic intervals cited in Dionys. Hal., *Comp. verb.* 11.63–4; Plut., *De E ap. Delph.* 389ef; *De defectu orac.*

nian ‘harmonicists’, especially those who set out to measure the tonal space by a grid of quartertones.⁷¹ Still it must be stressed that the notation offers no such grid, but merely the musically relevant part of it, arranged in a musically meaningful way. But the attitude towards the genera and intervals is related, and it is definitely non-Pythagorean.

A look at Diagram 5 shows that the *mésē* is not the only note of the third scale that it was possible to notate by reverted basic signs of the first one. In a similar way its *nētē* N could have been written as \sqsupset and its *hypátē* \mathcal{M} as \sqsupset . How to account for this divergence? It seems that the two signs in question are actually older than the conception of the third scale, both being part of the frame of fixed notes that constitutes the second one. This is obvious for the *nētē* N, which originated as the *nētē synēmménōn* of the second scale, before this modulation to the *synēmménōn* tetrachord could eventually lead to the conception of the third scale. Similarly we have already found some reason to assume that the note \mathcal{M} originally stood for the *hyperypátē* of the second scale, that constituent note of Aristides’ ancient Dorian and Phrygian, which later dropped out of the regularised Perfect System.⁷² If this is true, and *hyperypátē* was introduced into the notation in its two-scale state, its sign would of course have been used for the *hypátē* of the third scale also, the two being identical in pitch. Still, there is another possibility. If the lowest tetrachords came later than the third scale, there simply was not yet a note \sqsupset with which to identify the new *hypátē*. In this case, \mathcal{M} might have been adopted as a modified Y indicating ‘ὑπόατη’.⁷³ We are not in a position to decide between the alternative explanations; nevertheless it has become clear that the divergence between the central note being notated by a reverted sign and the outermost notes being not poses no serious problem.

436a; Sext. Emp., *adv. Math.* 6.47 (standard intervals in spite of the enumeration of shades in 6.51); see also below, p. 152 with n. 39.

⁷¹ Cf. Barker 2007: 33–104; also, Barker 1978a; Wallace 1995; below, pp. 371 ff.

⁷² It was then either conceived – correctly – as a modulation, even if inherent in some, hence irregular, scales (so obviously in Aristoxenus’ system of *synékheia*, constitutive fifth/fourth relations), or commonly (mis)understood as identical to the (diatonic) *likhanós hypatón*, which it is more likely not: while it seems that the *hyperypátē* sits by definition a perfect fifth below *mésē*, the *likhanós* does not; its position varies with the shade of the tuning. Cf. Hagel 2000: 89–93 with n. 139; for the musical significance of the perfect fifth, see also Hagel 2005b: 302–5.

⁷³ Cf. West 1992a: 42 n. 78. The modification of the sign form may have taken place only later when a triplet was required at that position.

THE INTRODUCTION OF *TÓNOI*

In more or less this way a three-scale system was established, following the direction of modulation that was traditionally used in music-making: that to the scale situated a fifth below, which is reached by modulation into the *synēmménon* tetrachord, as well as later by building a *pyknón* over the *hyperypátē*.⁷⁴ Originally, as we have seen, melodies of different modalities were notated in the basic scale. At the same time, however, the conception of a fixed relation of *tónoi* evolved, inspired especially by the development of polymodal auloi. Most probably it started with Dorian and Phrygian, whose relative distance of one tone, easily understood from the Aristides scales, was universally acknowledged.⁷⁵ Soon Lydian joined the pair, being put another tone above Phrygian: the stage of “those composing in three *tónoi*” was reached. At this point the identification between the *tónoi* and the three scales, or keys, of the notation became inevitable. Melodies that modulated between the three *tónoi* had to use all three scales, so that Dorian was necessarily notated in the lowest one, while the highest scale became associated with Lydian. The evolution of the notation had followed the principles of Greek musical scales and melodies up to a point where the mapping of *tónoi* onto the resulting system came about naturally: there was never any question of making Dorian the central key.

The further evolution of the *tónoi* was easily incorporated. Besides Dorian, Phrygian and Lydian, the established set of signs covered Hypophrygian and Hypodorian, as well. Only for Hypolydian an additional triplet had to be inserted, to fill the gap between C and ♯. Its basic shape K is still among those with an opening to the right;⁷⁶ but we can hardly base any chronological speculation on its appearance. Nor is it certain that this sign only came late. The modulation caused by adding a disjunctive whole tone from the *hypátē* – i.e. treating *hypátē* as the *mésē* of the modulating scale – could have occurred early, and been incorporated as an alternative without yet conceiving a full modulating scale.⁷⁷ Still, the triplet based on K was very probably introduced after the sign ♯: otherwise it would have been

⁷⁴ Cf. the modulation technique in the First Delphic Paean, Hagel 2000: 58–70.

⁷⁵ Cf. Hagel 2000: 170–1.

⁷⁶ Bataille (1961: 18) not implausibly regards it as another variation of <.

⁷⁷ Cf. the modulating tuning of the eleven-stringed cithara as proposed by Gevaert 1881: 260–2, and again by West 1992a: 26–7 (cf. also Comotti 1972).

possible to notate the pitch of the latter as λ , just as the ‘Dorian’ *mésē* was equated with ζ .⁷⁸

Similarly we cannot know at which stage the ‘Dorian’ lowest tetrachord was added. We are told that the notes of the *hypaton* tetrachord were not used in Dorian melodies by the ‘ancients’;⁷⁹ but can we apply this piece of information to the notation also? In any case, the sign for ‘Dorian’ *hypatē hypatōn* E is clearly more cumbersome to write than all that we have encountered so far. If we arrange the note signs according to how quickly they are drawn, starting with the simplest and most ancient specimens, E is ordered even after K, followed only by the even lower H (with ‘accidentals’ HH). This does not prove its lateness; but we should beware of assuming a shape like E to be early just because it resembles a letter nicely.

From the complete set of scales the signs can be extracted in their order of pitch. If this is done, their respective pitch equivalences give a diatonic scale, and can therefore be transcribed by the natural notes of our modern system (as long as absolute pitch is not intended). This fact has led to the almost universal belief that the architects of the ancient notation started from this diatonic scale, to take each of its steps as the basis for a *pyknōn*.⁸⁰ Nevertheless one was also aware of the serious problems posed by this view.

First of all, it seems more than strange that the scale that underlies the whole system does not appear as such. The diatonic semitones of the individual scales are expressed by the basic and the rotated signs of the triplets even where they are identical to those of the supposed underlying scale, and even in the ‘Hypolydian’, where the identity extends to the whole scale. The diatonic tetrachord above Γ , for instance, is not written as ΓMFC , although the relations between these notes would give the desired sequence of a semitone followed by two tones, but as ΓLFC . If one started from diatonic as the norm, obviously regarding its semitone steps as structurally on the same level as the whole tones, why should one arrive at a system in which the diatonic semitone steps are regarded as vague raisings of their lower counterpart, as implied by notating them in the same way as the quartertones of the enharmonic?

⁷⁸ Admittedly, we cannot presently exclude that this pitch was originally designated by λ , i.e. before further modulation required the start of a new triplet at this point. In due course, however, we shall see that Γ was not later than K.

⁷⁹ Ps.-Plut., *Mus.* 1137d; cf. n. 64 on p. 23 above.

⁸⁰ E.g. Bellermann 1847: 43–6 (“ursprüngliche diatonische Scale”); Fortlage 1847: 61 etc. (“Schlüssel-scala”); Henderson 1957: 359ff.; Barbour 1960: 7; Chailley 1967 (“échelle de base”); 1979: 126 (“degrés-repère”); *AGM*: 262; West 1992a: 41.

Secondly, the equation of the ‘Dorian’ *mésē* with the enharmonic ‘Lydian’ *likhanós* betrayed pre-Aristoxenian thinking in a rigid scheme of equally tempered quartertones. This is hardly compatible with the identification of the diatonic semitone and the enharmonic quartertone.⁸¹ Our explanation, which builds on an enharmonic model from the beginning, can avoid this particular problem, e.g. by attributing the diatonic interpretation to a comparatively late stage (but we shall see below, that such an assumption is not necessary); with an exclusively diatonic start, it remains a conundrum.

Finally, the series of signs adopted for the alleged original diatonic scale has firmly resisted any attempt to explain it. Only with our model of gradual expansion in ambitus and tonal space could the signs be accounted for as shapes chosen for maximum clarity and simplicity, with the adoption of increasingly complicated forms only when this was inevitable.

The modern misunderstanding is, however, more than natural. Both the process of modulation and the establishment of a (‘Pythagorean’) diatonic tuning proceed in alternating fifths and fourths, and lead to an identical structure of tones and semitones. An unreasonable fixation on cyclical ‘tunings’ instead of modulating scales – effectively, on the lyre instead of the aulos – led researchers in the wrong direction.

The reader will have noticed that we had to regard the Lydian scale as the original and therefore ‘natural’ one in our reconstruction of the history of notation, whereas Hypolydian appears as the natural key of the developed system on systematic grounds. This is because of the adoption of the ‘Hypolydian’ note K. Without this note, the Lydian *mésē* can be transcribed as the central note of the system, i.e. as our note $a = LA$. But once the K is inserted it defines, together with C, F and \mathcal{N} , a sequence of three whole tones. Such a sequence is unique in the diatonic octave, and it fixes the central $a = LA$ to the Hypolydian *mésē* C ($a = LA$ is one but highest in the sequence $f-g-a-b = FA-SOL-LA-SI$). The implications can easily be gathered from the two rows of modern note names in Diagram 6. The fact that the Hypolydian *mésē* is the only note of identical appearance in both systems, by assimilation of an original vocal sign Σ to the lunate form C, without doubt supported its perception as a central note as a considerable psycho-

⁸¹ The reference to the tunings of Archytas, in which the lowest intervals in the tetrachord are indeed equal, does not help: the paradigm behind the notation is definitely non-Pythagorean. Even if Archytas’ scheme reflects some musical fact it can hardly be assumed that the small diatonic interval was ever described as a quartertone: it appears as the semitone-sized *leimma* in Plato and its knowledge is presupposed by Archytas himself (cf. below, p. 178 with n. 117). On the contrary, I regard it as more plausible that Archytas was inspired by the notation; cf. below, pp. 171ff.

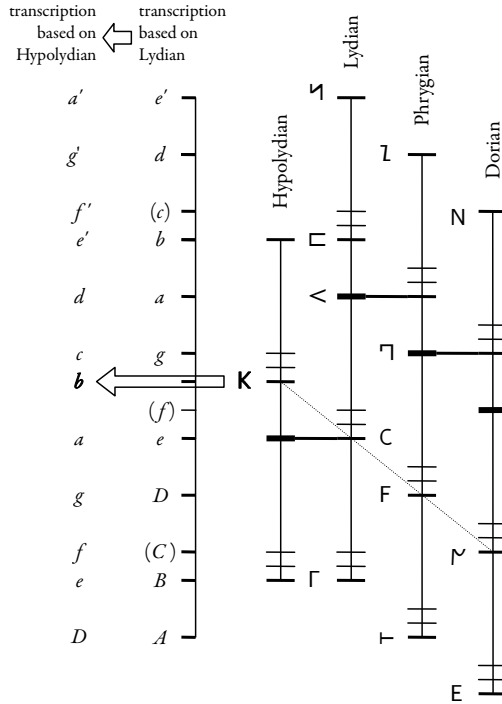

Diagram 6 The shift of the 'natural' scale to Hypolydian

logical factor (although no argument can be based on this coincidence: the vocal notation is clearly older than the lunate sigma).⁸²

VOCAL NOTATION

The invention of the simplified signs of the vocal series must have taken place at approximately the stage that is presented in Diagram 6.⁸³ It is enticing

⁸² The misleading inference of an underlying diatonic scale was also bolstered by this coincidence (Bataille 1961: 15–16; Chailley 1967: 204; 212–13). But the earlier form Σ, although never attested, is implied by the reverted or rotated form 3, found in the low range of the series; cf. Winnington-Ingram 1978: 240–1. Unlike the shapes of the instrumental notes, the transparent letters of the vocal series naturally evolved together with the alphabet; cf. the usual Z instead of original I, which has been postulated in accordance with the letter form generally used until the third century bc (Winnington-Ingram 1978: 239–40; West 1992a: 42; note however that epigraphic evidence tells little about bookhands).

ing to assume that the first three letters ΑΒΓ had originally been mapped onto the triplet of *nētai*. Thus the starting point of the alphabet would find a natural explanation as the original highest note of the system, which had remained constant, much unlike the ever-expanding lower end. If this hypothesis of an originally different highest vocal triplet is correct, the vocal notation would have been devised before the introduction of the *hyperbolaion* tetrachords, and thus date back well into the fifth century. Such an early date would be confirmed by the *Orestes* papyrus, already written in vocal notation.⁸⁴ Still, the implication of a subsequent re-mapping of the letters Α and Β to new pitches for the sake of an unbroken system is highly problematic; the considerable practical disadvantages of such a change within a living musical tradition would certainly more than outweigh the purely aesthetical gain. We will come across an alternative explanation for the starting point of the vocal alphabet in a later chapter. In any case, the letters of the alphabet were assigned to the ‘instrumental’ signs one by one, from a well-defined highest towards a less well-defined lowest pitch,⁸⁵ first in their usual shape, then in inverted or distorted form (cf. Diagram 7).⁸⁶

When new note signs were needed for the *hyperbolaion* tetrachords, the vocal notation may already have taken the lead. The last six letters of the alphabet, modified in the same way as those below the alphabet in normal form, were used to designate the two new *pykná* (if the sequence ΑΒΓ did not form a *pyknón* from the outset, this was the point when it was normalised into one). For the Phrygian and Lydian *nētai hyperbolaíōn*, however, a new device of octave strokes was invented.⁸⁷ Does this indicate that one

⁸³ Mathiesen (2007: 319) insinuates that the connection between the alphabet and the lowest and highest notes of the aulos made in Aristot., *Met.* 1093b, could be understood in terms of the vocal notation. He does not make clear, and I fail to understand, how this should work out in detail.

⁸⁴ It is, however, possible that an original score in ‘instrumental’ notation was transcribed later into the format the actors were then accustomed to. But even several generations after the papyrus was written it was obviously regarded as not unnatural to inscribe a vocal composition in ‘instrumental’ notation; cf. below on the Limenios Paean, *DAGM* № 21.

⁸⁵ Consequently the notation cannot serve as an argument for the Greeks conceiving of their scales as ‘descending’; cf. Hagel 2005b: 299–300.

⁸⁶ It may be worth observing that the musical documents do not support the hypothesis that the vocal alphabet was applied to the central range of the voice: only 3206 of the extant ancient notes fall within the range from Α–Ω, comprising an octave plus a *pyknón*, the mere octave from Υ–Φ holds 3356 notes (+4.7%), and the octave plus tone from Θ–Φ, 3431 (+7.0%). The data accord better with the view that the alphabet started from a given highest pitch.

⁸⁷ The octave strokes are similar in form to the acute accent (ὀξεῖα, ‘high tone’) and have been or become associated with it semantically, as well: while the terminology of the note tables is ἐπὶ τὴν δέξυτητα (Alypius throughout, Gaud. 23, p. 352–5), Gaudentius describes the addition of the strokes as ὀξεῖος προσθέντες, ‘adding acutes’ (21, p. 350.5–9), and the notes with octave strokes appear as the ‘high’ or ‘acute’ variants of their basic forms in the *koiné hormasia* (*DAM* № 6, e.g. “ὀξεῖα μέση”).

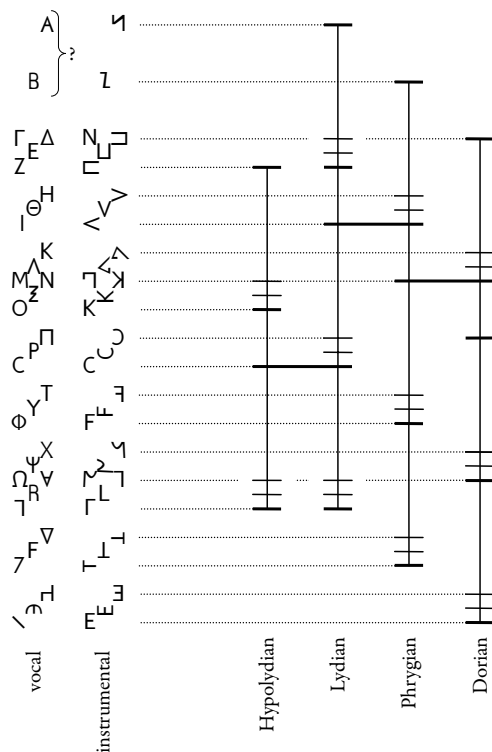

Diagram 7 The invention of the vocal notation

was already short of letters? If so, the lower part of the system would already have included the Hypophrygian and Hypodorian *hýpaton* tetrachords, down to the note 3, so that only the letters from \perp to \cup were still available. As we have already stated, this late stage of downwards expansion was originally conceived in the vocal notation, as the adoption of the vocal sign \exists as instrumental Ξ indicates.

But the assumption that the octave strokes were merely just another way of creating new signs, when the traditional resources were exhausted, is dangerous, especially because it fails to appreciate the fundamental difference. When the alphabetic series was extended, in both directions, by inverting and distorting the letters, this was done without any regard to a possible functional relation between different forms of the same letter: there is an interval of a ninth between Φ and Θ , for instance, similarly between Z and \exists , while Γ and \perp do not even appear together within any *tónos*.

The octave strokes, on the other hand, disclose an entirely different conception, the conscious application of functional equivalence between similar notes in different octaves. This is all the more remarkable, because this kind of equivalence was not expressed in the terminology of the note names, based on the Perfect System. Thus it becomes probable that the octave strokes derive immediately from musical practice, for instance from the technique of playing harmonics on the lyre.⁸⁸ In this case, their invention could be quite early. Why they start only with $O' K'$, is easily explained: all triplet-basic notes below were already part of the notation in its earliest stages. Admittedly, it would have been possible to notate the newly created *pykná* above instrumental \perp and \mathfrak{M} with octave strokes; but such mixed triplets of the form $\dagger \perp \perp' \mathfrak{E}'$ and $\dagger \mathfrak{M} \cup' \mathfrak{D}'$ had nothing to recommend them. Thus, six closely related instrumental signs were devised instead, expanding the old graphic $N \perp \mathfrak{M}$ triplet to the three *pykná* $N \wedge \setminus$ $L \wedge \setminus$ $\mathfrak{M} \wedge \setminus$.⁸⁹ In vocal notation, this range was filled with inverted letters, adjoining the end of the alphabet to its start, just as its start had been adjoined to its end in the lower region: $\Gamma B A$ $\cup \wedge \mathfrak{X}$ $\ominus \wedge \perp$.

This stage, with keys from Hypolydian to Dorian and an ambitus from \perp / \setminus down to at most $\mathfrak{Z} / \mathfrak{E}$ is perhaps a good approximation to the notation as it was developed by musicians without all too far-reaching systematic ambitions. But it was well suited for being taken over and expanded to incorporate the eventually developed canonical relationships of *tónoi*. Since Hypodorian and Hypophrygian merely reuse the tonal material of their adjacent scales, six out of the seven keys reported for those “composing in seven *tónoi*” are already available. The remaining Mixolydian poses a special problem. Its structure as a modal scale is reported by Aristides as well; but probably it had no such canonical correlations to the other scales as were established between these by traditional types of modulation. The two pre-Aristoxenian schools did not agree about how to insert the Mixolydian into the system of *tónoi*.⁹⁰ Thus it appears that the ‘Mixolydian’ enjoyed quite a

⁸⁸ So already Gevaert 1881: 637; Jan 1895: 422–3. For techniques of obtaining harmonics on a lyre, cf. Lawson 2005: 110; for ancient evidence for lyre harmonics, cf. *AGM*: 66; 69; 341–2; Franklin 2005: 12.

⁸⁹ For the distribution of the shapes see Winnington-Ingram 1978: 241–8.

⁹⁰ The two schools generally consent about the order of the scales, but not in every case about the intervals between them (cf. below, pp. 379 ff.). But whereas the ‘first’ pre-Aristoxenian system links the Mixolydian to the rest of the scales by identifying its typical note between the two *pykná* — the *mésē* according to old analysis — with the lowest note of the (Syntono-)Lydian, the ‘second’ school sets its lowest and highest notes to the same pitch as the Dorian *hypátē* and *nētē*, and the basic note of its higher *pyknón* to the Dorian *mésē*.

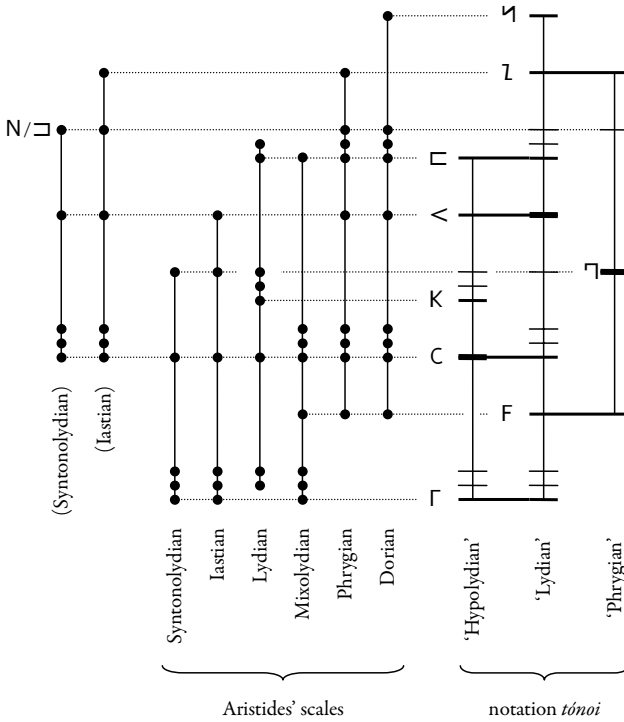

Diagram 8 The notation of Aristides' ancient scales

detached musical tradition, to be forced into one scheme with the other scales only by theoretical efforts. Hence, we should not expect to find it reflected in a system so much oriented towards the reality of music as the early notation. There can be little doubt the note signs could be used for Mixolydian melodies, too. But as there was no canonical relationship to other scales, most probably the natural 'Lydian' series was employed for Mixolydian music. In any case, the system of notation as reconstructed so far accounts for all keys whose names are agreed between Aristoxenus and the fully developed fifteen-key notation. Moreover, all of these are attested for an earlier time as well. They can therefore safely be assumed to constitute the tonal *koiné* of late classical music, untainted by any theoretical speculations that precede, and ultimately lead to Aristoxenus' unified *diágramma polytropa*.

A COMMON TOP NOTE

At this point it will be profitable to examine the connection between the system of notation and Aristides' modal scales more closely. From Diagram 8 it becomes clear in which way the notated form of these scales as found in Aristides is oriented towards the 'Lydian' and 'Hypolydian' as the natural scales. Dorian, Phrygian and Mixolydian are plainly written in the 'Lydian' key, which we reconstructed as the original one. Curiously enough, what Aristides calls 'Lydian' is not. Yet this scale is suspected not to stem from the same early source as the rest. Unlike the others, it is regular in form and identical to an enharmonic 'octave species', and interestingly to the Hypolydian.⁹¹ The enharmonic octave species are a construction of pre-Aristoxenian theory; and there are some indications that Aristides' 'Lydian' might be identical with the 'slack Lydian' of the fifth-century theorist Damon, which later came to be known as Hypolydian, or perhaps merged with a scale known under this name. Its notation in the 'Hypolydian' *tónos* seems therefore justified historically. On the other hand, it can quite as well be explained synchronically: the notation in the 'Lydian' key would have required a *l*, thus going beyond *néēē* ♯ into the realm of signs which are obviously secondary.

Aristides' Syntonolydian, which corresponds to the true Lydian scale, is notated in the Lydian key, and so is Iastian.⁹² The two share the irregular degree ♯, the note for which is the 'Phrygian' *mésē*, here corresponding to a diatonic note in enharmonic environment. Although the form of the two scales accords with the conventions followed throughout, it is interesting that they are not notated at a high pitch; after all, it is startling that the only scale with an explicit designation 'Syntono-', i.e. 'high', occupies the lowest range of all.⁹³ One fourth higher the Syntonolydian would take the form C U > < N, and Iastian would appear as C U > < N I (cf. the bracketed version in Diagram 8). The Phrygian scale shows that there would be no objection to L. The N, however, does not appear in the Greater Perfect System of the 'Lydian' *tónos* (as ♯ does), but only in the *synēmménon* tetrachord. Alternatively, though, the enharmonic environment would allow writing the

⁹¹ For the following cf. Winnington-Ingram 1936: 24–5; Barker 1982a; *AGM*: 227–8; below, pp. 373ff. For the identification of the Hypolydian and Lydian, see also Hagel 2000: 174–7; below 434.

⁹² Although these scales include the 'Hypolydian' *mésē*, and although all their notes except for the ♯ also occur in both keys, the presence of the ♯ instead of the 'Hypolydian' ♯ with identical pitch would make no sense in 'Hypolydian'.

⁹³ Henderson 1942: 94.

same pitch as \square (two quartertones above \square instead of one tone below \square); this was perhaps avoided with a view to the protean nature of the *pyknón*. Thus the paradigm behind the transcriptions becomes evident: \square is not perceived as *nētē synēmménōn*, but as a diatonic note, just as is \square . Indeed the *synēmménōn* tetrachord remains out of consideration, and all scales are notated within the basic ‘Lydian’ key, up to its *nētē* \square . Where this was impossible, namely in the case of the so-called Lydian scale – which in fact was the traditional Hypolydian octave, the ‘Hypolydian’ *tónos* was used.

Such a conception does not support the assumption that all of Aristides’ scales were transmitted in their notated form from an early time, when the coexistence of conjunct and disjunct tetrachords was one of the main ideas of musical thought. It is more compatible with a Roman Imperial viewpoint that maintained merely an awareness of ‘Lydian’ as the natural key (together with Hypolydian as its lower satellite *tónos*).

All the more we must wonder whether the modal Dorian, Phrygian and Lydian scales came to be notated in their homonymous keys, once the latter had received the names of the former. If they are (we have again to take Aristides’ Syntonolydian as the true forerunner of the Lydian *tónos*), the surprising symmetry of Diagram 9 emerges: the highest notes of all three scales fall on the same pitch. At first one might regard this as a mere coincidence (if an extraordinary one), which became a structural target only later, when theorists tried to define a coherent system of modulating *tónoi*: both pre-Aristoxenian approaches are evidently oriented towards packing their highest notes as closely as possible.⁹⁴ But even more surprisingly, we find that the highest notes of all three scales correspond quite straightforwardly to the (basic) sign N for *nētē*. Can this be just another coincidence? The identification of two *nētai*, at least, is musically relevant. The *nētē diezeugménōn*, allegedly introduced by Terpander, was called the ‘Dorian *nētē*’:⁹⁵ here we find it in the Dorian *tónos*. The *nētē synēmménōn* was obviously no less typical for Phrygian music:⁹⁶ here it is present as the

⁹⁴ Hagel 2000: 171–2; below, pp. 379 ff. (the present structure is, however, closely related only with the first pre-Aristoxenian system, with which the notation shares the focus on musically relevant modulations). Only these arrangements provide a possible explanation of the term ‘Syntonolydian’ within the scope of our evidence: due to its relatively restricted ambitus it consists of primarily high notes once the top notes of the scales are equated.

⁹⁵ Ps.-Plut., *Mus.* 1140f; cf. ps.-Aristot. *Pr.* 19.32; Plut., *Apophth. Lac.* 238c.

⁹⁶ Ps.-Plut., *Mus.* 1137d; cf. the use of this note to indicate Phrygian modality in the First Delphic Paeon; cf. Hagel 2000: 40–2. Cf. also Hagel 2005a: 84 with n. 94. Perhaps the cosmic harmony cited by Pliny, *NH* 2.84, and Lydus, *Mens.* 2.3, p. 20, also belongs here (cf. Burkert 1961: 36). Although in both sources an entire system of seven correlations is envisaged, Lydus cites only Dorian, Phrygian and Lydian, and Pliny only Dorian and Phrygian; and while Lydus’ “moving in Dorian etc. r h y t h m” makes no sense unless understood in a very wide sense of the word (similarly, Lydus uses

highest note of the Phrygian scale set to the Phrygian key. Aristides' Syntonolydian seems to indicate that there was some kind of 'Lydian *nētē*' also – which did not, however, correspond to any *nētē* of the Unmodulating System.

The coincidence of the sign N with the common highest note of the three scales might be taken as an argument that the notation was originally conceived for precisely this triad of scales. But this cannot be true. The notation of the 'Dorian' key, with its *mésē* written as an accidental, proves that the three are not coeval. Moreover the set of signs cannot be explained on the grounds of such an assumption, especially because one is missing out of those three that we have identified as structurally primary. Finally, the primary state of the 'Lydian' key, including its higher part, also documented by the *Orestes* fragment, similarly excludes such an origin.

On the other hand, one might argue that the final adoption of the shape N in exactly this position was perhaps influenced by a diagram like ours. We have seen that, although it is virtually certain that the three forms of the letter N were implemented for the three *nētai* as abbreviations of the note name, our reconstruction so far would imply an originally reverse order, with the 'natural' N for the 'natural' scale: at an early stage, we could account only for the *nētē diezeugménōn* (N instead of later $\mathfrak{N}?$) and the *nētē synēmménōn* (L). Only a subsequent exchange of the upright forms would have brought the triplet into the same ascending pitch relation as the rest. Once the natural mapping of the *tónoi* onto the keys was recognised, at least as an option, the adoption of such a new order

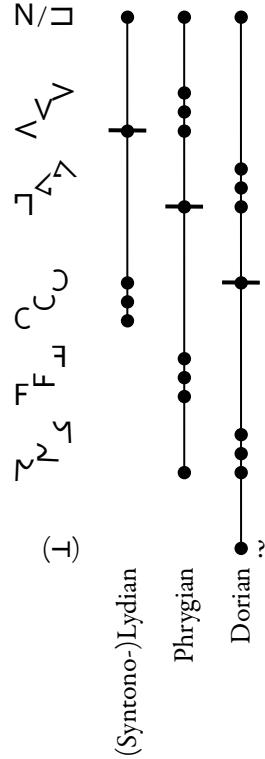

Diagram 9
The Aristides scales set to
their respective *tónoi*

'rhythm' in the context of the vowels associated with the planets: τὸν ᾠ ῥυθμὸν), Pliny definitely refers to a Dorian and a Phrygian "*phthongus*". This Greek term is obviously taken over from his source, which therefore did not speak of octave species or keys, but of notes typical for each mode/species/key. These can hardly have been anything else than the highest notes of the octave species, after the model of the Dorian and the Phrygian (and perhaps the Lydian) *nētē*, conceived in their functional values within the boundaries of a regular (Dorian) scale that extends from Saturn as *nētē* down to the Earth as *hypátē*.

might have been supported by the coincidence of all three *nētai*: it would have seemed odd not to use the basic N for the note that represented all essential *nētai*. Once more, however, we must acknowledge that such a model, seducing as it seems in theory, loses much of its plausibility if its practical implications are taken into consideration: would musicians embrace a change that made all existing scores ambiguous, unless one knew in which way they were written, not to mention the impracticality of switching between different meanings of the same signs when reading them?

Setting the details of their notation aside for the moment: how was it that the three '*nētai*' fell together at all? Such a coincidence can hardly be attributed to pure chance; and indeed, it is ultimately due to the principles that govern the evolution of the Greek tonal system. The whole tone steps, on which all relations are based, result from the relations of fifths and fourths underlying Greek music. Most basically, the two rivalling *nētai* of the Unmodulating System, *nētē diezeugménōn* and *nētē synēmménōn*, are one tone apart, because they lie, by definition, one fifth and one fourth above *mésē*, respectively. Similarly, modulation brought different scales into relations of fifths and fourths. We have seen how the completion of the *synēmménōn* tetrachord to a scale resulted in two similar tonal structures one whole tone apart.

On the other hand, there was a tendency to conceive of differently formed scales as lying within the same gamut. It can be observed in the pre-Aristoxenian efforts to equate the highest notes of the scales as well as in the system of keys and octave species laid out by Ptolemy. Both approaches must have been founded upon musical reality. Singers will have tended to take the scales within their optimal range of voice. Since high vocal notes were apparently more esteemed than low ones,⁹⁷ this led rather to the equation of the upper extremes of the scales, just as reflected in pre-Aristoxenian theory. Lyre players, on the other hand, when tuning their instruments to different scales, could not alter the pitch of the individual strings too much without considerable loss of sound quality. Hence, the scales played by their instruments were also all set to approximately the same pitch range. More often than not, both conditions applied at once, since lyres were typically used for the accompaniment of vocal music.

But the most powerful impetus to a more definite regulation came from the aulos, once virtuoso instruments became suited to play in more than one scale. This has to do with the typical restrictions of playing two separate pipes at once. Since each is fingered with only one hand, it is vital to

⁹⁷ Cf. n. 52 on p. 74.

make use of all five fingers whenever possible. Yet although four fingers can more or less easily change their respective positions on the row of holes on the upper side of the instrument, if one or more holes are closed at the top by other means, the thumb, being confined to its lower side, can not. On the other hand, the boring of more than one thumb hole was incompatible with the mechanism of rotating sleeves, by which the unused holes were closed. Thus – the archaeological record is unequivocal – Greek auloi regularly had only one thumb hole (which was second from the top of the instrument), even if there were more than four finger holes on the upper side. Consequently, the maximum of five holes that could be fingered at once was available only in the highest playing position on each pipe. This inevitably led to a concentration on the higher notes, with the tendency to equate the higher end of the different playable scales. If the strict identification of the upper notes of all scales, as shown by the ‘second’ pre-Aristoxenian school, was rooted in more than pure aesthetics, only the aulos can have given the impulse. Voices and lyre strings are flexible to a certain extent, but not so the highest finger hole of the woodwind instrument. If it is bored for exact intonation in one scale, no similarly exact notes are available in the immediate neighbourhood: those up to about a semitone below would have to be achieved by partially covering the highest hole; notes above it could have been achieved, if at all, only by manipulating the mouthpiece. Neither procedure yields precise results. Thus, the identification of the upper notes of all scales actually became a sort of necessity in the advancing auletic art.

All in all, it is easy to understand how these concurrent conditions ultimately led to an arrangement of scales whose *mésai* were situated one tone apart, while their upper ends were identical. As soon as this principle was acknowledged among practising musicians, the assignment of the basic letter form N to this common highest note is all but reasonable – and even more so, if this relationship was incorporated into the design of modulating auloi. We will come back to these topics later.

NOTATION IN *TÓNOI*

In spite of the evidence of the *Orestes* fragment and the Aristides scales, we have postulated the notation of ‘Dorian’ and ‘Phrygian’ music in the ‘Dorian’ and ‘Phrygian’ keys (in the case of Lydian, a distinction between the

usage of the ‘natural’ and the ‘Lydian’ scale is impossible, of course). This assumption led to fascinating prospects in the reconstruction of early theoretical accounts, and might even have implications on our knowledge about the classical aulos – but are we justified in making it? With little doubt, the persistent identification of the keys of the notation with the *tónoi* alone might be regarded as sufficient proof that it had, at some time, musical relevance. Yet we can get beyond such a general assertion.

To put it briefly, the evidence suggests that there was indeed a tendency to notate music in the ‘appropriate’ key. Nevertheless, the old way of applying the natural scale for music of different modality persisted side by side with the new approach, and finally outlasted it. The decay of the key-specific notation was probably connected with the eventual obsolescence of the clear-cut divisions between the ancient modes in general. Once a clear conception of Dorian music was lost, there was no more sense in rejecting the natural keys in favour of more complicated ones. The (renewed) advance of diatonicism will also have played its role:⁹⁸ here the removed scales, devised in the high time of the enharmonic, were especially ill suited, since all their diatonic notes must be notated by ‘accidentals’.

Still, some of the earlier documents illustrate the employment of the *tónoi* of the notation. In the Zenon Papyrus we find notes that are at home in the Phrygian and Dorian keys.⁹⁹ It is from the third century BC, but too fragmentary even to speculate about its modality. The few notes found on a Hibeh Papyrus date to about the same time, and apparently belong to a similar range of keys.¹⁰⁰ In a Vienna Papyrus from the third or second century BC, a section that uses notes from the Phrygian key is expressly labelled as ‘Phrygian’.¹⁰¹ Again, the few preserved notes concede no insights into the modal structure. The Ashmolean Papyri, from about the same period, once more provide notes belonging mostly to the Phrygian-Dorian complex.¹⁰² Little can be gleaned from the short fragments of melody; but it may be significant that the highest note is vocal Γ, corresponding to instrumental N, which is also the highest note of the combined scheme represented by Diagram 9. In the neighbourhood of Π, the Dorian *mésē*, it could be interpreted as the Dorian *nētē*.¹⁰³ But often it is found, with or without

⁹⁸ Cf. Gaud. 6, p. 331.27–332.3.

⁹⁹ Pap. Zenon 59533 (*DAGM* № 8); cf. also Hagel 2000: 103–5.

¹⁰⁰ Pap. Hibeh 231 (*DAGM* № 7); West 1992a: 2–4.

¹⁰¹ Pap. Vienna G 29 825a/b (*DAGM* № 9).

¹⁰² Pap. Ashmolean inv. 89B (*DAGM* № 5 and 6).

¹⁰³ *DAGM* № 6, fr. 15.i.4; fr. 43.2.

The evolution of ancient Greek musical notation

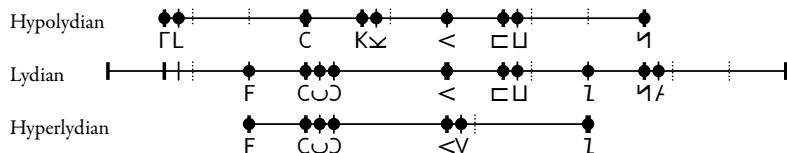

Diagram 10 The tonal material of Limenios' paeon

Π, in the context of non-Dorian Υ.¹⁰⁴ Thus we would reckon rather with an underlying Hypodorian.

More can be inferred from the virtually complete two sections of the First Delphic Paeon, which was performed, presumably for the first time, at the occasion of the Athenian Pythais in 128/7 BC.¹⁰⁵ Here the emphasis on *nētē synēmménōn* within an otherwise entirely non-diatonic composition points to Phrygian modality.¹⁰⁶ And indeed the melody is notated in the Phrygian key, with much modulation into the *synēmménōn* tetrachord in the second section. Especially interesting is a comparison with the Second Paeon, which was composed by the citharist Limenios, either for the same occasion, or perhaps for a similar festival in 106/5.¹⁰⁷ The initial section of both pieces seems to follow a traditional musical programme, which dictated, for instance, the way of introducing the *synēmménōn* modulation. But whereas the First Paeon is inscribed in the usual vocal notation, Limenios chose to use the instrumental signs, presumably because he was himself an instrumentalist. And obviously he did not care about *tónos* names: although his composition has so much in common with the First Paeon, Limenios employed the natural, 'Lydian', triad of scales (cf. Diagram 10).¹⁰⁸ Perhaps these different approaches reflect the typical usage of the two types of notation. When the conception of *tónoi* was introduced into the notation, it would not easily overturn the traditions that were connected with the instrumental signs. The young vocal notation, on the other hand, could readily adopt the novel approach, especially as its straightforward alphabetical design obscured the substructure of triplets, and therefore also the primacy of the 'Lydian' triad.

¹⁰⁴ *DAGM* N^o 6, fr. 28; fr. 45.3; cf. also fr. 15.i.3–5.

¹⁰⁵ *DAGM* N^o 20.

¹⁰⁶ Cf. Hagel 2000: 39–42.

¹⁰⁷ *DAGM* N^o 21; for the dating problem cf. Schröder 1999.

¹⁰⁸ The considerations in Hagel 2000: 99–102 have to be modified accordingly: it seems now that it was not the composers who took Aristoxenus' diagram into account, but that Aristoxenus' diagram was so well adapted to musical practice that it was still in good accord with compositions of traditional hue in the late second century BC.

Unfortunately, too few documents from the Hellenistic period are known for a decisive mathematical proof of this hypothesis. If we take the triads (or, for that time, rather dyads, the ‘Hyper-’ scales resulting from later systematisation) together, which makes a clear distinction easier and also seems to reflect the view of the composers,¹⁰⁹ the interpretable scores from this era yield the following distribution:

	Vocal	Instrumental
Lydian	6	5
Phrygian/Dorian	4	0

Although the case might seem clear, it is not mathematically conclusive: there is a one in six chance that we are deceived by (evil) luck.¹¹⁰ In any case, it cannot be doubted that the ‘Lydian’ key was more than the set of notes employed for the notation of Lydian melodies.¹¹¹ Furthermore, it retained its primacy throughout all the time in which the ancient notation was in use, and it seems that this was especially true for the instrumental variety: about half of all fragments in vocal notation use scales of the Lydian triad, but about eighty per cent of those written with instrumental signs. It seems, therefore, that it was primarily the vocal signs that were associated with *tónos*-aware notation.

THE MIXOLYDIAN *TÓNOS*

We have seen that the Mixolydian was not assigned a definite position within the system by musical tradition, but included differently by different harmonic ‘schools’, whose solutions were later merged by Aristoxenus. As a consequence it is likely that these theory-borne ‘Mixolydian’ *tónoi* lacked a practical connection with traditional Mixolydian music; this also explains why their names were so readily given up in favour of the newly invented ‘Hyperian’ and ‘Hyperdorian’ in the system of fifteen keys. Yet the Mixolydian interlude marks out a substantial step in the development of

¹⁰⁹ Cf. *DAGM* № 9, 6, where notes of obviously Hypophrygian affiliation are labelled as ‘Phrygian’ (Hyperlydian would constitute an alternative, as far as we see, but was most probably not yet considered as a key).

¹¹⁰ Fisher’s exact test: $p = 0.154$.

¹¹¹ One would expect more Dorian and Phrygian than Lydian music. But even if, for the sake of the argument, we assume an equal distribution between the three ‘modes’, the prominence of ‘Lydian’ notation with 11 out of 15 fragments from Hellenistic times is highly significant: $p = 0.0018$ (binomial test).

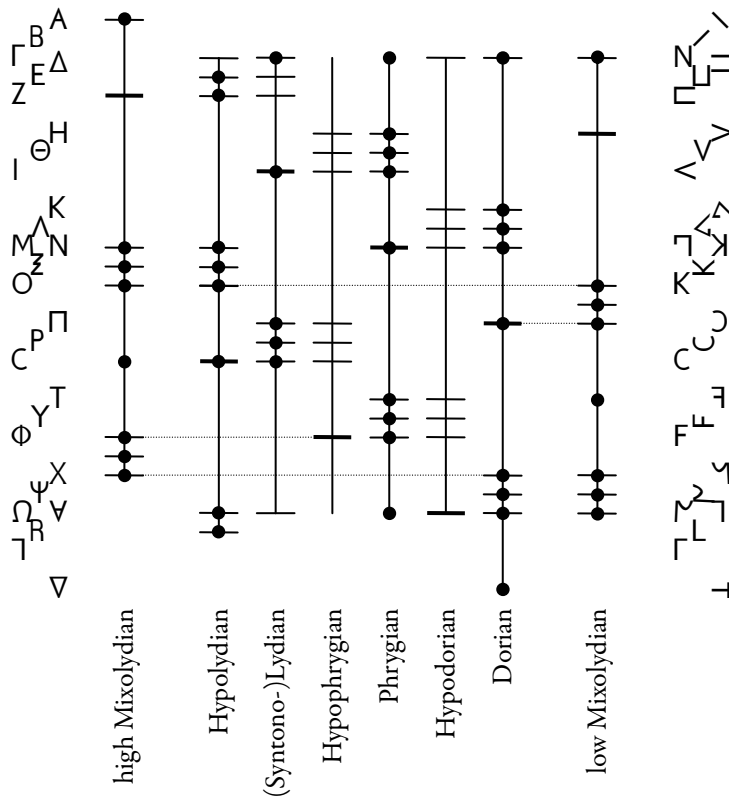
Diagram 11 The system of seven *tónoi*

the notation: the intervention of systematising theory. Ptolemy, who rejects the thirteen scales of Aristoxenus, still clings to the earlier arrangement of seven *tónoi*, including the Mixolydian.

Diagram 11 shows the adoption of this scale as it was conceived in the two rival approaches.¹¹² In the diagram, short lines represent the regular steps of each enharmonic scale, while the small circles indicate the notes which are present in Aristides' modal scales. For Hypolydian, its regular octave species is given, which Aristides lists under the name of Lydian, as

¹¹² For the high variant, cf. Hagel 2000: 172 Abb. 23; for the low one, Bacchius 47, p. 303,7–9; Boeth., *Inst. mus.* 4.15, desc. II. p. 343 add.; Hagel 2000: 178 Abb. 25. For the comparatively late inclusion of the Mixolydian as a *tónos*, Winnington-Ingram 1956: 180 n. 3.

explained above. The tonal structure of hypothetical modal Hypodorian and Hypophrygian scales can only be guessed at.

Although the structure of the old Mixolydian scale is irregular, it is nicely incorporated into the system in both ways, seamlessly extending the circle of fifths in either direction. In the higher variant it becomes the neighbouring scale of the Hypolydian, one fifth above it, with whose *pyknón* the higher Mixolydian *pyknón* falls together, while the irregular note between the two Mixolydian *pykná* corresponds to the Hypolydian *mésē*. In the lower variant, the lower Mixolydian *pyknón* was equated with the lower Dorian one, so that the Mixolydian key comes to lie one fourth above the Dorian.

Thus, the Mixolydian could easily be included within a diagram of tonal relations. Its notation, however, was problematic. The highest note of the higher variant could only be written after there had been created an enharmonic triplet above N – which had to be done anyway to include the *hyperbolaion* tetrachords, which were in use already in the fifth century. In the vocal notation, the highest note of this whole system was then to become A.

The *pykná*, however, posed unprecedented problems in both variants: in each, only one of the two corresponded to a traditional sign triplet, namely $K \sphericalangle \aleph$ in the high, $\text{M} \sphericalangle \text{M}$ in the low Mixolydian. In contrast, the basic notes of the respective remaining *pykná* were identical in pitch not with a basic sign, but with the highest member of a triplet (see Diagram 11). Thus the lower *pyknón* of the high Mixolydian is evidently to be based on the highest note of the triplet belonging to the Dorian *mésón* tetrachord, M . Its highest note, on the other hand, would fall together with the Phrygian *hypátē*, F. Analogously, in the low Mixolydian, the lowest note of the upper *pyknón* is the Dorian *mésē* D , notated with a reverted sign, while its upper note corresponds to the Hypolydian basic note K. In short, whatever approach one adopted, the Mixolydian semitones were easily notated by traditional means. But not so the intermediate quartertone steps. Neither between M and F, nor between D and K was there a note available, nor could it be created within the system, since this would have involved the rotation of an already rotated instrumental sign, or the insertion of a letter between vocal Φ and χ , or O and Π , respectively.

This problem, however, was probably never urgent: theory could do without notation, and notation accounted for all practical needs anyway. An enharmonic Mixolydian tune of the old style would have been notated (if at all) in the natural scale. The ‘Mixolydian’ scales of the *tónoi* systems, on the other hand, were required only when the classical era of enharmonic music was over, and the advance of chromaticism had laid the ground for a new perception of the old tonal structures.

THE CHROMATIC SYSTEM

The new favour for chromatic scales in the modulating music of the later fifth century went hand in hand with the frequent and often rapid modulations into remote scales, for which this avant-garde movement became so infamous among more conservative minds. Modulations were always based ultimately on relations of fifths and fourths (even if these relations became obscured by abrupt movements).¹¹³ But continuous alternations of these intervals – the circle of fifths – result in a grid of semitones. Given the limited number of notes that can be produced by any instrument, a tonal structure which includes a maximum number of semitone steps will always be better suited for extensive modulations than a system with, for instance, quartertones. These facts have led to our tonal system of octaves divided into twelve semitones; a similar evolution seems to have contributed to the decay of Greek enharmonic music. The full set of twelve semitones already underlies Aristoxenus' theory of modulation; and he accounts for modulations between scales of a ny number of semitones apart.¹¹⁴ Moreover, it is implied that even such strange modulations as that between two scales one semitone apart were musical practice; probably the First Delphic Paean provides examples of such a technique.¹¹⁵

Aristoxenus was the first to draw a diagram of the full scalar circle, and to give an account of the principles that ensure its coherence (*synékheia*). Now, for the first time, the puzzling melodic movements of the most famous composers could be described within one consistent structure. Thus, the way was made free for the extension of the notation to the same full cycle. We do not know when this was achieved, since the newly incorporated scales are attested only centuries after Aristoxenus. On the other hand, some of the rules that were applied then must have originated quite early, out of the need to write down the complex melodies of the late fifth century.

In any case, chromaticism was the new paradigm; and just as the traditional half of the notation is based on enharmonic *pykná* of quartertones, its post-Aristoxenian extension is interested only in chromatic *pykná*,

¹¹³ Cf. the presumably traditional procedure exploited by the First Delphic Paean, first to establish the canonical relations only to use the tonal material more freely afterwards: Hagel 2000: 48–51; 58–9; 70–6; and especially 86.

¹¹⁴ Cleonid. 13, p. 205.10–206.2; cf. Hagel 2000: 77–9.

¹¹⁵ Cf. Hagel 2000: 70–6.

which could easily be realised on the basis of a grid of semitones.¹¹⁶ This grid is already implicitly present in the old enharmonic form of the notation, as can be seen in Diagram 7 above (p. 31). The basic signs of the triads form a diatonic scale, the whole tone steps of which are divided by the reverted forms. In this way a series of semitones arises:¹¹⁷

instrumental: ... Ε Ξ Ι Κ Γ Λ Μ Ν Ξ Ο Π Ρ Σ Τ Φ Ψ Ω Χ Φ Τ Σ Π Ο Μ Κ Ι Η Ζ Γ Α ...
 vocal: ... \ ρ 7 ∇ 7 Ω Χ Φ Τ Σ Π Ο Μ Κ Ι Η Ζ Γ Α ...

With the help of such a scale, it is possible to notate music in the diatonic and chromatic genera, which can be measured, in their standard forms, in semitones. At the same time, the old system was not simply given up. On the one hand, we can assume that there was still the need to transmit enharmonic music, even if no new pieces were composed in this genus. On the other, there was already an established tradition of notating chromatic music within the traditional system. For this task, its *pykná* were simply treated as chromatic; as we have seen, Aristoxenus testifies to the lack of a sharp boundary between the two genera previous to his own work. Still, the identification of the ‘Dorian’ *mésē* with the note ∩ demonstrates that, at this stage of development, the quartertone *pyknón* was regarded as the norm. Already at this rather early point the notorious inconsistency of the system as regards the interrelation between signs and pitches was created. If a piece was performed in a tuning with larger *pykná*, a ‘Lydian’ or ‘Hypophrygian’ ∩ was no longer identical with a ‘Dorian’ ∩. When chromatic music gained primacy, this must have led to considerable confusion, especially in modulating music. It was now possible that the interpretation of the notational signs depended on the immediate melodic context. After a plausible phase as a tablature, and a first attempt at a pitch notation, although valid only for the enharmonic genus then dominant, a stage of confusing abstraction was reached. We shall consider the reaction to this rather unpleasant development below.

At first, the new possibilities were exploited that came with chromaticism as a standard. The notation of the high Mixolydian *tónos* can serve us as an example, especially as it displays the complication of the new mixed system very well. As we have seen, this variant of the Mixolydian shares its higher *pyknón* with the Hypolydian. There was therefore no doubt about the notation of this part of the scale. The lowest and the highest notes could be equated, following long-used models, with Χ ∩ and Α ∖, highest

¹¹⁶ Cf. Barbour 1960: 10.

¹¹⁷ The relevance of this series is demonstrated by the respective tables given by Aristides Quintilianus, 1.11, p. 26, and Gaudentius, 22, p. 350.23–352.3 (“τά καθ’ ἡμῖν τόνιον σημεῖα”).

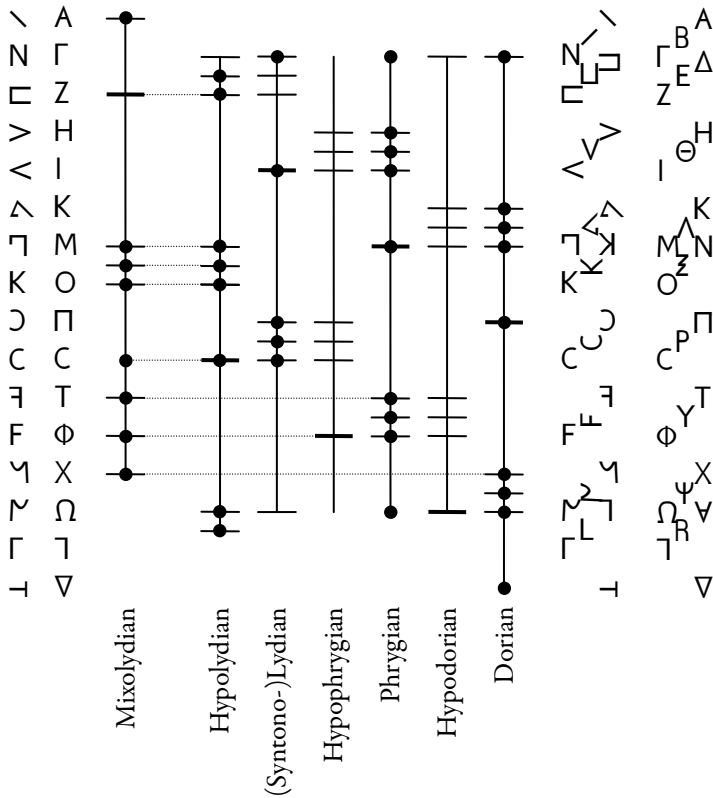

Diagram 12 Chromatic Mixolydian notated

notes of their respective *pykná*, while the irregular note was identical to the Hypolydian *mésē* CC.¹¹⁸

Only the lower *pyknón* could not be incorporated, as long as it was regarded as enharmonic. As a sequence of semitones, however, both of its

¹¹⁸ The assumption is not necessary that, at this stage, the irregular modal scale, as given by Aristides, was still envisaged, however now in its chromatic variant. But there is evidence that at least some of these scales survived the decay of enharmonic music in chromatic form: both the chromatic Phrygian and Dorian are cited as models for the cosmic harmony (Phrygian: Alexander of Ephesus *ap. Theon, Util. math.* 138–41; Censorinus, *de die natali* 13, p. 22.10–24.14; Ach., *Intr. Arat.* 17.2, p. 24–5; Dorian: Pliny, *NH* 2.84; Mart. Cap. 2.169–99, where a semitone wrongly replaces the tone between Sun and Mars; Honorius Augustodunensis, *De imagine mundi* 81–3 (*PL* 172, 140–1); ambiguous: ps.-Probus, in *Verg. Georg.* 1.336–7, *Append. Serv.* 365.6–18, with the necessary emendation of *infra Saturnum to infra Solem* in l. 15. For an overview of ancient cosmic scales see Jan 1894; Reinach 1900; Richter 1999).

notes were found to occupy positions that were already accounted for (cf. Diagram 12). The middle note is thus identical in pitch with the Hypophrygian *mésē* and Phrygian *hypátē* Φ F, while the highest note coincides with Τ ♯, which forms part of the semitone grid as the highest note of the *pyknón* of the Phrygian *hýpaton* tetrachord. Consequently we are facing the paradoxes of the notational system in their extreme form. Firstly, a chromatic note is notated by a sign whose pitch value depends on the enharmonic reading of another scale. Secondly, we find two different ways of notating a *pyknón* combined within a single scale, once as a triplet, evoking enharmonic connotations, and once as a sequence of semitones, which cannot prima facie be interpreted as anything but chromatic. The latter type of combination, which is probably the most perplexing element of the ancient notation in its developed form, occurs only at those points where the old and the new approaches meet: in the two variants of the Mixolydian, which came later to be known as Hyperian and Hyperdorian respectively.

The same orientation towards the semitone grid also enabled the notation of all the scales that were introduced by Aristoxenus – only these were now purely chromatic, not containing any of the old triplets.¹¹⁹ As a result, the system now consisted of two areas, based on entirely different principles. The pre-Aristoxenian enharmonic section, represented to the right in the present diagrams, comprises six scales, two of which are reduplicated at the octave in the final fifteen-key variant; the post-Aristoxenian chromatic section consists of four keys, one of them doubled at the octave, plus the two ‘mixed’ keys at the boundaries, making a total of six, as well. The implications can be gathered from Diagram 13, where the keys and portions of keys notated according to the older and the younger system are separated by undulating dotted lines. Grey horizontal lines indicate how the top notes of enharmonic triplets become part of the semitone grid, fixed in (relative) pitch. The former are consequently listed to the right, while two rows at the left give the subset of note signs used for the ‘chromatic’ keys. The vocal notes always stand to the right of their instrumental counterparts.

It is, of course, entirely improbable that any of the new scales was ever used to write down enharmonic music. Not only were these designed as chromatic from the outset; they were also simply too late. Being devised by Aristoxenus, and therefore included within the notation not before 300 BC, perhaps much later, they were at the composers’ disposal only at a time

¹¹⁹ Cf. Winnington-Ingram 1956: 179–80.

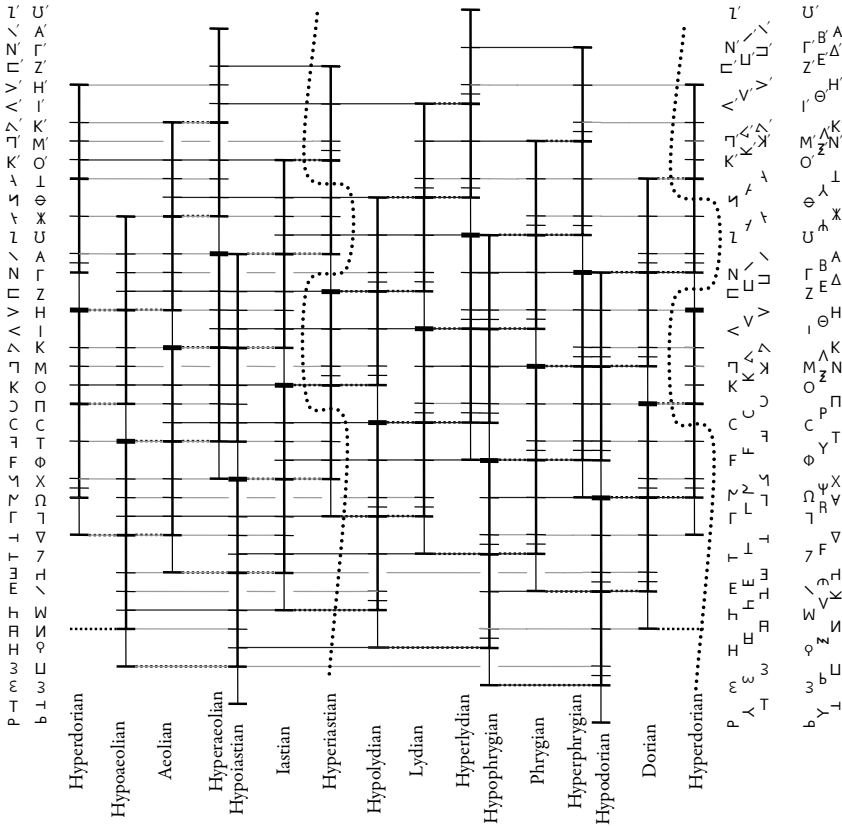

Diagram 13 The notational system as consisting of an enharmonic and a chromatic half

when enharmonic music was, by and large, history.¹²⁰ Still, Alypius' tables also contained enharmonic variants of those late keys. Obviously these are conceived out of a (misguided) sense for completeness and symmetry; to 'create' them, the chromatic series was simply copied under a different heading, just as it was – rightly – for the older keys.

In Diagram 13, not only the *pykná*, but also the typical diatonic notes are included. It is easily seen how these always correspond to standing notes from adjacent keys. The manner of notating the lower movable diatonic note by using the same sign as for the lower movable note of the *pyknón*,

¹²⁰ For references to enharmonic performances (presumably of classical music) up until the Roman period, cf. *AGM*: 165–6.

regardless of the actual interval size, is especially appropriate within the late scales: here this note is obviously located a semitone above the lowest note of the tetrachord, just as in the standard definition of the diatonic genus.

Again, it is very difficult to date the latest extensions of the system's ambitus. For the lowest tetrachord of the Hypolydian and Hypophrygian keys two new triplets were invented. Simple forms that gave unique variants on rotation and reversion were now rare. The new basic signs Γ and Δ seem to be variations of the same idea; but for the latter, which is symmetrical around the vertical axis, the triplet-forming principle was apparently given up.¹²¹ The vocal series was extended alphabetically, down to Σ , on the continuing principle of inverting the letters where possible. The respective modifications of the last six letters, from Υ to Ω , were already in use for the upper extension, so the glyphs had to be treated differently, and were mostly rotated by ninety degrees. But of these signs, only \neg and \triangleleft were actually needed for the regular keys. Instrumental notation adopted vocal Σ , in its reverted form Ξ , as the basic sign for a triplet, and once more the reverted forms of the lowest signs, giving up the idea of the formal triplet entirely. Quite possibly only few of these were ever used in practice.

The extensions in the higher region, on the other hand, made consistent use of the octave strokes; consequently they could not leave any inherent traces of a possible stepwise evolution. There may however be evidence that the conception of the Hyperphrygian and Hyperlydian keys antedated the later designation of the 'chromatic' *tónoi*.¹²² If so, the triadic system would have originated within the older system, to be expanded and generalised only later.

¹²¹ Cf. however the possible earlier form considered, although hesitantly, by West 1992a: 40.

¹²² In Ath. 625d, Aristoxenus' terminology appears mixed with that of the final system: ... καὶ τιθεμένων ὑπερμιξολύδιον ἁρμονίαν καὶ πάλιν ὑπὲρ ταύτης ἄλλην. οὐχ ὀρῶ γὰρ οὐδὲ τὴν ὑπερφρύγιον ἴδιον ἔχουσιν ἦθος· καίτοι τινὲς φασὶν ἄλλην ἐξευρηκέναι καινὴν ἁρμονίαν ὑπερ(λ)ύ(δ)ιον "... and who posit a Hypermixolydian *harmonia* and again another one beyond that. For I cannot see that even the Hyperphrygian has a character of its own; but some say they have discovered yet another new Hyp(er)ly(d)ian *harmonia*" (as one should perhaps read instead of the manuscripts' ὑποφρύγιον. But cf. also the solution of Winnington-Ingram (1936: 20): "a new Hypophrygian" = Hyperlydian, which reduplicates Hypophrygian at the octave; problematic is only that such a terminology should occur side by side with the late "Hyperphrygian", although the older designation of Hypermixolydian was at hand, and although this *tónos* is also a doublette, namely of Hypodorian). The sentences seem parallel, so that the second mentioned *tónos* must be understood to carry the transgression associated with the first even further. Since this first *tónos* is initially identified in the older way as Hypermixolydian, then by its later designation as Hyperphrygian, the one even beyond it should be the Hyperlydian: if only one of the two keys above Hyperphrygian, namely Hyperaeolian and Hyperlydian, is in view, Hyperlydian is the natural candidate, as Hyperaeolian must be either coeval with it or later. Since the deprecated development took place only after Aristoxenus, the text cannot be part of the quotation of Heraclides Ponticus, within which it appears.

	BC		AD	
younger keys (Iastian)	0	—	18	53%
natural keys (Lydian)	11	73%	16	47%
older keys (Phrygian, Dorian)	4	27%	0	—
	15		34	

$\chi^2 = 18.31 \quad p = 0.0001$

Table 2 The late Hellenistic revolution in *tónos* employment

We possess virtually no musical documents from the two centuries around the turn of the Christian era. All extant fragments that date before this span and can be read with reasonable reliability adhere, as we have seen, to the earlier, ‘enharmonic’ half of the notation. After that dark period, things had changed considerably.¹²³ Of the early scales only the Lydian triad seems to have survived – it has, however, lost its predominance. The new ruler is definitely the Iastian triad, and especially the Hyperastian scale: the former ‘high Mixolydian’ with its weird mixed *pykná*, the immediate neighbour of the older set of keys (and the first of the newcomers¹²⁴). The distribution, shown in Table 2, is certainly significant, although we cannot of course exclude the possibility that the old *tónoi* continued to be used, even if much less frequently.¹²⁵

This radical change was, it can be supposed, motivated by the desire to escape the annoying inconsistencies that were inherent in the old keys, especially in their chromatic reading. With the new focus on the ‘left-hand’ scales, the system again came close to a pitch notation. Still, there was no one-to-one relation between pitches and signs, not even if we disregard matters of fine-tuning. As ever, the same position in the semitone grid was sometimes notated differently in different contexts, the note signs reflecting functional values within the tetrachord structure. This was perhaps considered as an advantage of the system, which should not be given up. But a considerable improvement was the fact that, within the chromatic and diatonic genera, a given note sign now designated a unique pitch. If some precautions were taken, the danger of ambiguous scores was eliminated.

¹²³ Cf. *AGM*: 383.

¹²⁴ Cf. Riemann 1902: 566.

¹²⁵ It is also conceivable that such music retreated – for whatever reason – to environments that left no traces in Egyptian papyri.

To understand the new framework completely, we must consider its implications in detail. Of all the old sign triplets, only those of the Lydian keys survived as triplets; and these were now interpreted as chromatic *pykná*. Their central notes remained restricted to the notation of the second-lowest notes in the respective tetrachords, and did not occur in any other function. The outer notes of the triplets, in contrast, established the overall semitone grid, and thus became abstracted from their original function, which was connected with their position within the triplet. This gave rise to the unproblematic type of doublets: Lydian *parypátē* P∪ occupies the same pitch as, for instance, Hypoianian chromatic *paranétē* Π∩. For diatonic music, everything works out perfectly: within a network of nine scales from Hypoaeolian to Hyperlydian an unambiguous notation is ensured.¹²⁶ As the extant musical documents show, diatonic music was standard at the time in question.

Slight complications arise in the chromatic genus (which was however approaching obsolescence, as well). If the notation of a piece could be confined within the five keys from Iastian to Hyperlydian, there was no problem at all. Only the chromatic scales of the Aeolian triad and the Hypoianian would bring about a violation of the principle of unique pitch. Here the signs Π∩, for instance, indicate a pitch one semitone above CC, whereas in the Lydian key the same signs designate the highest note of their *pyknón*, which stands, in the chromatic genus, two semitones above CC (at a pitch that is elsewhere written OK).

CHROMATIC STROKES

It was probably for these cases that one felt the necessity to create a distinction by means of diacritical marks. In a time when chromaticism was the exception it was natural to put these on the relevant notes of the chromatic *pykná* – and of course only in extensively modulating pieces where there was danger of confusion. Such diacritical marks are found in the chromatic tables of Alypius and Boethius, in the form of small strokes.¹²⁷ Scholars have usually assumed that these strokes served to distinguish chromatic from enharmonic *pykná*. Consequently it was never understood why the

¹²⁶ Note that the Hyperdorian scale cannot be included, because its *hypátē mesón* Π∩ relies on the enharmonic principle. Accordingly, its name puts it into the environment of the early keys.

¹²⁷ Alypius, p. 384; Boeth., *Inst. mus.* 4.3–4, p. 310–12.

strokes occur only in the Lydian key.¹²⁸ From our findings, this seems to make good sense: ambiguous were only those signs that came also to be exploited in the Aeolian or Iastian keys, but were, at the same time, in use as members of non-obsolete triplets. All notes for which this is true occur in the Lydian, namely $\forall \Gamma \Pi \Delta \text{H} > \Delta \square \perp \lambda$.¹²⁹ It is precisely this set that we find adorned with chromatic strokes in the tables. Even if these complicated forms¹³⁰ are not repeated in the Hypo- and Hyperlydian, or in the Hyperaastian key (chromatic music could in most cases be notated without them), every necessary note shape is exemplified in the first and basic table.

Thus we find that an older ‘enharmonic’ notation was replaced by a younger ‘chromatic’ and ultimately ‘diatonic’ paradigm. It is vital, however, to remember that these were not mutually exclusive, but represented rather different sections of a consistent comprehensive system, which was upheld and passed on in its entirety. Although the extant musical documents from the Roman period testify only to the younger approach, we have doubtless to reckon with the continued transmission of older pieces, still notated in keys that were flourishing several centuries earlier. In any case, a large part of that music was notated in the natural Lydian key anyway, which never fell into disuse.

¹²⁸ For the second problem, why only the highest notes of the *pykná* were distinguished, and not the middle notes, it has been pointed to the fact that there is also no difference between the notation of these notes in their diatonic and enharmonic form, and that these notes are also identical in the tunings of the three genera given by Archytas. Archytas’ system is discussed below (pp. 171ff.); in any case a pre-Aristoxenian origin for these strokes, which are not attested before late antiquity and never in the musical documents, is wholly implausible.

¹²⁹ To these, one might add the tremendously high Hyperlydian $\text{H} >$; but this note occurs only as Hyperaolian chromatic *paranēiē*, an extreme note of a scale never attested in practical use.

¹³⁰ The signs are not only drawn but also described, which calls for formulations such as $\lambda\acute{\alpha}\mu\beta\delta\alpha$ $\pi\lambda\acute{\alpha}\gamma\iota\omicron\nu$ $\acute{\alpha}\pi\epsilon\sigma\tau\rho\alpha\mu\mu\acute{\epsilon}\nu\omicron\nu$ $\gamma\rho\alpha\mu\mu\acute{\eta}\nu$ $\acute{\epsilon}\chi\omicron\nu$ $\delta\acute{\iota}\acute{\alpha}$ $\mu\acute{\epsilon}\sigma\sigma\omicron\upsilon$ (“horizontal lambda, facing backwards, with a stroke through the middle”) for the sign L . In some cases, the chromatic stroke seems to have become confused with the octave stroke of the highest notes.

CHAPTER 2

Notation, instruments and the voice

BELLERMANN'S SECOND ANONYMUS

From a short late treatise, the second in a collection known as Bellermann's Anonymi,¹ we learn that different selections of keys were associated with different types of music.² Lists of *tónoi* are given for aulos music, for the water-organ (*hýdraulis*), for citharodic, and finally for 'orchestic' music. Although in the text the keys are ordered, as usual, according to pitch, it becomes immediately clear that the single lists are held together by the principle of modulation: they represent contiguous sections of neighbouring keys. Interestingly, of those pairs of *tónoi* that re-double each other at the octave, sometimes both are mentioned, sometimes only one, omitting the 'Hyper-' keys. It seems therefore that in some cases the older, Aristoxenian, system is still influential. But there is never a gap, and it is therefore always possible to proceed over the entire tonal range of one type of music by reiterated application of the simplest types of modulation.

In Diagram 14, the ranges for the various types of music are juxtaposed to the evidence of the fragments. It will be noticed that the least common denominator of all four categories of music consists of the Lydian and Hypolydian scales, the core of the system, which we have also found to be the common ground of the earlier and the later approach. For the single categories, the following explanations suggest themselves:

'Orchestic' music seems at first a bit misplaced in the context of three instruments, because we expect choral song and dance to be accompanied, either by the aulos, or, especially in classical and archaic settings, by the

¹ For the question of the number of sources and the nature of the compilation, cf. Pöhlmann 1975; 1994: 190–1.

² Anon. Bell. 2, §28.

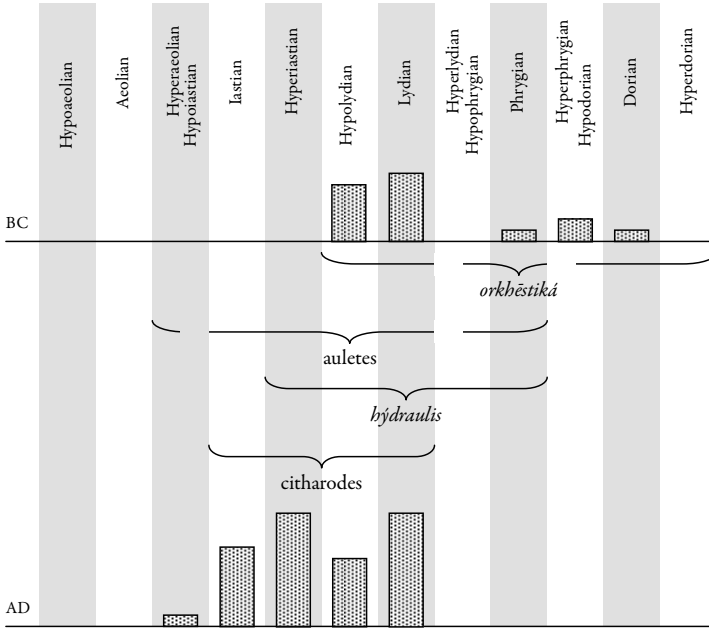

Diagram 14

Keys used in different periods and by different instruments (Anon. Bell. 2, §28)

cithara, or by both, as for instance in the First Delphic Paean.³ The term is obviously introduced to distinguish the old genres of choral music from the virtuoso forms, which enjoyed a continuous history from the times of Terpander and Olympus down to the Imperial age. The listed keys confirm this identification, as they are identical with an old system of seven keys, from Hypolydian to (low) Mixolydian, appearing under its later name of Hyperdorian. In similar accordance with the older systems, the Hyperlydian and Hyperphrygian keys are not named, their tonality being provided by the Hypophrygian and the Hypodorian, respectively. It is a pity that we do not know which genres the author of the list, which may be considerably older than our source, had in view. The term *orkhēstiká* may embrace anything from Pindar and the dramatic and dithyrambic choruses of classical Athens down to pieces of Hellenistic workmanship such as the Delphic Paeans, which still adhere to the notational range in question.

³ Here the text draws attention to both instruments playing; the melodic subtext seems to presuppose them accompanying the song; cf. Hagel 2002.

Solo aulos music played an important role throughout antiquity. So it is no wonder that the keys for the aulos extend over parts of both the earlier and the later section of the notational system. Besides the natural 'Lydian' scale, which might have been originally created for the notation of simple aulos music, the two old Phrygian keys are named; the famous connection between Phrygian music and the reed instrument is explicitly asserted by our source. We wonder, however, why the Dorian is altogether excluded, although Dorian aulos music was held in the highest esteem from early times on.⁴ Later auletes obviously exploited the new 'chromatic' scales, too. So the tonal versatility of the aulos, for which this instrument was celebrated from early times, is reflected in the large tonal range it is ascribed in our list, exceeding by far that of the other two instruments.⁵

The *hydraulis* will have leaned on its mouth-blown ancestor, until it was accepted to a degree that allowed generic organ music to evolve. As a Hellenistic invention it came to share the old Phrygian scales (although it seems unlikely that there was ever an enharmonic organ), and its tonality was, if we can trust our source, never extended beyond the Hyperastian (the old 'high Mixolydian'). Is this due to the fact that keys are, after all, less flexible than finger holes?

Finally, the smallest range of only four keys is attested for citharody. This seems to imply that citharodic music of the older times did not exploit the modulating system of *tónoi*, but only the basic 'Lydian' notation, which sufficed for the simpler modulations that could be carried out on the stringed instrument. We have already mentioned that the citharist Limenios composed his Delphic Paean in the basic scale, probably guided by the customs of his profession. In later times, the Iastian was adopted, too. It is obvious to the eye that the extant scores from this period conform almost exactly to the citharodic set of keys – which was however part of the auletic range also. Possibly the old *tónoi* survived merely in traditional aulos and aulos-accompanied music, which were well known and thus rarely notated, while new compositions took advantage of the younger chromatic keys.

Although our late source seems to add most valuable pieces to our puzzle, we must wonder if we have not put too much reliance upon its report.

⁴ Cf. e.g. ps.-Plut., *Mus.* 1134ab; Gal., *Plac. Hipp. et Plat.* 5.453 Müller (5.6.21 de Lacy); Mart. Cap. 9.926.

⁵ Cf. also Porphyrio, in *Hor. Carm.* 4.15.30: *aiunt tres modos tibiariam esse: Ionicum, Lydium, barbarum* (cf. in *Hor. Epod.* 9.5–6), which seems to account for the same auletic range, *Ionicum* covering the Iastian triad plus Hyperaeolian (the octave doublet of Hypoastian), *Lydium* the Lydian triad, *barbarum* the old Phrygian/Hypophrygian.

Without doubt independent confirmation would be immensely welcome. And indeed we will see that such confirmation can be derived from a rather unexpected source, namely from Ptolemy's *Harmonics*, a work that has notoriously seemed at odds with the rest of ancient musical writing.⁶ Consequently we cannot avoid an excursion into some rather technical aspects of Ptolemy's reasoning; but we will be rewarded by the solution to a riddle that has vexed generations of scholars.

PTOLEMY

Ptolemy is interested in strings. Only they – and only if one makes the most careful technical provisions – ensure measurements of truly scientific accuracy.⁷ String lengths form the background of Ptolemy's musical mathematics; his demonstrations are based on, and are meant to be reproduced on, strings; and the mathematical description of the cithara tunings that are actually heard on the stages of his time is the ultimate objective of the second book of his *Harmonics*. Yet although, or rather because, Ptolemy is really concerned about a clear-cut description of musical structures, he does not adhere to the common system of *tónoi*, as it underlies the musical life of his time in the form of the traditional notation. This framework, laden with the shortcomings and inconsistencies that resulted from an evolution of over five hundred years, cannot fit Ptolemy's purpose. And what is more, the Aristoxenian division of the octave into twelve semitones of equal right can by no means be reconciled with the Pythagorean approach of intervals as ratios of integers. Ptolemy revives the most mathematically minded branch of Pythagorean musical theory, which seems to have, after a period of important contributions, ultimately despaired in the face of Hellenistic modulating music, and retreated into the lore of straightforward non-modulating scales and cosmic speculation. The task was then, to allow for a certain amount of modulation without giving up the Pythagorean principles. This was possible only by sacrificing the attempt to account for every kind of music of every period – which adds another motive for Ptolemy's focus on the lyre.

⁶ Cf. e.g. Chailley 1979: 94–5; Redondo Reyes 2003a.

⁷ Cf. Ptol., *Harm.* 1.8, p.16–19.

After refuting the Aristoxenian system on slightly unfair grounds,⁸ Ptolemy has opened up the field for a different approach towards *tónoi*. He conceives of them by letting the paradigm of modulation coalesce with those of the octave species and of the tuning. The aspect of tuning makes the Dorian the natural centre. Ptolemy did not change the tonal relations between the *tónoi*, of course – these were part of the reality of music he had set out to describe, but he restricted their number to seven, in accordance with the number of octave species. This would certainly do for almost all melodies of his time. Laying out the relations by means of numbers, Ptolemy did not need to attach musical notation to his scales. So his system escaped the ‘re-mapping’ that had marginalised the ‘Dorian’ in the notational system. While there the natural scale came to be identified with ‘Lydian’, Ptolemy’s natural scale remains the Dorian. Thus, he created the coherent system which scholars would have loved to find in the notation as well.⁹ In his method, Ptolemy was apparently justified by the citharodic practice of focussing on the natural ‘Lydian’ scale. But the citharodes’ terminology had succumbed to the aulos-borne nomenclature of *tónoi* long before. Consequently, Ptolemy had to pay the price when applying his scheme to the cithara tunings of his time.

After establishing the measurements with the help of which all acceptable tunings in all *tónoi* can be set up on the canon, Ptolemy lists those he finds actually employed.¹⁰ After short remarks on the lyra,¹¹ he turns to the cithara. There we learn of six tunings, realised in four different *tónoi*: Hypodorian, Phrygian, Dorian and Hypophrygian. The tunings are referred to by terms obviously created by practising musicians: *tritai*, *hypértropa*, *parpátai*, *trópoi*, *iastiaiólia* and *lýdia*. Two of them are denoted by the slightly

⁸ Cf. Hagel 2001: 88 with n. 11.

⁹ It must be kept in mind, though, that Aristoxenus was perfectly free to make Dorian the centre of his *diágramma polýtropou*, which was not equipped with notational signs any more than Ptolemy’s tables; we do not know whether he did so, or preferred a layout with an ‘old’ and a ‘new’ half as in the diagrams printed here.

¹⁰ Ptol., *Harm.* 2.16, p. 80.

¹¹ It is usually inferred from Ptolemy’s words that the lyra was tuned to all of his *tónoi* (e.g. Monro 1894: 84 with n. 1; Gombosi 1939: 102; *GMW* II: 356 n. 135; Barker 2000: 257; Redondo Reyes 2002: 504 n. 332). But this is not what Ptolemy says. What he is providing is a formula to find the appropriate tunings for any given *tónos*: περιέχεται δὲ τὰ μὲν ἐν τῇ λύρα καλούμενα στερεὰ τόνου τινός (ποτ ἐκάστου τῶν τόνων!) ὑπὸ τῶν τοῦ τοιαίου διατόνου ἀριθμῶν τοῦ αὐτοῦ τόνου... In Ptol., *Harm.* 2.1, p. 43.9–12, on the other hand, it seems presupposed that the *stereá* lyra tuning applies only to ‘Hypodorian’ and ‘Phrygian’ (cf. *GMW* II: 317 n. 9). The common modern misunderstanding arose from the erroneous identification of our knowledge with that of Ptolemy’s audience: we are lacking the information of applicable *tónoi*, which Ptolemy’s audience was perfectly familiar with. All we can infer is that the lyra enjoyed less variation of tuning shades, but perhaps a wider range of *tónoi* than the cithara. On the problem of the lyra, see below pp. 77 ff.

traditional <i>tónos</i> name	Ptolemy's <i>tónos</i> name	Ptolemy's tunings in that <i>tónos</i>
Lydian	Dorian	<i>lýdia</i> <i>parypátai</i>
Hypolydian	Hypodorian	<i>tropiká = trópoi</i> <i>trítai</i>
Hyperastian	Phrygian	<i>hypérupta</i>
Iastian	Hypophrygian	<i>iástia = iastiaiòlia</i>

Table 3 Ptolemy's tunings

different names of *tropiká* and *iástia* in a related passage.¹² The bulk of these terms have hitherto found no satisfactory explanation.¹³ However, on the basis of our insights into the originally independent evolution of notation and *tónoi*, and the 'conservative' character of citharodic notation, the solution is surprisingly simple. Just as in the anonymous list, Ptolemy attributes to citharodic music a contiguous range of four keys.¹⁴ The divergence between the names of the keys, which makes both accounts appear contradictory at first glance, is due to Ptolemy's idiosyncratic approach to the *tónoi*. His 'natural' key is the Dorian, whereas the anonymous source uses the traditional key names, and therefore calls the natural key the 'Lydian'. But the latter nomenclature also stands behind Ptolemy's tuning names, as can be gleaned from Table 3.

In the Roman period, whenever citharodes used the natural key, they called it the 'Lydian' like everyone else – except Ptolemy.¹⁵ Consequently the basic tuning, which was associated with the respective notational signs, was also referred to as *lydia*. Although a contemporaneous musician might perhaps have smiled at a theorist who called 'Dorian' what was obviously Lydian, we ought to do justice to Ptolemy, who was well informed on Greek musical history. The tuning in question indeed goes back to – and is more or less identical with – a structure that classical Greece would doubtless have addressed as 'Dorian', and in all probability ultimately to 'Dorian' lyre music of Terpander's time. Besides, until long after Ptolemy the corre-

¹² Ptol., *Harm.* 1.16, p. 39.11 and 14.

¹³ Cf. Düring 1934: 201–15; *GMW* II: 360–1; Redondo Reyes 2002: 500–11, nn. 328–35.

¹⁴ Cf. Düring 1934: 211; Gombosi 1939: 108–13 (who would hit upon the truth here, were he not taking Hypolydian instead of Lydian as the natural key); Redondo Reyes 2002: 659–60, n. 647.

¹⁵ Possibly, however, Ptolemy depends on a 'Pythagorean' *tónos* system from a lost source (cf. below, pp. 100ff.).

spending octave species continued to be recognised as ‘Dorian’, although we do not know to what extent this terminology was acknowledged by practising musicians.

In the same way, the tuning that corresponded to, and was notated in, the Iastian key, was naturally called *iástia*. Its second name cited by Ptolemy, *iastiaiólía*, seems to reflect a general awareness of the two late triads, the Iastian and the Aeolian, as belonging together. Perhaps this ‘chromatic’ section of the notation – the ‘sharp’ keys in modern transcription – was called by this name: on such an assumption, it would be easy to understand how the ‘Iastian’ tuning assumed the name of the section in which it stood: ‘the key (we citharodes use) out of the modern ones’, in opposition to those that did not exceed the earlier established range. But perhaps there was more behind the notion of ‘Aeolian’: actual pieces might have included modulations into Aeolian that are not reflected in Ptolemy’s straightforward eight-string tables, but needed additional modulating strings on the instrument.

It does not fall within the scope of this chapter to address the problem of the shades of fine-tuning that Ptolemy associates with each tuning scheme. To round off the picture, some remarks on the possible interconnections between the schemes must suffice for now, even if many questions remain unanswered.¹⁶

The two tunings called *trópoi* and *hypértropa* might relate to the natural *lydia* as a point of reference: starting from this basic ‘Dorian-Lyidian’ tuning, one turning (τρόπος) of modulation or retuning leads to *trópoi*, another cumulative turning to *hypértropa* – although, if we trust Ptolemy’s figures, it must be admitted that slightly different pitches of structurally identical notes require the retuning of several strings, especially between *lydia* and *trópoi*, even if the respective scalar degrees are identical.¹⁷ On the other hand, *hypértropa* is easily retuned to *iástia* and vice versa (in this case, *hypértropa* functions as the ‘Hyper-’ key of Iastian). If one starts the tuning series from *iástia*, *hypértropa* leads over to *tritai* and *parypátai*, the last two being arrived at by adjusting the eponymous strings, *tritē* and *parypátē*, respectively.¹⁸ The connections are displayed in Diagram 15, the graphical distances exactly reflecting the interval sizes given by Ptolemy.

¹⁶ For the following cf. Mathiesen 1999: 474–6.

¹⁷ It is significant in this context that Ptolemy’s term *harmogé* means ‘tuning’ not only in the sense of a pitch structure, but also as the process of ‘tuning’ and ‘retuning’, the way to arrive at one tuning from another: Phryn., *Praep. soph.* 24.16–25.9; cf. Redondo Reyes 2002: 500–1, n. 328.

¹⁸ For *parypátai*, cf. *GMW* II: 360; Redondo Reyes 2002: 507. Although, in the present hypothesis, *tritē* is the third highest note and hence *tritē* by position, not by function (although *tritē hyperbolōn* by

We must, however, bear in mind that Ptolemy provides us only with non-modulating octachord tunings, to be constructed experimentally. Yet virtuoso instruments had more than eight strings; so tunings which appear, from Ptolemy's account, to differ only in microtonal shadings such as *lydia* and *parypátai* might actually have referred to substantially different stringings. For instance, it is more than probable that the scalar degree of *hyperypátē* was present, although it exceeds the range of an octave, to which Ptolemy confined his tables.

Furthermore, we should consider the possibility that virtuoso instruments might have been capable of hosting more than one of the 'tunings' Ptolemy gives at the same time, to make modulation between them possible within a piece. Ptolemy tells us, although without further explanation, that the two tunings of *lydia* and *iástia* were called 'modulating', *metaboliká*.²⁰ So we would assume that these at least included more pitches

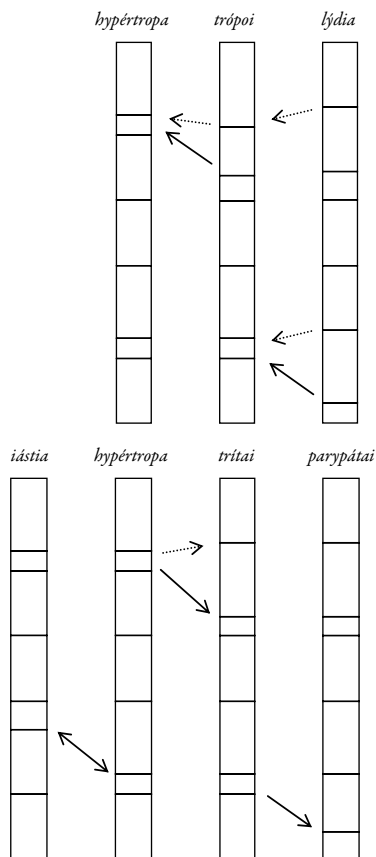

Diagram 15 Possible connections between cithara tunings¹⁹

function, as stressed by Düring (1934: 212–13) and his followers; but I do not regard this as relevant), it is not necessary to vindicate the whole system of Ptolemaic thetic nomenclature for practising musicians: the Hypodorian *trítē* in question is identical with that of the basic 'Dorian' tuning, where thetic and dynamic names fall together. Since the upper notes do not change between 'Dorian' and 'Hypodorian', it was quite natural to refer to the same third string, tuned to the same pitch, by the same name. For an extensive discussion of this notorious issue see below, pp. 103 ff.

¹⁹ The relations and distances in the diagram are based on Ptolemy's numbers (in logarithmic form, of course, so that equal intervals are rendered by equal distances). Note the error in Barker's (*GMW* II) table 11.3 ("Phrygian from *nētē*"), p. 352; cf. Redondo Reyes 2002, n. 643, pp. 658–9.

²⁰ Ptol., *Harm.* 1.16, p. 39.13.

than Ptolemy's respective tables. In any case, eleven strings are attested already for the fifth century BC.²¹ We shall revert to this topic later on.

POLLUX

There are another two lists of citharodic *tónoi*, which coincide only partially with Ptolemy and the Anonymus, thus seemingly contradicting their statements. One of these is found in Pollux' *Onomastiká* and comprises Dorian, Ionian, Aeolian, then Phrygian and Lydian, and finally some Locrian, invented by Philoxenus.²²

Yet Pollux is not a musical writer. He is only interested in collecting vocabulary applicable to any topic; therefore he has obviously brought together terminology of different periods and categories: tunings, modal scales and keys. It should also be noticed that Pollux is not even talking about *tónoi*, but subsumes his list under the broad term ἄρμονία.

The construction of a primary 'Greek' trio of Dorian, Ionian and Aeolian, here contrasted with the modes of foreign names, associated with Asia Minor, goes back to Heraclides Ponticus.²³ The absence of Hypo- and Hyper- keys shows Pollux' disregard for technical details. If interpreted under the aspect of *tónoi*, he ends up with a complete list of available tonality, with the addition of the Locrian '*harmonía*', for which apparently no respective *tónos* was ever conceived. Consequently, Pollux' account is worthless for our investigation.

PORPHYRY

Much more serious are the problems posed by Porphyry's list, which has never been adequately understood. At the very end of his discussion of Ptolemy's tetrachordal constructions, which require knowledge of the tunings (we shall discuss this topic in a later chapter), Porphyry adds:

²¹ Cf. nn. 96 and 97 on p. 87 below: whether the twelve χορδαί repeatedly invoked in Pherecrates, *ap. ps.-Plut., Mus.* 11.41d–11.42a, are strings or notes is disputed.

²² Pollux 4.65: ἄρμονιαὶ δὲ Ἄωρις Ἰᾶς Αἰολίς αἰ πρώται, καὶ Φρύγιος δὲ καὶ Λύδιος, καὶ Λοκρικῆ, Φιλοξένου τὸ εὕρημα.

²³ Cf. above p. 16 n. 4; below pp. 429ff.

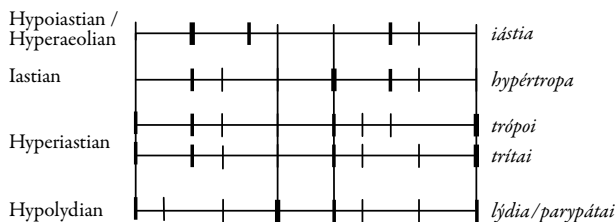

Diagram 16 Porphphy's construction of Ptolemy's tunings

εἰδέναι δεῖ καὶ τοῦτο, ὅτι οἱ κιθαρωδοὶ τετράσι τόνοις ὡς ἐπὶ τὸ πλεῖστον ἐχρῶντο, τῷ Ὑπολυδίῳ, τῷ Ἰαστίῳ, τῷ Αἰολίῳ καὶ τῷ Ὑπεριαστίῳ.

(Porph., *in Harm.* 156.8–10)

It is necessary to recognise also the fact that the citharodes were employing four keys, for the most part, the Hypolydian, the Iastian, the Aeolian and the Hypoerastian.

First of all, we learn that Porphphy was perfectly aware that Ptolemy's nomenclature of *tónoi* differs from that of the rest of the world, and that Ptolemy's 'Dorian' must not be equated with the Dorian *tónos* of musical and notational practice, but replaced by something more familiar. As to what this was, Porphphy obviously developed his own ideas.

The set of keys with which he comes up comprises, on face value, not even four contiguous *tónoi*, as required by Ptolemy's tunings. But it is essential to understand Porphphy well. Although his few remarks on the matter seem cryptic and even contradictory, we will see that they are probably based on a consistent interpretation.

The contiguous range Porphphy has in mind evidently extends from Hypolydian to Hypoiastian (cf. Diagram 16). In comparison with the Anonymus' list, which we have explained as equivalent to Ptolemy's description, it is thus shifted by one *tónos*, and therefore situated one fourth lower. It will be noticed immediately, that the neat correlations of *iástia* with Iastian and *lýdia* with Lydian are now lost. On the other hand, the variant *ias-tiaiólía* would find a good explanation in the fact that this tuning is now realised in a tonal range the greatest part of which is shared by the Hypoiastian and the Hyperaeolian key.

In order to understand why Porphphy introduces the unqualified term 'Aeolian' instead of referring to 'Hypoerastian', we must have a closer look at the tetrachords Ptolemy sets up for mutual comparison. The somewhat complicated details of Ptolemy's procedure need not concern us yet. Suffice

it to say that he offers a set of experiments, by which, he claims, the musically experienced reader will be able to assess the validity of Ptolemy's mathematical descriptions of the familiar lyre tunings.²⁴ In each step of a larger process, two tetrachords that share at least one pitch are set up on the eight-stringed canon by ear. Ptolemy refers to the notes in question by the name of the tuning, and by the names of the strings on the cithara. It is clear that he cannot relate to *tónoi*, firstly, because he has not come to the subject yet, and secondly, because at this point the reader is not in the position to decode Ptolemy's unusual nomenclature. Later in his work, however, the position of all the notes in question within his system of keys becomes clear.

Porphyry, on the other hand, finds it easier to explain the relationships in terms of *tónoi*. Citharodic practice might have changed in the meantime; at any rate the system of *tónoi* provided a stable and well-defined background for the discussion of tonal relations. So he sets out to translate Ptolemy's *tónoi* into familiar notational *tónoi*. It is essential to understand that Porphyry did not, in this respect, rely on his knowledge of contemporary music. On the contrary, he seems to infer that the practice of Ptolemy's time was quite different; otherwise there would be no point in using the imperfect ἐχρῶντο, 'were employing'. Obviously Porphyry reconstructs Ptolemy's tunings out of his work, just as we do.

Apart from the summarising statement quoted above, Porphyry expressly equates Ptolemy's "fourth from *néte* to *paramésē* of *trópoi*" with "the higher tetrachord of the Iastian *tónos*", and Ptolemy's "fourth from *tritē* to *diátonos* of *iastiaiólía*" with "the lower tetrachord of the Aeolian *tónos*".²⁵ This seems incompatible with Ptolemy's system: although Iastian and Aeolian are separated only by one key, as are Ptolemy's *trópoi* and *iastiaiólía*, the tunings of the other neighbouring key of *trópoi*, namely *lýdia* and *parypátai*, would then occupy the Hyperastian *tónos*, leaving no room for the Hypolydian of Porphyry's list. Moreover, the implied equation of Ptolemy's 'Dorian' with such a scale as Hyperastian would be bizarre.

The key to Porphyry's classifications is that he is thinking in terms of the Unmodulating System, instances of which he associates with the basic scales of the triads of the notation, while avoiding the 'Hypo-' and 'Hyper-' prefixes wherever possible.²⁶ Thus, he references the 'Hyper-' keys by means

²⁴ Ptol., *Harm.* 2.1, p. 42–5. See below, pp. 194ff.

²⁵ Ptol., *Harm.* 2.1, p. 42.11–12; p. 43.19–20; Porph., in *Harm.* 153.16–17; 154.19–20.

²⁶ Cf. the focus on the basic scales in Aristid. *Quint.* 1.10, p. 21.1–4 (above, p. 4 n. 13; cf. *GMW* II: 422 n. 120); Plut., *De E ap. Delph.* 389c; Apul., *Flor.* 4 (adorning the basic scales of triads with partially anachronistic epithets); Cassiod., *Var.* 2.40.4–5 (similarly enumerating the five basic scales with

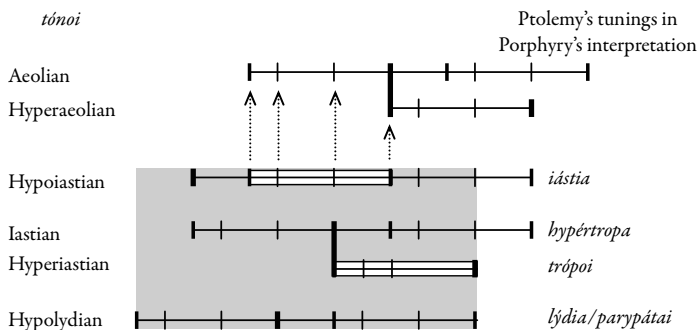

Diagram 17 Porphyrus's reference to tetrachords

of the *synēmménon* tetrachord, and conceives of the ‘Hypo-’ keys, where possible, as consisting of the tetrachords of their neighbouring basic keys. The relations are set out in Diagram 17, where the grey region, covering an octave in four contiguous keys, indicates the part of the system that Porphyrus assigns to Ptolemy’s tunings. For the sake of clarity, only the complete tetrachords of the central octave²⁷ of all relevant *tónoi* are drawn in the diagram, even if they fall short of, or overrun, the range of the tunings. The two tetrachords we are talking about are marked. Thus it becomes clear how Porphyrus can refer to the notes from the Hypoiastian key as “the lower tetrachord of the Aeolian *tónos*”: it is indeed identical with the lower *mésos* tetrachord, as opposed to the higher *diezeugménon* and *synēmménon* tetrachords, of the Aeolian, and from a certain point of view, it is this tetrachord, in that it is native only to the Aeolian Unmodulating System. Similarly, the tetrachord from *trópoi* is in some way “the higher tetrachord of the Iastian *tónos*”, namely the *synēmménon* tetrachord, since the other candidate for a high Iastian tetrachord, the *diezeugménon*, does not fall within the considered octave range in its entirety.

Thus, the jigsaw of Porphyrus’s statements assembles into a consistent picture. Having constructed the system, he realised that it contains five complete tetrachords, which he referred to, as far as we can see, by their position in the Unmodulating Systems of the un-prefixed keys (whether he would have done so in the case of Hypolydian, too, remains questionable; but, unlike the other keys involved, Hypolydian goes back to pre-Aristoxenian nomenclature). Even so, the philosopher can barely escape the charge

characterisations, but also referring to the fifteen *modi*: “*omnis enim tonus habet summum et imum: haec autem [the characterisations] dicuntur ad medium*”).

²⁷ Cf. Diagram 1 on p. 6.

of having failed to achieve the clarity we expect from a commentary, especially in the compilation of his list, where he names an Aeolian, based on his tetrachordal viewpoint, side by side with the Hyperaastian *tónos*, presumably a concession made in order to complete the necessary number of four keys. In any case, our reconstruction should correctly represent the system he had in mind; otherwise one would have to assume that Porphyry was completely confused.

But even if we concede that Porphyry's rendition of Ptolemy's tunings can be interpreted as consistent both with Ptolemy's text and the notational system, it is nevertheless wrong. Perhaps Porphyry already perceived not Lydian, but Hypolydian as the 'natural' and therefore central key, with which Ptolemy's 'natural' Dorian scale had to be equated, thus anticipating the modern error?²⁸ As we have seen, Porphyry was probably aware of the discrepancy between citharodic practice, which employed the Lydian key quite frequently, and his own list of keys, which excludes it. Hence the imperfect ἐχρῶντο: 'Do not consider contemporary music! These are the keys of Ptolemy's time (as I have extracted them from his text).'

Still, the existence of a divergent interpretation of Ptolemy's text only a few generations later must cast doubts on our present reconstruction. Might not Porphyry's Hypolydian hypothesis account for the facts just as well as our Lydian interpretation? Presumably the agreement between Bellermand's Anonymus and the tuning names preserved by Ptolemy would suffice to outweigh Porphyry's statement, problematic as it is anyway. Even so, some further independent evidence would be welcome.

MUSICAL PRACTICE

To a certain extent, it must be possible to draw conclusions about lyre tunings from the extant musical documents. Although it cannot be emphasised enough that the notes available on an instrument such as the lyre and the scales of the vocal line must not be identified, and although only part of the existing melodies were performed to the lyre at all, we can nevertheless expect a certain amount of correlation between the melodies and the tunings. This is partly because instruments were built in accordance with the needs

²⁸ As a possible testimony of such a transition to Hypolydian as the natural key one might also compare the 'Hypolydian canon' (cf. n. 6 on p. 98 below), where Hypolydian is taken as the basis, whereas the intercalated semitones fit only a Lydian diagram.

of the singers, and partly because composing singers tend to use the tonal material of their instruments as the primary point of reference. Ptolemy explicitly tells us that the octave gamut of his tunings reflects the range that is most comfortable for the human voice.²⁹ Hence there will be correlations, if his claim of representing structures of musical practice is worth anything. Such correlations must, however, at first be detected by statistical methods, even if the insights gained in this way can then be used for, and deepened by, the inspection of individual pieces.

In our case, the question is easily posed: which one of the two competing interpretations of Ptolemy's tuning better accounts for the extant material? The evidence we have collected for the *tónoi* list of Bellermann's Anonymus provides a first answer: the identification of Ptolemy's account with that system seems in accordance with the tonality of the fragments. But Ptolemy's gives not only a list of keys, but specifies a particular range within these, which enables us to study the relations between theory and extant scores in detail.

Whether we equate Ptolemy's Dorian with the Lydian or the Hypolydian key of the notation, in both cases his array of octachords corresponds to a well-defined set of notational symbols from four keys. A comparison with the notes used in the fragments reveals which portions of the extant pieces are covered by the tunings according to each of the two interpretations. The respective percentages are displayed in Diagram 18. There the fragments are grouped chronologically, although in periods of varying length, so that each holds a comparable number of pieces and sufficient material for statistical evaluation. Since no exact date can be assigned to most of the pieces, the classification is based on the centre of the time spans given in the standard edition. Usually this does not yield dates of composition, because almost all of the fragments are copies, not autographs; but this is rather an advantage, because we are interested not in the latest musical innovations, but in the general repertory of each period. The time span that covers the middle of the second century AD (125–175) conveniently includes the period of Ptolemy's literary activity.

In the diagrams, the values according to our 'Lydian' interpretation are given by straight lines, while the lines indicating the results for the 'Hyperlydian' model are broken. Bold lines represent the simple octachords of Ptolemy's tables, whereas thin lines include the *hyperypátē*, which was likely present on actual instruments, as well. The two charts represent two op-

²⁹ Ptol., *Harm.* 2.11, p. 64.18–65.6: the 'thetic' central octave is Ptolemy's 'Dorian' central octave, within the range of which all his tunings are situated.

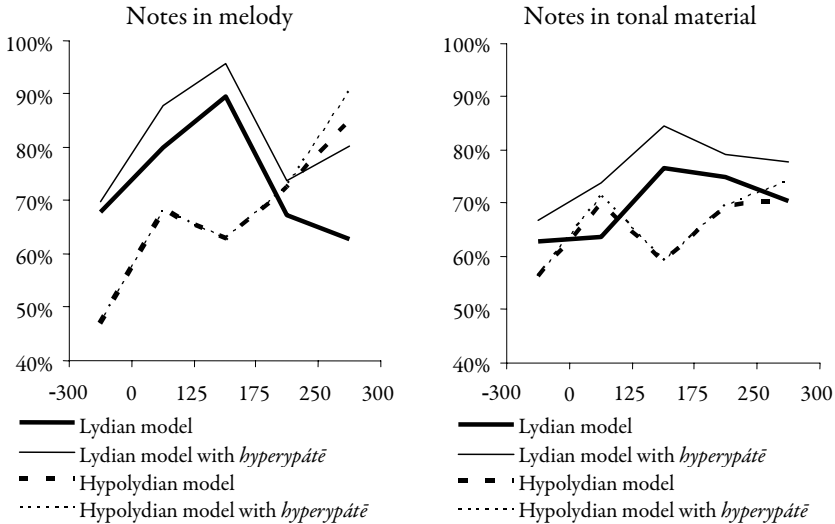

Diagram 18 Percentage of notes in musical documents as included in Ptolemy's tunings

tions of interpreting the material, each with its specific advantages and shortcomings. Into the graphics to the left there go all extant notes, one by one.³⁰ This means that longer fragments exert stronger influence on the results (which is rather an unwanted effect), but also that the different frequencies of the notes are reflected (an advantage, because notes rarely used in the melody are more likely outside the range of the instrument than are frequent ones). For the diagram to the right, the extant scale of each piece was established, and each note counted only once per fragment. Thus, all documents are treated as equal; but rare notes outside the usual range are given the same weight as the focal notes of the melody.

In any case, the general results obtained by both methods of evaluation are practically identical. In the period of special interest for us, the middle of the second century, the 'Lydian' model accounts much better for the contemporary music than Porphyry's 'Hypolydian' hypothesis. With *hyperypátē* included, 95.6 per cent of the notes that are preserved from that time can actually be played on our reconstruction of Ptolemy's cithara, but only 62.9 per cent on a 'Hypolydian' one. Thus, the case is clear: Ptolemy's ta-

³⁰ In the case of the early fragments, where iterated notes are not written in the source, they have nevertheless been counted for all syllables in question.

bles do indeed reflect the musical practice of his generation, just as he claims; and the 'Lydian' interpretation, which we have put forward on different grounds, is confirmed.

At the same time, the diagrams might bring us closer to an understanding of Porphyry's error. Towards the end of the second century things might have changed considerably; in the music of Porphyry's time a comparable tuning system yields better results if based on Hypolydian. This is not to imply that precisely such a system, tuned a fourth lower, had supplanted the earlier one; but it is possible that third-century music no longer provided the immediate clue to Ptolemy's work – if perhaps only because preferences for styles or genres had changed.

ABSOLUTE PITCH

In this context we have to address the question of absolute pitch. It has been observed that the extant melodies are on the whole compatible with the view that the ancient notation contained a notion of more or less fixed pitch. Diagram 19 displays how steady the musical documents' relative mean pitch generally remained throughout the centuries, with an average slightly above Phrygian *mésē* ΜΠ (of course this alone does not necessarily imply constant absolute pitch).³¹

With a model of fixed pitch, the same melody notated in different *tónoi* would be interpreted as lying in different registers of the voice.³² Indeed the very existence of the *tónoi* system was put forth as the main argument for fixed pitch.³³ As a point of reference, standardised pipes, flutes or whistles could have been used.³⁴ A system of resonators tuned to specific pitches (*ēkheía*) set up in a theatre would have enforced a standard pitch for the

³¹ The centres of the circles in the diagram indicate the average pitch of individual documents, their radii the number of notes in each of them (the assumed dates are the average of the span given in *DAGM*). For reasons discussed below, *DAGM* № 17 and № 32–7 are excluded. The bold line represents the linear regression through all extant notes ($y = -0.00036x - 1.46$, with 0 at Lydian *mésē* | <, and semitones and centuries as the respective units); its almost exactly horizontal orientation indicates that there is no suggestion of any regular change in the absolute pitch allocated to the notation system throughout the period in question (of course, it does not exclude individual variation).

³² Most extensively argued in *AGM*: 273–6.

³³ Cf. e.g. *AGM*: 273: "Otherwise there would be no reason to choose one key rather than another for a given piece of music, and far fewer symbols would be needed."

³⁴ Cf. the *tonarion* / *syringion* mentioned in Cic., *De or.* 3.225; Plut., *De cobib. ira* 456a; *Ti. Gracch.* 2.6; Quint., *Inst.* 1.10.27 (cf. Bélis/Delattre 1993: 140).

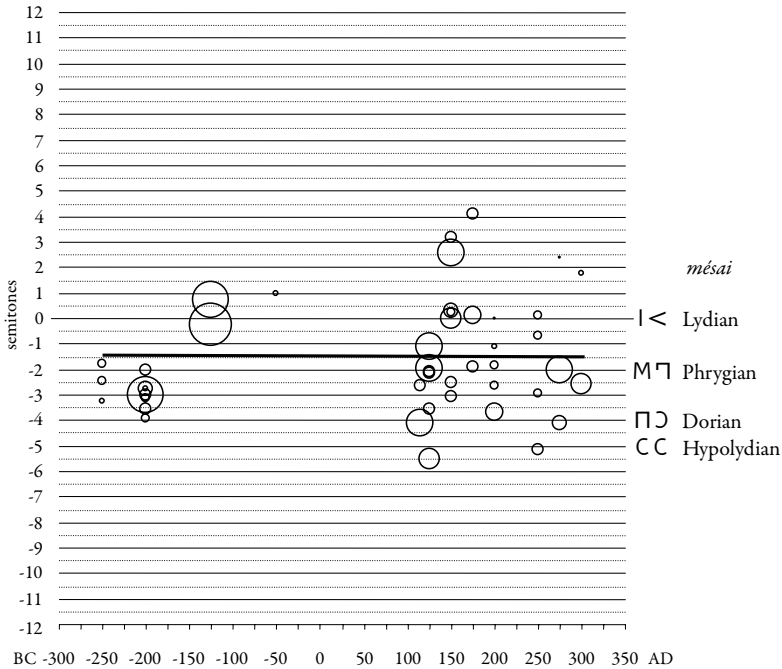

Diagram 19 Mean pitch of the musical documents

performances given there;³⁵ if virtuoso auletes took their instruments to different places, an international tuning standard would have been useful. There is also evidence about tuned resonators forming part of citharas, which would ensure fixed pitch without extraneous devices.³⁶

And yet reference instruments are never mentioned in association with a definition of *tónoi*. Instead, both Ptolemy and Aristides Quintilianus refer to the capabilities of the human voice as anchoring the tonal system within an in principle infinite space of pitch.³⁷ Especially interesting is Aristides' account, who describes nothing less than an algorithm for determining the appropriate *tónos* for a given melody. However, since both writers were pre-

³⁵ On the resonators described in Vitruv. 5.5, cf. below pp. 249ff. For *ékbeia* as sounding devices, musical or signal instruments, cf. e.g. Apollod. *ap.* Schol. Theocr. 2.35/36b; Ioann. Philop., *in de An.* 355.13–27 (instrument of slowly decaying sound); Schol. Aristoph., *Nub.* 291–2 (theatre thunder); Philo, *Quis rer. div. heres* 259 (instrument played by striking). For the ancient recognition of resonance, cf. also the experiment described in Aristid. Quint. 2.18, p. 90.2–5.

³⁶ Vitruv. 5.3 (*aeneis lamminis aut corneis* ἡχείοις); Hesych., s.v. ἡχεῖον, κάλαμος/κάλλιμος, κώδων.

³⁷ Ptol., as in n. 29 above. Aristid. Quint. 1.10, p. 21.13–22.10; cf. also Stob. 4.22.101.

sumably aware that the ranges of individual singers differ considerably, even if only adult male voices are taken into account,³⁸ their statements might be understood as qualifying the idea of 'fixed' pitch significantly: the pitch of the whole tonal system might have been taken differently by different performers. In this case, keys would mainly designate relationships, between each other and to a convenient vocal range. On the other hand, it is possible that Ptolemy and Aristides had in mind the 'average voice', such as it emerged in male choruses, put together from all kinds of voices, yet bound to perform one and the same melody together. Still, Aristides' wording clearly implies one individual judging the tonal range of a melody by means of his own voice.

Furthermore, we must not forget that such an 'individualistic' approach is all but natural for stringed instruments. The characteristics of tunings such as *lydia* or *iástia* were defined by the relative pitches of the strings, regardless of whether the instrument as a whole was tuned somewhat higher or lower. In informal solo performance, no citharode, citharist or private lyre player needed to bother about a pitch standard, as long as his instrument sounded well and fitted his vocal range. In any case, in the lyre players' minds, the *tónoi* were clearly linked to the tunings. Thus, there was no need to perceive them as being fixed in pitch. Of course, on other occasions stringed instruments were tuned to the pitch of a wind instrument with which they played together, and the environment of the theatre imposed definite pitches, wherever it included tuned resonating jars. But this would hardly obliterate a general conception of *tónoi* as tunings on the side of lyre players. The situation must have been largely comparable to modern guitar music: if the instrument is tuned in itself, it may differ significantly from standard pitch. Nevertheless the players will perceive, and talk about, the sound produced by a *C* chord fingering as a '*C* chord', even if an analysis of pitch would render it rather a *B* chord.³⁹ In any case, modern fixed pitch makes sense mainly in a music culture of ensembles and orchestras,⁴⁰ whereas ancient Greek music largely remained focussed on solo instruments.

Finally, it is perfectly possible that aulos music developed in the direction of fixed pitch, perhaps quite early, while lyre players maintained a relative, tuning-based conception, as reflected by Ptolemy. Such a view is sup-

³⁸ So expressly Ptol., *Harm.* 2.7, p.58.7–13.

³⁹ It may be added, that (as far as we know) no such tool as the capo, which sustains the guitar players' awareness of a correlation between pitch and key, was available for instruments of the lyre type.

⁴⁰ Even so, different orchestras could maintain different pitch standards, with varying reference pitches over the centuries.

ported by our earlier results, which suggest that lyre music never fully adopted the aulos-borne *tónos* notation represented by the full ‘enharmonic half’ of the notational system.

Vocal range

In any case, even if the pitch values indicated by the notation were not regarded as (ideally) fixed, they were certainly also not perfectly flexible, but confined to not all too wide a range. Consequently scholars found it possible, at the basic assumption of fixed pitch, to deduce a plausible standard from the corpus of extant melodies: the evidence suggests that the pitch of Lydian *mésē* | < was about that of modern *b* below middle *c*, or a little lower. Accordingly, Hypolydian *mésē* CC, the modern common point of reference, corresponds to about *f* sharp or *f*.⁴¹

These pitches are in good accord with the double octave of the Dorian key as covering the range of the (male) voice, as defined by Aristides. The Dorian *tónos* thus extends from about *G* an octave and a fourth below middle *c* to *g'* above middle *c*, which is suitable for a baritone voice.

A very similar passage in Bellermann’s *Anonymi*, however, refers to the Lydian.⁴² Here the triple octave is envisaged as the general ambitus of the human voice, and the Lydian double octave apparently presented as the standard melodic range – although the argument exhibits a certain lack of coherence.⁴³ This testimony should probably not be taken too seriously; but at least it illustrates once more that quite similar assertions could be made for ‘Dorian’ and ‘Lydian’.

There are, therefore, three positions, of which Ptolemy’s is in a certain sense intermediate. Bellermann’s *Anonymus* clearly indicates the Lydian *tónos* as the point of reference; Aristides specifies the Dorian (leaving no room for doubt that he is talking about the Dorian of the fifteen-scale system); and Ptolemy refers to the ‘Lydian’ of notational practice by the name of ‘Dorian’. What are the practical bearings of these differences? If Ptole-

⁴¹ Bellermann 1847: 54–6; *AGM*: 273–6.

⁴² Anon. Bell. § 94.

⁴³ The subsequent reference to the Hypolydian and Hyperlydian is barely compatible with the argument for the Lydian range. Furthermore, the triple octave might be taken from a context where not the range of the individual singer was in view, but that of the human voice in general, women and children included: Aristoxenus, in determining the largest melodic range actually in use (i.e. within one instrument), denies that the triple octave is accessible to the human voice (*Harm.* 1.20, p. 26.2–7).

within the scope of our reconstruction of the cithara tunings to which Ptolemy refers, from Lydian *hyperypátē* ΦF to *nētē diezeugménōn* ΘM . The Lydian double octave covers most, but not all, of the attested notes, while its higher part extends into a virtually unused region. Aristides' Dorian *tónos*, on the other hand, accounts for practically all attested notes.⁴⁶

It appears therefore that the reality of ancient Greek music is best described by a combination of Ptolemy's 'central' octave, reflecting the practice of cithara tuning, and Aristides' overall range, which describes the capabilities of the male voice. This implies that the cithara tunings corresponded to a rather high region of the voice, and that vocal melodies preferred this region, too. Nevertheless the highest notes were not used very frequently: the diagram shows that by far the greatest number of the melodies stayed within the lower part of the preferred gamut, between the cithara's *hyperypátē* and *paramésē*. This, now, is indeed the central region of the Dorian *tónos*, although it is not an octave. Aristides' account seems perfectly correct, whereas Ptolemy may have over-stated the 'centrality' of his central octave.⁴⁷

The asymmetric position of the tuning octave in a rather high region is echoed in the nomenclature of notes. The tetrachord above the 'central octave' acquired the designation '*hyperbolaion*', which unmistakably involves the notion of transgression and is associated with late fifth-century developments.⁴⁸ On the other hand, the tetrachord below *hypátē* carried no such stigma, purportedly being used already in earlier music.⁴⁹ This combination – a certain contempt for the upwards extension of the melodic space hand in hand with the feeling that a downwards extension is rather natural – also speaks for a high pitch of the range that is taken as a starting point.

The musical documents add to the picture. There it appears that the lower registers of the voice were used particularly for special effects. We

⁴⁶ The central octave of the Dorian *tónos* of the notation, which ranges from ΩM to ΓN , would not include the frequent U L : another indication that we must not equate Ptolemy's 'Dorian' with it.

⁴⁷ It should however be acknowledged that Ptolemy's cautious formulation does not imply a perfectly central position of the octave, nor that the 'Dorian' double octave as a whole were accessible to the voice (Ptolemy's Dorian owes its primary status mainly to its structurally central position within the seven keys). The 'middle melodies' are merely invoked as an explanation of why emphasis must be put on the central octave of the Perfect System (which is crucial for Ptolemy's general argument).

⁴⁸ For its possible origin in aulos overblowing, cf. Hagel 2005a: 82–6, with reference to ps.-Plut., *Mus.* 1142a. Cf. also the appellation (probably derogatory) '*Hypertonidēs*' bestowed upon some Philoxenides (or Theoxenides according to *Suda*, s.v. $\chi\acute{\iota}\alpha\zeta\epsilon\upsilon\upsilon$), prominent for the artificiality of his music (Pollux 4.65).

⁴⁹ Aristox. *ap.* ps.-Plut., *Mus.* 1137d: the 'ancients' ($\text{o}\acute{\iota}$ $\pi\alpha\lambda\alpha\iota\text{o}\acute{\iota}$) excluded the *hypaton* tetrachord merely from Dorian music.

encounter low notes in programmatic melodic turns,⁵⁰ and in an especially nice example in connection with a prophecy.⁵¹

All this fits well into what we know about ancient Greek song culture, where pure, high voices were adopted as the aesthetic ideal.⁵² Obviously the employment of a rather high tuning standard ensured that even the lower notes of an average melody lay within a comfortable range.

Finally, we must consider the possibility of a bifurcation in the evolution of (more or less) absolute pitch assignment, associated with the 'citharistic' and the 'auletic' traditions of using the notation. If the original scale of the Lydian key remained associated with the 'Dorian' tuning in citharistic practice, it is conceivable that an 'auletic pitch' existed side by side with a, probably more flexible, 'citharistic' one. In the documents, this possible dichotomy might be reflected mainly in the opposition between the older 'enharmonic' half, which represents the auletic approach, and the 'chromatic' keys, which are intimately linked to the cithara tuning names found in Ptolemy. The Lydian and Hypolydian keys, which take part in both, must be treated separately, of course.

Diagram 21 compares the ranges of notes that are associated with each of the three groups.⁵³ Although there is noticeable diversity, it is not of the sort we would expect according to a simple model of pitch difference. The 'auletic' keys centre round M $\bar{\Gamma}$, the Phrygian *mésē* – obviously because the few pieces in question all belong to the Phrygian triad, since no single melody fragment in definitely Dorian notation has come down to us. Similarly, the Lydian peaks at its *mésē*, I<, with emphasis on the *mésōn* tetrachord down to CC. The 'citharistic' keys are generally close to the Lydian and Hypolydian, with which they belong together in the cithara tuning system: this is not surprising, either, since the greatest part of the respective data is from the Roman era. The similar peaks, however, dimly hint at a harmonic relationship that covers more than just a common ambitus.

⁵⁰ *DAGM* № 21 (Limienios' Delphic Paean), ll. 9–10 (the storms ceasing); 13 (the god moving in huge intervals); 20–1 (the ancient origins of Athens); 23 (religious inspiration); 29 (killing of Tityos). Where the melodic formula of a closing octave leap is involved, a programmatic intention is impossible to prove. But the composers of the Delphic Paean obviously meticulously coordinated the text with the melody; so Limienios was probably concerned about putting the right word where he wanted a certain melodic move, and vice versa; cf. Hagel 2000: 160–2; 73–4.

⁵¹ *DAGM* № 41, col. i.6, with comment on p. 136.

⁵² Cf. *AGM*: 42–6 (with reference to ps.-Aristot., *Aud.* 804a); 276.

⁵³ In order to enable comparison between the different keys, which use different individual signs, the contours of the diagram are calculated by representing the value for each note by a bell-shaped curve and subsequent addition of these (for convenience, the present diagram is based on normal distribution with note triplets corresponding to units on the x-axis).

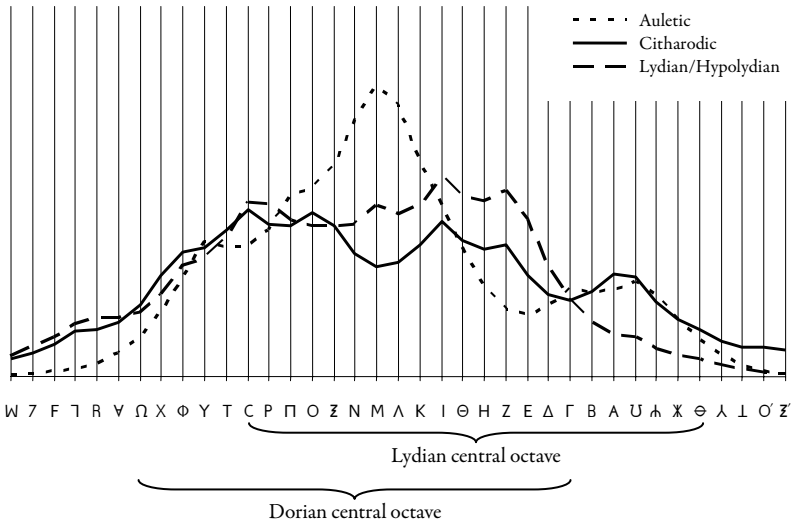
Diagram 21 Note ranges associated with *tónoi* groups

This variation in detail set aside, the overall ranges of all three groups do not differ much, especially not at their lower end. The characteristic peak of the 'auletic' keys is due partly to the chromaticism of Hellenistic music, with the *pyknón* above Phrygian *mésē*, partly to the virtual absence of the note H> from the extant melodies, which may be a coincidence.⁵⁴ We must conclude that the musical documents do not support the hypothesis of a difference in pitch standard between both halves of the ancient notation. On the other hand, an assertion of one pitch standard throughout is also not possible, because there is far too little Hellenistic evidence.

In any case, we have seen that the traditional theory of absolute pitch, as inferred from the fragments, is perfectly consistent with our reconstruction of Ptolemy's tunings. But there is another aspect, which ought not to be overlooked.

⁵⁴ H is probably written twice in Pap. Vienna G 29 825 a/b recto (*DAGM* № 9), and almost certainly once in the Mylasa inscription (*DAGM* № 22). Cf. however below, p. 354 with n. 67.

Lyre range

In dealing with lyre tunings, scholars seemed sometimes to assume that any pitch is available just by choosing strings of appropriate thickness (and by adjusting their tension, of course). This is, however, not true. With a certain type of string, a given vibrating length allows only for a limited pitch range with acceptable tonal quality.⁵⁵ The highest usable note is determined by the material of the strings and the shortest vibrating length.⁵⁶ At a constant length, strings of a given material will break at a certain pitch, regardless of their diameter. On the other hand, strings of a given length must not exceed a certain diameter nor be slackened too much, or the sound becomes dull, and the pitch unstable.

On harps and lutes of all kinds, these problems are overcome by decreasing the vibrating length with rising pitch, either by the design of the instrument, or by means of stopping the strings against a board, often equipped with frets. Some kinds of ancient Near-Eastern lyres with a slanting yoke adopted a harp-like approach, although the variation in string length alone could account only for a small part of the required pitch differences.

All lyre types of classical antiquity, in contrast, adhere to a symmetrical design. All strings were roughly of equal length, the slight elongation of the lowest and the highest, caused by their fanning out towards the yoke, being entirely negligible.⁵⁷ As a consequence, the notes of the instrument must fall within the range that can be produced by strings of one specific length.

But are we in a position to reconstruct this range? Ptolemy lives almost on the verge of classical antiquity. By his time, a new wave of Oriental influence had permeated the Mediterranean world and led to the coexistence of musical instruments that had long been separated by cultural barriers. Although there is ample iconographical evidence from the Roman period, the ascription of instrument names to individual representations is extremely difficult, especially because we must reckon with false archaism and fantasy instruments in mythological scenes.⁵⁸

⁵⁵ These limitations are pointed out by Reinach 1896: 197 n. 1; Lawergren 1984: 172–3; Byrne 1993: 11; Landels 1999: 57–8.

⁵⁶ For the physics underlying the following discussion, cf. Abbott/Segerman 1974.

⁵⁷ Even with an unrealistically large fanning, the differences are not musically relevant: with a bridge–yoke distance of only 45 cm, a large span of 30 cm between the outermost strings at the yoke and a tiny one of 5 cm at the bridge (a fan of 31 degrees), the interval between two strings of equal thickness and tension, one spanning the shortest, the other the largest distance possible, amounts to mere 64 cents, about a third of a tone. Under more realistic assumptions, this (of course purely theoretical) interval drops below a tenth of a tone.

⁵⁸ Cf. Lawson 2008: 179–80.

Nevertheless there must have been an unbroken tradition at least of the cithara from classical Greece down to the Roman world, if only because there was a tradition of professional citharodes whose repertoire included pieces from famous composers such as Timotheus.⁵⁹

Ptolemy's *lyra*

There is, however, another complication: Ptolemy mentions not only the *kithára*, but also the *lyra*. Without doubt, he considered these to be two distinct types of instrument, because he used neither of the two terms to denote the general class that we are accustomed to address as 'lyres'. To express such a conception, he had to say *λύραις δὲ καὶ κιθάραις καὶ τοῖς ὁμοίοις*, "lyras, citharas, and the like".⁶⁰ Ptolemy makes sure that his tables accommodate the tonal structures of both instruments; his arguments, however, are more concerned with the cithara.⁶¹ The two types of lyre apparently played somewhat different kinds of music, as transpires from their association with different tunings.⁶² The most important difference, however, concerns the number of strings. When Ptolemy goes on to develop methods of implementing the full two octaves of the Perfect System on the experimental instrument, his words clearly imply that this ambitus was available only on the *lyra*:⁶³

... ὥστε προσποιεῖν τοῖς ὀκτώ φθόγγοις τοὺς ἑπτὰ τοὺς λείποντας εἰς τοὺς ἔν τῇ λύρᾳ δεκαπέντε τοῦ δις διὰ πασῶν μεγέθους...

(Ptol., *Harm.* 3.1, p. 83.7–9)

... in order to add to the [previously established] eight notes the seven of the double octave that are missing from the fifteen on the *lyra* ...

Ptolemy's application of the tuning tables to the instruments confirms this surprising fact. All his tables comprise merely one octave; in order to account for the double octave of the Perfect System as well as for the tunings, they come in two sets.⁶⁴ The figures of the first set, called 'from *nētē*', describe the central octave from *nētē* (*diezeugménōn*) down to *hypatē* (*mesōn*).

⁵⁹ Cf. *AGM*: 372; 381–2; Vendries 1999: 277–80.

⁶⁰ Ptol., *Harm.* 2.12, p. 66.19.

⁶¹ The extensive tests of Ptol., *Harm.* 2.11, p. 42–5, are based on cithara tunings exclusively.

⁶² Ptol., *Harm.* 1.16, p. 39.6–14; 2.16, p. 80.8–18.

⁶³ Cf. Solomon 2000: 128 with n.6; Redondo Reyes 2002: 666 n.663.

⁶⁴ Ptol., *Harm.* 2.15, p. 74–80.

The tables of the second set, which are titled ‘from *mésē*’, cover the structure of the lower octave of the Perfect System from *mésē* down to *proslambanómenos*, as well as the structurally similar higher octave from *nētē hyperbolatōn* down to *mésē*.⁶⁵ The cithara tunings, however, refer exclusively to the tables ‘from *nētē*’. In his specification of the lyra tunings, on the other hand, Ptolemy makes no mention about which kind of tables are to be consulted.⁶⁶ This makes sense only if here, too, a fifteen-stringed lyra is presupposed, to which both types of table apply.⁶⁷ On the other hand, it is clear that the same was not true for the cithara. Obviously, the strings of this instrument – or at any rate those that had to be readjusted – were confined to the central octave, or at least did not include a substantially greater range (although the addition of a note such as *hyperypátē* is perfectly possible, of course).

Can we identify Ptolemy’s cithara and lyra? The continual tradition of the art of *kitharōidōtē* and *kitharistai*, as well as the traditional focus on the central octave compels us to search for Ptolemy’s cithara among those instruments which are reasonably close in basic design to the classical and Hellenistic cithara. In any case, parallels are to be sought not so much in form but in playing technique and especially string length: it is a reasonable assumption that the relation between the instrument’s pitch and the singer’s voice underwent little change.

A much more difficult case is the lyra. Firstly, Ptolemy’s many-stringed instrument clearly does not stand in the tradition of the simple tortoise-shell lyre of the classical period, which we have come to connect with this name.⁶⁸ Secondly, a fifteen-stringed lyre can barely be played with the plectrum by muting the strings that are not to sound by the left hand, as has

⁶⁵ Ptol., *Harm.* 2.15, p. 75.1–6.

⁶⁶ The simpler matter of lyra tunings is dealt with before turning to the more complicated subject of the cithara, so that one cannot suppose a tacit extension of the ‘from *nētē*’ qualification.

⁶⁷ The second of the two seemingly incompatible arguments in Plut., *Plat. quaest.* 1008c (cf. n. 42 on p. 118 below), may support the present conclusion, since it holds true only for an instrument covering considerably more than an octave.

⁶⁸ The tortoise-shell lyre was still recognised as a *lyra*, but it was no longer the standard type of this name, so that an unequivocal reference had to be qualified; cf. Anton. Lib. 22.6 λύρα τῆ ἐκ τῆς χελώνης ‘the *lyra* made from the tortoise’. The sixteen tuning pegs found together with the tortoise-shell-shaped bronze casing of a sound box – on a lyre an almost certain indication of strings of equal length – would provide enough notes; but they were not necessarily part of one instrument (Behn 1954: 89 with Taf. 50f; cf. Vendries 1999: 74 with pls. 1 and vi1b; for the possibility of arranging them on one yoke, cf. Byrne 1994; Strauß 1994: 102, who expresses doubts whether the instrument was playable at all), and the casing has now plausibly been attributed to a lute (Lawson 2008: 182–5); cf. also the 16 pegs from Intercisa (Barkóczi *et al.* 1957: 477–8; 487–8).



Figure 1 The 40° Lyre
(from Byrne 2002b, Pl. 1a)

convincingly been inferred for the classical lyres.⁶⁹ Finally, the physics of strings make it hardly possible that lyres of otherwise constant structure were equipped with strings for the missing notes of the double octave, both below and above the old range. So we should feel entitled to look for an instrument of rather different design.

Possible candidates would be large lyres with slanted yokes,⁷⁰ such as those that turn up in Roman era iconography, primarily around Asia Minor, and have been described as the “40° lyre”, in accordance with the

⁶⁹ Even if every finger of the left hand touches two strings, twelve strings seem almost the maximum for this technique, at least if the plectrum is swept across all the strings. If it is not, on the other hand, octave doubling is made practically impossible (the respective strings sit at the opposite ends), so that the instrument would be deprived of one of its strongest effects.

⁷⁰ An association between the term *lyra* and the Near-Eastern *kinnarum* lyre with usually slanted yoke is established in the gloss κινυύρα· ἡ λύρα (ps.-Hdn., *Epim.* 65.3), where the definite article apparently indicates the identification of the terms; were the *kinnýra* perceived as merely one type of *lyra* in the generic sense of ‘lyre’, the article would be missing (cf. κичώριον· βοτάνη “chicory: a plant” two lines below).

approximate angle between yoke and base (cf. Figure 1).⁷¹ This instrument would comfortably accommodate two octaves, and moreover in the required relative pitch region.⁷² It was obviously plucked with the fingers. Problematic is only its consistent association with female players in the iconography; in any case, for our present purpose it suffices to show that by Ptolemy's time and within his cultural horizon there were lyres that are compatible with what can be deduced about his 'lyra'.⁷³ If, on the other hand, Ptolemy's lyra was of the 'Western' type, and thus equipped with strings of similar length, these should have been considerably shorter than those of the cithara.

But how is a lyra of about twice the ambitus of the cithara compatible with the latter being the virtuoso instrument par excellence? Obviously, ambitus, and even string number, are not the only factors that determined the perceived quality of the music. In his references to cithara tunings, Ptolemy often alludes to this instrument's capability for modulation; if it had more strings than the eight or nine required for one key, the rest would apparently provide the modulating notes. For the lyra, on the other hand, Ptolemy expressly attests fifteen strings covering two octaves. These are precisely the notes of one heptatonic scale, with no room for modulation. Consequently, the lyra was still in some sense the simpler instrument – and especially if it was usually played with bare fingers.⁷⁴

Constructing a history of strings: Boethius and Nicomachus

The present inference that additional cithara strings were inserted mainly for purposes of modulation seems, however, contradicted by a passage from Boethius, naming the inventors of strings exceeding the seven of Terpander's lyre.⁷⁵ Boethius follows a traditional conception (although the details are far from agreed);⁷⁶ but his account is exceptionally comprehensive, and

⁷¹ Byrne 1993 (20: "in my opinion this lyre is the most sophisticated string instrument of antiquity"); Byrne 1996; Byrne 2002b.

⁷² For the reconstruction of pitch ranges, cf. n. 103 on p. 89 below.

⁷³ It goes almost without saying that *lyra* need not denote the same instrument in other writers, and the less, the further these are separated from Ptolemy in space and time: when, for instance, at about AD 400 Synesius sings a tune of the citharode Mesomedes "to the lyra" (*Ep.* 95, p. 161.9–13), a priori any kind of lyre can be meant.

⁷⁴ It is significant that Ptolemy recognises four different fine tuning schemes for the cithara, but only two for the lyra.

⁷⁵ Boeth., *Inst. mus.* 1.20, p. 205–9.

⁷⁶ The ancient authorities commonly hold that Terpander's lyre covered an octave with seven strings, whether or not he was believed to have established this number. The eighth string as filling in a gap

exceptional also because he specifies the scalar degrees associated with the added strings. Starting from the mythical origins, his succession of lyres runs as follows:⁷⁷

- 4 Hermes – Orpheus: $e - a - b - e'$.
 5 Coroebus of Lydia: fifth string
 6 Hyagnis of Phrygia: sixth string
 7 Terpander of Lesbos: $e - f? - g? - a - b^b? - c? - d$
hypátē, parhypátē, likhanós, mēsē, 'paramēsē' = trítē, paranētē, nētē
 8 Lycaon of Samos: $e - f? - g? - a - b - c? - d? - e'$
hypátē, parhypátē, likhanós, mēsē, paramēsē, trítē, paranētē, nētē
 9 Prophrastus of Pieria:⁷⁸ $D - e - f? - g? - a - b - c? - d? - e'$
hyperypátē, hypátē, parhypátē, likhanós, mēsē, paramēsē, trítē, paranētē, nētē
 10 Histiaeus of Colophon: tenth string = *parypátē hypatón*
 11 Timotheus of Miletus: $B - C? - D? - e - f? - g? - a - b - c? - d? - e'$
hypátē hypatón, parypátē hypatón, likhanós hypatón, hypátē, parhypátē, likhanós, mēsē, paramēsē, trítē, paranētē, nētē

In what follows, Boethius forsakes the concept of an evolution carried forth by outstanding individuals, but goes on to describe the larger systems of theory: first a conjunct variant of the 'Timotheus' tuning ($B - C? - D? - e - f? - g? - a - b^b? - c? - d$), then the addition of the *hyperbolaíon* tetra-

in the upper range is associated with Simonides (*Suda*, s.v. Σιμωνίδης: προσεξέυρε ... τῆ λύρα τὸν τρίτον φθόγγον), the ninth once with Timotheus as its inventor (which establishes too late a date: Pliny, *NH* 7.56, § 20.4: *septem chordis primum cecinit iii ad iiii primas additis Terpander, octavam Simonides addidit, nonam Timotheus*), or with Phrynis as using nine instead of seven strings (Plut., *Agis* 10: Φρύνιδος τοῦ μουσικοῦ σκεπάρνω τὰς δύο τῶν ἐννέα χορδῶν ἐξέτεμε; *De prof. in virt.* 8.4a: Φρῦνιν μὲν γὰρ οἱ ἔφοροι ταῖς ἑπτὰ χορδαῖς δύο παρεντεινάμενον ἠρώτων πότερον τὰς ὄνωθεν ἢ τὰς κάτωθεν ἔκτεμειν αὐτοῖς ἐθέλει παρασχεῖν; *Aporoth. Lac.* 220c: Ἐκπρέπης ἔφορος Φρύνιδος τοῦ μουσικοῦ σκεπάρνω τὰς δύο τῶν ἐννέα ἐξέτεμεν, εἰπὼν μὴ κακούργει τὴν μουσικὴν); cf. Procl. *soph. ap. Phot.*, *Bibl.* 320a. Pausanias plausibly attributes an eleven-stringed lyre to Timotheus, although the alleged addition of no fewer than four strings at once is probably a wrong inference (3.12.10: ἐνταῦθα ἐκρέμασαν οἱ Λακεδαιμόνιοι τὴν Τιμοθέου τοῦ Μιλησίου κιθάραν, καταγνόντες ὅτι χορδαῖς ἑπτὰ ταῖς ἀρχαίαις ἐφεύρεν ἐν τῇ κιθαρωδία τέσσαρας χορδὰς); but cf. ps.-Plut., *Mus.* 11.41c. In *Frag. Cens.* 12, p. 76.1–9, strings and tetrachords are confused into an impossible diadoche; Timotheus is credited with *paramese* (reflecting the introduction of the – ungappped – octave scale, which Nicomachus attributes to Pythagoras) and 'hyperbolaeos' (which transforms the – auletic? – tetrachord into a cithara string). In contrast to the 'archaising' opinions, Schol. Arat. 2.69 gives nine strings already to Orpheus, the first non-god to play the lyre; cf. also Schol. German. 83.21–84.4. Iconography is not a reliable guide to string numbers; cf. Maas 1992: 86–7.

⁷⁷ I indicate (relative) modern note names where they can be derived from Boethius' text, from his specification of either the intervallic relations or the position of the disjunctive tone. The 'movable' inner notes of the tetrachords are labelled according to their pitch in the diatonic, with question marks. The lists of ancient note names reflect those given by Boethius.

⁷⁸ Read *Pieriotēs* (?) instead of the manuscripts' *Periotēs* (1.20, p. 208.10–11); cf. below *Exc. Nicom.* 4, p. 27.4.3 Πιερίτης (cf. St. Byz., s.v. Πιερία).

chord and finally of the *proslambanómenos*, resulting in the fully developed Greater Perfect System with its fifteen notes. Interestingly, the Lesser Perfect System is given merely in its incomplete variant, without *proslambanómenos*.

It is generally agreed that the source for the first books of Boethius' musical treatise is Nicomachus of Gerasa's *Introduction to Harmonics*,⁷⁹ which is lost except for some excerpts, whereas we possess his earlier and much shorter *Handbook*. Nevertheless, and although Boethius has been described as following his sources quite closely, we cannot project the described evolutionary scheme to Nicomachus one to one. Several points are of interest in this context. Firstly, Boethius expressly mentions Nicomachus as the source for an original four-stringed music.⁸⁰ Such explicit quotations of the source he is implicitly working upon all the time are found on occasions where Boethius is aware that this source deviates from commonly accepted views.⁸¹ In the present case, he apparently expresses his reservations about the mythical and half-mythical account, and he was certainly compelled to do so in the case of a pagan deity as the inventor of the lyre. Unfortunately, we cannot determine the extent of his reference with certainty; at any rate, the wording suggests that Boethius refers merely to the earliest stages. Of course, the first supplements stand and fall with the assumption of a four-string phase, so that we must infer that the evolution from Hermes to Terpander is also taken over from Nicomachus.⁸² Notably, the details of this process remain obscure. Mere addition of strings will not produce the desired results, since Hermes' 'original' lyre is said to span the octave, while Terpander's instrument covers only a seventh. According to Nicomachus' *Handbook*, the eighth string was introduced not by some Lycaon, but by

⁷⁹ Cf. esp. Bower 1978; also, Bower 1984: 256–7; 1989, xxiv–xxix.

⁸⁰ Boeth., *Inst. mus.* 1.20, p. 205.28–206.6: *Simplicem principio fuisse musicam Nicomachus refert adeo...*

⁸¹ Bower 1978: 4.

⁸² Even so, the present account cannot be reconciled with the report found in *Exc. Nicom.* 1, p. 266, where the lyre is constructed with seven strings from the start, and passed directly from Orpheus to Terpander. Note, however, that this first paragraph of the so-called *Excerpts* does not betray its source (Franklin 2006b: 55 n. 41: "...has all the marks of fifth-century logographic rationalisation"). If it stemmed from Nicomachus, the bracing φασί would have to be a direct quotation (at the end of the paragraph, one should perhaps read παραλαβείν τηρικαυτά φασί without punctuation, "the Greeks are said to have received [the lyre] from Cadmus just at that time"); but the simple short sentences of the paragraph do not resemble Nicomachus' style at all. Nicomachus as the source is explicitly identified only at *Exc. Nicom.* 3, p. 271.16, where, as transpires from many manuscripts, material starts that is quite different from that of the first paragraphs; cf. Mathiesen 1999: 392–3 and 235 n. 174. On top of this, Nicomachus' views seem inconsistent: on one occasion he attributes the invention of the disjunctive tone as the eighth note to Pythagoras (*Ench.* 5, p. 244–5), on another to a time when there was already a system of thirteen notes (11, p. 257.17–20); although he gives a reference to the previous passage, he fails to address the obvious contradiction (cf. Levin 1995: 160).

Pythagoras himself. But the way in which this is done is described so similarly by Boethius that we ought not to assume another source. Presumably Nicomachus attributed the idea to Pythagoras, but the adoption and dissemination to a musician fellow-countryman of the philosopher.

So far, the list is obviously almost pure construction. It betrays a programme, in which a traditional awareness of a common lyre culture of the Indo-European peoples round the Aegean and the appreciation of foreign contributions to Greek music are distilled to a geographical diadoche: from Thracia, the art of the lyre is passed on to Lydia and to Phrygia, whence it enters the Eastern Greek colonies.⁸³

For the next three strings, we have more direct evidence: a paragraph that is clearly excerpted from Nicomachus' *Introduction*, since it presents the same set of names as Boethius:

ὅτι ὅσοι τῇ ὀγδόῃ χορδῇ προσκαθῆσαν ἑτέρας, οὐ λόγῳ τινί, τῇ δὲ πρὸς τοὺς ἀκροατὰς ψυχαγωγία προήχθησαν. ὥσπερ δὴ καὶ (Πρό)φραστός τε ὁ Πιερίτης τὴν ἐνάτην χορδὴν προσκαθῆψε, καὶ Ἰστιαῖος τὴν δεκάτην ὁ Κολοφώνιος, Τιμόθεος ὁ Μιλήσιος τὴν ἐνδεκάτην, καὶ ἐφεξῆς ἄλλοι. ἔπειτ' εἰς ὀκτωκαιδεκάτην ἀνήχθη χορδὴν τὸ πλῆθος παρ' αὐτῶν. [...] ⁸⁴ Αἱ μὲν οὖν πᾶσαι χορδαὶ κατὰ τὰ τρία γένη [εἴτε καὶ πλείω] εἴκοσι καὶ ὀκτώ τὸ πλῆθος.
(*Exc. Nicom.* 4, p.274.1-12)

That those who adjoined other notes to the eighth were led not by some sort of reason, but by the art of beguiling the listeners: thus Prophrastus of Pieria adjoined the ninth note, and Histiaeus of Colophon the tenth, Timotheus of Miletus the eleventh, and so on, one after another. Subsequently they raised the number of notes to eighteen. [...] So all notes in the three [or perhaps more] genera amount to twenty-eight.

Still, there are marked differences. Nicomachus treated the multiplication of strings as a moral issue; this is implied as the topic of the paragraph,⁸⁵ although the necessary explanations are missing in the excerpt. No trace of this view is discernible in Boethius' detached relation, which is reduced to a mere list of facts. Moreover, the figure eighteen, which the *Excerpts* state as the final number of strings, does not appear in Boethius at all, neither explicitly nor implicitly. Of course, there are eighteen notes in the Unmodulat-

⁸³ On the 'musical revolution' associated with the name of Terpander, and its possible oriental connections, cf. Franklin 2002a; 2002b; 2006a; 2006b; for the European / Anatolian lyre culture, cf. Lawergren 1993; 1996; 1998; Hagel 2005b: 341-2.

⁸⁴ The intervening sentence is apparently a gloss (on the person of Timotheus) that does not belong to the excerpted text.

⁸⁵ The process of adding strings is presupposed in the relative clause; the first sentence, introduced by ὅτι, is most likely close to Nicomachus' wording.

ing System, the combination of Greater and Lesser Perfect System. Curiously enough, in the face of its primary importance for most Greek music theory, Boethius does not address the Unmodulating System, although he is otherwise eager to provide an unnecessarily complete account, including lists of such minute differences as the Greater Perfect System with and without *proslambanómenos*.

Congruence is attained once more when it comes to the most extensive list of all, that of the twenty-eight notes of the Unmodulating System in all three genera.⁸⁶ All in all, Boethius doubtless follows the structure of Nicomachus' treatise, but with considerable variation in detail, at least in this chapter.⁸⁷

But let us consider the general outline of the argument. Both writers start with a lyre of comparatively few strings, follow the track of an alleged organological evolution, to end up with a complete account of the tonal material within one key. Neither of them goes so far as to assert that anybody had ever strung a lyre according to this full system of twenty-eight notes.⁸⁸ At some point, there is therefore a transition between the organological model and the contemplation of abstract scales; at least in the case of Boethius, this transition is silent. It is made possible by the ambiguity of *χορδή* / *chorða*, which designates the actual 'string' on the instrument as well as the abstract 'note'. Without making it clear, Nicomachus and Boethius duplicate the semantic evolution of the term.

As a consequence, we must treat the information of both the *Excerpts* and Boethius with extreme caution. Boethius does not consider an eighteen-stringed lyre – although he may be understood as implying a fifteen-stringed one. We can therefore assume that he found no prominent reference to eighteen lyre strings in Nicomachus. Consequently, the eighteen strings of the *Excerpts* are perhaps only a misunderstanding. Just as we

⁸⁶ Boeth., *Inst. mus.* 1.22, p. 214–16.

⁸⁷ Since his *De institutione musica* is not expressly a translation (such as *In Isagogen Pophyrii commenta* or the *De institutione arithmetica*), and the material does not require pursuing such a narrow track as is often inevitable in a mathematical treatise, one need not assume that Boethius stayed as close to his source here as in his other early works. Even so, the differences which we infer in the following fall readily into the scope that F.E. Robbins formulated for the *De institutione arithmetica*: "... Boethius follows Nicomachus from first to last, expanding here and condensing there ... but never adding anything essential, either original or derived from other sources, that departs from his model" (D'Ooge 1927: 132). For Boethius' extensive lists of *systemata* of growing size, cf.: "... Boethius more often expands than condenses. His method is to intersperse between sections literally translated, or closely paraphrased, others in which the general principles stated by Nicomachus are furnished with exhaustive explanation ... Boethius also supplies data in tabular form to a far greater extent than did Nicomachus" (133).

⁸⁸ Cf. Sachs 1924: 291.

might read a fifteen-stringed lyre into the text of Boethius, because the abstract system is developed so far, the writer of the *Excerpts* might have wrongly extended the scope of the lyre model to include Nicomachus' account of the Unmodulating System.

On the other hand, the *Excerpts* do not associate the three strings added by Prophrastus, Histiaeus and Timotheus with note names. One cannot argue *ex silentio*; but at any rate there is no positive evidence that Boethius took over the specific identifications from his source. In this context, Nicomachus' reproach of those who decided to use more than eight strings is of great interest.⁸⁹ The notion of serving only the pleasure of the (less erudite) public is commonplace and goes back at least to Plato – but what does Nicomachus mean by οὐ λόγῳ τινί, “not by any *lógos*”? Should we simply translate “not according to any rationale”; or perhaps, more specifically, “not according to any [numeric] ratio”? What is this rational background that contrasts with the mere appreciation of music as gratifying? If interpreted along Boethius' lines, it can only relate to the extension of the musical system beyond the octave. But what should be unreasonable about this? If it is argued that any additional note merely duplicates the function of its counterpart one octave apart, the completion of the octave would already have been a step in the wrong direction. But Nicomachus celebrates the introduction of the octave as a major advance, achieved by the most revered Pythagoras. Not even Ptolemy, who restricts the number of keys to seven to avoid functional duplication,⁹⁰ sees any problem in adopting the usual two-octave system. On the other hand, an interpretation of *lógos* as ‘numeric ratio’ is also impossible in the context of ambitus extension. On the contrary, some of the ratios traditionally recognised as musically important by Pythagorean writers can be incorporated only within an increased tonal range.⁹¹

The statement obtains a very specific sense, however, if no simple extension of the scale is envisaged, but the insertion of modulating notes within the original octave. A numeric representation of modulating tunings always requires uncomfortably large numbers.⁹² Moreover, once functionally different notes come to be played on the same string, a ‘Pythagorean’ analysis of the music becomes plainly impossible: music no longer adheres to *lógos*

⁸⁹ That the phrase οὐ λόγῳ τινί, τῇ δὲ πρὸς τοὺς ἀκροατὰς ψυχαγωγία is taken over from Nicomachus is highly probable not only on stylistic grounds, but also because it appears in the introductory ὅτι-clause (cf. n. 85 above).

⁹⁰ Ptol., *Harm.* 2.9, p. 60–2.

⁹¹ These are the multiple ratios above two, the twelfth (3:1) and the double octave (4:1).

⁹² Cf. Hagel 2005a: 58 with n. 21.

in the Pythagorean sense. So a careful interpretation of the two texts that depend on Nicomachus' *Introduction* suggests that both misunderstood their source, in which a general reaction against modulating music along traditional lines was followed by, but not clearly set apart from, an account of the 'evolution' of the Unmodulating System by adding tetrachords to the central octave of traditional lyre tuning.⁹³ Whether Nicomachus himself realised that both arguments, which he may have adopted from different sources, were not quite compatible, is doubtful. Boethius, in any case, who was concerned only with the more technical and systematic side, conflated the two accounts by assigning the innermost strings of the first new tetrachord to the three musicians each credited with adding one string to the cithara. He might have been induced to do so by a (correct) reference to the ninth string as *hyperypátē* (by him identified with *likhanós hypatōn*⁹⁴) – whence he would have felt entitled to complete the *hýpaton* tetrachord with the tenth and eleventh string. Moreover, a non-modulating fifteen-stringed lyra as described by Ptolemy might still have been current in Boethius' time. In the sixth century, it would be no wonder if he confused this instrument with the cithara of classical music.

That neither the evolution of the latter nor the tonality of the former is adequately addressed by Boethius and the *Excerpts* becomes entirely clear from earlier sources. Firstly, the references to the disjunctive tone show that Boethius conceived of the many-stringed tunings as a structurally fixed series of notes, at best to be taken in the different genera. Yet it is obvious that there were always different ways of tuning the given number of strings. The most lucid evidence is the tuning tables of Ptolemy, Nicomachus' contemporary, which show that the disjunctive tone could occupy several positions, in the double octave of the lyra as well as on the cithara. Boethius' view is therefore misguided; but it is less likely that the same kind of misconception should have occurred to a second-century author such as Nicomachus.⁹⁵

⁹³ Cf. also the wording in Nicom., *Ench.* 11, p. 256.5–11: τῆ τοίνυν ἀρχαιοτρόπῳ λύρῃ... προσήψαν ἄλλα δύο τετραχόρδα "they supplemented the lyre of the old style... with two tetrachords", whereby the transition from the instrument to abstract scales is effected. Remarkably, Nicomachus here dates the conception of the *hyperbolaion* and *hýpaton* tetrachords before the insertion of the disjunctive tone, which he has attributed to Pythagoras (cf. n. 5 on p. 104 below): so much for his value as a historical source.

⁹⁴ Cf. Hagel 2000: 89–90 with n. 139.

⁹⁵ Adrastus, *ap.* Theon, *Util. math.* 51, treats the extension of ambitus as an organological development, too – but notably he explains the note names *hypátē* and *néte* in terms of the eight-stringed lyre, while he attributes the extended systems to unnamed instruments: πολυχόρδων καὶ πολυφθόγγων γεγονότων ὀργάνων (not τῶν ὀργάνων: these are perceived as new instruments rather

Secondly, in the period in question, towards the end of the fifth century BC, additional strings were evidently introduced for modulating purposes and not for mere extension of ambitus. Ion of Chios praises the modulating capabilities of the eleven-stringed lyre,⁹⁶ and the comic poet Pherecrates makes fun of the composers who have plenty of *harmoniai* within their up to twelve strings.⁹⁷ By Nicomachus' times, the cithara was still not reduced to simple scales: Ptolemy, as we have seen, mentions the 'modulating' tunings as a perfectly common feature of citharodic music. Consequently, we can hardly suppose a complete lack of knowledge both of music history and of contemporary practice on the part of Nicomachus. Even if he was thinking of a many-stringed lyra of the type Ptolemy has in mind rather than of the cithara, he is unlikely to have overlooked the fact that such instruments were tuned in more than one way. On the other hand, when Boethius and the author of the *Excerpts* were writing, the citharodic tradition that had continued to flourish in the first centuries of our era had almost certainly undergone substantial changes. Similarly, the 'Ptolemaic' lyra, if it still existed, might have been used differently.⁹⁸ Much of the knowledge of these late authors derived from handbook theory depending on the musical culture of a then remote past; thus, they were prone to misunderstandings and simplifications.⁹⁹

than a developed continuation of earlier forms!), "when instruments of many strings and many notes were created".

⁹⁶ Ion of Chios *ap.* Cleonid. 12, p. 202.14–17. Cf. Levin 1961; Baud-Bovy 1978: 170–1; West 1981: 128 n. 86; *AGM*: 227; West 1992a: 23–8; Hagel 2000: 52–3. Anderson (1994: 109–12) proposes that ἐνδεκάχορδῆ might refer not to eleven strings but eleven notes elicited by a new playing technique; but since the adjective refers to the lyre it is the instrument that has acquired new capabilities. On Maas 1992: 76, cf. Anderson 1994: 109 n. 42. For a socio-political discussion, cf. Power 2007.

⁹⁷ Pherecrates *ap.* ps.-Plut., *Mus.* 1141d–1142a; cf. Restani 1983 (with references to earlier contributions); Restani 1984; *GMW*: 237–8; Hagel 2000: 83–7. In Pherecrates, we might also read "twelve notes" rather than "strings"; but the comic effect suggests understanding the physical strings.

⁹⁸ Of course, instruments of the lyre type were still in use, and Boethius was a recognised expert on contemporary citharody (Cassiod., *Var.* 2.40); but the disappearance of notated music from the record after about AD 400 testifies to a change in music culture. Perhaps pieces such as Mesomedes' hymns were still sung (cf. above p. 80, n. 73); but these represent a much simpler type of music. Possibly Boethius' musical environment also comprised the heritage of Ptolemy's *lyra* with its extended compass but restricted tonality, just as we find non-modulating music later in the middle ages.

⁹⁹ For a failure of Boethius to grasp a rather essential point – he presents the interval *B–f* as a fifth – cf. Kunz 1936: 10–11; for his inadequate renditions of argumentative structures, Kunz 1936: 8–10; Hagel 2001: 92–3.

Lyre physics

Instruments are generally built so as to produce an optimal sound, at least if the relevant parameters are obvious and easily optimised. String length and tension are without doubt of this kind. The Greeks built lyres of different sizes; nevertheless the iconography indicates that at least the main types came with largely standardised vibrating lengths. On realistic representations the string length can often be gauged against the forearm of the player. Especially when the instrument is held against the chest in playing position, we can expect that the proportions between the player's body and the instrument are portrayed with reasonable accuracy (a special problem, however, is the bridge, whose position and size may be represented inaccurately, even in cases where it is clearly marked¹⁰⁰). Still, the value of such measurements must at first be doubted; only if there is concurrent evidence from more than one side may we adduce them as additional evidence.

In order to ensure an unbiased foundation of any statistical evaluation of iconographic evidence, the measurements must be carried out on a well-defined set of representations. For convenience I have chosen those illustrations in Maas/Snyder 1989 on which both the distance between bridge and yoke and the length of the forearm of the person holding the instrument can be determined (in special cases I have used the forearm of an adult in immediate context with the player instead). This sample is just sufficiently large. The average adult body height of ancient Hellenic men has been determined as about 168 cm;¹⁰¹ we can safely base the calculations on this value, since a few centimetres more or less will not yield relevant pitch differences.¹⁰² From the given body height, we extrapolate a forearm length between elbow and main finger joint of 36.9 cm – these two points are conspicuous on almost all representations. Based on these absolute figures, my measurements translate to an open length of the central cithara string of $s = 43.4$ cm, with a standard deviation of $\sigma = 4.6$ cm. An analogous review of lyra strings gives the astoundingly similar value of $s = 43.5$ cm, with $\sigma = 5.7$ cm. The coherence of the two results raises confidence in the

¹⁰⁰ Cf. Lawson 2005: 103–6 on medieval lyres, where representations can be checked against finds: bridges were pictured much too large. Greek art is, however, not liable to serious proportion mismatches of whole instruments such as found in medieval representations.

¹⁰¹ Communication by S. Psaroudakēs, based on various surveys, *inter alia* Poulianos 1960; 1971. Cf. also Sarti 2003: 48 with n. 8.

¹⁰² One may reasonably assume that representations are oriented towards a body height slightly above average, in accord with an ideal of tall people (cf. the late-fifth-century burial of a 174 cm tall young man with a lyre, Forstenpointner *et al.* 2001). But even if a barely realistic 10 cm were added, the resulting pitch would be merely a semitone lower.

method and its underlying assumptions, namely (1) that the proportions between player and instrument in vase paintings are, on average, reasonably accurate, and (2) that the error involved in taking measurements from projections of curved surfaces to flat photographs is not accumulated: whereas citharas are almost always depicted in approximately upright position, lyras are more frequently shown tilted or horizontal, so that the measurements for the two instruments are affected by surface curvature quite differently. If the data for both instruments are taken together, we can assert with 95 per cent confidence that the derived average string length deviates from an assumed 'true' value by less than a semitone.¹⁰³

The quality of sound of a given string increases with pitch and is best slightly below breaking tension. The designation of lyre sound as λιγύς, 'clear, high, shrill', testifies to the currency of the respective aesthetic ideal from Homeric times on. With gut strings on lutes and violins, it is generally suggested to tune the highest note a minor third below the breaking point.¹⁰⁴ The rather violent plectrum action¹⁰⁵ on the ancient lyre might however have necessitated a slightly lower pitch. There is no doubt that the tuning devices supported such high tensions; as my experiments have shown, they could be achieved even on the more archaic collars before the introduction of tuning pegs.¹⁰⁶ Thus, we must assume that, just as in the case of later stringed instruments, the vibrating length of the cithara strings was kept just as short as necessary to yield the desired treble note, while on

¹⁰³ $f(40.9 \leq s \leq 45.9) = 1 - 0.05$; these differences in length correspond to a deviation in pitch of ± 97 cents. With a confidence of 99 per cent, our result for the string length in relation to forearm length is accurate to 132 cents, or two thirds of a tone. — In a similar way values for the 40° lyre can be obtained: for the longest string, an average length of $s = 68.9$ cm, with a standard deviation of $\sigma = 6.8$ cm; for the shortest string, $s = 24.9$ cm, $\sigma = 4.2$ cm (measurements taken from the illustrations in Byrne 2002b, namely from: Egyptian Mus. Berlin Inv. Nr. 21433; Bursa, Arch. Mus. Inv. Nr. 1421; Sotheby's 17 May 1965 Lot No. 194; Damascus, Nat. Mus. Inv. Nr. 5314/2650; Istanbul, Arch. Mus.). Strings of similar material as on the classical cithara will yield notes about a minor sixth below the lowest note of the cithara to about a major sixth above its highest note. If the cithara covers about the central octave from *hypátē* to *nētē*, the extension to the double octave needs merely a fifth downwards and a fourth upwards. Note that the assumption of a specific forearm length does not affect the relative intervals between the instruments.

¹⁰⁴ Cf. Abbott/Segerman 1974: 61, who find that a second may suffice.

¹⁰⁵ Cf. *AGM*: 68, with reference to Lucian, *Ind.* 9.

¹⁰⁶ In an unintentional experiment it has proven perfectly possible to break a treble gut string of 0.8 mm diameter on a textile collar rotating round the yoke even without the help of a pin inserted into the collar to act as a lever (on tuning collars, tuning collars with pins, and tuning pins/pegs, cf. Roberts 1981: 305–8; Pöhlmann/Tichy 1982; Bélis 1985: 216–19; 1995: 1028–31; Lawergren 1984: 161; *AGM*: 61–2; Byrne 1994; Vendries 1999: 71–81; Lawson 2008: 160–1).

the other hand being as long as possible, in order to optimise the sound of the bass strings.¹⁰⁷

Thus, we can determine the highest pitch of the classical cithara with some accuracy. Calculations or experiments must however not be based on modern gut strings, whose tensile strength is augmented by chemical treatment.¹⁰⁸ It is therefore customary to extrapolate from the data for lute gut given by Mersenne in the seventeenth century.¹⁰⁹ For cithara and lyra strings of the specified length, the formulas give a theoretical breaking pitch of about 435 Hz, slightly below modern concert pitch *a*. Exceptionally good ancient strings might have been stronger; but the apparently identical string lengths of the non-professional tortoise-shell lyra imply that the desired pitches must have been available with rather ordinary material (the superior stress resistance of professional strings was perhaps taken advantage of rather for minimisation of breaking risk even at especially emphatic playing). The highest usable pitch must have been about a minor or major third lower, between *f* sharp and *f* above middle *c*.

According to our interpretation of Ptolemy's account, the respective lyre treble string was the citharodic *nētē*, i.e. the Lydian *nētē diezeugménōn* Θϣ. Thus we can compare the pitch resulting from our study of the iconographic evidence with the pitch that has been inferred from the musical fragments. According to the traditional interpretation, the note Θϣ, which stands at an octave above the usual point of reference CC, also corresponds to a pitch between *f* sharp and *f* above middle *c*.¹¹⁰ Facing this perfect coincidence, which must raise suspicion given the number of not all too precisely defined variables that entered the calculation, it is essential to keep in mind that all the formulas and values (except for the measurements) have been taken over unaltered from independent sources. In any case, alternative interpretations of a 'Hypolydian' or 'Dorian' lyre are ruled out by the present results. They would require string lengths that diverge

¹⁰⁷ Cf. Abbott/Segerman 1974: 61–2: "The limiting factor on string length is the breaking stress of the treble string tuned to the highest pitch."

¹⁰⁸ Cf. Abbott/Segerman 1974: 49. Gut strings are well attested for antiquity (cf. Bélis 1995: 1033–5). Sinews are also mentioned (esp. Schol. Aristoph., *Ran.* 231; cf. Hägg 1989: 59); but the frequent designations as νεύρ-/neru- seem to derive mainly from the analogy to the bow-string. In *Anth. Pal.* 11.352 (Agathias), for instance, the strings are called νεῦρα and νευρία, but are all fabricated from sheep gut (τὰ νευρία πάντα τέτυκται ἐξ ὄϊος χολάδων; μή τις γαστρὸς ἔδοντα). In Aristot., *Gen. anim.* 787b, νευρίνην need not belong to the simile. Gut is the older material (*Od.* 21.406–8), was never abandoned, and must suffice for the present evaluation, since data for sinew strings seem unavailable.

¹⁰⁹ Cf. Lawergren 1984: 172–3, for the 'cylinder cithara'; Landels 1999: 58; 65–7 (assuming too short strings for cithara and lyra).

¹¹⁰ Cf. above, p. 71.

from the established figures by 27 per cent or more; such an error is barely conceivable.

Still, our data are obtained mainly from vase paintings which predate Ptolemy by many centuries. Even if we accept that the classical cithara conformed to a 'Lydian' pitch standard, can we reasonably bridge such a chronological gap? The traditional nature of the citharodic art suggests so. The preservation of the works of famous composers within a kind of standard repertory is hardly compatible with the notion of a major break in instrument design: Hellenistic and (early) Roman period citharas probably included the possibilities of their predecessors at least as a subset. This has inevitable consequences on the evolution of instrument range. As we have seen, an upwards extension of pitch would have required shorter strings. As long as the characteristic design of the instrument, namely the principle of equal string length was maintained, this would have implied an upwards shift of the entire range, unless a new technique of bass string manufacturing allowed for acceptable low notes on shorter strings. I know of no evidence for a tendency to decrease the string length. On the other hand, taller instruments would inevitably have lost the capability of playing the traditional highest notes. Under these circumstances, it is only to be expected that the treble note remained constant as long as there is no major disruption in music culture; thus, the concurrence of Ptolemy and Attic vases is no miracle, after all.

Quite different is the case of the bass notes. They are not subject to a sharp limit analogous to the breaking point; but if the strings are too thick or slackened too much, their sound becomes dull (because the harmonics become ill aligned) and of unstable intonation (because the decrease of average tension together with that of the amplitude of string vibration leads to an audible pitch shift). For a given vibrating length, the lowest acceptable pitch depends, besides plucking position and strength, on the elasticity of the string; it can become significantly lower during an evolution of string making techniques such as high twist or overspinning. On plain gut strings of equal length, the available range spans about a tenth, if the strings are struck with the plectrum, and about a ninth, if plucked with the fingers.¹¹¹ It will be observed that this corresponds precisely to the interval between

¹¹¹ Abbott/Segerman's (1974: 64) equation (6) gives the ranges of 1380 and 1640 cents, respectively, under the following assumptions: plucking position at 15cm (from the yoke: left hand plucking) or 7 cm (from the bridge: plectrum action); a maximal string displacement of 6 mm at the plucking position (according to measurements on a replica); a pitch shift tolerance of 25 cents (Abbott/Segerman allow for 33 cents, but this seems too large in view of the fine tuning shades recorded by ancient authors).

hyperypátē and *nētē*, which is the most plausible range of the classical cithara as well as of the instrument Ptolemy has in mind.

With increased twist, lower notes would have become accessible, up to a maximum range of about two octaves.¹¹² Thus, the tonal space down to *proslambanómenos* (and further) could have been incorporated. Still, the *hyperbolaion* tetrachord would be available not from the open strings, but only by the production of first harmonics. It is unlikely that a lyre with strings of equal length and reasonable sound quality that cover the entire double octave of the Lydian Perfect System could be built, even with maximum twist.¹¹³ Thus, Boethius' record of ambitus expansion in the bass region may carry an element of genuine memory (or contemporary experience), after all, even if the connection with musicians of the modulating era is evidently misguided.

All in all, we must reject the idea of Greek *citharas* with strings for the double octave of the Perfect System. Ptolemy's octaves are certainly close to reality, although the instruments of his time probably spanned (at least) a ninth, also including the *hyperypátē*, whose name suggests an origin as an additional string rather than as an aulos finger hole or as an abstract scalar degree.

Conclusion

Diagram 22 compares all the relevant pitch ranges. Beneath the Dorian double octave as the range of the human voice according to Aristides, the central octaves of three *tónoi* are plotted: the Dorian, according to the prima-facie interpretation of Ptolemy's nomenclature, the Hypolydian, which seems to be Porphyry's interpretation, and which is also of interest because the Hypolydian has erroneously been understood as the 'basic' key of the notation in modern times, and finally the Lydian, which we have found actually to represent Ptolemy's 'Dorian'. Below the grey rectangles of these octaves, the extension to *hyperypátē* is indicated in white. The two black fields indicate which range of a given size covers a maximum number of the notes of the extant fragments. Finally, the inferred gamut of the cithara is indicated, with its well-defined upper and doubtful lower boundary.

¹¹² With the highest possible twist according to Abbott/Seegerman (1974: 51: a twist ratio of 2.25), one obtains a theoretical range of 2500 cents for left-hand plucking (assumptions as in n. 111).

¹¹³ If the string length is reduced to 32.5 cm, so that the treble string sounds the Lydian *nētē diezeugménōn*, the calculated left-hand plucking range drops to 2080 cents.

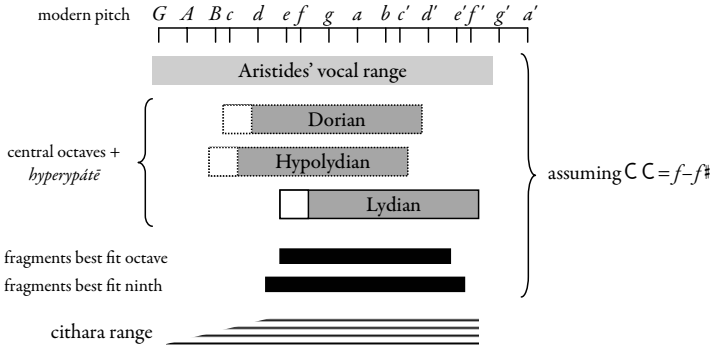

Diagram 22 Pitch ranges compared

The diagram illustrates once more the general accord between Aristides' account, Ptolemy's tunings, the iconographical evidence for the cithara, the range of the male voice, and the musical documents. It makes evident that the high region of the voice was aesthetically preferred, while the pitch of the instrument even exceeded the average vocal pitch.¹¹⁴ Consequently, the lyre accompaniment must often have used notes above the vocal line, and especially so whenever the melody dropped to its lower range. Problematic is only Ptolemy's reference to his 'Dorian', and thus to the main octave of the cithara, as a kind of central pitch. Probably he wrongly transferred a traditional attribute of the notational Dorian to his octachords, perhaps encouraged by the central position of any 'Dorian' within the system of seven *tónoi*.¹¹⁵ In any case, Ptolemy's 'Dorian' octave is only one tone above that favoured in the fragments – which in turn is situated one tone above the notational Dorian.¹¹⁶

Finally, one observes that the lyre string of highest tension was obviously regarded as close to the 'breaking pitch' of the singers' voices, as well. Only

¹¹⁴ For the difficulty involved in singing *nētē* and even higher notes, cf. ps.-Aristot. *Pr.* 19.3. — Compare the fact that Aristoxenus inserts the '*aúloi kitharistērioi*' between 'children's auloi' and 'men's auloi' in a list apparently ordered by pitch (Ath. 634ef; cf. also 176ef; Pollux 4.81), which also might indicate that the pitch of the cithara was higher than the average male voice (Bélis/Delattre 1993: 142). Auloi of this designation were in use at least from the fourth (cf. also Ath. 182c) until the first century BC (Pap. Berlin 13057; cf. Bélis/Delattre 1993).

¹¹⁵ For the traditional 'centrality' of Dorian, cf. *Frag. Cens.* 12, p.74.2–75.4, with its curious *Dorius medius* between five lower and seven higher keys.

¹¹⁶ A 'best fit double octave' is not included in the diagram because it is not well defined: all ranges from the Lydian to the Iastian Perfect System have roughly equal claims – if one discounts, as I think one should, Pap. Berlin 6870, 16–19 (*DAGM* N^o 17), with its suspicious octave stroke notes; cf. below, pp. 277f.; if these are counted, the Lydian double octave is the clear champion.

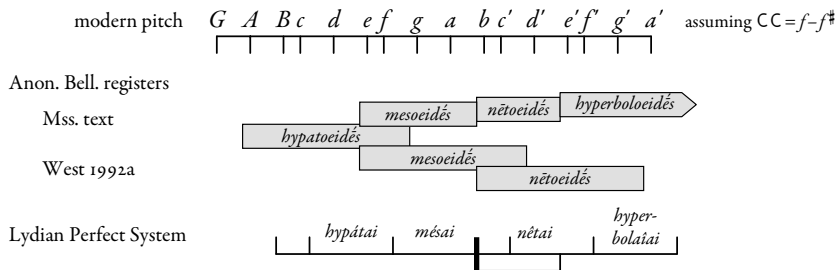

Diagram 23 Anon. Bell. § 64 as referring to the Lydian

seldom do the melodies exceed the range of the cithara. It seems likely that this relation had ultimately determined the size of the instruments.¹¹⁷

Another passage from Bellermann's *Anonymi* remains to be mentioned, which is so badly distorted that we could not take it as a starting point for any conclusions. There part of the tonal space is divided into four registers of the voice (*tópoi phōnēs*), which take their names from notes or tetrachords of the Perfect System.¹¹⁸ From low to high pitch they are called: *hypatoeidēs*, *mesoeidēs*, *nētoeidēs*, *hyperboloeidēs*. The text lists the tetrachords contained within each register, and defines their boundaries. Probably both accounts are seriously corrupted; at any rate they cannot be assembled to a coherent system. But there has been suggested an appealing restoration of the boundaries, at least, which is in best accord with the present reconstruction.¹¹⁹

It is clear that the names of the four registers demand some reference key. Within the Aristoxenian *tónoi*, there are thirteen *mésai* spread over an octave. Now *mesoeidēs*, 'resembling the *mésē/mésai*' could conceivably designate 'the range into which all *mésai* fall'; but such an interpretation can-

¹¹⁷ In this context, we must wonder how to interpret the introduction of the 'Dorian *nēē*' attributed to Terpander, one tone above the highest pitch reported for previous tunings (cf. n. 95 on p. 35 above). Given the above considerations, it is implausible that Terpander tuned his treble string one tone closer to breaking pitch than anyone before: either he would have undergone the greatest risk of breaking the string, or we would have to assume that his predecessors had not exploited the capabilities of the instrument. Was the new tuning connected with a decrease of string length by about 5cm? The general air of a musical revolution that surrounds Terpander is certainly compatible with such a design change. Yet it seems not very probable that fourth-century musical historiography had access to genuine information about music from before Terpander. More likely, a historical succession was construed out of existing alternative tunings, one of which apparently bore associations with music going under Terpander's name. — As regards Philochorus *ap. Ath.* 637–8, I do not think that *μακροῦς τοὺς τόνους ἐντέλειας* refers to an increase of tension (for which one might expect a comparative, and also *τάσεις* rather than *τόνοι*); cf. n. 39 on p. 12 above.

¹¹⁸ Anon. Bell. § 64.

¹¹⁹ West 1992a: 35.

not be reconciled with the definitions in the text. Thus we are left with the much more practical alternative of ‘the notes in the range of the *mésôn* tetrachord’.¹²⁰ A comparison between the tetrachords of the Lydian *tónos* and the Anonymus’ ranges reveals a close coincidence, which holds for the manuscripts’ text as well as for the restored version: see Diagram 23. Of the three keys in question, only the Lydian can explain the designation of the Anonymus’ registers. These, however, will have originated not from the abstract *tónos* but from musical practice. It also becomes obvious why the designation of the two lower tetrachords reflects that of their upper note. Within the most convenient singing octave the ‘lowest notes’ (*hypátai*) thus correspond to the lower range from about *c–e*, the ‘middle notes’ (*mésai*) to about *f–b*, the ‘highest’ (*nétai*) to about *c’–f’*. Even higher notes were associated with the notion of ‘excess’ (*hyperbolaíai*).

NOTATING THE CITHARA TUNINGS

Now that we have sufficiently established the relationship between Ptolemy’s and the traditional *tónoi*, we are in the position to assign the correct notational sign to each note of his eight-string cithara tunings. These range from $\Theta\aleph$ down to CC , or, with *hyperypátē* included, to ΦF . The complete system is presented in Diagram 24 (which disregards the microtonal variations in interval size, in order to align notes of similar function vertically).

At this point we ought to address a curiosity inherent in Ptolemy’s account. Despite the fact that modulation into the *synēmménōn* tetrachord was always described as the most common type at all, this tetrachord is absent from the ‘basic’ Lydian (or, in Ptolemy’s diction, ‘Dorian’) key of the tunings. In the predominantly diatonic music of the Roman era, Lydian *synēmménōn* modulation would require merely one additional note, *trítē synēmménōn* ΘV , since *paranētē* and *nētē synēmménōn* can be regarded as identical with ‘ordinary’ Lydian $\text{E}\sqcup$ and UL . But Ptolemy does not provide for the *synēmménōn* tetrachord at all.

¹²⁰ For the designation of the notes of the *diezeugménōn* and the *synēmménōn* tetrachord as ‘*nétai*’ in Aristoxenian terminology, cf. Cleonid. 10, p. 200–201; Theon, *Util. math.* 48.15 (92.23 also for the *hyperbolaíon*, cf. Porph., *in Harm.* 166.3; 167.21). Alternatively – though less likely – the terms might refer directly to the notes, not the tetrachords. In this case, ‘*hyperbolaioeidés*’ would refer to ‘*hyperbolatá*’, which is found for *nētē hyperbolaíōn* (Aristox., *Harm.* 2.40, p. 50.6–7; Philo, *Leg. alleg.* 3.121; Theon, *Util. math.* 89.16–23). The difference is however more of a theoretical nature, because the eponymous notes were obviously felt to rule the tonal space below, not around them (cf. the rather archaic terminology in Aristox., *loc. cit.*).

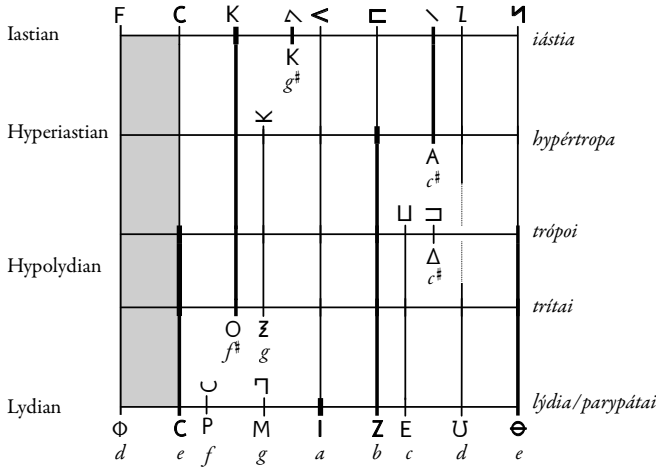

Diagram 24 Ptolemy's cithara tunings notated

Surprisingly, this absence, which seems so odd in the light of the treatises, is in best accord with musical practice. Although the bulk of the extant fragments stems from the time in question and contains much music in the Lydian key, there are virtually no instances of Lydian *synēmménon* modulation. Only in one piece, the Michigan Papyrus 1205,¹²¹ do we encounter an (instrumental) V. But these lines of music are remarkable in another respect, too, because they modulate into the Hypophrygian also. According to Bellermann's Anonymus,¹²² the fragment must therefore be ascribed to auletic, orchestric or hydraulic music, and certainly does not testify to cithara tunings. Has Lydian *synēmménon* modulation become largely obsolete,¹²³ lyre music, at least, being now oriented towards the new Iastian keys? The late treatises, which regularly include the *synēmménon* tetrachord, cannot be taken as evidence of the musical practice of their times, of course. For the most part they write out theory that was based on classical and Hellenistic music. On the other hand, the evidence from the fragments might be biased if citharistic music produced more written documents. Below we shall argue that Lydian *synēmménon* modulation, in spite of its neglect in Ptolemy and the documents, might still have played a certain, if minor, role even in the art of the cithara.¹²⁴

¹²¹ *DAGM* № 61, where a date of "first to third century AD" is given. Cf. below, pp. 319 ff.

¹²² Cf. Diagram 14 on p. 54 above.

¹²³ For its presence in Hellenistic music, cf. Limenios' Delphic Paean (*DAGM* № 21).

¹²⁴ Below, pp. 198 ff.

CHAPTER 3

Notation in the handbooks

GAUDENTIUS, ALYPIUS, BACCHIUS,
BELLERMANN'S ANONYMI

Once the historical and structural primacy of the Lydian key is established, the usage of notation as found in most of the later treatises fits into the picture quite readily: here, too, the Lydian regularly maintains its primary status.¹

Firstly, we encounter a sort of fixed order in which the *tónoi* of the notation were presented. Since this approach is based on the triads, it cannot be older than the latest version of the notation with its fifteen keys. It comprises three complete series of *tónoi*, one for each genus: first the diatonic, then the chromatic, and finally the enharmonic. The triads are enumerated in descending pitch, and within each triad, the basic scale is followed by its 'Hypo-' and 'Hyper-' variants. As a result, the Lydian triad comes first, the Dorian last, and the tables start from the plain Lydian *tónos*. These lists constitute the body of Alypius' book (or what we have of it). They were apparently appended to Gaudentius' treatise as well, although only the part from diatonic Hypolydian to Hypoaeolian survives in the manuscript tradition.² The lists were truncated quite early, and on top of this the Lydian key has been lost, together with part of the preceding chapter(s). Still the arrangement is the same as in Alypius, and the sequence of Hypolydian – Hyperlydian – Aeolian – Hypoaeolian... makes sense only if the preceding lacuna is supposed to have contained the Lydian key.³

¹ Cf. Bellermann 1847: 48 (clearly phrasing the 'Dorian' properties of the Lydian *tónos*, but proposing a wrong historical model, which makes the scales of Aristoxenus the oldest); Sachs 1925: 3 (adopting the absurd notion of an "inversion" of scales between classical Greece and late antiquity); Bower 1978: 17.

² Gaud. 22–3, p. 352–5.

³ Cf. Jan 1895 ad loc.; Mathiesen 1999: 508.

Bellermann's Anonymi are content to reproduce the notation of the Unmodulating System in merely one key, which is the Lydian. Similarly Lydian are all illustrations of intervals, ranges and instrumental notation in this collection, and so are the short instrumental exercises which are found towards its end. Interestingly, the examples given by the First Anonymus start from *hyperpátē* F as their lowest note, which accords with our hypothesis about the range of the cithara.

Bacchius uses notational signs to exemplify notes and ranges within the Perfect System as well as certain intervals.⁴ Once more, all examples are taken from plain Lydian (in two cases, where a modulation is implied, the Lydian *synēmménon* tetrachord comes into view⁵).⁶

BOETHIUS

Boethius introduces the note signs in the fourth book of his *De institutione musica*. In the first place, he intends to use them merely as abbreviations for the note names, as a quick and economical way of labelling his diagrams. For this purpose, he needed only the signs for one Unmodulating System. Once more it is the Lydian key that he chooses, just as the Greek writers considered above. Unlike these, however, he explicitly acknowledges its priority.⁷ What makes the respective chapters especially interesting is the fact that Boethius employs the musical signs in diagrams that belong to a division of the canon: no extant Greek source accomplishes such an intimate connection between Pythagorean argument and notation.⁸

⁴ Bacchius 11–18, p. 293–7; 29–42, p. 299–302.

⁵ Cf. Hagel 2000: 67.

⁶ Cf. also the table that the manuscripts append after the second book of Aristid. Quint. One might object, as a Hypolydian example, the 'Hypolydian canon' found in the Codex Palatinus 281, fol. 173 v. But there this curious table is obviously intended as additional information to the Hypolydian scale of the *koiné hormasta*, which is derived from Lydian as the basic scale (see below, pp. 117 ff.). Moreover, the notes which are inserted in the 'Hypolydian canon' in order to supply the missing semitones are misplaced (Ruelle 1875: 534–5; Reinach 1896: 212–13) – but they would fit into a Lydian diagram of similar structure (accordingly they are accompanied by the siglum Φ as stemming from the Phrygian key). The usual Lydian notation is assigned to the Unmodulating System in Cod. Vat. 192, fol. 225 (Reinach 1897: 325–6).

⁷ Boeth., *Inst. mus.* 4.3, p. 308–14: *Sed ex his omnibus modis unum interim Lydium eiusque notulas per tria genera disponamus, in reliquis modis idem facere in tempus aliud differentes*; 4.6, p. 318.4–6: *in eo scilicet modo qui est simplicior ac princeps, quem lydium nuncupamus*.

⁸ Remotely comparable are tables contained in Bellermann's Anonymi, where the notes of the Unmodulating System are provided with numeric values establishing the intervals (Anon. Bell. 3, §77+79; §96).

Even more fascinating is Boethius' discussion of *tónoi*, which seems to preserve a Greek system otherwise not directly attested. In several respects, it is related to Ptolemy's approach: the arrangement of the keys is derived from the species of the octave,⁹ and consequently a rather limited set is envisaged instead of the seemingly abundant Aristoxenian *tónoi*. But at this point Boethius' presentation becomes confused. First he seems to follow Ptolemy in the rejection of even an eighth *modus*, which merely duplicates the first one at the octave, since he specifies the same seven keys as Ptolemy, although without indicating his source.¹⁰ But Boethius does not reproduce Ptolemy's argument, he merely derives the number of 'modes' from the number of octave species. Shortly afterwards, however, Boethius introduces the eighth, 'Hypermixolydian', key, but defers the explanation of his reasons to a later point. The wording reveals that Boethius does not consider the decision in favour of or against an eighth *modus* a matter of importance; he seems hardly aware that there is a decision at all:

septem quidem esse praediximus modos, sed nihil videatur incongruum, quod octavus super adnexus est.
(Boeth., *Inst. mus.* 4.17, p. 343.17–19)

It is true, we have said above that there are seven keys; nevertheless it shall not be considered a lack of consistency if an eighth is adjoined at the top.

The eighth *tónos* is simply there: for the reader, in the diagrams preceding the passage, and for Boethius, in the source from which he took the diagrams. Thus, its presence has to be reconciled with the number seven implied by the line of reasoning that derives the keys from the octave species, for better or worse. In what follows Boethius expounds on the intervallic distances that separate the keys from each other. But he does not base his argument on musical facts: neither on the circle of fifths – which gives the adequate explanation, as found in Ptolemy,¹¹ nor even on the design of the diatonic scale. Boethius is content to explain how the respective intervals are read from the diagrams. Finally, he fulfils his promise to explain the rationale behind the eighth key: the heptatonic double octave contains eight octave relations – whence the eighth *modus*. No attempt is however made to justify why the double octave is invoked at all.

⁹ Boeth., *Inst. mus.* 4.15, p. 341.19–21: *Ex diapason igitur consonantiae speciebus existunt qui appellantur modi, quos eisdem tropos vel tonos nominant.*

¹⁰ Boeth., *Inst. mus.* 4.15, p. 342.12–14.

¹¹ Ptol., *Harm.* 2.10, p. 63.14–64.15.

Surprisingly, in the end Boethius attributes the duplicating key to none other than Ptolemy.¹² It is true that the eight-*tónoi* system is described by Ptolemy, but only after (and immediately after) he has put forward his own arguments for rejecting the eighth key, and in a chapter where almost every sentence breathes Ptolemy's contempt for the lack of analytic method exhibited by those who embraced it.¹³ Only here in the *Harmonics* is the term 'Hypermixolydian' mentioned, but with explicit attribution to others.¹⁴ The seven keys, on the other hand, are not only exhaustively argued for in Ptolemy's work, but also displayed graphically, and they form the basis for the tuning tables and part of the astrological applications.¹⁵ It is therefore hardly possible that Boethius derived his erroneous attribution from a reading of Ptolemy's work, however cursory it might have been.¹⁶ Presumably he had not yet studied the *Harmonics* closely when working on the fourth book of his *De institutione musica*. At any rate, the present chapters are certainly not based directly on Ptolemy. Both the seven-key and the eight-key systems were older than Ptolemy,¹⁷ and the association of *tónoi* and octave species might date back even to pre-Aristoxenian theory. Apparently, therefore, Boethius' source for his tables of *modi* adheres to the tradition Ptolemy criticises.¹⁸ Nicomachus, whose work stands behind the initial books of *De institutione musica*, is a likely candidate.¹⁹ On the other hand, there are good arguments that Nicomachus is probably dependent on Ptolemy.²⁰ In this case, Boethius' attribution of the eighth key to Ptolemy might have been induced by some ambiguous phrasing in Nicomachus' text.

What then was the general character of the eight-mode source (or sources – Ptolemy uses the plural, as usual in anonymous diatribe)? Did it represent the Pythagorean mainstream?²¹ This seems rather unlikely, considering a detail of Ptolemy's criticism: instead of insisting on the 'Pythagorean' *leímma*, the unnamed authority divided the tone into two equal 'semi-

¹² Boeth., *Inst. mus.* 4.18, p. 348.2–3: *Atque hic est octavus modus, quem Ptolomaeus superadnexuit.*

¹³ Ptol., *Harm.* 2.10, p. 62.16–63.14: τὸν ἕνα τὸν περισσῶς τοῖς ἑπτὰ ... ταῖς οἰκείαις αὐτῶν ὑπεροχαῖς ἐπιπτεῖν, οὐ μέντοι κατὰ τὴν δέουσαν ἐπιβουλὴν. ... καταχρησάμενοι ... ὁ θέλουσι ποιεῖν ... οὐ δεῖ δέ ... The context is misrepresented by Bower (1978: 34–5), who negates the problem ("Boethius does not attribute to Ptolemy the addition of an eighth mode"); but cf. Bower 1984: 262–3, with reference to Bryenn., *Harm.* 1.8; also, Bower 1989: 160 n. 91.

¹⁴ Ptol., *Harm.* 2.10, p. 63.6: προσηγόρευσαν ὑπερμιξολύδιον.

¹⁵ Ptol., *Harm.* 3.12, p. 106–7.

¹⁶ So Pizzani 1965: 134–7.

¹⁷ Cf. above, p. 5 with n. 17.

¹⁸ Cf. Kunz 1936: 17 ("eine uns unbekante, aber nicht ptolemäische Quelle").

¹⁹ Bower 1978: 36–41.

²⁰ Bower 1978: 41–3.

²¹ So Bower 1978: 39 n. 98.

tones', just as the Aristoxenians did.²² On the other hand, it was also no 'Aristoxenian' treatise, which would have featured at least thirteen *tónoi*. Doubtless it was written by a more individual thinker, perhaps one who tried to establish musical theory as a balance between the two traditional viewpoints, possibly with a new evaluation of contemporary music, as well.²³ It may be dated, with considerable caution, to the Hellenistic period.²⁴

Boethius supplies diagrams of the keys with note signs, thus providing a minor version of the 'wing-shaped' diagram whose complete Aristoxenian version was given by Aristides Quintilianus, but is missing from the manuscripts.²⁵ It is important that the note signs are an integral part of these diagrams, which Boethius must consequently have taken over from his source in more or less unchanged form. This implies that, if the chapters in question are really based on Nicomachus' *Introduction*, this work made use of notation, too, and would thus be the earliest known treatise to do so.

Boethius' diagram as such holds no surprises. It represents the notation in the seven-scale stage which we have supposed to date from some time around Aristoxenus. Its designation as *ab antiquis tradita musicis* may therefore contain more truth than one might expect from such a remark. This part of the notation is clearly the ancient one, the 'enharmonic' half, the greater part of which practically vanishes from the evidence of the scores before the Roman Imperial era. Similarly, there is no trace of the connection with contemporary practice, which Ptolemy so ingeniously re-established by his idiosyncratic treatment of keys. Nor could there be any, since Ptolemy's system, based on ancient associations of lyre tunings, is entirely incompatible with the *tónoi* of notational practice, which presumably gained their shape under the auspices of auletes and composers of choral music.

Ultimately it is Boethius' treatment of keys that enables us to fully appreciate the lines along which Ptolemy proceeded. As far as the establishment of the seven *tónoi* and their (alleged) connection to the species of the octave were concerned, Ptolemy could, by and large, follow his precedes-

²² Ptol., *Harm.* 2.10, p. 63.11: τοῦ λείμματος ὃ θέλουσι ποιεῖν ἡμιτόνιον, "the *lémma*, which they want to make a semitone", indicates that the text in question did not merely use the 'wrong' term, but asserted or presupposed that the tone could be divided in halves. Nicomachus, on the other hand, uses 'Aristoxenian' diction quite freely, but in the end points out the mathematical facts (cf. *Ench.* 12, p. 262–4).

²³ A relatively close association of the eight-scale system with musical practice might be indicated by their presence in Cod. Vat. 192, fol. 222r (Reinach 1897: 315).

²⁴ Cf. the criticism apparently also directed against this system in the mysterious source quoted in Ath. 625d; cf. n. 122 on p. 49 above and n. 10 on p. 106 below.

²⁵ Aristid. *Quint.* 1.11, p. 23.25–24.6; cf. Mathiesen 1999: 634.

sors, amending their methodology where necessary, and developing precise arguments to settle disputed questions, such as whether an eighth scale should be adopted or not. Still, it seems that his application of keys to lyre tunings was exceptional. It is based on the fact that the 'Dorian' octave species is identical with the central octave of the Greater Perfect System,²⁶ which comes to play such an important role in Ptolemy's diagrams, and that the same octave species forms the basis of certain cithara tunings. Ptolemy draws the consequences and assigns these cithara tunings to the 'Dorian' key, in perfect accordance with their pre-history, and the others to the appropriate neighbouring keys. In doing so, he exceeds the scope of the other musical treatises, but he does not contradict them, as far as we know: presumably no theorist had described the tunings in terms of modern notational *tónoi* such as Hyperastian. What Ptolemy contradicted was merely notational practice – and, if we like to put it thus, recent professional terminology that paid tribute to the victory of aulos-based notation, calling a tuning that realised the Dorian octave by the name of '*lydia*'. In this way Ptolemy established a framework in which lyre music was reconciled with, and could resume its place within, music theory, probably for the first time for centuries. Nevertheless, the price he paid was considerable. The divergence from the notation as the universally accepted paradigm for the definition of *tónoi* inevitably led to confusion. Since Ptolemy did not profane his work by mentioning notational practice and explicating the problems involved, his system could be misunderstood only a few generations later.

²⁶ Ptol., *Harm.* 2.11, p. 65.10–12.

CHAPTER 4

Strings and notes

NOTE NAMES BY 'THESIS' AND 'DYNAMIS'

When I read my first book on Greek music, I found the chapter about the keys quite hard going, but by far not so impenetrable as the account of 'thetic' and 'dynamic' note names, which seemed created out of the merest joy of as abstract thinking as possible, while contributing nothing at all to the understanding of musical structures. Not the smallest part of my confusion was due to the convention of taking over the Greek untranslated: while 'thetic' is merely arcane, in the case of 'dynamic' one has to suppress all modern associations of the word entirely. Meanwhile most writers render the Greek terms by comprehensible modern equivalents such as 'by position' and 'by function', and one can even access the topic as a question of practical lyre playing.¹ Placed in this original context, it becomes clear that 'thetic' notes ultimately translate to strings. Still, much of a puzzle remains.

The distinction is, as far as we know, drawn only by Ptolemy.² All other harmonic treatises use the 'functional' note names exclusively – of course without calling them by such a designation. Only Ptolemy introduces names 'by position' in addition. Still, this 'thetic' conception seems so much more natural for instrumentalists that one could not but assume a long history behind it, although, for some curious reasons, a history completely hidden from our eyes.³

¹ *AGM*: 221 with n.10; Winnington-Ingram 1936: 62–5, already gives a perfectly clear account of Ptolemy's system.

² Gaudentius, 6, p. 332.5–11, employs a contrast of φύσει and θέσει, 'by nature' and 'by definition', in which *thésis* assumes the opposite meaning as in Ptolemy, referring to the function of the note in the Perfect System. This suggests that Ptolemy's distinction does not rest on tradition.

³ Cf. however Aristot., *Pol.* 1276b, which becomes understandable only if τῶν αὐτῶν φθόγγων refers to string names, not to pitches (Mountford 1920: 21; 33).

Strings and notes

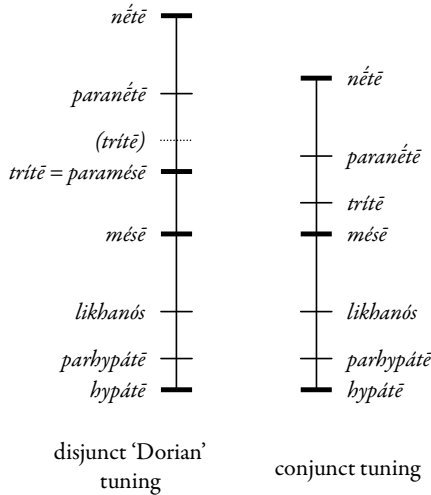

Diagram 25 Purported ancient lyre tunings behind the note names

In this book, we have so far used 'functional' note names. These are canonised within the Perfect System and gain their meaning from their intervallic relations, which defined their melodic function: *hypátē* is the note a fourth below *mésē*, which in turn is the note below the disjunctive tone, *parhypátē* lies one step above *hypátē* (although its pitch is determined by the genus of the scale), and so on. The names as such are clearly derived from string names, in accordance with their placement on the instrument. In their 'functional' interpretation, however, they make sense only in two specific tunings, namely those in which *hypátē* and *nētē*, 'topmost' and 'bottommost', do in fact refer to the outermost strings, *trītē* to the third, and *mésē* lies in the centre. One of these 'compliant' tunings realises the 'Dorian octave', the central octave of the Greater Perfect System, the other the respective range in the conjunct Lesser Perfect System (cf. Diagram 25).⁴ Consequently, these have been assumed to correspond to the most important lyre tunings of an early period – as far back, in fact, as the Greeks themselves would remember.⁵

⁴ Cf. *AGM*: 219–22.

⁵ Cf. ps.-Aristot. *Pr.* 19.3–4 (the semitone is the typical interval between *parhypátē* and *hypátē*, while *nētē* is a high note: as far as I see, this is the only passage in the *Problems* presupposing a 'standard tetrachord'; cf. also n. 32 on p. 114 below); 19.7; 19.32 (cf. ps.-Plut., *Mus.* 1140–1); 19.47; Nicom., *Ench.* 3, p. 242.4–7; 5, p. 245.14–18 (describing the evolution of the disjunct octave from the conjunct tuning); 7, p. 249.15–19; 9, p. 252.16–254.2 (bringing himself into trouble by presupposing, this time, the defective disjunct tuning, in accordance with unnamed authorities); Varro, *Ling. lat.* 10.46; Boeth.,

But there were doubtless more possibilities of tuning a lyre.⁶ In all of these the 'dynamic' note names lose their immediate sense: in a 'Hypodorian' octave, for instance, the functional *mésē* becomes the lowest string. It appears that the note names, which are so commonly used in the handbooks, were purely theoretical abstractions, whereas lyre players must have referred to their highest string, for instance, as '*nētē*' regardless of the instrument's current tuning. Just as we have inferred it for the development of the *tónoi*, such a bifurcation of the tradition can be explained best by the assumption that the functional nomenclature evolved under circumstances in which the aulos had replaced the lyre as the model instrument. Indeed, as soon as the design of the wind instrument was based on conscious reflection, structural features such as the disjunctive tone became of primary importance, regardless of their position within the actual scale. After all, there is also independent evidence that the conception of the Perfect System took place in an aulos-centred environment.⁷ The lack of references to the divergent nomenclatures is then parallel to the disappearance of the lyre approach to keys in favour of the auletic *tónoi*. By the times of Aristoxenus musical theory became detached from instrumental practice to such an extent that the professional terminology of instrumentalists no longer entered the discourse. As we will shortly see, this was another point Ptolemy was going to reverse.

All this does not explain sufficiently how the functional note names were conceived for the first time. Although the two mentioned tunings might

Inst. mus. 1.20, p. 206.10–207.7; 27, p. 219.4–25; Mart. Cap. 2.187. Note, however, that whereas the disjunct tuning doubtless corresponds to early musical reality, the conjunct might be argued to constitute a later attempt to reconstruct the scale of the old seven-stringed lyre (cf. the lack of genuine information expressed in ps.-Aristot. *Pr.* 19.7); it is however backed by the relatively old designation of the fourth as *diá tessárōn*, 'through four [strings]' (alluded to by Ion of Chios, cf. n. 96 on p. 87 above), which applies to the 'conjunct' lyre throughout, but makes hardly any sense with a gapped tuning.

For the conventional interpretation, cf. Burkert 1972: 391–4; *GMW* II: 37–8 n. 34; 97 nn. 76–7; 261–2 nn. 70–3; *AGM*: 176–7. For divergent views, Chailley 1968 (going to some lengths to exclude the defective octave from the *Problems* and from Nicomachus' mind, but overlooking the evidence from Philolaus); Franklin 2001: 197–212. The association of Terperand with 'trichordal' compositions in ps.-Plut., *Mus.* 1137b, a section based on Aristoxenus (see below, p. 436), in combination with the mention of an 'incomposite trihemitone' ((τρι)ημιτόνιον ἄσυνθετον) by Nicomachus, in typically Aristoxenian terminology, suggests that the tradition of the defective octave goes back at least to Aristoxenus himself. Of the two possible interpretations of ps.-Aristot. *Pr.* 19.32, relating to either the conjunct or the disjunct *tritē* (cf. *GMW* I: 198–9 n. 62 with *AGM*: 177), only the latter is compatible with 19.7; since this accords also with Philolaus, it is certainly preferable.

⁶ Cf. e.g. Aristoph., *Equ.* 984–96; Plato, *Lach.* 188d; see Winnington-Ingram 1956: 172–3. In ps.-Aristot. *Pr.* 19.7 and 19.47, the wording implies several seven-stringed *harmoniai* all ranging from *hypátē* to *nētē* or a tone below *nētē* (διὰ τί οἱ ἄρχαιοι ἑπταχόρδους ποιοῦντες [τῶς 47] ἁρμονίας τὴν ὑπάτην ἀλλ' οὐ τὴν νήτην κατέλιπον:). For the various 'modes', see *AGM*: 180–4.

⁷ Cf. Hagel 2005a; the present study will disclose further evidence for this claim.

have enjoyed some superior state in an early period, it would be naïve to assume that they were used to the exclusion of other possibilities. Near-Eastern music theory had codified the complete cyclic system of seven diatonic tunings in the second millennium BC, and probably even earlier,⁸ and most or all of them were actually employed in musical practice.⁹ Similarly, we should presuppose a variety of tonal structures in those periods of Greek history of which we know little or nothing.

PTOLEMY

When Ptolemy calls the ‘thetic’ system to the stage again (and invents a name for it), he does so for a specific reason: he needs the double nomenclature as a means of referring to the relative positions of functionally identical notes in different genera. An alternative would have been to count note positions in the double octave. But Ptolemy’s argument that there can be but seven *tónoi* is based on the possible number of positions of functional notes. The argument in itself is rather weak, but it gains credibility by referring to the ‘thetic’ and the ‘dynamic’ conception by identical sets of names.¹⁰

⁸ For an introduction to the sources of our knowledge of the ancient Near-Eastern tonal system see, e.g., West 1994; Kilmer 1997; 2001; Krispijn 2002; Shehata 2002; Hagel 2005b.

⁹ This is known from a cuneiform list of songs together with their tunings: *KAR* 158, col. 8.45–52; cf. *Nabnitu* 32.1 (*MSL* 16, 251). Cf. Kilmer 1965: 267, 138; Wulstan 1968: 223; Kilmer 1971; Wulstan 1971: 370; Duchesne-Guillemin 1984: 423; Lasserre 1988: 87–8; Krispijn 2002: 472.

¹⁰ Ptolemy, *Harm.* 2.9, p. 60–2, argues from the view of non-modulating tunings of a stringed instrument, in accordance with the old Near-Eastern conception of scales. Is it by chance that the single clear statement of such a viewpoint in Greek music theory is made by an astronomer, whose science is also deeply rooted in the Near East? On the other hand, the same point made in Ath. 625d: καταφρονητέον οὖν τῶν τὰς μὲν κατ’ εἶδος διαφορὰς οὐ δυναμένων θεωρεῖν, ἐπακολουθούτων δὲ τῆ τῶν φθόγγων ὀξύτητι καὶ βαρύτητι καὶ τιθεμένων ὑπερμιξολύδιον ἁρμονίαν καὶ πάλιν ὑπὲρ ταύτης ἄλλην “now one must reject those who are unable to investigate the differences in form [i.e., the arrangement of intervals; almost certainly the octave species are meant], but cling to the pitch of the notes and posit a Hypermixolydian *harmonia* and again another one beyond that” (for the argument that follows, cf. n. 122 on p. 49 above). Does Ptolemy rely on the source here quoted? — The acceptance of Ptolemy’s argument in Barker 2000: 186–7, is based on the misunderstanding that the circle of fifths would also reiterate after seven steps. This is not the case, of course: after completing first the anhemitonic pentatonic scale ($b-e-a-d-g$), then the diatonic ($+c-f$), the circle of fifths produces intermediate semitones ($+b^b-e^b-a^b-d^b-g^b$), and can be made to reiterate only after the twelfth step ($e^b \sim b$) – if one assumes equally tempered intervals, as does Aristoxenus (in Barker’s fig. 9.08, an erroneous ‘fifth’ of three tones and two *leimmata* appears, namely between b and g^b , or between a and f^b , depending on the order of pitch assumed).

In accordance with his systematic task, Ptolemy assumes a complete system of fifteen note names ‘by position’, parallel to the traditional ‘dynamic’ Greater Perfect System. Such a complete account clearly goes beyond traditional citharodic terminology: the note names associated with the outermost tetrachords *hýpaton* and *hyperbolaion* are abstractions which no longer refer to the arrangement of physical strings.¹¹ How Ptolemy starts from a traditional set of string names, from which he develops the comprehensive account, becomes clear from an analysis of his text.

Ptolemy is a very careful author, concerned about convincing his readers by a consistent line of argument. Consequently, he is well aware of what general knowledge he can expect from his public, and never makes use of less-familiar conceptions, let alone ideas of his own, before introducing them thoroughly. Thus the double octave ‘by position’ is explained in detail before further argument is based upon it.¹²

Nevertheless, a number of references to ‘thetic’ note, i.e. string, names already appear in an earlier section, notably in the chapter that draws most extensively on citharodic practice. At the end of the first book, Ptolemy has completed his purely rational deduction of tetrachord divisions, and proposed to construct these on the experimental instrument, the canon, so that it becomes clear that they concord with the demands of musical perception as well. The second book starts with an even more ambitious programme: on the basis of logical deduction, based merely on the musical expertise of cithara tuning, it shall be shown that the tunings of musical practice conform exactly to a subset of the previously derived possible tetrachord divisions.¹³ Ptolemy describes the necessary procedures in full detail and even provides instructions on how to construct the canon in order to make it as reliable an instrument of interval measurement as possible. For the proposed tests, a canon of eight strings is used, so that two tetrachords can be set up simultaneously. The specification of these tetrachords is done by reference to the cithara,¹⁴ so that Ptolemy’s target audience –

¹¹ The double-octave *lyra* of Ptolemy’s time (cf. above, pp. 77ff.) can hardly stem from the fourth century BC, when the Perfect System was developed. In any case, the subsequent addition of individual strings would not have led to a tetrachord-oriented nomenclature; the last real string name is ‘*hyperypátē*’.

¹² Ptol., *Harm.* 2.5, p. 51–3.

¹³ Apart from the common basic assumptions which Ptolemy lists, namely that the fourth embodies the numeric ratio 4:3 and the tone 9:8, his deductions also rely on the principle that all melodic intervals must be superparticular – which he fails to mention; cf. Barker 2000: 246–9.

¹⁴ Ptol., *Harm.* 2.1, p. 42.10–11: τῶν παρὰ τοῖς κιθαρῳδοῖς μελωδοιμένων τετραχόρων, “of the tetrachords that are played/sung by the citharodes”.

people with sufficient musical training to judge whether an instrument is tuned accordingly – could easily follow the instructions.

Unfortunately, however, most modern readers were hopelessly confused by the unfamiliar terminology Ptolemy employs in this chapter. It is therefore necessary to give a brief reference to the tetrachords in question, or rather of their boundary notes, by which Ptolemy defines them.¹⁵ The following table lists them in the order of their appearance in the text, together with the respective tunings; the rightmost two columns indicate whether a ‘thetic’ or/and a ‘dynamic’ interpretation yields the required notes (✓) or not (✗). Diagram 26 provides a visual representation (for easier orientation, the disjunctive tone in each tuning is marked).

	tuning	note	<i>Harm.</i> 2.1,	thetic	dynamic
1	<i>trópoi</i>	<i>nḗtē</i>	p. 42.10–12	✓	✓
		<i>paramésē</i>		✓	✓
2	<i>stereá</i>	<i>paramésē</i>	p. 43.10–11	✓	✗
		<i>khrōmatikḗ</i>		✓	✗
3	<i>iastiaiōlia</i>	<i>tritē</i>	p. 43.19–20	✓	✗
		<i>diátonos</i>		(✓)	✗
4	<i>parypátai</i>	<i>mésē</i>	p. 44.15–16	✓	✓
		<i>hypátē</i>		✓	✓

It almost goes without saying that all the employed tetrachords are of the standard form of theory, that is, they have their smallest interval at the bottom, and Ptolemy always cites and labels them in descending pitch.

In the examples taken from *parypátai* and *trópoi*, which belong to Ptolemy’s ‘Dorian’, the note names ‘by position’ and ‘by function’ coincide, so that they contribute little to our investigation. The tetrachord from ‘*stereá*’, on the other hand, is of special interest, because it characterises Ptolemy’s highly precise method especially well. The term ‘*stereá*’ denotes not a specific tuning but rather a class of tunings which are realised on the lyra as well as on the cithara. According to Ptolemy, it is distinguished by implementing ‘tonic diatonic’ tetrachords throughout, regardless of the relevant *tónos*.¹⁶ On the cithara it appears only in the tunings known as

¹⁵ The identification of the tetrachords is ensured by the numbers given for their intervals, which can be compared with the tables associated with each of the tunings (Ptol., *Harm.* 2.15–16, p. 76–80.18).

¹⁶ Ptol., *Harm.* 1.16, p. 39.7–10: τὸ μὲν... τονιαῖον τῶν διατονικῶν, ὅταν καθ’ αὐτὸ καὶ ἄκρατον ἐξετάζηται, τοῖς τε ἐν τῇ λύρᾳ στερεοῖς ἐφαρμόσει καὶ τοῖς ἐν κιθάρᾳ κατὰ τὰς τρίτων καὶ ὑπερτρόπων ἁρμογῶς, “the tonic one of the diatonics, when tested by itself and unmixed, will fit the *stereá* both on the lyra and on the cithara as realised in the *tritai* and *hypértropa* tunings” (the

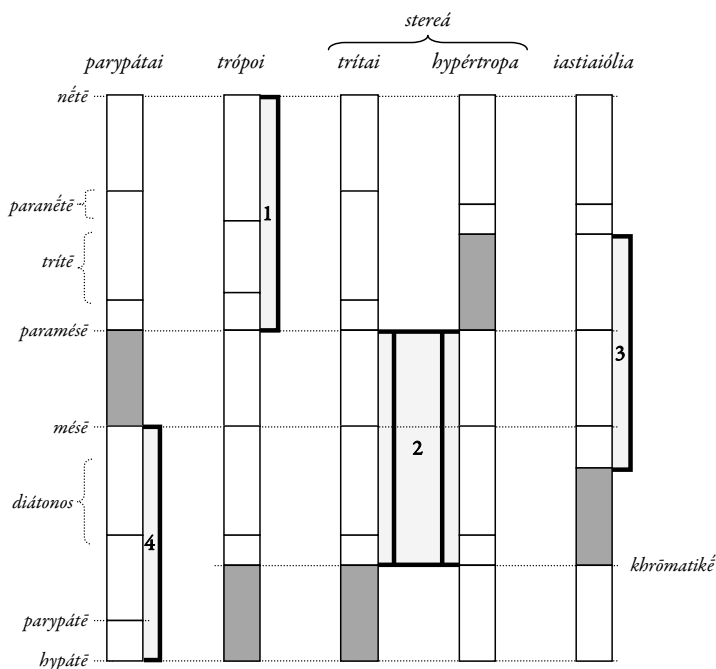

Diagram 26 Addressing notes by cithara string (Ptol., *Harm.* 2.1)

trítai and *hypértropa*. By choosing the tetrachord that is common to these two, Ptolemy is able to subsume two tunings under one name, and at the same time he establishes the connection to the lyra, as well. Ptolemy's target audience was certainly familiar with the correspondences between the two types of *stereá* on the cithara, and with the lyra tunings of the same name – correspondences which we must extract from his scattered remarks.

The boundary notes are cited in 'thetic' nomenclature, by the names used by the citharodes for their strings. Obviously this was the natural thing to do, because Ptolemy does not mention the fact at all. Here functional note names are impossible anyway, because they would diverge between the two tunings in question, which implement different *tónoi*. Here

passage was often mistranslated: the second τοῖς refers back to τοῖς στερεοῖς!); 2.16, p. 80.8–10: τὰ ἐν τῇ λύρᾳ κολούμενα στερεὰ τόνου τινός, "the so-called *stereá* of a given *tónos* on the lyra". Apparently the term refers to the fact that all the higher movable notes of the respective tunings occupy the highest possible position (cf. Aristid. Quint. 2.12, p. 77.19–20). This would be true also of *lydia* and *iástia* – but these share the more specific designation as *metaboliká*; cf. the discussion below, pp. 194ff.

the inadequacy of the functional conception for cithara players becomes especially prominent. The arrangement of the lower part of the tessitura is identical in *trítai* and *hypértropa*; in practical music-making and teaching it would be ridiculous to call, for instance, the lowest string *mésē* in one case and *likhanós hypatôn* in the other – and even more so if both tunings were present at the same time on a modulating instrument.¹⁷

That concert instruments could embrace the pitches of Ptolemy's eight-note tables as subsets of modulating tunings is conveyed by the name he uses for the lower boundary note of the *stereá* tetrachord: *khrōmatiké*, "chromatic note". In the Perfect System, *khrōmatiké* is an abbreviation for the chromatic variant of the higher movable note within the tetrachord – *likhanós* or, in the higher region, also *paranētē*. It establishes the distinction from the diatonic and enharmonic manifestations of these degrees, which are known as *diátonos* and *enarmónios* respectively.¹⁸ We shall see that, just as the other note names, *khrōmatiké* and *diátonos* were derived from lyre practice at quite an early date. The note which Ptolemy designates as *khrōmatiké* is situated exactly one whole tone above his lowest note, *hypátē*.¹⁹ In spite of its name, its position is not subjected to the procedure of fine tunings, but defined by the scheme of alternating fifths and fourths which establish the relationships between the keys. In particular, the *khrōmatiké* lies a perfect fourth below the *paramésē* (cf. Diagram 26 above).

Even so, its chromatic character is perfectly clear, but only from a basic 'Dorian' tuning. Together with the *hypátē* and the *parypátē*, this modulating note forms a chromatic *pyknón*. Thus the player is able to modulate not only between two keys, but also between diatonic and chromatic in the basic key (cf. Diagram 27).²⁰ Consequently, the two strings that were distinctive in the latter type of modulation came to be called 'the chromatic' and 'the diatonic'.

The addition of the 'chromatic string' was no novelty by Ptolemy's time. Chromaticism and modulation are two keywords we associate with the

¹⁷ It might be tempting to compare the changing between hexachords on modulation in the sol-fa system. Yet the purpose is completely different: in the sol-fa system the syllables serve to get the vocal melody right, in the absence of a physical orientation, while the cithara provides the fixed pitches of its strings, which call for a fixed nomenclature.

¹⁸ Cf. Nicom., *Ench.* 12, p. 264; Cleonid. 4, p. 184–6; Thrasyllus *ap.* Theon, *Util. math.* 91–2; Anon. Bell. § 66; Cod. Vat. 192, fol. 222r (Reinach 1897: 315–16).

¹⁹ So correctly Barker, *GMW* II: 317 n. 9 (although reading "*chromatikos*", an erroneous 'emendation' in Düring's edition, taken back in Düring 1934: 18). Barker is misunderstood by Solomon 2000: 61–2 n. 14, as well as by Redondo Reyes 2002: 519–20 n. 358, who nevertheless provides a good account of the general confusion about the passage.

²⁰ Cf. the proposed reconstruction of the late-fifth-century eleven-stringed cithara: above, n. 77 on p. 26; below, n. 59 on p. 283.

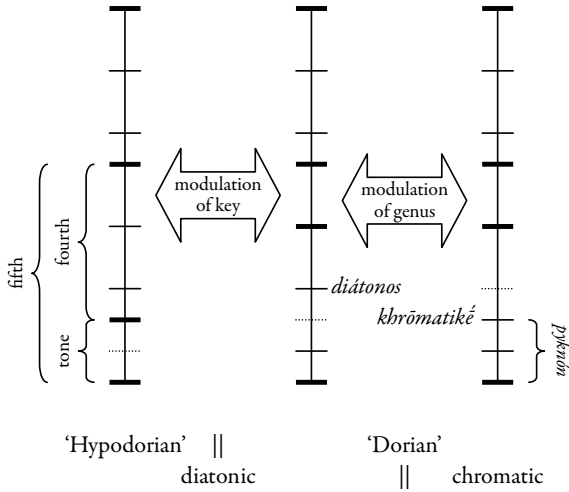
Diagram 27 Modulation by *kbrōmatiké*

‘New Music’ movement towards the end of the fifth century BC,²¹ and there is no doubt that the *kbrōmatiké* goes back at least to that period. The most striking evidence for this date are the early divisions of the tetrachord, to be considered below, which invariably posit the chromatic *likhanós* at the distance of a 9:8 tone from *hypátē*, even if this severely compromises the mathematical beauty of the whole system. Ptolemy doubtless faced the same problem: although he testifies to the continued existence of the ‘chromatic string’, he is not able to account for its chromatic function, but treats it only as a tetrachord boundary note, in accordance with the definition of its pitch by the modulating framework. In Ptolemy’s cithara octaves, chromatic melodies are provided for only in the upper region, where the tuning called *trópoi* includes a chromatic tetrachord of mathematically derived beauty. Was contemporary music diatonicised to such a degree that the old chromatic *mésón* tetrachord survived merely in a string name? At any rate, the music of composers of the halcyon times of the chromatic must still have been heard – thus, Ptolemy’s tacit neglect of the chromaticism in the lower part of the scale is perhaps more due to the impossibility of reconciling the musical facts with his mathematical principles.

²¹ ‘New Music’ is a modern term for the advances brought forth by the leading musicians of that time (but cf. Timoth., *Pers.* 203; *μουσικὴ νεοτευχῆ*). Unfortunately it is mostly perceived through the filter of deliberately exaggerated expressions of conservative reaction; but cf. Aristot., *Met.* 993b. Cf. e.g. Richter 1968; *GMW*1: 93–8; Csapo 2004.

That the cithara should have maintained such distinctive features over almost seven hundred years seems again perplexing. It reminds us of the similar continuity in pitch standard, which we have discussed earlier. The cause must once more be sought in the specific circumstances of post-classical music culture. The compositions of outstanding musicians such as Timotheus remained well known, and throughout the Hellenistic period there was apparently no new wave of original music, whose composers could have replaced the standards set by their great predecessors. Presumably the technical possibilities of lyre playing – although perhaps not making – had become fully explored, as well, in the agonistic culture of the late fifth century, once traditional restrictions were overcome. Thus it is not entirely surprising that standards of tessitura could remain relatively stable afterwards.

It is another token of this continuity that Ptolemy's account can elucidate the fifth-century Pythagorean Philolaus' famous reference to the lyre *harmonía*. Without mentioning any particular tuning,²² Philolaus writes:

ἁρμονίας δὲ μέγεθος ἔστι συλλαβὰ καὶ δι' ὀξειᾶν· τὸ δὲ δι' ὀξειᾶν μείζον τᾶς συλλαβᾶς ἐπογδόωι. ἔστι γὰρ ἀπὸ ὑπάτας ἐπὶ μέσσαν συλλαβὰ, ἀπὸ δὲ μέσσης ἐπὶ νεάταν δι' ὀξειᾶν, ἀπὸ δὲ νεάτας ἕς τρίταν συλλαβὰ, ἀπὸ δὲ τρίτας ἕς ὑπάταν δι' ὀξειᾶν. (Philol., fr. 6a = Nicom., *Ench.* 9, p. 252.17–22)

The size of *harmonía* is a fourth [*syllabá*] and a fifth [*dí' oxeián*].²³ And the fifth is larger than the fourth by 9:8. For from *hypátē* to *mésē* there is a fourth, from *mésē* to *néte* a fifth, from *néte* to *tritē* a fourth, from *tritē* to *hypátē* a fifth.

What Philolaus establishes here is the framework of the 'central octave'. The term '*harmonía*' clearly denotes the octave, but it cannot be separated from the octave as organised into the particular symmetric inner structure, described in the form of a rudimentary tuning cycle. Together with its simple numeric rendition as 6:8:9:12, this structure also became the prime code for harmony in later writers.²⁴ Considering the evidence from Ptolemy, we must acknowledge that it was not merely repeated over and over by

²² Of course there were several possible tunings at that time, as well; cf. n. 6 on p. 105 above. That the lyre is the reference instrument is ensured by the archaic application of the term *tritē*: when the string names were transformed into note names of cross-instrumental applicability, the octave was no longer gapped, and the 'third string' occupied a different position in the scale.

²³ These archaic interval names, transmitted especially in Pythagorean writings, are found only rarely; cf. Porph., in *Harm.* 96.29–97.8; Burkert 1962: 368.

²⁴ Cf. e.g. the hymnic diction in Aristotle, *ap. ps.-Plut.*, *Mus.* 1139b–1140a (cf. Barker 2007: 329–38; probably an exposition of Pythagorean thought). In Boethius we find this harmonic set projected back to Hermes' lyre; cf. above, pp. 81f.

adherence to a music-philosophical tradition, but rested on elements of musical culture which were omnipresent throughout all those centuries: it is certainly no coincidence that all of Ptolemy's cithara tunings incorporate the same basic structure as described by Philolaus. Notably, a rather early date for lyres regularly spanning an octave is also evinced by the designation of this interval as *diá pasôn*, 'throughout all [strings]'.²⁵

To fully appreciate the fact, it is important to understand that the appearance of perfect fourths and fifths from each of the boundary notes of Ptolemy's octaves is by no means an accident (cf. Diagram 26 on p. 109 above). Only in the 'Dorian' tunings of *lýdia* and *parypátai*, where the central tone is identical with the disjunctive tone of theory, follows this structure from the basics of tetrachordal arrangement. In all other cases the individual tetrachord tunings have to be chosen cautiously in order to establish the whole tone at the right position – later we shall evaluate Ptolemy's account from this perspective.²⁵ For the present, it suffices to state that the adherence to the 'Philolaic' pattern is a *sine qua non* for Ptolemy. Nevertheless he does not mention this principle at all, probably because it was self-evident anyway.

This, then, is the second characteristic of Ptolemy's tables that can safely be regarded as rooted in a practical tradition going back at least to the fifth century BC. There, however, it is not merely the virtuoso cithara that is involved, but the entire lyre tradition, probably from archaic times on: Philolaus' reference to *tritē* in the place of the later *paramésē* betrays that he is not talking about the musical avant-garde (perhaps already of philosophically disputed reputation), but about the old seven-stringed lyre of divine ancestry.²⁶

Furthermore, it appears that from some point on only such tunings were used that were true *harmoníai*, in the sense that they established this core structure. From a musical point of view such a restriction is perfectly understandable, since a maximum of resonance with those strings which stand in octave relationship to each other ensures a greater richness of sound than other possible tunings.²⁷ If there ever was a period in which all seven possible diatonic tunings were employed in Greece,²⁸ this practice was likely

²⁵ See below, pp. 194ff.

²⁶ Note in this context the reference to seven concordant strings (ἑπτὰ συμφώνους χορδᾶς) in one textual tradition of the Homeric Hymn to Hermes, 51, which Franklin 2002b: 676–7, argues as alluding to a full 'Pythagorean' cyclical tuning. I regard it as equally possible that the structural *harmonía* of four strings is implied, regardless of how the remaining three strings are tuned (i.e., perhaps also by the use of minor resonance).

²⁷ Cf. Hagel 2005a: 303–4; 315 with n. 80.

²⁸ Arguments for such a 'cyclical' musical culture are put forth by Franklin 2002b.

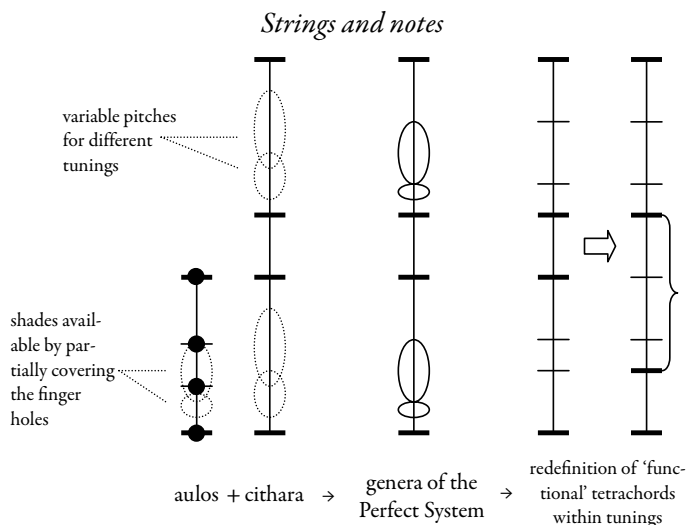

Diagram 28 Origins of the concepts of fixed and moving notes

doomed as soon as the interval of the octave was introduced to the lyre – a feat that is attributed to Terpander.²⁹ For all we know, Philolaus' cycle through the four notes of the framework could well reflect the first steps that he carried out when tuning his lyre.³⁰

The practical importance of this harmonic framework from an early time onwards provides a natural starting point for the conceptions of Greek theory with its 'fixed' and 'movable' notes. With such a background, a structure of fixed notes into which others could be fitted according to various schemes was the self-evident way of grasping tonal relations. The main contribution of pure theory was the abstraction of the tetrachordal structure from the framework, by defining the 'standard' shape of the tetrachord according to the 'Dorian' tuning, and to perceive different tunings as containing shifted tetrachords of this standard shape. Here, however, the aulos with its versatile *pyknón* probably played a significant role, since it provided a good reason to regard only the lowest note of a *pyknón* as belonging to the fixed category. Diagram 28 is a schematic representation of this process.³¹

²⁹ Cf. above, p. 35 n. 95.

³⁰ Compare also the mythical construction of an original four-stringed lyre incorporating only this framework, attested for Nicomachus by Boethius (see above, p. 81).

³¹ In the Diagram, the aulos finger holes divide the tetrachord into $\frac{3}{4}$ tone + $\frac{3}{4}$ tone + 1 tone; cf. *AGM*: 97–100. The example for the redefinition of the tonal structures of certain cithara tunings represents diatonic 'Hypodorian', corresponding to Ptolemy's *tritai*.

Although this may appear surprising, professional modulating tunings must have supported the alignment of auletic and citharodic tetrachords, with the resulting definition of functional note names. On instruments that contained separate strings called *khrōmatiké* and *diátonos*, *parypátē* was pinned down to the position a semitone above *hypátē*, in congruence with its functional definition.³² In the era of simple heptachords, there was in all probability considerably more variation in the lowest interval. One must notice especially that with the relatively well-attested octave between the outermost strings a semitonal *parypátē* could not take

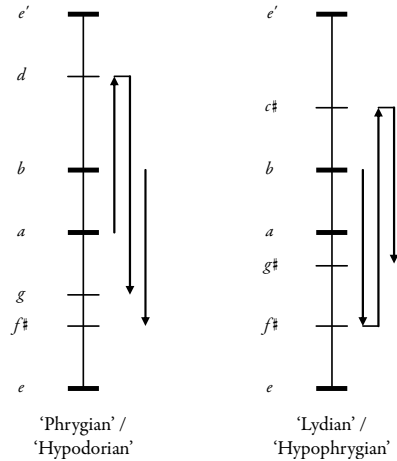

Diagram 29
Heptatonic tunings 'by consonance'
on a lyre with 'Dorian *nētē*'

part in a tuning of seven strings 'by consonance': if the upper fourth is divided by but one note, no more than two different scales can be established by fifths and fourths only (cf. Diagram 29³³). It surfaces that the 'Dorian *nētē*' precludes a Dorian tuning in Pythagorean diatonic.³⁴ The conclusion is almost inevitable that at least *parypátē* was often established in a different way.

It has become clear, how the old citharistic approach to the tetrachord left its traces. Presumably it is also reflected in the emphasis put on the species of the fourth:³⁵ the different diatonic tunings on an octachord – be it an eight-stringed lyre or a contiguous scale as a subset of a modulating

³² This narrowed-down quasi-functional value of the term *parypátē* can also explain the otherwise surprising 'functional' usage of this note name in ps.-Aristot. *Pr.* 19.3–4.

³³ In the diagram, the tunings are labelled according to the (later) octave species. Due to the missing note, no unambiguous assignment is possible.

³⁴ Other tunings would require the use of intermediate notes on strings that are subsequently retuned. E.g., for a 'Dorian' *e-f-g-a-b-d-e'*, one would tune $a \rightarrow e' \rightarrow e$ and $a \rightarrow d \rightarrow g$, then alter d to ($g \rightarrow$) c , then tune ($c \rightarrow$) f , then d again, i.e. establish nine instead of seven pitches. In practice, such a procedure is not only inconvenient, but virtually useless, since it is not possible to test the intervals in a second run, as would be necessary: the change of tension involved in retuning two strings by an entire tone affects the curvature of the yoke and therefore the rest of the pitches. Anyway, nothing is gained by abstract consonances that are no longer available once the instrument is played: in our example, the f of the ready tuning stands in no consonant relation to any other note. Consequently, a direct tuning by ear must have been preferred, perhaps exploiting intervals of minor resonance.

³⁵ First in Aristox., *Harm.* 3.74, p. 92.12–17. Unfortunately, the text breaks off at this point, so that we cannot know how Aristoxenus' argument is going to proceed.

instrument – could be defined by the shapes of the two fourths that fill the framework of *harmonía*. When Aristoxenus implies the existence of ‘tetrachords’ that do not lie between fixed notes,³⁶ he reveals that the old lyre-centred view on the relations between keys as embodied in retuning cycles and modulations was still alive, and the final orientation of music theory towards the Perfect System only just taking place.

It remains to examine the last reference in Ptolemy’s discussion, namely that to the tetrachord from *trítē* to *diátonos* of *iastiaiólia* (number 3 on page 109 above). *Trítē* corresponds to the third highest string, thus contributing to our picture of a traditional professional terminology of strings ‘by position’. Even more interesting is the qualification of the tetrachord’s lower boundary note as *diátonos*. This note neither bears any functional connotation with the diatonic genus (it is a fixed note), nor does it correspond in pitch to the diatonic *likhanós* of the basic tuning, which lies a semitone lower. Still its designation can be understood in historical terms: the note in question is obtained from the same string that was called *diátonos* (as opposed to *khrōmatiké*), and whose pitch becomes raised by a semitone only in the *iástia* tuning. In the context of musical practice and especially teaching it is therefore not surprising that reference was made to this string by the same name as in the other tunings, although this name no longer made any proper sense. On the other hand, such a nomenclature is possible only if the instrument did not at the same time incorporate another string that corresponded to the usual *diátonos*: in other words, if the tuning refrained from certain types of modulation.³⁷ Unfortunately, the few references in Ptolemy do not suffice to clarify the nature of this restriction, nor do they throw enough light on string naming on modulating instruments.

Thus we have to be content with what we get: the clear proof that cithara strings were called by ‘thetic’ names in a professional tradition, which persisted side by side with the theoretical treatises’ ‘functional’ terminol-

³⁶ Aristox., *Harm.* 2.46, p. 57.13–16; 2.49, p. 61.11–12; cf. Bacchius 75, p. 308.8–10. In the diatonic, Aristoxenus’ straightforward definition of musical ‘continuity’ (*synékheia*: 2.54, p. 68.1–6; 3.58–60, p. 73.4–75.10 with the definition of *eidos* in 3.74, p. 92.6–11) holds for all species of the fourth; for the chromatic and enharmonic, the rules must be restricted to the standard form of the tetrachord by some additional regulations which Aristoxenus announces, but which are not found in the extant parts of his work (2.54–5, p. 68.7–9; cf. *GMW* II: 167 n. 109). As far as I see, Aristoxenus ensures the restriction by the premise that the intervals of a *pyknón* are never separated from each other (which almost follows from the meaning of the term, after all).

³⁷ Cf. however the perception of modulating music as “splitting one note in two”, which I suppose is present in ps.-Plut., *Mus.* 1141d (... πλείοσι τε φθόγγοις καὶ διερριμμένοις χρῆσάμενος ... διέρριψεν εἰς πλείονας φθόγγους; for different interpretations, cf. Borthwick 1967: 146–7; Porter 2007: 13–14); compare the medieval differentiation of *b* into *b durum* and *b molle*.

ogy, which had been abstracted from instrumental practice quite early. Nevertheless, the ‘thetic’ nomenclature was so well known that Ptolemy could be sure to be understood when he used it, without further explanation, when referring to cithara strings.

So these are the string names that can be derived from Ptolemy’s text; together with *hyperypátē*, they make a total of nine:³⁸

hypátē parypátē khrōmatiké diátonos mésē paramésē trítē (paranētē) nētē

THE QUESTION OF *MÉSĒ*

In the light of our conclusions, we can finally address the question that has set off a large part of the scholarly discussion about ‘thesis’ and ‘dynamis’:³⁹ when ancient sources refer to the melodic primacy of *mésē*, do they talk about the functional ‘note below the disjunctive tone’, corresponding to the modern tonics of the minor keys? Or is an invariable ‘thetic’ *mésē* implied, which consequently defines the modality of its surrounding scale? The second option has the great advantage of accounting nicely for modal diversity, as expected from fifth-century ‘modes’ with their purported ethical implications,⁴⁰ which a functional *mésē* would reduce to questions of pitch and relative ambitus. And yet the almost universal employment of ‘functional’ terminology in the treatises made it problematic to attribute a Ptolemaic conception to texts from a much earlier period.

These texts are few, and have been discussed over and over. Even so, our new insights permit us a somewhat sharper view on them, especially if we focus on the organological context of each passage: as we have seen, the functional note names of the technical treatises are related rather to aulos music, while citharists naturally retained the ‘thetic’ string names. Of course, we shall investigate only passages with a minimum of contextual information, as might allow to distinguish between the two approaches. Probably the oldest is an example that Aristotle gives for the spatial meaning of πρότερον, ‘previous to’:

... οἷον παραστάτης τριτοστάτου πρότερον καὶ παρανήτη νήτης· ἔνθα μὲν γὰρ ὁ κορυφαῖος, ἔνθα δὲ ἡ μέση ἀρχή. (Aristot., *Met.* 1018b)

³⁸ The string name *parypátē* can reasonably be deduced from the tuning called *parypátai*. Only *paranētē* is not mentioned by Ptolemy in the context of the cithara.

³⁹ Cf. Winnington-Ingram 1936, esp. 6–9.

⁴⁰ For a qualification of the scalar contributions to ethos, cf. Wallace 2005.

... as, for instance, the second-row singer is previous to the third-row singer, and the *paranéēē* to the *néēē*: for here the chorus-leader is the starting point, and there the *mésē*.

The first example invokes the chorus of the drama, where the chorus-leader dances in the centre of the first line, flanked by two *parastátai* and two *trítostatai*. Similarly, it is most natural to interpret the musical image not by reference to the abstract scheme of the Perfect System of music theory, but to the lyre, which Aristotle's hearers were perfectly familiar with. The strings of the instrument form a precise parallel to the epicentric arrangement of the chorus line, with *mésē* occupying a physical centre flanked on each side by an equal number of objects.⁴¹ The assumption that Aristotle talks of the functional *mésē* inevitably excludes a reference to the instrument: if the 'dynamic' *mésē* lies within the higher range of the strings, the 'dynamic' *néēē* is no longer part of the tuning at all.⁴² But in the context of 'thetic' string names, Aristotle's example holds regardless of the actual tuning.⁴³

A similar association of *mésē* with a leading position is expressed in a pseudo-Aristotelian *Problem*:

⁴¹ Cf. Franklin 2001: 248–53, with reference to the correspondence between *mésē* and the Aristotelian ideal of *mesótēs*.

⁴² This appears neglected in Plut., *Plat. quaest.* 1008e, where the position of the functional *mésē* on the lyre is used as a point of reference: ... ἔτι δὲ τὴν μέσην, ἐν ᾧ τις ἂν χωρίῳ τῆς λύρας θέμενος ὡσαύτως ἀρμόσθεται, φθεγγομένην δεξιότερον μὲν ὑπάτης βαρύτερον δὲ νήτης. "... and that the *mésē*, in whichever part of the lyra it is put and the tuning established accordingly, sounds higher than *hypátē* and lower than *néēē*". The argument appears to contradict what Plutarch had stated immediately before, namely that *hypátē* and *néēē* are the outermost strings on the *lyra* (cf. n. 21 on p. 5 above). The contradiction would be partly resolved on the assumption that the two notes are imagined as parts of the vocal melody, in case they exceed the instrumental tuning in question. The assumption of such a mixed image is however unlikely; on top of this, it does not remove the principal problem that the first argument uses 'thetic', the second 'functional' terminology. The most natural explanation is that the first argument is copied from an older tradition, while the second is young, perhaps devised by Plutarch himself. In this case, the term *lyra* would refer first to the 'classical' lyra, similar to that envisaged by Aristotle, but afterwards possibly to the fifteen-stringed instrument of the Roman era which Ptolemy also knows under this name. In any case, the view expressed by the second argument could develop only when the Perfect System was firmly established in upper class musical education, whether bolstered by a specific instrument or not.

⁴³ It is a priori conceivable that functional note names emerge out of their function as the starting point of the tuning procedure. But this would not account for the specific name of *mésē*: from a functional *mésē* 'a' = LA, the diatonic tuning proceeds four steps in one and two in the other direction ($a \rightarrow d \rightarrow g \rightarrow c \rightarrow f$ vs. $a \rightarrow e \rightarrow b$); in this respect, the central note is 'd' = RE. In comparison, the Near-Eastern tuning procedure was carried out in one direction throughout, starting from (functional) 'b' = SI, whose position on the instrument varied with the tuning. Accordingly, each tuning was called after the string pair from which one started to establish it, which is an entirely 'thetic' approach; except for the 'tritone', the 'impure' interval that occurred in various positions in the different tunings, no functional conceptions appear to have evolved in the Near-Eastern tradition; cf. West 1994: 168.

διὰ τί εὐαρμωστότερον (ἀπὸ τοῦ ὀξέος) ἐπὶ τὸ βαρὺ ἢ ἀπὸ τοῦ βαρέος ἐπὶ τὸ ὀξύ; πότερον ὅτι τὸ (μὲν) ἀπὸ τῆς ἀρχῆς γίνεται ἀρχεσθαι; ἢ γὰρ μέση καὶ ἡγεμῶν ὀξυτάτη τοῦ τετραχόρδου. (ps.-Aristot. *Pr.* 19.33)

Why is it more harmonious [to proceed] from high to low than from low to high? Is it, because this means starting with the starting point? For the central note (*mésē*) and leader/guide (*hēgemōn*) is the highest of the tetrachord.

Here it is not clear if the writer envisaged an instrument at all. If so, only the central string can be meant, since a functional *mésē* can occupy a position at the lower end of the octave scale – and probably often did so⁴⁴ – from which the melody cannot possibly move downwards. At any rate, the argument is entirely compatible with the old citharistic approach, in which ‘tetrachord’ would be used for any division of the framework *harmonia*’s lower fourth, without regard to the ‘fixed’ notes of the Perfect System.

Other passages in the pseudo-Aristotelian *Problems* reveal that the octave of the lyre of musical education is generally in the background, whereas there is no sign of awareness of functional terminology. In one passage it is asked why the octave stands out from the other intervals, in that an octave relationship between voice and accompaniment is perceived not much differently from unison.⁴⁵ The answer refers not to the octave in general, but to *hypátē* and *néte*, the only octave that is found on the simple lyre, and more specifically to the harmonic triad *hypátē* – *mésē* – *néte*.⁴⁶ Apparently a general question about a musical phenomenon that occurs only in a tonal space significantly larger than the single octave is addressed in terms of the classical lyre: the writer takes it as all but natural that the characteristics of this instrument provide the key to musical structures.

⁴⁴ Namely in ‘Hypodorian’ tunings such as Ptolemy’s *trítai* and *trópoi*, which instantiate the neighbouring key of the basic tuning.

⁴⁵ ps.-Aristot. *Pr.* 19.18–19.

⁴⁶ The cause given for the special status of the octave is that “only they [namely *hypátē* and *néte*] stand at equal distance from *mésē*” (μόνοι ἴσων ἀπέχουσι τῆς μέσης), which is the reason for their similarity. Jan 1895: 89, interprets this as alluding to the old ‘defective’ seven-stringed tuning, where the two outermost strings stand at an equal distance of three ‘positions’ from *mésē* (cf. Diagram 25 on p. 104 above). Yet even if the propositions in the *Problems* are not always brilliant, it cannot have escaped the specific writer’s mind that there is more than one epicentric pair in an arrangement of seven, especially as he emphasises the exclusiveness of the relation. The distance envisaged is more likely of a numeric kind, derived from the famous representation of the harmonic framework as 6 : 8 : 9 : 12, with 6 : 9 : 12 = 2 : 3 : 4 representing *néte* – *mésē* – *hypátē*. Here, the equal distance (12 – 9 = 9 – 6 = 3, or 4 – 3 = 3 – 2 = 1, which translates to similar lengths on the canon) of the note pair to the centre is indeed exclusive. The relation is expressly stated by Thrasyllus *ap.* Theon, *Util. math.* 88.13–15. Significantly, only the central octave is in view; the unique relation between the three notes is even suspected to be the cause of the ‘natural’ restriction of the scale. Obviously the writer is not acquainted with the extended calculation for the Perfect System, where equal distances also occur between *néte diezeugménōn* – *mésē* – *hyperypátē* (3 : 6 : 9 = 1 : 2 : 3; cf. Thrasyllus *ap.* Theon, *Util. math.* 89.18).

Another contributor, however, regarded the regular octave as the natural point of reference, and already found it necessary to explain that the term *mésē* goes back to the era of seven strings.⁴⁷ Even there, however, *mésē* is clearly perceived as belonging in the central position, or at least region, of the given set of notes, and consequently there is no idea of a functional *mésē*.

Similarly, *parypátē* appears as a low note as well as *hypátē*; and *nētē* is invariably addressed as lying in the high range – there being no doubt that these notes correspond to actual lyre strings.⁴⁸ All in all, the note names cited in the *Problems* are either unequivocally ‘thetic’ in character or, in a few cases, compatible with both approaches. It is in this context that the celebrated statement about the melodic primacy of *mésē* must be read:

διὰ τί, ἔαν μὲν τις τὴν μέσην κινήσῃ ἡμῶν ἀρμόσας τὰς ἄλλας χορδὰς, καὶ χρῆται τῷ ὀργάνῳ, οὐ μόνον ὅταν κατὰ τὸν τῆς μέσης γένηται φθόγγον λυπεῖ καὶ φαίνεται ἀνάρμοστον, ἀλλὰ καὶ κατὰ τὴν ἄλλην μελωδίαν· ἔαν δὲ τὴν λιχανὸν ἢ τινα ἄλλον φθόγγον, τότε φαίνεται διαφέρειν μόνον, ὅταν κάκεινῃ τις χρῆται; ἢ εὐλόγως τοῦτο συμβαίνει; πάντα γὰρ τὰ χρηστὰ μέλη πολλάκις τῇ μέσῃ χρῆται, καὶ πάντες οἱ ἀγαθοὶ ποιηταὶ πυκνὰ πρὸς τὴν μέσην ἀπαντῶσι, κἂν ἀπέλθωσι ταχὺ ἐπανέρχονται, πρὸς δὲ ἄλλην οὕτως οὐδεμίαν. (ps.-Aristot. *Pr.* 19.20)

Why is it that, if someone of us shifts the *mésē*, having tuned the rest of the strings, and makes use of the instrument, that he causes pain and seems out of tune not only whenever arriving at the note of the *mésē*, but also within the rest of the melody – but if [he shifts] the *likhanós* or some other note, then the difference stands out only when he uses that note? Is this only to be expected to happen? For all decent melodies use the *mésē* often, and all good composers visit it regularly, and when they depart from it, return quickly, but not so to any other one.

Given the virtual absence of functional terminology in the *Problems* and especially the unmistakable lyre-centred background of the present passage,⁴⁹ we cannot but interpret *mésē* as the central string here, as well. Its superior role in the melody is reflected in the tuning procedure. Why *mésē* can be brought out of tune only after an entire consistent tuning is

⁴⁷ ps.-Aristot. *Pr.* 19.25; 19.44; 19.47; cf. also 19.32.

⁴⁸ ps.-Aristot. *Pr.* 19.3–4; 19.12 (the production of two *nētai* by stopping the *hypátē* string in the middle, cf. also 19.24); 19.42 (with reference to instrumental physics); 19.7 and 19.47 (several *harmoniai* are all bounded by *hypátē* and *nētē*, cf. n. 6 on p. 105 above. The answer to 47, however, refers merely to the ‘conjunct’ system; read Bojesen’s text without Jan’s addition of μόνον and καί).

⁴⁹ Apart from the fact that tuning and shifting individual notes make no sense in wind instruments, the complicated expression ὁ τῆς μέσης φθόγγος, which is incompatible with functional terminology, testifies to a conception of *mésē* as primarily a string, not a note.

achieved transpires from another passage, where a different answer to the same question as above is considered:

ἢ ὅτι τὸ ἡρμόσθαι ἐστὶν ἀπάσαις τὸ [δὲ]⁵⁰ ἔχειν πῶς πρὸς τὴν μέσην [ἀπάσαις], καὶ ἡ τάξις ἡ ἐκάστης ἤδη δι' ἐκείνην; ἀρθέντος οὖν τοῦ αἰτίου τοῦ ἡρμόσθαι καὶ τοῦ συνεχόντος οὐκέτι ὁμοίως φαίνεται ὑπάρχειν.

(ps.-Aristot. *Pr.* 19.36)

Is it because being in tune means for all of them to stand in some relation to the *mésē*, and the station of each of them is already [defined] through it? So if the cause of being in tune is taken away, that which holds them together, it no longer appears to be the same.

How deeply rooted in lyre tuning practice this in more than the superficial sense central position of *mésē* was is shown by its apparently unchanged role some centuries later, when Dio Chrysostom employs it as a simile for the ultimate objective at which all individual actions of one's life should be oriented:

χρὴ δὲ ὥσπερ ἐν λύρᾳ τὸν μέσον φθόγγον καταστήσαντες ἔπειτα πρὸς τοῦτον ἀρμόζονται τοὺς ἄλλους – εἰ δὲ μὴ, οὐδεμίαν οὐδέποτε ἀρμονίαν ἀποδείξουσιν – ...

(Dio Chrys. 68.7)

It is necessary, just as on the lyre one sets up the middle note, in order to tune the others in relation to it – otherwise they will by no means display harmony – ...

Here the definite practical sense of the old designation of *mésē* as 'starting point' (*arkhḗ*) and 'leader/guide' (*hēgemōn*) finally becomes clear.⁵¹

The consistency of this tuning practice from Aristotle to Dio corresponds to that of the harmonic framework, which, as we have seen, remained similarly stable from at least the end of the fifth century BC until at least the second century AD. Only where *mésē* divided the octave between *hypátē* and *néte* into a fourth and a fifth could it serve as the starting and focal point of the tuning. Accordingly, its melodic function must be considered exclusively within this framework. This leads us to a synthetic

⁵⁰ For the text, cf. the parallel wording in Cleonid. 11, p. 202.3–5, below p. 122.

⁵¹ Other references to *mésē* as *arkhḗ*: ps.-Aristot. *Pr.* 19.44 and probably Aristot., *Pol.* 1254a; as *hēgemōn*: Aristox. *ap.* ps.-Plut., *Mus.* 1135a. Franklin 2006b: 63, argues for a connection with the Mesopotamian fourth string, exalted by the name 'Ea-Made-It'. But the Near-Eastern tonal system rests on a standard ninth with an acknowledged centre on the fifth string, whereas the heptatonic basis appears never stressed; it is also unclear whether the Greek *mésē* ever was the fourth highest string in a diatonic series and thus musically comparable to its Ea-made 'counterpart'. As regards the Mesopotamian tuning procedure, any of the seven higher strings could in principle take the lead, producing the seven different diatonic scales in turn.

solution to the scholarly controversy between the advocates of a ‘thetic’ and a ‘dynamic’ *mésē*. The central note in question is neither the abstract functional *mésē* of the Perfect System, nor the Ptolemaic abstraction of a ‘thetic *mésē*’ of any octave species in any genus. Rather, it is the central string of a well-defined set of lyre tunings, all of which incorporate a stable harmonic framework. Since these tunings stand in a conspicuous relation to a basic tuning, in which the string names correspond to the respective degrees of the Perfect System, no harsh opposition between ‘thetic’ and ‘dynamic’ names was seen in antiquity.

Consequently, the specific character of *mésē* as determining the other notes, which appears as a rather loose conception in the *Problems*, could be adopted by Aristoxenian theory and applied to the Perfect System, albeit with precise qualifications:

ἀπὸ δὲ τῆς μέσης καὶ τῶν λοιπῶν φθόγγων αἱ δυνάμεις γνωρίζονται, τὸ γὰρ πῶς ἔχειν ἕκαστον αὐτῶν πρὸς τὴν μέσην φανερώς γίνεται.

(Cleonid. 11, p. 202.3–5)

And from *mésē* the functions of the rest of the notes are perceived; for the relation of each of them to *mésē* becomes clear.

Although Cleonides is concerned exclusively with abstract Aristoxenian systems, it is astounding how close the wording still is to *Problem* 19.36 quoted above. Without doubt the author of the *Problem*, who was thinking only of strings, would not have hesitated to agree with Cleonides’ formulation – which shows how much of the dichotomy between ‘thesis’ and ‘dynamis’ is but modern chimera, born from undue extension of ancient ideas beyond the boundaries of ancient practice.

THE *HORMASÍA*

There is another document that relies on the same citharodic tradition as Ptolemy’s vocabulary: the mysterious table commonly known as the ‘*koiné hormasia*’, contained in more or less complete form in a number of manuscripts in which various musical material is compiled (most complete in Cod. Pal. 281, see Figure 2).⁵² Its two columns, it appears, are the remains of a larger collection of lists, from the rest of which only the headings survive.

⁵² DAM^o 6.

Ἡ ΚΟΙΝὴ Ὁρμασία		Ἡ ΚΟΙΝὴ Ὁρμασία		
ἀριστερὴ χεῖρ		δεξιὰ χεῖρ		
ΠΡΟΣΔΕΔΕΜΜ	Ζ	ΜΑΤΗΜΩΓΑ	Φ	ὈΡΟΛΥΝΝ
ΔΕΣΝ	Κ	ΣΠΩΤΗ	Λ	ΤΡΑΙΑΝΝ
ΝΗΤΗ	Λ	ΧΡΩΜΑΤΙΚΗ	Λ	ΣΠΡΑΥΛΥ
ΣΥΝΝΗΜΕΝΗ	Λ	ΔΙΑΤΟΝ	Λ	ΜΑΤΟΝΑΡ
ΣΥΝΝΗΜΕΝΗ	Λ	ΔΕΣΝ	Λ	ὈΡΟΛΥΝΝ
ΔΙΑΤΟΝ	Κ	ΠΑΡΑΔΕΣ	Λ	ΜΑΤΟΝΑΡ
ΔΙΑΤΟΝ	Κ	ΤΡΙΤΗ	Λ	ΧΡΩΜΑΤΙΚΗ
ΠΑΡΑΔΕΣ	Κ	ΣΥΝΝΗΜΕΝΗ	Λ	ΣΠΡΑΥΛΥ
ΤΡΙΤΗ	Λ	ΝΗΤΗ	Λ	ΜΑΤΟΝΑΡ
ΔΙΑΤΗΜΩΓ	Λ	ὈΡΙΑΧΤΜΑΤΙΚΗ	Κ	ὈΡΟΛΥΝΝ
ΣΠΩΤΗ	Λ	ὈΡΙΑΧΤΗΝ	Κ	ΤΡΑΙΑΝΝ
ΠΑΡΑΔΗ	Λ	ὈΡΙΑΔΕΣ	Κ	ΣΠΡΑΥΛΥ
ΧΡΩΜΑΤΙΚΗ	Κ	ὈΡΙΑΠΑΡΑΔΕ	Κ	ΜΑΤΟΝΑΡ
ΔΕΣΝ	Κ	ὈΡΙΑΤΡΙΤΗ	Κ	ὈΡΟΛΥΝΝ
ΠΑΡΑΔΕΣ	Κ	ὈΡΙΑΣΥΝΝΗΜ	Κ	ΜΑΤΟΝΑΡ
ΤΡΙΤΗ	Λ	ὈΡΙΑΝΝΗ	Κ	ὈΡΟΛΥΝΝ

Figure 2 The *koiné hormasia* (Codex Palatinus 281, fol. 173r) (Reinach 1896: 189 pl.1)

The *hormasia* withstood all modern attempts to explain its curious details, and was ultimately discarded as a late reconstruction depending on a mutilated source.⁵³ Nevertheless I think it is possible to demonstrate that it is in fact a valuable document of ancient origin; even if it will not be possible to solve all its riddles here, some light will hopefully be shed on the coherent approach that underlies it.

Since the *hormasia* contains no melody, it is rightly excluded from E. Pöhlmann’s and M.L. West’s current standard edition of ancient Greek musical documents. It will therefore be convenient to reproduce its contents in translation (Table 4).

Each of the two columns contains a series of note names, accompanied by the respective note signs and an unexplained pair of letters that reads either $\frac{A}{M}$ or $\frac{O}{K}$. The notes are basically the same in both parts, although in different order, and while the left-hand column includes the *proslambanó-*

⁵³ DAM, 34–5. Bélis (1995: 1059) clings to the other extreme, citing it as a piece of cithara music for two hands (cf. n. 55 below).

The common tuning, adapted from the *Music* / According to citharody⁵⁴

	left hand ⁵⁵			right hand			
Lydian, diatonic	<i>proslambanómenos</i>	Ο Κ	7 Γ	<i>diápeptos</i>	Α Μ	Φ F	Hyperlydian, diatonic
	<i>mésē</i>	Ο Κ	ι <	<i>hypátē</i>	Α Μ	C C	Hyperlydian, diatonic
	<i>nētē</i>	Α Μ	Θ ϛ	<i>khrōmatiké</i>	Α Μ	Ο K	Hyperaeolian, diatonic
	<i>synēmménē</i>	Α Μ	Υ Λ	<i>diátonos</i>	Α Μ	Ζ <	Hyperaeolian, diatonic
	<i>synēmménē</i>	Α Μ	Υ Λ	<i>mésē</i>	Α Μ	ι <	Hypoiastian, chromatic
	<i>diátonos</i>	Ο Κ	Ζ <	<i>parámesos</i>	Α Μ	Π □	Hyperaeolian, diatonic
	<i>diátonos</i>	Ο Κ	Ζ <	<i>tritē</i>	Α Μ	Ε Π	Hyperaeolian, diatonic
	<i>parámesos</i>	Ο Κ	Ζ □	<i>synēmménē</i>	Α Μ	Υ Λ	Lydian, all three genera
	<i>tritē</i>	Α Μ	Ε Π	<i>nētē</i>	Α Μ	Θ ϛ	Hyperphrygian, enharmonic
	<i>diápeptos</i>	Α Μ	Φ F	high <i>khrōmatiké</i>	Ο Κ	Ο' K'	Hyperaastian, diatonic
	<i>hypátē</i>	Α Μ	C C	high <i>diátonos</i>	Ο Κ	Ζ' <	Hyperaastian, enharmonic
	<i>parypátē</i>	Α Μ	Ρ C	high <i>mésē</i>	Ο Κ	ι' <	
	<i>khrōmatiké</i>	Ο Κ	Ο K	high <i>parámesos</i>	Ο Κ	Ζ' Π'	
	<i>mésē</i>	Ο Κ	ι <	high <i>tritē</i>	Ο Κ	Ε' Π'	
	<i>parámesos</i>	Ο Κ	Ζ □	high <i>synēmménē</i>	Ο Κ	Υ' Λ'	
	<i>tritē</i>	Α Μ	Ε Π	high <i>nētē</i>	Ο Κ	Θ' ϛ'	

Table 4 The *koiné bormasia* translated

menos, at the right hand a complete second octave is added at the upper end.

Unusual note names such as *diátonos* and *khrōmatiké* demonstrate that the material belongs in the same citharodic tradition that we know from Ptolemy's references. On the other hand, it is clear that the *bormasia* does not depend on Ptolemy (at least not entirely), since it also preserves two unparalleled terms: *diápeptos* for *hyperypátē*, and *synēmménē* for *paranētē*. The former is easily understood as indicating the principal function of the

⁵⁴ The manuscripts give different headings: ἡ κοινὴ ὄρμασια ἢ ἀπὸ τῆς μουσικῆς μεταβληθεῖσα *Pal.*; κατὰ κίθαρῳδίαν *Neap.*

⁵⁵ 'Left hand' and 'right hand' are not playing instructions but indicate that there are two (independent) columns; cf. Jan 1895: 423; 1897: 168; *DAM*, 34.

- Finally, what is the meaning of the letter pairs $\frac{A}{M}$ and $\frac{O}{K}$, which are applied consistently within each column, but differently between the two?

As regards the first question, it has been suggested that the order of notes reflects the tuning procedure of the cithara.⁵⁷ And indeed it can be proven that this is the case. Diagram 30 shows how, starting from *proslambanómenos*, each subsequent note can be derived from an earlier established one by tuning either an octave or a fifth or a fourth, resulting in the typical ‘Pythagorean’ tuning.

But how can we be sure that this is the intention of the list, and not mere coincidence, especially since the arrangement does not follow a neat cycle where the last note established is always the starting point of the next step? This is a matter of simple calculation. Of the eleven notes of column one, there are in principle $11! = 39\,916\,800$ possible arrangements. But only a small part of these, namely $239\,040$, establish a ‘Pythagorean’ tuning sequence.⁵⁸ In all the others, the tuning chain is broken, for instance because the *f*# appears earlier than the *b* (but not at the start). In other words, only 0.60 per cent are valid progressions, and the odds to obtain one by mere chance are only 1:167.⁵⁹ Thus it is practically certain that the first column of the *hormasia* is intended to establish a Pythagorean tuning. It is, however, not so clear that the tuning of a cithara is meant, even if this seems implied by the heading. Alternatively, such a progression could stand in a purely theoretical context, namely in a Pythagorean division of the canon.⁶⁰ Such a context might be taken as suggested by the initial *proslambanómenos*, which represents the full string length of the traditional canon,⁶¹ here sepa-

⁵⁷ Jan 1895: 422–3; 1897: 168.

⁵⁸ Since the relations between the notes are rather complicated I found it most convenient to let the computer evaluate all $11!$ arrangements. It will be noticed that in the case of recurring notes as in the *hormasia*, only the first instance has to be considered, so that indeed all arrangements can be reduced to simple sequences of 11.

⁵⁹ It might be objected that *proslambanómenos* was probably the starting point by definition in any case, so that only the other ten notes should be taken into account. Yet the results are identical, with 22 176 valid out of $10! = 3\,628\,800$ possible sequences, resulting in a ratio of 0.61%. Even if the second position of *mésē* were regarded as fixed (which already establishes the basis for four further notes), one arrives at not more than $6\,048$ out of $9! = 362\,880$, or 1.67%. Here the odds of an accidental result rise to 1:60; but the assumption of *mésē* as the effective starting point *per se* associates the sequence with practical cithara tuning; cf. above, p. 121.

⁶⁰ In the extant ps.-Euclidean *Division of the Canon*, however, the sequence of established notes runs quite differently: *proslambanómenos* – *diátonos hypatōn (hyperypátē)* – *mésē* – *nētē hyperbolatōn* – *nētē synēmménōn (synēmménē)* – *nētē diezeugménōn* – *hypátē* – *parámesos* – ‘low *hypátē*’ – *tritē hyperbolatōn* – *diátonos hyperbolatōn* – *tritē diezeugménōn* – *parypátē mesōn* – *parypátē hypatōn* – *diátonos mesōn* (*Sect. can.* 19–20, p. 163–6); compare also the sequence established in Aristid. Quint. 3.2, p. 97.17–98. Against this background, the *hormasia* appears especially practice-oriented.

⁶¹ Cf. *Sect. can.* 19, p. 163.17–164.2; Ptol., *Harm.* 2.13, p. 68.2–3 (Didymus).

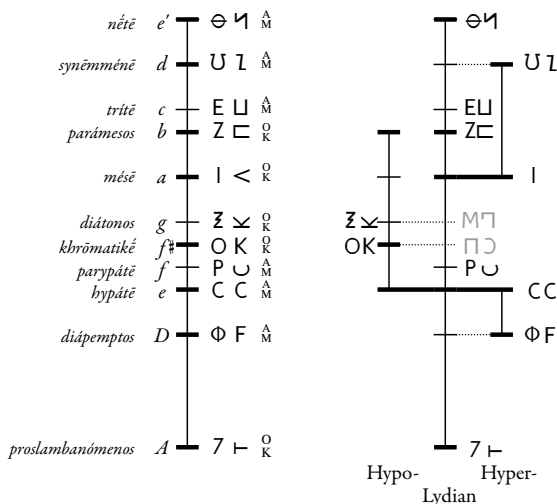

Diagram 31 *Koinē hormasia*, left column, as a tonal structure

rated by a fourth from the lowest established note, but which is not a cithara string. On the other hand, we will presently detect more unmistakably citharodic characteristics in the *hormasia*, and it is perfectly possible that the tuning process described starts from a *proslambanómenos* in a very specific sense: either from the lowest pitch of an aulos which serves as a pitch pipe⁶² (a notion that would probably derive from contexts where both instruments were played together), or from the lowest note accessible to the voice of the citharode, as described by Aristides Quintilianus.⁶³ But whether the instrument for which the tuning procedure is described was the cithara or the canon, the tuning in question is certainly a cithara tuning: apart from the *proslambanómenos*, it comprises the central octave plus *hyperypátē*, and in the lower tetrachord the *diátonos* appears side by side with the *khrōmatiké*, whereas mere theoretical divisions encompass either an octave or the complete double octave, and either one genus or a complete mixture of genera.

Diagram 31 displays the tonal structure that results from the tuning procedure of the left column, both as a scale and as implementing part of the Lydian triad. Here the employment of the Hypolydian notes OK/ΖΥ instead of the corresponding Lydian ΠΔ/ΜΠ stands out clearly (the Hyper-

⁶² For the *proslambanómenos* as the aulos *bómbyx*, cf. below n. 21 on p. 333.

⁶³ Aristid. Quint. 1.10, p. 21.13–22.10; cf. above, pp. 68ff.

lydian is present only in the note name ‘*synēmμένē*’). It has been suggested that the composer of the table had access only to the Hypolydian scale, namely in an already mutilated copy of Gaudentius, and made the best of it he could.⁶⁴

But there are manifest tokens that the Hypolydian was used intentionally. In the left column, most notes are assigned the cryptic abbreviation $\frac{A}{M}$. The other letter pair $\frac{O}{K}$ is reserved for the *proslambanómenos* and four contiguous notes, which range from *paramésē* down to *khrōmatiké*. These notes form a regular tetrachord, although not in the basic Lydian key, but in Hypolydian (and Hyperastian). Whatever the meaning of the abbreviations is, in the left column they are clearly used to draw attention to this tetrachord. But in a context that emphasises the Hypolydian aspect of the given tuning, we need not be disturbed if Hypolydian note signs are found, as well. The notation also underscores the status of *khrōmatiké* as an effectively fixed note, invariably positioned one whole tone above *hypátē*, emphasising its function of forming a modulating fourth with *paramésē*, over its secondary role in a chromatic *pyknón*. Finally, the tetrachord in question is among those which Ptolemy refers to, namely that from the *stereá* tunings.⁶⁵ One might consider whether the *hormasia* is perhaps in some way related to a discussion of Ptolemy’s work. If not (and we have seen that it contains knowledge about citharodic practice beyond what can be deduced from the *Harmonics*), it testifies to a more general awareness of the tetrachord in question – an awareness which further explains Ptolemy’s condensed diction.

The obvious correspondences between the *hormasia* and Ptolemy encourage us to view the scales of the former in the light of the latter. The *hormasia* appears to establish the connection between two of Ptolemy’s tunings, namely *tritai* and *parypátai* – with notational emphasis on *tritai*. That this pair belongs together seemed already probable on the basis of Ptolemy’s tables, where the tetrachord divisions are chosen in such a way that all their shared notes do in fact coincide.⁶⁶ On the other hand, Ptolemy’s intervals appear to differ from those of the *hormasia*. The tuning procedure described there leads to a ‘Pythagorean’ scale, from which Ptolemy’s refined mathematics deviate in several cases.⁶⁷ Nevertheless, the structural

⁶⁴ *DAM*, p. 35. It seems, however, rather implausible that whoever could compile such a consistent table should not have had at his disposal a n y of the treatises that give the Lydian scale.

⁶⁵ Cf. Diagram 26 on p. 109 above.

⁶⁶ This coordination demands the introduction of the ‘soft diatonic’ for the lower tetrachord of *parypátai*, a division which appears only here. Cf. above, Diagram 15 on p. 60; see also below, pp. 19–4 ff.

⁶⁷ Ptolemy’s *tritē* and *diátonos* are lower by 27 cents, his *parypátē* by 6 cents.

coincidences seem obvious enough to draw the connection. The divergent fine tuning, on the other hand, makes it less plausible that the *hormasia* is anyhow dependent on Ptolemy's *Harmonics*; both accounts seem to derive from citharodic practice independently.

The right column of the *hormasia* arranges the notes in ascending order and adds their octave counterparts (cf. Diagram 32). *Proslambanómenos*, however, and *parypátē* are now excluded, the former certainly because it formed only the starting note of the tuning procedure but does not correspond to a cithara string; the right column presents the available tonal material. The omission of *parypátē*, on the other hand, underscores that the main objective of the first column was to establish the Hypolydian part of the tuning, by derivation from the basic Lydian.⁶⁸ In the purely Hypolydian scale of the second column, the employment of the Hypolydian notation is certainly all but natural. Considering this apparent transition from Lydian to Hypolydian, it is however problematic to extend the scope of the caption "Lydian, diatonic" to both columns, as it is commonly done. Notably, this label is written not above the table, but to the left of the left column; it finds its counterpart at the right side in a list of similar expressions (cf. Figure 2 on p. 123 above). The first of these is "Hypolydian, diatonic". This fits the contents of the right column, so that there can be little doubt that it indeed belongs there, and that only the tables to which the subsequent captions refer are lost.⁶⁹

For the notes of the higher octave, the signs are furnished with 'octave strokes'. This practice is in accordance with the notation tables in the treatises; the range of the notes, however, exceeds even the ambitus of the fifteen-scale system.⁷⁰ Once more, the *hormasia* is closer to practice than to theory: on the cithara, the octave-stroke notes were evidently played as the first harmonics of the strings associated with the basic note signs.⁷¹ Since the higher and thinner strings produce harmonics of clearer sound and more easily, it would make no sense at all to dismiss the highest notes from a table of available cithara tonality. Here we have direct evidence that the addition of octave strokes within a notational system that otherwise pays

⁶⁸ Note in this context that the *khromatiké* is reserved for the final step of the tuning procedure.

⁶⁹ This connection was never made because the note names were thought to represent the usual functional terminology, which would ascribe them to the Lydian Perfect System (cf. Reinach 1896: 199 with n. 1), while they are in fact 'thetic' string names.

⁷⁰ In effect, another disjunct tetrachord is added at the top of the Lydian scale; consequently, there are four extra notes as regards the Lydian (Ζ Γ Ε Λ Ὑ Ι Θ Ψ), two of which are not used in any key of the fully developed system (Ε Λ Θ Ψ).

⁷¹ Cf. above, p. 32 with n. 88.

no tribute to the octave was very probably elicited by the production of harmonics on the stringed instrument. It adds to the picture that the ‘harmonic’ notes are not labelled according to the Perfect System, not even those that form part of it. The Perfect System, whose nomenclature entirely neglects octave relations, and especially its *hyperbolaïon* tetrachord, was apparently conceived in the context of aulos scales, where the production of harmonics at the octave is impossible.⁷² On the cithara, in contrast, the higher octave was naturally perceived as redoubling the available notes. Hence it was not necessary to create an extended tonal system to account for it; the terminology of the *hormasia* probably reflects the citharists’ approach very closely.⁷³

In the second column, the distribution of the curious letter pairs is quite straightforward: the notes available from the open strings are labelled as $\frac{A}{M}$, the harmonics as $\frac{O}{K}$. The entirely different application in the two columns makes it clear that these abbreviations, or whatever they are, have nothing to do with scalar functions. The common denominator seems to be something like ‘this note does not belong to the basic set’ for $\frac{O}{K}$, as opposed to ‘regular’ $\frac{A}{M}$ notes: the *proslambanómenos* does not form part of the cithara tuning, the Hypolydian tetrachord does not form part of the basic Lydian scale, but constitutes a modulation, and the harmonics are not part of the stringing. Notably, it would make no sense to mark out the ‘Hypolydian tetrachord’ in the second column, too, because here it is embedded in an entirely Hypolydian scale.

One might consider two possible meanings of the letter pairs: firstly, the similarity between $\frac{O}{K}$ and the notational $\frac{O}{K}$ catches the eye,⁷⁴ especially as



Diagram 32
Koinē hormasia, right column

⁷² The unusual ‘harmonics’ described by Najock 1996 were produced on pipes with uneven bore, entirely unlike the ancient aulos.

⁷³ Similarly, no attempt was made at a system that embraces both the normal playing mode (*aulein*) and the high ‘whistling’ mode (*syrittein*) of the aulos, in which higher harmonics were used (cf. Hagel 2005a: 87–9).

⁷⁴ Cf. Reinach 1896: 204 n. 1 (“coïncidence singulière”).

they are associated in the left column. Similarly, $\frac{A}{M}$ might be related to the notational doublet $\frac{M}{\Gamma}$, where an inversion would have to be assumed, possibly due to the reiteration of the signs in long vertical columns. In this case, the *khōromatikē* $\frac{O}{K}$ as the one definitely modulating note would originally have stood in contrast to the *diátonos* $\frac{M}{\Gamma}$, perhaps comprising both the opposition between diatonic and chromatic and between the Lydian and the Hypolydian key (or Dorian and Hypodorian tuning, if we adopt Ptolemy's probably older terminology). The application of the same $\frac{O}{K}$ to the *proslambanómenos* and the harmonics, however, would have to be explained by a rather unlikely extension of meaning. Still, by a curious coincidence, OK are at the same time the first note signs to be supplied with an octave stroke,⁷⁵ so that in the scales of the two columns the contiguous series of $\frac{O}{K}$ labels start from $\frac{O}{K}$ and $\frac{O'}{K'}$, respectively, as their lowest notes.

Alternatively, if the *hormasía* reflects a division of the canon in order to reproduce a cithara tuning, perhaps roughly analogical to Ptolemy's tests, it is tempting to interpret $\frac{O}{K}$ and $\frac{A}{M}$ as abbreviations of some case of *kóllabos* and *mágas*, tuning peg and bridge, as the two complementary devices of pitch adjustment on the experimental instrument.⁷⁶ I am, however, unable to figure out any procedure in which the given distribution becomes meaningful; moreover, we would have to assume that the *hormasía* is the last trace of a very sophisticated work, which applied methods that we otherwise know only from Ptolemy (although it would probably have been more traditional in content).⁷⁷

It remains to explain the recurring notes in the left column: the double *synēmménē* and *diátonos*, as well as the appended *mésē* – *paramésē* – *trítē*. The immediate repetition of a note makes no sense at all in a tuning sequence. On the other hand, the recurrence of some notes at the end might be explained as a case of 'testing' the established intervals, or as the re-establishment of some notes of major importance that might have changed their pitch slightly since they were tuned (for instance because the adjustment of string tensions has changed the geometry of the instrument). Yet it is implausible that a note of secondary importance such as *trítē* should have been tuned anew, while *nētē* and *synēmménē* were not. Nor is there any

⁷⁵ So explicitly Gaud. 21, p. 350.2–9 (for the thirtieth note of the semitone series mentioned there, cf. above Diagram 13 on p. 48).

⁷⁶ Cf. e.g. Ptol., *Harm.* 2.16, p. 81.5–21.

⁷⁷ Not even on the assumption that the *hormasía* considers 'tuning-peg' notes as to be tuned not by perfect fifths and fourths, but by the intervals of practice as established by ear, can it be brought into accordance with Ptolemy's divisions: its (non-'tuning peg') *parypátē* must be derived from *trítē*, but these notes do not include a perfect fifth in Ptolemy's *parypátai* tuning. Note furthermore that Ptolemy talks about *harmogai*, whereas *hormasía* is an unparalleled derivation of the same stem.

note against which *trité* could be tested that was not established in relation to *trité* anyway. Thus, all the doublets seem equally meaningless. On the other hand, the two columns appear in the manuscripts in a striking balance, which does not derive from an inherent logical structure: although their contents and purpose are entirely different, the lists are combined into a symmetrical table of sixteen rows, thus wrongly suggesting some association between two notes within the same row. This arrangement is obviously a misunderstanding, which most probably also caused the doublets. Originally, two lists must have stood side by side, one comprising eleven, the other sixteen notes. Some copyist mistook this arrangement for a table; compare the cell borders in Figure 2. In the course of transferring the lists to such a preconceived table, unequal line spacing must soon have posed a problem. In two cases, the copyist attributed two notes from the left list to one of the right. Even so, the left column was shorter, and it seems that the remaining three positions were filled with material from another list, one that contained a contiguous scale.⁷⁸

On balance, the *koiné hormasia*, although we were not able to provide unambiguous solutions for all its problems, figures among the most important documents for our study. Above all, it preserves the explicit connection between citharodic ‘thetic’ nomenclature and notational signs, for which Ptolemy’s *Harmonics* gave only indirect evidence, and thus supplies the ultimate proof for the relation between Ptolemy’s *tónoi* and those of Aristoxenian tradition. Secondly, it confirms that octave harmonics belonged to the art of lyre playing, and suggests an intimate connection between this instrumental practice and the octave strokes of the notation. Finally, the *hormasia* also provides direct evidence for the presence of a *hyperypátē* string on the cithara, and the restriction of the ambitus of this instrument to a ninth.⁷⁹

⁷⁸ Possibly this table comprised an account of modulation from Lydian/Hypolydian into Hyperlydian, the next key in the caption list at the right of the table: these scales differ only above *mésē*. Note, however, that the ‘abbreviations’ are consistent with the original list; perhaps they were not used in the source of the three supplementary notes and therefore copied from their counterparts above.

⁷⁹ The expert citharodic background of the ‘*mousiké*’ from which the *hormasia* claims to be taken supports the idea that it was identical with the ‘*mousiké*’ that contained pieces by Mesomedes (cf. *DAGM*: 114–15). The similar headings of the *hormasia* in the Palatinus (ἀπὸ τῆς μουσικῆς μεταβληθείσα) and the Mesomedes poems in the Ottobonianus (παρεξεβλήθησαν ἀπὸ τῆς μουσικῆς) suggest, however, that both already depend on the same compilation. The poems are only associated with the Lydian and the Hypolydian, notably the same two keys which the *hormasia* establishes.

HOW TO TUNE A LYRE

The sources we have considered combine to a consistent and musically plausible picture of post-archaic lyre tuning. The *harmonía* was guaranteed mainly by a framework of ‘fixed’ notes in a very practice-near original sense of the word. Its minimal form was expressed in the triad *hypátē* – *mésē* – *nētē* (*e*–*a*–*e*’), doubtless inherited from archaic times;⁸⁰ but from the fifth century BC on the usual basis is the tetrad *hypátē* – *mésē* – *paramésē* – *nētē* (*e*–*a*–*b*–*e*’), with *paramésē* inheriting the function of Philolaus’ *tritē*. An important extension was brought about by the addition of *hyperypátē* (*d*), an octave below ‘*synēmménē*’ (*d*’, in tunings where it was available). Into this framework of mutual enforcement by maximal resonance, intermediate notes were inserted, whose specific pitches determined the character of the tuning. These were the truly ‘movable’ notes, which lent their conception to the inner notes of the standard tetrachords of music theory.

The citharistic conception, however, continued to coexist side by side with the terminology of theory, naturally clinging to the ‘thetic’ string names to which we find Ptolemy referring. It is beautifully expressed by Quintilianus in the late first century AD, as an example for the practice of dealing with an in principle infinite multiplicity by picking out one definite set of instances:

Eademque musicis ratio est, qui cum in cithara quinque constituerunt sonos, plurima deinde varietate complent spatia illa nervorum, atque his quos interposuerant inserunt alios, ut pauci illi transitus multos gradus habeant. (Quint., *Inst.* 12.10.68)

The same idea is followed by the musicians, who, after setting up five notes on the cithara, fill the remaining space of strings with the greatest variety, and between those which they have put in they insert others, so that these few transitions assume many [different] steps.

In contrast to the various ‘inserted’ pitches, the basic five must constitute an unchanging framework of reference. With considerable confidence we may identify them with the old tetrad augmented by *hyperypátē*. The ‘few transitions’ are the fourths between *hypátē* and *mésē*, and between *paramésē*

⁸⁰ Cf. Plato, *Rep.* 443d (ὄρους τρεῖς ἁρμονίας, νεάτης τε καὶ ὑπάτης καὶ μέσης); Plut., *Quaest. conv.* 744c (οἱ τὰ διαστήματα παρέχοντες ὄροι, νῆτη καὶ μέση καὶ ὑπάτη· καίτοι Δελφοὶ γέ τας Μούσας οὕτως ὠνόμαζον); 745b; *SEG* 30.382 (Kritzas 1980: Argos, c. 300 BC: Νήτας. Μέσ-σας. Ὑπάτας πράτας. Οἱ: Πράτας = *hyperypátē*?); *Frag. Cens.* 12, p. 75.5–6; cf. also Diod. Sic. 1.16.1.

and *nētē*, indeed fewer than the five fixed notes, and comprising within each tuning fewer notes. The mention of iterated insertion may refer to modulating tunings, with many actual intermediate steps, or merely to the fact that two notes must be established within each of the fourths, with a great number of possible steps.⁸¹ We will contemplate their various pitches in the following chapter.

It is of the essence that Quintilianus credits his audience with sufficient familiarity with the basics of lyre music to understand his example. Ptolemy's readers must, in addition, recognise the names of the strings, and if they are to assess the validity of his divisions, possess a trained ear as well. Knowledge of string names and intervals is also among what Quintilianus expects from the educated.⁸² At any rate one could assume a general awareness of the principles of lyre scales in the educated public of the Roman empire in its heydays, in Alexandria as well as in Rome, in readers of Latin as well as of Greek.

The details of the tuning framework explain why *mésē* never ceased being acknowledged as the 'leader'. From *mésē*, one tuned a fifth upwards to *nētē* and a fourth downwards to *hypátē*, a fourth upwards to *synēmménē* (where applicable) and a fifth downwards to *hyperypátē* / *diápemptos*.⁸³ As regards the framework *harmonía*, only *paramésē* must be tuned from another note.

⁸¹ In this case the expression would provide a practical parallel to Ptolemy's mathematical procedure of iterated division.

⁸² Quintilianus' insistence on musical education: *Inst.* 1.10.1–33, esp. 3: ... *qui citharae sonos nominibus et spatiis distinxerit.*

⁸³ Often I find it gives better results, when tuning the two lowest strings of the nine-stringed cithara, to use fifths and fourth and not the octave from the highest strings, using the latter merely for testing.

CHAPTER 5

Fine-tuning

GENERAL CONSIDERATIONS

While dealing with the more general outlines of ancient scales, we were able to talk in terms such as tone, semitone and, in some cases, quartertone, indulging in a simplification similarly familiar to us as to ancient musicians and music theorists. Even though if the actual intervals of performance may diverge considerably from any fixed definition, the simplified terms make sense in a music culture that is based, either historically or synchronically, on diatonic heptatony. In this musical paradigm, which is strongly associated with stringed instruments, and whose origins lie beyond the second millennium BC, the main unit is defined as the difference between a pure fifth and a pure fourth: the tone. When it was constructed recurrently, until there remained no gap large enough to fit another tone into, the result is 'our' typical heptatonic scale, called 'diatonic' by the Greeks: 'constructed by tones throughout'.¹

If one carries the tuning process further, another fifth or fourth will cut an existing tone in halves, apparently: semitones. Similar intervals were already established as the remaining gaps in the seven-note scale.

The quartertone, on the other hand, does not come up in resonant tuning of strings. Ancient tradition attributed its invention to aulos players, with good reason: the technique of half-covering finger holes easily leads to such small intervals. Their classification as quarter-tones, however, presupposes a theoretical consciousness that crosses the borders between instruments and musical styles. The aulos provided no stable recurring pitches, especially not for the notes that were not obtained from open holes. The exact intervals of ancient aulos tunes were thus open to discus-

¹ Cf. Franklin 2002b: 674–5. For the procedure expressed in note names, cf. n. 10 on p. 106 above.

sion, and the obviously professional instrumentalist term *diésis*, ‘letting through’, was also equated with the semitone of lyre tuning before it became more firmly associated with the quartertone.² Aristoxenus pays tribute to the flexibility of the auletic scales by reckoning with a variety of *diéseis*. Once more, we perceive a tension in Greek musical thought between a more lyre-centred and a more auletic view, while the evolved ideas of the Aristoxenian school are again born out of a synthesis of both into a coherent – if abstract – picture of music.

Yet even if lyre strings ideally provide a set of fixed pitches during performance, there are in principle infinite ways of adjusting the intervals between them. And although we have seen that the harmonic framework of the instrument had remained stable over centuries, the sources suggest considerable variation not only in the arrangement, but also in the size of the intervals with which this framework was filled. This entails that the tuning by fifths and fourths was often, if not regularly, only a first step, after which the resulting scale had to be adjusted at one or several points.

The most obvious reason for adopting such a ‘fine tuning’ procedure is the creation of minor resonance:³ beautifully sounding string combinations that are not present in a purely ‘Pythagorean’ tuning, as the simple form has come to be called. By small adjustments of string tension resonant major and minor thirds, for instance, are easily established – although at the cost of one or the other resonant fifth or fourth. It is also possible that in certain cases a compromise was sought, where a note was used in two mutually exclusive contexts of resonance, so that, for instance, both a ‘fourth’ and a ‘third’ were acceptable, although neither was pure. This would be a case of tempered – though not necessarily equally tempered – tuning. We shall discuss a possible example shortly.⁴

The task of this chapter is the evaluation of the available sources and the assessment of their respective correlation to musical practice. In view of the complex and disputed matter, it is advisable to state the most important methodological principles in advance. One has already been mentioned: wherever possible, the instrumental background should be taken into regard. The aulos will not easily refute any claims about the exact size of its

² Philol., fr. 6a (see p.112 above); Plut., *Anim. procr.* 1018e; 1019a; Procl., *in Tim.* 191e, 2.168.28–9; Theon, *Util. math.* 55.11–15; 56.18–19; 91.8–92.16 (λεῖμμα διεσίστου); Cod. Vat. 192, fol. 224r (Reinach 1897: 319, §1.8–9).

³ By ‘resonance’, I refer to the physical basis of the perception of consonance (cf. Franklin 2005: 12–13). The latter is now generally understood not as the perception of the ‘blending’ of two (or more) sounds, but burdened with the culturally determined conception of musical agreeability.

⁴ Below, pp. 140ff.

intervals (nor prove them). On stringed instruments, on the other hand, at least the principles of the tuning procedure were commonly recognised and could not easily be disregarded by a theorist.

Secondly, the viewpoint of practising musicians should be considered; although it is not directly transmitted, it sometimes emerges from the treatises, either as the criticised 'primitive' view, or as the common basis of different theoretical approaches.

Thirdly, no writer can be trusted before her or his motives have been thoroughly examined. This is crucial especially where tunings are described by numeric values and the topic of mathematical beauty comes into view. The greater the elegance of a numeric account, the greater must also be our suspicion that the pursuit of elegance might have overcome the interest in representing practical music. What is more, we must be careful in insinuating such an interest at all. Especially when embedded in a metaphysical system, musical theory is liable to prescribing scales of philosophical beauty rather than describing those of everyday music, which is frequently deemed decadent in such a context. On the other hand, resonant intervals do correspond to simple numeric ratios; consequently, mathematical elegance *per se* is not an argument against the practical orientation of an account, no more than it is an argument for it. Only one constellation makes it extremely likely that information from real music-making stands behind the theorists' figures, namely where we encounter a major aesthetic shortcoming in an author who is concerned with mathematical beauty otherwise. Among the possible causes for such a flaw the coercing force of commonly recognised facts ranges very high.

Fourthly, there is the question as to whether a theoretically described intervallic structure is accessible at all on the instruments in question, and assessable by the musical ear: those elements that are not must belong to the realm of mathematical fiction.⁵ The converse, however, is not true. The mere fact that a given tuning can be established more or less easily on the lyre by no means proves that it was indeed employed in practical music-making.

Finally, we must not suppose any ancient account to rest on experiments (let alone accurate experiments), unless there is clear evidence to this fact, or unless there is no alternative explanation for the choice of one set of intervals instead of another. To put it the other way round: whenever the figures of a theoretical tuning system can be deduced from reasonable basic assumptions, musical, philosophical or mathematical, the belief that the

⁵ This question is systematically addressed in Franklin 2005.

divisions have been ascertained on an experimental instrument is entirely ungrounded.⁶

SYSTEMATIC RESTRICTIONS

Within one ‘scale’, one is free to choose any kind of fine tuning. At the end of the fifth century, however, Greek music was no longer restricted to simple scales. Especially the styles that were held in the highest esteem by the public indulged in modulation between different keys. These keys were implicitly related through the circle of fifths, and as a consequence modulation must be understood as a stabilising force, which prevented excessive digressions from the old ‘Pythagorean’ scheme. This is because in a number of cases basic notes of one key correspond to functionally different notes of another. Only a ‘Pythagorean’ fine tuning, in which the intervals within one scale and the procedure of modulation are governed by the same principle, ensures that the respective pitches coincide accurately. In other kinds of fine tuning, differences of various sizes arise. Theoretically, one could account for such divergences by using different strings for the two notes; but in practice lyre strings are much too valuable a resource (in terms of playing technique, not materially), and instrumentalists – if aware of the problem at all – preferred to spend them on the general extension of tonal space, internal or external.

Let us consider the consequences in detail; we need not follow the process of modulation beyond its simplest example, the modulation between a conjunct and a disjunct tetrachord. Its immediate implications can be gathered from Diagram 33:⁷

- The fourth between *mésē* (*a*) and *nētē synēmménōn* (*d*), which determines the conjunct scale, at the same time fixes the pitch of *paranētē diezeugménōn*. In practice, the role of the string as a ‘fixed’ note was more

⁶ Early experiments, as reported for Lasus of Hermione and Hippasus of Metapontum (Theon, *Util. math.* 59.4–21; Schol. Plato, *Phaed.* 108d), confirmed the figures for the consonances but were not exact enough to be extended to those smaller intervals that are the topic of this chapter. The Pythagoreans in Plato, *Rep.* 531a–c, are also described as interested mainly, if not solely, in concords.

⁷ The note equations are systematically stated by Thrasyllus *ap.* Theon, *Util. math.*: *paranētē diezeugménōn* = *nētē synēmménōn* (91.23–4; cf. Nicom., *Ench.* 11, p. 259.11–13); *paranētē synēmménōn* = *tritē diezeugménōn* (92.1–2); *paramésē* = *khrōmatikē synēmménōn* (92.8–9).

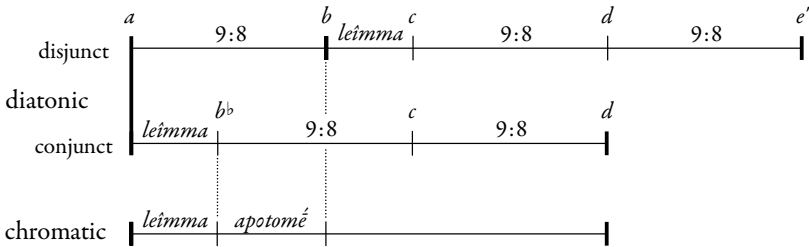

Diagram 33 'Pythagorean' diatonic and chromatic as a consequence of modulation

prominent, so that we found it called simply '*synēmménē*' in the *koinē hormasia*.⁸

- Similarly, *paranētē synēmménōn* coincides with *trítē diezeugménōn* (c).

If both tetrachords are to be realised in similar intervals, the combination of these two relations enforces a 'Pythagorean' tuning:⁹ the first establishes the highest interval as a whole tone, and the second equates the central interval with the highest one. Alternatively, however, it is conceivable that different divisions are used for the two scales.

- Furthermore, a chromatic *pyknón* must obtain the size of another whole tone, since its upper note coincides with that above the disjunctive tone (*b*).
- The central note of the chromatic *pyknón*, on the other hand, coincides with the respective diatonic note (*b^b*).

In other words, while the size of the chromatic *pyknón* is determined by the harmonic framework, its division is linked to the diatonic. This applies not only to the *synēmménōn* modulation as shown in the diagram, but also to the similar structure that emerges in the lower part of the octave with the modulating '*khrōmatiké*' string.

Those of the listed restrictions that are caused by the harmonic framework of tetrachordal structure and modulation are not easily overcome. Negating them means nothing less than undoing the basics of Greek harmonic theory, and indeed we know of no treatise that accounted for such

⁸ Cf. also Cod. Vat. 192, fol.222r (Reinach 1897: 315): διάτονος, καὶ νῆτη συνημμένων. Similar sensibility for note equations seems to stand behind the curious 'title' assigned to the figures for Aristoxenus' commensurable 'tonic' chromatic on fol.224v: κοινὸν τονιαίου χρώματος καὶ τῶν διατονικῶν μελῶν, "common to the tonic chromatic and diatonic melodies".

⁹ Cf. Tannery 1915: 94.

an endeavour. Only once is such a practice mentioned, in a scathing reference typical for Aristoxenus:¹⁰

μαλάττουσι γὰρ αἰεὶ τὰς τε λιχανοὺς καὶ τὰς παρανήτας. ἤδη δὲ καὶ τῶν ἐστῶτων τινὰς παρανιασι φθόγγων ἀλόγῳ τινὶ διαστήματι, προσανιέντες αὐτοῖς τὰς τε τρίτας καὶ τὰς παρανήτας, καὶ τὴν τοιαύτην εὐδοκιμῆν μάλιστα πῶς οἶονται τῶν συστημάτων χρῆσιν, ἐν ἧ τὰ πολλὰ τῶν διαστημάτων ἐστὶν ἄλογα, οὐ μόνον τῶν κινεῖσθαι πεφυκότων φθόγγων, ἀλλὰ καὶ τινῶν ἀκινήτων ἀνιεμένων, ὧς ἐστὶ δῆλον τοῖς αἰσθάνεσθαι τῶν τοιοῦτων δυναμένοις.
(ps.-Plut., *Mus.* 1145d)

All the time they soften the *likhanoí* and the *paranétai*, and are already going so far as to lower even some of the ‘standing’ notes along with them by some incommensurable interval, lowering the *tritai* and *paranétai*¹¹ in addition. And they regard such a scalar practice as especially agreeable, in which the bulk of the intervals is incommensurable, not only the naturally movable notes, but also some of the fixed being lowered, as is obvious to those who are able to perceive such things.

This is diatribe, of course, and must not be taken too literally. Especially the plurals are certainly rhetorical, and it need not be assumed that more than one note of each type in question was concerned. One might think that among the fixed notes, the *paramésē* is the obvious candidate for being tuned down: whereas *hypátē* – *mésē* – *nétē* form the primary framework, with intervals of considerable modal importance, the concords between *hypátē* – *paramésē* – *mésē* seem to have been much less prominent. But it should be noticed that the author’s primary intention (which becomes clear from the context of the passage) is not to accuse the group he is talking about of tearing down the fundamentals of Greek music, but merely to make clear that their practice embraces precisely that sort of intervals which their theory implicitly deprecates (intervals, by the way, which Aristoxenus admits). The reference to the altered fixed notes illustrates how far they are ready to go in this direction. All this taken into account, it is probably wise to accept the least catastrophic reading of the passage as a working hypothesis.

Actually, it can be understood without reference to any of the four notes which constitute the stable harmonic framework of lyre practice, and perhaps this is also the most natural interpretation. In a first step, the higher movable notes of both tetrachords are tuned down (i.e., from a ‘Pythago-

¹⁰ For ps.-Plutarch’s sources, cf. Lasserre 1954: 104.

¹¹ Barker (*GMW*1: 246 n.249) proposes to read “*tritai* and *parypátai*”, these being notes of identical positions in the tetrachord.

rean' raw tuning – Aristoxenus' 'tense diatonic' – as the natural starting point). Obviously the diatonic genus is meant; in the others, this procedure would result in a *pyknón* of the wrong shape, with the smaller interval at the top. Thus, a kind of 'soft diatonic' is established. As we have seen above, such a division is in principle mutually exclusive with *synēmménon* modulation, which requires a stable whole tone at the top of the tetrachord. Aristoxenus' wording may indicate that this restriction is ignored, and a kind of wrongly tuned modulation carried out. For his systematic mind, *paranētē diezeugménōn* and *nētē synēmménōn* remain quite separate entities even if they are played on the same string.¹² Hence, a reference to "tuning down some fixed note", namely the fixed *nētē synēmménōn*, "along with" the *paranētē* is perfectly justified, even if the physical process is one and the same.¹³ The last step, then, makes good sense without altering the text. To conceal that the *synēmménon* tetrachord is malformed, an adjustment of its interior intervals suggests itself. Two strings are concerned, namely *paranētē synēmménōn* = *tritē diezeugménōn* and *tritē synēmménōn*, in good accord with Aristoxenus' wording.

The necessity of this adjustment becomes especially obvious if the process is envisaged as the introduction of more resonant small intervals. In this case, the initial down-tuning of *paranētē diezeugménōn* must result in a wide septimal tone (8:7) at the top of the tetrachord, and at the same time a septimal third (7:6) to *paramésē* (cf. Diagram 34 with ratios and cent numbers). No other resonant intervals are possible at this position. The resulting soft diatonic is not identical with Aristoxenus' division of this name, but indeed 'incommensurable'.¹⁴ In the context of a maximally reso-

¹² Cf. Aristoxenus' complaint that 'different' tetrachords are notated by the same signs (*Harm.* 2.40, p. 50.4–9; cf. Pöhlmann 1988: 74–6 and 1997: 286, rejecting doubts whether the passage can apply to the notation as we know it; e.g. Chailley 1979: 123–4; now again Barker 2007: 60–6), which must refer to the fact that the 'same' tetrachord has different functions in different keys (e.g. the Lydian *diezeugménōn* tetrachord is identical with the Hypolydian *hyperbolaíon*) – but of course these distinctions do not translate to any difference on any instrument. An analogous criticism on modern stave notation would point out the fact that *c* is notated similarly whether it is the tonic of *C* major or the dominant of *F* major, etc.

¹³ One might wonder if not $\sigma \upsilon \nu \alpha \nu \iota \alpha \dot{\iota} \sigma \iota$ would be expected instead of $\pi \alpha \rho \alpha \nu \iota \epsilon \nu \tau \epsilon \varsigma$. But the present procedure is differentiated from the following $\pi \rho \circ \sigma \alpha \nu \iota \epsilon \nu \tau \epsilon \varsigma$, which stands for the appropriate adjustment of other strings. The notion of $\pi \alpha \rho \alpha$ is explained most easily from the visual representation in the musical diagrams, where *paranētē diezeugménōn* and *nētē synēmménōn* lie side by side. According to the present hypothesis, $\eta \delta \eta$ introduces not another down-tuning but a novel way of using the tonal material. It may seem an odd way to put it, but it is characteristic of Aristoxenus' habit to refer to alien views in the most unfavourable way possible.

¹⁴ For the meaning of this term in Aristoxenian scalar theory, cf. *GMW* 1: 246 n.246; Cleonid. 5, p. 189.2–8. The 231 cents of the septimal tone lie between the 'commensurable' sizes of 200 (a tone of equal temperament) and 250 (1¼ tones).

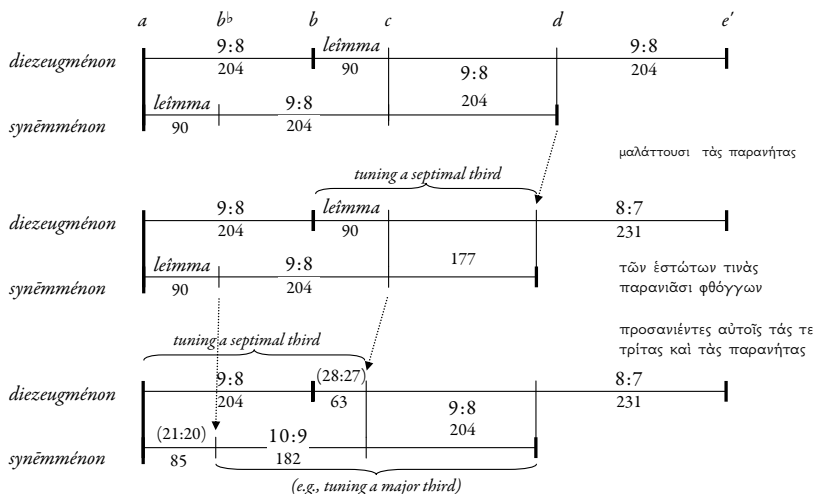
Diagram 34 A possible interpretation of ps.-Plut., *Mus.* 1145d

nant tuning, the resulting pitches are unsatisfactory not only for the internal shape of the *synēmménōn* tetrachord, but also within the basic scale: the Pythagorean *trítē* still forms no acceptable interval with any other note. By down-tuning, once more only a septimal solution is available: taking the *trítē* at a septimal third to *mésē* will restore a 9:8 tone as the central diatonic interval, and at the same time as the highest interval of the *synēmménōn* tetrachord. Finally *trítē synēmménōn* can be taken (for instance) a minor third below *nētē synēmménōn*, which needs only a minimal adjustment.

This is, it must be remembered, little more than an *exempli gratia* reconstruction, put forth merely to show that we should not draw from Aristoxenus' allusions all too far-reaching inferences about a general discrepancy between theory and practice. Whatever the musical reality behind his words, we need not be too much troubled. Moreover, the tuning style in question was perhaps fashionable only in Aristoxenus' times. Ptolemy, who lays such emphasis on the tonal structures of practice, does not know about a down-tuned *paranētē* (we shall however learn later that there is in fact evidence for a more serious breach of the theoretical standards, although only in the Roman era).

In the following sections, we are going to discuss the various ancient approaches to the question of fine tuning. We will not discuss them in strictly chronological order, but follow the individual threads.

'PHILOLAUS'

Towards the end of the fifth century BC, Philolaus composed the first written account of Pythagorean philosophy. From the few fragments that survived of his work, we have already quoted his description of *harmonía*, the octave as the harmonic framework of lyre tuning.¹⁵ The text continues by putting forth the ratios describing the disjunctive tone (9:8), the fourth (4:3), the fifth (3:2), and the octave (2:1). These intervals are 'superparticular' (also called 'epimoric'), which means that they exceed unity by an integer part of it, to be written in the (modern) form $1 + \frac{1}{n}$, or $(n+1)/n$. In ancient Greek, such ratios are expressed by a single word – a fact that contributed to the attention that subsequent theorists paid to this type of ratio.¹⁶

The fragment concludes by assessing the sizes of the larger intervals in terms of 9:8-tones and *diésies*: the octave consists of five intervals of 9:8 plus two *diésies*; the fifth of three 9:8-intervals plus one *diésis*, the fourth of two 9:8-intervals plus one *diésis*. Thus, Philolaus' *diésis* amounts to what was later called the *leímma*. The corresponding ratio of 256:243 is not mentioned in the fragment and needed not be calculated for its purposes: the 'components' of the consonances could be read directly from any diatonic octave scale. Even so, the deduction of the ratio of 9:8 from the difference between a fifth and a fourth, $3:2 \div 4:3$, testifies to the knowledge about how to deal with intervallic ratios properly; the calculation of the *leímma* involves higher numbers, but is otherwise analogous. In any case, the way of putting together tones and *leímmata* strongly suggests the form of diatonic that emerges from tuning a stringed instrument in alternating fifths and fourths, a structure that we still call a 'Pythagorean' scale. The calculation of its tetrachordal division is identical to that of the *leímma*. Not having at their disposal the modern way of dealing with fractions, the Greeks used to find the lowest integers that expressed the sought proportions. In the case of the 'Pythagorean' diatonic, these are 192 : 216 : 243 : 256, enclosing ratios of 9:8, 9:8, and 256:243, respectively.¹⁷

So far, Philolaus is in accord with later writers, and probably already presenting traditional lore. But there is another account that goes under his name and introduces a unique and surprising way of presenting various small intervals. It is transmitted by Boethius, within his adaptation of

¹⁵ Philol., fr. 6a (cf. p. 112 above).

¹⁶ Cf. *Sect. can.* 1, p. 149.14–16.

¹⁷ For the calculation, cf. e.g. *Exc. Nicom.* 2, p. 267.1–268.2.

Nicomachus' lost *Introduction to Harmonics*.¹⁸ Here, however, it is highly disputed whether the attribution to the famous Pythagorean Philolaus is genuine, or whether Nicomachus depended on a forged work, based on ideas that originated, perhaps, in the Early Academy.

The system as such has puzzled modern scholars especially because of its mathematical shortcomings. It jumbles the two approaches, which are often thought to have stood in irreconcilable opposition:¹⁹ the treatment of intervals as ratios to be concatenated by multiplication, a comparatively new achievement, and the old manner of simply adding them together, as suggested by the human ear and codified linguistically in expressions such as ditone, double octave, semitone, etc. The creator of the purportedly Philolaic system, instead of carrying through the multiplicative method (perhaps because it would have led to large numbers without numerological meaning), fell back into addition when it came to non-diatonic intervals.

To do him justice, however, we should keep in mind that the sharp antagonism between both views was probably not yet formulated by his times; certainly not if the source is really Philolaus. Even today, we are accustomed to using both approaches side by side, and, when necessary, transforming one into the other by means of logarithmic calculations. Logarithms were not at the ancient Greeks' disposal, but even so they were aware that similar and dissimilar intervals can somehow be 'added', and should therefore be describable by addition. Moreover, it must not be overlooked that similar inadequate mathematics were applied to intervallic computations throughout antiquity where the 'true' values were incomputable.²⁰

Unlike multiplication, however, the additive approach requires the establishment of some kind of unit, once the mere manner of speech is transformed into figures. Today we use the 'cent', which is defined as the hundredth part of the equally tempered semitone, and therefore conveniently small to express all audibly distinctive intervals in integers.

Philolaus (or whoever it was) derived his figures, and ultimately a 'measure', from the numbers that established the diatonic division of the tetra-chord. The 'distance' between 243 and 216, two numbers comprising the ratio of a tone, is 27; accordingly he defined 27 as representing the whole

¹⁸ Boeth., *Inst. mus.* 3,5, p.276.15–277.18 = Philol. A 26 DK; Boeth., *Inst. mus.* 3,8, p.278.11–16 = Philol., fr. 6b; cf. also Plut., *Anim. procr.* 1018e–1019a; 1021e–1022a.

¹⁹ E.g., Busch 1998.

²⁰ Boethius' "*commate, quod in .VIII.CLIII. primis unitatibus invenitur aequari*" (*Inst. mus.* 3,7, p.278.8–9; cf. 3,4, p.275.6–276.13) is based on precisely the same principle as the 'Philolaic' *diesis* of 13. Cf. also the deductions in Boeth., *Inst. mus.* 3,14–16, p.293–300; cf. below, n. 22.

tone. Similarly, the *leímma* (again called '*diesis*') is found between 256 and 243, whence it is associated with a value of 13. Number mysticism played an important role here,²¹ and we do not know whether some argument was given, why $216 - 192 = 24$ did not have an equal right of being accepted as the 'number of the tone'. Yet even if there are apparent methodical shortcomings as regards the foundation of the figures, we must acknowledge that the results were still fairly accurate, in a sense. As a measure *per se*, any number would have done, and Philolaus' 27 is no worse than the modern 204 (cents). The relation to other figures, above all that for the *diesis*, might however prove problematic. But the actual relation between the sizes of tone and *diesis* equals 27:13 in reasonable approximation. Expressed in cents, the true relation amounts to $204:90 = 2.27$, while $27:13 = 2.08$ (starting from a whole tone of 27, the 'correct' integer value for the *diesis* would have been 12 instead of 13). Thus we find that the relations between tone and *diesis*, at least, are expressed in a way that was not disproved by any possible evidence except exact calculation.

From the figures thus established, the sizes of another two intervals are calculated:

- The difference between tone and *diesis* is $27 - 13 = 14$. This is called *apotomé*, 'segment'.
- The difference between two *diéseis* and a tone, and thus between *diesis* and *apotomé*, is $27 - 2 \times 13 = 14 - 13 = 1$. This is expressly recognised as the unit²² – a conception of considerable significance in Pythagorean thinking. It is called *kómma*, 'chip'.

The differentiation between *diesis* and *apotomé* deserves our attention, since it expressly encodes the fact that the *leímma* is smaller than half a tone. Was this correct insight gained by a wrong method, namely from the curiously derived figures 27 and 13? Or were the latter admitted out of an awareness of the true relation? The latter assumption would require that some more extensive calculation of the adequate multiplicative kind was carried out previously.²³

²¹ Boethius mentions that $13 = 1 + 3 + 3^2$, that $27 = 3^3$, and that $27:24$ is again a tone (*Inst. mus.* 3.5, p. 276.15–277.18); one is tempted to add that $27:24 = 3^3:(3 \times 2^3)$.

²² Boeth., *Inst. mus.* 3.5, p. 277.4–18: ... *unitatem loco commatis censet esse ponendam*. The implicit treatment of the *kómma* as the 27th part of a tone is seriously wrong: in fact, it is larger than the ninth part of a tone. The necessary calculations for properly assessing the size of the *kómma* against the tone, however, involve inaccessible ratios such as $3^{108}:2^{171}$. An approximate solution by inadequate subtraction of boundaries is given in Boeth., *Inst. mus.* 3.16, p. 297.10–298.6; it still requires figures up to 531 441.

²³ In order to prove that $256^2:243^2 < 9:8$, one has to show that $256^2 - 243^2 = 6487$ is smaller than $243^2:8 = 7381\frac{1}{8}$; in integers: 51 896 and 59 049. The proof of *Sect. can.* 15, p. 161.4–16, depends on

After introducing the three basic microtonal intervals, Boethius points to the fact that the tone consequently consists of two ‘smaller semitones’ (in his own argument he uses familiar terminology) and a *kómma*. Then he resumes the discussion of ‘Philolaus’ by quoting the latter’s definitions of *díesis*, *kómma* and two further intervals. Here the faulty numeric values play no further role:

- The *díesis* is the excess of 4:3 over two tones.
- The *kómma* is the excess of 9:8 over two *diéseis*.
- Half a *kómma* is a *skhísma*, ‘cleft’.
- Half a *díesis* is a *diáskhísma*, ‘cleaving through’.

It will be noticed that the first two statements refer to the proper way of calculating the respective intervals. The latter two are mere definitions. Within a strict ‘Pythagorean’ paradigm, they are open to the criticism that the bisection cannot actually be carried out; but this would provide no problem as long as the two micro-intervals are only used as abstract units within logical deductions.²⁴ Another point of interest is that the *apotomé* is missing from the list.

Boethius does not expound on the function of these various micro-intervals in the context of Philolaus’ work. It has been argued that they obtain any meaning only as parts of tetrachord divisions; that they are in fact the first, if flawed, comprehensive attempt to translate the structures of musical practice into numbers (cf. Diagram 35).²⁵ For the *apotomé* this is quite rea-

proposition 9, p. 157.5–158.7, which uses numbers up to $9^6 = 531\,441$. Alternatively, a very exact experiment on a stringed instrument would yield this result – but only in theory. Such an experiment would demand setting up twelve alternating fifths and fourths each with an error of less than 2 cents; it would be the exact equivalent of the experiment by which Aristoxenus proved the opposite (namely that the perception of concords does not contradict the assumption that the ‘*leímma*’ is in fact a semitone; cf. below, p. 153 n. 43): the necessary precision was (of course) not available.

²⁴ Note also that equal bisection was expressly rejected for superparticular intervals only, while neither *díesis* nor *kómma* are of that kind (actually commensurable bisection is only possible for ratios that can be reduced to ratios of squares).

²⁵ For the reconstruction and the defence of authenticity, cf. Burkert 1962: 372–7 (Burkert 1972: 394–9); *AGM*: 167–8; 235–6. On the other hand, Huffman (1993: 364–74) seeks the origins of the system in the Early Academy, above all because of its “infatuation with the powers of 3”, and because of the apparent inconsistency in treating intervals: “since that fragment [6a] clearly shows knowledge that the concords correspond to ratios and that subtraction of musical intervals from one another means division of ratios...” (‘division of ratios’, however, is not the Greek way to put it). Yet Huffman admits that even Ptolemy mixes (not to say confuses) both approaches, and it is hardly conceivable anyway that the ‘correct’ way of dealing with intervals was not known in the Academy. Furthermore, a date before Archytas’ three-genera system of ratios would seem preferable for a less sophisticated account. Finally, twenty-seven was doubtless already recognised as the cube of three before Plato (the absence of evidence for pre-Platonic Pythagorean numerology cannot be taken as evidence of absence), and Huffman does not propose any possible significance of numbers such as 13 and 14

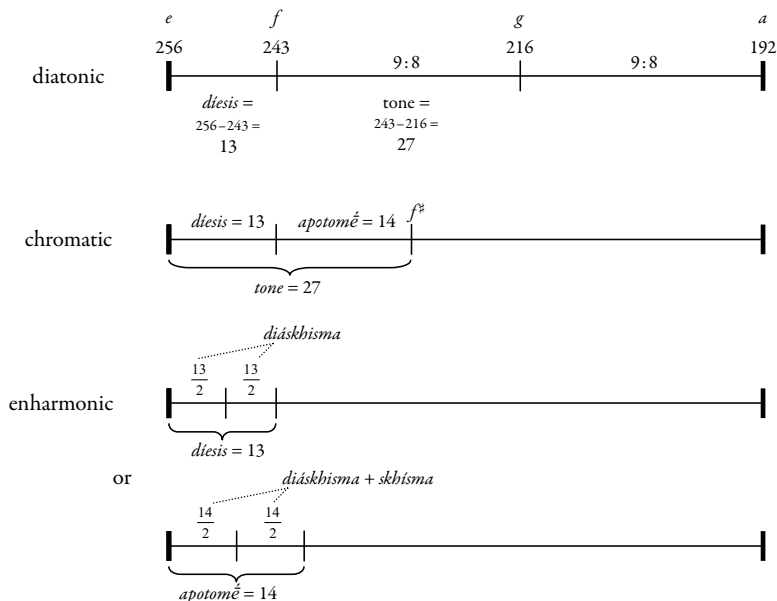

Diagram 35 Philolaus' tetrachord tunings according to Burkert / West

sonable, since it is nothing other than the higher interval of the chromatic *pyknón*, as it follows from a 'Pythagorean' lyre tuning procedure. Already at the time of Philolaus it must have been common knowledge that the typical highest note of a chromatic *pyknón*, the *khrōmatikḗ*, was tuned as the difference between a fifth and a fourth,²⁶ while the lower was necessarily identical with its diatonic counterpart. As we will see below, this became a standard assumption.

But what about the minor intervals? The *kómma* could imaginably have been conceived for the sake of theory, to expressly state an (imaginary) unit of intervallic measurement. Not so *skhísma* and *diáskhisma*, which both require the bisection of that unit. This appears as a major aesthetic flaw of the system, for which there must have been some strong motivation. But neither *skhísma* nor *diáskhisma* is of any numerological interest or contributes anything to the understanding of the musical structures discussed

for the Early Academy (cf. also Barker 2007: 271 n. 17; 282 with n. 39 pointing to cultic 3×9 at Soph., *Oedip. Col.* 483-4).

²⁶ Note also that Philolaus, fr. 6a, states this for the disjunctive tone, which is identical with the '*khrōmatikḗ synēmménōn*'.

so far.²⁷ In analogy to the chromatic *apotomé*, they were consequently understood in the context of the enharmonic. Here two *diáskhismata* can form a *pyknón* of the size of a *diésis*, in accordance with the view that the two enharmonic ‘quartertones’ added up to a ‘semitone’, so that the diatonic and chromatic *parypátai* coincided with the enharmonic *likhanós*. This still leaves the *skhísma* unaccounted for. Thus it was proposed that Philolaus suggested an alternative enharmonic division, in which the *pyknón* was of the size of the *apotomé*, with two constituent intervals each of the size *diáskhisma* + *skhísma*.

This supposed second enharmonic variant stands out in another respect. Its highest interval is defined by the difference between a fourth (498 cents) and the *apotomé* (114 cents), and therefore amounts to 384 cents. For all practical purposes, it is therefore identical to a pure major third, which is ideally represented by a ratio of 5:4, or 386 cents.²⁸ Such a replacement of the dissonant ‘Pythagorean’ ditone by a pure major third gives birth to a significantly higher degree of resonance within the resulting scale: in addition to the major third above, the altered note forms a pure minor third with a disjunctive tone below the *pyknón*, such as *mésē* or *hyperypátē*. The hypothetical reconstruction of Philolaus’ system would certainly not suffice as a basis for such an assumption. But the existence of exactly such a resonant enharmonic was deduced from entirely independent sources:²⁹ some decades after Philolaus, Archytas expressly assigned the ratio of 5:4 to the interval in question, and again some decades later Aristoxenus complained about the prevailing custom of raising the enharmonic *likhanós* slightly to produce a more pleasant, ‘sweeter’, effect.³⁰ In such a context, the possibility of a quasi-pure third in the system attributed to Philolaus is seductive.

Nevertheless, it seems forced to attribute the refinement of two enharmonic divisions to Philolaus’ era. Moreover, the enharmonic theory presents the serious difficulty that nothing in the sources recommends such an ascription. In the case of the chromatic, a persistent tradition of the *apotomé* as the upper chromatic semitone justifies the assumption that it was

²⁷ Tannery (1915: 107) assumes that the *diáskhisma* served for an equal bisection of the chromatic (*leímma* + *diáskhisma* = tone / 2). But the term *apotomé* remains associated with the upper chromatic semitone (cf. below on Gaud. 16, p. 344.17–24; Theon, *Util. math.* 91–2; *Anecd. Stud.*, 5–7; cf. also Barbera 1977: 306; *AGM*: 168 n. 32; Mathiesen 1999: 504–5).

²⁸ *AGM*: 168; Hagel 2006a: 285–9, with arguments how the relations could be verified in lyre tuning.

²⁹ Winnington-Ingram 1932: 200; cf. *GMW* II: 50 (but see also 298 n. 98); Barker 2000: 122; Franklin 2005: 26–8. Vogel 1963a and 1963b builds much too far reaching conclusions on the difference between the ‘Pythagorean’ and the ‘pure third’ enharmonic (cf. Richter 2000: 105–8).

³⁰ Aristox., *Harm.* 1.23, p. 29.14–30.8; cf. 1.28, p. 36.9–11 (the enharmonic ‘ditone’ might be smaller than eight ‘quartertones’); 2.48, p. 61.5–9.

originally invented in precisely this context. But for the supposed enharmonic microtones, no evidence of this kind exists.

On the contrary, the absence of a term for the half-*apotomé* strongly tells against the presumed resonant form of the enharmonic. Why would the creator of this microtonal system rather invent a name for the half-*kómma*, and talk about the *kómma* at all, instead of splitting the *apotomé* right away, if this was his intention? Bisecting the latter’s numeric value of 14 would have posed less of a conceptual problem than that of the *diesis* with its 13 units. On the other hand, once the splitting of the *apotomé* is dismissed as a possible motive, the creation of *kómma* and *skbisma* besides the *diáskbisma* shows that the author must have been interested in something else than the enharmonic division of the *diesis*, too. Admittedly, an enharmonic with a *pyknón* the size of a *diesis* might have been part of the original system; but in the light of the preceding considerations, this is mere speculation of no explanatory value.

Thus we are well advised to take a closer look at the role of the intervals in Boethius’ text. There they are put to one exclusive use: the definition of the true semitone by means of those intervals which are established by consonance, i.e. by tuning in fifths and fourths. Since the whole tone consists of two *diéseis* and a *kómma*, the semitone is defined as two half-*diéseis* and a half-*kómma*. From this calculation it becomes immediately clear, firstly why *diesis* and *kómma* were singled out for bisection (and not the *apotomé*), and secondly why the products were assigned so similar names, although these refer to entities of entirely different size: the apparent cause is that they serve an analogous purpose.

In consequence, the four chapters in which Boethius focuses on the supposedly Philolaic microtones and their mutual relationships reveal a straight line of argument. Presupposed is merely the knowledge of the ‘Pythagorean’ diatonic tetrachord and its expression in smallest integers as 192 : 216 : 243 : 256. From these ratios, simple numbers for the intervallic steps of any ‘Pythagorean’ lyre tuning are derived, diatonic or chromatic, with primary interest in their numerological significance. At the same time the *kómma* is established as a kind of musical unit. After that, considerable emphasis is put on the specific relation that a tone is composed from two smaller semitones and a comma,³¹ which sets the scene for the bisection of this structure. Here the focus narrows down on *diesis* and *kómma*. In a fur-

³¹ For this fact Boethius provides two arguments. The first, which would have sufficed at this point, is straightforward; it may reflect the original source. The second refers to the octave and thus to preceding numeric demonstrations; it was probably inserted by Nicomachus.

ther step, the proper mathematical definition of these two intervals is given. Their equal bisection is postulated subsequently. Finally, in an extensive argument of considerable redundancy, the true semitone is established as comprising two *diaskhismata* and a *skhisma*.

On balance, this seems to be the purpose of the unparalleled microtonal system: to provide a means of dealing with the notion of a 'semitone' in terms of the 'Pythagorean' tuning. One will certainly notice that in a strict mathematical sense, nothing has been achieved at all. Actually the impossibility of dividing a 9:8 tone into halves has been replaced by the practical, but not discussed, impossibility of dividing the *diesis* and the *kómma*. But such a criticism probably misunderstands the objective. The original author may have intended nothing more than to clarify the inherent relations, ultimately tracking down the difference between the two approaches to half the difference between a minor and a major semitone. Admittedly, this is not an ingenious insight, and it is presented in a somewhat cumbersome manner.³²

The idea of equal interval bisection in a Pythagorean context as such was certainly not taboo when Philolaus wrote, and probably remained in principle unproblematic for some time. It was apparently not before Archytas at the beginning of the fourth century that anybody denied generally the possibility of dividing superparticular intervals into equal parts.³³ Respective considerations fall within the scope of the theory of means, which Archytas advanced greatly. This step introduced a quasi-mathematical argument into a discussion that must previously have been much closer to practice. Earlier one needed not reject the idea that the tone could be divided into equal halves; and it may have taken some time until Archytas' contention was universally accepted. On the other hand, by calculations of ratios one merely found out that, as regards the lyre, the tone was not divided into true semitones, because the subtraction of two 9:8 tones from the fourth in accordance with common tuning practice left a remainder that was demonstrably smaller than the half of a tone.³⁴

Where does the supposedly Philolaic system fit in this evolution of musical thought? Possibly it was a reaction both to the 'harmonicist' free admit-

³² The question of accuracy of the presentation in Boethius set aside, it must be pointed out that the definition of the *diaskhisma* is superfluous, as regards our sources: the calculation $(2 \times (\textit{diaskhisma} + \textit{kómma}) / 2 = 2 \times (\textit{diaskhisma} / 2) + 2 \times (\textit{kómma} / 2)$ is probably not the most elegant way to put it. Here the advocates of an enharmonic might argue their case.

³³ Cf. Boeth., *Inst. mus.* 3,11, p. 285–6.

³⁴ It may be of importance that the detection of the unequal division of the chromatic tone need not have had any bearing upon the question of the enharmonic.

tance of semitones and to Archytas' denunciation of superparticular bisection – a desperate and not very reasonable attempt to escape the latter's verdict by shifting the bisection to the realm of non-superparticulars.³⁵ In this case we would postulate an origin around the middle of the fourth century.

On the other hand, we cannot exclude the possibility that the ascription to Philolaus is true, after all. The concentration on the intervals of lyre tuning matches the reference to the lyre strings in his generally accepted fragment. The calculation of the 'Pythagorean' diatonic predates Archytas.³⁶ The interest in the 'true' semitone might have been raised by existing musical discourse, with which the discovery that the *leimma* falls short of the semitone needed reconciliation.³⁷ In this case, the naïve nature of the answer would become all the more understandable.

Be that as it may, the 'Philolaic' system seems to testify to the actual employment of 'Pythagorean' diatonic and chromatic lyre tuning at some time between the later fifth and the mid-fourth centuries BC: so much seems warranted by the identification of the diatonic whole tones with the disjunctive tone, which must be rooted in the fact that both were (or could be) tuned by fifths and fourths.

ARISTOXENUS AND THE AULETIC VIEWPOINT

Generally speaking, Aristoxenus' treatment of tetrachord divisions stands in a tradition that may reach back well into the fifth century. Its supporters

³⁵ When the impossibility of halving the tone had become an anti-Aristoxenian war-cry, the simple numbers of the 'Philolaic' system were transformed into an especially stupid argument: in Theon, *Util. math.* 70.17–19, the fact that 27 is an odd number, divisible not into halves but into 13 and 14, is cited as a 'proof' that the tone cannot be divided into equal parts. Thus even the intellectually least gifted handbook-consumer of the Roman era could indulge in a Pythagorean triumph over Aristoxenus.

³⁶ Cf. below, p. 178 with n. 117. Note that the sequence tone–tone–semitone need not necessarily refer to a 'standard tetrachord' in the later sense; thus the impossibility of producing a Dorian Pythagorean tuning on the heptachord presumed in Philolaus, fr. 6a (cf. above, p. 115) posits no insuperable obstacle.

³⁷ Cf. Barker 2007: 272–86. My interpretation, although conceived independently, is close to Barker's, who however argues that Philolaus' goal was not the bisection of the tone as such, but of the 'disjunctive' tone in order to define the central point of the octave. I find this idea less likely because it posits an artificial duplicate notion of centrality, which was traditionally associated with *mésē* as the central string.

are referred to as *'harmonikoi'*.³⁸ Their view is most closely related to the language of musical practice, and ultimately to the function of the human auditory system: intervals are concatenated by addition. Little is however known about their theories: Aristoxenus' systematic approach went a long way beyond anything attempted so far and consequently obliterated the work of his precursors.

Some of these had tried to find an interval by which all musical structures could be measured, and accepted the *diesis* as satisfying this condition – which had become the accepted view in Aristotle's time.³⁹ By the term *'diesis'*, however, they designated the quartertone interval, not the *leimma* as did Philolaus. Indeed, a quartertone grid permits the complete description of all melodies and modulations within the standard definitions of the genera, which employ tones, semitones and quartertones only. Yet if Aristoxenus is to be trusted at all, the presupposition that all intervals must be commensurable, and moreover by an audible unit, was inadequate from the very beginning.

Aristoxenus liberates himself of any limitation of such a kind, and allows for an infinity of musically acceptable intervals. Of all theorists, he (and his followers) are least restricted by a priori assumptions, and hence most likely to convey unbiased information about ancient music as it was.

Unfortunately from Aristoxenus' work, which dealt with practical topics as well, only very basic and abstract chapters have come down to us. Although these include thorough discussions of possible (and impossible) tetrachord divisions, only occasional mention of specific instruments is made. What we get is the tonality of ancient Greek music, in the form of a generalisation that is deduced from different instruments and styles and has consequently lost almost all traces of its various and diverse practical implementations. In the case of the tetrachord divisions this means that the versatile auletic *pyknón* and the rigid tunings of the lyre are not treated differently, and that one cannot know beforehand which intervals apply to which instrument.

³⁸ For the (later) commonplace antagonism between 'Pythagoreans' and *'harmonikoi'*, cf. e.g. Plut., *Anim. procr.* 1020ef. For a concise introduction to the philosophical and mathematical differences between the two viewpoints, cf. e.g. Barker 2003: 73–6.

³⁹ Aristotle cites the *diesis* as the measure in music among measures of daily use such as the foot for distances or the mina for weights: *An. post.* 84b; *Met.* 1016b; 1053ab (with awareness of the problems introduced by a mathematical approach of the 'Pythagorean' kind; cf. Barker 2007: 349–53); 1087b (cf. Barker 1978a: 11; 2007: 349–53). The theorists ridiculed in Plato, *Rep.* 531a, pursue a related endeavour (cf. *GMW* II: 55–6 n. 3; Barker 2007: 23–5; 34–7; 424–7), but search for the smallest perceptible interval as the musical measure, which is certainly smaller than a quartertone (namely the comma – less than an eighth of a tone – according to the tradition behind Boeth., *Inst. mus.* 3.10, p. 285.1–2: "est enim comma, quod ultimum comprehendere possit auditus"; 3.13, p. 293.7–9.).

enharmonic:	$\frac{1}{4} + \frac{1}{4} + 2$	
soft chromatic:	$\frac{1}{3} + \frac{1}{3} + 1\frac{5}{6}$	
hemiotic chromatic:	$\frac{3}{8} + \frac{3}{8} + 1\frac{3}{4}$	
tonic chromatic:	$\frac{1}{2} + \frac{1}{2} + 1\frac{1}{2}$	
soft diatonic:	$\frac{1}{2} + \frac{3}{4} + 1\frac{1}{4}$	
tense diatonic:	$\frac{1}{2} + 1 + 1$	

Diagram 36 Aristoxenus' tetrachord divisions

Remarkably, in spite of his exhaustive treatment of tetrachord divisions, in his discussion of the essentials of larger musical structures Aristoxenus reverts to the simple terminology of tones, semitones and quartertones.⁴⁰ His awareness of the problem transpires from the indication how different divisions would be handled.⁴¹ Nevertheless it is clear that Aristoxenus, too, acknowledged the priority of the commensurable standard divisions.

Not at least for that reason, Aristoxenus seems fully compatible with many aspects of the 'Pythagorean' account, as regards musical practice. It was agreed that the tone is the difference between the fifth and the fourth, and that it is the principal measure of scales; that the regular chromatic *pyknón* comprises a tone; that the chromatic *pyknón* is divided by what remains from a fourth after two tones have been subtracted; and that this interval also equates to the size of an enharmonic *pyknón* – although we do not know when this was first formulated in 'Pythagorean' context.

But Aristoxenus avoided the complications that arise from the computation of intervals as ratios by simply rejecting such an approach as unscientific.⁴² Instead, he defined the octave as consisting of six equal tones, and the fourth of two and a half, and offered an experiment to prove that this is not at odds with the auditory perception of concords.⁴³ An 'equally tem-

⁴⁰ Aristox., *Harm.* 3.63–72, p. 79–90. For quartertones the term *diesis* is employed, which Aristoxenus uses also for slightly larger intervals; the size of the quartertone (specifically called "the smallest enharmonic *diesis*") appears however implied by the regular reference to the ditone above the *pyknón*.

⁴¹ Aristox., *Harm.* 3.68, p. 85.1–8.

⁴² Aristox., *Harm.* 2.32, p. 41.19–42.3. His predecessors must have used the same principles, although in all likelihood methodologically less well founded.

⁴³ For the justification of this experiment, cf. Hagel 2000: 17–21 (where I overlooked the fact, rightly pointed out by Barker 2007: 190, that "the method of construction he offers ... is not represented as a proof, but as a procedure through which we can form our own judgement"). It is discussed at some length by Barker 2000: 100–5; the anti-Aristoxenian conclusions reached there, however, miss Aristoxenus' central point: that the experiment can indeed be set up with equally tempered fourths and fifths without anybody noticing the difference (and that in consequence nothing forces us to assume that the fourth corresponds exactly to a ratio of 4:3; Aristoxenus, by the way, does not make it explicit that his argument is directed against the ratio-based approach). Although the 'error' would

pered' semitone being thus established, the difference between the Pythagorean *diesis* = *leimma* and the *apotomé* vanished. Nevertheless it is obvious that the lyre tuning behind the account is the same: everything relies on the tone, which is taken 'by consonance' as ever.

Aristoxenus lays some emphasis on the fact that there is in principle an infinite number of musically acceptable divisions, whose boundaries he gives in the form of general rules. Still he points out, besides the standard divisions, one diatonic and two chromatic variants as "outstanding and familiar", because put together from "familiar" intervals.⁴⁴ To these shades, which are represented in Diagram 36, he assigns names part of which are apparently taken from common musical terminology.

From Aristoxenus' principles it follows that only the quartertone version of the enharmonic can appear under the 'familiar' divisions. Still, on another occasion he admits that in his time most people found an enharmonic with slightly raised *likhanós* much more 'familiar';⁴⁵ and he emphasises that such an intonation is also perfectly enharmonic in character.⁴⁶ This is the form whose 'sweeter' effect has been attributed to the replacement of the ditone with a pure major third.⁴⁷ If this interpretation is as correct as it is tempting, the two variants of the *diesis* differ by merely the seventeenth part of a tone. The relations are visualised in Diagram 37.

The case of the 'sweetened' enharmonic illustrates the major shortcoming of Aristoxenus' method: although his tone fractions can be regarded as reasonable approximations of intervals actually in use, they give no clue to minor resonant intervals as such. If pure thirds played a role in fourth-century Greek music, Aristoxenus' quantifications must conceal them rather than point them out. For tonal systems based on minor resonance, his descriptive paradigm is ill-chosen from the very start. The discrepancy between the two enharmonic versions, one favoured by Aristoxenus' units of

accumulate to perceptible 23,5 cents (twelve times the difference between pure and equally tempered fourth = $3^{12} : 2^{19}$), if there were a way of setting up mathematically exact pitches, it could in practice be divided over the twelve steps of the experimental construction: only the consonance of the single fifths and fourths is to be judged, and there the difference of merely two cents is not perceptible without resort to electronically generated sounds. Aristoxenus' experiment is thus entirely equivalent to the modern 'equal temperament', although he would hardly admit the notion, intrinsic to the modern term, that there is something to be tempered.

⁴⁴ Aristox., *Harm.* 2.49, p. 62.17: ἐξαιρέτοι τε καὶ γνώριμοι. The relevant passages are discussed at length in Bélis 1982. Aristoxenus' apparent exactness is rightly questioned within his own conceptual framework by Barker 1978b; note, however, that the quartertone, above all, requires not the exact perception of its size relative to the tone, but merely that of the (approximate) equality of two intervals that add up to the semitone.

⁴⁵ Aristox., *Harm.* 1.23, p. 30.1–5.

⁴⁶ Aristox., *Harm.* 2.49, p. 61.5–11.

⁴⁷ Cf. above, p. 148 n. 29.

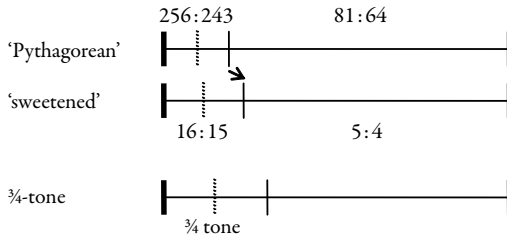
Diagram 37 'Ditonic', 'sweetened' and $\frac{3}{4}$ -tone enharmonic

measurement, the other by the musicians, probably allows a glance into this basic inconsistency.

More seriously compromising is perhaps another passage, in which Aristoxenus seems to concede a three-quarter tone as the undivided precursor of an enharmonic *pyknón* in the archaic *spondeíon* tune,⁴⁸ although such a division is identical with his own 'hemiotic' chromatic. This reference to archaic aulos music as the earliest known form of enharmonic is particularly interesting as it is not Aristoxenus' own invention or inference, but goes back to unnamed '*mousikoi*', who naturally cared little about Aristoxenus' classification of genera. Likely these '*mousikoi*' are the same group to whom Aristoxenus attributes a general understanding of the genera, although "the very point where the enharmonic becomes some sort of chromatic was never focussed upon by any of them";⁴⁹ they might also be associated with the aulos-based 'second' pre-Aristoxenian scheme of *tónoi*:⁵⁰ all three contexts combine a general orientation towards the aulos with the assumption of a *pyknón* that deviates from Aristoxenus' definition and is twice associated with an interval of three quarters of a tone.

All in all, it transpires that in over-exaggerating the enharmonic of the smallest possible intervals Aristoxenus rides his personal hobby-horse, in dissent with great parts of contemporary and probably also earlier musical practice.⁵¹ On the other hand, we must as well bear in mind that the tradi-

⁴⁸ Aristox. *ap. ps.-Plut., Mus.* 1134f–1135b; 1137bc; for a detailed discussion, see below, pp. 397ff. The *pyknón* in question is not that of the *mésion* tetrachord, which might seem to comprise merely a semitone, but that above *paramésē*: the three-quarter tone interval there (*spondeiasmós*) is perceived as *pyknón*-like, as transpires from 1135b: ἀσύνθετον γὰρ βούλεται εἶναι καὶ τὸ ἐν ταῖς μέσαις ἡμιτόνιον, "he intends that the semitone in the *mésai* is also incomposite", implies that the other respective interval was, a fortiori, an undivided *pyknón*.

⁴⁹ Aristox., *Harm.* 2.35, p. 44.15–22; cf. above, p. 11.

⁵⁰ Aristox., *Harm.* 2.37–8, p. 47.7–13; cf. below, pp. 379 ff.

⁵¹ Cf. also *Exc. Neap.* 17, p. 416.2–9, a paragraph of clearly Aristoxenian language and content, where the 'enharmonic' and the 'smallest chromatic' *diesis* are much more neutrally referred to as 'fourth-

tion of a standard quartertone enharmonic also stood behind the extended notation system, so that Aristoxenus was perhaps a bit narrow-minded on that point, but certainly did not replace some accepted model with his own inventions.

As stated above, the surviving parts of Aristoxenus' work are on such a high level of abstraction that they contain virtually no information about the applicability of the shades to different instruments. For the present, we can but append some preliminary considerations of a general nature. The standard aulos design, on which the mentioned pre-Aristoxenian *tónoi* system is based, must have been current not long before he wrote. There the finger holes were seemingly bored so as to play, without further modification by half-stopping and similar techniques, sequences of $\frac{3}{4}$ tone – $\frac{3}{4}$ tone – tone.⁵² Such a division of the fourth is never described by any ancient author. So it seems that, at least from the fourth century on, either auloi of this primitive make had fallen outside the scope of music-theoretical discourse, or that players were expected to produce 'regular' scales from this raw material by fingering and perhaps embouchure techniques.⁵³ Such techniques would always have been required when auloi of this kind played together with lyres. In any case it is legitimate to ask how such auloi would relate to the Aristoxenian tetrachord shades. Apart from possible considerations of easy fingering, their finger hole distribution appears best adapted for a combination of some or other sort of diatonic with that kind of *pyknón* that Aristoxenus labels the 'hemiotic chromatic', while on another occasion associating it with early enharmonic music. Diagram 38 displays how all the shades would be produced on such an aulos by lowering the notes of one or the other finger hole, where necessary.

It emerges that the lower finger hole within the tetrachord suffices for the production of the three shades within the range that we find associated with the enharmonic in one or the other way. Most probably, these shades were characteristic primarily for auletic music, in which the Aristoxenian difference between enharmonic and chromatic was blurred, and seems ultimately to have depended on an arbitrary decision. In this context of a versatile auletic *pyknón* the origins of the sign triplets of the notation have to be sought.

part *diesis*' and 'third-part *diesis*', which are opposed, as two variants of the general idea '*diesis*', to the tone and the semitone. For a detailed discussion of the issue, see below, pp. 413ff.

⁵² Cf. *AGM*: 97; Hagel 2000: 178–80. For an explanation of such an instrument design, cf. pp. 393ff.

⁵³ If the supposed derivation of the enharmonic from a heptatonic scale (cf. n. 48) is taken at face value, the underlying archaic 'diatonic' tetrachord would have had the form of $\frac{3}{4}$ – $\frac{3}{4}$ – 1 tones; but it might be doubted that the authors of this model were aware of the implication.

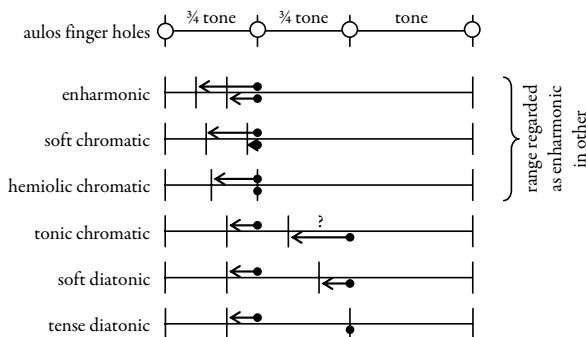
Diagram 38 Producing Aristoxenus' shades on a $\frac{3}{4}$ - $\frac{3}{4}$ -1 tones aulos

On the other hand, there is the tonic chromatic, whose *pyknón* exceeds the size of three quarters of a tone, and which is therefore the only one that cannot be played on a single finger hole of such a 'standard design'. At the same time, this is the typical chromatic of the lyre. It establishes the equivalence of the chromatic *likhanós* with a modulating disjunctive note, as necessary on stringed instruments with their restricted number of pitches. On the old aulos, the respective note would have been available only by lowering the pitch of the 'diatonic' finger hole by a semitone. Notably, this would have to be done for modulation, as well. Thus we can by no means infer that Aristoxenus' tonic chromatic was characteristic of lyre music exclusively. On the contrary, it appears likely that the flowering of modulation around 400 BC established the tonic chromatic in auletic music also. But at this time, the newly invented mechanism for the aulos probably liberated players from the considerable task of accessing these important notes by means of half-covering a hole: notes that were now no longer merely ill-defined points within the tetrachord, but part of the harmonic framework (for instance, early types of mechanism might have allowed the pitch of the lower hole within the tetrachord to be raised by a quartertone). At present, this is speculation, of course, primarily for the purpose of showing that a naïve distinction between small auletic *pykná* and one large citharistic chromatic *pyknón* is probably misleading, at least when applied to virtuoso music of the late fifth century. Also, the discussed structures are already inherent in the musical figure of chromatic *synēmménon* modulation, which not unlikely belonged to the basic means of composition in the classical period. Instead of presuming a straightforward organological dichotomy, we are probably well advised to consider a distinction of musical styles within the broad field of aulos music: on the one side there were traditional tunes of

restricted tonality, which could be played on inexpensive instruments that resembled those of earlier times and probably maintained the comparatively small auletic *pykná*. On the other, the professional music of the dithyramb, the games and the theatre was played on sophisticated pipes of polymodal design, which paid tribute to the latest innovations and may have favoured the tonic chromatic both because of its suitability for modulation and because of an increasing coalescence of aulos and lyre music into a single tonal paradigm.

In any case, an original association of the term ‘chromatic’ merely with its tonic variant as emerging in modulating structures can explain the ‘deficiency’ of which Aristoxenus accuses the *mousikoi*. If these treated all auletic *pykná* as enharmonic and confined the chromatic to an entirely different background, it is no wonder that they never defined any boundary between the two: the conception of the three genera as occupying adjacent regions within a continuum of shades is perhaps not pre-Aristoxenian at all.⁵⁴

‘PYTHAGOREAN’ ORTHODOXY

Shortly after the time of Philolaus, a quest for mathematically more satisfying tetrachord divisions started. Nevertheless the old system with its *leitmata* and *apotomai*, which we found attributed to Philolaus, was by no means forgotten. Its diatonic version became extremely prominent through Plato, whose *Timaeus* featured it as the inner structure of the ‘tetrachords’ in the division of the universal soul.⁵⁵ On the other hand, the ‘Pythagorean’ chromatic also enjoyed considerable attention, which cannot be attributed to Platonic tradition. Probably it was widely accepted as the obvious consequence of the basic tuning procedure, notwithstanding the large numbers required for an exact calculation of ratios. It is worthwhile to follow this strand as well, if only to make sufficiently clear how little it can contribute to our knowledge of the actual music-making in the times of the respective authors.

⁵⁴ A particularly striking argument for Aristoxenus inventing the genera comes from the term itself, which betrays its origin in the Peripatetic school; cf. Barker 2007: 405 with n. 71.

⁵⁵ Plato, *Ti.* 36ab.

Thrasyllus

A complete 'Pythagorean' division of the entire Unmodulating System is attested for Thrasyllus in the first century AD.⁵⁶ He describes the construction of all notes of the double octave by filling in the framework of fixed notes with 9:8 tones: two subsequent steps downwards from the highest note of each tetrachord create the diatonic genus, whose *parypátē* is shared by the chromatic, and constitutes the enharmonic *likhanós*, as well. On the other hand, one step upwards from the lowest note of each tetrachord supplies the chromatic *likhanós*, for which the term *khrōmatikḗ* is adopted throughout.⁵⁷ Thrasyllus correctly identifies 10368 as the smallest number that can be assigned to the highest note in order to represent the entire system by integer figures.

For enharmonic quartertones, no provision is made;⁵⁸ the wording suggests that for Thrasyllus the enharmonic genus was already established by removing the diatonic *likhanós*.⁵⁹ Is he merely content to reproduce the purported older enharmonic style with its undivided semitone, maybe because the quartertone enharmonic had long been out of use?⁶⁰ Or was the enharmonic reduced to a trichordal form, when the art of singing quartertones became obsolescent? After all, such a trichordal melody is attested for the late second century BC, in the opening of the First Delphic Paean, which evidently cites an archaic musical style.⁶¹ Alternatively, the trichordal style might have been the only form of 'enharmonic' ever adopted on the lyre – another possible example of instrument-specific diversity that be-

⁵⁶ Theon, *Util. math.* 91–3.

⁵⁷ The *khrōmatikḗ hypatón*, however, is missing, which is probably due to a lapse of the author or, less likely, an omission in the manuscript tradition.

⁵⁸ The arithmetic mean would give acceptable results for the Greater Perfect System; in the *synēmménon* tetrachord, however, it leads to an enharmonic *tritḗ* of 20209 ½, which would require the multiplication of all figures by two.

⁵⁹ Theon, *Util. math.* 92.27–93.2: τὸ δὲ ἑναρμόνιον ἐξαιρουμένων τῶν διατόνων καθ' ἕκαστον τετράχορδον διπλαζομένον γίνεται. "And the enharmonic is created by taking out the *diatónoi* that recur in each tetrachord." But compare the *Division of the Canon*, 17–18, p.162–3, where a 'Pythagorean' enharmonic is envisaged, whose *pyknón* comprises a *lémma*. Here a proof is offered that it cannot be divided into equal parts, although no specific construction is proposed instead.

⁶⁰ Cf. ps.-Plut., *Mus.* 1135a; 1137b; Winnington-Ingram 1928; West 1981; *AGM*: 163–4 (assuming a pentatonic precursor of all genera); Franklin 2002b (plausibly arguing with Aristoxenus for a diatonic origin); below pp. 397ff. and pp. 435ff.

⁶¹ Winnington-Ingram 1936: 24; 33. Note that Aristoxenus classifies such melodies not as enharmonic, but as 'common' (κοινά), since they use only the notes shared by all three genera (*Harm.* 2.44, p. 55.10–11; cf. Hagel 2000: 38 n. 61).

came obliterated in comprehensive Aristoxenian theory.⁶² In this case the first, Apollinian, part of the Paean would carry a citharistic flavour, in opposition to the second, increasingly Dionysian and predominantly auletic section.⁶³ Notably, however, a trichordal enharmonic has its place within a basically heptatonic and therefore tetrachordal lyre culture only as a deliberate restriction to a subset of (melodic) notes.⁶⁴ In any case, it is more than probable that in Thrasyllus' time at the latest no lyre was tuned to quarter-tones. But perhaps Thrasyllus merely reflects a tradition which compensated for the impossibility of tuning the enharmonic quartertones 'by means of consonance', and therefore of detecting their 'true' ratios, by excluding them from music theory and practice altogether.⁶⁵

Nicomachus, 'Timaeus Locrus' and Boethius

In a very similar way as Thrasyllus, Nicomachus takes it for granted that 'diatonic' means 'Pythagorean' diatonic, and that this is somehow the natural basis for all genera.⁶⁶ The derivation of the chromatic and the enharmonic from this standard is projected back to Pythagoras himself, whence it becomes clear that the tradition represented by 'Philolaus' and Thrasyllus was regarded as the genuinely Pythagorean perspective.⁶⁷ Nicomachus also states the equation between diatonic *parypátē*, chromatic *parypátē* and enharmonic *likhanós*,⁶⁸ which is so obviously a necessary characteristic of

⁶² When Philo, *Leg. alleg.* 1.14, calls the lyre the prime instrument for considering the enharmonic (ἡ ἐπτάχορδος λύρα πάντων σχεδὸν ὀργάνων ἀρίστη, διότι τὸ ἑναρμόνιον, ὃ δὴ τῶν μελωδομένων γενῶν ἔστι τὸ σεμνότατον, κατ' αὐτὴν μάλιστα πῶς θεωρεῖται), this might be related to such a 'trichordal' line; otherwise it contrasts sharply with the historical association of the enharmonic with the aulos. But more likely Philo mistakenly associates the most revered instrument with the most revered genus; cf. also his loose employment of 'enharmonic' at *Migr. Abr.* 104.

⁶³ For the musical programme of the Paean, cf. also Hagel 2002.

⁶⁴ If lyre music embraced such a trichordal enharmonic in imitation of aulos melodies, a conjunct chromatic or modulating tuning made it possible to modulate between two such 'trichords': *hypátē* – *parypátē* – *mésē* (*e-f-a*) is echoed, one semitone higher, by *parypátē* – *khrōmatikē* – *tritē synēmménōn* (*f-f#-bb*).

⁶⁵ Cf. Aristox. *ap. ps.-Plut., Mus.* 1145b: εἶτα καὶ τὸ μὴ δύνασθαι ληφθῆναι διὰ συμφωνίας τὸ μέγεθος, καθάπερ τὸ τε ἡμιτόνιον καὶ τὸν τόνον καὶ τὰ λοιπὰ δὲ τῶν τοιούτων διαστημάτων "another reason [for excluding the enharmonic quartertone from the musical intervals (for the preceding, cf. p. 415 below)] is the fact that its magnitude cannot be established by consonance, as can the semitone and the tone and the other intervals of that kind".

⁶⁶ Nicom., *Ench.* 7, p. 249.2–6.

⁶⁷ Cf. also the reference to the Aristoxenian viewpoint as that of "the more recent ones" (οἱ νεώτεροι) in Nicom., *Ench.* 12, p. 263.22–4.

⁶⁸ Nicom., *Ench.* 12, p. 263.3–10.

practical tunings. The details of his mathematics, however, are not disclosed in his extant *Manual*, where he merely promises an exhaustive account for his extensive treatise:

καὶ προσεκησόμεθα τὸν τοῦ Πυθαγορικοῦ λεγομένου κανόνος κατατομὴν ἀκριβῶς καὶ κατὰ τὸ βούλημα τοῦδε τοῦ διδασκάλου συντετελεσμένην, οὐχ ὡς Ἐρατοσθένης παρήκουσεν ἢ Θράσυλλος, ἀλλ' ὡς ὁ Λοκρὸς Τίμαιος, ᾧ καὶ Πλάτων παρηκολούθησεν, ἕως τοῦ ἑπτακαϊκοσιπλασίου.

(Nicom., *Ench.* 11, p. 260.12–17)

and in addition we will explain the division of the so-called Pythagorean canon, carried out accurately and in conformity with the intent of this teacher, not in the imperfect understanding of Eratosthenes or Thrasyllus, but in the way of Timaeus the Locrian, whom Plato followed, too, up to the twenty-seventh multiple.

This 'genuinely Pythagorean' tradition goes back to Plato's *Timaeus*, where the creation of the universe involves a 'division of the cosmic soul' in obviously musical terms, although Plato denies any immediately auditory implications.⁶⁹ The division is indeed carried through to the twenty-seventh multiple, which corresponds to an ambitus of four octaves and a sixth. But Plato develops no ready system; he merely creates a sort of large and unprecedented harmonic framework by the first three numbers, their squares and cubes, and the arithmetic and harmonic means between them. This results in a numeric structure that describes an intervallic series of mainly fourths, with some tones, two fifths, and one (discordant) minor third intercalated.

In a final step, the framework is filled with tones, so that of each fourth a *leitmma* remains. Expressed in the musical terminology that Plato avoids so carefully: diatonic tetrachords are created. Plato, however, wisely failed to mention the direction in which these tetrachords are to be taken, so that the final shape of the universal soul (and its relation to pitch structures) remained a mystery to be disputed by his followers.

Nicomachus, though, seems unaware of standing in a Platonising tradition. The work he obviously has in mind is not Plato's *Timaeus*, but the extant Hellenistic pseudepigraphon under the name of Timaeus the Locrian himself, which implicitly claims to be the book on which Plato based his dialogue. This work contains a complete and unequivocal numeric account of the division of the cosmic soul, in accordance with Plato's recipe.⁷⁰

⁶⁹ Plato, *Ti.* 35b–36b.

⁷⁰ 'Tim. Locr.' 209–13. The division is probably taken from Crantor, who expanded the figures by the same number (384) as the 'Timaeus Locrus' (Plut., *Anim. procr.* 1020c; cf. also Theon, *Util. math.* 68.12–69.12), which entails that the systems must have been practically identical.

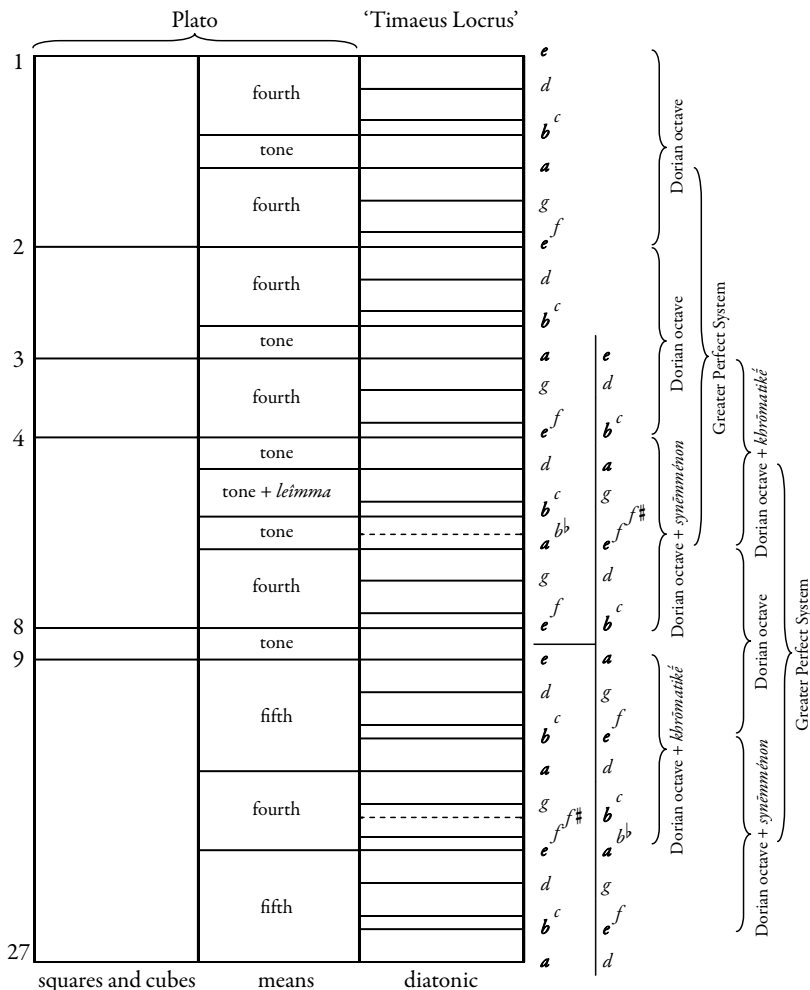

Diagram 39 The division of the universal soul

The Platonic tradition as such would be of little interest for our topic. Plato adopted the form of the diatonic tetrachord, but he was not interested in nor contributed to the description of musical structures. On the contrary, his authority makes it likely that later authors would even propagate his 'Pythagorean scale' in sharp contrast to musical reality. Therefore we need not pay much attention to anything that 'Timaeus Locrus', and consequently also Nicomachus, have in common with Plato. But there is

one detail that was not taken over from the philosopher, but from music theory.

The division of the pseudepigraphic Timaeus is set out in Diagram 39, without numbers, but with a scalar analysis in modern functional equivalents, and a selection of important musical structures that are present in the system.⁷¹ The detail of interest for the present study is the two places in which series of three consecutive 'semitones' are created – which require the introduction of accidentals in the transcription. Such a crowding of 'semitones' is seemingly in opposition to Plato's precept to supply tones only until a *leïmma* remains. In the diagram, the 'superfluous' notes are shown as broken lines.⁷² Now I can see no mathematical reason why they are inserted – except perhaps to bring the entire number of notes to a 'round' thirty-six; but would that justify the digression from Plato? But if the numeric system as such gains nothing from their presence, the motivation seems to have to do rather with the musical side. The introduction of the first 'superfluous' note is indeed accompanied by an explanation of the 'minor' and the 'major' semitones, *leïmma* (also referred to, in exclusively Pythagorean terminology, as 'diesis') and *apotomé*.⁷³

The latter is entirely alien to Plato's model and thus definitely proves an influence of non-Platonic Pythagorean music theory. Thus it becomes more probable that the notes in question are also inserted with respect to musical scales: either to account for the chromatic, or for the basic modulations, or simply for common tuning structures, which were used for both.

Nicomachus must have used a similar division, if he contrasts Timaeus' 'correct' version with the 'deviations' of Eratosthenes and Thrasyllus. The fault of Eratosthenes, whose system we are going to discuss below, was probably the invention of new figures for the chromatic that neglected the traditional equation between diatonic and chromatic *parypátē*. Thrasyllus, on the other hand, remained faithful not only to the 'Pythagorean' diatonic, but also to the chromatic *apotomé*; but he accounted merely for the two octaves of the Unmodulating System, not for Timaeus' cosmic scale.⁷⁴

⁷¹ The direction of the tetrachords follows from attributing 'fixed' notes to the positions of the framework; for the relationship between Plato's division and contemporary music theory cf. Hagel 2005a: 74–6.

⁷² They correspond to numbers 19 and 30 in the text: 'Tim. Locr.' 211.5–12; 212.7–8. Note that while the mutual relations of other positions are elaborated in some length, no comment of that kind is given for these two.

⁷³ *Diesis*: 'Tim. Locr.' 213.8; 12; *apotomé*: 213.7; 11; *leïmma*: 213.2–15; 'major' and 'minor semitone': 211.6–12 (read *μείζον ἄμιτόνιο(ν)* in 6). For the association of *diesis* = diatonic semitone with Pythagoreans, cf. Adrastus *ap.* Theon, *Util. math.* 55.11–15.

⁷⁴ *GMW* II: 266 n. 87.

On the other hand, there are good reasons for supposing that Boethius' quite dissimilar tetrachord divisions⁷⁵ reproduce those of Nicomachus: not only because the first books of Boethius' work seem to follow Nicomachus' lost treatise rather closely, but also because his chromatic and enharmonic divisions are based on arithmetic means, which appear appropriate for Nicomachus 'the arithmetician'.⁷⁶ In any case, these divisions cannot be identical with the "Pythagorean canon" Nicomachus promises, because their ambitus does not exceed the usual double octave. On top of this, Boethius never even mentions the number twenty-seven.⁷⁷

Boethius' divisions are part of his fourth book, which also contains the eight-mode system with its not strictly Pythagorean background. In the earlier books, however, which are clearly based on Nicomachus, the figures for the *apotomé* are calculated; this interval recurs in the account of Philolaus' system; eventually its construction is thoroughly demonstrated.⁷⁸ But in the end this thread leads nowhere, and in the actual divisions of the genera the *apotomé* plays no role at all. All in all, the traces of the orthodox Pythagorean chromatic division in Boethius' work are unmistakable, and yet he arrives at a different solution. This is, however, no proof that his genera are not taken from Nicomachus. Firstly, we need not presume perfect stringency in Boethius' source; and secondly, Boethius might have skipped the 'Pythagorean division' of the universal soul as not belonging to music theory proper. On the other hand, it is perfectly conceivable that Nicomachus integrated a 'Pythagorean' division of the canon, in accordance with 'Timaeus Locrus', side by side with an account of the three genera of the Perfect System with tetrachord divisions developed by himself. After all, the implicit 'chromatic *pykná*' of the Timaeus tables are not discussed there as such, so Nicomachus need not even have noticed their presence. Thus he might have felt justified in replacing the traditional form of the chromatic, which was not expressly sanctioned by 'Timaeus' and Plato.

Be that as it may, the chromatic genus as presented by Boethius, although deviating from the 'Pythagorean' chromatic, was evidently devel-

⁷⁵ Boeth., *Inst. mus.* 4.5–12, p. 314–35.

⁷⁶ Bower 1978: 19–26, against Pizzani 1965: 115–21.

⁷⁷ Bower's view that "the number 27 itself has nothing to do with the division except to establish ... the mathematical context within which the division takes place" (1978: 24) is hardly tenable; nor would it be a solution to delete the comma and read ζ καὶ Πλάτων παρηκολούθησεν ἕως τοῦ ἑπτακαταεικοσιπλάσιου, thus attributing the system "up to 27" to Plato only: firstly, the mention of the number is motivated only if it is crucial for Nicomachus' undertaking; and secondly, such a reading would imply that Nicomachus' 'Timaeus' did not use this boundary, whereas the only 'Timaeus' we know does.

⁷⁸ Boeth., *Inst. mus.* 2.30, p. 263–4; 3.9, p. 281–3; 3.15, p. 295–6.

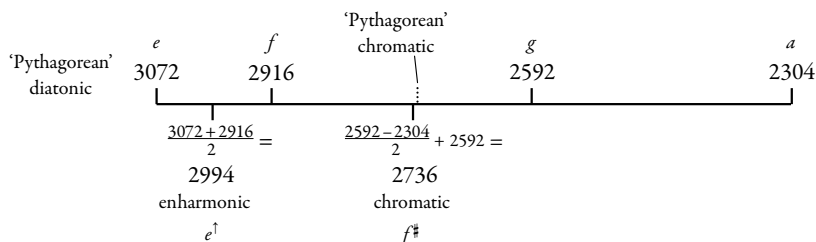

Diagram 40 Boethius' tetrachord divisions

oped with respect to it. Its construction is rather simple and reveals a bit of the typical mixture between the additive and the multiplicative approach, whose application here is however methodologically sound. The chromatic *likhanói* of each tetrachord are not found by taking the usual 9:8 tone from the lowest note upwards. Nor is Boethius using the arithmetic mean for 'bisecting' the tone within which the sought note lies, although this would have been a natural procedure, which he actually adopts for the division of the enharmonic *pyknón*.⁷⁹ For the chromatic, a different formula is developed, which is at a first glance altogether curious: the numeric difference between the two highest notes of the diatonic tetrachord is bisected, and the result added to the diatonic *likhanós*, thus increasing the diatonic tone to the chromatic 'three semitones' (cf. Diagram 40).⁸⁰ What appears as a serious inconsistency, however, emerges as an original way of preserving the traditional interval sizes by introducing a new mathematical method: taken in this way, the chromatic *likhanós* is practically identical with the old whole-tone *kbrōmatiké*, with a difference of only 3.4 cents, about the sixtieth part of a tone (cf. the dotted line in the diagram).⁸¹

It follows that the seemingly deviating chromatic division found in Boethius is only another testimony to the authority of the 'Pythagorean' paradigm, only out of which it can be understood. Nicomachus is certainly a plausible candidate for the invention of such a system, which requires familiarity with the mathematical procedures by which the sizes of different intervals are compared – a technique for which Boethius' work is outstanding among the extant treatises.⁸² In any case, Boethius' genera are fully

⁷⁹ Boeth., *Inst. mus.* 4.6, p. 321.15–322.2.

⁸⁰ Boeth., *Inst. mus.* 4.6, p. 320.24–321.9.

⁸¹ As a ratio, the difference amounts to 513:512. The enharmonic 'quartertones', on the other hand, are close to Aristoxenian identity, with sizes of 44.5 and 45.7 cents, respectively.

⁸² Cf. e.g. Boeth., *Inst. mus.* 3.15, p. 295.20–296.29, *Apotomen maiorem esse quam quattuor commata minorem quam quinque, tonum maiorem quam .VIII. minorem quam .VIII.* "that the *apotomé* is larger than four *kómmata*, but smaller than five, and the tone larger than 8, but smaller than 9".

compliant with the principles stated by Nicomachus, namely the priority of the diatonic, from which the chromatic and the enharmonic are derived, and the adoption of the ditone for all three genera, which orthodox Pythagoreanism shares with the Aristoxenians.

Minor Sources

Another proponent of the orthodox view is Gaudentius, who provided two diatonic and one chromatic table of the Greater Perfect System, and explains that the chromatic *pyknón* consists of both types of semitone, *leimma* and *apotomé*.⁸³

The *koinē hormasia* must be mentioned here, as well. Although it contains neither a numeric account nor geometric instructions, it establishes 'Pythagorean' diatonic and chromatic tetrachords by its tuning procedure, which we have proven to proceed in fifths and fourths. The same is true of the *Division of the Canon*, which complements the framework of fixed notes by inserting 9:8 tones.⁸⁴ A similar procedure is proposed by Aristides Quintilianus.⁸⁵

The curious figures given by Bellermann's Third Anonymous also belong here, although they preserve almost nothing of genuinely 'Pythagorean' ratios.⁸⁶ The number series for the Perfect System ranges from 192 to 768, and proceeds through diatonic tetrachords of 19:18 – 9:8 – 64:57, inverted to 19:18 – 64:57 – 9:8 above the disjunction. Obviously the architect of this system was not concerned about elegant ratios any more than about the traditional 'Pythagorean' figures. What he was after is a complete

⁸³ Gaud. 15–16, p. 343–4. The tables are lost, but can be reconstructed unambiguously from their respective highest numbers, which Gaudentius mentions in the text.

⁸⁴ *Sect. can.* 20, p. 166–7.

⁸⁵ Aristid. Quint. 3.2, p. 97.17–98.21. For the purpose of a diatonic 'Pythagorean' division, the bounding figures he gives in advance (p. 97.7–9) are unnecessarily large (cf. *GMW* II: 497 n. 16; even if the *synēmménōn* tetrachord is included, all can be divided by two). Since they are identical with Boethius' figures, one might consider the possibility that they are taken from Nicomachus' *Introduction*.

⁸⁶ Anon. Bell. § 77 (+ 79). The upper part is mutilated, and § 79 wrongly restored by Najock: the four extant figures there belong to another diagram, similar to § 96. The complete Greater Perfect System must read: 192 – 216 – 228 – 256 – 288 – 304 – 342 – 384 – 432 – 456 – 512 – 576 – 608 – 684 – 768. Note that these figures can still be divided by two. The Lesser Perfect System requires an additional *trité synēmménōn* of 405½, for which the manuscripts have "435". Was the series wrongly expanded by 2 instead of 3 in the course of inserting the *synēmménōn* tetrachord? Cf. the similar case of a non-integer *synēmménē* in the cosmic scale of Ptolemy's *Canobic Inscription*, 154.1–155.2, and probably of the lost *Harm.* 3.14, p. 82.28–30; cf. *Exc. Neap.* 24, p. 418.14–420.6 (see Hagel 2005a: 64–7).

series of as small integers as possible, for which he was ready to sacrifice even the exact correspondence of the tetrachords. Indeed his numbers are considerably smaller than those of all rival systems. Nevertheless this account, too, must be understood against the background of the common 'Pythagorean' diatonic, whose intervals it reproduces in remarkably close approximation: no single pitch or interval deviates by more than 3.4 cents from the 'Pythagorean' model scale.

The pinnacle of the 'orthodox Pythagorean' tradition, however, survives only in one copy in a thirteenth-century codex.⁸⁷ There a 'canon of the entire order' is found, unfortunately without indication of its provenance (and moreover full of the typical errors that arise in copying mainly numerical material). It establishes a scale very much like that of Thrasyllus, including the diatonic and chromatic notes, although here confined to the Greater Perfect System. The terminology is also identical with that of Thrasyllus, referring to '*khrōmatikai*' and '*diátonoi*' in all four tetrachords. At first, the measurements for the division of the canon are listed. Here the viewpoint is clearly practical, so that the relevant section of the ruler is divided into twenty-four units, fractions of which are used where necessary. In this respect the author is close to Ptolemy's method – the large integers used elsewhere betray a mainly theoretical interest, since they cannot be applied to the experimental instrument right away. The Perfect System is accordingly bounded by the numbers 6 (*nētē hyperbolaiōn*) and 24 (*proslambanōmenos*), with *mésē* at 12.

In a further step, epicentric note pairs are formed, and it is shown that the product of their respective numbers is always the same, namely 144. No further comment is added, but it is clear that this procedure highlights the stupendous symmetry inherent in such a full 'Pythagorean' division: starting from central *mésē*, the series of intervals is identical in both directions (cf. Diagram 41). As is easily understood with the help of the diagram, this symmetry is based on the equation of the higher tone of the diatonic tetrachord with the disjunctive tone ($a - b = g - a$), of the lower tone of the diatonic tetrachord with the sum of the two chromatic 'semitones' ($e - f\sharp = c - d$, $b - c\sharp = f - g$), and, of course, of the diatonic with the lower chromatic 'semitone'. It is therefore not exclusive to the 'Pythagorean' model, but by no means a common characteristic of tetrachord divisions. Under the restrictions posed by such a symmetry only one parameter is open to choice, namely the size of the *pyknón* = the middle interval of the diatonic tetrachord. Of the various mathematical divisions known from other ancient

⁸⁷ *Anecd. Stud.*, 3-7; 14-19.

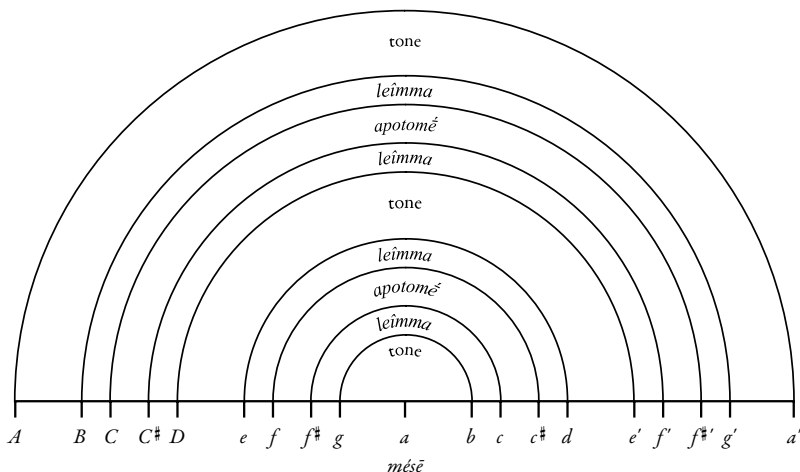

Diagram 41 The symmetry of the Pythagorean Perfect System (*Anecd. Stud.*, 4–7)

theorists, only one meets these specifications (we will come to it before long). After all, the *pyknón* and the lower diatonic tone are entirely unconnected in every other respect; therefore, the epicentric symmetry does not easily arise by chance, as a side-effect of preferences which are governed by other considerations.

Nevertheless, such symmetry is necessarily inherent in the standard ‘Aristoxenian’ approach with its grid of equal semitones; in any case, this old ‘harmonicist’ way of looking at intervals rests on the same fundamentals as the ‘Pythagorean’ system. Both are based on a maximum of similar tones, and consequently all necessary elements were innate to both from the beginning. As regards the ‘Pythagorean’ branch, all ingredients were present already in the system ascribed to Philolaus. It seems therefore impossible to assess a date for the first explicit establishment of the inherent symmetry. It is also conceivable that the ‘Pythagorean’ mathematical demonstration had a primitive precursor that pointed, for instance, to the epicentricity of just the Dorian octave with *hyperypátē* (*D* to *e'* in Diagram 41).⁸⁸ Thrasyllus’ mixture of diatonic and chromatic, along with his reluctance to deal with enharmonic quartertones, are perhaps tokens that he was either aware of that symmetry or dependent on a source that made it explicit.

⁸⁸ This range of twenty-eight quartertones was obviously of some importance in pre-Aristoxenian theory; cf. *GMW*1: 145 n. 117; Hagel 2000: 181–2; below, pp. 383ff.

SUPERPARTICULARITY

A third line of theorists are 'Pythagoreans' insofar as they describe intervals as ratios of numbers and consequently deny the possibility of accurately bisecting superparticular intervals such as the tone. But they disagree with the orthodox tradition in detail, and attribute different numbers to the chromatic, or the diatonic, or to both genera.⁸⁹ Curiously enough, practically all our knowledge about the various systems of this kind that were proposed within about five hundred years derives from only one work, namely Ptolemy's *Harmonics*.

The common ground of all respective accounts is the quest for mathematical elegance, and more specifically, for the description of musical scales in superparticular ratios, as far as possible. It was probably the dissatisfaction with the unwieldy *leimma* of 256:243 and the monstrous *apotomé* of 2187:2048 that encouraged Archytas in the beginning of the fourth century BC to rework the divisions of the tetrachord from scratch.

The aesthetic motivation of all the authors in question is obvious. For the human ear, only the larger intervals gain resonance by corresponding as closely as possible to superparticular pitch ratios. The Pythagorean viewpoint was in the first place based on direct experience of the consonant sounds associated with the numeric relations of 2:1 (octave), 3:2 (fifth) and 4:3 (fourth). A first level of abstraction led to the calculation of the tone as $3:2 \div 4:3 = 9:8$. Thus it emerged that the interval of primary melodic importance was superparticular, too, although no one would have counted it among the consonances. Accordingly, the expression of, if possible, all melodic intervals as superparticular ratios seemed a worthy objective, even of 'semitones' and 'quartertones', where there is no perceptible difference between mathematically more or less beautiful pitch relations. Such intervals are therefore certainly pure mathematical fiction, especially because they could not be realised with any precision on the aulos or the lyre (nor on any other ancient instrument).⁹⁰ Other cases are less clear and demand thorough investigation. It is perfectly possible to tune a lyre to resonant thirds, for instance; but it is by no means guaranteed that a ratio of 5:4 given by a theorist corresponds to a major third of musical practice, rather

⁸⁹ Cf. perhaps the distinction between 'Pythagoreans' and '*géométrai*' in Cod. Vat. 192, fol. 224r (Reinach 1897: 318–19)? This "special channel of the tradition" is recognised by Barker 1994: 67.

⁹⁰ For a comprehensive evaluation of all extant accounts under the viewpoint of practicality, see Franklin 2005.

than being introduced for mere numeric beauty. In such cases, mathematical beauty and auditory resonance coincide. Where there is lack of resonance, however, the viewpoints diverge. In the ‘Pythagorean’ diatonic, for instance, the major acoustic problem is the harsh thirds, whereas the primarily obvious mathematical shortcoming is the *leimma* of 256:243, which, as such, does not offend the ear worse than semitones of other sizes.

Again, it would be naïve to assume a priori that the proposed systems were tested on experimental instruments for accordance with commonly heard scales. On the contrary, sometimes they were not even intended to correspond to actual music.⁹¹ According to Ptolemy, no one prior to him had ever tested a theoretically conceived scale for its musical suitability by playing an actual melody.⁹² It is therefore highly problematic to extract positive evidence about the employment of minor resonant intervals, i.e. thirds, from transmitted ratios, and the more so because we possess only one of the respective original works. Above all, it is the frequent coincidence of mathematical beauty with auditory qualities that makes it difficult to decide where a specific feature belongs.

One of the principles stated before is particularly important when dealing with the adherents of the superparticular creed: much more promising than their successes are their failures, the points where the divisions of a given system fall short of the ‘mathematical’ standards that are otherwise maintained. Such cases can reveal facts of musical practice that were so obvious that the author dared not disagree with them openly, even if a better numeric solution would have been at hand. Still, we must bear in mind that, as far as their relation to practice is concerned, the present branch of ‘Pythagorean’ music theory deviates more from the views of both the *harmonikoi* and the orthodox Pythagoreans than these two differ from each other: whereas these agree about the identity of the two diatonic whole tones and the disjunctive tone, the superparticular faction was compelled to assume tones of at least two different sizes.

⁹¹ Ptolemaï̄s *ap. Porph.*, in *Harm.* 23.24–31: Πυθαγόρας καὶ οἱ διαδεξάμενοι ... κἀν τὸ σύστημα τὸ ὑπὸ τοῦ λόγου εὔρεθῆν τῆς πραγματείας μηκέτι συνάδη τῇ αἰσθήσει, οὐκ ἐπιστρέφονται, ἀλλ’ ἐπεγκαλοῦσι λέγοντες τὴν μὲν αἴσθησιν πλανᾶσθαι, τὸν δὲ λόγον εὔρηκέναι καθ’ ἑαυτὸν τὸ ὀρθὸν καὶ ἀπελέγχειν τὴν αἴσθησιν “even if the scale that is found according to the logic of their study is no longer in unison with perception, Pythagoras and his followers do not retreat, but bring a charge against perception, maintaining that it goes astray, whereas logic has found the truth by itself and refutes perception”.

⁹² Ptol., *Harm.* 2.12, p. 66.11–24; 2.13, p. 68.32–69.8.

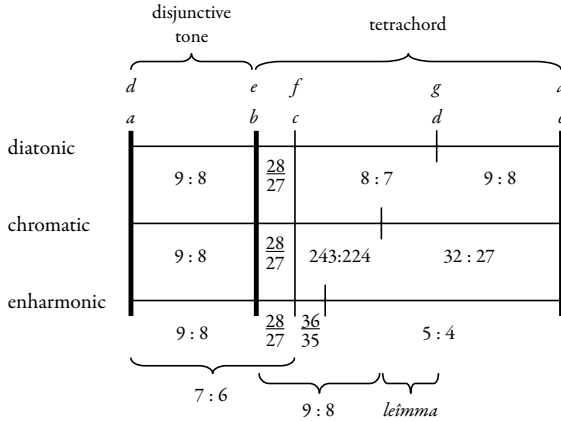

Diagram 42 Archytas' tetrachord divisions

Archytas

Ptolemy credits Archytas with the title of “the Pythagorean most concerned with music”.⁹³ So it is no wonder that the ratios transmitted as those given by the famous philosopher have found the greatest interest, as they seemed to promise the earliest ‘exact’ accounts of Greek tonality. All the more so, since Archytas’ tetrachords display certain characteristics with which later authors disagreed throughout, so that they could be regarded as the only key to the music of the classical age.⁹⁴

Indeed, Archytas’ arrangement of intervals, which is shown in Diagram 42,⁹⁵ reveals some extraordinary idiosyncrasies. Unlike all other theorists, he makes the lowest interval of all three genera identical, assigning to it the size of about a third of a tone (28:27). Consequently, the lower diatonic tone is a large ‘septimal tone’ (8:7; the whole tone above guarantees *synēm-ménon* modulation, as usual); the higher interval of the chromatic *pyknón* is more than twice as large as the lower one, and in the enharmonic *pyknón*,

⁹³ Ptol., *Harm.* 1.13, p. 30.9–10. The division is described in 30.17–31.6.

⁹⁴ Cf. e.g. Tannery 1915: 110.

⁹⁵ Since it is commonly held that Archytas’ divisions must be understood with respect to a disjunctive tone below the tetrachord, this tone is included in the diagram; cf. Tannery 1915: 78 with n. 1; 111; Winnington-Ingram 1932: 206–7; 1936: 25–8; *AGM*: 221; Hagel 2000: 89–93; Franklin 2005: 29 and *passim*.

Fine-tuning

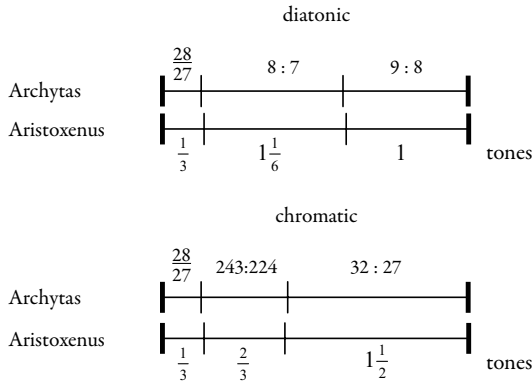

Diagram 43 Aristoxenus' 'Archytan' divisions

the lower interval is larger (although hardly perceptibly larger), contrary to the general rule stated by Aristoxenus and reinforced by Ptolemy.⁹⁶

On the other hand, two passages from Aristoxenus have been taken as confirmations of Archytas' diatonic and chromatic.⁹⁷ Aristoxenus cites successions of $\frac{1}{3} + 1\frac{1}{6} + 1$ tones and $\frac{1}{3} + \frac{2}{3} + 1\frac{1}{2}$ tones respectively as valid instances of these genera. Indeed these figures are extraordinarily close to Archytas' ratios (cf. Diagram 43). On the other hand, the text does not imply any connection with older theory; and one must bear in mind that Aristoxenus explicitly excludes an enharmonic such as that of Archytas,⁹⁸ insisting that the enharmonic *parypátē* is always different from any chromatic or diatonic one.⁹⁹ Certainly Aristoxenus' motivation was not to include Archytas' system wholesale.

Nor did he mention those tetrachord divisions because they were widely used in musical practice. Above we have considered those shades to which he ascribes broad recognition. If the two seemingly Archytan divisions had also been in common use, it is hard to see what would have prevented Aristoxenus from including them in his list. But he does not even provide a

⁹⁶ Aristox. as below, p. 173 n. 103; Ptol., *Harm.* 1.14, p. 32.1–10.

⁹⁷ Aristox., *Harm.* 1.27, p. 35.3–7; 2.51, p. 65.4–20; Westphal 1886: 98–9; Winnington-Ingram 1932: 202–3.

⁹⁸ Cf. Winnington-Ingram 1932: 197 n. 2.

⁹⁹ Aristox., *Harm.* 1.26, p. 34.14–17: παρυπάτης δὲ δύο εἰσὶ τόποι· ὁ μὲν κοινὸς τοῦ τε διατόνου καὶ τοῦ χρώματος, ὁ δ' ἕτερος ἴδιος τῆς ἀρμονίας· κοινῶν γὰρ δύο γένη τῶν παρυπάτων. ἔναρμόνιος μὲν οὖν ἐστὶ παρυπάτη πᾶσα ἢ βαρυτέρα τῆς βαρυτάτης χρωματικῆς... "there are two regions of *parypátē*, one common between diatonic and chromatic, the other characteristic for the enharmonic: two genera share their *parypátai*. Now every *parypátē* lower than the lowest chromatic is enharmonic..."

name for them. A closer inspection of Aristoxenus' argument reveals their actual significance.

What the manuscripts transmit as Aristoxenus' *'Harmonics'* consists of parts of more than one work.¹⁰⁰ The compendium contains two complete discussions of tuning shades, which emphasise slightly different points.¹⁰¹ Still, both present the same set of six standard shades, with consistent nomenclature. The two 'Archytan' shades do not appear in direct association with either of these lists. They are introduced merely to prove the validity of Aristoxenus' formal rules for possible tetrachord divisions, and only one of them appears in each of the two passages. We shall be able to discuss these most conveniently if we label the three intervals of the tetrachord as A, B and C, with ascending pitch:

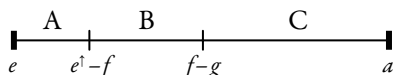

If the sum of the two lower intervals is smaller than the upper ($A + B < C$), so Aristoxenus, one talks about a *pyknón*.¹⁰² For the possible relations between the intervals he states the rules that:

- (1) the lowest is never larger than the central interval: $A \leq B$, whereas
- (2) any relationship between the two higher intervals is valid:

$$(B < C) \cup (B = C) \cup (B > C).^{103}$$

The first statement cannot be proven conclusively in the strict sense of the word, since it is not possible to test all of the in principle infinite divisions that either apply to or contradict the rule. All that can be done is to give examples for 'correct' and 'wrong' tunings, which appeal to the ear as melodic (*emmelés*) or as out of tune (*anármostos*), respectively. To establish the validity of the second principle, in contrast, it suffices to give one example for each relation in question.

For the allegedly 'Archytan' shades, the well-formed divisions are of primary interest. Examples for most cases are already provided by the standard

¹⁰⁰ For an exemplary analysis of the relations between the different 'books' see Barker 2007: 115–35.

¹⁰¹ Aristox., *Harm.* 1.21–7, p. 28.3–35.8; 2.46–52, p. 57.13–65.20.

¹⁰² Aristox., *Harm.* 1.24, p. 31.3–5.

¹⁰³ Aristox., *Harm.* 1.27, p. 34.19–35.3: τῶν δὲ διαστημάτων τὸ μὲν ὑπάτης καὶ παρυπάτης τῷ παρυπάτης καὶ λιχανοῦ ἦτοι ἴσον μελωδεῖται ἢ ἔλαττον, τὸ δὲ παρυπάτης καὶ λιχανοῦ τῷ λιχανοῦ καὶ μέσης καὶ ἴσον καὶ ἄνισον ἀμφοτέρως. Similarly in 2.52, p. 65.2–4; 15–16. These rules are not to be understood as sufficiently defining possible divisions; for instance, they do not exclude the combination of an enharmonic *parypátē* with a non-enharmonic *likhanós*, or a semitone at the top. Such issues are controlled by the genus-dependent definitions of the valid ranges for the 'movable' notes.

tunings,¹⁰⁴ where we find:

- (1) $A < B$ (diatonic)
 $A = B$ (enharmonic, chromatic)
- (2) $B < C$ (enharmonic, chromatic, soft diatonic)
 $B = C$ (tense diatonic)

A positive example is only lacking for $B > C$. To construct a division with this characteristic, Aristoxenus naturally resorts to the pitches that he has already defined in the preceding discussion of the familiar shades. Out of these, only one pairing fulfils all requirements, namely that of the lowest non-enharmonic *parypátē* with the highest possible *likhanós*. These create the unusual diatonic of $\frac{1}{3} + 1\frac{1}{6} + 1$ tones which is so close to Archytas' figures. Yet we cannot infer that Aristoxenus had in mind either Archytas' ratios or a practical tuning behind them. He plainly had no other choice, if he did not want to introduce new points of reference within the pitch continuum – and there was certainly no reason at all to complicate the matter further. No significance is given to the resulting structure in its own right; Aristoxenus does not even pause to inspect the size of its intervals.

In the similar argument of the second passage, the 'Archytan diatonic' is not even constructed as such. Here the discussion is more elaborate, and the in principle infinite possibilities of dividing the tetrachord remain in focus. Consequently no single tuning is pinned down; it suffices to assert the melodic acceptability of the combination of "the highest diatonic *likhanós* with a ny *parypátē* lower than that at the semitone".¹⁰⁵ Here it is evident that Aristoxenus saw no point in promoting any specific variant – and that in the other passage a definite example is merely introduced for the sake of conciseness.

The shade that resembles Archytas' chromatic, $\frac{1}{3} + \frac{2}{3} + 1\frac{1}{2}$, is only mentioned in the more elaborate passage. Here it functions as the proof that unequal lower intervals (i.e. $A < B$) occur not only in the diatonic (where they are trivial). Other than in the case of the diatonic shade discussed above, here there would have been an alternative – although rather a theoretical one: a division of $\frac{1}{3} + \frac{5}{12} + 1\frac{3}{4}$, generated by the 'hemiolic' instead of the 'soft chromatic' *likhanós*, has the required characteristics, too. But here the difference between the two intervals of the *pyknón* is just a twelfth of a tone, and therefore barely perceptible. Naturally Aristoxenus chose the neat figures of the other combination, in which the second inter-

¹⁰⁴ Cf. Diagram 36 on p. 153 above.

¹⁰⁵ Aristox., *Harm.* 2.51, p. 65.18–20: ...ἔταν (τις) λιχανῶ μὲν τῇ συντονωτάτῃ τῶν διατόνων, παρυσπάτῃ δὲ τῶν βαρυτέρων τινὶ τῆς ἡμιτονιαίας χρήσεται.

val is twice as large as the first, so that the melodic acceptability of the unequal division can be assessed unambiguously.

All in all, the passages from Aristoxenus by no means support the view that Archytas' divisions were frequently employed in musical practice. We should take Aristoxenus' account on face value: Archytas' chromatic and diatonic represent scales that are within the scope that fourth-century Greek taste would in principle accept, and similar divisions might have been in use. But Aristoxenus' standard diatonic and chromatic were still identical with those of the 'Pythagorean' main stream, which is for the time in question witnessed by Plato and the allegedly Philolaic system also. Although Aristoxenus' enriches the picture with a number of secondary shades, none of these resemble any of Archytas' genera. Perhaps we should even consider the possibility that Aristoxenus allowed for the Archytas-like divisions, wherever possible, not so much with regard to musical practice, but out of reverence for his great colleague and fellow countryman, a deferential biography of whom is among Aristoxenus' lost works.¹⁰⁶ Even so, he merely acknowledges that Archytas' diatonic and chromatic are not against the rules of harmony. In any case, an enharmonic with lower intervals similar to those Archytas gives had to be ruled out.

Apart from the interval sizes, which were disputable, Archytas overturns the otherwise canonical relationship between the enharmonic and the two other genera. While others identified the highest note of the enharmonic *pyknón*, the *likhanós*, with the second lowest note of the diatonic and chromatic tetrachord, their *parypátē*,¹⁰⁷ for Archytas the three *parypátai* are equal in pitch. As a confirmation of his view, the notational practice has been pointed out.¹⁰⁸ Here the second lowest note of the tetrachord is designated by the same sign regardless of the genus. Undeniably, the notation was originally conceived not in accord with the canonical note equations, which could be expressed in terms of a grid of quartertones and were almost certainly inspired by the conditions of stringed instruments, but rather in the context of aulos music with its infinity of possible shadings, which were nevertheless produced by an in principle constant fingering.

On the other hand, the 'harmonicist' view must already have been around at Archytas' time, and presumably a good deal earlier. After all, even the term 'diatonic' preserves the notion of creating the scale, or at least of

¹⁰⁶ Cf. esp. Aristox. *ap.* Diog. Laer. 8.82.

¹⁰⁷ The equation is clearly present in the account of the pre-Aristoxenian *mousikoi* in ps.-Plut., *Mus.* 1134f–1135a (*diátonos parypátē* becomes enharmonic *likhanós*); cf. below, pp. 397ff.

¹⁰⁸ Cf. e.g. *AGM*: 168.

filling up the harmonic superstructure, by tones, i.e. in alternating fifths and fourths, in a tradition that derived from ages unknown. Consequently, Archytas' diatonic is not diatonic at all in the original sense of the word (which the 'orthodox Pythagorean' line preserved), but a modification of it, although within the boundaries that Aristoxenus later assigned to the 'diatonic genus'. The disregard of the harmonicist enharmonic note equation, however, is hardly understandable unless we attribute at least Archytas' conception of the enharmonic to a similar context as the origins of the notation, namely the auletic. Although we are generally accustomed to imagine ancient music theorists, and especially Pythagoreans, as sitting over the monochord, an aulos-centred Archytas is perfectly consistent with the testimonies. Firstly, the aulos is attested as a serious concern of Pythagorean philosophers, and we find reference to a work of Archytas on this subject.¹⁰⁹ It was only later that the rejection of the wind instrument in Athenian elite circles spread out, finally to become philosophical mainstream. Secondly, in the passage on acoustics that survives from Archytas' work, he makes no mention of strings at all, although the notion of pitch increasing with tension and therefore vibration rate would perfectly fit his general theory, which associates pitch with a sort of *impetus*, a combination of speed and motional force.¹¹⁰ Instead, Archytas' first musical example is the aulos, whose connection with the proposed physical model is fairly awkward.¹¹¹ After the magic wheel (*rhómbos*), in which the effect of speed is obvious, Archytas proceeds to another wind instrument, the flute, the mechanism of which is explained similarly to the aulos. Here the fragment

¹⁰⁹ Ath. 184e: καὶ τῶν Πυθαγορικῶν δὲ πολλοὶ τὴν αὐλητικὴν ἥσκησαν, ὡς Εὐφράνωρ τε καὶ Ἀρχύτας Φιλόλαός τε ἄλλοι τε οὐκ ὀλίγοι. ὁ δ' Εὐφράνωρ καὶ σύγγραμμα περὶ αὐλῶν κατέλιπεν ὁμοίως δὲ καὶ ὁ Ἀρχύτας "Many of the Pythagoreans practised the art of the aulos, Euphranor, for instance, and Archytas, and Philolaus, and quite a number of others. Euphranor even left an essay on auloi; and so did Archytas". Cf. Hagel 2005a: 80; n. 8 on p. 3 above.

¹¹⁰ Archyt., fr. 1 = Porph., in *Harm.* 56.11–57.27. Cf. the excellent discussion in Huffman 2005: 140–6 (although perhaps with too little appreciation of the *impetus* conception as opposed to the modern separation between speed and force).

¹¹¹ ἀλλὰ μὲν καὶ ἐν γὰρ τοῖς αὐλοῖς τὸ ἐκ τῷ στόματος φερόμενον πνεῦμα ἐς μὲν τὰ ἐγγύς τῷ στόματος τρυπήματα ἐμπύπτον διὰ τὰν ἰσχύνην τὰν σφοδράν ὀξύτερον ἄχον ἀφήσιν, ἐς δὲ τὰ πόρσω, βαρύτερον. "But in the auloi the breath that moves out of the mouth also gives a higher sound if it falls into the holes nearer to the mouth, because of its considerable force, but a lower sound, if into the distant ones." Notably, it was possible to cite characteristic experiences of aulos playing for quite the opposite assertion; cf. Theophr. *ap.* Porph., in *Harm.* 63.7–11: ἀπονώτερον γὰρ τὸ ὀξύ τῷ διὰ τῶν ἄνω γίνεσθαι τρήματων, βίας δὲ δεόμενον τὸ βαρὺ, καὶ μείζονος εἰ δι' ὅλου τὸ πνεῦμα πέμποιτο, "high pitch needs less effort because it comes up through the holes at the top, while low pitch requires force, and even more, if the breath is sent through the entire [pipe]"; ps.-Aristot., *Aud.* 800b (see n. 139 on p. 321 below).

breaks off; if strings were mentioned in the missing part, their little prominent place would still be more than noteworthy.¹¹²

If the aulos forms the primary conceptual background of Archytas' tetrachord divisions as well, we must expect a significant degree of freedom in his account: due to its complicated physics and flexible intonation, the aulos did not lend itself to experimental tests of finer numeric divisions,¹¹³ and unlike the fixed pitches of lyre strings, those achieved by partially stopping finger holes do not imply much about their mutual relations. If one actually desired to represent features of aulos music in numeric divisions, this was possible mainly in two fields. Firstly, in the harmonic structure, insofar as it was hard-coded within the design of the instrument, namely by accounting for the resonant intervals at which the aulos makers aimed. And secondly, by taking into consideration some intervals of specific importance in playing, and ensuring that these correspond to attractive ratios.

The aulos as Archytas' instrument of reference easily accounts for the identification of the lowest intervals of the three genera. Either he adopted the conception which he found expressed in the notation,¹¹⁴ presumably aware that it transported the auletic paradigm. Or he conceived them as identical because of their similar fingering: the note in question was obtained by partially covering the same hole – although it remains a matter of question whether the degree of covering might not actually have differed in the enharmonic. But can such an assumption explain the rest of his figures, too? Is it not contradicted by the chromatic? There a 9:8 tone is maintained as the size of the *pyknón*, just as in the 'orthodox' Pythagorean tradition. Archytas obviously regarded this relation as indisputable, even if it brought about the awkward ratio of 243:224 for the higher interval of the *pyknón*.¹¹⁵ These particular numbers were however not even mentioned

¹¹² Against the idea of Archytas working experimentally with string lengths there is also his association with the proof that superparticular ratios cannot be halved (cf. n. 33 on p. 150 above). Had Archytas associated pitches with geometric lengths, would we not expect him to have realised the existence of a very straightforward geometrical construction resulting in the geometric mean between 9 and 8 and thus providing an easily accessible means of constructing a true semitone on the canon (cf. Busch 1998: 115–17)? After all, he provided an approach to the not entirely dissimilar, although much more complicated 'Delian problem' of doubling the cube (cf. Huffman 2005: 451–70).

¹¹³ A sort of experimental aulos appears envisaged at Nicom., *Ench.* 10, p. 255.4–17, but only as to demonstrate the basic consonances of octave, fifth and fourth.

¹¹⁴ Pöhlmann 1995: 1661; cf. Burkert 1962: 363 n. 81.

¹¹⁵ Cf. Barker 1989: 166–7; Huffman 2005: 421. As pointed out by Tannery 1915: 71 n. 1, Archytas could easily have incorporated a chromatic tetrachord with superparticular ratios into his system, namely 28:27 – 15:14 – 6:5. Note also that Archytas would have been particularly compelled to maintain the 9:8 chromatic *pyknón* if he was influenced by the notation, and if there the citharodic *kbrōmatiké* was associated not with the highest sign of an auletic triplet, but with the basic O K (as implied by its tuning and by its treatment in Ptolemy, and as found in the *koiné hormasia*).

by him; Ptolemy calculated his Archytan tables from the indication that the higher chromatic movable note and its diatonic counterpart enclose the interval of 256:243.¹¹⁶ Curious as this cross-genus reference may seem, it is actually the way to put it without any further calculation: from the fourth that bounds the tetrachord, the higher diatonic interval subtracts one tone from the higher and the chromatic *pyknón* another tone from the lower end, so that the remainder is the well-known *lémma*.¹¹⁷ It emerges that Archytas showed no interest in the ratios of 'his chromatic' as such. Its shape was determined by the common lowest interval and by that tone which he treats as given; after he had established his new versions of the diatonic and the enharmonic, it sufficed to indicate briefly how the chromatic related to these.

All this is in accord with our considerations concerning the genera before and in Aristoxenus. The chromatic originated in lyre music in the form of Aristoxenus' 'tonic chromatic'. All the smaller *pyknón* sizes that were played on the aulos were perhaps never classified into 'enharmonic' and 'chromatic' shades until Aristoxenus put forward his regular shapes, which were abstracted from their original instrumental contexts and conceived with emphasis on Aristoxenus' favourite enharmonic with a large ditone and two quartertones. Archytas naturally uses the term 'chromatic' in its older meaning, implying a fixed *kbrōmatiké*. By his times, though, the chromatic movement had probably permeated auletic music, as well, along with the exuberance of modulation. Here, too, it arose from the melodic combination of notes within an originally modulating structure; and this is how Archytas still takes it (cf. Diagram 44).¹¹⁸

It remains to find the reasons behind the size of the common lowest interval, and behind the enharmonic division. The pure major third of the enharmonic (5:4) is generally accepted as a genuine rendition of contemporary music, since it reflects Aristoxenus' notion of a 'sweetened' enharmonic so nicely, with its *likhanós* set slightly higher than a double 9:8 tone (i.e., 386 instead of 408 cents below the highest note of the tetrachord). The interpretation of 'sweetness' as minor resonance is of course attractive. Still, we must doubt whether there is much empiricism behind Archytas'

¹¹⁶ Ptol., *Harm.* 1.13, p. 31.2–6. The passage merely describes Archytas' account but contains no quotation, in spite of the introductory φησὶ γάρ "for he says": the practice of counting notes and intervals within the tetrachord instead of using terms such as *likhanós* etc. are typical of Ptolemy's abstinence from the terminology of musical practice when talking about more abstract relations.

¹¹⁷ Note that this way of referencing the *lémma* proves that the ratios of the 'Pythagorean' diatonic were already well known in Archytas' time.

¹¹⁸ Cf. Abert 1924: 37; Vogel 1963b: 124–5.

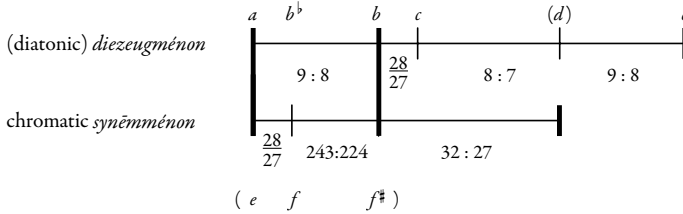

Diagram 44 Archytas' whole-tone chromatic

figures, even if they hit the truth in this case. It has been assumed that Archytas based his ratio on the observation that the lyre string for the enharmonic *likhanós* was first tuned as a ditone, and subsequently altered; similarly, the diatonic *parypátē* would have been slightly lowered. On the aulos, nothing of this kind is however possible. Although the difference is certainly audible (compare Aristoxenus' criticism), the wind instrument provides no clue about the nature of the respective intervals. Admittedly, though, Archytas might have introduced items of lyre-based musicology into his account, even if he insisted on the auletic identification of notes.¹¹⁹

Although such speculations are not easily refuted, none of the said assumptions are actually necessary. Firstly, the ratio of 5:4 is the natural choice for the enharmonic 'ditone' if one cares for superparticulars as such, which Archytas obviously did.¹²⁰ But one need not even employ the idea of superparticulars for their own sake here. The figures for the thirds are most easily derived by the arithmetic or harmonic means of the fifth, just as the harmonic framework is derived from the means within the octave.¹²¹ Ar-

¹¹⁹ We must however remember that the Dorian *parypátē* could not take part in a 'Pythagorean' tuning on the old seven-stringed lyre (above, p. 115). Even when a new *tritē* was finally inserted, it does not follow that it was subsequently employed as the intermediate step in setting up *parypátē*; more likely, musicians continued to tune the latter in the traditional way, whatever this was (Ptolemy's *lydia* presents precisely such a Dorian tuning with Pythagorean *tritē* and non-Pythagorean *parypátē*!). This structural autonomy of the *parypátē* of the tuning underlying the standard tetra-chord Archytas works with (as becomes clear from the inherent importance of a disjunctive tone below) might have supplied an additional motive for equating it with the enharmonic one.

¹²⁰ Huffman (2005: 410-23) rightly concludes that Archytas did not pursue the principle of superparticularity of all melodic intervals in all genera. If he presumes, however, that the idea of 'an interval slightly larger than 9:8' would have led Archytas immediately to the "natural suggestion" of a large tone of 8:7, that of 'an interval slightly smaller than 81:80' to 5:4, Huffman admits the impact of the superparticular aesthetic conception, even if he derives the intervals in question through the theory of means (419-20; cf. Barker 2007: 299-100 with n. 31).

¹²¹ Cf. Tannery 1915: 81; van der Waerden 1943: 185-7; Vogel 1963a: 50-1; *GMW* II: 48-9; Barker 1989: 163-5; 2000: 123-5. The arithmetic mean m between two numbers a and b is given by the formula $m - a = b - m$ (the distance of the mean to both extremes is the same), the harmonic mean by $(b - x) / (x - a) = b / a$ (the ratio of the distances is the same as the ratio of the extremes).

chytas was responsible for a major step forward in the theory of means, and their application to music theory without doubt goes back to him. If he embarked on applying means to structures other than the fixed note framework, the enharmonic major third as dividing the fifths between *hyperypátē* and *mésē* and between *mésē* and *nētē* was an obvious first step, especially if a chromatic *likhanós* one major third above the lower note was out of question.¹²² In a further step, the division of the fourth yielded the septimal third and the septimal tone, which in Archytas' tetrachords divide the space between *mésē* and *nētē* *synēmménōn* (or *hyperypátē* and diatonic *likhanós*). As a consequence, the common lowest interval emerges as 28:27.

Elegant as the theory of means may appear in elucidating Archytas' divisions, the size of the lowest interval can even be explained without it. It actually suffices to start from the reasonable assumption that Archytas regarded low numbers as welcome as such. He may have set out from nothing more than the necessary 9:8 tone at the top of the diatonic tetrachord, which required the 4:3 of the bounding fourth to be expanded by 9:

	fourth	tone		
<i>mésē</i>	4	9	→	36
<i>likhanós</i>		8	→	32
<i>parypátē</i>				?
<i>hypátē</i>	3		→	27

In other words, no diatonic with a highest number below 36 will meet the basic requirements. Without further expanding the figures, only the number 28 makes sense in the missing position. It gives an acceptable *parypátē*, as regards interval sizes; on top of this, it stands in superparticular ratios to its neighbours.¹²³

Archytas' final system is especially attractive because it comprises all numbers below ten,¹²⁴ and because most of the involved superparticular ratios are realised so that their higher term is projected onto the *nētē* (cf. Table 5). This inherent symmetry also shows how neatly the adoption of a 28:27 interval inserts the prime number seven into the overall structure.

¹²² Since Archytas apparently associated higher numbers with higher pitch in accordance with his physics (cf. van der Waerden 1943: 173–5; Hagel 2005a: 79), he would have obtained the enharmonic third by the harmonic mean. This conception, which runs contrary to experiments with strings, retained some importance in writers of the Pythagorean strand; cf. the discussions of both options in Adrastus *ap. Theon, Util. math.* 65.10–66.11; Thrasyllus *ap. Theon, Util. math.* 87.9–18; Nicom., *Ench.* 10, p. 254.5–13.

¹²³ Note that an alternative 29, besides generating unbearable ratios, deviates even more from the traditional Pythagorean division and, on top of this, cannot function as chromatic or enharmonic *parypátē*.

¹²⁴ Cf. Barker 1989: 163.

	fixed notes			movable notes	
	octave	fifth	fourth	enharmonic third	diatonic / <i>synēmménon</i> / common interval
<i>nētē</i>	2	3	4	5	9
<i>paranētē</i>				4	8
<i>tritē</i>					7
<i>paramésē</i>			3		
<i>mésē</i>		2			6
<i>likhanós</i>					
<i>parypátē</i>					
<i>hypátē</i>	1				

Table 5 Superparticulars in Archytas' divisions

Finally, on the basis of a common lowest interval, the 28:27 semitone was probably the only available solution anyway. The sought interval had to be sufficiently small to produce a sensible division of the enharmonic *pyknón*, and at the same time it should create, if possible, a superparticular middle diatonic interval, while being superparticular itself. These conditions are fulfilled by no other figures.

Thus it is clear that every bit of Archytas' divisions follows from a handful of primary assumptions of either musical or mathematical character:

- the identification of the lowest intervals, which very likely derives from an auletic context,
- the indisputable 9:8 tones of common modulating structures which determined the size of the higher diatonic tone as well as that of the chromatic *pyknón*, and finally
- the quest for low numbers and simple numeric relations, especially superparticular ratios, wherever possible, perhaps by deriving them from arithmetic and harmonic means.

Since no other solution accords with these requirements, there is no room for further consideration of interval sizes as observed in musical practice, not to speak of experimental confirmation. Quite possibly Archytas' pure third 'reflects' an enharmonic third of (late) classical music, but if it is so, the coincidence is due to the fact that numeric simplicity coincides with well-sounding music, after all. Nor are we encouraged to rely on the Archytan 'semitone'. Possibly the septimal thirds that it establishes were indeed

an element of the music of Archytas' time; but we can hardly infer so on the basis of his divisions.

Eratosthenes

If Archytas with his focus on the enharmonic and the diatonic stands for classical music, Eratosthenes represents the Hellenistic age. Once more, an original thinker with broad interests also proposed a refined harmonic model. Not being the partisan of any specific school, he devised a balanced system, which paid tribute to all earlier views. Eratosthenes attempted nothing less than the reconciliation of the 'orthodox' Pythagorean view and the Aristoxenian standard genera within a general superparticular approach as inherited from Archytas.¹²⁵ His divisions, as they appear in Ptolemy's tables, are set out in Diagram 45.

The appearance of a straightforward 'Pythagorean' diatonic among so many superparticular intervals may seem surprising. But meanwhile this diatonic division – unlike its chromatic counterpart – had become sanctified by Plato's *Timaeus*.¹²⁶ On the other hand, it still represented the standard tuning procedure and provided the obvious numeric interpretation of the Aristoxenian standard diatonic.

The other two genera are quite differently conceived. Firstly, it is of the greatest importance that their tuning tables in Ptolemy's *Harmonics* are identical with those that pretend to represent Aristoxenus' enharmonic and tonic chromatic.¹²⁷ It has been emphasised that the latter testify to a kind of mathematical blunder that one would rather not attribute to Ptolemy, who might perhaps be excused as having taken the figures over from Eratosthenes' work "without pausing to inspect its credentials".¹²⁸ Yet there is little reason to assume that the Hellenistic mathematician was such an

¹²⁵ Cf. Barker / Creese 2001.

¹²⁶ Cf. Geus 1995: 59 n. 27.

¹²⁷ Vogel 1963a: 45; Neumaier 1986: 164–5; Barker 2000: 254; cf. also *GMW* II: 345 n. 112.

¹²⁸ Barker (2003: 85–6) proposes an original solution to the dilemma that Ptolemy, whether adopting or creating the incriminated tables, appears to have been either temporarily inept or unfair to the point of serious dishonesty: he might have taken the tables from Eratosthenes, wrongly crediting Aristoxenus himself with the divisions and the inherent methodological flaw. But this would imply, firstly that Eratosthenes was very much less of "a highly skilled mathematician" than Ptolemy, which is hardly true; and secondly, that Ptolemy has not seen Aristoxenus' original works, which I think unlikely (note especially his well-informed report of Aristoxenus' argument for the fourth consisting of five semitones, *Harm.* 1.10, p. 22.2–16).

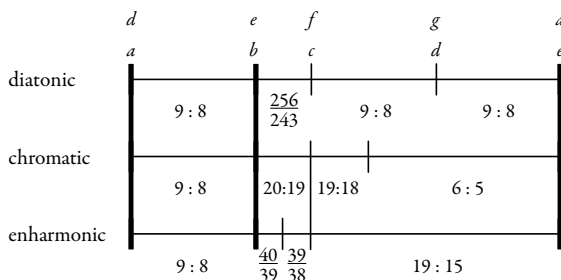

Diagram 45 Eratosthenes' tetrachord divisions

inferior mind either. Furthermore, Ptolemy can hardly be supposed to have overlooked the methodological problems involved. Hence, we ought to wonder whether there was perhaps some good reason to embrace those divisions.

The problem lies once more in the confusion of the additive and the multiplicative approach. To produce measures for positions of the bridge on the canon, Aristoxenus' pitch differences are treated as differences in string length, which is mathematical nonsense, of course. On the other hand, a particular numerical coincidence seems to suggest an integration of Aristoxenus' tetrachordal shades into Ptolemy's tables: for the sake of comparison between the former, the tone is commonly divided into twelve 'intervallic' units, and accordingly the fourth into thirty,¹²⁹ while on Ptolemy's experimental instrument the lower tetrachord extends from '90' to '120', which embraces thirty units of length.¹³⁰ In the first book of his *Harmonics*, Ptolemy correctly lists Aristoxenus' six shades in terms of equal parts of a tone – interestingly in twenty-fourth parts, which ensure that even the 'hemiohic' *diéseis* are rendered as integers.¹³¹ But when it comes to constructing all the proposed divisions, Ptolemy wrongly identifies Aristoxenus' units of pitch with his own units of length, thus creating the distorted representations.¹³² The amount of error thus generated for the 'tense dia-

¹²⁹ Ptol., *Harm.* 2.13, p. 69.29–70.4; cf. Aristox., *Harm.* 1.25–6, p. 32.7–33.15, and e.g. *Exc. Neap.* 17, p. 416.2–9. The twelfth of the tone suffices for a comparison of the positions of Aristoxenus' 'familiar' *likhanoi*. Comparing the *parypatai* requires another bisection, as carried out at Ptol., *Harm.* 1.12, p. 30.

¹³⁰ Ptolemy actually declares that he divides his ruler for accordance with Aristoxenus' number thirty; but his primary motivation was doubtless the fact that an octave of 120 units nicely reflects the harmonic framework as 60:80:90:120.

¹³¹ Ptol., *Harm.* 1.12, p. 29–30.

¹³² A similar confusion underlies Ptolemy's inadequate anti-Aristoxenian arguments in *Harm.* 1.9, p. 20.22–21.8, as one of my reviewers kindly reminds me; cf. *GMW* II: 294 n. 85.

Fine-tuning

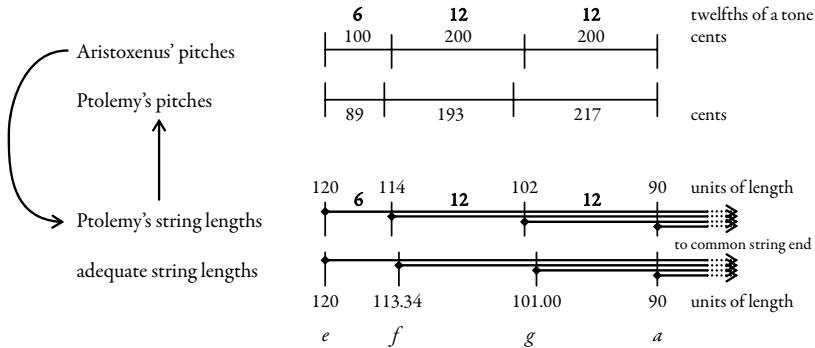

Diagram 46 Ptolemy's canon lengths for Aristoxenus' 'tense diatonic'

tonic' is shown in Diagram 46: its upper half compares the sizes of Aristoxenus' intervals with those that a canon set up according to Ptolemy's figures will sound, whereas in its lower half Ptolemy's bridge positions are contrasted with those that would render Aristoxenus' intervals correctly.

In the same way, Eratosthenes' chromatic and enharmonic are seemingly derived from Aristoxenus' units:

Enharmonic:

120	(3)	117	(3)	114	(24)	90
	120:117 =		117:114 =		114:90 =	
	40:39		39:38		15:19	

(Tonic) chromatic:

120	(6)	114	(6)	108	(18)	90
	120:114 =		114:108 =		108:90 =	
	20:19		19:18		6:5	

The nature of the misrepresentation increases the lower and decreases the higher intervals, while those in the centre of the tetrachord are affected least. Consequently, for a consideration of maximal digressions it suffices to regard those between the two inner notes of the tetrachord: the larger of these is always also larger than all divergences between corresponding intervals. Table 6 lists the respective values for all the Aristoxenian shades. In spite of the faulty procedure, all the errors are smaller than a tenth of a tone, many of them considerably smaller. From a practical viewpoint, the results are by no means unreasonable – and we must bear in mind that the task of Ptolemy's respective chapter is entirely practical.¹³³ In such a con-

¹³³ The preceding section deals with technical questions concerning the design and optimal usage of the experimental instrument. Accordingly, the bridge positions are given not as accurate ratios, but as

	<i>parypátē</i>	<i>likhanós</i>	
enharmonic	6.0	10.9	} cents
soft chromatic	7.7	13.4	
hemiotic chromatic	8.6	14.5	
tonic chromatic	10.9	16.9	
soft diatonic	10.9	17.9	
tense diatonic	10.9	17.5	

Table 6 Errors in Ptolemy’s representation of Aristoxenus’ shades

text, Ptolemy is willing to allow even for a difference of 22 cents as “not noteworthy”.¹³⁴ Possibly, then, he was aware of the general problem, but adopted the ‘Aristoxenian’ tables in this form for practical purposes, in the absence of the mathematical means to find the appropriate values. Still, he gives us no clue that there are serious methodological shortcomings; but is this not what one rather expects from an ancient author?

As far as Eratosthenes is concerned, we are left entirely in the dark. The identity of two of his divisions with the problematic ‘Aristoxenian’ tables makes it very probable that it was indeed he who originally conceived them. But whether he discussed their character as mere approximations, perhaps with reference to the Aristoxenian notion of perception as the ultimate guide, or plainly misunderstood his source, remains unclear.

At any rate, there is more to Eratosthenes’ divisions than just a tribute to Plato and an approximate derivation of two specific Aristoxenian shades. Firstly, he acknowledges the identification of the diatonic and the chromatic *parypátē*, but in an original way. His lowest chromatic interval of 20:19 is in principle different from the diatonic *leímma*. But for all practical purposes, they are identical, their difference amounting to mere 1.4 cents.¹³⁵ The general idea behind this construction seems related to the issues we have raised in connection with the ‘wrong’ Aristoxenian tables. In

useful approximations designed for a common unit-measure (Ptol., *Harm.* 2.13, p. 69.24–9). Finally, Ptolemy makes it clear that the only task of these tables is “the perceptual assertion of the differences between the genera” (τὴν ἀνάκρισιν τῶν γενικῶν διαφορῶν).

¹³⁴ Ptol., *Harm.* 1.16, p. 39.19–22 (μηδενὶ ἀξιολόγῳ διαφέρειν); 40.1–6. When dealing with the theoretical question of the semitone, on the other hand, Ptolemy offers an approximate ratio of 258:243 (*Harm.* 1.10, p. 24.10–17), which differs from the true half-tone, $\sqrt[9]{9:8}$, as such inaccessible with the mathematical means of antiquity, by mere 1.74 cents, or the 115th part of a tone.

¹³⁵ Cf. Ptol., *Harm.* 2.1, p. 45.3–5, where “smaller than a *leímma*” is correctly, however without further explanation, equated with “smaller than 20:19” (because the *leímma* is smaller than 20:19). The value of 20:19 × 505:504, given in Aristid. Quint. 3.1, p. 96.20–5 as an approximation of the *leímma* (cf. Redondo Reyes 2003b: 311–13), is in fact worse than the simple 20:19 (2.0 instead of 1.4 cents difference; the superparticular corrective is actually 1216:1215).

both cases, traditional assertions are clothed in a new mathematical form, which is *prima facie* contradictory with their original meaning; but the difference falls within a range that is not, or not easily, assessed by perception. In the present case, Eratosthenes seems to imply that the diatonic and the chromatic *parypátē* are not functionally the same note, as had been universally assumed, but that the possibility of playing them with the same instrumental note is merely due to the inadequacy of human perception. This may testify more to typical Hellenistic play with the tradition than to grim-faced pursuit of hidden metaphysical meaning.

On the other hand, the chromatic *pyknón* stands below a pure minor third, therefore comprising not the usual 9:8 tone, but merely an interval of 10:9. Its ‘semitones’ are created by arithmetic division, for which the terms are conveniently doubled: 10:9 = 20:18, with an arithmetic mean of 19. Analogously the lower chromatic semitone is bisected into enharmonic quartertones. Again, the impossibility of exactly bisecting a superparticular interval is overcome by an approximation that cannot be distinguished perceptually from exact bisection: the two intervals differ by only 4.8 cents.

This procedure is not a mere by-product of the derivation from Aristoxenus’ figures; in the *Excerpta Neapolitana* it is explicitly presented as Eratosthenes’ invention.¹³⁶ There it is however applied to the usual 9:8 tone, as required for a more traditional sort of chromatic, which is cut into semitones and quartertone *diéseis*:

tone	9:8 = 18:16 = 36:32			
semitones	18:17		17:16	
<i>diéseis</i>	36:35	35:34	34:33	33:32

Once more there is only a difference of 4.5 cents between the largest and the smallest ‘quartertone’: they are identical for all practical purposes.¹³⁷

From these figures, which have no complement in the tables Ptolemy transmits as Eratosthenes’ three genera, it transpires that the latter probably convey a rather unbalanced picture of the Hellenistic scholar’s contribution to harmonic theory. Still, they admit a cautious interpretation in the context of Hellenistic music. The fact that Eratosthenes could live with a non-superparticular 19:15 as the upper enharmonic interval is presumably

¹³⁶ *Exc. Neap.* 19, p. 416.12–417.11; the figures are given in Aristid. *Quint.* 3.1, p. 95.19–96.17, without identification of their source.

¹³⁷ I suppose that Eratosthenes’ ‘programme’ of bisection is echoed in Ptol., *Harm.* 1.15, p. 34.13–14: τῶν μὲν ὑπεροχῶν τηρουμένων ἴσων, τῶν δὲ λόγων παρίστων, ἐπεὶ μὴ δυνατόν ἴσων “maintaining equal differences, and approximately equal ratios, equal ones being impossible”.

to be understood in the context of the obsolescence of this genus. The mathematical flaw that inevitably turns up at one point or other in any system of divisions is thus shifted to the genus of least importance. The chromatic, on the other hand, which in Eratosthenes' time dominated the music of high culture, is entirely based on superparticular intervals, even if this required the separation of the melodic chromatic *pyknón* from the modulating disjunctive tone – an evolution which we find continued in Ptolemy's cithara tunings. The chromatic is no longer a side-effect of the progression in fifths and fourths beyond the ordinary seven notes, but has become a genus in its own right.

Eratosthenes' diatonic, finally, need not be understood as merely traditional. It also reflects the pitch relationships between the *tónoi*, and is therefore essential for modulation. Furthermore, it was indispensable if Eratosthenes perhaps adopted some system of seven or eight *tónoi* that he related to the diatonic octave species.¹³⁸

Once more, we have found all elements of a sophisticated superparticular system entirely determined, and partially over-determined, by purely theoretical considerations. Again, a further orientation of actual interval sizes towards musical practice seems almost impossible, and is at any rate impossible for us to detect. No specific connection to instrumental practice emerges from Eratosthenes' figures. Did the chromatic pure third reflect some resonant tuning, or was contemporary citharody still content with the whole tone *khōrōmatiké*? The evidence from Eratosthenes shall give us no answer.

Didymus

In the first century of our era, the music theorist Didymus, of whom we otherwise know little,¹³⁹ conceived an especially nice set of divisions. His

¹³⁸ Above we have seen that the Hellenistic age knew an eight-scale system that was neither wholeheartedly Aristoxenian nor Pythagorean, and that this system was criticised, probably not very much later, by somebody who argued for seven *tónoi* on the basis of the seven octave species (Ath. 625d: above, p. 101 with n. 24). Eratosthenes might be the authority behind one of these accounts; both would require a 'Pythagorean' diatonic.

¹³⁹ Barker (1994: 64–73) combines the evidence to some intriguing hypotheses, not all of which will be accepted by everyone. In any case, Porphyry's statements (*in Harm.* 5.7–15) do not imply that Didymus' work foreshadowed a substantial part of Ptolemy's general lines. Apparently much of Ptolemy's discussion of the Pythagorean and Aristoxenian principles draws on Didymus' respective work; but no further inference can be made.

figures for the three genera, as transmitted by Ptolemy, are displayed in Diagram 47. They adopt all common note equations, including the regular, and hitherto unquestioned, modulating 9:8 tone at the top of the diatonic. In addition, Didymus provides a maximum of pure thirds, both major and minor. Archytas had introduced the figures for the major third into his enharmonic. Eratosthenes had dismissed it again, in favour of a chromatic minor third. Didymus finally unites both, and in addition supplies his diatonic with a major and a minor third.¹⁴⁰ At the same time, he brings the superparticular paradigm to its zenith: for the first time, all non-composite and even a good deal of the composite intervals adhere to this norm.

Just as Eratosthenes, Didymus had to sacrifice the ‘Pythagorean’ chromatic 9:8 *pyknón*, which would entail a non-superparticular upper chromatic interval of 32:27. More seriously, the internal division of Didymus’ chromatic *pyknón* breaks the Aristoxenian rule that the size of the lower interval must never exceed that of the upper,¹⁴¹ a point explicitly criticised by Ptolemy.¹⁴² For the enharmonic quartertones, on the other hand, Eratosthenes’ simple ‘almost-exact’ bisection by the arithmetic mean is employed.

Although the superparticular coherence of his system may seem sufficient motivation, Didymus’ intentions went beyond that. Fortunately, it is possible to deduce part of his methodological background from Ptolemy’s remarks with reasonable certainty. Apart from the plain figures, we receive two pieces of information. Firstly, Didymus made a different use of the canon than his predecessors.¹⁴³ Before him, all the notes had been played on one side of the bridge only. Didymus was the first to pay attention to the remaining part of the string as well. Ptolemy gives one example. The entire string produces, as usual, the *proslambanómenos*. If the bridge divides it at

¹⁴⁰ It seems necessary to emphasise that Didymus’ division cannot be identified “as our modern major mode”, as Solomon (2000: 95–6 n.227) apparently believes: the intervals are in opposite order – apart from the fact that intervals alone establish no ‘mode’. As far as the tetrachordal division is concerned, the modern just tuning is similar to Ptolemy’s ‘tense diatonic’, which has the major and minor tone the other way round.

¹⁴¹ This fact cautions against interpreting the elements of musical practice in Didymus’ system as taken over specifically from Aristoxenian theory (so Barker 1994: 67–72). If Didymus’ goal really had been to recreate the tunings of classical Greek music as set forth by Aristoxenus, he could not have allowed himself such a flaw against one of the master’s most basic rules (a flaw, moreover, which is recognised from the figures at once).

¹⁴² Ptol., *Harm.* 2.13, p. 68.27–9.

¹⁴³ Ptol., *Harm.* 2.13, p. 67.24–68.6. Ptolemy treats this as a small advance concerning the use of the canon for actual music-making: if two consecutive melodic notes happen to share the same bridge position, the bridge need not be moved. This is certainly of no real help. As becomes clear below, such note pairs lie at least a fifth apart; such large intervals do not occur all too frequently in ancient melodies. Ptolemy projects to his predecessor’s instrument his own intention of playing and judging entire melodies.

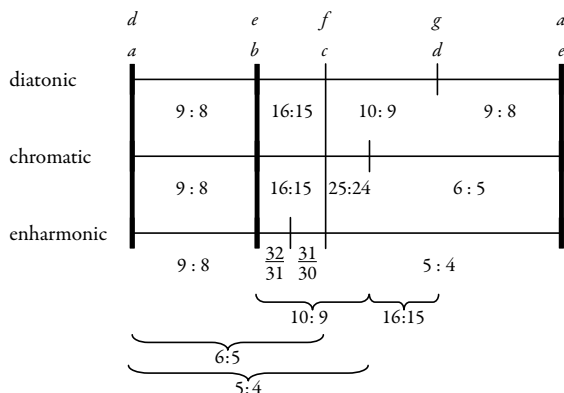

Diagram 47 Didymus' tetrachord divisions

one third of its length (so that one of the resulting parts is twice the other), the longer section will sound the *hypátē mesôn*, the shorter the *nētē diezeugménōn*, since they stand in the respective relations of 2:3 and 1:3 to the entire string.

Secondly, we are told that although Didymus assumed three genera like everybody else, his division included only the chromatic and the diatonic, and that it was restricted to the Greater Perfect System.¹⁴⁴ This statement has caused considerable confusion, because Ptolemy seems to contradict himself when supplying figures for Didymus' enharmonic, too.¹⁴⁵ But we have come across a similar asymmetry in Thrasyllus, who wrote only some decades before Didymus. Thrasyllus' orthodox Pythagorean division also regarded merely the diatonic and chromatic notes; only afterwards, he mentioned the bisection of the enharmonic *pyknón*, although without reference to any mathematical formula by which it would be computed. Didymus' procedure might have been along analogous lines. Establishing a division (*katatomé*) means to construct all the numbers involved in a coherent commensurable scheme, so that they can be transformed to theoretically exact bridge positions on the canon.¹⁴⁶ The greater the num-

¹⁴⁴ Ptol., *Harm.* 2.13, p. 68.15–19: ...τρία μὲν καὶ αὐτὸς ὑφίσταται γένη, διατονικὸν καὶ χρωματικὸν καὶ ἑναρμόνιον, ποιεῖται δὲ τὰς κατατομὰς ἐπὶ τε μόνων τῶν δύο γενῶν, τοῦ χρωματικοῦ καὶ τοῦ διατονικοῦ, καὶ μόνου τοῦ ἀμεταβάλλου συστήματος. In Ptolemy's terminology, *système ametábolon* refers to the structure which is usually known as the Greater Perfect System, *système meízōn*, i.e. not including the *synēmménon* tetrachord.

¹⁴⁵ Cf. Barker 2000: 129–30.

¹⁴⁶ Note that Ptolemy's comprehensive tables diverge from this principle; they serve only practical purposes and do therefore not care about integers. — The construction of commensurable measure-

ber of different structures that are included within such a division, the larger become the figures; apparently no one before Ptolemy worked out a comprehensive system of more than two genera.¹⁴⁷

It is quite a difference between giving just the ratios of the single intervals, and explaining how additional notes are to be found on the basis of the established structure. The latter is what Thrasyllus did for the enharmonic; Didymus probably followed his path. As we shall understand shortly, he did so not for the sake of smaller numbers, but because the enharmonic would not fit into his system any more than into the orthodox Pythagorean. In any case, finding the positions for the enharmonic notes by the arithmetic mean was trivial (quite possibly, Thrasyllus envisaged the same method).

To detect one of the main ideas behind Didymus' system, we have but to apply his principle of using both sides of the string to his figures. Ptolemy's example concerns the boundary notes of the central octave, *hypátē* and *nētē*, so it is reasonable to assume that this relation of fixed notes was also Didymus' starting point. The both-sides idea can however not govern an entire division; even within the central octave, by far not all notes could be forced into pairs.¹⁴⁸ Many are fixed notes anyway, and therefore not at the theorist's command. A definition of the diatonic and chromatic involves the demarcation of merely three movable notes, the two *likhanoi/paranētai* and the common *parypátē/trítē*. These three, however, are constituted by Didymus according to the principle under discussion.

We have seen that the outermost pair of fixed notes, *nētē* and *hypátē*, complement each other to the full string of *proslambanómenos* by good luck: $\frac{1}{3} + \frac{2}{3} = 1$ (cf. Diagram 48). The next pair consists of movable notes, *parypátē* and diatonic *paranētē*. The position of the latter was universally assumed to be a fourth above *mésē*, to coincide with *nētē synēmménōn*: the corresponding string length is $\frac{3}{8}$. For the *parypátē*, a length of $1 - \frac{3}{8} = \frac{5}{8}$ of the string remains, so that it comes to lie at that 16:15 semitone above *hypátē*, which is characteristic for Didymus' division.

ments could also be done geometrically, without listing the resulting ratios as figures, as in the pseudo-Euclidean *katatómē* (*Sect. can.* 17–20, p. 162–6).

¹⁴⁷ Ptol., *Harm.* 2.12, p. 66.6–11: ...οὐ καθ' ἓνα μόνον τόνον, οἷον τοῦ ἀμεταβόλου συστήματος, οὐδὲ γένος ἓν ἢ δύο κατὰ τὰ αὐτὰ τοῖς πρὸ ἡμῶν... “...not in only a single key, like the Greater Perfect System, nor in one genus, or two, in a similar way as our predecessors...”

¹⁴⁸ This limitation is acknowledged in Ptolemy's καὶ ἐπὶ τῶν ἄλλων τῶν τὸ παραπλήσιον ἐπιδεχομένων ὁμοίως “and similarly for the other [notes] that admit an analogous treatment” (*Harm.* 2.13, p. 68.5–6).

Superparticularity
tetrákhordon diezeugménon

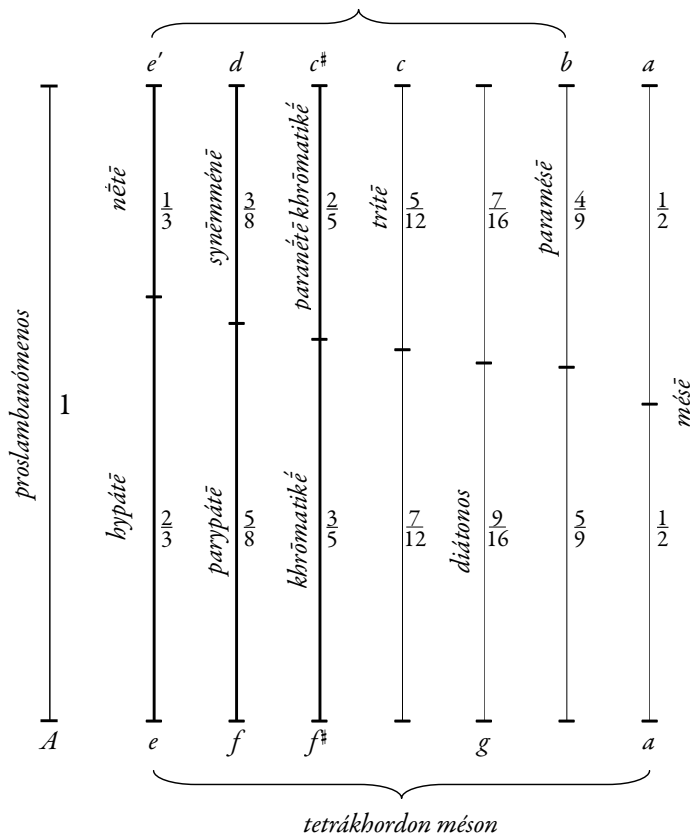

Diagram 48 Bridge positions for Didymus' central octave

This leaves only the upper chromatic notes undefined. Curiously, the two instances of this note, chromatic *likhanós* and *paranētē*, form the next pair in the series. This makes it possible to calculate their position from the two given assumptions: firstly, that they divide their tetrachords in the same way, which is trivial, and secondly, that their respective string lengths complement each other to the *proslambanómenos*. The calculation is most straightforward if we relate the note in question to the highest note of the tetrachord. Two notes shall lie at the same interval x below *mésē* ($\frac{1}{2}$) and *hypátē* ($\frac{1}{3}$), respectively, so that their combined string lengths give a total of 1. More formally: $\frac{1}{2}x + \frac{1}{3}x = 1$, whence the sought highest chromatic interval emerges as $x = \frac{6}{5}$, the minor third of Didymus' divisions. That the for-

mula produces not just any note but indeed a very reasonable chromatic *likhanós* is just another happy coincidence. It goes almost without saying that the enharmonic can by no means be included: neither does its *parypátē* find any counterpart between *nētē* and diatonic *paranētē*, nor is there an acceptable enharmonic *trítē*.¹⁴⁹

The rest of the notes within the octave do not form pairs, either: the principle of dividing the string into two meaningful parts can govern the constitution of the genera, which are at the theorist's disposal to a certain extent, but not the layout of the system in its entirety. All the same, the seven string divisions of Diagram 48 display a beautiful pattern if their notes are related to the tonal centre of *mésē*. The respective two parts of the string run through all superparticular ratios from the fifth to the minor tone:¹⁵⁰

<i>mésē</i> : higher part	2:3	3:4	4:5	5:6	7:8	8:9	1:1
<i>mésē</i> : lower part		3:4	4:5	5:6	6:7	8:9	9:10 1:1

On top of all this, Didymus' division of the canon is another example of complete epicentric symmetry within the double octave of the Greater Perfect System (cf. Diagram 49). Thus it implements one of the greatest benefits of the orthodox Pythagorean approach, but in accordance with the superparticular dogma. Although our sources give us no indication of this particular aspect, it is extremely unlikely that it was due to coincidence and went unnoticed. As I have demonstrated elsewhere, epicentric symmetry is not an ordinary attribute of rational tetrachord divisions. As a matter of fact, Didymus' figures represent the only solution with superparticular intervals throughout.¹⁵¹ This taken into account, it is tempting, in spite of the late evidence for the awareness of the Pythagorean symmetry, to ascribe the latter to Thrasyllus at the latest. Thus Didymus' division might be understood as the superparticular faction's answer to this challenge. This hypothesis also nicely accounts for the fact that the two almost contempo-

¹⁴⁹ The complementary note of the diatonic *likhanós* with a length of $\frac{7}{16}$ creates a 'pyknón' of 64:63 – 21:20, whose lower interval of 27 cents is clearly too small for melodic use.

¹⁵⁰ Cf. Barker 1994: 70–1 with n. 32; Franklin 2005: 37 fig. 6. On a canon of 120 units, as used by Ptolemy and plausible for Eratosthenes (because necessary for his apparent representation of the Aristoxenian figures), Didymus' seven divisions are also exceptionally comfortable. They translate to the following measurements in hexagesimal notation, for which a scale with units divided into six parts suffice:

higher part:	40	45	48	50	52.30	53.20	60
lower part:	80	75	72	70	67.30	66.40	60

¹⁵¹ Hagel 2006b, adumbrating also the arithmetical means by which the solution could be discovered.

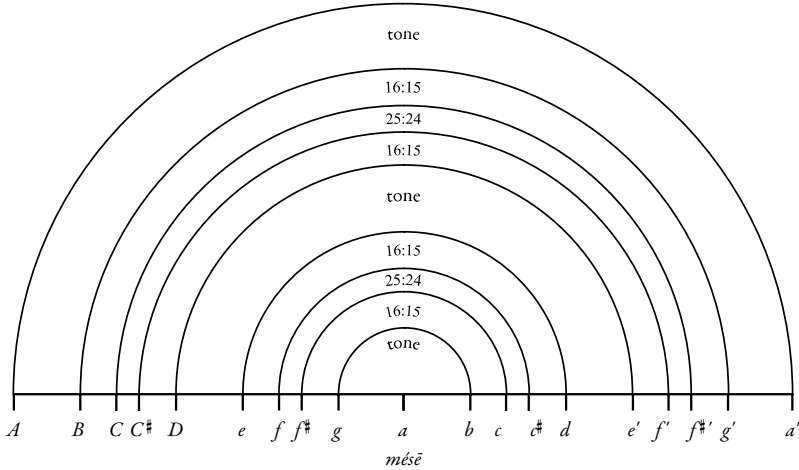

Diagram 49 The epicentric symmetry inherent in Didymus' canon

rary authors agree in not including the enharmonic within their divisions, although providing for it otherwise.¹⁵²

As regards the general lines of musical mathematics, the epicentric symmetry is somehow analogous to the principle of using the notes from both sides of the bridge. Both involve the notion of note pairs which complement each other to a fixed total. The difference lies in the type of calculation: in one case the string lengths are added (and yield the *proslambanómenos* = $2 \times \text{mésē}$), in the other multiplied (resulting in the square of *mésē*). Ptolemy tells us merely of the first type of symmetry, which affects his practical concern with the canon; but of course this does not preclude that Didymus considered the multiplicative aspect as well.

We cannot know with any certainty which symmetries stood in the foreground when Didymus devised his figures, and which he perhaps welcomed as additional benefits and reinforcements. Probably the superparticular epicentric solution was more important for him, because its mathematical beauty pervades the entire Perfect System. The principle of dividing the string into two usable parts, on the other hand, could not be applied universally. Be that as it may, again we must observe that the omnipresent mathematical patterns leave barely any place for the consideration of more than the most basic facts of musical practice. No inherent evidence gives us

¹⁵² If the enharmonic was not part of his 'division', Didymus might have provided the size of its intervals explicitly, instructions of how to find them, or merely referred to a 'bisection' of the semitone.

reason to doubt Ptolemy's verdict that Didymus paid insufficient tribute to the tonal structures actually heard in performance.¹⁵³ On the other hand, Didymus himself seems to have regarded his results as sufficiently close to common tunings, or he would hardly have criticised the attitude of earlier Pythagoreans simply to dismiss perception whenever it did not agree with their constructions.¹⁵⁴ Perhaps the discrepancy is due to the considerable advancements of Ptolemy's technical equipment; if we can believe him, no earlier theorist constructed his division on several strings at once, so that the scale could be subjected to the judgement of the senses by playing actual melodies.¹⁵⁵ In this case, the discrepancies between the senses and the constructions of Pythagoreans mentioned by Didymus must have been either considerably larger than those Ptolemy talks about, or of an entirely different kind. Perhaps they concerned not so much interval sizes but facts that fell to the eye more easily, such as the identity or relative pitch of notes from different genera. Archytas' system provides a good example, the relation of its enharmonic to the other genera contradicting the equations that everybody else regarded as obvious, at least from the later point of view.

Ptolemy

Ptolemy sets himself a more ambitious task than anybody before.¹⁵⁶ Firstly, he tries to derive all tetrachord divisions that the musicians used from purely mathematical principles. Secondly, he proposes experiments of truly scientific design by which the identity between the mathematically derived scales and the tunings of citharody could be verified. These experiments are of two types. The first proceeds from reason to perception, by constructing the established ratios on a sophisticated canon of eight strings, so that anyone with musical training could judge whether the melodies from this in-

¹⁵³ Ptol., *Harm.* 2.13, p. 68.16: οὐδέν τι προσποιεῖ τῶν φαινόμενων ἐχόμενον.

¹⁵⁴ Didymus *ap.* Porph., in *Harm.* 26.20–5.

¹⁵⁵ Cf. n. 92 on p. 170 above. It is in fact (pace Barker 1994: 71–2) impossible to play melodies (in the Greek sense: consisting of successive notes of stable pitch) by shifting the bridge of a one-stringed canon. For such an endeavour, one would have had to use multiple bridges in the manner of frets (as on the guitar), with the disadvantage that the change in the tension of the string, effected by pressing it against the frets makes the instrument even less exact. Where the monochord was used in music, it was always combined with a wind instrument of truly melodic capabilities (*Harm.* 2.12, p. 67.16–20).

¹⁵⁶ For a detailed analysis of the scientific method in Ptolemy's *Harmonics*, cf. Barker 2000, esp. 132–57; 243–9.

strument diverge from that of the concert hall.¹⁵⁷ Even stronger seems the argument from the second series of experiments, which starts from data supplied by perception alone. Here the musically trained reader is asked to construct pairs of citharodic tetrachords by ear according to Ptolemy's specifications, in order to compare specific pairs of the thus established pitches. From the results of these comparisons, which Ptolemy trusts to come out unequivocal, he ventures to derive the intervals involved, which emerge as identical with those he has developed before.

Such a derivation is however impossible without one particular assumption, which Ptolemy makes, at this point, tacitly: that all melodic intervals of musical practice are actually superparticular, just as his theory demands it.¹⁵⁸ All his assertions will break down if (a) the intervals of cithara tunings were not necessarily superparticular and (b) the divergences between practical tunings and Ptolemy's constructions were of a size or nature that the musically trained ear tolerated, at least in the context of non-modulating melodies as could be played on the experimental instrument.

Fortunately, many characteristics of Ptolemy's tunings can be confirmed without relying merely on his ear and his honesty. This is possible wherever the tonal relations can be shown to follow some inherent necessity. Thus we will be able to separate different layers, partially along the lines which we know very well by now: intervals that are imposed by basic harmonic frames and by note identification in retuning reflect contemporary tuning practice almost certainly, while for the remaining notes, which can be chosen freely without disrupting such structures, we will have to survey the strength of Ptolemy's tests.

The relations between his six cithara octachords can be studied in Diagram 50.¹⁵⁹ All adhere to the essential harmonic structure that goes back to at least the fifth century BC, with the central 9:8 tone, which establishes fifths and fourths with the extremes. This never violated framework is doubtless one determinative factor, and almost certainly the most important. On the other hand, there is the disjunctive tone that separates the

¹⁵⁷ Ptol., *Harm.* 1.15, p.37.5–20. Since Ptolemy remarks that Didymus' small 'improvement' of the canon does not mend the even more serious deficiencies that arise from not being able to play more than one note simultaneously (*Harm.* 2.13, p.67.22–4 with reference to 2.12, p.67.3–10), it seems clear that he used his own eight-string instrument not merely for plucking out the melodies, but that he reproduced more advanced citharodic techniques. For an Alexandrian public as allegedly consisting of experts on cithara music, cf. Ath. 176e.

¹⁵⁸ This methodical flaw is noteworthy because Ptolemy claims to start only from two common assumptions, namely that the fourth corresponds to a ratio of 4:3, and the tone to 9:8 (*Harm.* 2.1, p.42.8–10); cf. Barker 2000: 2.44–9.

¹⁵⁹ On the two right-hand columns, see also the following note.

	<i>metaboliká</i>		<i>stereá</i>		<i>stereá</i>		<i>metaboliká</i>
	<i>lýdia</i>	<i>parypátai</i>	<i>trítai</i>	<i>trópoi</i>	<i>hypértropa</i>		<i>íastia</i>
9:8	standard diatonic	standard diatonic		7:6	standard		standard
9:8	standard diatonic	standard diatonic		12:11	9:8		9:8
	standard diatonic	standard diatonic		22:21			
9:8	9:8	9:8	9:8	9:8	9:8		9:8
standard diatonic		standard diatonic	standard diatonic	standard diatonic	standard diatonic		9:8
standard diatonic	10:9	9:8	9:8	9:8	9:8		9:8
standard diatonic	21:20				iatonic		iatonic

Diagram 50 Determinative factors in Ptolemy's cithara tunings
(empty intervals are determined by external factors)

tetrachords of theoretical analysis, and ensures the 'consistency' of the scales, their inherent framework. In the diagram, it is shaded. In *lýdia* and *parypátai*, the two tunings that instantiate the 'Dorian octave', it is identical with the lyre framework tone, but in the other *tónoi* they differ, splitting up, according to Ptolemy's diction, into a kind of 'thetic' and the usual 'dynamic' disjunctive tone. Therefore, in the four respective tunings two 9:8 tones are already defined by the fundamental characteristics of Greek lyre tunings and scales.

In the two 'Hypodorian' octachords, *trítai* and *trópoi*, the disjunctive tone defines the traditional position of *kbrōmatiké*. As we have seen, Ptolemy refers to the note by this name without acknowledging its role in chro-

matic music: the necessary 9:8 tone at this position is irreconcilable with a superparticular chromatic *pyknón*. Within Ptolemy's system, chromaticity has retreated into the upper tetrachord of merely one tuning, *trópoi*.

The same *khrōmatiké* is found in *hypértropa*; here, too, enforced by the general tetrachordal rules: the tetrachord of standard analysis extends from *paramésē* (in the 'thetic' terminology of cithara players) downwards, so that its lowest note inevitably comes to stand a 9:8 tone above *hypátē*, just as its highest note stands a 9:8 tone above *mésē*.

In *iástia*, finally, the disjunctive tone lies second from the lower boundary. The lowest tone has thus become the structurally 'highest' interval of its diatonic tetrachord.¹⁶⁰ Its size is therefore no longer determined within the tuning. Nevertheless, its identification as a 9:8 tone is probably ensured by the identification of its higher boundary as the *khrōmatiké* and with the same note in the other tunings. In any case, the regular highest diatonic interval is of the same size, so that there could be little doubt how to determine the note in question. As a corollary, *iástia* is assigned no fewer than four 9:8 tones: the central tone ('thetic disjunction'), the functional disjunction, the *khrōmatiké* tone, and finally the interval above the central tone. The size of the latter follows from the other three, since its upper bounding note stands, as a 'fixed' note, a fourth above the note three steps below, so that the sequence of two 9:8 tones is projected from the bottom of the octave to the region a fourth above. At this point, a 'Pythagorean' tetrachord constitutes itself, revealing one reason why Ptolemy had to admit this non-superparticular division, after all.

This 'Pythagorean' tetrachord – 'ditonic diatonic', in Ptolemy's terminology – stands above the functional disjunction. Thus, the traditional note equations needed for *synēmménon* modulation into the Hyper- scale are granted. Here this is *hypértropa*, which differs from *iástia* only by establishing the *tritē synēmménōn* of the latter (at the expense of its functional *paramésē*: by retuning the *diátonos*, as the citharodes would have put it¹⁶¹). We have already suspected that the designation '*hypértropa*' may be derived from this function, especially because the cithara tunings *iástia* and *hypértropa* reflect the relation between the Iastian and the Hyperastian

¹⁶⁰ Actually, this tetrachord is here cut off at the bottom of the tuning. In consequence, its 'lower' part is realised at the top, since the scales are cyclical in regard of the octave; in other words, they can be conceived as 'wrapping around' it.

¹⁶¹ Cf. pp. 116f. above.

keys of the notation. It was very probably with a view to this connection, that *iástia* was subsumed under the ‘modulating tunings’, *metaboliká*.¹⁶²

The other of these is *lydia*. Here the ‘Pythagorean’ division above the disjunctive tone does not follow from structural axioms, as in the case of *iástia*. Consequently, it must be there precisely for the purpose of modulation, although Ptolemy’s octave schemes cannot give us any further details. Obviously here, too, a *trítē synēmménōn* could be inserted, which led over into the Hyperlydian key. This note is not part of any of Ptolemy’s tables, and, as we have discussed above, it seems to have become more or less obsolete in Roman-period music.¹⁶³ But it may have been used at least in the continued performance of ‘classical’ compositions from earlier times.¹⁶⁴ Our lack of evidence for the note in question could be explained by the fact that such pieces were so well known by the artists that there was little need to write them down. Certainly they formed part of any citharodic curriculum and were thus transmitted orally from master to apprentice. In any case, *hypértrōpa* was also a tuning in its own right – of the extant fragments, seven are unequivocally in the Hyperian key, whereas there is no evidence that Hyperlydian was ever used as an independent scale. Thus from Ptolemy’s viewpoint it was as natural to include the former into his tables as to neglect the latter.

Now we are in a position to realise the very precise meaning in Ptolemy’s justification of his admittance of the ‘Pythagorean’ diatonic in spite of its conflict with his own superparticular principles:

συνυποκείσθω δ' οὖν ἡμῖν καὶ τοῦτο τὸ γένος διὰ τε τὸ πρόχειρον τῶν μεταβολῶν τῶν ἀπὸ τοῦ τονιαίου γένους ἐπὶ τὸ δι' αὐτοῦ μίγμα καὶ διὰ <τὸ> τὸν τοῦ λείμματος λόγον ἔχειν τινὰ οἰκειότητα πρὸς τε τὸ διὰ τεσσάρων καὶ τὸν τόνον παρὰ τοὺς ἄλλους τῶν μὴ ἐπιμορίων, ὅτε κατὰ τὸ ἀναγκαῖον ἐπηκολουθηκότα τοῖς ἐμπύπτουσιν εἰς τὸν ἐπίτριτον δυσὶν ἐπογδοοῖς.
(Ptol., *Harm.* 1.16, p. 40.8–13)

Let us accept this type as fundamental, too, because the modulations from the tonic type to the mixture with it are convenient, and because the ratio of the *leímma* has some intrinsic relation to the fourth and the tone beyond all other non-superparticulars, in that it necessarily follows when two 9:8 ratios come to stand within a 4:3 ratio.

¹⁶² Ptol., *Harm.* 1.16, p. 39.12–14: τοῖς μεταβολικοῖς ἦθεσιν, ἃ καλοῦσιν οἱ κιθαρῳδοὶ λύδια καὶ ἰάστια “the modulating (*metaboliká*) characters, which the citharodes call *lydia* and *iástia*”.

¹⁶³ Above, pp. 96f.

¹⁶⁴ Cf. Limenios’ Delphic Paean, *DAGM* № 21.

Firstly, the practice of modulation between diatonic scales in adjacent keys is brought up.¹⁶⁵ The highest intervals of the involved tetrachord divisions are 9:8 tones (as they were in all previous accounts), which inevitably leads to a succession of two such tones in one of the scales – namely in the basic scale, if the transition is described in terms of *synēmmēnon* modulation. Secondly, the possibility is envisaged that two tones “come to stand” within the fourth, apparently without a modulating context. As we have seen, this is the case in *iástia*, where the superimposition of the citharodic with the tetrachordal framework alone results in an accumulation of 9:8 tones.

Up to this point, Ptolemy’s six cithara tunings are governed by the network of fifths and fourths, which imposes a ‘Pythagorean’ tuning on two of their twelve tetrachords.¹⁶⁶ Of the remaining ten, Ptolemy assigns to nine what he regards as the respective standard division. In the singular chromatic case of the higher tetrachord of *trópoi*, this is the tense chromatic; in all other cases what he calls the ‘tonic diatonic’.¹⁶⁷ The highest interval of the latter is the 9:8 tone (hence its name), which is entirely traditional at this position. No other interval would have been possible anyway, because in five instances it falls together with either the central or the *khrōmatiké* tone. The relative sizes of the two lower diatonic intervals, however, are obviously a matter of free choice, as is the entire chromatic division. Two

¹⁶⁵ Cf. also Ptol., *Harm.* 2.1, p. 44.6–7: τοῦ προχείρου τῆς μεταβολῆς “the fact that modulation is readily available”. The phrase has caused difficulty: *GMW* II: 318, takes τῆς μεταβολῆς in the sense of ‘τὰ μεταβολικά’ with the following, which I do not think is possible (for τὸ πρόχειρον with gen., cf. e.g. Philo, *Plant.* 70; Aelian., *Var. hist.* 14.14); Raffa (2002: 147) translates *metabolé* as “cambio d’ accordatura”, but cf. the sharp distinction between *metabolé* = ‘modulation’ and *harmogé* = ‘(re-)tuning’ drawn in Phryn., *Praep. soph.* 2.4.16–25.9; correctly Düring 1934: 59 and Redondo-Reyes 2002: 187.

¹⁶⁶ At some place, Ptolemy states a kind of ‘rule’ for the arrangement of unequal tetrachords to scales: that the smaller top interval must always stand above the (functional) disjunction (*Harm.* 1.16, p. 39.3–5). This directive is not further motivated; I suggest that it is in fact more of an observation, stated in generalised form because it applies to all combinations actually in use (note the use of ὄταν instead of εἰ). Its basis is not some obscure ‘harmonic’ law, but the simple fact that the tetrachord above the disjunction needs a 9:8 tone at its top in order to ensure a proper *néte synēmmēnon* (projected an octave downwards in the case of *hypértropa*), and that no division with a smaller interval at this position was ever tuned on the instrument anyway. Ptolemy’s exclusively vocal ‘tense diatonic’, on the other hand, sits above the disjunction, as well, because it exists only to substitute the instrumental ‘Pythagorean’ tetrachord, where the latter is enforced by the internal relations of *synēmmēnon* modulation.

¹⁶⁷ That the ‘tonic diatonic’ is not just the most frequent shade but represents the diatonic genus *per se* becomes clear from two passages: at one place Ptolemy presupposes that the reader is able to decode a reference to τὸ ἀπλοῦν διατονικόν, ‘the plain diatonic’, as indicating the ‘tonic diatonic’ (*Harm.* 2.13, p. 68.30); at another point, before he has proposed his own terminology, he takes for granted that the reader interprets Aristoxenus’ ‘tense diatonic’ (i.e. the standard ½–1–1 diatonic) as the tonal structure that he later baptises ‘tonic diatonic’ (*Harm.* 1.14, p. 32.23–7); cf. Barker 2000: 119–20; 131.

tunings, *trítai* and *hypértropa*, are standard diatonic throughout; these are classified as ‘*stereá*’, just as the *lyra* tunings of similar layout.¹⁶⁸

Finally, there is the lower tetrachord of *parypátai*, which is identified as ‘soft diatonic’. The reason for this departure from the standard, however, must be sought not so much in a preference for different intervallic shades, but in the practice of retuning and, probably, once more modulation. Ptolemy derives its size by reference to the corresponding notes in the *stereá* tunings:

οὐδὲ εἰς γὰρ αὐτῶν ἐνταῦθα κекίνηται. (Ptol., *Harm.* 1.16, p. 45.1–2)
for not one of them is altered here.

This assertion makes no sense if read in the context of Ptolemy’s experimental construction, which does not include a corresponding *stereá* division. It refers to the practice of *lyra* tuning, which constitutes the background of the whole chapter: if one proceeds from *trítai*, for instance, to *parypátai*, be it in the course of a modulating piece¹⁶⁹ or during retuning, the pitches in question remain unaltered. Here we have another instance where Ptolemy could not (and had no reason to) overlook a necessary equation between two functionally different notes. As a consequence, the size of the highest interval of Ptolemy’s ‘soft diatonic’ was fixed, and we need to examine further only the relative sizes he attributes to the lower intervals.

With some caution, we are able to determine the different functions of the two ‘Dorian’ tunings, which diverge only in their tetrachordal shades, as regards Ptolemy’s tables. *Lýdia*, as we have seen, is designed for *synēmménon* modulation in the direction of the Hyperlydian *tónos*, and hence perhaps associated more with earlier music styles; on the other hand, its status as the basic scale – as opposed to the modulating ‘Hyperlydian’ – may have granted it a more fundamental role in later music also. *Parypátai*, on the other hand, is oriented towards *trítai*, in the direction of the younger *tónoi*; at the same time, it betrays its secondary state, its intervals being governed by the relation to *trítai*. Consequently, in *lýdia* it is the upper tetrachord whose intonation is perceived as a compromise, while in *parypátai* the lower tetrachord deviates from what is otherwise regarded as the diatonic ideal.

¹⁶⁸ Cf. n. 16 on p. 108 above.

¹⁶⁹ Modulation between the two keys in question is found in Pap. Oxy. 2436 (*DAGM* № 38) and Pap. Oslo 1413a: 15–19 (*DAGM* № 40); cf. below p. 293 and p. 299.

Although Ptolemy gives no direct information about the layout of the Lydian *synēmménōn* tetrachord that is implied by the modulating characteristic of *lýdia*, we can nevertheless infer the pitch he would assign to its *trítē synēmménōn*. In the passage quoted above, the Pythagorean division is expressly considered as practical for modulation with a ‘tonic diatonic’ tetrachord; and indeed this is Ptolemy’s only diatonic division that comes into question. Of the others, only another ‘tonic diatonic’ would provide the required 9:8 tone at the top; but we have seen that Ptolemy admits this kind of division only where he cannot help it. The Lydian *synēmménōn* tetrachord, therefore, would doubtless be ‘tonic diatonic’, with its *trítē* at a small 28:27 semitone above *mésē*.

Thus we have explained the reasons behind Ptolemy’s identification of all tetrachords, but not all the sizes of their particular intervals. The following are not satisfactorily accounted for by the preceding considerations (cf. the dotted circles in Diagram 50, p.196 above):

- (1) the two lower intervals of the standard ‘tonic’ diatonic, i.e. the position of its lower movable note,
- (2) the two lower intervals of the ‘soft diatonic’, i.e. the position of the *parypátē* of *parypátai*, and
- (3) the entire (tense) chromatic division.

In order to judge the reliability of Ptolemy’s figures for these, a close inspection of his method is indispensable. Firstly, we must briefly address the way in which he arrives at his tetrachordal divisions in the first place.

Most of them result from a uniform procedure. At first, all possible divisions of the fourth into two superparticular parts are envisaged; these are $5:4 \times 16:15$, $6:5 \times 10:9$, and $7:6 \times 8:7$. Subsequently, these constituents are divided in turn, and the resulting interval triples are, if possible, arranged in accordance with the general rules for tetrachord shapes. For this second division, Ptolemy does not adopt Eratosthenes’ method of near equal bisection, as one should have expected in the case of the *pykná*. Instead, the near equality algorithm is extended to three parts, of which those two which add to another superparticular ratio are combined, so that the larger of the resulting two intervals is approximately twice the size of the smaller.¹⁷⁰ Ptolemy gives barely any justification for this procedure.¹⁷¹ One motivation

¹⁷⁰ E.g., of the primary division $6:5 \times 10:9$, if $10:9$ is taken as the highest interval of the tetrachord, the lower part is divided $6:5 = 18:15 = (18:17 \times 17:16) \times 16:15 = 9:8 \times 16:15$; the tetrachord is therefore $16:15 \times 9:8 \times 10:9$.

¹⁷¹ Cf. *GMW* II: 307–8 n. 129; Barker 2000: 139–42. Barker, who in several instances supplies better arguments for Ptolemy’s procedures than does Ptolemy, points to the fact that in this way the numeric relations are simpler if higher numbers are associated not with greater string length, but with higher

was apparently that he found the *pykná* obtained thus to be in better accord with the music he knew than the equal divisions envisaged by his predecessors.¹⁷² On the other hand, it enabled him to derive the divisions of all three genera by one and the same method. If the approximate 1:2 relation between the two lower diatonic intervals is transferred to the chromatic and enharmonic, a common rationale of all tetrachord divisions is established for the first time. In consequence, these are sufficiently determined by merely one variable, which is most comfortably expressed as the position of the *likhanós*.

In this way, Ptolemy finds the following well-formed shades (here given in descending order) and associates them with traditional names:

5 : 4	×	24 : 23	×	46 : 45	enharmonic
6 : 5	×	15 : 14	×	28 : 27	soft chromatic
7 : 6	×	12 : 11	×	22 : 21	tense chromatic
8 : 7	×	10 : 9	×	21 : 20	soft diatonic
10 : 9	×	9 : 8	×	16 : 15	tense diatonic

Of these, only the last three are actually relevant for Ptolemy's account of contemporary lyre music. The tense diatonic, he claims, describes intervals used by singers, but not realised on the instrument. The tense chromatic and the soft diatonic, on the other hand, are found in the tables for the lyre tunings; within the six octachords given for the cithara, each of them occurs once. The enharmonic and the soft chromatic must either have been out of use, or have been associated with different instruments. The latter appears more likely considering that Ptolemy very well expects his readers to judge their musical appropriateness, although admitting that they are "no longer similarly familiar to the ear".¹⁷³ It seems significant that we have posited exactly the same opposition for the shades of Aristoxenus: an

pitch. But Ptolemy never calculates in this way, and nothing in the text suggests such an explanation. That Ptolemy adopted the method from an earlier author who dealt not with the canon, but with abstract pitch relations, also seems unlikely. Furthermore, since Ptolemy holds that the intervals were of perceptibly different size (see next note), his procedure is sufficiently motivated anyway; his failure to put forth a sufficient mathematical reason merely underlines the practical relevance of the interval relations – and that Ptolemy probably did not detect the line of argument that Barker later took.

¹⁷² Ptolemy criticises Aristoxenus on that point: Ptol., *Harm.* 1.14, p.32.23–5. Possibly the practice of dividing the chromatic *pyknón* into unequal parts by standard was triggered by the introduction of the small diatonic semitone. At the lower end of the scale, chromaticism was obtained by combining the diatonic *parypátē* with the *khrōmatikē*, a tone above *hypátē*. With the small semitone, this gave a *pyknón* of 63 + 141 cents, which differs from a 1:2 relation as claimed by Ptolemy by a mere 5 cents.

¹⁷³ Ptol., *Harm.* 1.15, p.37.5–20: ἐφ' ἐκάστου γένους "in every single genus"; but 1.16, p.38.2–6: ... τὰ μὲν διατονικά πάντ' ἂν εὐροιμεν συνήθη ταῖς ἀκοαῖς, οὐκέτι δ' ὁμοίως οὔτε τὸ ἐναρμόνιον οὔτε τῶν χρωματικῶν τὸ μαλακόν... Taken literally, this still implies a certain kind of familiarity.

enharmonic and a soft chromatic, reflecting small *pykná* typical for the aulos, in contrast with an originally citharodic tense chromatic. If these distinctions were still valid in Ptolemy's times, he could certainly expect his contemporaries to compare old-fashioned 'auletic' melodies played on the canon with those known from real performances. But he could not base his second set of experiments on aulos music, simply because the fine-tuning of such an instrument to a fixed set of pitches was not part of musical practice. Nor could we expect from him tuning tables for the aulos in its various types, with whose particularities only the experts – then generally of low social status – can have been familiar.¹⁷⁴

All in all, it is not unlikely that Ptolemy vindicated some practical relevance for all of his systematically derived tetrachord divisions. On the other hand, by far the greatest part of the tables consists of diatonic shades that were not gained in this regular way, namely the 'Pythagorean' diatonic, called 'ditonic' by Ptolemy, and his 'tonic diatonic'. We have already explained the admittance of the former. But a clear understanding of the latter is even more important, since this is the form Ptolemy adopts as the standard diatonic. We can imagine how much it had cost Ptolemy to accept this disagreement of the musical standard with his mathematically ideal procedure. When he first introduces the division, he makes up some arguments, but is unable to conceal their *ad hoc* character:¹⁷⁵

ἀλλὰ πρὸ τούτων πάντων τῶν λόγων ὁ ἐπὶ ἡ' εὐρηται καθ' αὐτὸν περιέχων τὸν τόνον ἐκ τῆς ὑπεροχῆς τῶν δύο πρώτων συμφωνιῶν, οὗ κατὰ τὸ εὐλογόν τε καὶ ἀναγκαῖον ὀφείλοντος καὶ τὸν ἡγούμενον ἐπισχεῖν τόπον, τῶν ἔγγιστα πρὸς αὐτὸν συναπτομένων, διὰ τὸ μηδένα τῶν ἐπιμορίων συμπληροῦν μετ' αὐτοῦ τὸν ἐπίτριτον. ὁ μὲν ἐπὶ θ' φθάνει συνημμένος αὐτῷ κατὰ τὴν προεκτεθειμένην διαίρεσιν, ὁ δὲ ἐπὶ ζ' οὐκ ἐπι. διὸ τοῦτον μὲν ἐπὶ τοῦ μέσου τόπου συνάψομεν αὐτῷ ... (Ptol., *Harm.* 1.15, p.36.20–27)

But prior to all those ratios, that of 9:8 is found, in its own right, as comprising the tone, by the difference of the two first consonances [$3:2 \div 4:3 = 9:8$]. So, according to good reason and necessity, it ought to occupy the highest position [in the tetrachord], as well, conjoined with those closest to it, since none of the superparticulars complements it to the epitritic ratio [$4:3 \div 9:8 = 32:27$]. Now 10:9 is already joined to it in the division set out above, but not so 8:7. For this reason, we shall conjoin this one to it in the central location ...

¹⁷⁴ Cf. the various instruments taught to the apprentice in Pap. Berlin 13057 (see Bélis/Delattre 1993).

¹⁷⁵ Cf. *GMW* II: 309–10 n.135; Barker 2000: 142–4; Redondo-Reyes 2002: 488–9 n.304; Raffa 2002: 360.

That Ptolemy had to include some diatonic with a highest 9:8 interval is clear; this norm, set by *synēmménon* modulation, was maintained by all theorists before. Ptolemy conceals such reasons behind a formulation that appears mainly to claim the ‘honour’ of the highest position for the important 9:8 tone, which is missing in the above list. For the central interval, the 10:9 tone would have suggested itself from a mathematical point of view, because it combines with the 9:8 tone to a nice superparticular major third of 5:4. This would result in Didymus’ diatonic, $16:15 \times 10:9 \times 9:8$, which is also entirely consistent with Ptolemy’s general principles. All the more surprising is it that he rejects such a division just for the reason that the same set of intervals is already ‘spent’ for the tense diatonic (although in different order). The choice falls on the septimal tone instead, with the effect that, in addition to the inevitable 32:27 as the sum of the two lower intervals, that of the two higher is the equally unsatisfying 9:7, contrary to Ptolemy’s usual standard of making at least one of these combinations superparticular as well.

For us, Ptolemy’s argumentative pains are an invaluable proof for a musical reality behind his ‘tonic diatonic’. If he had not been forced by the evidence, he would hardly have neglected his favourite ideas in the presence of a mathematically preferable alternative. In combination with other passages, in which Ptolemy presupposes a common awareness of an especially small standard diatonic ‘semitone’,¹⁷⁶ the quoted text leaves no doubt that the citharas within his horizon were tuned differently than one would have expected on the basis of all other treatises: their diatonic *parypátē* was of especially low pitch. This shade was perceived as so natural that the musicians’ language apparently did not provide Ptolemy with a useful term by which he could single it out among the other diatonic variants. The designation ‘tonic diatonic’ is Ptolemy’s invention, as becomes clear from the way it is introduced.¹⁷⁷

¹⁷⁶ Ptol., *Harm.* 1.14, p. 32.23–7; 2.13, p. 68.30; cf. below, p. 215, n. 1.

¹⁷⁷ Ptol., *Harm.* 1.15, p. 36.28–35: κάναυθα δὴ πάλιν ἀκολούθως τῶ μεγέθει τῶν ἡγουμένων λόγων τὸ μὲν συντιθέμενον τετράχορδον ἔκ τε τοῦ ἐπὶ ζ’ καὶ τοῦ ἐπὶ θ’ καὶ τοῦ ἐπὶ κ’ προσάψομεν τῶ μαλακῶ διατονικῶ, τὸ δὲ συντιθέμενον ἔκ τε τοῦ ἐπὶ θ’ καὶ τοῦ ἐπὶ η’ καὶ τοῦ ἐπὶ ιε’ τῶ συντόνῳ διατονικῶ, τὸ δὲ συντιθέμενον ἔκ τε τοῦ ἐπὶ η’ καὶ τοῦ ἐπὶ ζ’ καὶ τοῦ ἐπὶ κζ’, τῶ μεταξύ πως τοῦ μαλακοῦ καὶ τοῦ συντόνου, κληθέντι δ’ ἄν εὐλόγως τονιαίῳ διὰ τὸ τηλικούτων εἶναι τὸν ἡγούμενον αὐτοῦ τόνον. “And here again, in conformity with the size of the highest intervals we will connect the tetrachord consisting of the ratios 21:10 – 10:9 – 8:7 with the soft diatonic, and the one consisting of 16:15 – 9:8 – 10:9 with the tense diatonic, and the one consisting of 28:27 – 8:7 – 9:8 with that which is intermediate in some way between the soft and the tense, and which could reasonably be called ‘tonic’, because such is the size of its highest position.” The crucial ἄν is neglected in almost all translations (an exception is Raffa 2002: 137); cf. Hagel 2006a: 299–300.

Only about a century later, it appears, things had changed once more. In his commentary on the *Harmonics*, Porphyry refers to Ptolemy's 'tonic diatonic' by '*malakón éntonon*', "soft high-pitched tuning", a remarkable combination of terms denoting high and low tuning respectively.¹⁷⁸ The slackening of the *parypátē* string is now perceived as a digression from the norm and marked by the notion of 'soft', which is traditional for tunings with relatively low-pitched movable notes. Possibly Porphyry's term indicates that the shade is still in use, but no longer standard.¹⁷⁹

As regards our general topic, the consideration of the way Ptolemy obtains his tetrachordal shades has shed light only on his 'tonic diatonic', which in all probability reflects contemporary musical practice at least insofar as the 'semitone' in question is audibly smaller than the *lémma*. The validity of the 'Pythagorean' tetrachord in the positions indicated by Ptolemy already followed from more general reflections. The other relevant shades were however derived from mathematical principles by a standardised algorithm. Thus, they may or may not reflect musical reality.¹⁸⁰ Further evidence can only be gathered from an examination of the detailed tests Ptolemy proposes.

These tests adhere to one basic scheme. First, the reader is asked to set up two tetrachords on the eight strings of the canon. Actually any eight-stringed instrument of flexible pitch would do, since no measurements are taken; but scarcely any of the current lyres, harps or lutes would have suited the requirements. Still it may be significant that no sophisticated tool of the type Ptolemy describes is necessary; any arrangement of eight roughly similar strings with movable bridges serves the purpose equally well.

The two tetrachords are to be established so that they share one note. From the relation of two other notes the conclusions are finally drawn. The following capabilities are required in order to reproduce the tests:

- (1) To establish all tetrachords of citharody by themselves (i.e. without the help of other notes that were present on the instruments), starting from any note.

¹⁷⁸ Porph., in *Harm.* 136.23; 154.7; 157.25. For the musical meaning of *έντονος*, cf. Philo, *De sacrif. Abelis et Caini* 37.

¹⁷⁹ Notably, the term *stereá*, used by the musicians of Ptolemy's time for tunings in the standard diatonic throughout, apparently pointed only to the highest interval in the tetrachord, and bore no connotation regarding the placement of the lower movable note; cf. n. 16 on p. 108 above.

¹⁸⁰ For a plausible case of Ptolemy 'beautifying' astronomical data for accordance with numerical aesthetics, cf. Swerdlow (2009).

In those cases where a note stands in a more resonant relation to one outside the tetrachord in question, it is plausible that the musicians used that interval for fine tuning rather than one of those within the tetrachord. In the experimental setting, however, only these are available, so that the skill required by such tests may exceed that which is indispensable for the lyre player.

- (2) To set up two identical notes with an accuracy yet to be discussed.
- (3) To ascertain whether two notes are identical, or which of them is higher.

Here a serious methodological problem is involved. Two pitches can hardly be equal but only undistinguishable for the human ear. Generally two pitches not more than about 5 cents apart are perceived as identical. As a consequence, the accumulated error of each setup must not exceed 5 cents, if identity is the envisaged result – and any experiment that claims to distinguish between pitches so close together is more than dubious.

- (4) To decide whether a given interval is larger or smaller than a 9:8 tone. This is less problematic than it may seem at first, because only superparticular intervals are focussed. Therefore the major tone (9:8) can only be compared to the septimal tone (8:7) and the minor tone (10:9). The respective differences are perfectly accessible to the musically trained ear. Ancient lyre players were probably accustomed to taking 9:8 tones from a given pitch by subtracting a fourth from a fifth within their minds; thus, they could compare the resulting note with that of the tested string.

It is of interest to compare these general considerations with the references to the human auditory potential in ancient authors. Adrastus holds that the 9:8 tone is the smallest interval whose size can be ascertained by ear.¹⁸¹ For Porphyry, on the other hand, no interval smaller than the fourth can be recognised (obviously we have to understand, with significant precision).¹⁸² To distinguish between Aristoxenus' common shades, differences

¹⁸¹ Adrastus (?) *ap.* Theon, *Util. math.* 66.24–67.4: διὰ τοῦτο δὲ πρῶτον διάστημα ὁ τόνος, ὅτι μέχρι τούτου καταβαίνουσα ἡ φωνὴ τοῦ διαστήματος ἀπλανῆ τὴν ἀκοὴν φυλάσσει. τὸ δὲ μετὰ τοῦτο οὐκέτι οἷα τε ἡ ἀκοὴ πρὸς ἀκρίβειαν λαβεῖν τὸ διάστημα. “The reason that the tone is the first interval is that it is down to this interval that the voice keeps the hearing reliable. Beyond that the hearing is no longer able to determine the interval with precision.”

¹⁸² Porph., *in Harm.* 152.18–21: οὐδὲ γὰρ δυνάμεθα ἐπέκεινα τοῦ ἐπὶ γ' διαισθανθῆναι ἄλλως διαφορὰν φθόγγου πρὸς φθόγγον· παχυμερώς γὰρ αἰσθήσεις ἀντιλαμβάνονται. καὶ πῶς ἂν ἐπὶ δ' ἢ ἐπὶ ε' ἢ ἐπὶ κ' ἀντιλήψονται; κάτωθεν δὲ τοῦ ἐπὶ γ' ὡς ἐπὶ τοῦ ἡμιολίου καὶ τοῦ διπλασίου αἰσθανθήσονται... “We are unable to perceive exactly the difference between notes beyond 4:3 [the fourth]. For the senses apprehend but roughly. And how would they apprehend 5:4 [the major third], or 6:5 [the minor third], or 21:20? But below 4:3, they will apprehend: so 3:2 [the

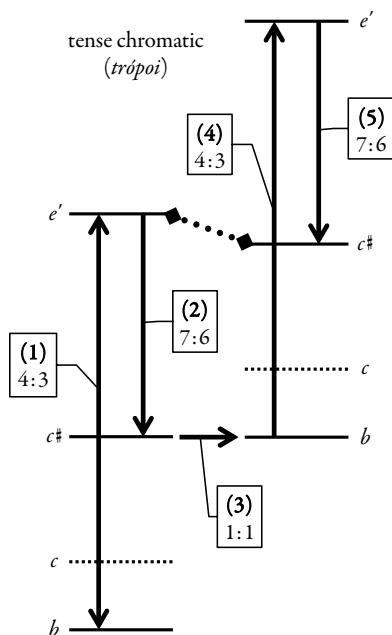

Diagram 51 Ptol., *Harm.* 2.1, p. 42.10–43.8

of 17 cents must be felt significant.¹⁸³ Ptolemy himself finds that the difference between the *lémma* and a true half-tone cannot be heard;¹⁸⁴ this poses a limit of 12 cents. None of these statements, however, defines a precise quasi-experimental context in which to understand them; thus, their implications remain vague. At any rate, they suffice to cure the not uncommon superstition of a superior ancient Greek musical ear.¹⁸⁵

Ptolemy's tests start with the derivation of the major intervals of the chromatic; the position of its lower movable note does not come into focus yet. Diagram 51 displays the five steps necessary if the most resonant, i.e. the largest superparticular, intervals are used in a construction that proceeds

fifth] and 2:1 [the octave]..." Cf. also 155.31–156.3. One of my reviewers rightly points out the possible dependence on Aristox., *Harm.* 2.55, p. 68.10–16.

¹⁸³ It is only in the course of Aristoxenus' discussion of impossible shades that a smaller difference of 8 cents is implied (between the 'misplaced' and the soft chromatic *parypátē*: *Harm.* 2.52, p. 65.12–15). Here his φαίνονται, "appear", seems barely credible.

¹⁸⁴ Ptol., *Harm.* 1.10, p. 24.8–21.

¹⁸⁵ Exemplarily Winnington-Ingram 1932: 206 n. 2: "I believe ... that the Greeks used intervals strange to us with precision."

from interval to interval. In practice, it is certainly useful to compare larger structures instead of concentrating merely on single intervals. Nevertheless, the chosen display gives a good impression of the respective difficulty of the individual tests. In this and the following diagrams, the horizontal arrows indicate at which point the pairs of tetrachords are connected by a common pitch; the bold dotted lines indicate which notes are finally compared.

In the first test it is merely required to tune two septimal thirds (7:6), apart from the obligatory fourths. The resulting pitch difference is large, and there is no doubt that the experiment could and can be carried out with ease. To derive the ratios, Ptolemy needs the additional assertion that the upper movable note (*c*♯) divides the fourth into two intervals each larger than a tone, as well as his implicit assumption that all resulting intervals must be superparticular. It is only this last point which may be doubted. But there is nothing a priori unreasonable in septimal thirds and tones. Such intervals are large enough that their inherent resonance can play a musical role. If so, we would be justified to translate the philosophical paradigm of superparticularity by the musical principle of resonant sound. If the other conditions Ptolemy gives are valid, his figures are indeed very likely to represent a chromatic tuning ideal of his time: no other division within the defined boundaries yields comparable resonance.

The second test establishes the identity of the chromatic septimal tone, which is enclosed by the lowest note and the upper movable note, with the central interval of the standard 'tonic' diatonic. The latter is cited as the lower part of the *stereá* tunings (and not *lýdia*, *parypátai* or *trópoi*). This makes the reference to its position a bit more complicated than it would have been in other cases, but it has two advantages. Firstly, in the *stereá* tunings, the highest interval of the tetrachord falls together with the invariable central 9:8 tone of the harmonic framework. Thus, Ptolemy can refer to its size as something obvious.¹⁸⁶ Secondly, he will return to this septimal tone between the cithara's *mésē* and *diátonos* in the context of the soft diatonic of *parypátai*.

Diagram 52 indicates the steps involved in this second test (actually the first two steps need not be repeated, since the chromatic tetrachord is still available from the previous setup). In contrast to the first experiment, the final comparison shall prove the identity of two notes. Consequently, we should expect that the accumulated error of steps (1) to (4) must stay below 5 cents. It will again be advantageous to adduce the entire tetrachords, even if several notes are in principle redundant. Nevertheless, the test cannot

¹⁸⁶ Ptol., *Harm.* 2.1, p. 43.14: οἱ τε γὰρ ΕΦ ποιήσουσιν ἀκριβῶς τόνον "will produce exactly a tone".

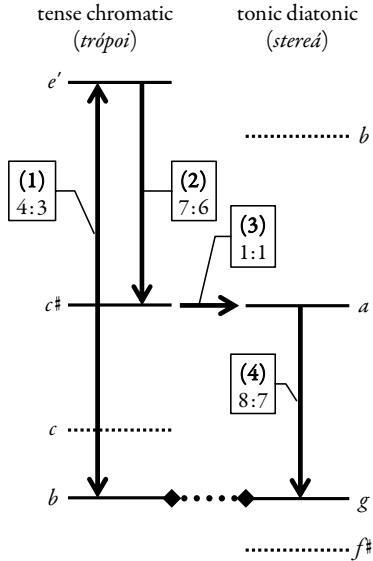

Diagram 52 Ptol., *Harm.* 2.1, p. 43.9–18

possibly work in the strict sense of Ptolemy’s words. The two strings which connect the two tetrachords by definition ($c\#$ and a in the diagram) can be set to ‘identical pitch’ only with the maximally available accuracy: they may disagree by the interval which the experimenter is just not able to discern from identity. Consequently, any digression in the setup of the other intervals may add to this amount; but if it is increased it will necessarily exceed the perceptual threshold. Since it is impossible that all the intervals are tuned with zero error, it follows that a perceived identity of the target notes (b and g) is a lucky coincidence, because the errors were not accumulated. If the test is performed repeatedly, it must fail from time to time.

A series of experiments with computer-generated pitches on a ‘virtual canon’ confirmed this prediction. After acquiring some familiarity with the characteristics of Ptolemy’s tetrachords, the results of my reproductions of his second test ranged between perceived identity (3 cents difference) and an audible interval of a twelfth of a tone (16 cents), with an average deviation of 9.4 cents. Without doubt Ptolemy would have done better; but universally positive results are out of the question, at least if the experiment relies exclusively on aural assessment. In this case we might assume that Ptolemy was content with his results either because he made only a few attempts which worked out satisfactorily, or because he was not disturbed by very

small differences, which he could readily attribute to a failure of perception rather than to a flaw in his theory.

Alternatively, he might have allowed for visual information entering his setup, perhaps half-voluntarily deceiving himself. In my experiments, I soon found it necessary to eliminate all visual information which permitted the comparison of pitches. In order to exclude all non-aural clues, I had to hide not only the figures on the ruler but also all bridges (except for the one I was setting up at a time), and to start from a random pitch (and therefore bridge position) on the first string. Ptolemy could have achieved much the same by starting from randomly tuned open strings. It is however unlikely that he did so. Firstly, he was doubtless interested in being able to read the results directly from the ruler. Secondly, the numbers by which his illustrations are accompanied represent not mathematical comments in the form of ratios but string lengths in hexagesimal notation rounded to minutes. It is quite obvious that they reflect Ptolemy's procedure. Inevitably, then, several visual clues obtruded themselves on Ptolemy's eyes. Firstly, the division of the chromatic fourth into septimal third and septimal tone requires a bridge position exactly halfway between those of the outermost notes. The visual division of a distance into equal halves requires less expertise and may, under favourable circumstances, lead to greater precision than the establishment of septimal intervals by ear.¹⁸⁷ Secondly, while tuning the final note of the second test, it must have been exceptionally hard to withstand the temptation to risk a side glance at the corresponding bridge of the first tetrachord. Especially if one remembered the position of the latter, it must have been almost impossible not to compare it with the figures of the ruler beneath the present string. If this number was, on top of all, identical with the assumed basic pitch, i.e. 120 units, as indeed it is in the experiment we are considering, one cannot possibly avoid remembering it, and consequently noticing whether in the final step the bridge is brought to the mark or not.

As stated above, the second test can be executed with reasonable accuracy, and the foregoing is not to imply that Ptolemy made up his evidence. Certainly he reckoned with others reproducing the experiments. Nevertheless the conditions under which he seems to have carried out his tests have very likely influenced his results, inducing a greater amount of accuracy than would have been possible on a purely aural basis.

Nevertheless we need not call Ptolemy's inference into question. Like the public he addressed, the author was capable of discerning a 9:8 tone

¹⁸⁷ Ptolemy himself acknowledges the great degree of exactness obtainable in visual bisection: *Harm.* 1.1, p. 4.19–22.

from a larger interval. Without any doubt, therefore, the central ‘tone’ of the standard diatonic tetrachord of Ptolemy’s cultural context was larger than a tone. On the other hand, it must have been smaller than a septimal third; otherwise the remaining ‘semitone’ would be reduced to a mere eighth of a tone. Once more, Ptolemy’s septimal interval is the only possible choice within the given range, if resonance is assumed to have played a role. Yet it is not so much the septimal tone itself that contributes to a more resonant lyre tuning. Almost certainly this 8:7 tone was mainly a by-product of the septimal third that arises from the combination of the resulting small ‘semitone’ with a 9:8 tone below the tetrachord in question. Within the citharodic tunings described by Ptolemy, such a tone was always present.¹⁸⁸ Accordingly we should suppose that citharodes established the lower movable note of the ‘tonic diatonic’ primarily by taking a septimal third from that note below.

The third comparison Ptolemy proposes does not really involve a test. For the intervals of the ‘Pythagorean’ tuning, his ‘ditonic diatonic’, he refers to the well-known practice of the citharodes, who “tune so that a tone is effected both by strings A and B, and by strings B and C”.¹⁸⁹ His expression is not needlessly complicated, as one might suppose, but merely exact: the musicians do not tune the tones directly, but these result from alternating fifths and fourths.

The six cithara tunings comprise two tetrachords of this shade. Once more Ptolemy chooses the less straightforward example (at least in our eyes): not the higher tetrachord from *lydia*, in which note names by position and by function coincide nicely, but that from *iástia*. One reason is probably that here again one of the tones is defined by the harmonic framework. It may also play a role that in tuning the cithara the *mésē* was generally taken as starting point. From there, the establishment of the ‘Pythagorean’ part of *lydia* requires two tuning sequences in opposite directions. In *iástia*, on the other hand, one continuous procedure led from *mésē* onwards, so that the nature of the tuning was especially conspicuous.¹⁹⁰

With the ‘ditonic diatonic’ of instrumental tuning, Ptolemy contrasts the shading of “exact character”, which was purportedly used in the vocal melody, obviously notwithstanding the divergence between singer and

¹⁸⁸ Cf. Diagram 50 on p. 196; in the case of the lower tetrachord of *lydia*, a string for *hyperypátē* must be assumed, as we know it from the same tuning in the *koinē hormasiá*.

¹⁸⁹ Ptol., *Harm.* 2.1, p. 44.1–2: οὕτω γὰρ ἀρμόζονται οἱ κιθαρῳδοὶ ὥστε τόνον ἀποτελεῖσθαι καὶ ὑπὸ τῶν ΑΒ καὶ ὑπὸ τῶν ΒΓ.

¹⁹⁰ In *lydia*: (1) *mésē* – *paranētē* – *diátonos* – *trítē* – (2) *mésē* – *nētē* – *paramésē*; in *iástia*: *mésē* – *hypátē* – *paramésē* – *khrōmatikḗ* – *trítē* – *diátonos*.

Fine-tuning

Diagram 53 Ptolemy's tense diatonic

accompaniment.¹⁹¹ The highest interval of this 'vocal' tetrachord was perceived as smaller than a 9:8 tone; so Ptolemy concludes it must correspond to the next smallest superparticular, 10:9. From a musical viewpoint, this shade with its pure major and minor thirds is once more perfectly reasonable (cf. Diagram 53). The difference between cithara tuning and vocal intonation would be explained most naturally by an accompaniment technique that employed thirds more frequently than unison. We shall come back to this question.¹⁹²

Up to this point, all relations in question were accessible by the principle of resonance, which provided a functional explanation for the employed intervals as well as a means of establishing them. The remaining two tests are of an entirely different kind. They deal with the positions of lower movable notes, which define the internal division of the chromatic *pyknón* and the size of the two lower 'soft diatonic' intervals, respectively. The involved differences are minute, and, above all, none of the notes concerned forms a resonant interval with any other note, either within the tetrachord or within the entire tuning of which it is part. Thus, their assessment depended entirely on a second-century sense for 'appropriate' melodic steps (which is hardly within our reach). Moreover, in the case of the chromatic *pyknón* Ptolemy disagrees with his predecessors in making its higher interval twice as large as the lower. Although such a division was already accepted as musically possible by Aristoxenus, no one except Ptolemy regards it as significant, let alone normative.

The soft diatonic *parypátē* is constructed against the background of the 'Pythagorean' tetrachord. As shown in Diagram 54, no fewer than six intervals have to be established by ear before the final comparison can take place. Two are 9:8 tones, which are accessible, for instance, by singing the pitch that stands at a fifth and a fourth, respectively, from the notes in question, while plucking these. This can result in a relatively exact intonation. The

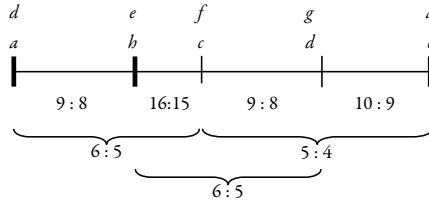
¹⁹¹ Ptol., *Harm.* 1.16, p. 39.12–17.

¹⁹² Below, pp. 241ff.

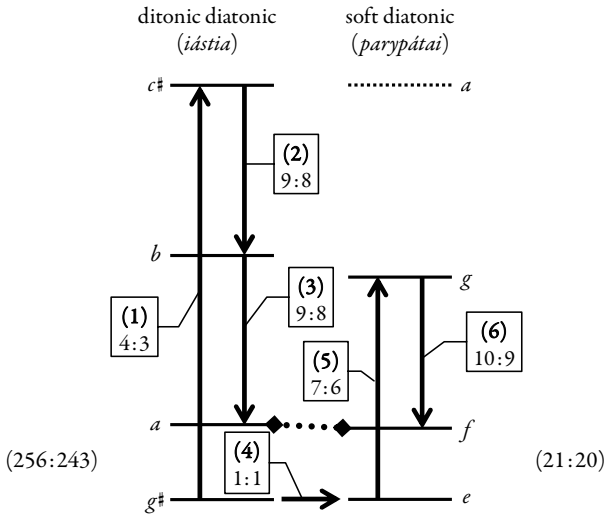

Diagram 54 Ptol., *Harm.* 2.1, p. 44.13–45.10

bounding notes of both tetrachords are identical; still, Ptolemy implies that they are to be tuned again on a different pair of strings. Here a maximum accuracy of about 5 cents is obtainable. Then the soft diatonic tetrachord must be divided into a septimal third and a septimal tone, using the principle of resonance. Here it may be of help that the resulting three notes correspond to a section of the harmonic series, namely the sixth, seventh and eighth overtones. Under ideal conditions, these relations may once more be set up with considerable exactness. Finally, the position of the *parypátē* itself must be determined, which can only be done by comparing the sizes of the semitones, in the absence of usable resonant relations.

The resulting difference between the *lémma* and the 21:20 semitone is tiny; it amounts to a mere 6 cents or the thirty-fifth part of a tone, and is thus on the verge of the audible. Here it is finally impossible that a tuning procedure of six cumulative steps invariably led to the desired result. In this case, Ptolemy's account is therefore misleading.

Two explanations suggest themselves. One is that Ptolemy faked this test, perhaps once more involuntarily. In this case, we should still assume that he found his figures for the soft diatonic to produce a scale that sounded soft diatonic. Consequently, he was aware how the pitch relations had to come out, and would not regard his divisions as satisfactory until the bridge of the soft diatonic *parypátē* was positioned slightly beyond its 'di-

Fine-tuning

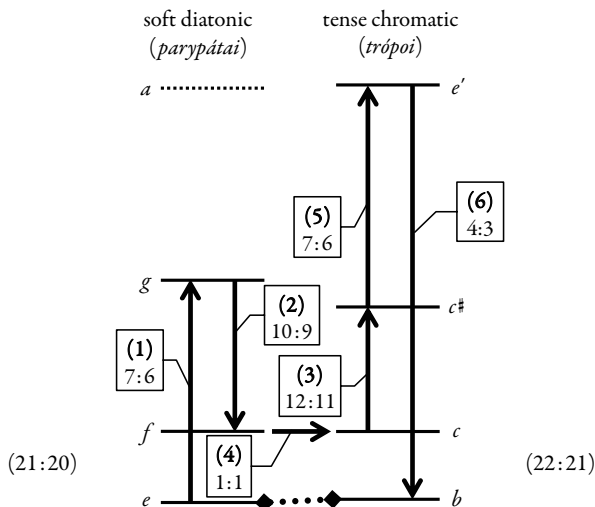
Diagram 55 Ptol., *Harm.* 2.1, p. 45.11–22

tonic' counterpart. This would amount to a perfectly common kind of self-deceit.

Alternatively, Ptolemy might have performed his test by more scientific standards, and indeed always obtained a lower soft diatonic *parypátē*. Then the actual (average) difference between the two notes must have been larger than 6 cents. In this case, the error is hidden within Ptolemy's inference of the interval sizes, which is based on the musically unfounded assumption that even small intervals are more pleasant if they are superparticular.¹⁹³

Both explanations imply that there was actually a considerable range of musically acceptable soft diatonic *parypátai*, at least if considered merely within the restricted context of one tetrachord, or even of the tuning table octachord. Such a less than definite character of this note's pitch concords well with its seeming lack of resonant relations.

Of a similar kind are the problems connected with the final test. Here, however, the experimental setup itself is surprising, because it causes difficulties that could easily have been avoided. Ptolemy's procedure is displayed in Diagram 55: of the previously established soft diatonic, its *parypátē* is taken over as the corresponding note of the chromatic tetrachord ($f \rightarrow c$). Thus, the central note of the *pyknón*, which one would naturally tune last, becomes the starting point. In relation to this pitch, the other

¹⁹³ Cf. Franklin 2005: 46.

three notes, which incorporate resonant intervals, are to be set up. We can hardly assume that anyone was capable of determining the 12:11 or 22:21 intervals with any considerable precision without being able to assess the entire tetrachord. As a consequence, all those three pitches must be adjusted several times, until the desired scale is achieved.

The same result can however be obtained in a much simpler way if the bounding notes of both tetrachords are equated, just as they were in the previous test. Thus, the higher movable note, which stands in the already well-known interval of a septimal third from the highest note, would be tuned first. As a consequence, one would be able to experiment on the division of the *pyknón* by moving only one bridge instead of three.¹⁹⁴ Ptolemy must have been aware of this alternative, if only because he had used the same method just before. Why then, we must ask, did he decide for such an absurdly complicated procedure?

Similarly bizarre is the alleged result of this final test. The purportedly established pitch difference of mere 4 cents does not even exceed the threshold that is generally held necessary for perceiving non-identity. Certainly, the 'identical' pitches of the second test could not have come out closer to each other than these two 'different' ones. This alone would prove that something is wrong here. In any case, a precision of 4 cents after six tuning steps is illusory. In the given form and interpretation, Ptolemy's final experiment is plainly impossible.

One might consider dealing with the inherent contradictions in the same two possible ways as with the preceding test: the results may be faked half-deliberately by the help of visual clues; or they may be based on a methodological error, which would once more imply that the obtained difference exceeds the inferred one significantly. Here, however, the first possibility seems ruled out by the specific layout of the test. If Ptolemy was content to put the bridge where he knew it had to be, he could have maintained the much more reasonable procedure of the preceding experiment. If he had to adopt another approach, he obviously found that his test did not work otherwise. But then we must conclude that Ptolemy was really interested in experiments that would yield the predicted results if reproduced by anyone – and we must transfer this inference to the preceding test, as well.

Thus, we can draw the following conclusions concerning Ptolemy's two final tests:

¹⁹⁴ In the diagram, the following steps would be altered: 4: $f \rightarrow c$ (1:1); 5: $b - e'$ (4:3); 6: $e - c\sharp$ (7:6); 7: $c\sharp - c$ (12:11).

- (1) The soft diatonic semitone was significantly smaller than the *leimma*.
- (2) A plain construction of a soft diatonic and a chromatic tetrachord does not show that the lowest interval of the latter is smaller.
- (3) The complicated procedure proposed by Ptolemy does however yield such a result, obviously by some systematic error.

Regarding the nature of the hypothetical systematic error, we can only guess. Ptolemy's setup forces the experimenter to base the position of the chromatic tetrachord on a first estimate of the large '12:11' semitone. Perhaps in the absence of any context this interval was invariably made too large – if only by Ptolemy himself (after all, he is barely likely to have had his tests tested by others). In this case, the resulting lower semitone would come out too small, if the septimal third and the fourth are tuned reasonably exact. Even if the tetrachord were found unconvincing, one or more small corrections would have led merely to the smallest acceptable lower semitone. Another factor might have contributed: the necessity to move three bridges and therefore re-establish all the intervals during each correction can hardly have encouraged further experimentation, once such an acceptable arrangement was reached.

This proposed mechanism can account for all the stated inconsistencies, if the lower movable notes of both tetrachords were in fact (roughly) equal – just as Ptolemy's figures imply. Then a plain test with two tetrachords of equal bounding notes would have yielded equal lower intervals, if accomplished with precision, or inconsistent results, if carried out less precisely. Only the complicated version that Ptolemy adopts can establish a consistent difference.

In this final case one can barely escape the impression of deliberate fraud on Ptolemy's side. He must have tried the simple version and was without doubt aware of the problem. Still, we must take into account that his method proved able to establish all the more important intervals by reliable and reproducible experiments. Could he be expected to stop so short of completing his ingenious approach? We should take into account that Ptolemy almost certainly believed in his principles. Perhaps he finally succumbed to a very delicate version of the old Pythagorean temptation to accuse perception where it conflicts with theory: he might have felt that the impossibility of establishing the theoretical tiny pitch difference by a plain test was due to his own inability, and thus resorted to a more complicated version that fulfilled the theoretical expectations.

Going beyond Ptolemy?

THE SOFT DIATONIC AND TENSE CHROMATIC SEMITONES

We have found the conclusion inevitable that Ptolemy's arguments, although in all probability providing trustworthy information about the employment of minor resonant intervals in second-century cithara music, fail in the case of those that lack resonant relations within the tetrachord. Thus we must raise the question whether we must leave it at that, perhaps assuming that there was at any rate not much point in standardising non-resonant intervals – or whether we can adduce arguments for specific pitches, perhaps different from those derived mathematically by Ptolemy. Indeed, at least speculations of the latter kind are possible, if only a small part of the foregoing considerations are accepted.

From the text of the *Harmonics*, we have extracted a number of conditions to which our tetrachords must comply:

- (1) The soft diatonic semitone is smaller than the *leímma* of 90 cents by a size that permits the unequivocal assessment of this relation under experimental conditions.
- (2) The corresponding lower tense chromatic semitone is of roughly the same size, perhaps a bit smaller, but almost certainly not larger.
- (3) The same chromatic semitone is significantly larger than the 'tonic diatonic' semitone (of 63 cents). This difference is stated without reference to experimental verification; it is regarded as common knowledge.¹

¹ Ptolemy criticises three of his predecessors for disregarding this fact: *Harm.* 1.14, p. 32.4–6 (against Archytas): τὸν τε γὰρ ἐπόμενον λόγον τοῦ συνήθους χρωματικοῦ μείζονα καταλαμβάνομεν τοῦ ἐπὶ κζ' "we perceive the lowest interval of the familiar chromatic as larger than 28:27"; p. 32.23–7: οὐχ ὑγιῶς ... ποιεῖ ... ἴσα τὰ πρὸς τῷ βαρυτάτῳ φθόγγῳ διαστήματα τοῦ συντόνου διατόνου καὶ τοῦ τονιαίου χρωματικοῦ, μείζονος τοῦ χρωματικοῦ συσταμένου "[Aristoxenus] was wrong in making the intervals to the lowest note of his tense diatonic and tonic

For coherent tests, we must assume a pitch difference of at least 10 cents. A universally recognised difference, on the other hand, cannot have involved less than 15 cents. Consequently, we obtain a very small theoretical range between 78 (= 63 + 15) and 80 (= 90 - 10) cents for the semitones in question. Although we had to deny the methodological adequacy of Ptolemy's relevant tests, this result is for all practical purposes identical with his ratios, which correspond to 81 and 84 cents, respectively. Thus, the musical implications of his superparticular shades are happily confirmed on the basis of ideologically unsuspecting evidence.

Another question is the musical significance of these intervals. No pitch within the range between 63 and 90 cents above the lowest note of the tetrachords forms any resonant interval with any other note within the lyre tunings, with or without *hyperypátē*. Neither the soft diatonic 10:9 minor tone nor the large chromatic 12:11 'semitone' possess desirable qualities within themselves.² At least in the case of the diatonic, a resonant alternative would have been at hand in the form of the small 28:27 semitone, resulting in a septimal third with *hyperypátē*, just as in the 'tonic' diatonic; these two shades would then differ only in the arrangement of the intervals. If instead of this interval, which is otherwise the most common semitone in Ptolemy's tunings, a slightly larger one was used, there must have been good motives. If resonance is out of question, the possibility of some kind of temperament comes to mind: the compromise between two slightly different pitches in order to access both on one string. In our case, one of these would be, just as in the majority of the other tunings, the septimal third above the disjunctive tone below the tetrachord, implying the common 28:27 semitone. For the other, the major third below the top note comes into question, which requires a large 16:15 semitone. The mathematical average between these gives a pitch of $(63 + 112) / 2 = 87$ cents, which differs from the inferred pitch by less than 10 cents. In the case of the tense chromatic, the all too unequal division of the *pyknón* by a 28:27 semitone may have been another reason for shifting the *trítē* as high as possible without entirely destroying the impression of a septimal third. Notably, though, for the relatively high soft diatonic *parypátē* the additional availability of a

chromatic equal, the chromatic actually being larger"; 2.13, p. 68.30-2: [Δίδυμος πεποίηκε] τοὺς ἐπομένους λόγους τῶν δύο γενῶν ἴσους, δέον ἐλάττω τὸν τοῦ διατονικοῦ "[Didymus has made] the lowest ratios of the two genera [i.e., the diatonic and the chromatic] equal, although it is necessary to make the diatonic smaller" (cf. Barker 2000: 131). The first two passages precede the derivations of Ptolemy's shades. Since they include no reference to arguments to be given later on, Ptolemy obviously regards the common knowledge about lyre tunings as sufficient evidence.

² The role of the minor tone in Western music derives from the resonant pure thirds. But in *parypátai*, it is attached neither to a major tone nor to a 16:15 semitone.

reasonable major third to *mésē* seems the only possible motivation. Consequently, we must wonder why such a compromise was sought only here. Probably an answer to this question could be given only if we possessed many more actual scores than we currently do.

MODALITY

Although Ptolemy's account contributes invaluable details to our knowledge of ancient music, it covers only the nature of the intervals of the citharodic tunings. Many questions remain unconsidered. Is each of these *harmogai* associated with one specific musical style, a kind of mode? Or can more than one mode be played on some or on all of the tunings? If there are modes of any kind, which characteristics define them? Are there typical notes of melodic focus, starting and final notes, melodic figures, and preferred intervallic leaps, the latter perhaps also associated with common intervals of instrumental accompaniment?

It will not be possible to obtain answers to all of these questions. Nevertheless there are two ways of approaching some of them at least tentatively. One leads over general considerations to a set of musical relations that are inherent within each of the tunings and might therefore be employed in respective modal music. The other examines the extant melodies, so as to detect relevant relations there. Its scope is however limited due to the scarcity of the material. Only where the results of the two approaches converge will we be able to draw some conclusions.

Focal notes

As the typical 'tonal centre' of ancient Greek music the *mésē* must, and has generally been, considered first. We have already surveyed the evidence for the primary status allotted to it in antiquity.³ There we found reference to a crucial melodic role of *mésē* as well, although dating from five hundred years before Ptolemy. The context of lyre music with its 'thetic' string names is however compatible with Ptolemy's account. If anything of the implied modality survived into the Roman era, we should therefore expect

³ Above, pp. 117 ff.

to find emphasis on the note $\mid <$. That the functional *mésē* of the different keys played some role cannot be ruled out either. Even if functional tonality was originally at home in aulos music, one must reckon with a considerable amount of mutual influence.

On the other hand, we do not expect focal notes to emerge out of the void, but to be grounded in some sort of harmonic context. The more a lyre string participates in resonant relations to its companions, the more is it likely to receive modal importance. Three factors can contribute to the constitution of such a hierarchy, all of which lead to similar results. Firstly, if the instrumental accompaniment is heterophonic, i.e. if different pitches sound simultaneously (either between voice and instrument or also within the instrument), relations of greater resonance are prone to occur on points of melodic prominence. Both heterophony and a fondness for resonant intervals are well attested for ancient music.⁴ Secondly, in the case of melodic intervals we might expect that those occurring with greater frequency tend to be resonant. Vice versa, pure intervals might be a guide to melodically important notes and note relations. Finally, even a single lyre note sounds better the more harmonic relations it establishes with other strings, because these can positively contribute to the overall oscillatory regime of the instrument. A note at the outskirts of the harmonic network, on the other hand, sounds comparatively dull.

All these mechanisms are strongest with simple harmonic relations. Strings with counterparts at the octave are most likely to play an eminent role, followed by those which take part in pure fifths and fourths. We will however not proceed to evaluate the potentials of every single interval now, a more detailed reflection having its place in the study of the single musical documents. In the following considerations, which deal with possible bearings of the harmonic series on the modal structure, we can address the most important points in a more concise way.

Every instrumental or vocal note consists not of oscillations of one frequency, but of a complex mixture of oscillations. Typically the single constituents ('partials') are parts of a harmonic series, i.e. their frequencies represent integer multiples of some basic frequency. The latter is usually perceived as the pitch of the note.

⁴ The proper application of the term 'heterophony' is disputed (cf. now Brandl 2005; Elschek 2005; Schumacher 2005). Its appropriateness for ancient Greek music, however, seems warranted by the fact that the word was invented by the ancient Greeks to describe their music. The testimonies are conveniently collected in Scheltema 1933; for a recent discussion, see Barker 1995. Cf. also Ahrens 1987: 160–2; Collaer 1960.

Where pitch relations analogous to parts of the harmonic series occur within the notes of a musical scale, they can contribute to the perception of a focal note. This is the case with the major chord of Western harmonic music, which incorporates, in its basic form, the relations of the fourth to the sixth harmonic:

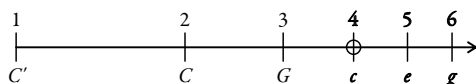

Of these three notes, the octave counterpart of the basic frequency (4) obtains the special status of the ‘basic note’ of the chord, and subsequently of the ‘tonic’, ‘dominant’ or ‘subdominant’ of the harmonic system.⁵

A similar structure of two pure thirds, minor above major, is almost excluded by the general assumptions of ancient Greek harmonic theory. The principle of disjunction demanded a major 9:8 tone between the degrees corresponding to *a* and *b* on the white keys of the piano. Similarly, we have seen that the highest interval of the diatonic was also universally defined as a major tone, so as to establish a pure fourth with *mésē*, an interval that was necessary for modulation and reasonable in regard of the central role of *mésē* in the tuning process. Thus, the lower two notes of the diatonic tetrachord would not comprise a pure major third, and a chord of the type *c*–*e*–*g* became impossible. Furthermore, between *g* and *b* two 9:8 tones came to lie in succession, which precluded the formation of a pure major third as necessary for a chord of the type *g*–*b*–*c* as well. The only ‘major chord’ compatible with the general rules is *f*–*a*–*c*, and indeed the ratios of Didymus’ diatonic create just such a ‘chord’. The corresponding hypothetical focal note, however, the functional *parypátē*, is otherwise isolated harmonically; we ought to take its possible role into account nonetheless.

Within Ptolemy’s instrumental tunings, there is no place at all for pure thirds; thus, any major-chord-based focus is excluded. There is, however, another section from the harmonic series, which they instance several times. In its simplest form it extends from the sixth to the eighth harmonic, comprising a fourth divided into a septimal third and a septimal tone. In one respect, this division of the fourth represents the exact analogy to that of the fifth into the major chord. In relation to the harmonic series, however, it is important to notice that the octave counterpart of the basic note

⁵ That the basic note of the chord is defined by the basic note of the harmonic series, and not by the lowest pitch within the group of three, elucidates from the inversions of the chord, which correspond to the partials 3:4:5 (*G*–*c*–*e*) and 5:6:8 (*e*–*g*–*c'*): here the lowest notes are different from the harmonic focal note.

is here at the top. In order to avoid accidentals, this structure is conveniently based on G :

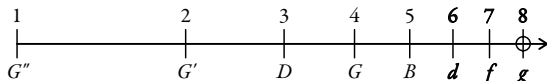

In each of Ptolemy's tunings, we find at least one instance of such a septimally divided fourth. The particular structure is established wherever a 'tonic diatonic' tetrachord sits above a 9:8 tone; it turns out that this is true for all such tetrachords. Only in *parypátai* is there another tetrachordal shade involved. Here the entire structure occurs within the boundaries of a single tetrachord, namely the 'soft diatonic'.

A second look at the tunings reveals another common point: in all cases, the 6:7:8 fourth stands below a 9:8 tone. This is not very surprising, because in almost all cases the tone is merely the regular highest interval of the 'tonic diatonic'; only in *parypátai* is it provided by the disjunction. This tone extends the range that recalls the harmonic series to four contiguous notes:

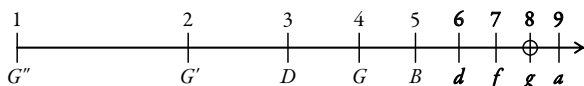

Up to this point, the envisaged musical function of the observed intervallic relation is mere hypothesis, of course. Nevertheless it is the first functional interpretation ever proposed for those second-century tunings, which their complete disregard of major and minor thirds makes seem so curious.

Still, the existence of notes that reflect a rather complicated section of the harmonic series should not make us overlook the more clear-cut relations. These are the combinations of a fifth and a fourth, either as the triad 2:3:4 ($c-g-c'$, for our purposes better written as $e-b-e'$) or as its inversion 3:4:6 ($g-c'-g'$, or $e-a-e'$). Together these erect the fundamental harmonic framework of the lyre, which remained stable for so many centuries: *hypátē* – *mésē* – *paramésē* – *nētē*. Both triads attach considerable importance to *hypátē* CC and *nētē* $\ominus \mathfrak{M}$, which redouble each other at the octave. In the variant 2:3:4, they correspond to the fundamental note also. Without doubt, *hypátē* as the low note must in practice have received greater attention as a possible final. The second variant 3:4:6 contributes to the eminence of *mésē* $\text{I} <$, which here represents the fundamental. Significantly, the reference to the harmonic series is able to account for the otherwise unexplained secondary status of *paramésē* from early times on. If only the concords as such are considered, the 2:3:4 relation, in which *paramésē*

takes part, shows a considerably higher degree of resonance than does its inversion 3:4:6, where the *mésē* is involved. But *mésē* reflects the fundamental, whereas *paramésē* does not. Consequently we should expect the latter's modal functions to include some subordinate relation to *hypátē*, which in turn would be oriented towards *mésē*.

Once the instruments comprised a *hyperypátē* string, a second octave relation was available, wherever the highest interval (*paranētē* – *nētē*) was equal to the lowest (*hyperypátē* – *hypátē*). The standard pitch of the *hyperypátē* was apparently defined as a pure fifth below *mésē* (cf. its designation as *diáemptos*, 'fifth-string' in the *hormasia*). Thus, when the *paranētē* was tuned a fourth above *mésē*, these three notes formed another 2:3:4 relation (*d* – *a* – *d'*), which adds emphasis to *mésē* | <, while attributing possible focal status to *hyperypátē* Φ F and perhaps *paranētē* ∪ L. Among Ptolemy's tunings, this is the case in *lydia*, *parypátai*, and *trítai* – always under the assumption of an added *hyperypátē*, which has no place in the tetrachord and octave structures with which the *Harmonics* deal exclusively.

If the tuning also provides a *diátonos* at an interval of a 9:8 tone below *mésē*, another 3:4:6 triad is produced (*d* – *g* – *d'*). Here the *diátonos* Μ Γ (or Ζ ∞ in non-Lydian tunings) receives the focal potential. The necessary conditions are fulfilled merely by one of the Ptolemaic tunings, namely *lydia*.

Diagram 56 gives an overview of all the discussed notes of possible modal importance. It is generally based on Ptolemy's intervals, except for the triangles, which indicate the hypothetical major-chord focal notes of Didymus' diatonic. Each note in question is characterised by a letter indicating the corresponding modern degree on the white keys. This is useful for reference to a 'mode' in (loose) analogy to the church modes. The letters are enclosed in symbols designating the respective focus-generating mechanisms. Squares are reserved for the relations involving merely octaves, fifths and fourths; those for the most resonant 2:3:4 relations are dotted, while those standing on their edge indicate derivation from a 3:4:6 series. The typical 'Ptolemaic' septimal foci are pointed out by dotted circles.

Especially remarkable are those notes which receive potential focus by more than one mechanism. Judging by these, we ought to expect a special status of 'thetic' *mésē* | < in all *tónoi* from Lydian to Hyperian, creating a kind of 'A mode' in Lydian, 'D mode' in Hypolydian, and 'G mode' in Hyperian. The second Lydian tuning, however, *lydia*, would tend rather to a tonic *G* on the *diátonos* Μ Γ. For Iastian one would similarly postulate a *G* mode, however this time focussing on *hypátē* CC. The *hyperypátē* Φ F might play an additional role both in Lydian and Hypolydian, whereas an influence of *D* may be expected in Hyperian.

Going beyond Ptolemy?

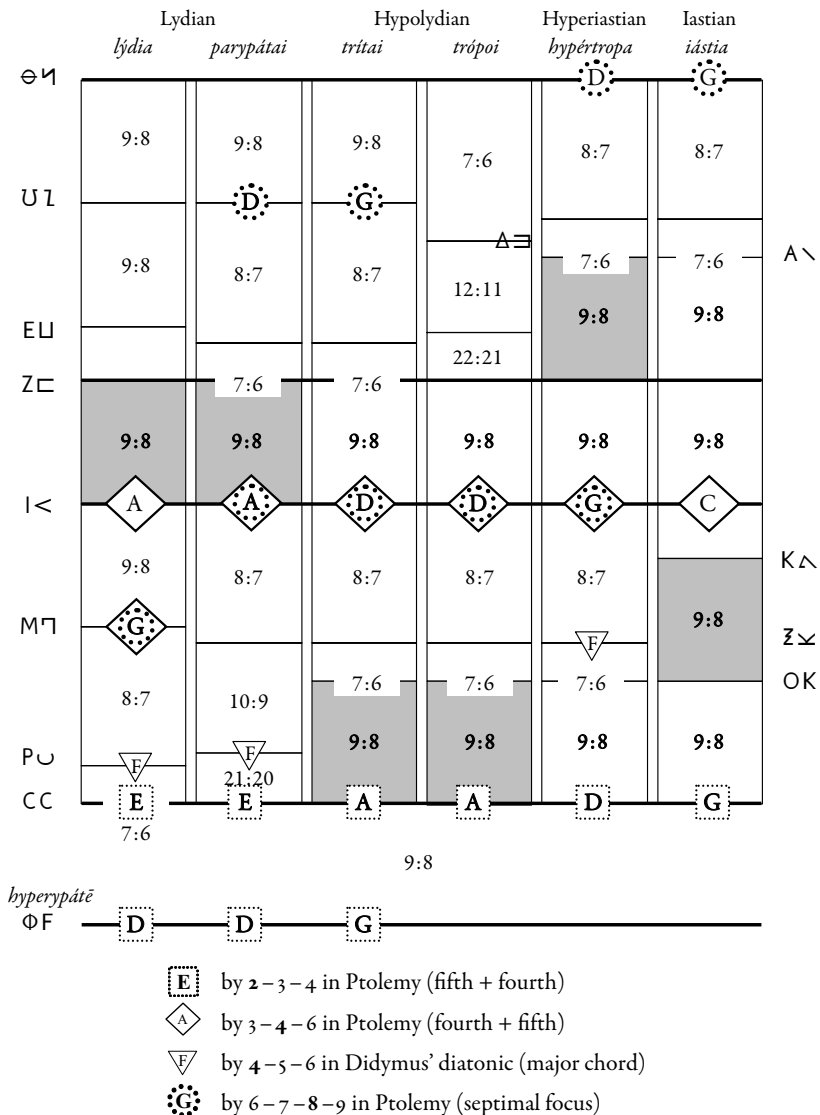

Diagram 56 Possible harmonic-series-generated focal notes in Ptolemy's tunings

These hypothetical results must be confronted with the evidence from the musical documents. We should however bear in mind that even under optimistic assumptions only part of the surviving scores can reflect the

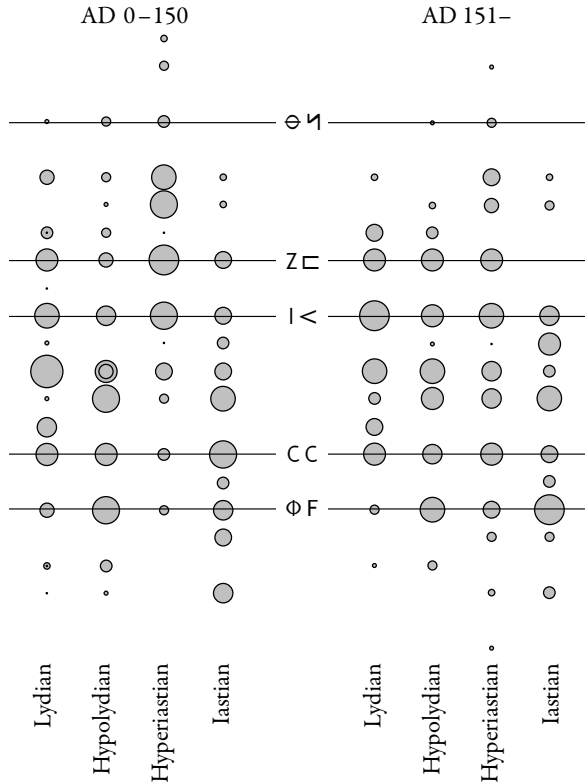

Diagram 57 Relative frequency of individual notes before and after Ptolemy

citharodic style Ptolemy is talking of. The lack of certain criteria precludes the extraction of a subset of probably or possibly citharodic compositions at the present point. Therefore we must be content to classify the fragments according to the dates given in the standard edition.⁶

That there may have been profound changes in the employment of the tonal material already becomes clear from Diagram 57, where the individual notes are represented by bubbles whose areas reflect their relative fre-

⁶ For the present purpose, it is convenient to assign to each fragment the central date of the given probable range (e.g., a date of AD 200 for a document dated to the “2nd – 3rd cent.”). Pieces with modulation are assigned to their ‘main’ key, which is readily defined by the frequency of the distinctive notes. In the following diagrams, the problematic Pap. Berlin 6870, 16–19 (*DAGM* N^o 17) is not included (cf. below, pp. 277 ff.).

quency.⁷ In the two periods under consideration, the first between the musical 'dark age' round the turn of the Christian era and Ptolemy, the second after the completion of his *Harmonics*, the notes appear to have been used differently; in any case, we observe much sharper distinctions in the earlier period. In view of the limited material, certain characteristics of the observed differences are without doubt not due to a general evolution of musical style, but to the character of individual pieces that happen to survive.⁸ Still, where we observe marked disparity, it must reflect some musical reality. In any case, the obviously different character of the post-Ptolemaic evidence clearly suggests that we base our comparison only on those fragments from the Roman era which represent music that was already, and in all probability still, known in Ptolemy's lifetime.

In Diagram 58, the data for this period are combined with our hypothetical focal notes.⁹ The bubbles for the Lydian *tónos* are split between the two Lydian tunings, *lýdia* and *parypátai*. *Trópoi* had to be left out, there being too little evidence for this kind of chromatic music.

In three of the five remaining tunings, our predictions account well for the observed tonality. The most frequent notes of the Lydian key are *diátonos* M Γ and *mésē* | <. The former is the expected focal note in *lýdia*, the latter a probable secondary or alternative focus of the same, but also the anticipated main focus of *parypátai*, the other Lydian tuning. Similarly, *iástia* is most clearly the predicted *G* mode.

On the other hand, the data from Hypolydian and Hyperastian pieces fail to confirm our hypotheses. Perhaps this should not be considered too significant, since material for these two keys is considerably more limited than for Lydian and Iastian, which appear to have been in vogue in the period under consideration.¹⁰ There is also no clear sign of a melodic focus other than the supposed one anyway: in neither of the two keys is there any clearly predominant note. Hypolydian displays an especially flat distribu-

⁷ In the 'AD 151-' part of Diagram 57, the 'instrumental exercises' from Bellermann's Anonymus (*DAGM* № 32-7) with their exceptionally low melodic range are excluded (cf. below, pp. 290ff.). The same is true for Diagram 59 on p. 228 below.

⁸ To be sure, the differences between the two time spans as such are not accidental, as binomial tests for the individual *tónoi* show (evaluated are the diatonic notes from Γ Γ to Θ Ψ native to each *tónos*): for Lydian, $\chi^2 = 169.91$, and the probability of obtaining the observed difference by pure chance is $p = 0.0000$; for Hypolydian, $\chi^2 = 24.02$ and $p = 0.0076$; for Hyperastian, $\chi^2 = 104.12$ and $p = 0.0000$; for Iastian, $\chi^2 = 28.90$ and $p = 0.0013$. Evidence for post-mid-second-century Iastian is especially limited.

⁹ The positions of the bubbles, which are arranged at intervals of equally tempered semitones, according to the nature of the notation, do not always coincide accurately with the notes of the tunings, which reflect the intervals given by Ptolemy.

¹⁰ I count 654 notes in Lydian, a mere 89 in Hypolydian, 286 in Hyperastian, and 353 in Iastian scores.

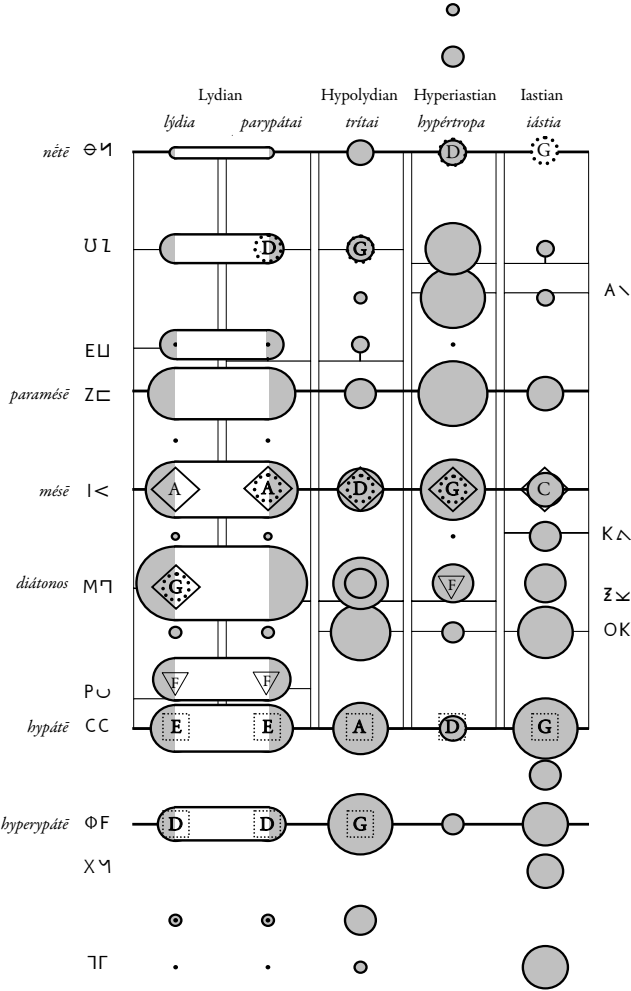

Diagram 58 Possible focal notes and observed note frequency AD 0–150
(for the meaning of the symbols, cf. p. 224 above)

tion over an entire octave, while the extant Hyperastian melodic fragments concentrate upon merely a fourth.

All in all, we can conclude that the musical fragments support the notion of harmonic-series-generated tonics at least for some of Ptolemy’s tuning tables. Thus, the puzzling septimal intervals obtain a very specific function within the harmonic system. On the other hand, the predictions based

Going beyond Ptolemy?

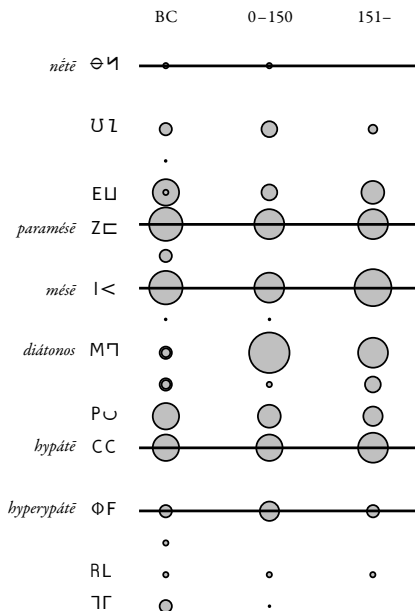

Diagram 59 Evolution of Lydian note frequency

on the pure thirds of Didymus' diatonic find no confirmation whatsoever. As a matter of fact, the traditional harmonic framework of Greek lyre music proves irreconcilable with a thirds-generated focus. Only by recurring to the septimal family of pure intervals could the notes of traditional importance – especially *mésē* and *hypátē* – obtain an additional harmonic support. To these the Lydian *diátonos* must be added, a note for which there is scarcely any evidence before the Roman era. Possibly the Lydian *G* mode was introduced in close association with the septimal tuning.

Interestingly, the preferred tonal ranges are not identical for all keys. While Lydian and Hypolydian share the same ambitus, which is largely identical with that of the cithara, Hyperian and Iastian seem to be associated with diverging standards of melodic pitch. What we have of Hyperian melodies moves within otherwise unusually high regions of the voice. The Iastian evidence, in contrast, fits better within the octave one fourth below our reconstructed standard. Although we must bear in mind that instrumental and vocal range need not always coincide, one might consider the association of these Iastian pieces with a different instrument, be

it an aulos or a long-stringed lyre, perhaps in continuation of the classical *bárbitos*.¹¹

Details of tonal evolution within the same key are difficult to pin down, not only because of the general scarcity of the material, but especially also because different *tónoi* become fashionable in the course of time. Still, the Lydian key was always in use; thus the different weights given to its notes in each of our three periods – Hellenistic, Roman up until AD 150, and after AD 150 – can convey an impression of general trends (Diagram 59). A look at the changing importance of the *diátonos* M \square suggests that the Lydian *G* mode, so prominent in its time, later went out of fashion again. There is good reason to assume that its fate reflects that of the septimal tunings, and thus of Ptolemy's 'tonic diatonic'. We have seen that while in Ptolemy's time this particular shade was regarded as the standard diatonic form, Porphyry already referred to it as a noticeably 'soft' intonation. The flourishing of a *G* mode at the same time as the tetrachordal shade that can create harmonic emphasis on *G* is probably no coincidence.

Intervallic structure

Apart from the mere frequency of the notes, it is the favoured relations between them that characterises the modality of the music. The present chapter is devoted to this aspect of harmonic structure. The purely melodic nature of the ancient notation naturally restricts our survey to consecutive intervals; even so, we may reasonably presume that the simultaneous intervals of instrumental accompaniment were oriented at least partially along identical lines. If we assume in addition that frequent intervals were tuned pure, this is at first merely a hypothesis. It can however gain some probability, if it either leads to a coherent intervallic structure, or if the results are in accord with other evidence.

In this context, the conception of 'frequent' is relative: the very nature of ancient Greek melodies – and, as regards that, those of most musical cul-

¹¹ Measurements on barbitos representations in Maas/Snyder 1989 in accordance with the procedures adopted above for the cithara and lyra (cf. p. 88 above) suggest a string length of about $s = 63.2$ cm, with a standard deviation of $\sigma = 9.16$ cm. It follows that the range of the barbitos was about a fifth below that of the 'ordinary' lyres. The apparent 'lastian' gamut a fourth below the usual range would call for lyres with at least 58 cm open string length. There is some iconographical evidence for instruments of such a size in the period in question (cf. Vendries 1999, pl. 3a; 14.b; cf. also p. 228, fig. 30; on Roman Imperial evidence for large lyres in general, cf. Vendries 1999: 65–6).

Going beyond Ptolemy?

Diagram 60 Pattern codes for intervals

tures – brings about larger rates of smaller intervals, while on the other hand divergences from pure tuning are perceived much more strongly in the larger intervals of octaves, fifths and fourths. Thus even a comparatively small sample of fifths must be regarded as significant, whereas only an outstanding occurrence of thirds at a certain position in the scale can have any bearings on our conclusions. For the present study, especially fifths, fourths and thirds are relevant. Octaves tell us little about the internal harmonic structure of a modal scale; and sixths are very rare anyway.

For the sake of convenience, in the following diagrams the intervals are pattern-coded (Diagram 60). The widths of the individual lines represent the absolute number of occurrences. Direction is indicated by the colours of the ovals at both ends: the melody proceeds from the white to the black end. The material for each key is first presented in a straightforward order of ascending pitch. Here the entire melodic contextualisation of each note can easily be assessed by help of the dotted grid that extends from each note symbol, and on which the ovals sit.

Before we proceed, a word of caution is once more required. Because of the extremely limited nature of the evidence, it is barely avoidable that the few better-preserved pieces imprint their individual characteristics upon our conclusions. Only partially will we be able to counterbalance this effect by pointing to harmonic features which are undoubtedly shared by more than one composition. But we have to take what we get, regardless even of the quite diverse types of music that we inevitably lump together by classifying only according to keys. With all this in view, we ought to be extremely careful with general assertions.

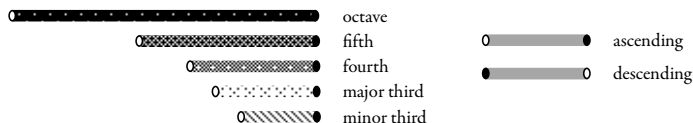
Lydian

Our orientation towards Ptolemy's tunings suggests confining the survey once more to the first 150 years of our era, at least in a first step. Within this period, music in the Lydian *tónos* is best attested. The intervals that characterise it are collected in Diagram 61. It becomes evident at first glance

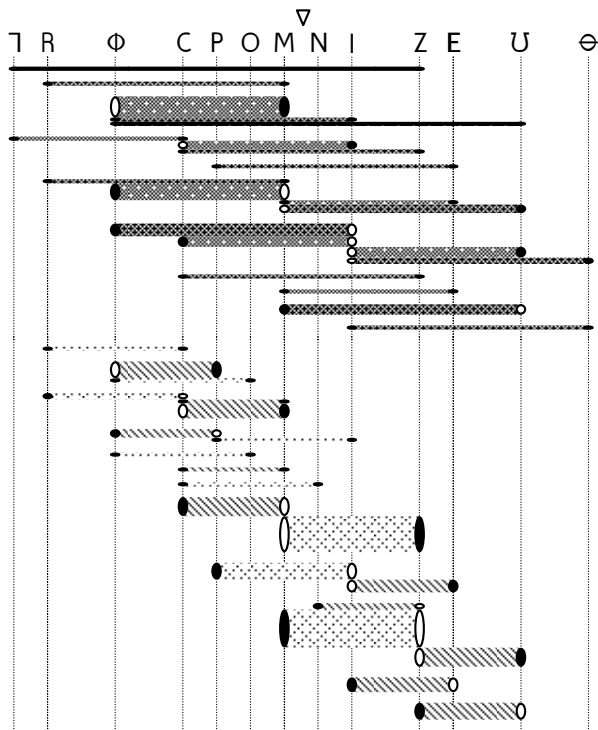

Diagram 61 Intervals in Lydian melodies AD 0–150

that their distribution is by no means accidental. While many kinds of melodic movement are scarcely attested, there are a number of favourites, which obviously depend on factors other than merely the preferred vocal range. Interestingly, the direction of the intervals plays little role. Only for the falling fifth from *mésē* $\Gamma <$ down to *hyperypátē* ΦF do we come across merely a single rising counterpart. Among the thirds, one encounters one significant relation, namely between *diátonos* $M \Gamma$ and *paramésē* $Z \square$; we will shortly discuss the serious problems raised by this preference.

The internal logic of the intervals can be grasped more easily, if they are arranged in structural groups, as in Diagram 62. Here it becomes obvious that the most conspicuous fifths and fourths contribute to identical modal relations by forming pairs that combine to octaves. The most frequent fifth between *diátonos* and *paranété* ($M \Gamma - U L$), for instance, appears as structurally associated with the most frequent fourth between *diátonos* and *hyperypátē* ($M \Gamma - \Phi F$). Both implement a relation to be described as ‘*G–D*’.

Going beyond Ptolemy?

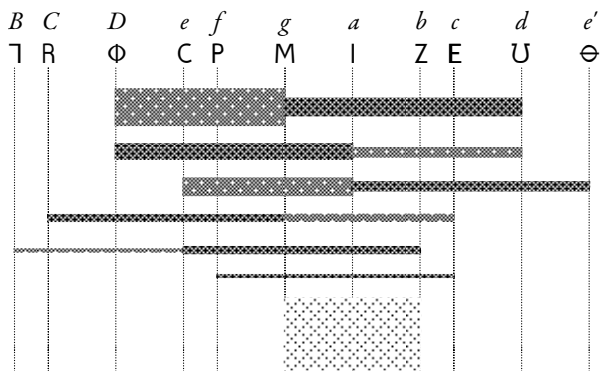

Diagram 62 Harmonic structure of Lydian melodies AD 0–150

This is evidently the harmonic basis of the *G* mode that we have associated with Ptolemy's *lydia* above. Once more it seems that Ptolemy's *lydia* is more of a standard Lydian tuning than his *parypatai*. The next two pairs centre on *mésē* | <, establishing frameworks of *A–D* and *A–E*. These at least may be connected with the presumed *A* mode of *parypatai* – but not unequivocally so, because we recognised a possible secondary harmonic axis of *A–E* in *lydia*, as well. Finally, the *A*-centred divisions of the octave bear the unmistakable traces of the *A* mode of Hellenistic and even older music, relating the old focal *mésē* with *hypátē* and *nētē* on the one hand, with *synemménē* and *hyperypátē* on the other.

All the more remarkable is it that the music from the early Roman era no longer features the entire old framework of *harmonía*, which also included *paramésē*, alongside *hypátē*, *mésē* and *nētē*. This traditional tetractys, which still governs the analysis of Ptolemy's tuning tables, has in common Lydian practice been replaced by another group, of similar internal structure, but one tone lower: *hyperypátē* – *diátonos* – *mésē* – *nētē*. This replacement may be seen as analogous to the downward shift of one tone that the focal note has undergone.

What does the evidence from the musical documents imply for Lydian fine tuning? Quite obviously, a network of fifths and fourths governs the relative pitches of the notes corresponding to *d*, *e*, *g* and *a*. To these we might add *c*, although with little confidence, whereas the inclusion of *b* and *f* seems hardly justified. On the other hand, the enormous frequency of major thirds between *g* and *b* strongly suggests that the obvious melodic prominence of this interval should be reflected in some pure tuning. This

possibility is supported by the general consideration that the establishment of another resonant interval with the focal *g* is musically plausible *per se*.

The assumption of such a resonant third between *diátonos* and *paramésē* however precludes a resonant fifth between *paramésē* and *hypátē*, because the relationship between the latter and the *diátonos* is apparently defined as a non-resonant 'Pythagorean' minor third by a sequence of alternating fifths and fourths (*g-d-a-e*). Admittedly, there is nothing problematic about an impure fifth between *hypátē* and *paramésē*, as far as the evidence from the fragments is concerned; we have already observed that they do not highlight this aspect of the old *harmonía*. Yet such a tuning contradicts the very basics of tetrachordal analysis, the core of Greek harmonic theory at least from Aristoxenus onwards: there both *hypátē* and *paramésē* are 'fixed' notes, whose relation is undoubted.

Still, Ptolemy makes no mention of such a digression. This must raise suspicion, since he is otherwise so zealous to provide exact representations of the citharodic scales, and since his account was hitherto in good accord with the tonality of the fragments, especially as regards *lýdia*. And yet, if musical practice did violate the obligatory fixed notes framework, could we really expect Ptolemy to account for such a monstrosity? After all, Ptolemy's innovative spirit was concentrated on original and coherent answers to the traditional question of how to divide the tetrachord, a task that had been set in the fourth century BC. Where Ptolemy criticises his predecessors and proposes his own solutions, he keeps within a field that was generally regarded as open to discussion, since it concerned only those notes that were universally agreed to be 'movable'. To account for a musical practice that deviated from the most basic standards of tetrachordal analysis would have demanded an entirely new harmonic theory. Such an enterprise was beyond the horizon of any writer after Aristoxenus. If such a fundamental discrepancy between theory and tuning practice did exist, there were only two ways of coping with it: either to incriminate practice as violating the standards (this is Aristoxenus' attitude), or to pass over the whole affair tacitly.

Interestingly, the note in question is never subjected to any of Ptolemy's tests. That the upper tetrachord of *lýdia* conforms to the 'ditonic diatonic' is taken for granted. This form of tetrachord is used in the course of the tests, but even here the reference to the common tuning method suffices to prove its shape: from the upper boundary, two consecutive tones are constructed downwards.¹² Notably, at this point Ptolemy refers not to *lýdia*,

¹² Ptol., *Harm.* 2.1, p. 43.19–44.5.

but to *iástia*, the other tuning that contains such a tetrachord. But his argument can be transferred to *lýdia*, as well. Our evidence from the fragments confirms that its *nētē* (*e'*) is part of the same 'Pythagorean' tuning series as the 'movable' *paranētē* (*d*) and, possibly, also the *tritē* (*c*): thus, the upper tetrachord of *lýdia* is indeed filled by constructing two consecutive tones from its highest note – in a procedure, in which its lowest note, *paramésē*, does not take part at all. Consequently the internal structure of the tetrachord is sufficiently defined as 'ditonic diatonic', just as Ptolemy claims – if only the tetrachord is really bounded by a fourth, which he does not and cannot call into question.

It emerges that the possible mismatch between theory and practice we have detected need not disrupt an otherwise plausible connection between the latter and Ptolemy's tables: conceivably these diverge from citharodic reality only in that single note of *paramésē*, whose pitch Ptolemy was forced to take for granted. In any case, if one follows Ptolemy's argument and even carries out his tests, the difference will go unnoticed.

If the *paramésē* of *lýdia* was 'out of tune', according to the standards of Aristoxenian theory, one question remains: was Ptolemy himself aware of the discrepancy? The only hint in this direction is the fact that he decided to treat the 'ditonic diatonic' rather by reference to *iástia*, where, as we shall see shortly, the tetrachordal structure was apparently unmarred. The reference to the basic key would have been more straightforward; the desire to avoid any mention of the troublesome *paramésē* of *lýdia* would provide a motivation for this choice.¹³

Now that it is clear that Ptolemy's work is not entirely incompatible with a non-standard Lydian *paramésē*, it is time to inspect the plausibility of such an assumption with mathematical means. Up to this point we have relied on relative frequencies without asking for their significance in the full statistical meaning of the word. But in order to take full advantage of the available material, we must pose the question, which of its characteristics might be due to chance, and which are most probably not, so that our conclusions are as reliable as possible.

A mathematical assessment of significant interval frequencies requires the definition of expectation values, which indicate how often we would

¹³ Another conceivable motive for selecting *iástia* could be the wish to equate, for the purpose of the tests, only the pitches of tetrachords that were not of too different pitch in reality. But the equation of the lowest with the highest tetrachord, as would be required in comparing the 'ditonic diatonic' from *lýdia* and the 'soft diatonic' from *parypátai*, is paralleled in the last test, where the same 'soft diatonic' *mésōn* tetrachord is put side by side with the chromatic *diezeugménōn* of *trópoi*.

expect a given interval to occur, if the distribution were governed not by modal hierarchies, but by pure chance. The translation of this rather vague idea into a meaningful formula requires some caution. In short, it must be ensured that the procedure of 'mixing up' the notes does not introduce quite unmusical 'possibilities' such as large random melodic jumps. It is therefore necessary to provide for a possible rearrangement of only the positions of the intervals, while maintaining the other characteristics unchanged as far as possible. In practice, we have to start from (1) the given relative frequencies of the notes (e.g., the proportion of $|\langle$), and (2) the given relative frequencies of the intervals (e.g., the proportion of rising minor thirds). Thus we assume that the choice of the tonal material and the basic nature of melodic movement, as expressed in the occurrence of steps of different sizes, are decisions independent from the intervallic hierarchy we are investigating.¹⁴ Starting from the 'experimental' data obtained from the fragments we can work out a theoretical frequency for each possible melodic progression from one note to another.¹⁵ This 'expected' value can then be compared with the actual occurrences. If there is a conspicuous difference, a simple statistical test can tell us how likely it is that such a difference arises by pure chance. Unfortunately, if any results are to be obtained from the limited material, we must be content with a rather poor level of significance of 10 per cent. We can console ourselves with the fact that the calculation of expectations is necessarily based on the assumption that relative note and interval occurrence is independent from modal interval distribution. This is necessary to ensure unbiased results, but it is cer-

¹⁴ In fact, all three features are interrelated, of course. Nevertheless, their separation is necessary, because it ensures that we can err only on the side of caution: our neglect of their interdependence may cause us to fail to obtain significant results where there is actually a significant relation (which is only a pity); but we will not obtain wrong significant results, caused by factors other than those tested (which would be methodologically detrimental).

¹⁵ The relative frequencies of notes are preferably refined to relative frequencies of each note as the first and the second note of a progression, so that typical initial and final notes enter the calculations accordingly. The task is then to assign expectations to all possible melodic progressions so that the overall distribution is as level as possible, while the mentioned basic distributions are maintained. I have found no straightforward formula that gives such values. Instead, I have obtained them by approximation, starting from a perfectly level distribution and repeatedly modifying it in the necessary directions, until all three conditions are fulfilled: the sum of the expectations of each interval size to equal the number of these intervals in the data; the sum of expectations with each note as first note to equal the occurrence of this note as first note in a melodic progression in the data; and the same for progression-second notes. Thus, the expectations are unbiased in every respect. — An additional problem is posed by modulation, because the succession of two notes that belong to different keys is a priori extremely rare. To avoid distortion from this effect, I have excluded from the data all progressions involving notes that do not belong to the main key of the respective pieces. — Rising and falling instances of the same interval are naturally treated separately; to obtain values regardless of direction, the two respective figures can be added: $E_{|,AB|} = E_{AB} + E_{BA}$.

DAGM [№]	C↔Z	M↔Z	Z↔U	
	e↔b	g↔b	b↔d	
12: Pap. Vienna G 29 825 d–f	1	0	0	BC
21: Limenios, Delphic Paean	5	(4)	0	
24: Invocation of the Muse	1	2	0	?
25: Mesomedes?, Invocation of Calliope and Apollo	0	1	0	
27: Mesomedes, Hymn to Helios	1	12	0	
28: Mesomedes, Hymn to Nemesis	0	10	3	
38: Pap. Oxy. 2436	0	6	11	AD
40: Pap. Oslo 1413a, 15–19; g–m	0	2	0	
55: Pap. Oxy. 3162	0	1	0	
56: Pap. Oxy. 3705	0	2	0	
61: Pap. Michigan 1205	0	0	1	

Table 7 Harmonic context of Lydian *paramésē*

tainly not true: as a consequence, the ‘actual’ significance of any result is certainly higher than the obtained numerical value suggests.

This method can help us in detecting various modal characteristics of Lydian pieces. For the present, however, we concentrate on the question of *paramésē*. Of all intervals that this note forms with others, only one shows a significant variation from what we would expect: fifths between *hypátē* CC and *paramésē* are obviously avoided.¹⁶ This substantiates the suspicion that the Lydian *paramésē* of the Roman era did no longer conform to Philolaus’ *harmonía* with its compulsory resonance between *hypátē* and *paramésē*. Interestingly, the extraordinarily high frequency of major thirds between *diátonos* and *paramésē* itself is not due to a significant deviation from the expectation, but sufficiently explained by the predilection for these notes and for melodic thirds. Even so, its dominance can be regarded as a potential factor in determining the fine tuning.

A closer look at the sources further confirms the picture. Table 7 lists all Lydian fragments that contain any of the relevant melodic progressions from or to *paramésē*. The transition from Hellenistic to Roman times is characterised by replacement of chromatic with diatonic music. In strictly chromatic Lydian, both M \sqcap and U \sqcup are naturally missing, so that the absence of their combination with *paramésē* in the earlier style is trivial.¹⁷

¹⁶ There are $x_{|CZ|} = 2$ observed progressions from CC to ZC or vice versa, where we would expect $E_{|CZ|} = 5.5$. A binomial test yields $p_{|CZ|} = 0.0875$: the probability of observing so few progressions of this kind if they are not really avoided, is merely 1: 11.

¹⁷ The four bracketed instances in the Delphic Paean, DAGM [№] 21, are actually from modulations into Hypolydian, with *g* notated as (instrumental) \sphericalangle , not \sqcap .

	transitions between C and Z	all extant transitions
BC	6	466
AD	1	787

$\chi^2 = 7.095 \quad p = 0.0077$

Table 8 The disappearance of the Lydian *hypátē*–*paramésē* fifth

What is significant is the fact that the subsequent ascent of these thirds went hand in hand with the almost complete disappearance of the *hypátē* – *paramésē* fifth (Table 8). The Invocation of the Muse, which possibly predates the early second-century AD citharode Mesomedes, with compositions by whom it is linked in the manuscript tradition,¹⁸ seems to occupy an intermediate position. This piece is diatonic, and makes (non-prominent) use of the *g–b* third. Nevertheless its opening leap from *hypátē* to *paramésē* proves beyond doubt that this old *e–b* fifth is here still of the highest modal importance.

Later this particular fifth is entirely avoided. The single instance in Mesomedes' Hymn to Helios must actually be discounted. It occurs not within a melodic movement, but between two verses – a position where otherwise even a (clearly dissonant) tritone is found.¹⁹ It is also only natural that the presumed intervallic 'harmony' of the accompanying lyre was not maintained over verse boundaries, and especially that it was not derived, in a most artificial way, from the combination of a verse final note with that of the subsequent fresh start.

All in all, the conclusion is barely evitable that the *paramésē* of *lydia* slightly differed in pitch from the standard that Greek harmonic theory demanded. To reject this conclusion, we would have to reject the underlying hypothesis of a close connection between frequent melodic intervals and lyre tuning and to assume that the characteristic intervals of instrumental accompaniment were different from those of melodic modality; but this would at the same time deprive us of any meaningful interpretation of the observed preferences. On the other hand, it is possible to cite the authority of Aristoxenus for the existence of mismatches between the tetrachordal framework of theory and musical practice already in the fourth century BC (even if we have seen that his words do not necessarily demand such a substantial disagreement as we are considering presently).²⁰

¹⁸ Cf. *DAGM*: 112.

¹⁹ *DAGM* N^o 27: fifth *paramésē* – *hypátē* between lines 20 and 21; tritone *paramésē* – *parypátē* between 15 and 16.

²⁰ Cf. above, pp. 140 ff.

Apparently, then, the triumph of the diatonic *G* mode over the *mésē*-centred *A* mode brought about a major harmonic reorientation. Still, we must bear in mind that most probably the picture drawn by the few surviving fragments does not reflect musical reality too closely. Ptolemy's *parypá-tai* tuning might echo the old *A* mode, whose traditional and well-known music was conceivably less often written down than new compositions. On the other hand, we cannot entirely rule out the possibility that the origins of the *G* mode are to be sought centuries before its first appearance: although there was undoubtedly a large amount of diatonic lyre music already in and before the classical period, nothing of it has come down to us.

In any case, we have seen that we can in all likelihood rely on Ptolemy's *lydia* as regards most of the fine tuning of the Lydian *G* mode by his time. All of the relevant tetrachord-internal pitches are established by trustworthy tests; furthermore, we were able to bestow them with musical meaning: by reference to the harmonic series, as regards the lower 'septimal' part, by the possibility of modulation, as regards the higher tetrachord. The major open question concerns the actual pitch of *paramésē*. In principle, there are two possibilities how it could be altered to produce acceptable thirds both below and above it. Firstly, it could be tuned down by 22 cents, resulting in a pure 5:4 major third to *diátonos* and a pure 6:5 minor third to *paranéte* (potentially combining to a *G* chord in the modern sense). Alternatively, raising it by 27 cents brings about two septimal intervals: a 9:7 'major septimal third' below, and a 7:6 'minor septimal third' above. Only these latter intervals are also found at other places in Ptolemy's lyre tunings; yet they are markedly less resonant than the thirds familiar to us, and they require a more substantial alteration. It is worthwhile remembering that Ptolemy is ready to allow for the smaller difference of 22 cents between a ditone and a pure major third or between a 'Pythagorean' and a pure minor third as "not worth mentioning" in certain practical contexts.²¹ On top of this, our interpretation of Ptolemy's *lydia* as supporting the focal *G* by means of the harmonic series strongly suggests the pure thirds solution. Adjusted in this way, the *paranéte* further extends the segment from the harmonic series:

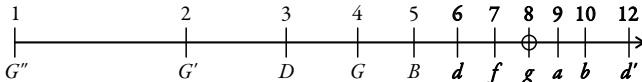

Thus, six out of the nine non-modulating cithara notes take part in this structure. Its concentration on *G* and a hierarchically primary relation between *G* and *D* is balanced only by the old *mésē* – *hypátē* – *nētē* *A*–*E* triad,

²¹ Cf. n. 134 on p. 185 above.

now obviously secondary. Even so, the pivot around which this harmonic dichotomy revolves is the *A* of *mésē*. The single note not embedded in either of these two structures is the *tritē*, *c*.

This *tritē* brings us back to one of the most vexing curiosities of Ptolemy's report: the alleged discrepancy between the pitches of instrument and voice in the inner notes of the higher tetrachord. Where the cithara strings of the *diezeugménon* tetrachord were tuned 'ditonic diatonic', as required for modulation, Ptolemy holds that the citharodes actually sang the pure thirds of his 'tense diatonic', both in *lydia* and in *iástia*.²² The experimental 'test' for this division is based on the observation that the highest interval of the tense diatonic is smaller than a tone, but only by a small amount (βραχεῖ τόνου ἔλαττον), while its central interval is still a tone.²³ Yet this 'test' does not claim similar stringency as the others. These are invariably formulated in the manner of mathematical derivations, their layout being prescribed by the typical perfect imperatives (πεποιήσθω, εἰλήφθω, ἡρμόσθω: "let there be constructed / taken / tuned"), which imply that the demanded constructions are unambiguously defined and can be carried out by everyone who is familiar with the subject. Only here do we read a first-person plural which invites the reader to join Ptolemy's judgement (ἔάν ... ποιῶμεν, "if we construct"). This stylistic difference reflects the fact that the present construction demands different musical skills than do the other tests. These require merely the common expertise of tuning a stringed instrument, relying on the well-known relationship between its pitches; all those who can judge whether a cithara is in tune will agree about the correct layout of the experiment. To reconstruct tonal relationships that otherwise exist only in vocal performance is a completely different thing. Since such an experiment has no complement in musical practice, the required skills were not directly acquired in ancient musical training.

Facing the vague nature of this 'test' and its cautious introduction by Ptolemy, we cannot exclude the possibility that the whole affair was actually invented by Ptolemy for the sake of saving his propositions at least for the vocal part of music. After all, his first account of *lydia* and *iástia* defines them by means of the superparticular 'tense diatonic'; only afterwards, the different instrumental tuning is mentioned. In this passage, too, Ptolemy shows his awareness of the special problems involved in assessing a purely vocal scale. Only here does he point out how his ascription can be substan-

²² Ptol., *Harm.* 1.16, p. 39.12–22; cf. Barker 2000: 154.

²³ Ptol., *Harm.* 2.1, p. 44.6–12.

tiated; all the other tunings will sufficiently be accounted for in the subsequent tests. Still, his argument for the ‘tense diatonic’ cannot but refer immediately to musical perception: if such a tuning is constructed according to the ratios, he holds, one will find that it matches the scale of citharodic song. But would he and the public he wrote for really have been able to reject this tuning, if the citharodes did not actually digress from their instruments’ pitches? The monodic nature of the evidence referred to precludes the evaluation of simultaneous intervals; furthermore, the large intervals of fourths and fifths which become distorted by the ‘tense diatonic’ are comparatively rare in melodic progressions. Much more frequent are melodic thirds, and the main advantage of Ptolemy’s ‘vocal *lydia*’ is the establishment of three pure thirds in the upper half of the gamut. Their effect, possibly reinforced by the generation of simultaneous intervals between the string of the present note and its still vibrating predecessor on the canon – in this form impossible in vocal melody – may have convinced Ptolemy that these were the ‘true’ scales, *lydia* and *iaestia* maintaining their “exact character (*ethos*)”.

On the other hand, we cannot exclude that Ptolemy’s account is based on observation, or even on a commonly acknowledged fact. If it is accepted, albeit cautiously, it has a deep impact on our methodology: the assumption of a simple correspondence between frequent melodic intervals and those of instrumental accompaniment inevitably breaks down, to make way for a much more complicated set of possible relationships. The question of maximum resonance becomes more detached from melodic consecution, and must be treated as concerning (1) relations within the instrument as effected by intervallic strums and (2) relations between voice and instrument, as arising from heterophonic plucked accompaniment.²⁴ As a corollary, the modal structure of instrumental intervallic ‘harmonisation’ might diverge from the melodic focal intervals. On top of this, we have to consider the possibility that the voice departed from the instrumental pitches only under certain circumstances, while remaining in concord with them in other cases. This would enable the singers to take advantage of a maximum of pure intervals, but deprive us of almost all means to extract those from the extant melodies.

Diagram 63 sketches the implications of Ptolemy’s redoubled *lydia*, contrasting a ‘Pythagorean’ lyre with the alleged pure melodic thirds of the

²⁴ Assertions of the impossibility of singing pitches other than those of the instrument (e.g. Redondo Reyes 2002: 512 n. 336) are apparently grounded in the assumption that the vocal note must always be redoubled on the instrument; ancient evidence does not support such a belief.

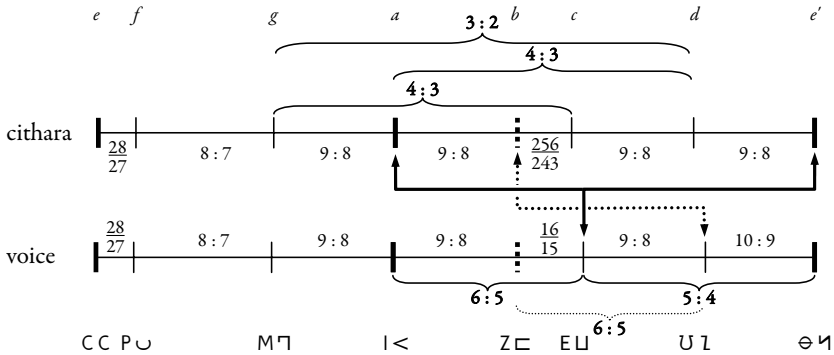
Diagram 63 Ptolemy's instrumental and vocal *lydian*

voice. The resulting pure intervals of heterophonic accompaniment are indicated by arrows. The major impact of the higher vocal notes is a harmonic reorientation of the *tritē* E Λ. On the lyre it is attached to the *diátonos* M Γ; now it appears oriented towards *mesē* I < and *néte* Θ ♯. Fortunately, these are fixed notes, so that melodic consecution and instrumental accompaniment between them and a vocal melodic *tritē* produce the same pure thirds. Thus, we would expect that such a tonal structure as purported by Ptolemy results in comparative melodic prominence of these thirds – or rather of the lower one, since there is no evidence of vocal *néte* in the period under consideration. On the other hand, the modally focal *diátonos* (g), if occurring in the melody, could still be accompanied by pure instrumental fourths (g–c) or fifths (g–d). Thus, Ptolemy's account can be bestowed with musical sense. Maintenance of maximal instrumental resonance with the focal note g is reconciled with an embedding of the inconspicuous melodic c in the modal context of the secondary a, so that a resonant accompaniment of c is possible without resort to instrumental g, thus avoiding an association of the most prominent with the least prominent note.

We can make less of the alleged similar displacement of vocal *paranētē* U Λ. In principle, it would create a pure third with *paramesē* Z □, and indeed we have encountered quite a number of such b–d thirds in the Roman era. Yet the overwhelming prominence of g–b thirds and the simultaneous disappearance of the e–b fifth led us to the assumption of a lowered *paramesē*. Thus, the b–d third should already have been pure, and any alteration of *paranētē* would again distort it. This contradiction is however resolved if we consider the nature of Ptolemy's experiment. Having

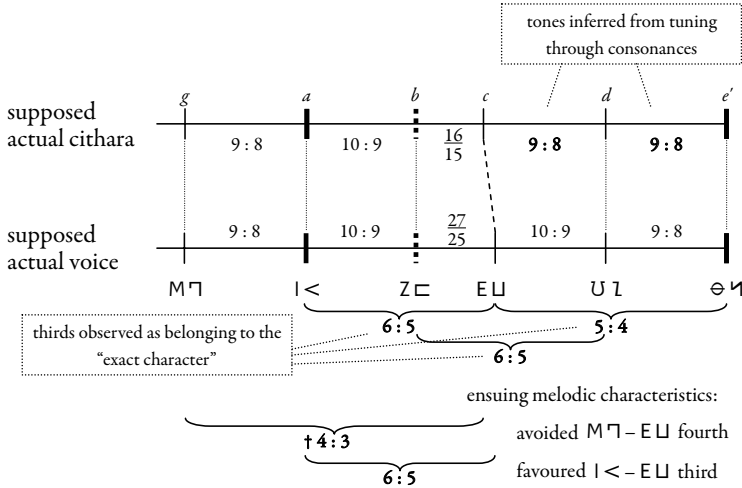
Diagram 64 A possible interpretation of Ptolemy's vocal *lydia*

constructed his 'tense diatonic' on the canon, he would have found that it provided a resonant interval between *paramésē* and *paranētē*, just as appreciated in vocal performance. On the other hand, the recognition that the whole interval is in fact shifted upwards by 22 cents requires the unequivocal distinction of non-resonant sung intervals – and the acceptance of a *paranētē* that violates theory.

It emerges that Ptolemy's 'vocal *lydia*' can be interpreted as the best possible approximation of musical reality in terms of traditional tetrachordal analysis, if this musical reality included both a lowered *paramésē* and a raised vocal *tritē* (cf. Diagram 64). It maintains the very element of the tuning which could easily be perceived as contributing to its "exact character", namely the resonant thirds, at the expense of positing a fictitious smaller tone at the upper end of the scale. Ptolemy's pitches would differ from the actual ones only at two places, and only by the usual 22 cents. The actual mismatch between voice and instrument, on the other hand, would be reduced to only a single note. Ptolemy's account would presuppose a more general awareness of the fact that singers used 'just intonation' in spite of the 'Pythagorean' tuning of the upper tetrachord (today, we might compare the widespread recognition of the fact that string ensembles, for instance, use just intonation, while few would be able to give a clear account of what this means in terms of pitch differences).

The preceding general considerations have left us with two options. Either Ptolemy's account of a distinct vocal 'tuning' is his invention, inspired by mathematical preferences and the pleasant effect of the resulting pure thirds; or these pure thirds were indeed rooted in musical practice, so that their presence or absence became the main criterion for judging the claim of any given division to reproduce the native *éthos* of song in the modes called *lydia* and *iástia*. So far, the decision depends on our confidence in Ptolemy's ability to recognise vocal pure thirds. We have no means to answer this question as such; but one should bear in mind that such a recognition was facilitated by the appearance of similar simultaneous intervals in both contexts: between voice and heterophonic accompaniment in citharodic performance, and by the sustained (if faint) sound of a previous note in plucking the strings of Ptolemy's canon.

The statistics of melodic intervals contributes two points to the present question. Firstly, a progression through the fourth between *diátonos* and *trítē* seems avoided – although we cannot be very sure whether this is significant.²⁵ With much higher certainty, though, a connection between *trítē* and *mésē* appears favoured: such melodic thirds are encountered twice as often as one would expect.²⁶ Both details are parts of the picture which we have above derived as the possible musical meaning of Ptolemy's scenery: the modal detachment of melodic *trítē* from its instrumental association with the focal *diátonos*, and its inclusion into the complex of *mésē*. We can hardly claim that the figures prove the case; but the fact that we find the very two points confirmed in which the pure thirds hypothesis can possibly affect the data is certainly a strong argument for a musical reality behind Ptolemy's account.

It remains to survey the other significant progressions that are found in Roman era Lydian melodies up until the mid-second century. Of the 'Pythagorean' relations, only the fourth between *hyperypátē* ΦF and *diátonos* $M \Gamma$ is conspicuous.²⁷ This is the most typical interval of the Lydian *G–D* modality, and therefore not surprising. Of somewhat greater interest is the favour for rising thirds from *hyperypátē* ΦF to *parypátē* $P \cup$, which is not shared by the falling movements between the same notes.²⁸ This is perhaps a trace of the harmonic series mechanism, in which the upwards movement

²⁵ $x_{|EM|} = 2$; $E_{|EM|} = 5.4$; $p_{|EM|} = 0.0945$.

²⁶ $x_{|E|} = 11$; $E_{|E|} = 5.8$; $p_{|E|} = 0.0331$.

²⁷ $x_{|\Phi M|} = 16$; $E_{|\Phi M|} = 9.9$; $p_{|\Phi M|} = 0.0347$.

²⁸ $x_{\Phi P} = 7$; $E_{\Phi P} = 3.3$; $p_{\Phi P} = 0.0519$. On the other hand, $x_{P\Phi} = 3$, with $E_{P\Phi} = 3.7$.

Going beyond Ptolemy?

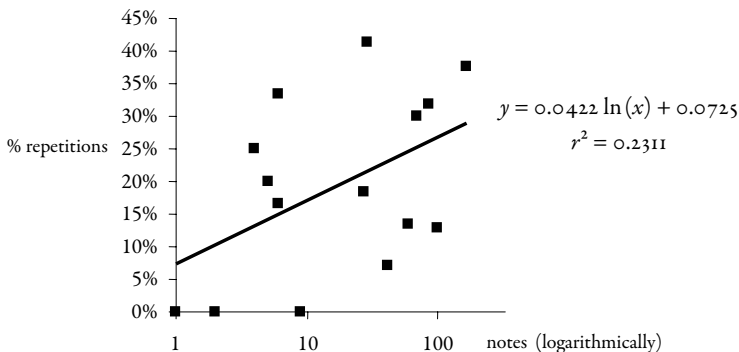

Diagram 65 Note frequency and repetition frequency in Lydian melodies AD 0–150

through the septimal third (6:7) points towards the focal G (8) immediately above.

Remarkably seldom do the melodies move between *hypátē* CC and *diátonos* MΠ.²⁹ This confirms the definitely non-pure character of this third, which we find not only in Ptolemy's *lydia*, but which also follows from the tetrachord divisions of his predecessors. To express it within the paradigm of our interpretation, *hypátē* does not belong within the domain of the harmonic series on G, but to the secondary E–A–C field.

A final aspect of modality is found in the tendency of melodies to use certain notes mainly transitorily, while emphasising others by repeated use. A simple mathematical expression of this kind of prominence is the ratio of repetitions. Although these can in principle be treated as just another instance of 'intervallic progression', it is possible to perform a more powerful statistical test for them.

Naturally one would suspect that the percentage of repeated occurrence is strongly correlated with the note frequency. But this is not the case. In Diagram 65 absolute frequency and ratio of repetitions are contrasted. The widely scattered cloud of points reveals the large amount of independence with which the ancient composers treated the issue of note repetition.

If there were no detectable correlation at all, we could calculate the expectations of repetition for each note simply by multiplying its occurrence with the overall ratio of repetition, which is 25.6 per cent. Yet there is a logarithmic correlation – although a weak one – (it is indicated by the ascending line in the chart), which we have to take into account. The respec-

²⁹ $x_{[CM]} = 1.4$; $E_{[CM]} = 24.6$; $p_{[CM]} = 0.0188$.

	notes (first)	repetitions		expected	<i>p</i>	expected	<i>p</i>
				(simple)		(corrected)	
M Γ	167	63	>	42.8	0.0002	48.2	0.0083
U L	29	12	>	7.4	0.0463	6.2	0.0123
Φ F	42	3	<	10.8	0.0024	9.7	0.0067
P \cup	60	8	<	15.4	0.0211	14.7	0.0256
I <	100	13	<	25.6	0.0028	26.7	0.0008

Table 9 Lydian note repetitions AD 0–150

tive figures for all notes with a level of significance below 5 per cent are listed in Table 9. Apart from the raw data, the ‘simple’ expectation is indicated as well as the corrected value, which ascribes still lower expectations to less frequent notes. Both are accompanied by the respective levels of significance.

We are not surprised to find the focal notes M Γ (*g*) and U L (*d*) once more in the most prominent positions. Similarly, the avoidance of repetitions of *parypátē* P \cup is easily explained by its modal wallflower status. Fascinating is however the scarcity of reiterated *mésai* I <. Quite possibly, it was prompted by the old, but still often-heard modality of the famous Hellenistic classics, in which *mésē* functioned as the focal note. It seems as if the maintenance of a clear *G* mode forbade any stronger emphasis on *A*, whose perception as a tonal centre was so easily elicited.

Hypolydian

The surviving Hypolydian material from the first one and a half centuries of our era is too meagre for statistical evaluation. Diagram 66 is therefore compiled from the respective fragments of the entire Roman era. Below the representation of single intervals, the more eminent ones are compiled into a hypothetical ‘harmonic structure’. The accompanying modern note names are ‘functional’, i.e. they transpose the scale into the natural key, in order to easily retrieve the modal function of each Greek note.

As is to be expected for such limited data, the results have little significance. Still, it is remarkable that all conspicuous intervals are related to *hyperypátē* Φ F, in spite of the existence of other notes that are almost as frequent. This insinuates another *G* mode. In Ptolemy’s account, however,

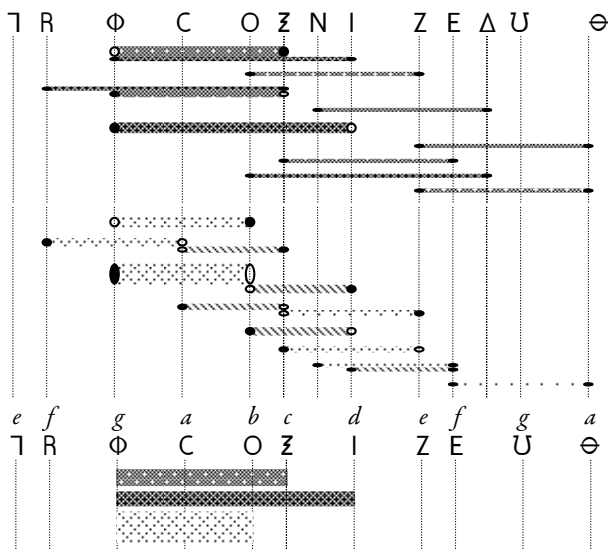

Diagram 66 Intervals in AD Hypolydian melodies

neither the $g-b$ third nor the $g-c$ fourth are pure; this could be explained by the chronological inadequacy of the material.

Hyperiaastian

A more detailed picture emerges for Hyperiaastian, where the fragments from before and after AD 150 can be evaluated separately. Diagram 67 displays the intervallic progressions of the earlier melodies. Their most frequent note is $Z\sqcap$, apparently the tonal centre of an A mode with primary $d-a-d'$ harmonisation. On the cithara, this is the most resonant triad within the old Philolaic *harmonía* ($CC - Z\sqcap - \Theta\upmu$). The prominence of its lower fifth is actually significant.³⁰

Besides, there emerges a $G-C$ relation with a possible focus on ‘thetic’ $mésē$ $l < (g)$, which is connected to a via d . A G mode is what we would have expected from the presence of septimal intervals; on the other hand, the $g-d$ fourth is not pure in Ptolemy’s tables. All in all, we do not obtain a clear picture from the melodic intervals; an investigation of the individual

³⁰ $x|cz|=4$; $E|cz|=1,2$; $p|cz|=0.0329$.

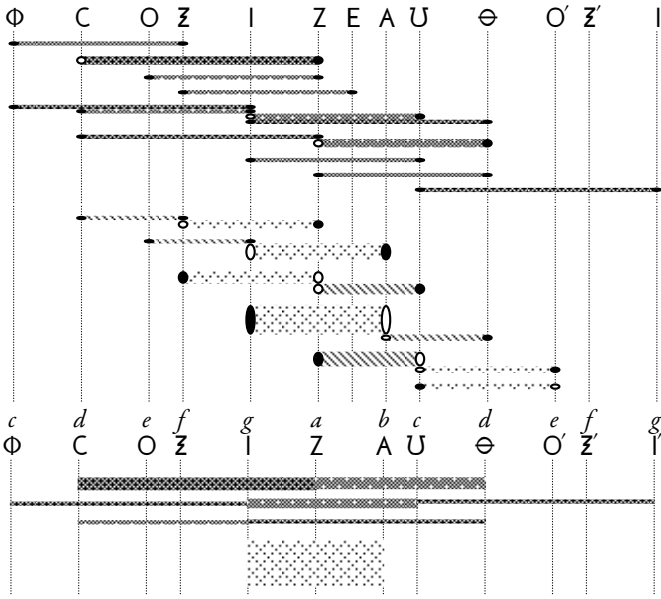

Diagram 67 Intervals in Hyperian melodies AD 0-150

pieces below will indicate that the few fragments in question belong to different modes.

After Ptolemy's time the general impression remains the same, although the $G-C$ domain has become more prominent (Diagram 68). Its two chief notes, $I<$ and $U L$ are also emphasised by frequent repetition.³¹ Several relations appear significant with varying degrees of certainty: frequent beyond expectancy are the fifth between CC and $Z\sqsubset$ ($d-a$), the fourths between $I<$ and $U L$ ($g-c$) and between ΦF and $Z\asyne$ ($c-f$),³² and the major third from $A \setminus$ down to $I<$ ($b \rightarrow g$); in contrast, the fourth between CC and $I<$ ($d-g$) and the third between OK and $I<$ ($e-g$) seem avoided.³³ All this does not combine to a coherent picture of a single modality: together with the general relations, the ambiguity of the earlier Hyperian data is preserved, as well.

³¹ $x_{II}=18$; by the more powerful test for repetitions, $E_{II}=12.5$, corrected to $E_{II}=12.6$; $p_{II}=0.0692$; $x_{UU}=11$; $E_{UU}=7.0$, corrected to $E_{UU}=6.6$; $p_{UU}=0.0562$.

³² Note in this context that repetition of $Z\asyne$ seems avoided: $x_{ZZ}=2$; $E_{ZZ}^*=6.8$, corrected to $E_{ZZ}=6.4$; $p_{ZZ}=0.0325$.

³³ $x_{|CZ|}=6$; $E_{|CZ|}=2.5$; $p_{|CZ|}=0.0442$; $x_{|IU|}=13$; $E_{|IU|}=8.1$; $p_{|IU|}=0.0685$; $x_{|OZ|}=8$; $E_{|OZ|}=3.8$; $p_{|OZ|}=0.0374$; $x_{AI}=9$; $E_{AI}=5.2$; $p_{AI}=0.0779$; $x_{|CI|}=4$; $E_{|CI|}=8.1$; $p_{|CI|}=0.0898$; $x_{|OI|}=7$; $E_{|OI|}=12.0$; $p_{|OI|}=0.0948$.

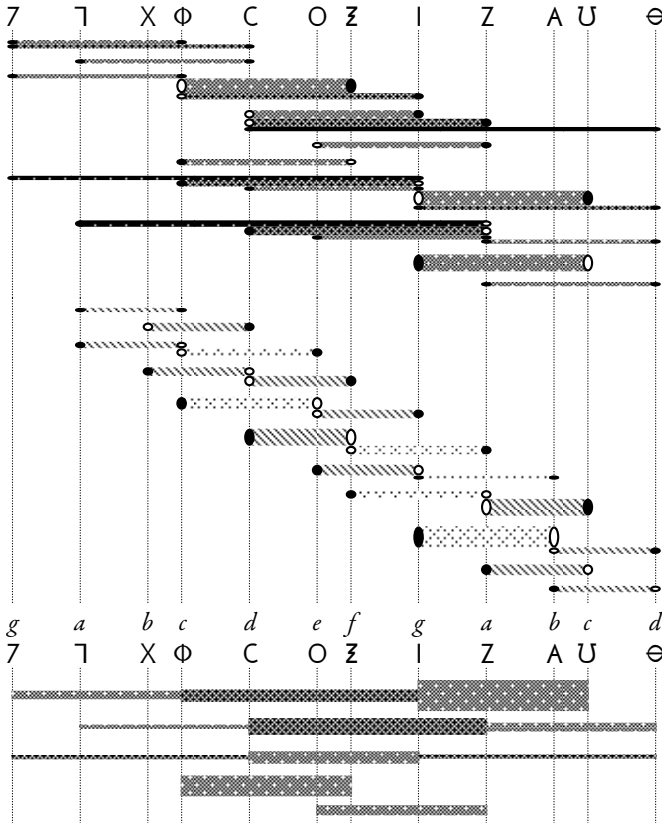

Diagram 68 Intervals in Hyperian melodies after AD 150

Even so, the development of interval use perhaps shows the vestiges of the Ptolemaic septimal tunings becoming extinct. Of the Hyperian melodic fourths from before Ptolemy that fall within the octave of his *hypèrtropa*, twelve out of fifteen are pure according to his figures, but in the fragments that have been assigned to a later date, only nine out of twenty-two.³⁴ This difference is most easily accommodated by the assumption of the typical septimal intervals becoming obsolescent not long after Ptolemy. The more general tuning schemes (in terms of tones and semitones) of

³⁴ According to Fisher's exact test, $p=0.0204$. Note that one cannot project the figures within Ptolemy's octave onto the intervals outside it: it is for instance not clear whether a *hypèrpátē* of *hypèrtropa* should maintain rather the pure fifth to *mésē* or the exact octave to *paranētē* (which fall together in *lydia*, *parypátai* and *tritai*).

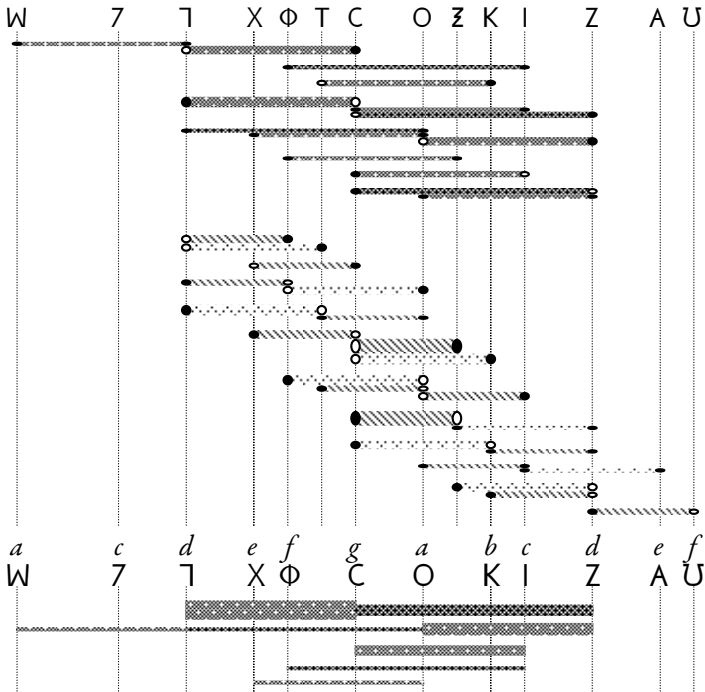

Diagram 69 Intervals in Iastian melodies AD 0–150

course need not have been abandoned together with this particular fine tuning.

Iastian

Almost all extant fragments in the Iastian key belong to the earlier period up until about AD 150. As seen in Diagram 69, they entertain a wide variety especially of thirds, but also of fourths and fifths, among which few predilections surface. These, however, arrange themselves into a neat picture of just another *G* mode, centring on the most frequent note CC – just as we have concluded above. It stands within an octave harmony of the well-known structure $d-g-d'$ ($\text{7}\Gamma - \text{CC} - \text{Z}\square$), which is however located at an unusually low pitch, one fourth below the usual triad *hypátē* – *mésē* –

nētē.³⁵ We have met its constituent fifth CC – Z□ in Hyperastian also. Possibly this common modal characteristic testifies to the more intimate connection between Iastian/*iástia* and Hyperastian/*hypértropa*, which we have suspected on the basis of their related tunings in Ptolemy.

Once more a basic focus on *G* seems to be variegated by an alternative *A*, here apparently incorporated into the same octave of *d*–*d'*, completing a ‘Philolaic’ harmonic tetrad. Its appearance one fourth below the usual citharistic standard pitch reinforces the suspicion that the majority of the pieces in question were played on a different instrument.

The absence of exceptionally prominent thirds precludes an examination of Ptolemy’s claim of a vocal just intonation, as we could carry it out for *lydia* (I leave it to the reader to work out its potential harmonic implications). If the bulk of the Iastian evidence was not written for the cithara, as seems to be the case, Ptolemy’s remarks on citharodic song would hardly apply to it anyway.

³⁵ The modal status of the typical final note ΓΓ is underpinned by frequent repetition: $x_{\Gamma\Gamma}=10$; $E_{\Gamma\Gamma}=4.2$, corrected to $E_{\Gamma\Gamma}=4.4$; $p_{\Gamma\Gamma}=0.0084$.

CHAPTER 7

Assisted resonance

THE RESONATORS DESCRIBED BY VITRUVIUS

According to the Roman author Vitruvius, many Greek stone theatres of his time were equipped with sets of tuned resonating jars, distributed in semicircles around the auditorium, which reinforced certain pitches (wooden theatre constructions as common in Rome, we are told, would not require such resonators, thanks to the elasticity of the material).¹ Smaller auditoria had only one row, which merely emphasised the harmonic framework; in larger ones, two further rows introduced the chromatic and diatonic *likhanoí* (cf. Diagram 70). Vitruvius gives all the details within the terminology of the Perfect System, without specifying a particular *tónos*. It goes without saying that the resonators were of fixed pitch and would not be changed for pieces in various keys. Consequently we are to understand Vitruvius' note names in terms of the 'natural' *tónos*, the Lydian, in the manner that we know from Ptolemy and the *hormasia*.²

Of the three rows, the first is associated with '*harmonía*'. By opposition to a chromatic and the diatonic row, we would expect that this term implies the enharmonic genus. Yet the resonators in question hold neither quartertones nor major thirds, but the 'fixed' notes of the Perfect System, including *nētē synēmménōn* (*d*), but not the *proslambanómenos* (*A*). Thus, the paramount notes of the citharodic octave, primarily its '*harmonía*' *e-a-b-e'*, are supplemented by the fourths below, the fourth above, and those from *mésē* upwards.

¹ Vitruv. 5.5; cf. Landels 1967; 1999: 192–5. On archaeological evidence, Plommer 1983.

² So rightly Landels 1999: 193; in Landels 1967, a Phrygian transcription is assumed "for the sake of simplicity" (86), but later converted to frequencies without further argument, and overlooking the pitch difference between the ancient notes and their traditional systematic transcription (90 Fig. 8).

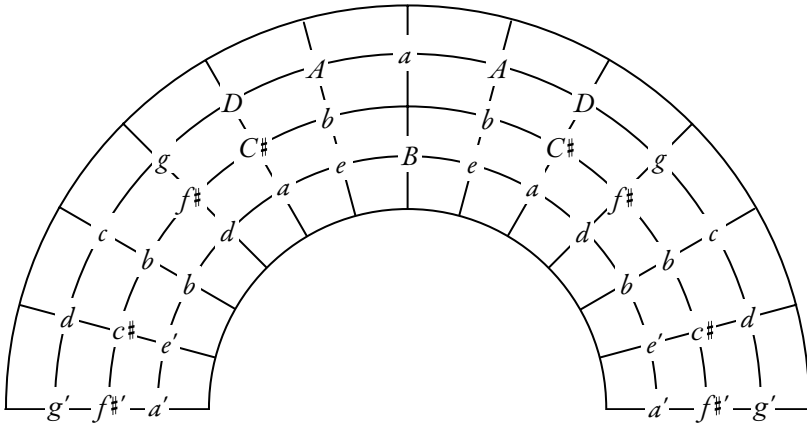

Diagram 70 Location of resonators in a large theatre (Vitruv. 5.5)

The innermost row also represents the resonators used in small theatres.

Perfect System transcribed as: $A-B-C-D-e-f-g-a-b-c-d-e'-f'-g'-a'$

The chromatic row supplies one pair of resonators for each chromatic *likhanós* ($C\#, f\#, b = khrōmatikḗ\ synēmménōn, c\#, f\#$). These are furthermore reinforced by $b = paramésē$ next to the centre, because this is the single fixed note standing in concordant relationship to chromatic *likhanoí* ($f\#-b-f\#$). It follows that the *khrōmatikai* are tuned an exact 9:8 tone above the bottom notes of their respective tetrachords: another example of how intimately connected this form of chromatic is to citharodic practice. We shall see below that the apparent reduplication of the pitch b makes good musical sense.

The diatonic jars in the rear proceed in an analogous way, each being tuned a semitone higher than its chromatic counterpart. The three central positions, however, are occupied by another *mésē* (a), flanked by a pair of *proslambanómēnoi*, an octave lower (A).

INTERPRETATION OF THE RESONATORS

How closely did this particular set of pitches correspond to the requirements of the music that was performed in those theatres? Granted that the performers' instruments and voices were generally in tune with the jars, the notes emitted from the stage would meet various degrees of reinforcement,

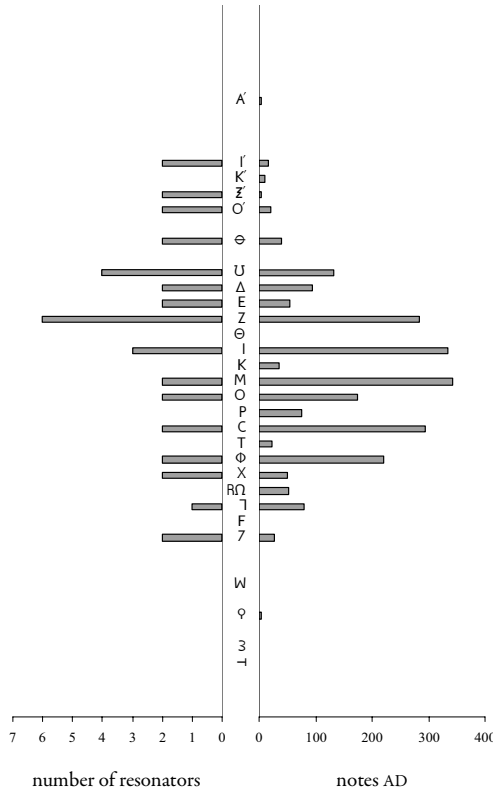

Diagram 71 Theatre resonators vs. notes in the musical documents

matching either one, two, three, four, six, or none of the resonators. Thus it is natural to compare the number of resonators for each note with the occurrences of the notes in the musical documents from the Roman era: compare the facing bar graphics of Diagram 71. The general agreement between the pitch ranges of the scores and the resonators springs to the eye, as well as the fact that the same semitone steps are missing from both. Nevertheless we observe a mismatch in emphasis. While the extant melodies unfold mostly in the lower part of the central octave, the resonators are distributed more uniformly, while their few outstanding pitches occur from *mésē* upwards.

It is not difficult to account for this upwards shift. Any sung note consists not only of its basic frequency, but also its upper partials. The second

Assisted resonance

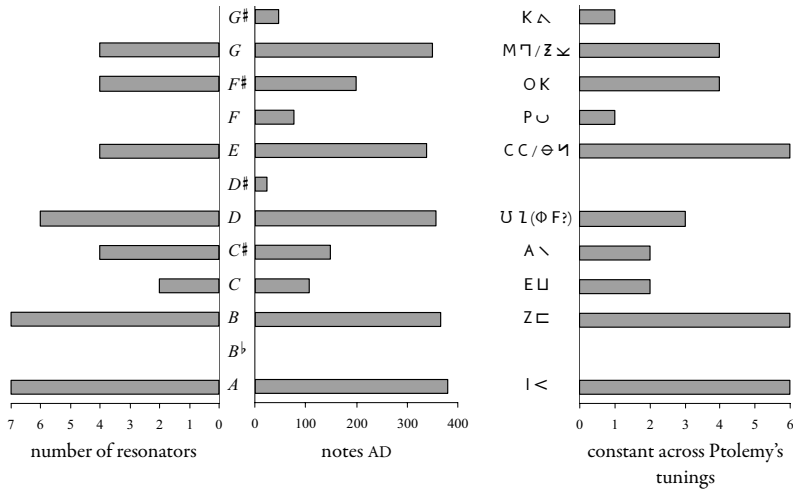

Diagram 72. Theatre resonators vs. notes, within functional octave

partial can excite the resonator one octave above the perceived pitch, a fact well known in antiquity;³ a reinforcement of the higher partials probably appealed to the ancient ear. As a consequence, we can fully appreciate the role of the resonators only if we subsume pitches standing in octave-relations within a single category, thus reducing the notes to their functions (in the modern sense of the word). The results of this procedure are presented in Diagram 72, in the couple of charts to the left.

Now the correspondence between note frequency and the number of resonators is almost exact.⁴ The fact that the functional notes *A* and *B* occur most often perfectly justifies the seven resonators tuned to variants of each of these pitches, while *D* comes next in both respects. Similarly, the absence of resonators for *B^b*, *D[#]*, *F*, and *G[#]* is all but natural. One might perhaps expect *E* and *G* to be better represented; but possibly these participated also in the resonators for *A* and *D*, respectively, especially in those pitched a fifth above the sung fundamentals, whose second partial coincides with the third of the sung note – another good reason to have twice as many resonators for *paranētē*/*synēmμένē* (*d*) than for *hyperypātē* (*D*).

Such a resonance across different functional notes is however possible only where pure fifths are involved. This leads us to the question, to what extent could the resonators fulfil their duty when the singers employed tun-

³ *Anth. Pal.* 11.352; cf. ps.-Aristot. *Pr.* 19.7.

⁴ The correlation coefficient is $r = 0.9233$.

ings that departed from the ‘Pythagorean’, such as those attested by Ptolemy? The chart at the right-hand side of Diagram 72 counts the numbers out of Ptolemy’s six cithara tunings across which the individual notes remain stable (cf. Diagram 50 on p.196 above). It emerges that the correspondence between the more stable notes and the number of resonators is also good; especially the significance of $M\Gamma \hat{=} G$ now decreases to an amount similar to that of $OK \hat{=} F\#$. On the other hand, *D* appears overrepresented from this perspective; but here we must once more make the reservation that we do not know whether *hyperypátē* would always have changed its pitch together with *paranētē*. Similarly, we must wonder whether the *G* resonators would have been tuned a septimal tone below *A*, as demanded by four out of five of Ptolemy’s schemes that contain this note. On top of this, if *paramésē* was sometimes fine-tuned to give pure thirds with *likhanós* and *paranētē*, would this be reflected in some of the *B* resonators? Certainly theatres were not constructed exclusively for citharodic performances. In any case it has become clear enough that the specific design reported by Vitruvius perfectly suits the general requirements of Roman Imperial music.

CHAPTER 8

The extant musical documents

The course we have followed from theoretical reflections and the accounts of ancient musical theory to more practice-related evidence leads us to a consideration of the individual musical fragments.¹ Naturally here is not the place to print these in full transcription; fortunately they are readily accessible in the new standard edition (*DAGM*), whose arrangement is maintained in the following. For the most part, only a short commentary on aspects of their scalar, and partially their modal structure is possible. Often this will be merely a summary of what has been said in the foregoing chapters; in a few cases, though, we will get hold of one or the other additional detail of value.

INDIVIDUAL SCORES

DAGM N^o 3

Pap. Vienna G 2315

3rd – 2nd cent. BC

This is the *Orestes* papyrus, which provided the earliest evidence for modally indifferent notation of ‘Dorian’ or ‘Phrygian’ music in the ‘Lydian key’. What survives of its vocal line adheres to the citharodic compass of

¹ Among what has been traded as musical documents containing some sort of notation the following are not dealt with here: the syllables imitating trumpet sound on Eleusis inv. 907 (Bélis 1984b; *DAGM* N^o 1); the comparable syllables furnished with part of what looks like instrumental notation of *CIL* 4.2305 (see Páll 2004): the signs read as < < F ∃ T T, about *a a d G# C#*, do not belong to one *tónos* nor do they fit within an overtone series; the vowels on a bone plaque and the letter imitations – possibly imitations of notation – on vases (Paris, Bibliothèque Nationale, inv. 2985; cat. 272) mentioned in Boshnakova 2008; the definitely non-musical inscriptions published by Themelis 1989 (Laurion inv. 90; Volos inv. E-927; Agora, Fétiche Tzami inv. 91A); Spyridis 1990; Themelis 1994; Spyridis 1999; Themelis 1999; cf. West 1992b; Spyridis 1993; *DAGM*: 6 n. 3; the spurious documents *DAM* N^o 13–17.

central octave plus *hyperypátē*, indicated by the greyed field in the graphical representation:

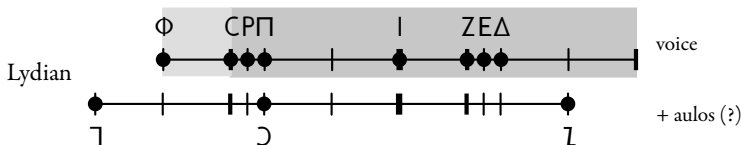

If the additional signs indeed represent hints to aulos harmonisation in instrumental notation as is often assumed,² they might give the scale a Phrygian character by the inclusion of *synēmménē* L.³ Their large span of more than an octave is a bit surprising, although the instruments could probably play these notes from the late fifth century on. At first glance it appears at least doubtful whether all three read instrumental notes could be intended for the same pipe, i.e. whether they could have been played by one and the same hand.

This fragment from Euripides' *Iphigenia in Aulis* was probably copied earlier than the *Orestes* papyrus. It is dated to the middle of the third century bc, and would therefore be a little more likely to preserve the original music, were it not for the fact that the papyrus contains excerpts for concert performance.⁴ Of its music, nothing could be restored with certainty. Editors disagree widely about the reading of the signs, some of which seem not to resemble any recognised shape at all.⁵ In the standard edition, from "the most clearly recognizable signs" a Hyperaeolian tonality has been inferred.⁶ This, however, can hardly be correct. The Hyperaeolian scale as such is not

² For a concise summary of the discussion about these signs, see Psaroudakēs 2004. For an extensive analysis of the papyrus, Prauscello 2006: 123–60.

³ But cf. ps.-Plut., *Mus.* 1137c on *nētē synēmménōn* in the accompanying pipe of the Dorian aulos (cf. below, pp. 407 ff.). Whether the glyph L is rightly identified as instrumental L, must remain doubtful (cf. Willink 2001: 126 with n. 5). The shape does not resemble the rotated M from which it originates and is attested only within runs of vocal notation. The usual interpretation requires the assumption that the form was deliberately altered to be distinguished from vocal Z. What appears to be instrumental notes of regular shape, on the other hand, ΓJ in ll. 5–6, are set apart by preceding diastole (Γ is also a vocal sign denoting a different pitch, whereas J is instrumental only). Cf. however below, p. 350.

⁴ For an improved edition with detailed analysis, cf. Prauscello 2006: 160–81.

⁵ Cf. Jourdan-Hemmerding 1973; Comotti 1977; Jourdan-Hemmerding 1981; Mathiesen 1981: 23–32; van Akkeren 1983; Černý 1986; Comotti 1989: 110–11; *AGM*: 286–7.

⁶ *DAGM*: 20; cf. *AGM*: 286.

even part of the Aristoxenian system, but appears only as one of the redoubled keys in the final version of the notation. We can therefore exclude that it was used by Euripides; and even if the music of the fragment were not the original, we should assume the fifteen-keys system to postdate the papyrus by generations.⁷ Admittedly, it is conceivable that the few preserved notes stem from an extensive modulation, such as Aristoxenus has described as ‘exceeding the melodic use’ (ἐκμελής). Such modulations occur in the First Delphic Paean, where they probably allude to music from Euripides’ time.⁸ In the Paean we can observe how ‘regular’ tonal material is melodically rearranged to radical modulations to a scale only a semitone apart. Indeed we must assume that the notation of such pieces anticipated structural features of the semitone grid and the chromatic scales that were schematically described only by Aristoxenus (we must bear in mind that there would have been no need to develop a system of scales distributed at equal distances of semitones unless it was no longer possible to describe contemporary music otherwise). But even if the necessary technical devices were probably at Euripides’ disposal, such a modulating interpretation of the fragment does not seem very likely.⁹ Firstly, extensive modulation is associated with different kinds of music. It is doubtful whether the tragedians ever went so far. Secondly, extensively modulating sections would have formed only a small part of the scores. Thus it is not all too likely that a fragment of some lines contains precisely such a passage. All in all, the present readings seem too uncertain to serve as the basis for conclusions of any kind.

DAGM^o 5–6

Pap. Ashm. Inv. 89 B/29–33

3rd–2nd cent. BC

In contrast to the ‘natural’ signs of the *Orestes* papyrus (N^o 3), the at least partially tragic music of the Ashmolean Papyrus forms our earliest evidence of typical ‘auletic’ notation, with the exploitation of the older, enharmonic half of the system. Thus, both approaches are exemplified for tragedy. Although the assumption of an evolution from the simple ‘Lydian’ system to the full set of Dorian, Phrygian and Lydian *tónoi* between Euripides and the probably later tragic piece of this papyrus is appealing, we must take

⁷ Much the same holds true for alternative interpretations as Aeolian or even Hypoaeolian, which were introduced by Aristoxenus as ‘Low Lydian’ and ‘Low Hypophrygian’.

⁸ See Hagel 2000: 70–82.

⁹ In the case of the Iphigenia fragment, one might think of a modulation between enharmonic Lydian (C[P]Π) and Phrygian (T), the notes subsequently rearranged to a chromatic *pyknón* at the semitone step in between (CΠT).

warning from the Delphic Paeans, where both practices still appear side by side in one and the same genre.

Although it is by no means certain that the fragments stem from the same roll, they are related in many respects. Their notation belongs mainly to a shallow range within the octave shared by Hypodorian and Hyperphrygian. In addition, two signs are found which are alien to these keys. Here are the notes of DAGM N^o 5, with tragic content:

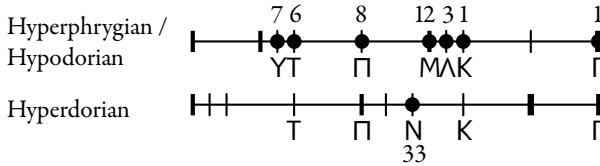

Here as well as in the next chart, the distances between the notes are oriented towards the relations underlying the notational system; they are not meant to reflect the actual intervals of the music. Although naturally written in the 'enharmonic' keys, late-classical and especially Hellenistic music might also have been chromatic. The figures accompanying the notes in the graphic indicate the frequency not of the written signs, but of the sung notes: at this early date repeated notes were recorded only once, over the first syllable; but for assessing the modal importance of individual notes, the number of syllables sung to each of them is of greater interest.

The distribution of notes is doubtless startling, to say the least. Pöhlmann and West remark:¹⁰

If the most frequent note in these fragments, N, is extraneous to the scale chosen for notation, this is symptomatic of the inadequacy of handbook theory to accommodate the modal variety of actual music in the late Classical period.

This statement requires careful consideration, because one must avoid the pitfall of equating 'handbook theory' with Aristoxenian theory at its height. If all we possess are mere handbooks, it does not mean that Aristoxenus' lost works would not provide us with the clue to such music. After all, what we observe is primarily the inadequacy of the notational system, which was originally devised for simpler melodies. Aristoxenian theory, on the other hand, with its strong descriptive component, was conceived after the late classical revolution, and especially with a view to its complex structures. It is improbable that it could not cope with melodies of a classical tragedy.

¹⁰ DAGM: 25.

Another question is, whether the N of our fragment indicates some “modal variety” in the sense of a primary scale of unusual shape, or if it introduces some element of modulation between structures that as such even conformed to handbook theory. Here meticulous examination of the melodic context is required. Since №5 is too short and too fragmentary, we must postpone the question for the moment.

In any case, it is impossible to determine even the pitch of N on the basis of the notation alone. Were it to be interpreted in accordance with strict pitch equation, N would coincide with M: the latter lies a tone above Π in the keys from Phrygian to Dorian, while N lies two semitones above Π in Hyperdorian – in a tetrachord that already belongs to the chromatic paradigm. Within this line of interpretation there is room merely for a microtonal difference of tuning shade between M and N. But no ancient source recognises a ‘modulation of shade’.¹¹ If the Hyperdorian tetrachord were conceived of as enharmonic, too (contrary to its notation!), N would be an unproblematic semitone lower than M.

But should we presuppose a strong interest in notational logic on the side of the composer at all? When he decided to use the sign N for whatever pitch he intended, he might have had in mind nothing more than ‘the next note below M’. In enharmonic context, this might denote a pitch a quarter-tone below M; in a chromatic piece, once more a semitone below M. The quartertone variant, it has been pointed out, leads to implausible melodic intervals,¹² so that the position a semitone below M appears most likely on this line of reasoning, too.

The papyrus scraps that are included in *DAGM* №6 come from the same papyrus cartonnage as №5. Seemingly they comprise fragments from several items of unclear interrelation. All of these are however notated in a very similar manner, which resembles №5 both in compass and a basically Hyperphrygian/Hypodorian scale. The curious N is again present, although much less prominent. The considerably greater amount of available material also includes the typical Phrygian notes Θ and (probably) Ι, whereas the Hyperphrygian/Hypodorian Κ is here missing. Still, the resemblances be-

¹¹ For Aristoxenus’ diligence in enumerating possible ‘modulations’ cf. his twelve rhythmical *metabolai*: Aristid. Quint. 1.19, p. 40.1–7 (partly echoing the seven distinctions given in Aristox., *Rhythm.* 22–9, p. 14–15, and Aristid. Quint. 1.14, p. 33.14–28. The manuscripts of Aristoxenus’ treatise break off before modulation is discussed; Aristides’ actual list has suffered corruption; cf. *GMW* II: 4.44 n. 211). Nothing would have prevented Aristoxenus from including a ‘*metabolé katá khróan*’ along with the four types he recognised (Cleonid. 13, p. 204.19–206.5; cf. Bacchius 88, p. 312.7–11; 50, p. 304.6–7; Anon. Bell. 3, §65), if musical practice had known such a thing.

¹² *DAGM*: 25 with n. 3.

tween N^o 5 and N^o 6 are so striking that they can hardly be treated independently; at the very least, they exemplify the same peculiar usage of notation, including hitherto unexplained vertical bars above, or in one case across, certain notes. Regarding all these similarities, the absence of K in N^o 6 raises doubts whether it is correctly identified as a note in N^o 5 at all.¹³

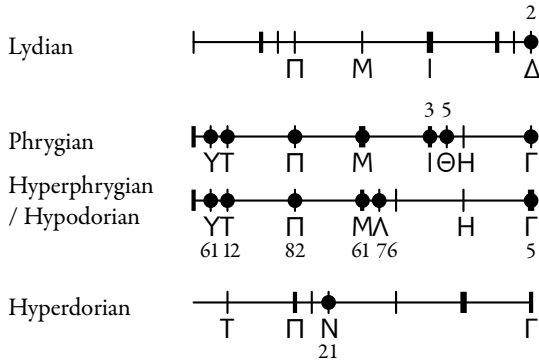

At two places a Δ appears that cannot be accommodated into the scale any more than can N. To relate it to the rest by means of scalar interdependence would require reference to the Lydian, which puts it two tones plus a *pyknón* above M. An enharmonic reading in accord with the triadic nature of this *pyknón* equates its pitch with Γ , while a chromatic interpretation raises it one semitone above the same Γ . Once more, the first option is hardly likely because it allows at most for microtonal variation. The second interpretation introduces a confusing divergence in the treatment of the two alien notes: whereas N is certainly not higher than the note written with the preceding letter M, Δ would be higher than Γ . The sole possibility of treating N and Δ equally is to put them at a similar interval below their respective predecessors (which are part of the main scale); this interpretation was adopted by the editors, as well.

Special consideration must also be given to the definitely non-Hyperphrygian Θ , which clearly does not represent modulation into Phrygian, but appears in close association with Hyperphrygian Λ . In chromatic music, Θ lies three semitones above M. In Hyperphrygian, however, this pitch should be notated by H. Consequently it has been assumed that Θ represents once more a somewhat lower pitch, about one quartertone below H. Thus the resulting Hyperphrygian *mésón* tetrachord $M\Lambda\Theta\Gamma$ would comprise intervals of $\frac{1}{2} - \frac{3}{4} - 1\frac{1}{4}$ tones, a structure that Aristoxenus de-

¹³ DAGM N^o 5, fr. 6.1:]K[Π ? ?[; fr. 8.1: κ[, with the remark "may be notation"; cf. West 1999: 52.

scribes as ‘soft diatonic’.¹⁴ But this interpretation is more than problematic. Firstly, the alleged relation between H and Θ would thus differ from those between M and N and between Γ and Δ. Secondly, nothing in the extant bits of melody suggests a functional tetrachord MΛΘΓ; above all, the typical interval between *likhanós* and *mésē*, which establishes the ‘soft’ character of the shade, is missing: never is Θ found next to, and not even near Γ (which is used rather for larger intervallic leaps). Instead, Θ is consistently embedded in an environment of ΥΠΜΛΘ,¹⁵ which is rather awkward if read as 1–1–½–¾. With Θ assigned its regular pitch, we obtain a straightforward diatonic section of 1–1–½–1, corresponding to a recognised ‘shape of the fifth’ of Aristoxenian theory.¹⁶

Probably the whole problem is caused by an inappropriate concentration on the scalar symmetry of the late regularised system, where scales such as Hyperphrygian and Hypodorian seemingly enjoy equal status as the old core *tónoi*. But what we commonly refer to as Hyperphrygian was introduced as a key only by Aristoxenus, under the name of Hypermixolydian. Before, its characteristic combination of tetrachords was merely present as the *synēmménon* variant of Phrygian. And what pre-Aristoxenian theory recognised as Hypodorian was not even identical with the later *tónos*.¹⁷

It is quite clear that the composer of the Ashmolean fragments did not intend to write a ‘Hypermixolydian’ melody. Presumably he called his tonal material by the name of ‘Phrygian’, even if the melody stayed within the *synēmménon* tetrachord for the most part.¹⁸ Taking this into account it is much less surprising that he used the sign from the basic key, Θ, instead of the H that rigid systematisation came to demand. After all, even many theorists acknowledged the identity between diatonic/chromatic *tritē diezeugménōn* and diatonic *paranētē synēmménōn*, which was inevitable in instrumental practice. On top of this, none of the notes involved maintained its native ‘function’ in the course of the melodies of the Ashmolean papyri; thus the neat functional distinction between a Θ and an H of the same pitch would have been mere hypocrisy.

Taken together, the employed notes form a continuous run of nine semitones:

¹⁴ West 1999: 49; *DAGM*: 38–9. West refers to Ptolemy’s ‘soft chromatic’ also; but this continues older chromatic music and was notated with a *pyknón* (cf. below p. 307 on *DAGM* N^o 48).

¹⁵ *DAGM* N^o 6, fr. 4.i.1: Λ[]ΠΘΠΥΠ; fr. 13.ii.5: ΛΘΜΛ; fr. 15.i.6: ΛΠΘ; fr. 18; fr. 23.3: ΘΜ[]Π.

¹⁶ Cf. e.g. Cleonid. 9, p. 196.20–197.3; Aristoxenus’ text breaks off after the enumeration of the species of the fourth. (*Harm.* 3.7.4, p. 92.12–17).

¹⁷ Cf. below, esp. pp. 429ff.

¹⁸ Cf. *DAGM* N^o 9, where a Hypophrygian section bears the signature ‘Phrygian’.

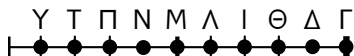

This is a ‘chromatic scale’ in the modern sense. As a musical structure, it is forbidden by the laws that Aristoxenus formulated. But it is not used as a musical structure as such; it merely provides the raw material from which various musical structures could be formed, to alternate in the course of modulation.

Only little can be gleaned of how this was done in particular from the short surviving scraps. Some principal considerations are therefore in place. The variety of notes itself is sufficient proof that what we have here is music of a very sophisticated style. Yet we are surprised by its narrow compass of a major sixth; and even of this sixth, the higher notes appear only rarely, so that the major part of the melody is restricted to a mere fourth. Sophisticated melodies within so narrow a range are naturally impossible within a single scale. We must therefore expect that the music of the Ashmolean papyri is heavily modulating: which means that in the course of the melody the available notes must frequently rearrange themselves to new scalar patterns.

Furthermore, sophisticated music of this age without doubt belongs to, or follows the manner of, late classical avant-garde composition. This style is best documented in the second part of Athenaeus’ Delphic Paean (*DAGM* N^o20).¹⁹ There we can study a modulating technique that starts from a traditional scale, then establishes, by rather transparent modulation, a tonal material that includes a run of semitones, only to re-interpret these notes in rapid and complex modulation. At its climax, the melody oscillates between small sections of two chromatic scales only a semitone apart. Interestingly, these complex figures unfold within a much narrower range than the surrounding parts of straightforward tonality: while the entire Paean extends over an octave and three tones, the compass becomes smaller the more the modulating style gets ground. At last the melody stays within a major sixth, which extends from Y to Γ in Phrygian environment, with emphasis on ‘Hyperphrygian’.

The parallels to the Ashmolean papyri are obvious. But these go even further as regards the chromatisation of the tonal space:

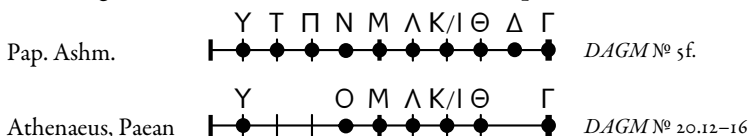

¹⁹ Hagel 2000: 70-87.

Apparently Athenaeus exploits a subset of traditional possibilities. Notably, he makes use of the same ‘alien’ note which is so prominent in *DAGM* N^o 5. The fact that he notates it as O perhaps testifies to an increasingly systematising attitude, brought about by Aristoxenus’ influence: O is the ‘correct’ choice, since the Hyperdorian tetrachord whence it stems is of the later chromatic type. Accordingly, the functional distinction between the ‘identical’ notes I and K is carried through meticulously.

In the Paean, the notes are arranged into three different structures of legitimate shape: (1) the original Phrygian scale, diatonicised in its upper range by the inclusion of *néē synēmménōn*, (2) chromatic Hypophrygian, and (3) a chromatic fourth a semitone below Hypophrygian. In the following diagram, these structures are complemented to sequences of full tetrachords, in order to bring their legitimacy to the eye:

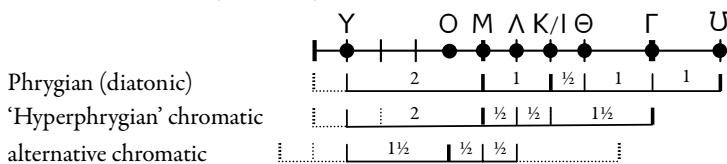

In the course of the composition, the structures alternate rapidly. Transition between them is often accomplished through some common interval; but in principle it does not require more than a common note.²⁰ That such violent modulations were very well accounted for by Aristoxenus is proven by the short passage in Cleonides, which is more or less all that has come down to us from this advanced chapter of harmonic theory:²¹

γίγνονται δὲ μεταβολαὶ ἀπὸ τῆς ἡμιτονιαίας ἀρξάμεναι μέχρι τοῦ διὰ πασῶν ... ἀναγκαῖον πάση μεταβολῇ κοινόν τι ὑπάρχειν ἢ φθόγγον ἢ διάστημα ἢ σύστημα. (Cleonid. 13, p. 205.10–19)

Modulations occur between scales that stand in distances from a semitone up to an octave ... Necessarily every modulation needs some common point, either a note or an interval or a *sýstēma* (i.e. a combination of intervals which form part of a legitimate scale).

Here two essential characteristics of music such as we are considering are explicitly acknowledged: modulation between scales only a semitone apart, and transition between scales merely through a common interval or even a

²⁰ Cf. the change from the first to the last structure by a sequence of ΓΘΥΟΜ in *DAGM* N^o 20.13, where the incompatible Θ and Ο are linked by nothing more than the common Υ.

²¹ For an interpretation of the complete passage, cf. Hagel 2000: 77–80.

single common note. It is crucial to understand that no music with less complex modulation than Athenaeus' Paeon needs such extreme concessions: this part of theory, like the full system of thirteen keys, was formulated precisely to describe the masterpieces of the 'New Music'.

Probably the Ashmolean papyri give us an impression of how such free modulation in the semitonal space was handled before the notational system was reworked under the influence of Aristoxenus' diagrams: additional notes were introduced more according to their position in the alphabet than with view to systemic relations. The fact that the underlying sign triplets were concealed by the alphabetic progression of the 'vocal' notation facilitated such an approach.

Of the patterns that were formed within the resulting semitone grid we get only dim impressions. In the absence of longer runs on which the modulating technique could be exemplified we must be content to observe some typical configurations, starting with the richer material from N^o 6. Firstly, parts of the melody used ambiguous structures, built from notes common to more than one definite scale. This is only natural in modulating music: such deficient systems could mediate less abrupt transitions between two alternative microscales. The most rudimentary form which we encounter is that of an empty fourth with a tone below, which is just a section of the tetrachordal framework:

But generally the melodies emphasise the fourth between ΥΛ (although this is none of the regular tetrachords between the fixed notes of theory), so that it is the 'species' of this fourth which implement the crucial distinctions. Of the possible ambiguous three-note structures, the following are found:

(A) ΥΜΛ(Γ): here a ditone stands above a semitone which is, in one possible case, once more followed by a ditone:

This implements only the notes that are common to all three genera, diatonic, chromatic and enharmonic; Aristoxenian theory spoke of a 'common

melody', *mélōs koinón*.²² Its practical importance is proven by the opening of Athenaeus' Paean (N^o 20). One of its functions in Hellenistic times was probably to cite enharmonic music without using quartertones – archaic enharmonic, according to a widely accepted version of ancient musical history.²³ But this structure is equally apt for modulation between the genera: in the present context, between diatonic and chromatic divisions.

(B) $\Upsilon\text{Π}\Lambda(\Theta)$: this is a sequence of $1 + 1\frac{1}{2}$ tones, possibly expanded by another tone at the top:

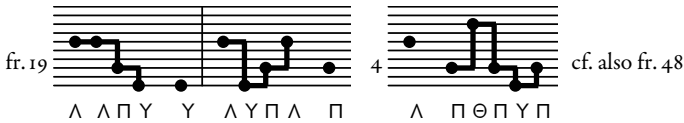

By bisection of the tone it becomes chromatic, by division of the trihemitone one of the diatonic species of $1 - \frac{1}{2} - 1$ or $1 - 1 - \frac{1}{2}$ tones.

(C) $\Upsilon\text{N}\Lambda$: the reversion the preceding division, $1\frac{1}{2} + 1$ tones, is not well attested:



Again, it can turn into a section of a chromatic scale by dividing the tone ($1\frac{1}{2} - \frac{1}{2} - \frac{1}{2}$), or by division of the larger interval, into the diatonic species $\frac{1}{2} - 1 - 1$ or $1 - \frac{1}{2} - 1$.

Most of the segments of non-gapped valid scales that the melodies employ can be analysed as combinations of these simple shapes:

(1) $\Upsilon\text{Π}\text{M}\Lambda$ (= $\Upsilon\text{Π}\Lambda \cup \Upsilon\text{M}\Lambda$): this is regular diatonic 'Hyperphrygian', in accordance with the notation; it divides the tonal space between Υ and Λ into a sequence of $1 - 1 - \frac{1}{2}$ tones. The largest continuous runs in this tonality are:



Compare also most of fr. 1, fr. 2+3, fr. 14, fr. 20, and fr. 25.

²² Cf. above p. 159 with n. 61.

²³ But cf. below, pp. 397ff.

At two points, this regular diatonic is alternated with similarly regular ‘Hyperphrygian’ chromatic (T in strong association with M, which include the typical chromatic trihemitone), and subsequently expanded to a fifth by another tone at the top ($1-1-\frac{1}{2}-1$):

fr. 15.i
 Y A P Y A P Y M T M P P Y G P Y Y P A P Θ

fr. 13
 A P A M A A P Y P Y Y P Y T M T M M T M M A Θ M A

Obviously modulation between the chromatic and the diatonic *likhanós* (T and Π) requires nothing more than recursion to the common *mésē* M; for the progression from T to Π in fr. 15.i above compare the inverse modulation in another scrap (with regression to diatonic in the following line):

fr. 16
 A P M T M P Y Y M A

(2) YNMA (= YMA ∪ YNA): This is the chromatic sequence of $1\frac{1}{2}-\frac{1}{2}-\frac{1}{2}$ tones. It stands out most clearly in:

fr. 41.1-2
 N N N Y N N M A M N

Another instance might be sought in fr. 42 (especially as both fragments reveal subsequent emphasis on the third ΠΛ). This scale segment is certainly alien to the Phrygian background; it represents the extreme case of modulation to a key only one semitone apart. Scalar analysis identifies it as belonging to the Hyperian *tónos*, which was, under the name of Mixolydian, already part of at least one pre-Aristoxenian system. This may be of little significance, though; probably the composers cared no more about such abstract interrelations than for a systematically satisfactory notation. Much more important is the fact that Athenaeus’ Paean employs precisely the same modulating chromatic fourth: here we have a real chance of pinning down a conventional element of Hellenistic composition.

(3) $\Upsilon\Pi\Lambda$ (= $\Upsilon\Pi\Lambda \cup \Upsilon\Lambda\Lambda$): a trace of this modulating diatonic sequence, which divides the focal fourth into $1-\frac{1}{2}-1$ tones,²⁴ is perhaps to be sought in:



(4) $\Upsilon\tau\Pi\Lambda(\Theta)$: where τ appears in immediate association with Π it can hardly belong to the regular Phrygian chromatic as above. Some badly mutilated fragments indicate that we ought to assume another modulating form of chromatic, in which the $\Upsilon\Lambda$ fourth appeared as a chromatic tetrachord in its quotation form of $\frac{1}{2}-\frac{1}{2}-1\frac{1}{2}$ tones, perhaps augmented by a disjunctive tone above:²⁵



Although considerable parts of the melody are missing, the extant notes of the last example seem to disclose a harmonic strategy. The initial leap accentuates the typical fourth, perhaps ‘emptying’ it of its previous division (the preceding column contains several instances of μ). The open space thus created is then filled with a modulating chromatic tetrachord. Afterwards, the melody probably returns to the underlying Phrygian. This is terminated by another clean $\Lambda\Upsilon$ fourth, which once more leads into the modulating chromatic. One might also compare the following progression:



(5) $\Upsilon\Pi\Lambda\Theta$? The extant notes of fr. 23 assemble to another structure of tone plus chromatic tetrachord:

²⁴ This sequence belongs to Aristoxenus’ Low Mixolydian or Low Hypolydian, later labelled Hyperdorian and Hypoaeolian, respectively.
²⁵ The respective Aristoxenian key is Low Lydian, the later Aeolian. For this configuration, cf. also fr. 28, whose notes $\Pi\Upsilon\Gamma\Delta$ fit into no legitimate structure except chromatic tetrachord + tone + chromatic *pyknón*.

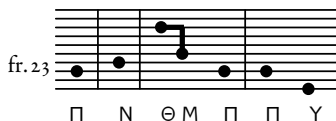

That this is in fact a scale is however just a remote possibility. Even if all signs are read correctly, it is more likely that modulation occurred between the extant bits.

The few continuous parts of N^o5 fit comfortably into the picture. One piece looks like ordinary diatonic:



Another provides one more attestation of the fourth with high *pyknón* which N^o6 shared with the Delphic Paean:



New is the combination of TNM, a sequence of tone plus semitone that N^o6 does not know. Whether it belongs in a diatonic or a chromatic environment cannot be determined:



All in all, the Ashmolean papyri, and especially the items of DAGM N^o6, convey a faint idea of ‘New Music’ at work, selecting and alternating between several – but by no means all! – possibilities that are inherent in a grid of semitones. Without Athenaeus’ Paean, any attempt to interpret the mutilated melodies would be at a loss. With this piece as a guide, however, we learn from them that Hellenistic free modulation could go beyond what was sung at a traditional ceremony in Delphi.

When comedy entertains the images of ant paths and vegetable full of caterpillars for the compositions of avant-garde poets such as Timotheus and Agathon, there is little doubt that a similar style is meant.²⁶ The intri-

²⁶ Aristoph., *Thesm.* 100: μύρμηκος ἀτραπούς “ant paths” (about the avant-garde tragedian Agathon); Pherecrates *ap. ps.-Plut., Mus.* 1142a: ἐκτραπέλους μυρμηκιάς “perverse ant-hills” (about Timotheus); ὥσπερ τὰς ῥαφάνους ὄλην καμπῶν με κατεμέστωσε “stuffed me with modulations/caterpillars like cabbage” (a pun on καμπή ‘melodic bend’ / κάμπη ‘caterpillar’; Timotheus again; Music herself is speaking); *Anth. Pal.* 11.78.3–4: μυρμηκῶν τρυπήματα “ant-holes” in the immediate neighbourhood of γράμματα τῶν λυρικῶν Λύδια καὶ Φρύγια “the lyric poets’ Lydian

cate melodic figures within a small tonal space are not unfittingly compared with the confusing movements of crawling or squirming insects. A more technical term that we encounter in this context is *kampai*, (melodic) ‘bends’ or ‘turns’.²⁷ It combines the notion of modulation – leaving the straight harmonic path – with that of the frequent change of melodic direction that is inevitable in melodies which are confined within a narrow compass.

The *kampai*-style is especially associated with Phrynis (although Timotheus seems to have brought it to unprecedented extremes).²⁸ Perhaps our novel characterisation of this style can throw new light on a notoriously disputed verse, which forms part of Pherecrates’ comic portrayal of Phrynis’ music.²⁹ Phrynis is said to have ruined music

ἐν πέντε χορδαῖς δώδεχ’ ἀρμονίας ἔχων. (ps.-Plut., *Mus.* 1141f)

with twelve harmonies in five strings/notes (*khordai*).

Of course, this is comic exaggeration and must not be mistaken for a musicological record. Even so, the text of this verse has been doubted on the grounds that one would expect more, not fewer strings than the earlier standard seven: in the same passage, twelve *khordai* are mentioned both for the earlier Melanippides and the later Timotheus. And yet a change of the text in this direction is unsatisfactory;³⁰ and three mentions of “a dozen strings” within not more than two dozen verses do not really add to the effect of the passage. But it is not necessary to take “five” as Phrynis’ total number of strings. Since everyone knew that Phrynis employed at least as

and Phrygian scripts” (cf. Pöhlmann 1960: 10 n.1; Bélis 1990); cf. also the appellation Μύρμηξ (“Ant”) for Philoxenus (*Suda*, s.v. Φιλόξενος); and Winnington-Ingram (Browning 1963: 77) on ἀνάτρητος in Psell. (?), *Trag.* 5.

²⁷ Aristoph., *Nub.* 333: ἄσματοκάμπτας “song-benders” (unnamed composers of dithyrambs); 969–70 κάμψειέν τινα κάμπην οἷας οἱ νῦν, τὰς κατὰ Φρυῖνιν ταύτας τὰς δυσκολοκάμπτους “... would bend a bend like those they make today, those of the Phrynis-kind, the uneasily-bent ones”; *ap.* Pollux 4.64; Pherecrates *ap.* ps.-Plut., *Mus.* 1141e ἐξαρμονίους κάμπας “exharmonic bends” (about Phrynis’ predecessor Cinesias); 1141f κάμπτων καὶ στρέφων “bending and turning [Music]” (about Phrynis), and as in the preceding note; Pollux 4.66 μέλεσι πολυκάμπτεσι “melodies of many bends” (Phrynis, too); Dio Chrys. 2.56: ἀμούσοις κάμπαις “with unmusical bends”.

²⁸ Apart from the passages quoted in the preceding note, cf. e.g. ps.-Plut., *Mus.* 1133b. For Phrynis’ style as a prerequisite for Timotheus’ music, Aristot., *Met.* 993b.

²⁹ Cf. West 1992a: 28–9 (rightly rejecting the variant reading πενταχορδοῖς); *AGM*: 360–1.

³⁰ West’s proposal ἐς πέντε χορδαῖς δώδεχ’ ἀρμονίας ἔχων elegantly reverses the association of nouns and numerals, but leaves an awkward bare dative to be construed with ἔχων (“holding up to five harmonies with twelve strings”? In order to enable the decoding of such a metaphorical usage, one should at least expect the instrumental dative to reference a recognised fact – and not also new information – indicated by the definite article τὰς χορδαῖς, “with his twelve strings”).

many notes as his predecessors, the text must be understood as “even in a subset of five *khordai* he had twelve harmonies” (the consequences for his full tonal material to be extrapolated). Although this interpretation seems sufficient by itself, our observations suggest a more specific connotation: the “five notes” allude to the surprisingly restricted pitch range within which the exuberant modulations of Phrynis’ style took place. In this case, the ‘*harmoníai*’ here are not entire octave tunings, but mutually exclusive tone constellations. Such a reading gives a more precise sense to the image of ant paths, as well: generally these insects stay on a narrow trail, within which their movements are however less predictable.³¹

It goes without saying that the numbers remain exaggerated. In the Ashmolean fragments we could determine at most eight ‘harmonies’ within six *khordai*:

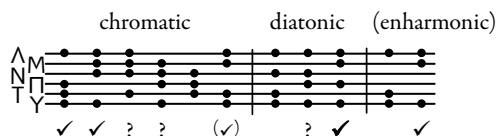

The organological background of the Ashmolean pieces is unclear. Tragic lyrics were, at least originally, accompanied by the aulos. The items of N^o 6, although “possibly from the same roll”, are considered to be “citharodes’ repertoire, either excerpts from tragedies or citharodic nomes or dithyrambos”³² – the latter again originally with aulos accompaniment. The Phrygian character of the notation also points to the aulos; but conceivably the notational conventions of modulating aulos-accompanied song were maintained when their melodic style was accommodated to citharodic genres (whereas more traditional lyre music maintained the ‘Lydian’ notation).

This papyrus seems to contain the remnants of a musical treatise, the earliest we know of that makes use of notation. Apart from a number of notes in a tabular arrangement of unclear purpose, one reads two short melodic sequences:]BBΓ[... | ...]ΚΥΜ[and]ΥΥΠΛΥΠΥΥ?Μ[. Their character is reminiscent of the Ashmolean pieces; the latter represents the basic Phrygian configuration. B appears in Athenaeus’ Paean (N^o 20) within a regular

³¹ I suppose that Aristophanes’ “ant paths” (μύρμηκος ἄ-τροπα-ούς) exploits an established metaphor, on which Pherecrates’ “deviant ant-hills” (ἔκ-τροπα-έλους μύρμηκιάς) puns.

³² DAGM: 38.

modulation; it extends the semitone series of the Ashmolean papyri beyond Γ.

DAGM[№] 8

Pap. Zenon 59533

3rd cent. BC

Another instance of the same notational style is the probably tragic fragment of the Zenon papyrus. The standard edition reads the following notes, which revolve around the Phrygian functional *mésē* M:

Phrygian	
Hyperphrygian	

Their interpretation within the melody is however problematic. While the first line remains within the regular Phrygian diatonic division of the familiar ΥΛ fourth (ΥΠΜΛ), and the final traces may be read as an ascension through the Phrygian disjunctive tone (ΜΙ), the second line apparently creates an illegitimate sequence of semitone – semitone – tone – semitone, and moreover employs Ι and Κ in immediate succession, although these are of identical pitch, at least in the plausible chromatic interpretation:

Consequently, it has been assumed that “the sequence Θ ΙΚ represents a descent by successive quarter-tones”,³³ which implies a complete disagreement with ancient theory.

If we start from the Ashmolean evidence, there are two difficulties. The first may be associated either with the Τ, or with the Μ at the start of the second line. The former would disrupt the regular ΥΠΜΛ mode; it should not appear together with both Μ and Π. Alternatively we could reckon with a chromatic division of the fourth as ΥΤΠΛ, as exemplified in the Ashmolean pieces.³⁴ In this case a preceding Μ appears harsh. Although the immediate vicinity of modulating notes is not impossible if both have been sufficiently established before, such a melodic figure is attested only once in

³³ DAGM: 42.

³⁴ This is the interpretation of Hagel 2000: 103–7, on the basis of the melody as given in DAM[№] 35 and AGM: 287. The parallels drawn there to similar scalar relations within Aristides’ Mixolydian, and to the status of Π as *hyperpyatē*, appear less striking once the restricted range of this type of music is recognised.

	regular	problematic
clearly read	15	0
doubtful	3	2

$p = 0.0526$ (Fisher's exact test)

Table 10 Textual and musical difficulties in Pap. Zenon 59533

the Delphic Paean, and once more it appears unlikely that so short a fragment should contain just such a passage.³⁵ Admittedly, one could understand the K immediately after I as an explicit indication of modulation from the disjunct to the conjunct system; but there was little emphasis on disjunction before. Notably, however, the reading of these two difficult notes is not agreed. A comparison between disputed readings (indicated by question marks in the score above³⁶) and musically problematic notes reveals that they are most probably correlated (Table 10). One could say, the odds are 18:1 that the musical problems of the Zenon papyrus are but modern construction.

Consequently line 2 should be read either as]M Π Y ♯ Λ M Θ I ?[, or as]? Π T ♯ Λ M Θ I ?[. The former disposes of all complications; what remains is a modulation from conjunct to disjunct Phrygian around the scalar pivot of *mésē*. The latter possibility seems more likely from a palaeographical viewpoint. It presents us with a more interesting modulation from an irregular – but paralleled – chromatic structure through the ‘clean’ fourth back to *mésē*, and from there into the disjunct tetrachord. It may be significant that in the Ashmolean fragments the leaps across the empty YΛ fourth stand just in the same association with Y, T, and Π as here.

The most important contribution of this fragment to our study is the explicit label ‘Phrygian’, by which the transition between two sections of different tonality is marked. As far as we can see, the preceding lines are in

³⁵ The fragment is from the end of the piece (and probably even the scroll): would a climax of modulation be appropriate there? The corresponding passage from of Athenaeus’ Paean (N^o 20) stands at the end of its section, but not of the composition.

³⁶ One must count either the T or the M, but not both; for the result it makes no difference, which one is chosen. Although the identification of the barred ♯ was long unclear, I have not regarded it as disputed: the reading is unambiguous, and an interpretation as a different note is obsolete now that the form is paralleled in DAGM N^o 6.

diatonic Lydian. The ‘Phrygian’ part, on the other hand, starts with notes that belong to the Hyperlydian and Hypophrygian keys of the fifteen-scale system, MHP:

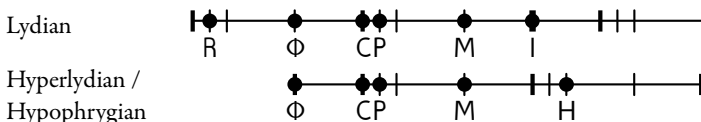

Hyperlydian and Hypophrygian form one of the pairs that differ only in pitch, but instantiate the same ‘key’ as far as scalar relations and ‘accidentals’ are concerned. The Hyperlydian *tónos* is in fact one of the late additions to the Aristoxenian set of thirteen.³⁷ The designation of notes belonging to this scale as ‘Phrygian’ uniquely reveals a Hellenistic composer’s view. Firstly, he chose to note as a change of *tónos* what could obviously have been described as *synēmménon* modulation within the Lydian Unmodulating System: the presence of a P immediately afterwards precludes a genuinely Phrygian tonality here. This is surprising since we cannot easily doubt that *synēmménon* modulation was a rather old conception. Consequently there should be a difference between *synēmménon* modulation and a real change of *tónos* which cannot be read just from the set of notes employed. From the view of theory, this would have to do with functional *mésē*: when the melody moves between the conjunct and disjunct branches of the Unmodulating System, it remains oriented towards one and the same *mésē*. In the course of a change of *tónos*, on the other hand, another note takes on the function of *mésē*. It seems that we can observe this process in the present fragment: although the Lydian *mésē* I is the most frequent note in the Lydian part, it disappears in the ‘Phrygian’ section, where the Phrygian *mésē* M becomes prominent. The odds that this observation is significant stand about 15:1 (cf. Table 11).

	I	M
ll. 2–6 χ	7	2
ll. 6 χ –8	1	4

$p = 0.0629$
(Fisher’s exact test)

Table 11

Lydian and Phrygian
mésē in DAGM N^o 9

In other documents obvious modulations are not indicated: as regards the execution of the melody, the explicit remark is redundant. Is it perhaps intended for the instrumentalist, as advice to adjust the accompaniment accordingly? It does not seem unlikely that a change of functional *mésē* would have called for a different harmonisation.

Furthermore, if Hypophrygian notes are subsumed under ‘Phrygian’, this testifies to a continuing aware-

³⁷ Cf. also its exclusion from the range of ‘orchestic’ scales in Anon. Bell. 2, §28 (see Diagram 14 on p. 54).

ness of the old modal tripartition into Dorian, Phrygian and Lydian music, of which ‘Hypo-’ scales are treated as mere variants. That the Phrygian *mésē* is the appropriate centre of a Hypophrygian melody confirms the picture. With some probability the present piece can therefore be associated with the first recognised stage of Greek music, that of ‘three *tónoi*’. Its clear-cut harmonic structure contrasts sharply with the exponents of the ‘New Music’ considered above.

In the last preserved line, we find the functional *parypátē hypatôn* below an empty ditone. As a form of ‘enharmonic’ division we have encountered a similar structure in N^o6. But Athenaeus’ Paean provides a more specific parallel. There a comparable melodic figure is located in the respective low range:

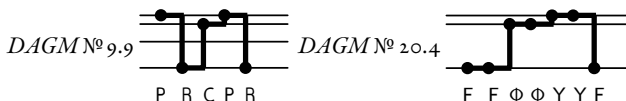

If the similarities are not accidental, they underscore the traditional character of N^o9: the example from the Delphic Paean stems from its archaising introductory lines.

Little can be gleaned about the genre to which N^o9 belongs. Its concentration on the functional *mésē* might vote for an auletic background; but the notes employed are also perfectly consistent with a Lydian-centred citharistic approach.

This piece is written on the reverse of the preceding. From chromatic and diatonic Lydian it modulates into chromatic Hypolydian and into the diatonic *synēmménon* tetrachord; whether the latter is once more conceived as belonging to Phrygian, does not become clear:

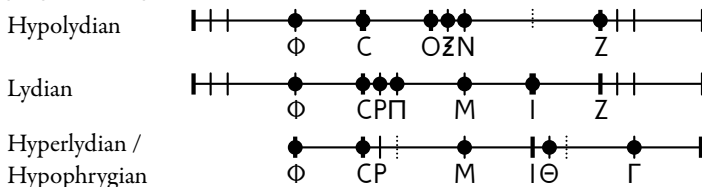

Regardless of the current tonality, the Lydian *hyperypátē* Φ is freely used as the lowest note. This would go very well with the cithara (the melody requires ten different pitches); the text, however, is obviously dramatic.

DAGM^o 11

Pap. Vienna G 29 825 c

3rd–2nd cent. BC

This scrap was interpreted as containing instructions for the accompanying aulos in addition to the vocal line, similarly to the *Orestes* fragment (N^o 3). Once more one is startled by the huge interval of a minor tenth between the two alleged aulos notes:³⁸

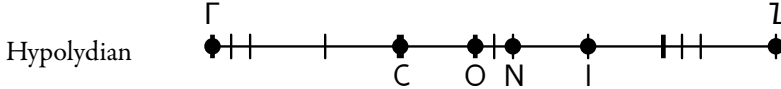
DAGM^o 15–16

Pap. Vienna G 13763/1494

3rd–2nd cent. BC

N^o 15 and 16 contain alternating vocal and instrumental lines in Hypolydian; they may belong to a single piece. Whereas the vocal parts are chromatic, the remains of the instrumental melody are genus-indifferent, at least as regards N^o 15. An apparently diatonic < is read in N^o 16, but in the context it is perhaps better called the *nētē synēmmēnōn*:

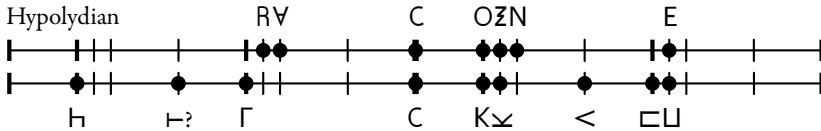

Hand in hand with this avoidance of a specific genus goes a melodic style of wide leaps that emphasise the fixed notes of the Hypolydian scale. Actually, the instrumental notes seem to represent mainly the fixed notes framework from *hypátē hypatōn* up to *nētē diezeugménōn* (and including *nētē synēmmēnōn*), enriched by two semitones within the main range of the voice (both of which are part of the vocal score, as well), and perhaps by a diatonic ♮.

The focus on the fixed notes suggests that the instrumental part is written for the aulos, in the course of whose evolution the Perfect System was apparently conceived.³⁹ Accordingly the restriction to a *mélōs koinōn* might once more evoke an ‘enharmonic’ style without quartertones.⁴⁰ Thus another of the Vienna fragments can be ascribed to an early or at least an archaizing style.

³⁸ Noticeably, Λ is written about 26% larger than the average of the five measurable vocal signs; it exceeds this average by 2.2 standard deviations.

³⁹ Hagel 2005a. For the type of aulos needed for such music, cf. below pp. 343 ff.

⁴⁰ Cf. above, p. 266; p. 159 with n. 61.

Music from the classical or early Hellenistic tragedy was also sought in two excerpts (N^o17 known as the ‘Ajax fragment’), which are found, among several later pieces, on a papyrus from the second or third century AD. Argument for an early date is based on “its content (lyric dialogue of Tecmessa and female chorus about Ajax’s suicide), its metre (dactylo-epitrite), and its musical setting (largely contrary to the word accents), which points strongly to strophic composition”.⁴¹ But there are also indications that point in the opposite direction. The first syllable of Ajax’s name is set to three notes, a feature that is typical for the later fragments; and especially the melodic division of a short syllable argues against an early date.⁴² Recently it was also demonstrated that the melody does not simply disregard word accents, but is set against them deliberately – a characteristic that is possible only in a musical culture in which composition in accord with the accents is well established.⁴³

The notation of the Ajax fragment consists entirely of signs with octave strokes (Ο’ Κ’ Ι’ Ε’ Α’); much the same signs, but – with one exception – without strokes, occur in the single line of N^o18 (Χ [?] Τ Ο Κ Ι Α’). The tonality has been determined on the basis of the observation that all these notes, except for the ‘irregular’ Ε’, occur in the Hyperaeolian key. The octave strokes are, however, incompatible with the suspected early date of the composition. Therefore, and because they are not applied consistently, they have been explained as the sign of an adaptation of a classical choral song, originally to be performed by male voices, to the vocal range of a female chorus or, rather, solo singer.

But if the octave strokes are added as a simple means of transposing the melody an octave upwards, we need not cling to the Hyperaeolian interpretation: deprived of their strokes, the notes also form part of the Hypoiasian and the Iastian.⁴⁴ The Iastian recommends itself as otherwise not uncommon.⁴⁵ Perhaps it fits the melody of N^o17 better as well: here the Hyperaeolian *mésē* Α, which we might expect to function as a melodic centre, at least in classical music, occurs only three times (and the Hypoiasian *mésē* Χ, not at all). The Iastian *mésē* Ο, on the other hand, is found nine

⁴¹ DAGM: 58. Cf. also Pöhlmann 2005: 139.

⁴² DAGM N^o17. 17 Αἴαν, 19 ποθοῦμενος. See AGM: 202–3; 320–1; cf. also 152.

⁴³ Cosgrove/Meyer 2006: 74–5; 80–1.

⁴⁴ Cf. also the free use of octave strokes in the *koinē hormasia* (above, pp. 123ff.); for another score exceeding the *systemata* of theory, cf. DAGM N^o 41 (below, pp. 300ff.).

⁴⁵ There are six fragments in Iastian, but only one in Hypoiasian, and virtually none in Hyperaeolian.

times. Against an Iastian background, the curious E' can also be interpreted as a modulation into the Hypolydian through the mediation of the Hyperiaastian;⁴⁶ thus the note material of OKIEA would be structured as: OKIA – OIA – OIE:

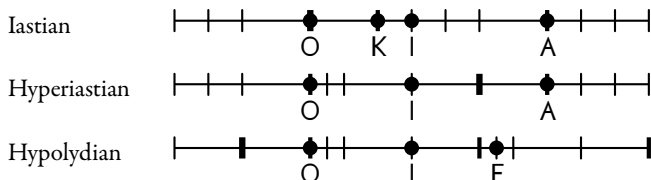

Such a structure, however, is not reflected in the melody, where we find not only E' and A' , but also K' and E' , side by side. Since the regular Z is missing, E' seems to represent an alternative pitch for this degree of the scale. It has been argued that this pitch must be about a quartertone above Z , since a raising by a semitone would call for a Δ instead.⁴⁷ But this is accurate only for Hyperaeolian; if we start from an Iastian reading, the E' can just as well indicate the semitone.

On the other hand, a modulating interpretation of the extant melodic figures is not impossible either. Twice E' is linked to K' and I' in what can only be part of a chromatic scale. Twice we find it in a succession $O' I' E' A'$, again a chromatic subset. In all cases these microstructures alternate with emphasis on $O' K'$, the disjunctive tone of the presumed Iastian main scale:



The iteration of the observed mechanisms adds a little plausibility to the modulating hypothesis. It is also of interest that $O' I' E' A'$ appears only in contiguous runs, once upwards and once downwards, the O' immediately preceded or followed by a K' , respectively. The falling sequence is introduced by an upwards leap of a fifth, recalling the 'open' fourths, which we have above observed as preceding a novel tonal division of their range. The missing Z is no real obstacle to such an interpretation: Athenaeus' Paeon (N^o 20) shows how a note can be excluded mainly because it will be replaced by a modulating counterpart.⁴⁸ Apart from abstract aesthetic considera-

⁴⁶ The other three pieces on the papyrus are unequivocally Hyperiaastian.

⁴⁷ *AGM*: 320–2; *DAGM*: 59. Note, however, that the transcriptions of N^o 18 accept Υ as a semitone below Γ , although this pitch 'should' be notated as Φ .

⁴⁸ The absence of Π in its chromatic portions is most probably associated with the presence of O in the second section.

tions, one can imagine how such a custom could arise out of very practical needs: if a string (or a row of aulos holes?) was tuned to some extraordinary note, an adjacent regular note might have had to be sacrificed.

For N^o18, the assumption of the Hypoianstian/Hyperaeoliankey appears preferable, firstly because there the T figures within the scalar framework, while the Iastian includes it merely as a chromatic note:

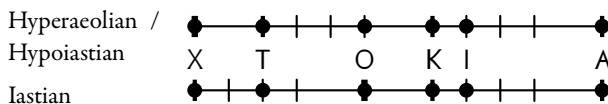

Secondly, the melodic fourth between T and K also points to Hypoianstian/Hyperaeolian, where it bounds a tetrachord of the Perfect System⁴⁹ (the tetrachord defined by the fourth between K and A is shared by all three keys in question):⁵⁰

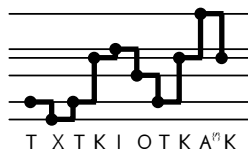

It is noteworthy that the extant notes do not define an explicit genus. While the upper tetrachord takes on the ‘common’ or ‘older enharmonic’ form, the lower part hovers between diatonic (Hypoianstian) and chromatic (Iastian).

All in all, the two ‘excerpts’ show close affinities, but also distinctive features. If they belong to the same composition or play (and are not merely two examples of a similar style), they probably did not stand in immediate context; this is suggested by their arrangement on the papyrus anyway.

Just as problematic as the scalar interpretation of the two fragments remains their date. Whether the basic scale is read as Iastian, Hypoianstian, or Hyperaeolian, we face the same problem as with the Iphigenia Papyrus: the scale in question cannot have been in use before Aristoxenus. This is in fact the strongest argument against dating the music of the Ajax fragment to the classical or Hellenistic era. It seems that we can defend an early date only on the assumption that the piece was originally notated in one of the old keys, to be transposed into (Hypo-)Iastian later. Still, there are the other late melodic features. Among the pieces that we possess from before

⁴⁹ In contrast, the open fifth in N^o17 occurs between notes that are fixed only in Iastian.

⁵⁰ This concentration on functional tetrachords points once more to a composition with aulos accompaniment, as would be fitting for an original tragic score.

the Roman period, the Ajax fragment would also stand out in not making use of at least one explicit *pyknón*;⁵¹ but on the other hand we have seen that much speaks for implicit awareness of chromaticism in both N^o 17 and N^o 18. It has to be admitted that our understanding is not yet sufficient for settling this vexing question.

DAGM N^o 19

Epidaurus, SEG 30.390

late 3rd cent AD

A line of apparently musical signs above an inscribed hexametric hymn has been understood as a melody to be repeated verse for verse, plus a short instrumental interlude.⁵² Tempting as such an interpretation is, several problems must be noted. Firstly, the stone reads

]ΕΝ Ἀ̄ζ̄Θ̄ε̄λ̄ ΕΝΔΟ[

which could be made into a sensible scale only by changing Α into Δ and Θ into ⊖ (the former being the more problematic correction), and by taking λ not as the note, but as the sign for a rest or prolongation (*leímma*, usually something like ∩). Secondly, the first and the last Ε are apparently rounded as are those in the text, whereas that in the central run of signs with diseme strokes is square (if it is an Ε at all).⁵³ At least three notes are seriously misplaced in regard to the syllables to which they supposedly belong. What would be the vocal melody finishes on Ε, on a high note of no structural importance. The supposed postlude can hardly mend this: after a pause (and consisting of short notes) it appears rather as a prelude to the next verse. Finally, even if it is accepted that the melody fits the first verse, it can barely be applied to the others, regarding the diversity of the hexameters' rhythmical structure. In the first verse, the fourth foot has a dactylic shape – ∪ ∪, to the two shorts of which two notes were consequently assigned (a falling major third), while the fifth foot is spondaic – – and therefore received only one note on its second long. Yet in almost all other verses, two notes are required in that position: should the single note of the first verse be resolved into two similar shorts? Even worse is the opposite situation, when the two short notes of the fourth foot come to lie on a single long (as obviously in v. 3 Ἀπόλλω]νι κλυτοτόξω): must here the long be sung with

⁵¹ The Hibeh Papyrus (DAGM N^o 7) unites ΚΑΜ, although not within the same 'fragment'; Pap. Vienna G 29 825 d–f (DAGM N^o 12) is too fragmentary; Mylasa Inv. 3 (DAGM N^o 22) is doubtful; the rest of the early fragments employ *pykná*.

⁵² West 1986.

⁵³ Cf. the exemplary epigraphical analysis by Boncfas 1989 (on the first Ε, 57; on the Ε̄, which appears as Ε̄, 54).

a melisma? On balance, it is inconceivable that the rhythmical idiosyncrasies of a first line impose themselves melodically on the following. One might seek a way out of this dilemma by assuming that the melody for the first line was intended merely as a template, after which the others had to be shaped. Yet on closer consideration it becomes evident that this is mere word-play: it seems impossible to apply a melody of that specific zigzag kind to hexameters of arbitrary metrical patterns.

On the other hand, it is hard to see what the signs of the first line should be other than musical notation. One might consider the possibility that they are meant as a prelude, perhaps to specify the appropriate *nómos* (melody style) for the hymn.⁵⁴ If all readings and corrections of the standard edition are accepted (only the identification of a single note is universally agreed!), the notes are chromatic Hypolydian:

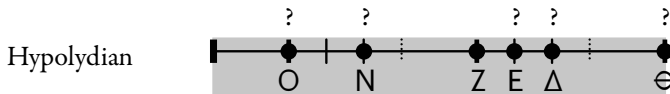

Notably, all fall within the octave of Ptolemy's citharodic tunings; only its lowest note is missing. Although one would not generally expect chromatic music from the time of the inscription, we must remember that, according to Ptolemy, chromaticism survived precisely in the Hypolydian (although on his account only in the higher tetrachord, ZEΔ⊖). Possibly the music is Hellenistic, as has been speculated; but at least some characteristics of this – highly uncertain – scale would still have been standard in the second century AD.

About this most complete piece of Hellenistic music much has been said above: how the *mélōs koinón* of its first section evokes archaic tunes, whereas the second section indulges in the rapid modulations associated

⁵⁴ Cf. Bonefas 1989: 59–60, whose arguments that only the signs with diseme are actually notes are certainly worth consideration. Her musical interpretation, however, is wholly impracticable (apart from not accounting for the diseme strokes and the 'rest sign'); similarly, her reading of the final letters as part of an instruction ἐν ᾧ]δῆ ἴν' ᾠδῆ 'in song' is highly improbable: why should the uncontracted form appear in a directive? The technical term for the preliminary instrumental notes from which the singer(s) took the clue when and how to start is 'ἐνδόσιμον' (cf. Hesych., s.v.; *Suda*, s.v.; cf. also s.v. μουσουργοί; Philo, *Migr. Abr.* 104; Heliod., *Aeth.* 3.2). Could this stand behind the inscription's ΕΝΔΟ[?]

with the ‘New Music’.⁵⁵ Although the rhythm is uniformly paeonic, variation is effected by different position of word boundaries within the metrical feet. Thorough analysis reveals a subtle interplay of ‘Apollinian’ and ‘Dionysian’ rhythms, which underscore the harmonic progress.⁵⁶ This style is a unique example of an evolution already deprecated by Plato, who protests against the poets who break down the borders between different musical genera,

... κεραννύντες δὲ θρήνους τε ὕμνοις καὶ παίωνας διθυράμβοις, καὶ αὐλωδίας δὴ ταῖς κιθαρωδίαις μιμούμενοι, καὶ πάντα εἰς πάντα συνάγοντες...
(Plato, *Leg.* 700d)

... admixing dirges to hymns and dithyrambs to paeans, imitating aulos-songs on the cithara, and fusing everything with everything...

We will not fail if we see such an element of originally dithyrambic music admixed to a Paean in the modulating second section. Even the role of the cithara is addressed there, within a melodic turn that obviously re-enacts its conversion to the aulos style, thus paying reference to the sculptural programme of the Delphic temple, which featured Dionysus as a citharist leading his dithyramb. The ever-changing scalar configurations of its typical music were perceived as an appropriate expression of the god’s very nature:

καὶ ᾄδουσι τῶ μὲν διθυραμβικὰ μέλη παθῶν μεστὰ καὶ μεταβολῆς πλάνην τινὰ καὶ διαφόρησιν ἐχούσης ... τῶ δὲ παιᾶνα, τεταγμένην καὶ σῶφρονα μοῦσαν, ἀγήρων τε τοῦτον ἀεὶ καὶ νέον, ἐκείνον δὲ πολυειδῆ καὶ πολύμορφον ἐν γραφαῖς καὶ πλάσμασι δημιουργοῦσι. (Plut., *De E ap. Delph.* 389a–b)

To [Dionysus] they sing dithyrambic songs, full of changes⁵⁷ and modulations incorporating a sort of illusion and shift, ... but to [Apollo] the paean, an orderly and temperate art, and in images and statues they represent him always ageless and young, but Dionysus manifold and multiform.

⁵⁵ For an extensive interpretation, see Hagel 2000: 38–93; 2002. Barker (2002: 119–32) analyses the first section along entirely different lines. For the astounding closeness of the melodic line to speech melody, cf. Devine/Stephens 1994, *passim*.

⁵⁶ Such a distinction is made possible by the terms applied by ancient theorists to the different word forms that can fill the five-time rhythm, which often derive from the cults of Apollo and Dionysus, respectively, namely from the typical forms of sub-literary cult songs and dances. A statistical analysis reveals their purposeful application in the present paean: Hagel 2000: 135–64; summarised in Hagel 2002.

⁵⁷ For the musical sense of πάθος, cf. Aristox., *Harm.* 2.38, p. 47.20; Cleonid. 11, p. 201.14–202.5; Aristid. Quint. 1.11, p. 28.6–7.

Nothing could express better the contrast between the first two sections of Athenaeus' Paean, as well as the eluding character of those 'Dionysian' melodies, on which several other early fragments also allowed us a glance. As in these, the notation is here basically Phrygian, the most typical aulos key; the most frequent note is the functional Phrygian *mésē* M, just as one would expect for this kind of music.

Although the two Paeans exhibit not only thematic similarities, but also share the paeonic rhythm, a favour for word-painting, and even some melodic details,⁵⁸ there are striking differences as well. Most eye-catching is that Limenios' composition contains nothing remotely comparable to Athenaeus' 'Dionysian' part. It seems as if the citharist refused to depart from the more traditional 'citharodic' line of writing Paeans. His employment of the more archaic instrumental notation, within the old 'natural' scale, in contrast to Athenaeus' 'auletic' Phrygian in vocal signs, strikes much the same note. To this add the rhythmical evidence: where Athenaeus employs a variety of word forms of different character, Limenios' text is characterised by cretic and paeonic words, which emphasise the boundaries between metrical feet.

The disposition of the note material mainly confirms the citharodic nature of the Paean. Most of the employed notes, and all that are common to more than one key, are precisely contained within the ninth from *hyperypátē* to *nētē diezeugménōn* that we have established as the probable gamut of the classical cithara:

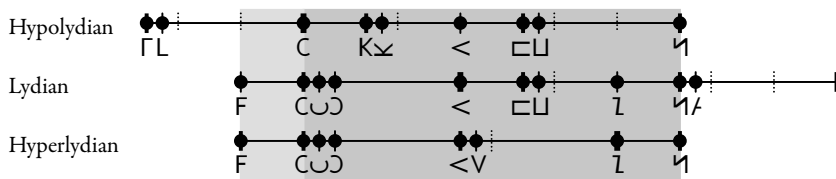

Of the twelve notes within this range, C and K coincide in pitch; plausibly, then, Limenios' cithara had eleven strings. This was apparently Timotheus' standard, extolled by Ion of Chios' celebrated verses.⁵⁹

⁵⁸ Cf. Pöhlmann 1960: 65–70.



⁵⁹ Timoth., *Pers.* 229–31 Page; Ion of Chios, cf. n. 96 on p. 87 above. For this eleven-stringed lyre, Gevaert 1881: 260–2, and West 1992a: 26–7, propose precisely the tuning structure that can be read

The places where the voice departs from the compass of this instrument deserve special mention. The low register appears only in the Hypolydian parts.⁶⁰ But the respective two notes, Γ and L, appear in quite different circumstances and are never associated with each other. Γ is by far the more frequent. All of its sixteen extant instances involve large leaps from and to the higher register. Five times we encounter octaves with □, twice a fourth with C, twice a fifth with K, but also more difficult intervals, twice with ∞, thrice with L, and, probably, once with ♯.⁶¹ One must state that Γ does not belong to a melodic scale in the same sense as all the other notes; it is reserved for momentary plunges, often programmatically motivated.

Entirely different is the case of L, which is used extremely sparingly. It makes its appearance not before the third section, where the artists come to sing about their own role (ll. 20–1). In the foregoing, Apollo's birth had been narrated, followed by his first travel to Attica. The account of the music that accompanied this mythical event reflects the performance of the paean. Then the focus turns explicitly towards the present: since that time, the Athenians call Apollo by the name of 'Paiéon', which is, they sing paeans to him. Here the sentence seems to find its end with one of the octave plunges.⁶² Thus the following eight bars, which introduce the performers as the 'guild of Dionysus', are melodically detached, although syntactically merely extending the subject of the sentence. Here the note L is introduced, through a fall of a tritone, on the word *thyrsopléx*, 'thyrsos-stricken', which

from the shaded field in the chart. Cf. also the eleven tuning pegs on the cithara of the Eros of Mahdia, dating from the period of the Paeans (Vendries 1999: 73 with pl. 11b).

⁶⁰ For the harmonic programme of the alternating Lydian and Hypolydian sections, cf. Hagel 2000: 94–9.

⁶¹ In l. 23, the stone has N, which is perhaps paralleled in l. 27. In view of the otherwise clear-cut scales this can barely represent some 'exharmonic' note (*DAGM*: 84: note how difficult it is to find a pitch for it). I suppose the lapicide, more acquainted with bidirectional inscriptions than with musical notation, miscopied the ♯ (inverted archaic N) of his exemplar as a straightforward N. To his excuse it must be said that the sign had previously occurred only once (l. 14). There, however, and in the subsequent occurrences in ll. 31–3, it has the unusual shape ∞. The blame for this should probably also be put on the lapicide, who might have mistaken it here for a kind of sigma: the written form remained the archaic ♯ until late antiquity (cf. *DAGM* N^o 51.15: ; N^o 61: ); cf. also the stone's regular idiosyncratic I (zeta, cf. l. 33 ληζόμενος; 34 σῶιζε) for – instrumental! – I (= N rotated; elsewhere always in this shape: N^o 3; N^o 11; N^o 51; N^o 52; N^o 61, all papyri), apparently also a misunderstanding unlikely in anyone acquainted with the notation as a system. If the present explanation of 'N' as ♯ is accepted, we obtain a huge upwards leap of an eleventh in ll. 22–3. For this exceptional interval (but cf. l. 31, where it is bridged by only one – missing – note) it is not difficult to conceive a programmatic motivation: it occurs on the word 'Parnassus' and illustrates its vertical cliffs, rising immediately above the holy precinct.

⁶² For melodic demarcation of syntactical units in ancient Greek music, cf. Hagel 2004b.

contributes the most vivid Bacchic association in the whole piece. Without doubt the composer alludes to the non-Apollinian capacities of his association, which threaten to break through at the mere mention of its Dionysian background.

Only once is another L read (l. 22). It stands at intervals of sevenths between two □, over the monosyllabic imperative that calls for Apollo's epiphany on the mountain ridge. This is certainly a point which deserves special musical treatment. In comparison, Athenaeus puts his first modulation on the verb that speaks out the epiphany; shortly before, he has introduced a new note to mark the god's arrival at his holy precinct, which also effects the shift of focus from the mythical world to the present ritual. Nevertheless one wonders whether L is not perhaps just an error for □ here.⁶³ Elsewhere (with the exception of the tritone just mentioned) Limenios reserves falling intervals of a fourth or larger for syllables that carry, in spoken language, the downward-glide after a word accent. Here a L would induce an all the more patent divergence from the general line of speech melody, because the resumption of the sentence after a relative clause would call rather for a return to a higher pitch.

The third and last note that falls outside the cithara range is ♯. Its belonging to the '*hyperbolaïon*' tetrachord sufficiently proves its irregular status from a more traditional viewpoint (nevertheless we have seen that such notes were obviously played as harmonics on the cithara). The air of transgression which the term *hyperbolaïos* conveys is taken advantage of to symbolise the Galatian assault: only here is this note found. The practice was obviously conventional; when Athenaeus addresses the issue, he similarly goes one semitone beyond his otherwise top note.⁶⁴

In citharistic 'Lydian' the *mésē* < as the instrument's central string falls together with the functional *mésē* of the *tónos*. This is also the pivotal point around which the modulations revolve, and we are not surprised to find its modal prominence confirmed by the fact that it occurs more often than any other note.

⁶³ So Reinach 1912: 165.

⁶⁴ For further discussion relating the paean's melody to the accompanying instruments, see below, pp. 350f.

With the next piece we have crossed the temporal gap that separates Hellenistic from Roman Imperial music, and come within Ptolemy's sphere. The uniquely well-preserved condition of the so-called Seikilos song, its shortness, its straightforward rhythm, and its immediate appeal to the modern ear have earned it the position of the typical example of ancient Greek music, often found even in schoolbooks. Modern interpretation welcomed it as a confirmation of the theory of octave species (its notes form a 'Phrygian' octave), which practically all other musical documents frustrated (the fact that it is notated rather in the Iastian *tónos* was dismissed on the assumption that the *tónoi* lacked all modal connotation anyway).⁶⁵

The octave within which the melody moves is definitely not that of Ptolemy's tunings, but one fourth lower. Thus it would suit a tall lyre, if a lyre at all; above we have wondered if the Iastian might have had some association with a deeper instrument:



On the other hand, it must be borne in mind that the two notes that actually exceed the citharodic ninth occur merely once, at the end of the song:

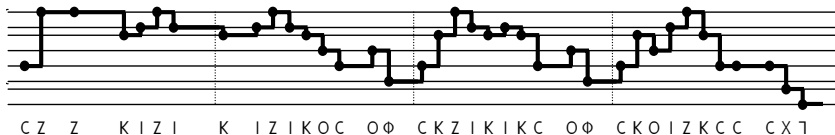

In contrast, the note below the tonal centre C is twice employed as a 'wrong' final within the piece. Notably this is Φ, the *hyperypátē* of the reconstructed 'ordinary cithara', so that the stringing of this instrument would nicely account for the distinction between a general range and a final plunge (whose notes would have been accompanied by octave-doubling).⁶⁶

In any case, the modal characteristics of the song are defined by a focal G (C) with secondary and final D (Z and Γ), which conforms to what we expected for Ptolemy's *iástia* as well as to the common tendencies of Iastian pieces. The modality is marked out at the very beginning by a leap over the fifth CZ.

⁶⁵ Cf. Solomon 1986, who accordingly confines his analysis to this single piece. His attribution of 'thetic' degrees to the notes of the piece (cf. Duysinx 1981: 307–10) also depends on its gamut of a single octave; this involves a thorough misunderstanding of Ptolemy's system, in which thetic note names are defined by relation to his 'Dorian' *tónos*. In effect, Solomon tacitly (and, it seems, unconsciously) equates Ptolemy's 'Dorian' with the notational 'Hypolydian'.

⁶⁶ Cf. the recent parallels cited by Baud-Bovy 1983: 8–9.

The same CZ fifth opens the short invocation of the Muse, which was preserved by manuscript tradition together with hymns by Mesomedes. This piece, however, is composed in Lydian (with modulation into chromatic Hypolydian):⁶⁷

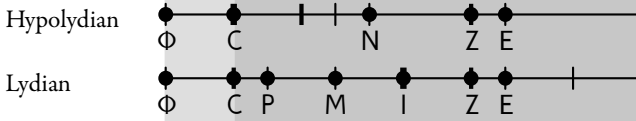

Here the notes of the opening fifth have the modal values of *E* and *B*, respectively, which describe the tonality of the piece quite well: C is the initial and final, Z the most frequent note.

The comparison with the Seikilos song teaches us that an initial CZ setting up the tonal environment was typical for more than one mode.⁶⁸ Its recurrence may be understood as a token of citharodic practice with its 'thetic' view on strings: a similar playing technique, here visible as the combination of *hypátē* and *paramésē* – probably realised as a typical fingering to a plectrum stroke, augmented in sound by *nētē* – assumed different modal values in different tunings. In fact this combination turns out to be the most frequent melodic fifth in ancient Greek music. There is little doubt that it continues an age-old tradition, being the interval of maximum resonance on the seven-stringed yet octave-ranged lyre ascribed to Terpander.⁶⁹

Another parallel to the Seikilos song concerns the general range: the melody remains for the most part between *hyperypátē* Φ and *paramésē* Z:

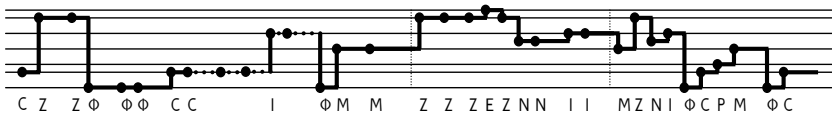

Here, too, it departs once from this range, although it does so neither at the end nor towards the lower region. A single high E is introduced within a small ornament, immediately preceding the modulation.

⁶⁷ For a detailed interpretation, see Hagel 2000: 107–12.

⁶⁸ Might the recognition of the typical starting note (also in DAGM N^o 25; N^o 27; first accented in N^o 50; cf. also N^o 51) stand behind the somewhat enigmatic Ὑπάτας πράτας in SEG 30.382 (cf. n. 80 on p. 27 above)?

⁶⁹ There are 23 instances of CZ or ZC. Naturally, next in order is ΦI with 20 examples, which produces a similar resonance on a nine-stringed lyre including *hyperypátē* and fits the later style better. Here, however, the falling variant is favoured.

As regards fine tuning, little is to be said for, and nothing against Ptolemy's *lydia*. There are certainly no traces of a *G* mode. Still, all the fourths and fifths of this melody are pure in *lydia* (but not so in *parypátai*), as long as *paramésē* is not altered. As stated above, this observation may add to the suspicion that the piece is perhaps of an earlier date.⁷⁰

DAGM N^o 25

Invocation of Calliope and Apollo

2nd cent. AD (?)

Similar in content and tonality is the invocation of Calliope and Apollo. It is also notated in Lydian; at one place the manuscripts have N, which effects the same modulation into chromatic Hypolydian as in the previous piece. The ambitus is larger, though; it extends from Γ to E, thus combining the ranges of N^o 23 and N^o 24:

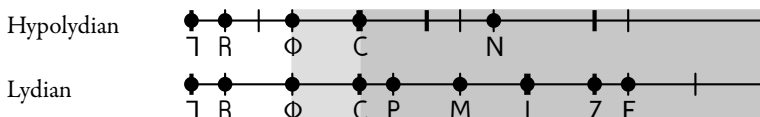

Just as there, the lowest Γ and the highest E are used only once, and the melody centres on the *mésou* tetrachord, the most comfortable region of the voice. Tonal centre, initial and final note is C, yielding once more an *E* mode, but this time without clear secondary tonal centre. The fifth from *mésē* I to *hyperypátē* Φ (which earned the latter the name of *diápeptos*) is emphasised once; but there are no intervals that would allow us to speculate about the fine tuning.

DAGM N^o 27

Mesomedes, Hymn to Helios

AD 100–150

The two hymns by Mesomedes we are going to consider now share certain characteristics with the preceding pieces; still, they are closer to each other than to them. Both are composed in the same stichic metre and stick to a simple diatonic Lydian scale, within which the melody gravitates towards the *mésou* tetrachord. The range of the Hymn to Helios goes up to E as in N^o 24 and N^o 25; only once and on a short note does it drop below *hyperypátē*:

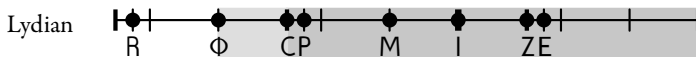

⁷⁰ Cf. above, p. 237.

The initial and final note is once more the *hypátē* C, and it reasserts its role as a possible tonal centre from time to time. Nevertheless, the *diátonos* M appears almost twice as frequently; often it forms a harmonic regime together with *paramésē* Z, which is clearly different from that of C. The primary tonal centre C is introduced by one of the typical resonant intervals; interestingly it is here combined in a fourth with *mésē* I, so as if to leave the Z to the alternative harmonic domain of M. This is the dichotomy inherent in *lýdia* that we have postulated above, between the harmonic-series-generated *G* mode and the (presumably) older *E–A* axis of *mésē*-centred music. The hymn illustrates how this opposition, which was doubtless reinforced by the accompaniment, could be made fruitful.

The absence of the CZ fifth in combination with frequent emphasis on the MZ third makes the hymn a clear candidate for the presumed adjustment of *paranētē*. It is all the more remarkable that the *G* mode does not dominate, after all. Did the strong Apollinian association call for the more traditional option?

The melody of the Nemesis hymn makes considerable use of a higher register, extending the scale up to *paranētē* U. On the other hand, it dives below *hyperypátē* thrice (still 98.4 per cent of the notes fall within the reconstructed compass of the cithara):

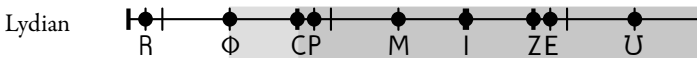

The tonality is pure *G* mode *lýdia*, the tonic M accounting for more than one third of the melody. To its sphere belongs *D*, above all, both as Φ and as U – which explains why this rather high note is so frequent here, while it was not used at all in the preceding pieces. Most of the melodic fourths and fifths occur between these notes. The most beautiful example of how the harmonic series could guide to the tonic is the following sequence from verse 10:

Φ P P M I P M M
6 7 8 9 7 8
-ρού-μενον αὐ-χέ-να κλί - νεις

Second in frequency is *mésē* I, which nevertheless does not form an alternative harmonic domain. The only note that builds up a real contrast to the dominance of the *G* series is the *tritē* E. The tension that this note can create becomes most evident at the verse-initial imperative with which the invocation of the goddess, including the description of her nature and function, turns into prayer. After that verse is brought to a 'wrong' end on P, E is resumed once more, but this time resolved to final M (vv. 14–15). The effect of the sudden emphasis on E is prepared by repeated I at the end of the preceding verse. Above we predicted such an association of (vocal) *tritē* and *mésē* as the likely consequence of the divergence between vocal and instrumental fine tuning in the upper tetrachord as described by Ptolemy.⁷¹ Of course, the single passage proves nothing; still the coincidence seems worth mentioning.

DAGM^N 32–7

Anon. Bell. §§97–101; 104

3rd–4th cent. AD

Six short pieces in instrumental notation form a kind of appendix to the compilations known as Bellermann's Anonymi. All are written in the Lydian key. Their focus is evidently on rhythm, each piece being labelled according to the number of beats each bar contains.⁷² Nevertheless it is commonly assumed that they have also a more practical background as basic instrumental exercises, presumably for aulos.⁷³ Notable are the differences in ambitus and melodic style. Two of the pieces are merely permutations of the lowest four notes of the Lydian Perfect System; one ascends and descends from *proslambanómenos* to *mésē* and back. Four do not exceed a fourth or fifth, two extend over different octaves:

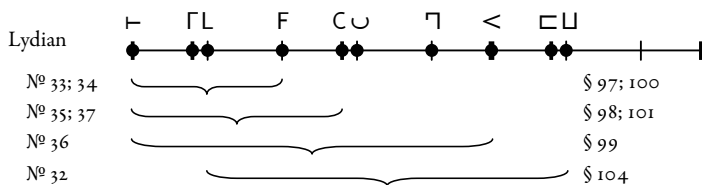

The unusual low pitch and the inclusion of the *proslambanómenos* confirm that the instrument in question is the aulos; more specifically, an aulos of the type whose lowest pitch was the *proslambanómenos* of its basic key.⁷⁴

⁷¹ Cf. above, p. 241.

⁷² Cf. Hagel 2008b.

⁷³ Cf. Najock 1972: 175; *AGM*: 309.

⁷⁴ Cf. below, pp. 328ff.

N^o 32 stands out for its melodic character, its extended range and also because it alone does not base its scale on the *proslambanómenos*, with which all the others begin and – if they are only remotely melodic – end as well.⁷⁵ But in N^o 32 the final note is *mésē* <. The octave that bounds the melody is emphasised both at the outset and, if we can trust the manuscript at this point, immediately before the end:

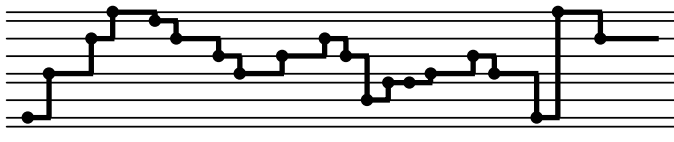

L ◡ <◡ ◡ < ◡ ◡ ◡ <◡ ◡ ◡ ◡ ◡ ◡ ◡ ◡ ◡ ◡ ◡ <

This octave, which so unmistakably draws our attention towards itself, marks out nothing other than the ‘Lydian octave species’. Thus the short piece seems finally to provide some connection between this concept of enumerating and classifying theory, so often over valued in modern interpretation, and musical practice.

Yet apart from the mere extension of an octave, its position within the scale is, in all likeliness, as closely linked to practice as any feature of ancient Greek music. Moreover, it is ultimately associated with a surprisingly early stage. To understand it, we must turn back to the final steps of the pre-Aristoxenian tonal system, when auloi had at last learned to play in all three primary modes, Dorian, Phrygian and Lydian. We have seen that the respective highest notes of these were set to the same pitch – a fact that found its proper explanation in the playing technique of such modulating instruments.⁷⁶ This common ‘*nētē*’, apparently indicating the pitch of the highest finger hole of an important type of modulating aulos, corresponds to the instrumental note N, which evidently stood for the name of the note. In the Lydian (and Hypolydian) key, however, the same pitch has to be analysed not as a ‘fixed’ note, but as the highest member of an enharmonic *pyknón*, to be notated as ◡, or as the chromatic or diatonic *tritē* ◡. Now this is also the highest note of our auletic exercise. Thus we may suspect that the piece owes its tonality to a tradition that goes back to the first multimodal instruments in the late fifth century BC. If so, this small melody with its combination of a ‘Lydian’ octave and a tonal centre on functional *mésē* is perhaps

⁷⁵ The manuscript layout also detaches N^o 32 from the rest. The arrangement in *DAGM* is based on its heading κῶλον ἐξάσημον, which thus nicely precedes the otherwise meaningless ἄλλος ἐξάσημος of N^o 33 (cf. *DAM*, 39). Still, the incongruence of gender must be noted.

⁷⁶ Cf. above, pp. 34 ff., with Diagram 9 on p. 36 and Diagram 11 on p. 42.

the only extant example of the Lydian key used to notate modally Lydian music in what we have called the auletic approach to notation.

In contrast, № 33–7 exhibit no modal characteristics. As regards their focus on the *proslambanómenos*, they could serve as beginners' exercises on any instrument that went as far down as to this lowest note of its key.⁷⁷ This opens up another possibility of using the notation with which we must reckon, although it further confuses the neat distinction between a citharistic and an auletic view. Conceivably the original method of notating simpler melodies in the natural 'Lydian' signs regardless of pitch was never entirely abandoned even by the auletes. For complex music on virtuoso instruments one could not do without the *tónos* model. Still, there were other, cheaper types of instruments. If these came in various sizes, yet similar designs, it would have been the most natural thing to use similar notation for similar fingering – just as with modern 'transposing' wind instruments. In this way, the *tónos* approach to pitch could even coexist with an entirely different system of pitch differences governed by instrument size. One will think especially of the 'girls' auloi' and 'children's auloi' mentioned by Aristoxenus side by side with types played by adults.⁷⁸ When Aristoxenus says that all types together encompass more than three octaves,⁷⁹ it becomes clear that their pitch differences are substantially unlike those of the *tónoi* system (which Aristoxenus did not extend so far), and consequently also of those of contemporary notation. If anybody was going to write aulos études for boys and girls at all (but who else should have needed such fundamental exercises as № 33 and № 34?), they were forced to employ notation of 'inappropriate' pitch, that is, to apply the notes to ranges other than those that emerge from the vocal scores.

As a consequence, we must be careful to postulate the usual absolute pitches for purely instrumental scores, if they are written in the Lydian key and probably for the aulos. Only if there is additional evidence that the piece in question belongs to the '*tónos* paradigm' is such a conclusion warranted.

⁷⁷ With all finger holes closed, the pipes of an aulos now in the Louvre sound the *proslambanómenos* (described in Bélis 1984c; evaluated in Hagel 2004a: 384–5: "Hypolydian"; but see below, pp. 332 ff.). If the melodies are transposed, № 33–5 and 37 can be played on its lower pipe, № 36 by alternating between the two pipes (although the lower pipe covers precisely the required octave, only part of it can be accessed at once).

⁷⁸ Ath. 634ef (cf. also 176ef). For a discussion of ancient testimonies for various aulos sizes, cf. Howard 1893: 38–41.

⁷⁹ Aristox., *Harm.* 1.20–1, p. 26.8–27.1.

This papyrus was supposed to contain Roman Imperial music set to an earlier dramatic text.⁸⁰ It is notated in Lydian, with occasional modulation into Hypolydian. The bulk of the melody is confined within the citharodic ninth (97.7 per cent); the better preserved right-hand column stays entirely within this compass. The left column contains two instances of R, one tone below it:

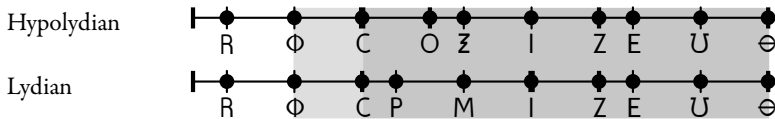

The modal characteristics are those of Ptolemy's *lydia*: the most frequent notes are M, U and Z, forming a 'G-chord' whose importance is underlined by progressions between them in fifths and thirds (a fourth and an octave with Φ also takes part in this structure). The frequent thirds suggest a re-tuned *paranētē*. The modality thus indicates a citharodic setting.

This and the following piece are evidently from an artist's anthology:⁸¹ similar in theme, and dramatic or monologic in nature, they can nevertheless hardly belong to the same play. From frequent cancelled notes and, above all, the existence of double melodic versions for several passages it appears that the papyrus is the composer's autograph. Probably he arranged an older text for concert performance: in this case, cithara accompaniment is at least as likely as the traditional aulos of drama.

The analysis of the note material involves serious problems. Generally the melody modulates within the Iastian triad; but two passages also employ a Λ, which cannot be interpreted out of the regular scales of the notation:

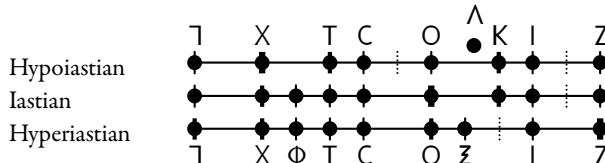

⁸⁰ Winnington-Ingram/Turner 1959: 114-15; *AGM*: 311. For the general practice, cf. Latte 1954.

⁸¹ For the following, cf. the exemplary study by the first editors, Eitrem/Amundsen 1955 and Winnington-Ingram 1955.

These two passages set aside for the moment, the piece analyses into Hypoastian and Hyperastian sections. The Iastian core scale binds them together not only because it provides the common tonality on which modulations are based, but also in that all notes can be described in terms of the Iastian Unmodulating System, if it is equipped both with the *diá-tonos* (C) and *khrōmatiké mesón* (T).

The melody extends over an octave, which however lies one fourth below Ptolemy's octave. This and the Iastian key associate the present piece with the Seikilos song (№ 23), in spite of their dissimilarity as regards musical complexity. Once more one might entertain the idea of a tall lyre. It would seemingly have covered only an octave, although with modulating capabilities that hardly fell short of the 'classical' variant.

Too little remains of the passages that include Λ to identify its function with absolute certainty. It has been concluded, I believe rightly, that it must designate a pitch one semitone below K, its predecessor in the alphabet.⁸² This is a practice we are familiar with; the only surprise is that this is here no alien pitch: in different contexts, it is notated with the regular Ζ. At any rate, sensitivity of context as such is part of the system (for instance where a conjunct *khrōmatiké* and a disjunctive tone are distinguished, as in the Delphic Paeans). Even so, such an awareness of 'function' is noticeable where the note sign in question is not taken from the regular system at all. Apparently composers were aware of their modulations even if they did not necessarily analyse them in terms of abstract Aristoxenian *tónoi*. A differentiation by note sign may have helped to maintain a general view of the tonal progress.

The notes between which Λ is found suggest that it introduced a chromatic *pyknón* between O and K (which 'ought to' have been written OΖ N, within the Iastian *synēmménon* tetrachord). Below it, we find either a tone or a step of one and a half tones: the former suggesting a disjunction, the latter another chromatic tetrachord in conjunction:

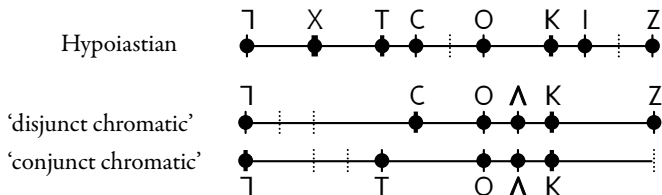

The melody can be analysed in nine sections, which were marked by the

⁸² Winnington-Ingram 1955: 46–7; *DAGM*: 129.

first editors.⁸³ Because of the florid modulations, the greater part of them is identical with lines on the papyrus: transitions between different tonal patterns often taken place within the lost parts.

The start of the fragment is of greatest interest because it allows us to observe a composer of the Roman era right in the creative process. Lines 2 and 3 present us with two melodies: what is obviously the prior version stands immediately above the text; a quite different melody is cramped into the remaining space above. Whether the same was true for the first line is no longer discernible. In the first version, the initial four lines stay within one straightforward scale, which is the Hyperiaastian:

(1) fr. a.1-4, version a:

O Z Z C Φ O Z Z C O O | I Z O I C Φ I Φ Z C O

Hyperiaastian

C Γ Γ C Φ C O Φ C O Z Φ C Φ Z Γ

Hyperiaastian

It goes without saying that we cannot exclude the possibility that the missing parts contained some surprises; nevertheless, we are bound to analyse merely what we have, and to be content if we obtain a coherent, albeit necessarily incomplete, picture.

On second thoughts the artist decided to enrich the passage with modulation into chromatic in the lower tetrachord (discernible by the introduction of T, and also suggested by X, which is more than once associated with such a scale in what follows):

fr. a.1-3b

C Z C C O C Φ X | I Z O I T Γ Z Φ Γ Z X

diatonic Hyperiaastian diatonic

chromatic

⁸³ Winnington-Ingram 1955: 42-7.

The chart shows how the short modulation is prepared beforehand by restricting the melody to notes common to both scales. Similarly slowly the melody slides back to the original tonality; the distinctive C is not re-introduced until the papyrus breaks off. In any case, we have seen that line 4 is once more diatonic.

In line 5, however, the melody has returned to the chromatic. Here its structure is unmistakable: a disjunctive tone, below a *pyknón*, below a minor third, below the fourth of another conjunct tetrachord, which is not further divided. Two notes are cancelled without replacement:

(ii) fr. a.5

Ο Φ [Ο Ζ] Τ Χ Τ Γ Χ Φ

chrom. (Hyper)iasian

In the following line, Λ appears for the first time. The ensuing chromatisation with frequent transitions between different arrangements of the note material is certainly reminiscent of the Hellenistic documents. Still, the modulations are carefully mediated by runs of common notes:

(iii) fr. a.6-7

Τ Λ Λ Λ Λ Γ Κ Ο C Χ Τ Ζ C K C O K Ο Λ Ο Τ Ο Τ C O C Χ Τ

Hypoiastian Hypoiastian

'disjunct chromatic' 'disjunct chromatic' 'disjunct chromatic'

'conjunct chromatic' 'conjunct chromatic' 'conjunct chromatic'

What appears to be a radical change of melodic style is associated with a shift of focus in the text. Up to here a vision of the Underworld was described; now the narrator turns to its effect on some Trojan women, who are apparently deterred from a planned assault, dropping their swords; at the end of this section the speaker emotionally addresses and reassures Deidameia (mother of Achilles' son Neoptolemus), who is seemingly upset by the report.

In the next line a verse ends with the apparition of dead Achilles himself; once more, modulation *katá génos* between diatonic and chromatic is employed:

(iv) fr. a.8.1-14

C Φ O C Φ X Γ T T X X Φ C

diatonic chromatic diatonic

The Hyperiaastian is maintained in the following description of the Trojan women's flight, with a brief modulation when their swords are once more mentioned. When the voice of Achilles is heard, the melody stays within the higher fifth:

(v) fr. a.8.16-9

Γ Γ Γ C O I K I Z O Z C Z Z Z O Z Z Z O C Z O

Hyperiaastian (Hypo)iaastian Hyperiaastian

The following line contains no harmonic surprises either:

(vi) fr. a.10

Γ Γ Γ T X T Γ C C C I O C Φ X

Hypoiaastian (Hyper)iaastian

Of the next couple of lines, only a narrow strip of papyrus remains, so that even a provisional determination of the tonal plan becomes impossible. The second appearance of Λ may have marked another intrusion of a 'disjunct chromatic'. Below there was some Hypoiaastian; but it seems that the composer decided to remain within the Hyperiaastian instead, since the distinctive Hypoiaastian notes are crossed out:

(vii) fr. a.11

Z Γ K A K C Λ Z C

Hyperiaastian (?-)iaastian disjunct chromatic

(viii) fr. a.12

[Z Z] C C K

(Hypo)iaastian

In any case, the piece ends, just as its extant part began, with pure diatonic Hyperian, which confirms the primary status of this scale:

(ix) fr. a.13–15

Hyperian

This impression is confirmed by the note counts: of the distinctive notes, Hyperian Z̄ is almost four times as frequent as (Hypo-)Iastian K (T appears in both contexts).

The most frequent, and at the same time the typical phrase-final, note is C.⁸⁴ On a low-pitched lyre such as hypothetically envisaged it would assume the place of ('thetic') *mésē*. Taking into account the range of Γ to Z, which is here clearly a melodic octave and not merely a smaller compass expanded by occasional dives, we would describe the tonality as a *D* mode within an octave species to be described as Hypodorian (accordingly, the piece ends on *A*, which is reached by a fall from *D*, from hypothetical 'thetic' *mésē* to *hypátē*).

Whether such a low tuning should be related to Ptolemy's account, and if so, in which way this should be done, is very doubtful. If the notational keys are maintained, Hyperian is associated with Ptolemy's *hypértropa*, which can in principle host a *D* mode, although this would not be the primary choice (cf. Diagram 56 on p.224 above).

On the other hand, it would have been much more natural to transpose the entire system of cithara tunings one fourth down, so that all tuning procedures remain in principle (but not in pitch) identical on both types of lyre. In this case, the keys of a deep-pitched lyre would shift by one towards the 'chromatic' scales: *lydia* and *parypátai* would have to be notated in Hypolydian, *tritai* and *trópoi* in Hyperian, *hypértropa* in Iastian, and *iástia* in Hypoastian.⁸⁵ Thus the present piece would be associated with *tritai* (*trópoi* including a chromatic upper tetrachord), one of Ptolemy's 'Hypodorian' tunings, in accordance with its bounding octave. This hypothesis has the advantage that we have found *tritai* especially suited for a *D* mode.

⁸⁴ Cf. Winnington-Ingram 1955: 50–1.

⁸⁵ Note that this is the scheme presupposed by Porphyry; cf. above, pp. 61 ff.: has he wrongly attributed Ptolemy's system to a form of instrument that had come to flourish by his time? Implicitly, the same system is assumed by Winnington-Ingram (1955: 49–50; 54 with n.1) without further elucidation (obviously on the basis of an alleged 'central range' of the notation from Γ to Γ with Hypolydian *mésē* CC as the seeming structural centre note of the notation).

Independently from these highly speculative considerations, the dominant melodic fourths might be taken as supporting the theory of a deep-pitched lyre: they would emphasise the usual harmonic framework of the octave, ('thetic') *hypátē – mésē* and *paramésē – nētē* (here Γ -C-O-Z).

Ten strings would suffice to play all melodic notes, assuming that Λ and \bar{Z} are really of identical pitch. Their symmetric arrangement round the 'thetic' disjunctive tone can be read from the lines onto which the melody is above transcribed.

This second piece from the same papyrus as the previous item contains iambic trimeters set to music. It is basically Lydian with one unambiguous modulation into Hypolydian:

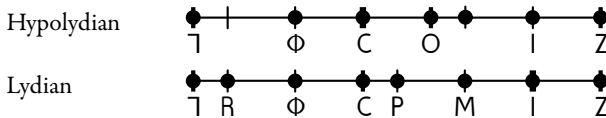

It is however conspicuous that the definitely Lydian P, which is found six times in the first three lines, is missing from the remaining two, where the modulation takes place. Consequently there is no unequivocal return to Lydian, its M being identical in pitch with Hypolydian \bar{Z} (which is never written). Possibly, therefore, the final line still 'feels' rather Hypolydian.

The range is the same as in N^o39. This time, however, the two notes that fall outside the citharodic ninth are used only once each, so that 96 per cent of the melody stays within it. Moreover, R has been described merely as "probably the right interpretation",⁸⁶ and Γ appears in close connection with Z an octave higher, in a verse-initial figure that recalls similar figures in Limenios' Delphic Paean (N^o21). In that composition, which apparently presupposes the 'classical' citharodic ambitus, we found no less than five octave leaps between the same two notes (Γ and \square , in instrumental notation). An ascription of the present piece to a lower-pitched instrument is thus not necessary. As regards the hypothetical tall lyre, it must also be remembered that of the models considered in the foregoing, the more prob-

⁸⁶ Winnington-Ingram 1955: 30. Note however the cautious use that Limenios (N^o21) makes of the same note (instrumental: L).

able leaves no room for a low Lydian, since its 'lydia' would require Hypolydian notation.⁸⁷

By far the most frequent note is *diátonos* M, which points to the well-known *G* mode of *lydia*. Its harmonic adversary *mésē* I is emphasised in verse-final position immediately before the modulation takes place. Conceivably it foreshadows the change of key: we have identified thetic *mésē* as the typical candidate for a Hypolydian focal note. The Hypolydian O is also familiar to us as the long-standing *kbrōmatiké*: all in all, the piece is in best accord with Ptolemaic standards.

DAGM N^o 41

Pap. Yale CtYBR Inv. 4510

early 2nd cent. AD

Another example from a performer's collection is the remains of two arias on a papyrus of unknown provenance.⁸⁸ Both are notated in Iastian; the first is of special interest for its florid style with a melisma on no fewer than nine notes, and a transitory plunge into the lowest region of the voice. Its span of more than two octaves is otherwise unparalleled.⁸⁹

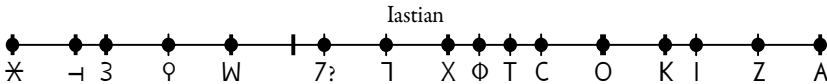

No lyre or aulos can have had such an ambitus (the lowest note is not even part of the fifteen-scale system), and harps were not used by (male) star performers: here at last the most pertinacious sceptic will have to admit that a note-to-note 'accompaniment' is out of the question, and that we were right in cautiously dissociating the problem of instrumental compass from the vocal fragments.

The scale is generally diatonic, but sometimes chromatic T appears. Its association with X and Φ confirms our interpretation of the respective chromatic passages of N^o 39.

The lowest note, ♯, demands special attention. The editors have transcribed it one semitone below −, at a pitch that does not match any of the upper octave and creates a melodic scale of intractable irregularity: ♯ – semitone – − – semitone – 3 – tone – ϕ – tone – W. That the regular de-

⁸⁷ The preference for M instead of Z proves that Lydian is indeed the basic scale, and not *synēmménon* modulation.

⁸⁸ For an enlightening discussion of the problems posed by the document and its importance for our understanding of Roman Imperial music, cf. Johnson 2000a.

⁸⁹ Where West (in DAGM) reads 3, Johnson 2000a: 74, prefers to see a rounded form of Z, indicating *synēmménon* modulation. This question has little effect on our conclusions here.

gree one whole tone below \neg (as printed in the above chart) might in fact be meant has nevertheless been considered, presupposing, given the rarity of \times , some “confusion about its significance”.⁹⁰

The confusion, however, is modern. The alleged ‘correct’ interpretation of \times was apparently derived from the assumption that, if a given key is prolonged downwards beyond *proslambanómenos* and out of any known Perfect System, its structure relative to the triplets of note signs should duplicate the structure found an octave above. Thus one would merely start from the known signs and count twenty-one positions downwards (seven notes \times three notes in a triplet). Although this seems all but reasonable, and although it works for octave relations within the fifteen-key system, its application to the lowest notes signs is nevertheless wrong: $\supset\subset$, the basis of the lowest triplet, was adopted for the pitch not one semitone, but one whole tone below $\underline{\alpha}\alpha$. After all, only the modified forms of the last three letters were still available. A ‘regular’ duplication of the series one octave above would have reduced the gain of the expansion to a meagre semitone.

This is not speculation. The true meaning of the signs can be read from the tables in Aristides Quintilianus, the only source which transmits them at all.⁹¹ There we find three lists of note signs arranged in abstract steps along the semitone grid: two in steps of whole tones, starting a semitone apart, and one combining these into a comprehensive rendition of the semitone grid itself. The lists unanimously define the space between vocal \times and \neg as the tone that we need for a sensible interpretation of the present melody:

	vocal	\supset		$\underline{\alpha}$	\exists	...
	instrumental	\subset		α	ε	...
according to tones	vocal		\times		\neg	\sqcup ...
	instrumental		\times		\top	\exists ...
according to semitones	vocal	\supset	\times	$\underline{\alpha}$	\neg	\exists \sqcup ...
	instrumental	\subset	\times	α	\top	ε \exists ...

If the transcription is corrected accordingly, the low-register passage merely duplicates the familiar Iastian scale at the lower octave, with \times substituting for the familiar final \neg . The instrument would not follow the plunge, of course, but provide a customary accompaniment.

Apart from this ‘octave doubling’ verse, the general range is the same that we found in other Iastian pieces. Almost the entire melody moves

⁹⁰ Johnson 2000a: 74.

⁹¹ Aristid. Quint. 1.11, p. 24–7. Alypius merely writes out the Perfect Systems of the fifteen scales; Gaudentius presents the semitone series, but starts it from $\underline{\alpha}\alpha$, the lowest note of the fifteen scales (22, p. 350.23–352.2, where the text breaks off before a lacuna).

within the octave between Γ and Z; only twice does a lower note appear, and only once the high A. Once more we must reckon with a composition for an instrument of lower pitch. Although the Yale papyrus presents us with no exuberant chromatic modulations such as those in N^o 39, one scarcely escapes the impression that the modality is more or less the same as there: all the extant melodic fifths and fourths belong to the harmonic framework of Γ -C-O-Z, which circumscribes a *G-D* mode.

Much less is preserved of the second piece on the same papyrus. It moves within a significantly higher register, either also in the Iastian, or in the Hyperastian key. Of the twenty-one readable notes, only two lie below the compass of Ptolemy's cithara, while twelve are higher than Z, the limit of the hypothetical tall lyre. The absence of C here is another indication that the two pieces belong to different modes:

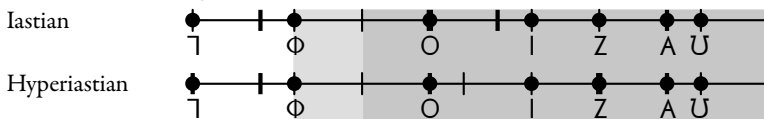

DAGM N^o 42

Pap. Michigan 2958, 1-18

2nd cent. AD

This papyrus from about Ptolemy's lifetime presents us with what is one of the most striking confirmations of our interpretation of Ptolemy's system. Once more it contains dramatic speech set to music; exceptional, however, is its clearly dialogic nature. On top of this, the verses are interrupted by one line of notation without text. Although it is written in vocal signs, it can barely represent anything other than an instrumental interlude.

The scale is diatonic Hyperastian, from which O is remarkably absent. A single chromatic N is a doubtful reading in the interlude:

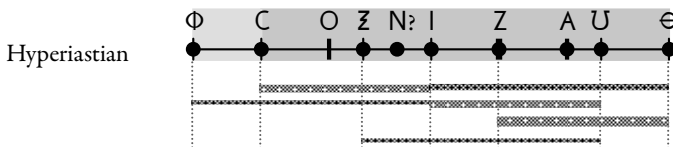

The piece remains within the ninth from Φ to Θ . But here we are in the exceptional position of determining vocal and instrumental ambitus separately. In fact the interlude covers precisely the same range as the vocal part, within which it meanders from the highest down to lowest note. This in-

strumental ninth is identical with our reconstruction of the standard cithara.⁹²

The Hyperastian *tónos* would require Ptolemy's *hypértropa* tuning, for which we derived a probable *G* mode with focus on (thetic) *mésē* *l*. This is however not the most frequent note of the present piece,⁹³ and at first glance the melody might seem too varied for a conclusive determination of modal primacy.⁹⁴ But the treatment of verse ends reveals that *l* is indeed the tonal centre.⁹⁵ The melodic fifths and fourth, which are included in the above chart, also centre round *mésē* and generally underscore the citharodic framework of 'thetic fixed notes', including *synēmménē* *U*.⁹⁶

Another note that is most clearly oriented towards *mésē* is *A*: the major third between *l* and *A* is employed no less than sixteen times. Since *A* is not integrated otherwise, there is reason to expect that this interval was actually tuned resonant. Here, too, the ditone found in Ptolemy's tables is imposed by the compulsory theory of tetrachordal succession. A resonant tuning would once more involve an adjustment of the 'disjunctive' tone, so that the tetrachord above it is no longer bounded by a perfect fourth: in practice the most natural thing to do, although impossible to describe within the ancient theoretic paradigm.

The final part of the papyrus contains the start of another composition in a different mode, suggesting that the document comes from a performer's anthology. The diatonic Hypolydian scale of the second piece corresponds to Ptolemy's *tritai*:



⁹² Pöhlmann (2005: 151) compares a *kithárisma* associated with a monody attested for the aulete (!) Satyrus at Delphi in 194 BC, apparently also involving a newly composed melody for verses originally spoken (SIG 648B; cf. AGM: 376 with n. 82).

⁹³ In DAGM one counts: *l*: 35; *Z*: 43; *A*: 42; *U*: 33. Accordingly, AGM: 315, reckons with *Z* as the tonal centre.

⁹⁴ Cf. Pearl/Winnington-Ingram 1965: 187.

⁹⁵ There is verse end after *l* in lines 2; 8; 10; 13; 15; in contrast, no other note is verse final more than twice: *A* in line 3; *U*: 4 (note the rising finals in 2–4, signalling increasing tension); 11; *Z*: 6; *Z*: 9; *C*: 10; *Φ*: 16; *Θ*: 17; 18. It is worth noticing that the two notes which appear twice, *U* and *Θ*, are *synēmménē* and *nētē*, a fourth and a fifth above the tonic.

⁹⁶ Note, however, that *l* *U* is not a pure fourth in *hypértropa*; on the other hand, the only non-framework fifth, *Z* *U*, is.

Is it more than accidental that both pieces of the Michigan Papyrus thus instance a *stereá* tuning, i.e. one formed (according to Ptolemy) of similar ‘tonic diatonic’ tetrachords? In any case, the present song once more testifies to the usual citharodic ambitus, from which the vocal line departs only in one note. The short fragment does not yield much information about its modality.

DAGM N^o 44

Pap. Oxy. 3704

2nd cent. AD



This document consists of three papyrus fragments, which bear text with notation on both sides. Whether all belong to one piece can neither be confirmed nor excluded; it is therefore a good idea to look at the two sides separately. Unfortunately many signs are far from certain, which is due not only to the state of the papyrus but also to the careless hand that added the musical notes. The standard edition reads the following:

Side →
Hyperiaastian





Side ↓
Hypolydian

The ascription of the respective *tónoi* depends mainly on the absence or presence of the distinctive notes A and E, which are however not unproblematic. Whether E is rightly identified is subject to doubt;⁹⁷ but if it is correct, one might also consider reading instances of E on Side →.⁹⁸ On the other hand, A seems unequivocal in one place; but this is on the smallest fragment, which might as well belong to a different composition. All in all, it is perfectly possible that both sides are in the same key throughout, be it Hypolydian or Hyperiaastian. Six notes are read with octave strokes. Of these, the highest occupies a singular position on Side →, while the other five reside on Side ↓. Strictly speaking, neither O' nor Z' belong to the Hypolydian key. Yet we must compare the *hormasia*, in which, obvi-

⁹⁷ Cf. Haslam 1986a: 45. In DAGM: 150, an erroneous “E (*f*#)” must be corrected either to “E (*e*#)” or – in accordance with the transcription – to “E (*f*)”. In any case, the note is certainly not “exharmonic” in the context of Side ↓.

⁹⁸ In 1 ↓, 6,  is interpreted as E with diseme. The note 1 →, 3  seems very similarly written, and might be an E rather than a C with diseme (the base of C is otherwise well rounded; cf. e.g. 1 →, 4 ; for the absence of diseme on a long syllable cf. 1 →, 2 σὺναίμος; 5 θῆρα). At this place E is also melodically favourable, providing the intermediate note between the preceding U and the following Z, while C introduces a falling seventh.

ously guided by citharodic practice, the octave signs are continued not only beyond the Hypolydian scale, but beyond the entire notational system (in N^o 41 we encountered an analogous expansion into the lower region; cf. also the transposition of an entire melody to the higher octave in N^o 17).

On the other hand, some of the octave strokes can also be cast into doubt. The papyrus exhibits quite a lot of almost horizontal strokes. Only those which stand above musical signs are clear diseme marks, and only those below a diseme mark are unequivocal octave diacritics; the identification of the latter is confirmed by their slight but noticeable slant. At least in one instance (1→.4), an isolated horizontal stroke occupies the position of a note.⁹⁹ A  in the same line is naturally understood as a misplaced diseme. Most problematic is 1→.3 . The first editor rendered it tentatively as $\bar{\iota}$, well aware that this is metrically wrong. The standard edition's $\bar{\iota}$ is palaeographically unconvincing, the short horizontal dash being so unlike the long slanted octave strokes (e.g. 1↓.5 ); on top of this, the latter maintain a distance of 0.7–1.7 mm from their respective note signs, whereas the dash touches the vertical line. The lower end of the sign is apparently abraded; perhaps it was similar to , next but one to it. Since the short syllable should preclude a diseme, such a reading would support the proposed interpretation as E. This also rids the piece of the terribly high $\bar{\iota}$ (about modern *b'*, with which the voice would probably have to start off after a pause), and mends a particularly severe clash between melody and word accent.

At any rate, the lower limit of the melody coincides with the cithara's *hyperypátē*, and all employed notes were available on this instrument in one way or other. Whether the actual tuning corresponded to Ptolemy's *tritai* or *hypértropa* – the former being supported by the possible occurrences of E, the latter by the high range and the note A, or modulated between these, it is very likely that this papyrus, too, contains citharodic repertoire.

The next item holds the remains of about five short pieces, separated graphically and by their different keys. In the following chart, however, the few extant notes of the left-hand column are united (its upper part contributes merely the \bar{U}):

⁹⁹ Cf. West 1998: 82, with the appealing suggestion that it might be “an abbreviation for ‘same note as previous’”.

11:	(Hyper-)Iastian/ Hypolydian	
11.1-3:	Hypolydian	
11.4-8:	Lydian	

Apart from these notes, an unexplained sign in the form of a checkmark appears thrice in the Lydian section.¹⁰⁰

While the Hyperastian/Hypolydian parts remain within the compass of the classical cithara, the Lydian appears to descend down to the lowest note of the hypothetical low-pitched alternative instrument. Again, the key does not easily support the notion of a tall lyre. Also, the solitary E would exceed its range at the top; but at any rate the identification of this note is especially problematic.¹⁰¹ On the other hand, the single low T, although it makes good musical sense in the neighbourhood of R, is palaeographically doubtful, as well.¹⁰² The low range is elsewhere associated with Hyperastian; hence the possibility of a transitory plunge of the voice only must be considered seriously.

In the Lydian piece, M and Φ account each for a quarter of the melody. With the necessary caution it can thus be added to the evidence for Ptolemy's *lydia* as a *G* mode.

DAGM N^o 46

Pap. Oxy. 4462

2nd cent. AD

Another Oxyrhynchus Papyrus is merely one more indication that the Hyperastian key could be associated with high tessitura:

Hyperastian

¹⁰⁰ 11.4 ; 5 ; 6 . From these, 1.7 with its different ductus is probably to be distinguished (cf. below, p. 315f).

¹⁰¹ Above all, reading (nothing but) E in 11.6 left to the checkmark does not take into account the roof-shaped remains after the gap (U? M?).

¹⁰² The "T" in 11.4 is written which very much resembles Z (for Z with similarly short tail, cf. 11.2 ; with angular ductus at the top, 11.6); this however produces a seventh with R. Here and with the following items one must be alert that the edition in *DAGM* by no means reflects the actual problems: contrary to the procedure followed elsewhere, no dots are printed below doubtful note signs in N^o 45-9, nor are these always made clear in the commentary (an extreme example is 11.7 "Φ I", of which only the tiniest traces exist). It is therefore indispensable to consult the unabridged apparatus in West 1998.

The frequent incidence of Γ fits in with an interpretation of Ptolemy's *hypérrtropa* as a *G* mode.

The next item is similarly Hyperian, although its range is quite ordinary:

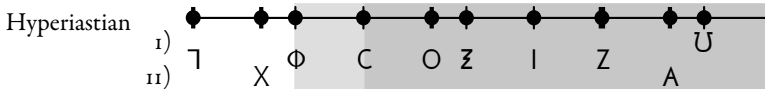

The average pitch of the first eight lines is higher than the rest by about a tone: perhaps two pieces are to be distinguished. If so, the first, in which no *A* is read, might also be Hypolydian. The modality can hardly be identified. *C* (*D*; *A* in the first piece?) is frequent; the first piece or section apparently ends on Γ (*l. 8*: *A*, or *E*?).¹⁰³

Many readings of this small fragment are doubtful (from a preceding piece, in Iastian or Hypoian key, only the notes *IKAO* remain). Its key is most probably Hypolydian; only one *R* falls out of the usual cithara compass. But there is one detail of special interest: if the Δ is rightly identified, the higher tetrachord is chromatic:



For this period, a document of chromatic music is extraordinary; it is a pity that the note cannot be read with confidence.¹⁰⁴ At any rate it seems reassuring that the supposed chromatic *pyknón* appears in a Hypolydian piece, and at that specific position in the scale. Within Ptolemy's six cithara tunings, the chromatic finds its place only in the upper tetrachord of *trópoi*, which we have identified as belonging to the Hypolydian key of notation.

¹⁰³ A conclusion of the melody with two semiquavers as transcribed by the editors does not seem very likely. The papyrus has , with an unexplained hyphen-like stroke from left below *C* up to (and perhaps right through) Φ , and the diseme is placed merely above Γ (elsewhere in this document there is no tendency to displace it to the right); so the rhythmical interpretation seems open to discussion.

¹⁰⁴ Cf. West 1998: 94.

After the Epidaurus inscription (N^o19), the present piece is therefore the second doubtful candidate for the *trópoi* tuning.

DAGM N^o 49

Pap. Oxy. 4465

2nd–3rd cent. AD

Another papyrus presents us – apart from scanty remains of a first column, apparently Lydian¹⁰⁵ – with an unspectacular section of the Hyperian or Hypolydian scale:

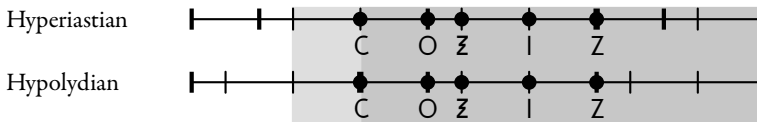

The important melodic role of C might support a Hypolydian interpretation (cf. Diagram 57 on p. 225 above¹⁰⁶).

DAGM N^o 50

Pap. Berlin 6870+14097.1–12

2nd–3rd cent. AD

With the following items we revert to the Berlin Papyrus, the collection of vocal and instrumental pieces from which we have already discussed the Ajax fragment (N^o17–18). Its upper half contains the remains of a solemn Paean to Apollo. The piece is composed in a straightforward diatonic scale of the Hyperian key:¹⁰⁷



This is precisely the *hypértropa* tuning within the classical cithara range, just as the character of the piece is probably the most undoubtedly citharodic in our collection besides Mesomedes' hymns. The modality confirms the impression of a storybook cithara composition. Most frequent is the 'thetic' *mésē* I, followed by *paramésē* Z, which both function as tonal centres, while *hypátē* C serves as a typical final. This implements the familiar *G–D* mode of *hypértropa* within the classical *harmonía* framework. The latter is also emphasised by resonant leaps between *hypátē* and *mésē*, *hypátē*

¹⁰⁵ On the sign *l* appearing there, cf. below pp. 315f.

¹⁰⁶ For the compilation of Diagram 57 the present piece has been counted as Hyperian, in accord with the ascription in DAGM, so that the danger of circular reasoning is excluded.

¹⁰⁷ Few will be able to follow Bélis (2003: 554–5) in holding that the key is Hypolydian with A instead of E, tantamount to describing a modern piece not as *G* major (or, if the *finalis* is to be taken into account, perhaps as church mode Lydian in *C*), but as 'C major with *f* sharp instead of *f* throughout'.

and *paramésē*, *paramésē* and *néṭē*. It even appears as a continuous run in the melody, ingeniously split between two verses, one concluding, one starting with a leap of a fourth, with special emphasis on *mésē*:

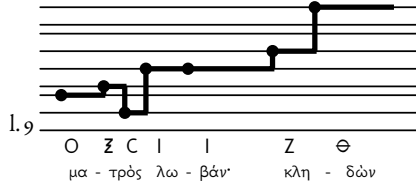

All this combines to a picture of Apollinian grandeur, where there is no more place for vocal notes exceeding the tonal space defined by the strings of the lyre than there is for modulation. Quite possibly the paean is a typical example of the music Ptolemy played on his canon to verify the suitability of his figures.

Two more pieces are found on the Berlin papyrus. These are instrumental music, set apart from the vocal fragments by a similar amount of indentation. Curiously enough, however, the vocal and the instrumental fragments alternate on the document. The combination of a solemn paean with the lament of the Ajax fragment shows that the collection is not governed by similarity of content or musical style; it might stem from a rhythmical treatise with notated examples.¹⁰⁸ Consequently we must not extend any inferences from one piece to another; in principle each ought to be investigated independently.

Nevertheless there are certain similarities between the two instrumental scores. Both employ long notes only on strong rhythmical positions (the *thesis* of ancient theory), and tend to solving the (preceding) weak positions into two quavers. As we are told by Bellermann's First Anonymus, such melodic figures were called *prókrousis*, if ascending, and *ékkrousis*, if descending.¹⁰⁹ In both fragments, such a pair of quavers can also be realised on identical notes, and in this case a kind of staccato sign is put in between. This, too, is known from the anonymous treatise, although the distortion of the signs in the manuscript transmission makes it impossible to decide

¹⁰⁸ DAGM: 173.

¹⁰⁹ Anon. Bell. 1, § 6-7 ≈ § 88-9.

whether it is the *kompismós* or the *melismós* that is applied in the papyrus.¹¹⁰ The general line of the two melodies adds to the feeling of a similarity of style. All in all, it appears almost certain that both pieces are intended for the same kind of instrument. That this may be the aulos was argued for N^o 52, where we encounter long notes side by side with short notes followed by pauses: such a distinction makes much more sense for a wind instrument than for the rapidly decaying sound of strings.¹¹¹

The staccato signs point in the same direction. The Anonymus demonstrates their meaning by different concatenation of solmisation vowels: while an ascending interval of a tone is exemplified for instance by the sound of “*tō-ā*”, the *kompismós* is illustrated by “*tōn-tō*”, the *melismós* by “*tōn-nō*”. It is obvious that such fine differences in the intonation of transitions hardly have a place in the art of the lyre (where other refinements come into play). But for the woodwind they are a primary element of differentiation. Staccato effects are achieved by means of ‘tonguing’, i.e. either stopping the reed or briefly closing or restricting the air channel inside the mouth with the tongue. Thus, the presence of the respective signs in the scores is strong evidence for an auletic context.

The first instrumental piece exploits a large compass, from the Hyperiasian *proslambanómenos* up to its *paranētē diezeugménōn*:¹¹²



Although the lowest two notes are employed sparingly, the importance of Γ is demonstrated by its closing a melodic section (and starting off the following one). Generally the piece appears dominated by C, probably with a secondary focus on < a fourth higher.¹¹³ Interestingly this is just the same Hyperiasian *G–D* mode that we know from other documents, and that we were able to derive from Ptolemy’s cithara tuning. If the present piece is auletic, it might open a window on a system of modal conventions that were not instrument-specific after all, but more generally associated with the particular *tónoi*.

Is it significant that the relative range of notes in the Perfect System, from *proslambanómenos* to *paranētē*, is the same as that found on the Louvre aulos?¹¹⁴ If so, the instrument in question could be determined more

¹¹⁰ Anon. Bell. 1, § 4.9–10 ≈ § 91–2. Cf. *DAGM*: 171.

¹¹¹ *AGM*: 321.

¹¹² For the Hyperiasian as an auletic key, cf. Diagram 14 on p. 54 above.

¹¹³ I am grateful to Charles Cosgrove for a lively discussion of the piece’s tonality, in which he rightly insisted on the primacy of C, as far as the evidence goes.

¹¹⁴ See n. 77 on p. 292 above.

specifically as an aulos of similar basic layout, although in an entirely different key. We shall presently return to the complex issues that the question of absolute aulos pitch raises.

In the second instrumental piece, the lower notes of the Hyperastian scale are missing. Instead there are two instances of its *nētē diezeugménōn* K', one tone above the range of the previous score (or what is extant of it).



As a matter of fact, the average pitches of the two melodies differ by no less than three tones. Still, they might be played on the same aulos, even if there was no additional finger hole above those required for N^o 51: the highest note of N^o 52 was available by overblowing the lowest note of N^o 51 (*proslambanómenos* Γ) to the first available harmonic, a twelfth above the fundamental.¹¹⁵ In this case, a performance of N^o 52 on one melodic pipe would require that the hand fingers the five notes from < up to ┐, that all the holes below ∞ are sealed in advance, and that the hole for ∞ is mechanically closed and opened while playing: opened, in order to produce ∞, closed, for overblowing Γ to K'. As far as we see, the player would have had plenty of time for the operation of the hypothetical mechanism, since the two mutually exclusive notes do not appear together within one and the same line of the score. Again we must postpone a more detailed discussion of instrument design.

As regards its mode, the piece once more focuses on *G* and *D*, in congruence with its Hyperastian key. This is another aspect that associates it with the preceding item (and also with the paeon). In accordance with the high range, however, the *D* is here present not as the more usual C, but as the ┐ one octave above. In Roman Imperial times at least, the octave relationships, which the Greek terminology conceals, were nevertheless strongly felt. In theory, this was acknowledged by Ptolemy.¹¹⁷ The fragments pro-

¹¹⁵ Hagel 2002: 385; Hagel 2005a: 82–5; cf. below, p. 320.

¹¹⁶ This entails an easily manageable finger span of about 11–11.5 cm, leaving some room for the small finger to reach the assumed mechanism for ∞.

¹¹⁷ Most beautifully, Ptol., *Harm.* 1.6, p.13.4–5: ἡ διὰ πρῶτων συμφωνία, τῶν ποιούντων αὐτῶν φθόγγων ἁδιαφοροῦντων κατὰ τὴν δύναμιν ἑνός... “since notes that form an octave are indifferent insofar as they are functionally one...”

vide the practical confirmation: notes one octave apart could assume similar modal functions, just as in later Western music.

DAGM^o 53

Pap. Oxy. 3161 recto

3rd cent. AD

Music from a dramatic setting is found on a number of papyrus fragments from Oxyrhynchus. In this case, not only the music but also the text seems to be late. Both sides are notated, but independently (as the writing direction shows) and by different hands. For the recto, the editions print the following note signs:

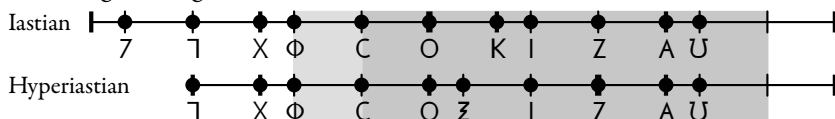

All notes that do not belong to the Hyperastian are however doubtful, and the single 7 is also uncertain.¹¹⁸ On top of this, the tonality of the four papyrus scraps is by no means uniform. Fragment 1 omits the Z, so that it may as well be Iastian as Hyperastian:

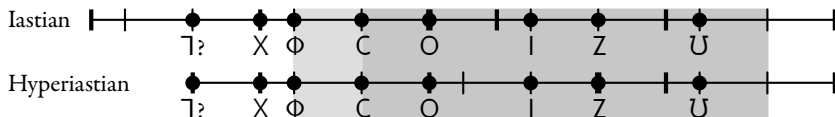

The melody appears to adhere to the (Hyperastian) *G–D* mode, based on focal I and final C.¹¹⁹ But U, frequently used in combination with I a fourth below, is also very prominent. Our general consideration of Ptolemy's tuning schemes led us to expect such a combination of C, I and U not from Hyperastian, but from Hypolydian *tritai* (cf. Diagram 56 on p. 224 above). Furthermore, *tritai* implements a pure fourth between I and U, whereas the awkward interval that Ptolemy's *hypértropa* puts in the same position can hardly account for its frequent occurrence in the melody of Fragment 1. Is it a coincidence that almost all of it is Hypolydian, as well? In this case the X, which appears only towards the end of the fragment, might be part of a transient modulation, perhaps introduced merely to emphasise the proper name Tereus.

¹¹⁸ For K in fr. 2.3, 7 7 in fr. 2.7, cf. Haslam 1976: 59; 62; for 7 in fr. 4.3 and 7 in fr. 1.4, DAGM ad loc.; 178. Cf. n. 75 on p. 358 below.

¹¹⁹ Cf. Haslam 1976: 63 (C); AGM: 323 (C and Z).

Fragments 2 and 3 provide no clear picture. The latter is very small, and in the former the distinctive notes are not identified with confidence.

The melody of fragment 4 employs rather a lower register than fragment 1. Since its single X is very doubtful, the key could once more be Hypolydian:

Iastian: 7? X? Φ C O I Z

Hyperastian: X? Φ C O Z I Z

Hypolydian: 7? Φ C O Z I Z

As regards frequency of occurrence, Z, O and I stand out. But they seem to mark out rather the favourite range of this piece than its modality; none of them bears clear signs of focal status. On the other hand, C seems to maintain its role as a final here, as well. All in all, the notes and the modal characteristics of this fragment seem both compatible with Hypolydian just as well as with Hypoastian.

On the back of the same fragments there are the remains of – probably – Iastian melodies, at one place modulating to Hyperastian:

Iastian: 7? X Φ C O K I A?U?

Hyperastian: 7? X Φ C O Z I A?U?

Nothing can be said about the function of the individual notes.

The next item is a small scrap with music modulating between Lydian and Hypolydian:

Hypolydian: C O Z I Z E

Lydian: C M I Z E

The most frequent note is *mésē* 1, which also serves as the turning point between the two scales (6: 11MIOC¹²⁰). The date of the score is significantly later than Ptolemy. Still, one is reminded of his *parypátai* and *trítai*, which instantiate the Lydian and the Hypolydian. These two *harmogai* were fully compatible, all shared notes being in fact tuned to identical pitches. Thus they could be combined on a cithara of only one string more than the number required for either simple scale; it is highly probable that this possibility of modulation was the only reason behind the ‘soft diatonic’ tetrachord of *parypátai*. On top of this, we expect a focal 1 for both of them (cf. Diagram 56 on p. 224 above).

If this tentative ascription hits upon the truth, it helps to characterise the relation between the two tunings in the Lydian key, *lydia* and *parypátai*. Where the Lydian is clearly dominant we have encountered the *G* mode of *lydia*, even if there was occasional modulation into Hypolydian (N^o 38 and N^o 40).¹²¹ Only if the Hypolydian plays a considerable role, to an extent that its proper tonal centre 1 becomes prominent, must the tuning scheme be adapted to the requirements of a double scale. In consequence, one should probably not expect ever to encounter a purely Lydian piece from the Roman era in *parypátai* tuning.

DAGM N^o 56

Pap. Oxy. 3705

3rd cent. AD

One of the most perplexing ‘musical’ documents, this papyrus contains four variant melodies to a line from comic dialogue, namely from Menander’s *Perikeiromene*. Obviously they are intended to illustrate different ways of performing the, or rather a verse. But sung comic dialogues are not what one expects even from late antiquity; consequently it has been proposed that the written notes merely sketch possible stylisations of speech melody.¹²² On the other hand, given the apparently instructive nature of the papyrus, one need not bother too much about the pedigree of the line. It comes from a typical recognition scene, as recommended themselves for concert performance because of their pathos and climactic structure;¹²³

¹²⁰ Since M corresponds in pitch with Z, the modulation is of course less abrupt musically than it appears in notation; in any case, the employment of M proves that the lost portion preceding the modulation was in fact Lydian; that is, it probably included P.

¹²¹ For the dominance of the Lydian compare the fact that in N^o 40 the Lydian sign M appears instead of the Hypolydian Z of equal pitch even in Hypolydian context.

¹²² DAGM: 185.

¹²³ Cf. N^o 42, where, apparently, Orestes reveals himself to a servant.

possibly the author just chose the first verse from such a context that came to his mind.

The notes employed are a mixture of Lydian and Hypolydian:

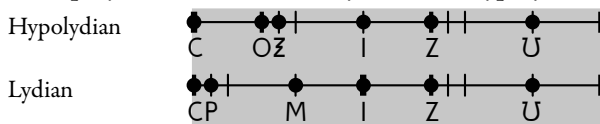

The latter is used only in lines 2 and 4; but even these start from Lydian.¹²⁴ As in the previous fragment, I is the dominant note, mediating between the two keys – although it does not occur at all in line 3, which is pure Lydian.



So much about the (more or less) easily identifiable notes. But there is also a symbol *l*, unlike any possible note sign, which is read at least six times, always clearly in the position of a note.¹²⁵ Another three instances of apparently the same symbol occur in N^o 45 and N^o 49, as here in a (Hypo-) Lydian environment, and one in Pap. Oxy. 4710, with unidentified key.¹²⁶ Not in all cases can its melodic context be established; even so, the extant eleven neighbouring notes are sufficient to determine its identity with reasonable confidence.

Four times *l* is found in combination with Z, thrice with Lydian M, once each with Hypolydian Z̄ and O; finally, there are two examples of repeated *l*.¹²⁷ As the left part of Diagram 73 shows, this distribution of neighbouring notes is surprisingly similar to that which we get for I in the Lydian and Hypolydian fragments from the Roman era. The conclusion seems scarcely avoidable that *l* and I stand for much the same pitch. If, as a working hypothesis, their pitch is actually assumed to be equal, we obtain a set of melodic intervals between *l* and its neighbouring notes: six rising versus two falling

¹²⁴ Bélis (1988: 54) prefers to analyse these lines as Hypolydian with movement between the *synēmmēnon* and the *diezeugmēnon* tetrachords. But only the assumption of a basic Lydian can explain that they start with M.

¹²⁵ Apart from the six instances printed by the editors, the third sign in line 1 is a possible candidate. An identification as V was rightly dismissed by Haslam 1986b: 48, on musical grounds. On West 1992a: 15 (“K”), see now DAGM: 154.

¹²⁶ N^o 45 l.7:  (to be distinguished from the checkmark-like signs in col.ii; cf. above p. 305, n. 100);

N^o 49 l.4: ; Pap. Oxy. 4710.4: ; here, e.g. l.4 . On the question of its association with Lydian/Hypolydian, cf. below p. 324, n. 146.

¹²⁷ In Pap. Oxy. 4710, *l* precedes a rest sign (*leimma*), which most probably marks an incision (Yuan 2005: 46; cf. the verse ends in N^o 42; the second function of the *leimma* for rhythmical distinction within a melisma is excluded in the absence of more than one note); consequently the following U cannot count as melodic context.

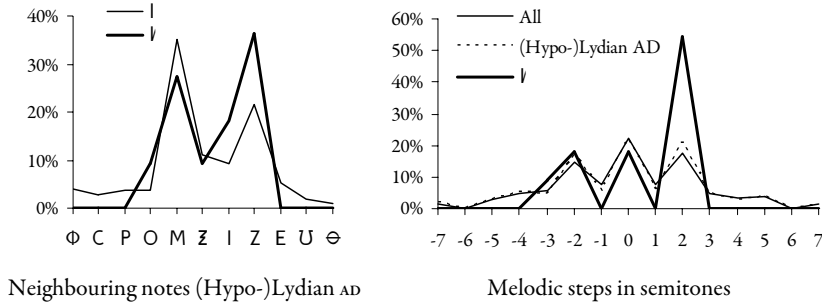

Diagram 73 Melodic context of ∨

whole tones, a falling minor third, plus the two instances of repeating the same note.¹²⁸ In the right part of Diagram 73, these are plotted against the distribution of melodic intervals both in the entire corpus of ancient Greek melodies, and in the subset of Lydian and Hypolydian pieces from Roman Imperial times. Once more, the figures are almost identical. Only one difference springs to the eye: ∨ occurs rather often in progressions of a tone. But this is most probably due to chance, a distortion of the data due to the minute sample size.

Nonetheless the coincidence of the peaks leaves hardly any doubt that ∨ is indeed some variant form of l, a conclusion that is also in good accord with its graphic shape.¹²⁹ The statistics cannot rule out some tiny pitch difference; but the system of ancient music gives us no reason to assume such a differentiation for *mésē*, of all notes; nor does the notion of two tuning variants of the focal note make much musical sense. If there was any distinction between ∨ and simple l it is probably to be sought along different lines.

DAGM^o 57

Pap. Oxy. 4466

3rd cent. AD

Hymnic content, perhaps even a paean has been sought in the next item. Although more readings must count as uncertain than the editions imply,

¹²⁸ Note that the musical context of the 'checkmark signs' of N^o 45.11 is much more varied, probably excluding their association with a specific pitch (they appear: in 4, between B and T; 5, before M; 6, after E; these notes are distributed over a minor ninth).

¹²⁹ The assumption of simple palaeographical variance was rejected by Haslam 1986b: 48, who nevertheless saw that an identification with l is most convincing musically.

it is clear enough that the extant notes all belong to a straightforward Lydian scale:¹³⁰





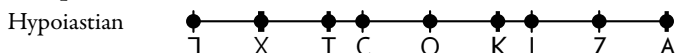

The good agreement with the strings of the classical cithara, along with the supposed genre, suggest a citharodic piece. *Hypátē* C is most frequent by far.

The next fragment is the only example of exclusively Hypoiastian notation besides N^o 18.¹³¹ What we know of its scale is bounded by a ninth. The sequence of tones and semitones would resemble a Hypolydian cithara tuning; but the pitch is a minor third lower:



In the lists of Bellermann's Second Anonymus, the Hypoiastian appears only as an auletic key (cf. Diagram 14 on p. 54 above). This information is in agreement with Ptolemy, but it need not necessarily apply to the rather late date of this papyrus. Anyway, since much of the melody moves near the lower limit of Γ, a setting for an instrument of lower pitch than the typical cithara is more than probable.

¹³⁰ Above all, two almost identical glyphs (1  ; 3 ) are transcribed once as Φ, once as Γ. In

line 5 (“:UΓ”) I read, on the digital image of the papyrus, :UΘ, which introduces an unusual short scanning of the first syllable of *ἔβλυσεν*, but would explain the double point (for the long horizontal stroke of Θ, cf. *DAGM* N^o 45.1 and N^o 50). The reading “EZI:ZIP CΦR Z” for line 2 does not account for the large spacing between I and P: either the former is actually Φ (melodically most unlikely), or they were separated by another double point. After both “EZI:ZIP” and “CΦR” a horizontal stroke not unlike the modern hyphen appears. The first might be a diseme above R below, but this is improbable in view of the second. The E of “EZI” seems unlikely; perhaps “MI” is possible (compare  with 5 ). Z stands just where one expects the note for -σε[-, namely after the syllable initial consonant and before the vowel; if the ascription to the previous syllable is accepted, -σε[- is lacking a note. From the mere layout it appears thus preferable to ascribe C to -ρε-, and ΦR to -α-, which disposes of the unparalleled melisma. But then the lines below the notes would have to be hyphens (in the ancient sense), if α shall be short, as is probable. With a long α (indicated by diseme above R?), the assumption of either elision (τείρε’ ασ[] or *scriptio plena* with a note for the elided vowel seems necessary: τείρο(ε) ασ[]. Finally, -ρεα- might form only one syllable (cf. *χρυσέαισι* in *DAGM* N^o 27.10). None of these options is unproblematic.

¹³¹ But compare the Hypoiastian sections of N^o 39 (above, pp. 293ff.).

DAGM^o 59

Pap. Oxy. 1786

3rd–4th cent. AD

This famous anapaestic Christian hymn of Trinitarian theology¹³² employs the Hypolydian key:



If it was accompanied at all, we would expect an instrument belonging to the lyre family. The vocal line, however, exceeds the compass of the classical cithara four times (R), and the supposed range of a potential tall lyre thrice (E). Both are therefore equally possible, and given the special social context we must also reckon with the employment of some instrument that enjoyed less prominence in pagan culture.

The melody clearly adheres to the familiar *G–D* mode, with Φ and I as focal notes, the fifth between which also appears as a melodic interval.¹³³ Even so, we come no step further to determining the instrument: a low-pitched variant of *lydia*, implemented on a tall lyre, would imply such a mode just as well as a classical cithara tuned to *tritai*.

DAGM^o 60

Pap. Ms. Schøyen 2260

3rd–4th cent. AD

A small scrap of papyrus is our third source for Hyperastian within an especially high range:



Similar in this respect were N^o 46, with a compass from O to Z', and the instrumental N^o 52, which includes notes from ∞ (= Z) to K' (= O'). While these three pieces seem to exemplify some special high-pitched aspect of Hyperastian music, the same key was also employed for melodies of ordinary citharodic pitch, which we have addressed as instances of Ptolemy's *hypértropa* (N^o 42; N^o 50; probably N^o 44 →). Still, one cannot take for granted that the three high-pitched pieces really belong within a common performance-related category, for instance because they are composed for the same instrument.

¹³² The latest detailed discussion is found in Meier 2004: 41–67; for the 'Greek' character of the music cf. West 1992a: 47–54.

¹³³ Cf. *AGM*: 325.

The last instrumental piece in our collection is also the most interesting, at least from the melodic viewpoint. It has a surprisingly large compass of an octave and three tones, and modulates between several keys. Lydian and Hypolydian notes are encountered; a *synēmménon* modulation into Hyperlydian prepares an unexpected plunge into Hypophrygian in a lower range:¹³⁴

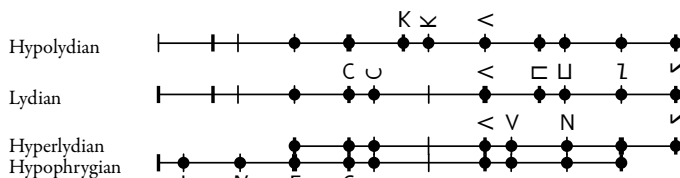

Which instrument was capable of playing all these notes? Certainly not a lyre in the classical tradition. A many-stringed lyre would rather require a slanting yoke, but probably such instruments did not belong in the professional context that produced written scores; much the same applies to the harp. The aulos is therefore the most likely alternative.¹³⁵

What remains legible on the papyrus is the left-hand parts of four lines, most likely comprising less than half of their original width. A comparison of the notes employed in each of these melody fragments is instructive:

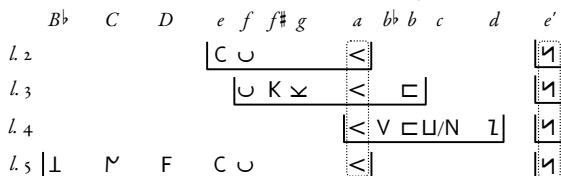

Only two notes are commonly used, the Lydian *mésē* < and *nētē diezeugménōn* ♯. Frequent occurrence of the former is not unexpected – although we have seen that it did not maintain its focal function in Lydian cithara music in the Roman era. The persistent employment of such a high note as the *nētē*, however, is surprising. Even more remarkable is the fact that it

¹³⁴ Johnson 2000b: 28–9, in another exemplary edition, prefers analysing this piece in terms of tetrachords, not *tónoi*. Such a view has its advantages, especially because it does not involve such a structure as the ‘Hyperlydian Perfect System’, which probably belonged to systematic theory only. The question remains whether the composer would have looked at the ‘Hypophrygian’ notes as parts of the Lydian triad, the octave complement of the *synēmménon* tetrachord, or not. — The modern note names in Johnson’s second diagram on p. 29 are misprinted; they should run: *d e^b f g a b^b c’ d’*.

¹³⁵ Cf. Johnson 2000b: 30–3.

recurs regardless of the pitch of the surrounding notes. Only in line 4 is it part of a continuous high-pitched section, whereas a fifth separates it from its fellows in lines 2 and 5, and a fourth in line 3. Such an isolated note is unprecedented in our corpus of ancient melodies.

It can find its explanation in the playing technique of the aulos; more specifically, of an aulos whose lowest playable note corresponds to the *proslambanómenos*. The crucial point is that on the aulos one cannot obtain the higher octave by overblowing, as one can, for instance, on the oboe or on flutes. On reed pipes with cylindrical bore such as the aulos and the clarinet only the odd harmonics are available, so that the distance between the fundamental mode and the first harmonic amounts to a twelfth.¹³⁶ This is also the distance between *proslambanómenos* and *nētē diezeugménōn*. Thus the latter is the first note that can be produced not by another finger hole, but by overblowing the entire pipe, with all holes closed, provided that it is tuned to the *proslambanómenos*, one octave below *mésē*. I have argued that the Louvre aulos instantiates such an instrument, albeit one of primitive make, on which different sets of holes can be stopped and opened only between different pieces, by means of some kind of plugs, and that the evolution of the Perfect System was associated with that of such instruments.¹³⁷

To extend the scale even further, one would have to overblow the lowest finger holes. As a result, on an aulos of the type in question, with fundamental notes ranging only from *proslambanómenos* to *paranētē diezeugménōn* = *nētē synēmménōn*, it is impossible to change quickly between the notes below and above *nētē diezeugménōn* on one pipe: the former require fingering the highest holes, the latter to have these all covered by some means, while playing at the lower end of the instrument. As regards a single pipe of this make, the *hyperbolaïon* tetrachord and the higher part of the central octave were mutually exclusive.

On the other hand, the *nētē diezeugménōn* was always available, as long as all holes below those actually fingered were closed (those above must be closed anyway). Consequently one could jump to this, but not to any other, high note from any part of the scale, whenever all finger holes were obtu-

¹³⁶ It is now mostly agreed that the typical professional aulos was played with a double reed, not with the 'primitive' single reed sometimes envisaged by earlier authors; cf. *AGM*: 83–5; for iconographic evidence, e.g. Byrne 2000: 284 fig. 1. The most recent assertion of single aulos reeds ignores methodological issues as well as most of the relevant literature (Steinmann/Reichlin 2006: 239); similarly, when Mathiesen (2007: 319) expresses doubts about a double reed used on the Louvre aulos, he overlooks the fact that such a reed was found attached to an instrument of a similar type, Berlin Egypt. Mus. inv. 12.461 (cf. n. 140 below).

¹³⁷ Hagel 2004a; 2005a: 81–9; Cf. below, pp. 332ff.

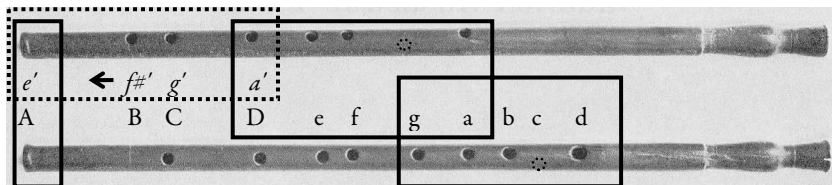

Diagram 74 Overblowing to *nētē* and *hyperbolaiāi* on the Louvre aulos
(Hagel 2005a, 84, Fig. 3)

rated, e.g. by the mechanism of rotating bands, except those four or five that the fingers could reach in each playing position. How all the notes of the Greater Perfect System's double octave would be obtained in different playing positions of the Louvre aulos is shown in Diagram 74 (once more, the modern note names indicate no absolute pitch).

The reduplication of the basic pitches not an octave but a twelfth above the fundamental entails that the overblown notes in fact belong to a modulating scale: the higher mode of *hypatē hypatōn* (*B*) yields not the required *tritē hyperbolaiōn* (*f*), but a pitch about a semitone higher, corresponding to *kbrōmatikē hyperbolaiōn* (*f#*).¹³⁸ Instead of a sequence of tone – semitone – tone, as available on the finger holes for the lowest part of the Perfect System, a sequence of semitone – tone – tone is required. For obtaining a 'proper' scale on the Louvre aulos, one would therefore resort to half-stopping the lowest finger hole, a technique that considerably influences the tone quality. One can imagine that a more regular usage of the *hyperbolaiōn* tetrachord created the need for a *B^b* hole, either as an alternative or even instead of the regular *B*.¹³⁹ Once such a *B^b* hole had become conventional, it was only natural to make use of its fundamental pitch also, in effect as a modulating note. In this way, the scale of N^o 61, from *nētē* down to a pitch a semitone above *proslambanōmenos* can be entirely explained on the basis of organological considerations.

These in turn are substantiated by archaeological evidence. Two wooden pipes in the possession of the Egyptian Museum at Berlin provide the 'miss-

¹³⁸ This is the first pitch notated with an octave stroke in the natural scale (whose significance for the aulos in question is argued below). Is it coincidence that the non-modulating *tritē hyperbolaiōn* is also absent from the *koinē hormastā*?

¹³⁹ Such a preference for an easier production of the highest part of the scale at the expense of the lowest might have been supported by the fact that the latter is much more difficult to play (accordingly, it appears only at the end of the present fragment); cf. ps.-Aristot., *Aud.* 800b: πάντες γὰρ χαλεπῶς πληροῦσι τοὺς βόμβυκας καὶ μετὰ συντονίας πολλῆς διὰ τὸ μῆκος τῆς ἀποστάσεως "For everyone fills the (entire) tubes with difficulty and great effort, because of the large distance"; Theophr. *ap.* Porph., *in Harm.* 63,7–11 (see n. 111 on p. 176 above).

ing link' between the Louvre aulos and the melody of the Michigan Papyrus.¹⁴⁰ They resemble the general structure of the former in supplying a diatonic scale extending from *proslambanómenos* as their lowest note up to *paranéte* as the highest finger hole (although placing this scale at a considerably higher pitch). On the other hand, they also include the necessary B^b , not as a finger hole, but as the lowest note of one of the pipes. One pipe therefore yields A and, if overblown, e' , the other B^b and f' .¹⁴¹ This is of the greatest importance for the question of playing technique. A melody in the higher range that goes up as far as f' must be distributed between the two pipes; otherwise the f' would stand totally isolated on its pipe, a sixth above a . And the fact that f' is an intended note is sufficiently proven by the low B^b , whose function is not easily explained otherwise. Consequently, one cannot simply divide this kind of aulos in a melodic and an accompanying pipe; instead one must reckon with the possibility that all of its pitches could be and were used melodically.

To illustrate the structural associations between the design of such an instrument and the melody of the Michigan Papyrus, Diagram 75 juxtaposes the structure of the latter with the Berlin aulos. Three points are notable, two of which apply to the Louvre aulos, as well. Firstly, as discussed above, the *néte diezeugménōn* (e') stands out in the melody by its occurrence independent of the context, and on the aulos by its unique production through overblowing. Secondly, *mésē*, the other note that occurs in all four lines is also the highest note that can be played on both pipes of the aulos. Thirdly, the perplexing modulation found at the end of the papyrus straightforwardly corresponds to the design of the instrument, so that the descending movement comes to its end only at the end of the pipe. This particular melodic figure must have acquired an almost conventional state, given the fact

¹⁴⁰ Berlin Egypt. Mus. inv. 12.461/2, acquired in Egypt in 1894; cf. Sachs 1921: 86–7, Nr. 88–9; Taf.11. I plan to discuss these pipes in *Studien zur Musikarchäologie* 7, with special emphasis also on the question as to whether they should be addressed as belonging to one instrument. The algorithms described in Hagel 2004a give the following pitches and minimal divergences from an equally tempered scale, with effective reed lengths of 3.2 cm and 4.3 cm respectively:

	tube		finger holes										
inv. 12.461		~223.1	241.1	255.3	283.3	313.2	337.7	376.4	427.0				
inv. 12.462	212.6				285.9	315.5	~344.2	382.0	429.6	472.2	505.4	560.2	
	$A+2$	B^b	$B+20$	$C+19$	$D-1$	$e-14$	$f+4$	$g-8$	$a+11$	$b-15$	$c+3$	$d-19$	

¹⁴¹ That overblowing was possible on these pipes is guaranteed by the fact that a double reed (now lost) was still attached to one of them when they were first documented, and by my experiments with a comparable reed on a replica of the Louvre aulos. If the tiny holes near the mouthpiece were 'speaker holes', used to facilitate overblowing, it would follow that this technique was employed on the instrument far beyond the production of e' and f' . But this is a hypothesis awaiting further experiment.

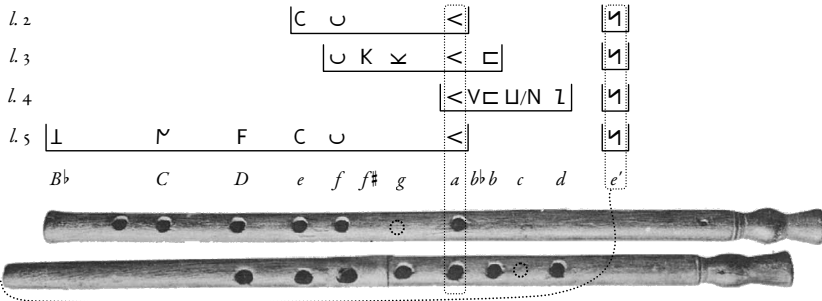
Diagram 75 *DAGM* N^o 61 and the Berlin aulos

that the alternative *B* hole was always plugged whenever a high *f'* was required at some point in the piece.

Taken together, these structural affinities leave no doubt that the Berlin aulos and the Michigan papyrus belong within a common paradigm of aulos music. This confirms the identification of the piece as an auletic composition, which is in turn of the highest importance for our knowledge of aulos playing techniques. It is a very different question, though, whether the Berlin aulos as such actually belongs to the particular class of instruments for which the score was written. Above all, the pitch of this instrument is almost an octave above that inferred for the notation. But this question is better deferred to a more thorough discussion of aulos types.¹⁴²

A newly published papyrus from the Louvre contains iambic trimeters from a *Medea* tragedy, part of which are set to music: two arias separated by spoken verses.¹⁴³ Although the text might be older, the Iastian key, and the melismatic style, where even elided syllables are furnished with a note, be-

¹⁴² See below, pp. 332ff.

¹⁴³ Bélis 2004, attributing both text and music to the younger Carcinus. One must note some inconsistencies in that edition: at the end of l.14, ZX K1 is transcribed into stave notation as if it were ZX X1; for the end of l.15, Bélis gives once CXO (1308), once OXO (1319). Furthermore, the music is regarded as written "pour voix grave, baryton et basse" (1320), which rests on the typical confusion caused by the traditional transcription: in fact, the octave from X to A corresponds to the convenient vocal range of about modern *d*(#) to *d'*(#). — Both because of its recent publication, and because the editor's readings still await discussion, the fragment has been excluded from most statistics in this book.

tray the late character of the composition.¹⁴⁴ The diatonic genus is also in agreement with a Roman Imperial date:

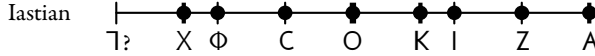

According to the editor, the melody remains within the octave from X to A. But it may be that at some places instances of Γ have been mistaken for carelessly written Z. This is at least highly plausible at line 12, κόρης, where the supposed XZ yields an upwards leap of a seventh at verse end, contrary to the word accent. This would be the only instance on the papyrus of written melody overriding word melody, against a total of fourteen not violated accents (plus probably 4 παῖ[δας]). A reading of X Γ amends this; on the published photograph, the note in question appears as , which seems to support the suggested correction.

Most frequent are I and Z. At verse end Z, O, C, Φ, and – probably – Γ are found; both arias terminate on O. This gives the unusual impression of an A–D mode, based on the fourth OZ, with a certain admixture of E, harmonically connected to A by the fourth XO. The prominent intervals are paralleled in other Iastian documents (cf. Diagram 69 on p.249 above); the present pieces are however distinguished by the lacking importance of C.

Pap. Oxy. 4710

3rd–4th cent. AD

The last published fragment is so tiny that its *tónos* cannot be determined. The legible notes are ICZU, which are common to all four citharodic keys.¹⁴⁵ In addition, one finds one or two instances of ♭, for which we have derived a plausible explanation as a variant form of I.¹⁴⁶ The modality is as obscure as the key, of course.

¹⁴⁴ Cf. now West 2007: 7–9. Bélis 2004: 1320, presuming original fourth-century BC music, fails to distinguish the post-Aristoxenian Iastian *tónos* from the early Iastian *harmonía*.

¹⁴⁵ Yuan (2005: 46) lists “Lydian, Hypolydian, and Hyperaeolian” as possible *tónoi*, perhaps mistaking Hyperaeolian for Hyperastian, and omitting Iastian. In Hyperaeolian, U does not appear except as *tritē synēménōn*, properly belonging to Iastian.

¹⁴⁶ Above, pp.315f. Yuan points out that otherwise ♭ shows up in Lydian or Hypolydian context. Counting individual vocal pieces from the Roman Imperial period, this fact is however significant only at a level of 10%:

	♭	no ♭
Lydian / Hypolydian	3	16
other	0	22

$p = 0.0909$ (Fisher’s exact test)

It is therefore not very safe to assume a predilection of ♭ for Lydian/Hypolydian, let alone exclusive applicability, on the basis of current data.

CONCLUSIONS

So what have we gained from the preceding survey of extant melodies and, unfortunately so much more often, melody fragments? From the earliest kinds of music we have mere echoes: the *Orestes* fragment with its apparent disregard of notated *tónoi* (N^o 3), the probable presence of an early approach to these in a Vienna papyrus (N^o 9), and the archaising parts of the Delphic Paeans, the extent of whose dependence on ancient tunes we can only guess (N^o 20–21). The oldest style of composition of which we could learn a little more is that highly modulating music of which the Ashmolean fragments are the prime example (N^o 5–6). It is almost certainly very close to the technique associated with Phrynis and Timotheus, and typically centred on the Phrygian key, in accordance with its presumed origin in the aulos-accompanied dithyramb.

The two paeans from Delphi both exhibit a tonality focussed on the functional *mésē*. In the citharist Limenios' composition, notated in Lydian, this harmonically pivotal note coincides with the *mésē* string of the cithara; the stringing of the same instrument can also explain other characteristics of this composition.

From the Roman era, several pieces are plausibly related to Ptolemy's cithara tunings. Especially *lydia* appears well attested (N^o 27; N^o 28; N^o 38; N^o 45; cf. N^o 24; N^o 25; N^o 40), but there are also at least two clear examples of *hypértropa* (N^o 42; N^o 50; cf. N^o 46; N^o 44?), and other scores point to *tritai* (N^o 43; N^o 53; N^o 55; N^o 44?; N^o 59?). Just as its intervals in Ptolemy suggest, *parypátai* was probably used only in combination with the latter (N^o 55). Of *trópoi*, the only surviving chromatic tuning, we encountered two possible examples (N^o 19; N^o 48).

The Bellermann pieces (N^o 33–7) suggested the assumption of a transposing class of auloi, presumably rather simple instruments for beginners, similar to the Louvre and Berlin auloi. That the 'modulating' second pipe of the latter was a typical feature emerged from comparison with another instrumental piece (N^o 61). Other compositions, also presumably for aulos, surprised us with their large gamut. This is already the case with the scattered instrumental notes found in some early fragments (N^o 3; N^o 11; N^o 15); later pieces can exhibit a large melodic compass (especially N^o 51).

A number of scores favour a range a fourth below the tessitura of the cithara, essentially between Γ and Z . We have considered the possibility of a taller lyre type, analogically to the old *bárbitos*. Although such an assumption would often be helpful, it also posed specific problems. This issue can only be pursued further with a more detailed knowledge of the alternative instrument, the aulos.¹⁴⁷

¹⁴⁷ The topic will be resumed below, pp. 356ff.

Aulos types and pitches

Because Ptolemy's tunings provided the necessary starting point for the interpretation of modal characteristics, much of the foregoing study of the fragments was concentrated on possible connections to the cithara. For the aulos we have no similar written source; hence we can consider this instrument only now that we have obtained an overview of the musical structures of melodic practice.¹

For the aulos there is once more a huge amount of pictorial evidence, which must be evaluated with the usual caution.² But here we have in addition a number of excavated instruments. Most of these are however highly damaged. Usually the upper end is missing, so that possible pitches can be deduced only indirectly, by finding the instrument length with which the finger holes would yield a plausible scale. But although this principle seems promising, it has not yet produced convincing results for most of the early finds. One cause is that we have almost always but a single pipe, while especially on some of the more primitive types with not more than five finger holes per tube, the notes of the two pipes probably complemented each other in some way. An additional complication is the rich number of different instrument types and sizes, mentioned by several authors from Aristoxenus on.³

¹ I do not discuss here the misguided views of Schlesinger 1939: see Landels 1981: 300–1; *AGM*: 96–7. For a stimulating discussion of the general characteristics of certain types of 'primitive' aulos music as inferred from recent traditions (although unfortunately marred by ignorance of the archaeological evidence and by uninformed disdain of the literary sources), cf. Ahrens 1987: 153–4; 160–3; 166–7; 175–6 (for the limited scope of such a study, see especially 154, n. 2; there is little hope that fading traditions, isolated in a rural environment, give us a good impression of what the music played at the Panhellenic competitions might have been like, not even at the period before the invention of mechanical auloi).

² Cf. e.g. Hagel 2004a: 375.

³ Cf. *AGM*: 89–94.

EARLIER AULOI AND THEIR ICONOGRAPHY

For the earlier times, we must therefore resort to the iconography also, mainly from vase paintings, even if this is the least trustworthy kind of source as regards details of playing. Yet since we found the evidence for lyre string lengths quite consistent, there is hope of assessing at least the most general relations of instrument size, estimated against the players' forearms.

The evaluation must once more rest on a well-defined corpus of representations. A natural choice is the collection of Paquette 1984. Otherwise, I have followed the same procedure as in the investigation of the lyres.⁴ In

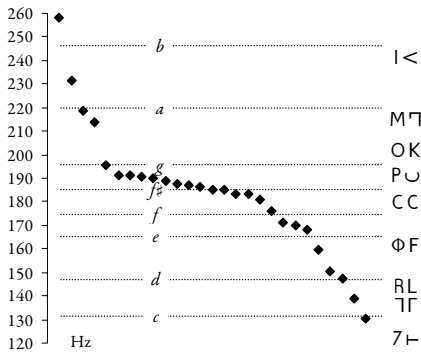

Diagram 76
Pitch of iconographic aulos tubes
(male players)

general, three significant points can be measured: the position of the index finger, which corresponds to the highest note (without overblowing); that of the small finger, which has however little immediate value, because it indicates some pitch above the lowest playable note; and the length of the entire tube. Only for the last we can expect that it was represented with some accuracy, since it contributes most to the overall impression of realistic proportion. Unfortunately, though, it does not necessarily reflect an employed note at all. Many early instruments

were equipped with a 'vent' hole below the lowest finger hole, which ensured that the timbre of the lowest playable note did not differ noticeably from that of a finger hole. The lowest pitch of such instruments is to be sought between the position of the small finger and the end of the tube.

We must nevertheless start with the tube lengths. Considering that only very rough data are obtainable from the iconography, the simplest calculation of pitches will suffice at this point.⁵ The results are plotted in Diagram

⁴ Cf. above, p.88. Where the measurements for the two pipes differ, I have taken those of the foreground pipe and hand.

⁵ To the estimated lengths a small amount must be added for the part of the mouthpiece inside the player's mouth, plus the 'end correction', which is slightly less than the diameter of the main bore.

76. Although the estimated pitches range over more than an octave, we observe an unmistakable concentration around 185 Hz,⁶ which indicates a sort of 'standard iconographic aulos', extending about 44.5 cm from the player's mouth. This is remarkably close to the length of the Louvre aulos, whose pipes measure 41 cm and must be equipped with a reed of about 4.5 cm effective length, the tip of which enters between the player's lips.⁷ The Reading pipe, complete but without mouthpiece, is 40 cm long, and appears to require a total effective length of about 43.5 cm.⁸ The remains of the Elgin pipes measure about 31 cm and 34 cm respectively, but their upper end is broken, and at least the conical reed insert is missing.⁹ Their original length (with reed) must have been quite similar. Likewise, the suggested interval relations of the Brauron pipe imply an effective tube length of 45.5 cm, identical to that of the Louvre pipes.¹⁰ The pipe fragment unearthed in Corinth requires an effective length of 45 cm to play the scale that was suggested for it.¹¹ Closest to a complete instrument of the classical type comes the recently excavated Pydna aulos, a pair of relatively well-preserved bone tubes.¹² These are comparatively short, measuring only 34.2 cm and 37.0 cm. But to retrieve resonant fifths and fourths, and a heptatonic scale, especially

Additional 'length' is contributed by the cavities below the closed finger holes above the opening. This quantity naturally decreases for higher finger holes, and becomes zero for the index finger hole. On the other hand, the vibrating air column extends a bit below the sounding finger hole, if the hole diameter is smaller than the main bore (for the physics involved, cf. Benade 1960; 1976: 431–5; 447–55). This effect is rather small on most extant auloi, whose finger holes are generally large in relation to the main bore (cf. Psaroudakēs 2002: 350–2, pl. 13–15). For the present calculation I have added 2 cm to each measurement. This will give consistent results for the entire tubes and the index holes, where the smaller diameter of the latter will about compensate for the effects of the hole cavities in the former cases. The small finger pitches will be a little too high in comparison; but this difference is of course much smaller than the uncertainties that arise from the nature of the source and the measurements. For the velocity of sound inside the tube I have assumed a value of 345 m/s.

⁶ Note that the interquartile range of the measurements amounts to not more than a tone (198 cents).

⁷ Cf. n. 77 on p. 292 above.

⁸ Landels 1968; *AGM*: 100. With the stated effective length and by the algorithms laid out in Hagel 2004a: 380–1, I obtain a fourth and a fifth above the lowest finger hole (494 and 721 cents, respectively), and an octave between the highest finger hole and the entire tube (1180 cents).

⁹ Cf. Baines 1962: 200; Letters 1969.

¹⁰ Landels 1963; Landels 1999: 273–5; *AGM*: 98: a fourth between thumbhole and second hole from the bottom; Hagel 2004a: 381.

¹¹ Broneer 1935: 73 with fig. 18; *AGM*: 99; drawing in Psaroudakēs 2002: 360 pl. 20.3 (with hole *v* erroneously shifted about 7 mm towards the lower end).

¹² Banou 1998; Psaroudakēs 2008. The aulos was found in a grave, almost in playing position. The site is not earlier than the first half of the fourth century bc; the instrument, however, is of the same simple type as the Brauron aulos, with six holes per pipe and no mechanism. In the funeral context, an instrument associated with traditional cultic functions may have appeared more in place than an up-to-date concert aulos, even if the deceased was a professional player (apart from this, mechanical auloi were incomparably costlier).

long mouthpieces of 6.5 cm and 6.9 cm effective length are required.¹³ Thus the longer Pydna pipe might come close to the usual extent, after all.

According to the established assignment of absolute pitch to the ancient notation, the pitch of the typical classical aulos tube seems to lie between CC and P U. The median of the 'iconographic aulos pitches' coincides with modern *f* sharp,¹⁴ and is therefore only a quartertone higher than the classical cithara *hypátē* as inferred from the pictorial evidence.¹⁵ Most importantly, this relation, since it is derived from similar sources by identical methods, is independent of absolute lengths and absolute pitches. The most straightforward interpretation is that one typical aulos type of the classical era sounded as its lowest pitch that of the lowest string of the old lyre, the full length of the pipe producing a kind of aulos *hypátē* analogous to the citharodic *hypátē*. Such a standard instrument would confirm our inferences concerning the evolution of the notation, especially that it did not originally extend below CC.

Sometimes, however, it seems clear that larger instruments are depicted. If blown without a vent hole, their inferred lowest pitches would drop to about ΓΓ, thus also covering Γ (= vocal V), the lowest instrumental note read on the *Orestes* papyrus (*DAGMN* 3).

All in all, the pictorial evidence for aulos lengths seems in good accord not only with the archaeological data but also with the expected pitch standards. It seems justified therefore to extend our survey to the represented fingering positions.

In Diagram 77 the index and small finger positions are printed together with the data for the pipe lengths.¹⁶ The placement of the small fingers is, in a sense, least consistent: the values are almost evenly distributed over about a fourth. One encounters great variation in the position of the index finger, as well; but here we observe once more a clustering at a certain pitch,

¹³ With these effective lengths I calculate the following resonant intervals between the pipes A and B (holes counted from the lower end): fifths: 1–6 (digression from perfect fifth: +7 cent); 5–2 (–5); 6–3 (+6); fourths: 1–5 (–6); 5–3 (+20); 6–4 (+14). These results must be regarded as provisional (Stelios Psaroudakēs kindly provided a copy of his measurements of the remains, which differ from Banou's in several points). Since the artefacts end close above the bulb, one wonders whether part of the reed insert is broken away and/or decayed. In this case, no unusually long reed would be required. Anyway, the hypothesis of unison playing (Banou 1998: 520) is untenable facing the marked differences between the pipes.

¹⁴ Here the median is preferable over the arithmetic mean because it is less sensitive to outliers, which enter the data either as careless representations or as unusual instruments.

¹⁵ Above, p. 90, we have derived the probable pitch of *nētē* Θ ♯ as lying between *f* and *f*♯ above middle *c*. *Hypátē* is an octave below.

¹⁶ Note that all three groups are sorted by magnitude independently: vertically aligned points are not derived from the same representation. Furthermore, in the present chart equal distances along the *y*-axis imply similar intervals, whereas Diagram 76 was scaled according to frequencies.

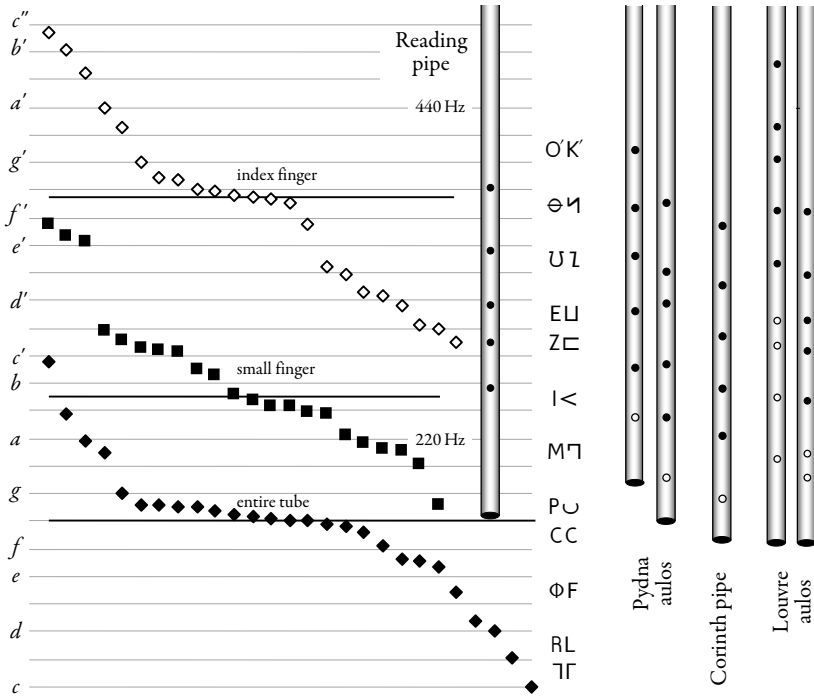

Diagram 77 Pitches of iconographic aulos fingering (male players)

which is identical with the median of the data. It lies slightly below *f* sharp above modern middle *c*, and therefore almost exactly an octave above the median tube length. Accordingly one would associate it with the citharodic *nētē* Θ ♯, which is at the same time our inferred highest pitch of the original notation. It may be of interest that the represented span between index and small fingers is almost always realistic.¹⁷

The reconstructed pitches of some extant auloi of simple design, especially of those with preserved upper end, are drawn to the right of the chart.¹⁸ In the case of the Reading pipe, the correspondence is astonishing: not only its tube length, but also the position of its index and small finger holes diverge from the respective iconographic medians by no more than a

¹⁷ Only twice have I obtained estimated spans above 13 cm (my current personal maximum is 14 cm, accessible only with the conveniently placed intermediate finger holes of early Greek instruments). The iconographical average is 10.7 cm.

¹⁸ Note that the 'finger holes' in the diagram do not reproduce the respective relative distances in the artefacts (which decrease towards the upper end), but their pitches. The especially small Berlin aulos is omitted.

sixth of a tone. One can imagine the missing pipe either filling in the gap at the lower end or extending the scale upwards.

On the Pydna aulos, the lowest hole on each pipe is a vent hole and cannot, under normal circumstances, be fingered. This taken into consideration, the iconographic median for the small finger falls right between the corresponding holes on the two Pydna pipes. The same is true for the index. The finger positions on the Corinth pipe are very similar, although it is pitched somewhat lower.

We have already observed that the length of the Louvre aulos is also close to the typical representation. In a similar way, the iconographic index finger hole corresponds to the highest note that is present on both pipes, and thus to the typical index position on the lower pipe. The additional three notes on the higher pipe extend over the range within which index fingers are at least sometimes depicted. The lowest pitches of the lower pipe are accessible only if its highest three holes are stopped by some kind of plugs.¹⁹ In this case, the index plays the fourth hole, and thus falls on the lowest position observed in the iconographic sample.

So far, one could barely wish for a better correspondence of the available sources. The conclusion that the 'Lydian' central octave between CC and CCC corresponds to the original focal pitch range appears at last established not only for the cithara, but also for the classical aulos. Thus the construction of both instrument types in their most typical forms appears engendered by the range of the male voice.

THE *PROSLAMBANÓMENOS* AULOS

The problems start as soon as one considers the actual scale of the Louvre aulos. Viewed as a self-contained note structure it is straightforward enough and testifies to the Greater Perfect System as deeply anchored within musical practice: we have seen that most of the Bellermann exercises require an instrument with the *proslambanómenos* as its lowest note, and could explain some melodic characteristics of the Papyrus Michigan 1205 only by reference to the specific design of the Louvre aulos and the Berlin instrument of closely related design.²⁰ Both instruments come from Egypt, but from a Hellenistic cultural context, as their shape with the typical bulb

¹⁹ Cf. Hesych., s.v. παραπλάσμος (cf. Borthwick 1967: 153 n.2).

²⁰ Above, pp. 290ff. and pp. 319ff.

below the reed insert betrays. So it is no wonder that they fit in with Greek music theory and melodies in Greek notation. Their date is unknown, since they were all purchased on the antiquities market, and none has been radiocarbon-dated. Exact knowledge of their age would not bring us much further anyway. The general type of instrument was very likely imported from a region which very rarely yields ancient artefacts made from wood. As I have argued earlier, the general type must very probably be dated to at least as early as the fourth century BC.²¹

Let us briefly recapitulate the basic features of this aulos class, which I would like to call the *proslambanómenos* aulos. The two pipes combine to a diatonic run from *proslambanómenos* (*A*, in relative pitch) up to *paranētē diezeugménōn* (*d*). With *nētē diezeugménōn* (*e'*) supplied by overblowing the *proslambanómenos*, one can obtain the Greater Perfect System with the exclusion of the *hyperbolaion* tetrachord. Accessing the latter would have implied a change of the playing position of at least one hand, and some additional fingering for *tritē hyperbolatōn* (*f'*) in the case of the Louvre aulos. The Berlin variant provides for the latter by a basic *B^b* on one of the tubes, which directly overblows to *f'*.

Such a layout is not only in accord with the main reference scale of Greek musical theory, but has also a specific practical advantage, whose importance cannot be overvalued. A semitone in the high range translates to a very small distance between neighbouring finger holes on the instrument; if the distances approach 1.5 cm or drop even below that mark, the pipe becomes unplayable except for tiny hands. Now the upper semitone (*b-c*) is bounded by two holes 1.4 cm apart on the Louvre aulos, and mere 1.0 cm on the Berlin instrument. Thanks to their specific layout, however, these holes need not be bored side by side, because the *tritē* (*c*) falls on the second highest finger hole, which is traditionally the thumb hole.²² Thus, both instruments are conveniently fingered even by an adult male player. This advantage doubtless contributed to the historical stability of the class of instru-

²¹ A main argument is the fact that in *Sect. can.* 19, p.163.18–164.2, the entire string of the canon, sounding the *proslambanómenos*, is introduced as *bómbyx*, a term denoting the aulos tube as a whole. As Barker (2007: 394–406) has shown, this chapter belongs in the late fourth century BC. Since it betrays the method of dividing a string as conceptually secondary to aulos boring, we must posit some kind of *proslambanómenos* aulos for a significantly earlier date. This accords with my interpretation of Aristot., *Met.* 1093b. Cf. Hagel 2005a; also, Hagel 2004a: 384–5.

²² We are accustomed to thumb holes occupying the highest position on modern instruments. But such a layout makes a pipe that is played with only one hand unmanageable. Here it is crucial that the force exerted by the thumb is opposed at each side; otherwise the torque exerted by the fingers is counteracted merely by the mouth via the reed, which is an entirely unfortunate option, especially with double reeds.

ments; of course it is the more essential, the higher pitched a particular pipe is.

The affinities of this type of instrument with Greek music, do not stop at the level of the scale, but extend to the harmonic relations which its layout suggests. The position of *mésē* an octave above the lowest producible note (*A*), and a fourth and fifth respectively below the highest producible notes in the main playing range, with and without overblowing (*d* and *e'*), makes it a natural tonal centre. Thus the presence of auloi of that kind is perhaps partly responsible for the importance of functional *mésē* in late classical and Hellenistic music. On the other hand, the instruments are also well suited for an alternative *G* mode. The particular position of *g* second from the top of one pipe and second from the lowest available note in the main playing position on the other provides it with possible melodic 'leading notes' above and below (*f* and *a*),²³ while the intervals of a fifth up to the highest finger hole (*d*) and a fifth and a fourth respectively down to the two lowest notes in the main playing position of the lower pipe (*D* and *C*, the latter perhaps often stopped in order to obtain *B* or *B^b* instead) embed it nicely within the usual harmonic *G–D* axis. For the *A* mode, we would expect an additional emphasis on *hypátē* (*e*). In the main playing position on the higher pipe, the lowest obtainable note is however the much less important *parypátē* (*f*), unless the hole for this note is permanently closed. That this was indeed a frequently used option is shown by the Berlin instrument, which incorporates a revolving bronze ring exactly in this position. Thus it was easily possible to switch between a scale with and one without *f*, the latter better suited for an *A–E* mode, the former providing the 'leading note' for a *G* mode.

Now we must revert to the question of pitch. Both the Bellermand pieces and the Michigan Papyrus 1205 are notated in Lydian; both show affinities to the *proslambanómenos* aulos, doubtless affinities in the case of the papyrus. But the Louvre aulos is pitched about a fifth above Lydian standard pitch: what we must call its *proslambanómenos* corresponds to about the note CC. In my first investigation of its scale I have therefore assumed that the aulos played an octave above the male voice, and consequently identified its *tónos* as Hypolydian, so that the sign CC would be assigned to the highest pitch of the lower pipe, representing not *proslambanómenos*, but *mésē*. This view can hardly be upheld against the obvious

²³ In modern theory, the term 'leading note' is usually reserved for degrees a semitone below or above a modally important pitch. A more relaxed usage suggests itself in the context of ancient music; cf. especially the employment of *hyperypátē* at the end of *DAGM* N^o 25 and N^o 26 or at the start of N^o 50; an expressive example is also N^o 51.13.

typical correspondence of male voice and aulos size. But there is also no plausible alternative *tónos*, which would instantiate the instrument's Perfect System at a proper pitch. In the final stage of the notation, the highest key is Hyperlydian, with *proslambanómenos* ΦF . This is still a tone below the Louvre aulos. Even if one would accept a discrepancy of this size, a Hyperlydian instrument would make no musical sense. This *tónos* was introduced for complementing the triadic symmetry and played an autonomous role neither in theory nor in the fragments.

Nevertheless, the most straightforward interpretation of the Louvre aulos' pitches produces a well-known series of notes: $\text{C C O K } \mathbb{Z} \sphericalangle | < \text{Z } \square \text{ E } \sqcup \text{ U } \text{L } \ominus \text{N}$ etc. This is nothing other than the cithara octave in a Hypolydian tuning such as Ptolemy's *trítai*. But if the Louvre aulos could play together with a lyre tuned to that key, it appears not unreasonable to call it a Hypolydian instrument, after all. The three highest notes of its higher pipe, however, extend the scale beyond the Hypolydian Perfect System of the notation. In consequence, the Perfect System of the instrument does not coincide with that of *tónos* theory. Indeed it had to be inferred that originally the concept of *tónoi* and that of the Perfect System evolved independently. So it should be little surprise if we encounter an instrument still standing in a tradition that does not pay tribute to the Aristoxenian fusion. If so, however, one must wonder how much of the *tónos* model would have entered the practice of writing down music for such an instrument – supposing that music for such rather primitive auloi was notated at all. We will deal with that question in a moment.

The Berlin aulos complicates the picture even further. Its rudimentary ring mechanism raises it above the cheapest levels of folk instruments. But it is pitched a minor third higher still than the Louvre aulos, far beyond any proper *tónos*. Even so, one might argue that it played Phrygian an octave higher – but there is no recourse to a Phrygian lyre tuning in the same pitch range, in analogy to the Hypolydian of the Louvre aulos. The Berlin instrument's close structural association with the Michigan Papyrus also makes a Phrygian interpretation appear dubious.

Reverting to the pieces in Lydian notation, it is essential to envisage the design of a genuine Lydian aulos, extending down to the bass notes. The Lydian *proslambanómenos* $\gamma \vdash$ requires a vibrating air column of about 67 cm. Although such pipes are not outside the scope of ancient representations,²⁴ they were almost certainly extraordinary, used by professionals for

²⁴ Cf. e.g. Marsyas' aulos on the relief from Mantinea, Athens 215 (Becker 1966: 97 Abb. 31). Later outstandingly long instruments also turn up in the hands of relief Satyrs – a fact which does not *per*

special purposes. Since their production was without doubt considerably more expensive, it is barely conceivable that commonly transmitted exercises for beginners such as the Bellermand pieces were associated (exclusively) with such enormous instruments.²⁵

All this supports a suspicion that we have already uttered in connection with the Bellermand exercises. Conceivably the Lydian notation of such pieces was not associated with the absolute pitch of the vocal and citharodic notation, but based on the notion of the natural scale. Thus they could be played by apprentices of different age and gender on instruments of different size but similar structure, and therefore with similar fingering.²⁶ Such a custom would very probably have stood in a tradition that went back to the very earliest stages of the notation, when only the core octave of the 'Lydian key' was in use.

If this assumption comes near the truth, it also provides us with a plausible model for the Louvre and Berlin auloi. These belong to the class of 'transposing instruments', to a more humble aulos family that coexisted with the sophisticated modulating instruments. Aristoxenus' famous classification of aulos sizes that include boys' and girls' instruments perhaps refers mainly to such simple kinds.²⁷ The complex auloi, which bore the evolution of the *tónoi*, belonged to a different cultural sphere of star musicians; similarly, the more complex aspects of the notation system probably remained attached to a rather high professional level. Anyway it would be more than puzzling if music for instruments different in pitch but similar in design and fingering had ever been notated in different keys: why should instrumentalists have embraced the most impractical solution possible?

All this taken into account, the interpretation of Diagram 77 becomes less straightforward. The ancient note signs, which provided such a welcome link between typical aulos and cithara ambitus, might apply merely to a subset of the depicted instruments. Even so, a general orientation of one or more types of auloi towards the range of the voice remains obvious.

se increase confidence in the organological validity of the representations (often such long pipes appear not fingered, but clenched in the player's fists, which substantially facilitated the masons' task). Among professionals, sheer instrument length might have been a factor of competition (cf. Paus. 9.30.2); the lower parts of such instruments were perhaps purely decorative.

²⁵ Note also that four finger holes that are involved in playing the notes of *DAGM* № 35 and № 37 cannot be spanned by one hand on an aulos in the Lydian *tónos* (the distance between ΓΓ and CC would amount to about 15 cm).

²⁶ An example for small auloi whose extremely high notes were not integrated into the *tónos* scheme is the Ephesus fragment (Psaroudakēs 2002: 362 pl. 22; cf. *AGM*: 97–9). Its probable pitch range was about 425–695 Hz (assuming an effective length of 8.1 cm for the broken part and the reed, the calculated intervals are: 160 – 186 – 172 – 179 – 161 cents).

²⁷ Cf. n. 78 on p. 292 above.

As regards the playing technique, only the four simplest Beller mann exercises could possibly be played in unison on both pipes, on a sufficiently small instrument. All other *aulos* pieces require either the distribution of the melodic notes between the two pipes, or the employment of some mechanism during performance, or both: a single hand is never able to control an entire octave. Professional instruments were equipped with such a mechanism, consisting of thin rotating metal bands, much more delicate than that of the Berlin *aulos*, and/or remote-operated sliders. Especially the former are found on a number of excavated (often fragmentary) instruments from Hellenistic times on.²⁸ It allowed closing and opening different holes along the instrument, and thus changing the playing position of the hand. The sliders, on the other hand, were used for low notes outside any playing position. With some skill, and cautious management of open holes, these techniques even made it possible to produce on one pipe a melodic figure such as we find at the end of N^o 32, with its octave leap doubtless among the most demanding extant passages²⁹ (admittedly, though, one might doubt the manuscript's reliability at that particular point). Alternatively, there is always the possibility of distributing the melody between the two pipes. In any case, whenever only one pipe took over the melodic line, the other must have provided some accompaniment, if only a drone.³⁰

N^o 32 stands out for its 'Lydian octave' as well as its placement in the manuscript. N^o 36 also comprises an octave, but in a simple ascending-descending movement. The rest of the Beller mann pieces are confined not only to one key but also to a rather narrow compass. These at least, and with a smaller probability also the two of extended range, may be regarded as natural candidates for a simple 'transposing' instrument class such as we have postulated. But what about the lively modulating music of the instru-

²⁸ For *aulos* sleeves and sliders see Howard 1893: 7–8; Bodley 1946; Masaraki 1974; Litvinsky 1999; Byrne 2000; *AGM*: 87–8; cf. also the fragments in Deonna 1938: 325, B 124–7637; pl. 812; Flourentzos 1991: 44–5; pl. 4.1–2; Kostoglou 1970: 331; πιν. 279α. That sleeve adjustment during performance is possible I have confirmed on an experimental instrument: with a little practice both sleeves and sliders can be operated melodically without disrupting the continuous sound produced by circular breathing. With appropriate mouthpieces, large intervallic jumps are possible. That quick mechanism operation was indeed part of the ancient playing technique elucidates from Philost., *v. Apoll.*, 5.21: τὸν δὲ εὐχεῖρα αὐλητὴν πολλοῦ ἡγοῦμαι ἄξιον, ἦν μήτε ὁ καρπὸς ἀπαγορεύη ἀνακλώμενος μήτε οἱ δάκτυλοι βραδεῖς ὡσιν ἐπιπέτεσθαι τοῖς φθόγγοις· καὶ γὰρ τὸ ταχέως μεταβάλλειν ἐκ τρόπου ἐς τρόπον περὶ τοὺς εὐχειράς ἐστι μᾶλλον. "I hold an aulete with a fine hand in great esteem, if neither his wrist grows weary of being bent upwards nor his fingers are slow to fly towards the notes; rapid modulation from key to key is also associated rather with fine hands." Here modulation doubtless involves mechanism action; otherwise there would be no question of speed.

²⁹ Cf. the score on p. 291 above.

³⁰ For possible drone techniques, cf. Byrne 2002a; against a greater importance of drones in ancient *aulos* music, Ahrens 1987: 160–1.

mental Michigan Papyrus (*DAGM* N^o 61), with its ambitus of more than an eleventh? Here, too, the Lydian is clearly the central *tónos*, around which the modulations revolve. The piece is equally unlike the Hellenistic Phrygian-centred music, of which we have encountered several examples, and the non-modulating Hyperastian pieces from the Berlin Papyrus (N^o 51–2). As a matter of fact, the occurrence of the note V sets it apart from all other music from the Roman era.³¹

Might an investigation of the technical requirements posed by the Michigan piece help in deciding whether it could be played in ‘proper’ Lydian pitch at all? As discussed above, each preserved line fragment is confined to a very specific range that in this case would reflect a particular fingering position. Diagram 78 displays the approximate physical spans for these ranges.³² Those of lines 2–4 are entirely reasonable for a trained male hand (although we will have to come back to the question of the number of holes). The required 29 cm for the notes of line 5, however, cannot possibly be covered by one hand in one position. But the difference from the largest reasonable span is so great that the hypothesis of a smaller ‘transposing’ instrument would be of no help either. Above all, there are six holes to be fingered, but only four fingers available, since the thumb holes of Greek and Roman instruments are confined to the second position from the top. If the notes were distributed between two pipes, on the other hand, the fingering would not have posed any problems on a large instrument of Lydian pitch either.³³

³¹ As regards the notes employed, N^o 61 might seem related to Limenios’ Delphic Paean (N^o 21), which is also notated in instrumental signs:

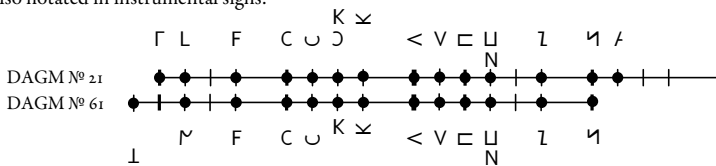

But we will see below that the resemblance is only superficial, the Paean being written for a different type of instrument.

³² The holes for the respective lowest notes must also be fingered, in order to play the overblown *nētē* ♩. The approximate measurements are based on calculations for a main bore diameter of 8 mm, a wall thickness of 3.5 mm, and finger holes of 6 mm diameter, by the software described in Hagel 2004a: 380–1. The semitones are assumed as 112 cents, so that they produce pure thirds (similar 16:15 semitones are intended – though inadequately derived – by Favonius Eulogius, *Comm. somm. Scip.* 26.8), about halfway between the Pythagorean *leímma* (90 cents) and the old 3/4-tone *pyknón* (c.150 cents). The necessary adjustments for larger bores and finger holes do not affect the present argument (e.g., the distance between the two topmost finger holes is the same for a main bore of 9.5 mm with 8 mm finger holes).

³³ With 13 cm for the lower hand, the *proslambanómenos* (and thus the *nētē*) are available on both pipes; if it is needed on one pipe only, the larger span is a mere 11 cm.

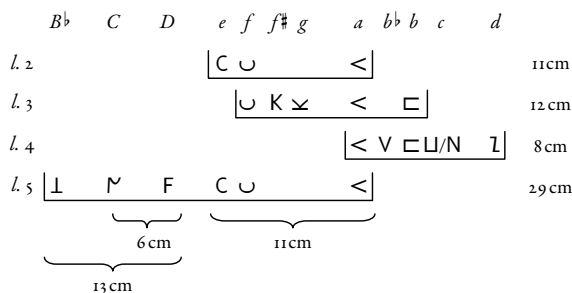

But would a mechanical aulos, equipped with rotating sleeves, make it possible at all to play the complicated line 5 with one hand? Even with such a mechanism, one cannot perform any given sequence of notes: just as in modern instrumental compositions, ancient composers had to pay attention to the restrictions of playing technique. Thanks to the unbroken sequence of ten notes in line 5, we are in a position to infer the necessary adjustments if the entire melody is to be performed on only one pipe of the pair.

The initial upwards movement leads from U over a major third to *mésē* < and further to *nētē* M. Consequently it must be possible to access the two holes for U and <, and then to close all holes, in one rather quick movement. Thus, the highest fingered note is <, above which all holes must be closed by the rotating sleeves. Four fingers being available, all notes below *hypátē* C must for the present remain mechanically obturated, too. Furthermore, it proves convenient to have the □ = □ hole mechanically stopped, as well – the corresponding note occurs only once in line 3, in Hypolydian context. This, then, is the most convenient initial configuration, displayed leftmost in Diagram 79: the index stops the < hole, while the rest of the hand is free.³⁴

For the second note, the index finger is released, and then all holes are stopped at once, to sound the *nētē*, on a longer note. Now it is time to prepare the following descent. First of all, the sleeve of the highest hole fingered up to now has to be pushed shut, preferably at the first occurrence of *nētē*: otherwise a small pause would be required after this long note (in the diagram, mechanism action is indicated by arrows).

This accomplished, the return to U is possible by releasing the two remaining fingered holes. So far it is easy, provided that the reed is prepared

³⁴ The diagram ignores the modulating notes that are needed for the foregoing lines.

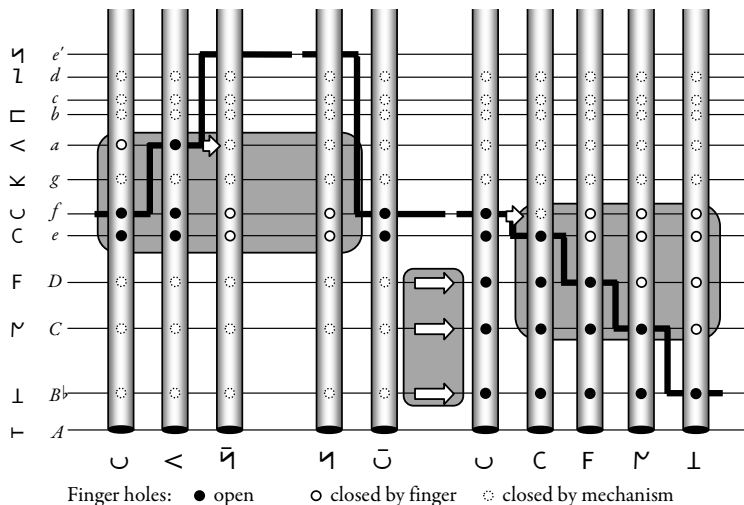

Diagram 79 Playing *DAGM* No. 61.4 one-handed?
(hole and tube diameters drawn not to scale)

to overblow readily. But now that the hand is temporarily free, it must move towards the lower end of the pipe, in order to open the remaining three holes,³⁵ and then back, so that the index reaches the *parypátē*. Then the final descent requires no more than subsequently closing holes: the highest by shutting its sleeve, the rest can conveniently be fingered, as well. Or, the hand might work its way down by opening and closing holes in turns. The crucial question is whether either this or the alternative of opening no less than three holes and returning to *U* with the index finger within the duration of a long and a short note was feasible. Of course, this depends on the tempo of the piece, about which we know nothing. The required action would perhaps have been facilitated if the lowest three holes were equipped not with sleeves but with sliders, which allow the hand to remain in the higher position.³⁶

On balance, performing the piece in Lydian pitch is doubtless demanding, but probably not impossible: the melody appears to be composed in a way that does not transgress the capabilities of one-handed playing. This

³⁵ The generally large finger hole diameter relative to the bore of ancient auloi ensures that (almost) no change of pitch occurs while opening the additional holes below the open two or three, in any case not at such large inter-hole distances as are here involved.

³⁶ It is worth mentioning that the sliders published by Kostoglou 1970, appear to be of just the required lengths for such a scale.

impression might find confirmation in the fact that we find note protraction and repetition precisely at the point where extensive mechanism action is probable. Also, changes of playing position, indicated in the diagram by grey fields, are well provided for: they are necessary only where the hand is not busy otherwise. Certainly the player would have to act very swiftly, but if the mechanism worked easily³⁷ the required skills are perhaps not beyond what we should expect from a professional instrumentalist.

The rest of the document does not contradict such a view. Line 4 employs the top five finger holes, which include the thumb hole, so that it is executed in a stable playing position and without turning any sleeve. In line 2, merely three notes are read, apart from the overblown *nētē*; they are handled conveniently. Line 3, as well, requires no change of hand position; but the five different notes in a range without thumb hole necessitate some mechanism action. Several notes are missing, and more than one solution is conceivable: either by closing one of the lower holes, K or ∞ before playing the ♯, or by opening □ afterwards.

On the other hand, what about a transposing instrument similar to the Berlin aulos? On such an instrument, the melodic notes of the fragment have to be distributed between the two pipes, which leads to the troublesome question, how melody and accompaniment were distinguished, if neither by volume nor by a fixed relation that would keep the accompaniment invariably either above or below.³⁸ Furthermore, the modulating pitches of K and V are to be produced by half-stopping finger holes (both are instanced only once). All this conceded, the notes of the fragment are accessible in one and the same playing position, if the unneeded finger holes are all plugged (i.e., those crossed out in Diagram 80).

Of course, the strongest argument for this kind of instrument is that we have archaeological evidence that it existed, combined with the fact that its design reflects the melodic idiosyncrasies of the papyrus so nicely, at least on a structural level. On the other hand, if no change of playing position was necessary, after all, we find ourselves bereaved of the most straightforward explanation for the isolated ubiquity of *nētē* ♯. Instead, one would have to suggest something less obvious, for instance that the different, and specifically shriller, sound quality resulting from overblowing ensured its perception as a melodic note in any context.

³⁷ My experiments show that well-fitted sleeves do not need much pressure to remain sufficiently airtight. On top of this, the alloy found on such pipes is said to yield self-lubricating corrosion products (Byrne 2000: 282).

³⁸ On the supposed partition into melodic and accompanying pipe, cf. Howard 1893: 43–7; *AGM*: 103–5.

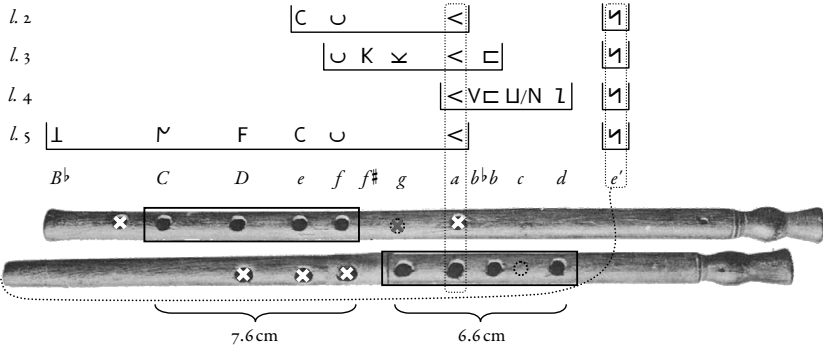
Aulos types and pitchesDiagram 80 Playing DAGM N^o 61 on the Berlin aulos?

The conundrum can hardly be solved solely on the basis of the available evidence. In view of the occurrence of the modulating B^b we cannot but presume some correspondence between the melody and the Berlin aulos, even if it is not of a straightforward kind. In any case, it reinforces the suspicion that the piece was applicable to a transposing aulos. The appearance of both B^b and $\mathcal{M} = e'$, which presupposes a lowest pitch of A , is a strong argument for a distribution of the melody between the pipes. On the other hand, it appeared perfectly possible to play the melody on one pipe only, even at the low pitch of the Lydian *tónos*. Such an interpretation avoids the accompaniment dilemma, and accounts better for the isolation of \mathcal{M} .

Quite possibly, the truth is to be sought between the two extremes. It is certainly not necessary to assume that all auloi whose design was based on the Perfect System belonged to the rather humble cultural level suggested by the Louvre instrument. The Berlin aulos possessed a rudimentary form of mechanism, and there may have been others with a more elaborate one. These, of course, would have been much scarcer, and therefore less likely to appear in the record. Still, it is clear that even for professional instruments of such a 'transposing' type, one would choose the 'natural' notation.

For the melody of N^o 61 in particular, an aulos with the general characteristics of the Berlin aulos doubtless appears most fitting, but one would probably expect an instrument of somewhat lower pitch. At least the upper part of the higher pipe should be equipped with sleeves, so that it can play melodically between C and \mathcal{M} , *hypátē* and (overblown) *nētē*. If *tritē hyperbolaiōn* was required, the melody would change to the other pipe, overblowing its low B^b ; here the shriller sound would have assured the perception of the note as belonging to the melody. Thus an element of melody distribution is introduced into an instrument that otherwise mostly keeps

the melody to one particular pipe. Another instance is very probably the end of the fragment, where the downwards run so obviously reflects the lower part of the B^b pipe. Here the recognition of notes produced on the 'secondary' pipe as melodic may have been prompted by a contrast of motion against (relative) stability: the downwards movement starts from \cup , common to both pipes, the temporary insistence on which prepares for \perp , a fifth below. Conceivably, \cup was subsequently dwelt upon on the higher pipe, or perhaps alternated with C .

This possible resolution of the tension between the clear structural affinities associating the Michigan papyrus with the Berlin aulos on the one hand, and the problems that an all too straightforward connection raises on the other, can of course not be regarded as anything but speculative. Future evidence may either corroborate or overthrow it. In any case, one point seems established beyond reasonable doubt: in contrast to a widely held belief about aulos music,³⁹ in the case of the present fragment the pitch of the accompaniment cannot have been above that of the melody throughout. On the contrary, it seems that of the two pipes of a *proslambanómenos* aulos it was generally the higher one that carried the melody, a relation that could be reversed only under special circumstances.

THE HELLENISTIC 'TÓNOI AULOS'

Among the excavated instruments, we cannot currently identify a Hellenistic aulos of the multi-*tónos* class, i.e. one playing in Dorian, Phrygian and Lydian. But there is indirect evidence for this type of instrument.⁴⁰ When investigating the evolution of the simple 'Lydian' core notation into the *tónos* model, we posited an aulos with ΓN (= Lydian $E \perp$) as its highest hole, in respect to which the old scales were aligned.⁴¹ A look at the extant melodies shows that several of them have their upper limit precisely at this note. The earliest are the Ashmolean Papyri (*DAGM* N^o 5–6) and some of the Vienna Papyri (N^o 10; 14–16), all from the third or second century BC; the most valuable testimony for the technique of the aulos is certainly the instrumental interlude found on one of them (N^o 15.2–3). A similar upper limit occurs in later pieces, as well, even in typical citharodic music such as

³⁹ E.g. Howard 1893: 45; but cf. 47.

⁴⁰ For the following, cf. Hagel 2009.

⁴¹ Above, pp. 34 ff.

Aulos types and pitches

	$\Gamma N / E \sqcup$	other		$\leq \Gamma N / E \sqcup$	other
BC	6	8	BC	10	4
AD	8	41	AD	19	30

$p = 0.0453$
 (Fisher's exact test)

$p = 0.0312$
 (Fisher's exact test)

Table 12 Top notes of musical documents BC and AD

Mesomedes' hymns. On closer investigation, however, it emerges as much more frequent in Hellenistic pieces (Table 12, left part).⁴² Even where the notes ΓN or $E \sqcup$ themselves are not directly attested, the vast majority of early documents does not rise above this pitch (Table 12, right part). Note also that, according to our interpretation, the inclusion of the *Orestes* papyrus (N^o 3) in the data obfuscates the statistics, since it belongs to the earlier paradigm of non-*tónos* notation.⁴³

It is therefore reasonable to assume that the mere 16 per cent of Roman era pieces with respective upper limit are the result of random distribution, whereas the 43 per cent in Hellenistic times reflect some element of musical reality. Confidence in the suggested characteristics of the early *tónos* aulos is thus strengthened considerably. That they are reflected in vocal scores speaks for a widespread practice of redoubling the sung melody on one pipe, so that the amount of 'heterophony' in aulody or choral song did not go much beyond that of purely instrumental music.

From the established highest note, whose pitch is known within relatively narrow boundaries, it is easy to calculate the extension of the highest playing range, i.e., the span within which the remaining finger holes could be bored. The lowest pitch that the small finger can play with ease if the index closes the top hole for ΓN , is six semitones below (cf. Diagram 81, which includes a chart of relative note frequencies in the Hellenistic era). Alternatively, the next lower semitone could also be reached, although only with considerable difficulty, and only if the note for the ring finger is at least an entire tone higher (this is the tone between $P \cup$ to $M \sqcup$ in diatonic Lydian / Hypophrygian and between $\Pi \cup$ and $M \sqcup$ in Phrygian and (Hypo-)Dorian). Within the usual heptatonic scales, these possible intervals of a tritone or a fifth respectively comprise five notes, so that optimal advantage is taken of the five fingers. If the five highest finger holes are all

⁴² Where possible, the individual pieces of collections contained on one document have been counted. *DAGM* N^o 7 with its apparently mostly theoretical material, and the Mylasa inscription (*DAGM* N^o 22), whose readings are uncertain, have been discarded.

⁴³ Without the *Orestes* papyrus, for the difference between pieces with and without a definite highest limit of $\Gamma N / E \sqcup$: $p = 0.0324$ (Fisher's exact test).

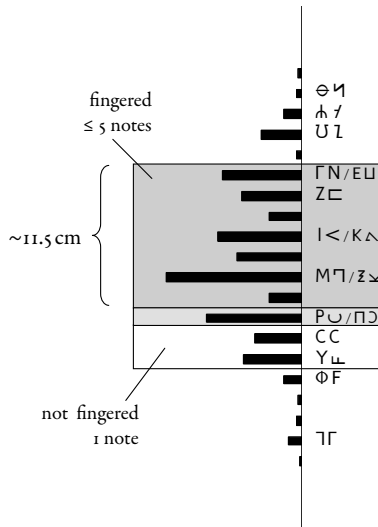

Diagram 81
Highest playing range of a tónoi aulos

stopped, the next lower one sounds, whose position is no longer determined by the capabilities of the player's hand. In a continuous scale, two notes come especially into question: on the one hand, ϚϚ as the Lydian *hypátē* (corresponding to chromatic Τ Ϝ in Phrygian), on the other, ΥϚ, which plays an important role as the lower boundary in the Phrygian modulating style as we know it from the Ashmolean, the Hibeh and the Zenon Papyri, and from the second part of Athenaeus' Delphic Paean (*DAGM* №5–8; 20). Out of physical considerations, therefore, it is to be expected that the primary range of such an aulos reached down to about ϚϚ ± a semitone, depending on the actual *tónos* played.

In contrast, the instrumental interlude of *DAGM* №15 employs a surprisingly large compass of an octave and three tones. Its lowest part, however, is constituted by an empty fourth, the bass note Η being connected to the rest of the melody solely by large leaps. In the entire corpus, this is by far the lowest note that comes into question for instrumental execution.⁴⁴ The second lowest note, Γ, is still separated from the rest of the instrumental part by a fourth – although the voice drops almost that deep, so that a note-to-note accompaniment would require melodic play in this region.

⁴⁴ The bass section of *DAGM* № 41 goes even lower; but, as discussed above, it merely duplicates the overall scale, one octave above, for a special effect, and requires no extraordinary accompaniment.

If the pitches are converted to pipe measurements, the resulting instrument is again much larger than those usually shown in iconographical sources.⁴⁵ The pipe for the bass notes requires an effective length of about 80 cm, on the upper half of which the finger holes for the melody come to lie:⁴⁶

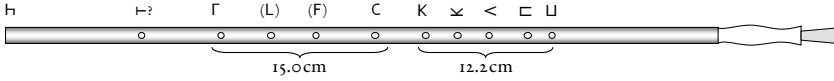

As discussed above, it is possible within one pipe to finger the notes from the top down to OK without changing the hand position. With all five fingers closing their holes, one additional lower note is accessible. Judging from line 2, this was almost certainly CC in this case:

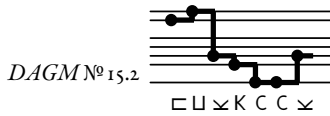

The leaps of line 3 cannot be performed at all within one playing position by ordinary fingering: too far is the distance between OK and ΓΓ, which would have to be accessed simultaneously:

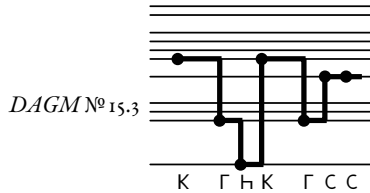

⁴⁵ Instruments of about the required length are sometimes shown accompanying dances in armour (Poursat 1968: Fig. 61; 12–13; still longer, perhaps 115 cm: Fig. 10). But even here the tube lengths cluster at a value corresponding to the assumed pitch of CC, the median being not lower than Φ F. Apparently, for dance-in-armour scenes the artists either drew a ‘standard aulete’, or they emphasised the instrument’s length:

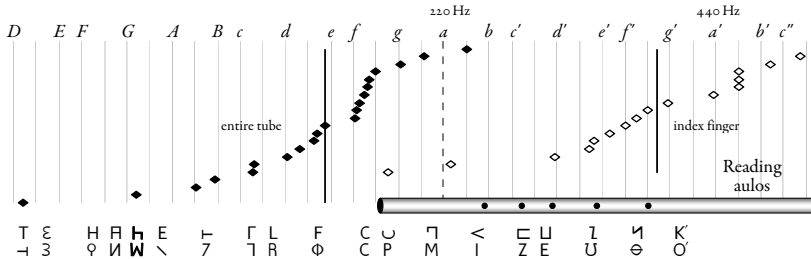

For the Roman period, cf. e.g. Vendries 1999: 228 Fig. 30 (Cyrene; two long pipes with bells and lateral tubes).

⁴⁶ In the graphics, the ‘semitone’ finger holes have been calculated as the old 3/4-tone *pykná* implied by Aristoxenus. This has no effect on the argument.

So how can this problem be solved? An option is to suspect the reading of the unique Γ as well as the doubtful \vdash altogether.⁴⁷ If the lowest note were Γ , the aulos would become quite an ordinary instrument, well adapted to the accompaniment of male voices, and a natural predecessor of the objects we are going to discuss afterwards.

But there are other, less desperate, possibilities. If sleeves are of no help, we ought to consider the other type of mechanism, the remote-operated sliders. Within one pipe, this would necessitate the transition from Γ to \mathbf{H} , without an intervening higher note, solely by pushing the Γ slider shut. In principle, this is perfectly possible; there is however the question of which finger should perform it, since sounding the Γ requires all higher holes closed. Consequently one would first have to release at least one finger by occluding its hole with the sleeve. In practice, it is necessary to change the hand position, in order to access the \mathbf{C} hole and to free the small finger for operating the slider button.⁴⁸ Starting from the configuration in line 2 this means merely closing the two topmost holes (\sqcup and \sqcap); then, the three long fingers can handle the holes for \sphericalangle , \mathbf{K} , and \mathbf{C} , while the small finger manages the Γ slider. Alternatively, of course, the melody might once more have been distributed between the pipes.

In any case, the short fragment leads to very specific conclusions about the instrument on which it was performed. Most plausibly, its top finger hole played the 'modulating *nētē*' \sqcup/\mathbf{N} . In the bass region, there were holes for Γ , \vdash (which is however the least certain note), and \mathbf{H} . The latter represented perhaps the lower end of the pipe, whereas the former two must have been operated by sliders. The lowest extant note used in contiguous melody is \mathbf{C} . Given the minimal range required for the two positions of the Γ slider button, the row of finger holes cannot possibly have reached much further down.

Luckily, these inferences are substantiated by positive evidence. At Pergamum the lower part of the bronze model of an aulos with remote-operated sliders has been unearthed.⁴⁹ As a model,⁵⁰ it did certainly reflect the

⁴⁷ Cf. Pöhlmann 1966: 503: "die Instrumentalnoten \vdash und Γ , die allerdings nicht ganz sicher lesbar sind".

⁴⁸ The small finger is much more versatile along the axis of the instrument than are the ring and the middle fingers. Moreover, to prevent the rods from intervening with fingers and sleeves, they may extend only a little into the fingered region. On the Pergamum model (cf. p. 347 below), one button lies significantly below the lowest finger hole, the other two are roughly aligned with the second lowest. This design proved useful in experiment.

⁴⁹ Published with an excellent drawing in Conze 1902: 7–8 with Taf. 1 (reproduced in *AGM*: 88 Fig. 4.1; Byrne 2002a: 372 Fig. 1); photograph in Behn 1954, Taf. 58 Abb. 134 (together with a mistaken reconstruction, cf. Byrne 2002a: 367). The fate of the original is currently unknown (Byrne, loc. cit.). Shorter sliders of similar form were found in Delos (Kostoglou 1970: 331 πιν. 279α); ones of

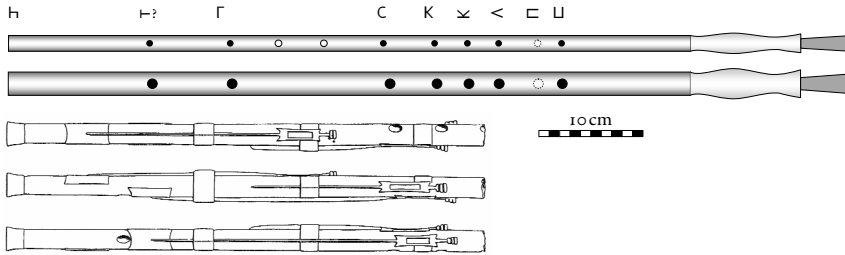
Diagram 82 *DAGM* № 15 and the Conze model

basic properties and proportions of an actual instrument, even if details such as the exact hole positions are probably not accurate. Furthermore, the considerable size of the artefact, as well as the realistic diameters and distances, suggest that it was not scaled down.⁵¹

Diagram 82 juxtaposes the calculated measurements for playing *DAGM* № 15 and the design of the Pergamum artefact (shown from three sides). Below the hypothetical pipe from above another one is drawn whose dimensions resemble those of the find.⁵² The correspondences are surprisingly close. Above all, the row of proper finger holes of the model extends down to the same region as the continuous melodic scale of the papyrus. Also, the distances between the three extant finger holes very roughly match those required.⁵³ Of the three holes to be covered by sliders, only one is visible. It diverges from the position needed for H– by a musically significant amount – still, in a model, the correspondence may seem close

slightly different make at Meroë (late first century BC: Bodley 1946: 233 with pll. 5, 12–14 and pl. 6.1) and in Bactria (Takht-i Sangin, Seleucid era: Litvinsky 1999).

⁵⁰ Byrne, who provides a most valuable discussion of this type of aulos and its playing capabilities, sees “no reason not to take it as part of an actual instrument” (2002a: 367). Actually the main reason is, apart from the presence of a rod without slider and, more importantly, without a hole to cover, the fact that the object is solid (Conze 1902: 7; Behn 1954: 101–2).

⁵¹ So also Conze 1902: 7 (“Es scheint ein Abbild in Naturgröße”).

⁵² Since the solid model does not allow a direct measurement of a main bore, whose diameter must however exceed that of the finger holes (~ 9 mm), and since aulos pipe walls are generally rather thin, a bore of 12 mm is assumed. A comparison between the two calculated pipes reveals that minor variations within the parameters affect the present argument little.

⁵³ On the assumption of a main bore of 12 mm, an overall effective length of 81.9 cm yields the required octave between the entire pipe and the second finger hole (H–K; calculated as described in Hagel 2004a). The distances between the finger holes would then amount to tones (calculated 195 and 200 cents respectively), and the lowest finger hole would sound a pitch of about 179 Hz (f^{+47}) – exactly the generally assumed pitch of CC (between f and f^\sharp). The calculation accords with the pitches measured by Byrne on his “reproduction” (Byrne 2002a: 368; 373 Ex. 1, with pitches rounded to the nearest modern semitone. The reference to an overall tube length of 68 cm must however be an error, unless Byrne’s *guan-zi* reed has an effective length of almost 15 cm).

enough.⁵⁴ The second slider that the extant notes of N^o 15 demand is that for Γ. Here no slider plate is visible, and no hole seems provided; but the lower end of the respective rod extends just into the required region.⁵⁵

The Pergamum artefact is dated, with some caution, to the second century BC, and thus not much later than the Vienna papyrus, which calls for an instrument of similar capabilities. The analogy of the contrast between a freely flowing melody in the higher range and the marked leaps to detached notes in the bass region on the papyrus, and the row of closely spaced finger holes as opposed to the three sliders, distributed over the lower part of the Pergamum aulos, leaves no room for doubt: at least one of the pipes of the aulos for which that melody was written was equipped with very similar sliders. Especially intriguing is the fact that the instrument's lowest finger hole was apparently very close to the most typical tube length of earlier iconography. Thus, the lower part with its slider holes was perhaps an extension of a simpler type of instrument, perhaps with the original intention of adding different drones.⁵⁶ Early long pipes, in analogy, would have provided only one drone (either in total or per pipe).

One can also speculate whether the papyrus, in combination with our reconstruction of the upper limit of the *tónos* aulos, contributes to a reconstruction of the upper half of the Pergamum model in turn. If so, we would expect three more finger holes, although the higher of these might have been bored only on the other pipe. Furthermore, in concordance with the fragment, we would assume that the highest slider hole sounded the fourth below the lowest finger hole. But such a simple equation between Pergamum instrument and Vienna Papyrus instrument would again be careless. If the slider holes are related to the Lydian and Hypolydian scales in a straightforward way, it remains unexplained why the upper limit of the piece is that of the polymodal aulos. For such an instrument, we might expect drone pitches that relate to different *tónoi*.⁵⁷ So we obtain merely a

⁵⁴ Under the assumptions stated in the previous note, the pitch of the hole would lie a third of a tone below the required fifth below the lowest finger hole.

⁵⁵ For the reconstruction of the suggested hole position, cf. Hagen 2009: 242–3 with n. 20.

⁵⁶ For double pipes with three alternating drones one tone apart from each other cf. the Georgian *gudastwiri* bagpipe (Emsheimer 1980: 235). On the Pergamum model the slider holes are not aligned with the finger holes, which is a corollary of the rod mechanism. Might this be the solution to the riddle of “lateral openings”, with the invention of which the aulete Diodorus of Thebes is credited (Pollux 4.80)?

⁵⁷ One might wonder whether the lowest note of the Pergamum tube might have been intended for the Dorian *proslambanómenos* И Π, not the Hypolydian *hypatē hypatōn* W Π of the fragment, one semitone higher. The lowest finger hole would then correspond to Υ Λ, the typical lowest note of Hellenistic ‘Phrygian’ music (*DAGM* № 5–8 and the second section of № 20), while the correspond-

fascinating glance into Hellenistic aulos technique, but still remain far from solving all the questions concerning the class of early modulating instruments.⁵⁸ Perhaps it deserves mention, as a final point, that the hole beneath the lowest slider of the model would yield the instrumental note E (Phrygian *proslambanómenos* and Dorian *hypátē hypatón*) as its fundamental, but $\bar{\Gamma}$ a twelfth higher, if overblown. The latter occurs persistently in the *Orestes* fragment, and is found also on another Vienna Papyrus (*DAGM* N^o 11), in both cases wide above the (few) other instrumental notes. Would the assumption of an overblowing technique solve this riddle?⁵⁹

The discovery that melodic leaps below *hypátē* CC, and primarily to $\bar{\Gamma}\Gamma$, have a very material background in aulos design, leads us further to an enhanced understanding of Limenios' Delphic Paean (*DAGM* N^o 21). Here we have observed that $\bar{\Gamma}\Gamma$ occurs exclusively in such leaps, but were not able to explain this phenomenon.⁶⁰ Now it becomes clear that the leaps introduce an element of aulos music into the vocal line. Consequently such melodic figures are excluded from the first section (ll. 1–7) with its strongest archaic-Apollinian associations; similarly Athenaeus' paean (*DAGM* N^o 20) defers auletic ingredients to its second section.

On the other hand, it is also conspicuous how Limenios reserves the three highest notes, $\bar{\Gamma}$ – $\bar{\mathfrak{M}}$ – $\bar{\iota}$, for certain parts and special purposes, even though $\bar{\Gamma}$ and $\bar{\mathfrak{M}}$ were evidently part of traditional cithara stringing. All three occur only in the shrill melody that describes the Galatian assault (ll. 31–3), $\bar{\iota}$ being entirely restricted to this context. $\bar{\Gamma}$ also appears in the first section, in accordance with its 'citharodic' character, but otherwise only twice, obviously underlining mention of the performers and their music (l. 15 on $\Lambda\iota\beta\upsilon\varsigma$, geographical epithet for the aulos; l. 38 on the imperative $\mu\acute{o}\lambda\epsilon\tau\epsilon$ within the final prayer, distinguishing the plea for the musicians from those for the Delphians and the Romans). Finally, $\bar{\mathfrak{M}}$ is employed only twice outside the Galatian part, once to mark the god's arrival at the composer's home city (l. 14), once – probably – illustrating the steeply rising precipice of Parnassus (l. 23).

Apart from these instances, all of which betray their programmatic motivation, the upper limit of the melody is $\bar{\Lambda}$, and thus identical with the up-

ing expected highest note would still remain $\bar{\Gamma}$ N. But this interpretation cannot easily accommodate the visible slider hole.

⁵⁸ Some of these conceivably involved sliders capable of producing more than one pitch, as are implied by the find of a slider-covered slot (Litvinsky 1999: 520–1; cf. Byrne 2002a: 368).

⁵⁹ If we can trust Psell. (?), *Trag.* 5 (cf. n. 158 on p. 440 below), that Euripides was the first to use extended scales in tragedy, it might point to the introduction of the mechanical aulos to the theatre.

⁶⁰ Above, p. 284.

per limit of the reconstructed *tónos* aulos, and of such a great part of the other early fragments. Apparently the design of the aulos that took part in the original performance of this paean was very close to the instrument of N^o 15. A row of finger holes provides for melodic play between CC and E U; below there is a gap of a fourth, the next available note being TΓ. Whether the paean aulos also incorporated additional bass notes, such as the instrumental score of N^o 15 requires, we do not know. If so, the highest vocal notes might have been available as harmonics: ♯ from the 7┊ hole that N^o 15 demands; possibly also ♭ from an \ E hole. In any case, the singers were not forced to the low register of the corresponding fundamentals; but the absence of these notes from their score is of course no argument against the existence of respective pitches on the accompanying aulos.

Starting from an eleven-stringed cithara and the minimal assumption of an aulos with lowest pitch TΓ, the coincidence between vocal and instrumental compass is remarkable enough. Of the extant notated syllables 94.7% fall within the range of the cithara (95.4%, if harmonics are admitted). The aulos, on the other hand, could accompany 92.5% in unison. For at least 88.6% of the music, accordance of voice, a lyre string and an aulos note was possible. Only in 1.5% (0.7% with cithara harmonics), none of the instruments could follow the song; still, they would always be able to play an octave above or below.

All in all, concurrent evidence suggests that the type of aulos described – with finger holes in the range between Γ N/E U and (about) CC, plus one or more bass notes accessible by sliders on rods if necessary – represents a main type of refined Hellenistic music.

ROMAN IMPERIAL AULOI

From the Roman era, the excavations at Pompeii yielded a set of four elaborate pipes in relatively good condition, measuring between 49 cm and 54 cm. They have no remote-operated sliders, all of their ten to nineteen finger holes being (or having been) equipped with metal rotary sleeves. An investigation of their pitches revealed that they belong within a common tonal paradigm, so that the pipes were perhaps played in several combinations.⁶¹ The identification of finger holes with ancient notes proved unequivocal under the assumption that the instruments related to the recog-

⁶¹ Howard 1893: 47–55; pl. II.; Hagel 2008a (on which the following arguments are based).

Aulos types and pitches

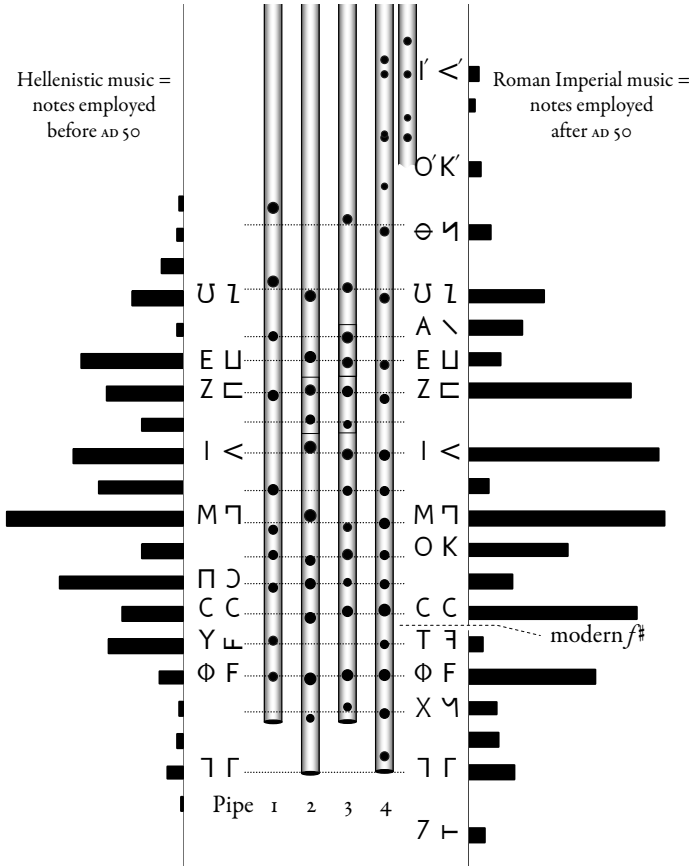

Diagram 83 The notes of the Pompeii pipes

nised facts about ancient music. It emerged that their pitch was a bit higher than the commonly assumed standard: their Lydian *hypátē* CC apparently lies about a quartertone above modern *f*#.

The notes it was possible to play with each pipe can be gathered from Diagram 83,⁶² where the frequency of individual notes in the musical documents is displayed in the bars at both sides.⁶³ The destruction of Pompeii

⁶² The highest pitches must be regarded as mere approximations. For the two pairs of holes at the top of Pipe 4, two sets of calculated pitches are printed: one with the respective lower neighbouring hole closed, one with this hole left open.

⁶³ The note signs are given merely for orientation: in the different keys, the same pitches are often notated with different signs. For better comparison, the scale of the left ('Hellenistic') chart is 33 %

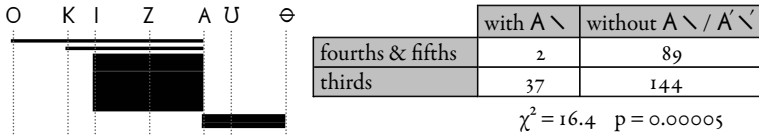

Diagram 84 Melodic context of A \ in extant melodies AD

falls towards the end of the gap in the evidence that separates Hellenistic from Roman Imperial music; the evidence is split accordingly.

In general, the pipes do not appear ill suited for either of the two periods in question. But there are some details which associate them rather with the Roman Imperial era. Firstly, the undivided tone between $\cup \uparrow$ and $\ominus \uparrow$ corresponds to the absence of the intervening note in any score later than the second century BC. Secondly, the finger holes for A \, present only on Pipes 1 and 3, are located surprisingly low. This can be explained by the fact that the extant documents embed the note in question into the harmonic structure not by fifths and fourth, but almost exclusively by thirds to \downarrow below and $\ominus \uparrow$ above, especially the former. The evidence is collected in Diagram 84.⁶⁴ On closer inspection, the avoidance of fourths and fifths in favour of thirds is highly significant, if compared with the overall melodic intervals of the fragments in question. Pure thirds at this point of the scale would demand a lower tuning of A \; this is what the Pompeii instruments exhibit.

Here we encounter another instance of an instrumental scale that conflicted with the premises of tetrachordal theory. According to the latter, A \ in the extant scores is always a tetrachord-bounding note, not qualified for the pitch modifications of fine tuning. Roman-period music, however, in accordance with its almost exclusively diatonic nature, partially abandoned the older fourths-oriented paradigm, embracing divisions of fifths into thirds even where this was at variance with old theory's scalar analysis. Above, we could only speculate about the existence of such 'violations'; now it appears substantiated by hard archaeological evidence.

The peculiarities of the mechanism make it easy to assign each of the pipes to either the left or the right hand of the player.⁶⁵ Thus, one arrives at

larger than that of the right ('Roman Imperial'), thus balancing the different amount of available material for the two periods.

⁶⁴ Cf. also Diagram 67 on p. 247 and Diagram 68 on p. 248 above.

⁶⁵ If a finger hole is open, the small knob by which its metal collar is operated points outwards towards the palm of the player: leftwards on left, rightwards on right pipes. The hole is closed by pushing the knob upwards, opened by drawing it down again, by the fingertips.

four possible pairings, each of which combines one of the longer with one of the shorter pipes, and each of which gives access to a specific set of notes. Thus it emerges that not all of the various *tónoi* are equally well supported. Diagram 85 provides a comfortable overview, indicating the available gamut for each of the twelve keys in the octave: the ranges where continuous scales are provided in all four possible combinations are printed white; those not available in any, dark grey, those that are provided for in only one or two combinations, in intermediate shades of grey. Bars to the left indicate the relative frequency of the *tónoi* in the musical documents. It appears that the instruments are best suited for a continuous sequence of keys from Iastian to Lydian including *synēmménōn* modulation. This covers the bulk of the extant scores, and is also in best compliance with the list of auletic *tónoi* found in Bellermann's Anonymus, which adds one key in each direction to the specified five optimal keys.⁶⁶

In a few cases, one metal band applies to two finger holes in a way so that only one can be open at a time. These cases are also governed by practical needs. On Pipes 2 and 3, Ζ□ is thus jointed with the note a semitone below. The two appear together in no diatonic scale except in Aeolian and Hypoaeolian, which are never attested. Perhaps we observe here the physical basis for the absence of these keys from both the extant melodies and the auletic keys according to the Anonymus: if the mechanical mutual exclusion of the two notes had become a traditional feature of aulos design, playing in either Aeolian or Hypoaeolian would have been extraordinarily troublesome. That such a design was probably traditional surfaces from a closer inspection of how the two pitches in question were actually used. In principle, they form part of one scale not only in the mentioned diatonic keys, but also in the chromatic tetrachord Ι–Θ–Η–Ω, which appears in the Lydian *synēmménōn* as well as in Hypophrygian and Phrygian: keys that were frequently employed in the Hellenistic period, when the chromatic was also in vogue. Thus we would be compelled to expect instances of this tetrachord in the earlier fragments. But it does not show up anywhere. If the two pitches in question are found within one piece at all, they are separated by modulation, indicated by the employment of the note Ζ□ instead of Η>.⁶⁷ The complete absence of chromaticism at this particular position

⁶⁶ Cf. above, pp. 53ff.

⁶⁷ Modulation is found in *DAGM* № 10 and № 21 (Limenios' Paean). The lower note alone appears in № 6; № 8; № 20 (the First Delphic Paean, where the Phrygian significantly abstains from chromaticism, except in the *synēmménōn* tetrachord). In the Roman period, V makes its appearance only once, in № 61, which was composed for a different type of instrument (for a transposing *proslambanónēnos* aulos in accord with the theory evolved above, or, if one is not convinced by it, at any rate for an

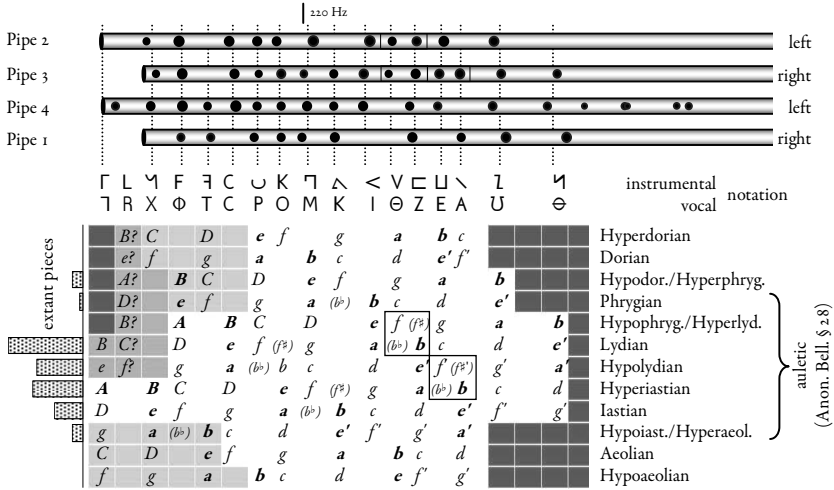

Diagram 85 Keys playable on the Pompeii pipes

must be significant, and finds its natural explanation in the mechanical design that the two Pompeii pipes exemplify. Where modulation between Lydian on the one hand and Lydian *synëmmënon* or Phrygian on the other occurred, it corresponded to turning the metal sleeve during performance: only rarely are we allowed such a sharp vision of the material foundations that determined the compositional process of a past musical culture as here.

Another sleeve on Pipe 3 switches between E ⊢ and A \. Again, these two pitches appear together in a continuous diatonic scale solely in keys that are never attested as such, namely Dorian and Hypodorian.⁶⁸ As bounding notes of a higher chromatic semitone, they would belong to Lydian and Hypolydian, the higher being written as Δ ⊢. This chromatic tetrachord forms part of Ptolemy's citharodic *trōpoi*, which may be reflected in *DAGM* N^o 19 – certainly not auletic – and perhaps N^o 48. Significantly, it does not appear in Limenios' aulos-accompanied paean, which only takes up a chromatic *pyknón* in the lower part of the Lydian scale.⁶⁹ The few other occurrences of both pitches within one composition are of

aulos that went at least a semitone lower than the Pompeii instruments). Perhaps the lack of an upper chromatic tetrachord in the Phrygian contributed to the feeling, expressed by Aristoxenus, that the diatonic was especially suited for this *tónos* (*ap. Clem., Strom.* 6.11.88.1; see n. 98 on p. 408 below).

⁶⁸ Athenaeus' Paean (*DAGM* N^o 20) once introduces Dorian B, a pitch avoided otherwise, besides regular Γ; for the interpretation of this single instance, cf. Hagel 2000: 48–50.

⁶⁹ Cf. above, pp. 280; 284; 307.

unclear nature; nowhere, as far as we see, do they belong to a regularly employed scale.⁷⁰

Another point of interest is the correspondence between the ranges of melodies and instruments. The two longer Pompeii pipes sound $\Gamma\Gamma$ as their lowest pitch: a note that we have frequently encountered as the lowest note of melodies. It makes its appearance, as an instrumental note, as early as in the Vienna fragments (*DAGM* N^o 11–12). Then it forms the detached bass note of Limenios' Delphic Paean (N^o 21), whose relations to auletic technique we have considered above. Quite possibly, then, the Pompeii instruments inherit their size (but not necessarily their scales) from much earlier models.

In the Roman period, we encounter at least thirteen pieces that go down precisely to $\Gamma\Gamma$. For some of them – those which do not exceed $Z\Box$ as their highest note – we have envisaged the hypothesis of a tall lyre, with a bass note a fourth below the old *hypátē* CC . We have also noticed a correlation of this lower register with the Iastian key. Of course, only the instrumental pieces are decisive as regards instrumental range; in vocal music, we can probably expect a general tendency towards the instrumental gamut, but no one-to-one correlation.

These precautions affect especially two famous short tunes: the Seikilos Song (N^o 23) and the proem-like Invocation to Calliope and Apollo (N^o 25). The latter looks entirely citharodic, and only transitorily does it drop below Φ . The Seikilos song, on the other hand, is Iastian and ranges precisely from Γ to Z , thus suggesting rather an aulos, although the confinement of the two lowest notes to the very end of the piece leaves room for doubt.

Most instructive are the instrumental scores from the Berlin Papyrus (*DAGM* N^o 51–52), which we could already identify as aulos music on other grounds with reasonable certainty. N^o 51 instantiates the Perfect System of the Hyperastian *tónos* from *proslambanómenos* up to *paranētē*, a structure reminiscent of the *proslambanómenos* aulos. None of the Pompeii pipes is of such a make, if considered in isolation. As a set, however, they exhibit unmistakable relations to the tonality of the fragment (cf. Diagram 86). Two of them, Pipes 2 and 4, provide the lowest note from their entire tubes, while the highest note can be played on the topmost holes of the other two, Pipes 1 and 3. A combination of Pipes 2 and 3 seems especially useful for this particular piece of music; together these could be described

⁷⁰ *DAGM* N^o 6 has Γ and twice Δ , probably denoting the pitches in question, once in immediate succession; *DAGM* N^o 22 might contain both A and E, but the tonality of this only provisionally published inscription is not established. In *DAGM* N^o 3 (the *Orestes* papyrus), $Z\Delta$ most probably denote not a chromatic but an enharmonic *pyknón*.

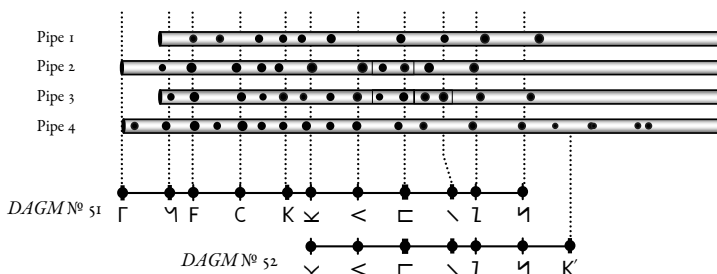

Diagram 86 The Pompeii auloi and the Berlin Papyrus

as a kind of Hyperian *proslambanómenos* aulos, chromaticised by a number of modulating semitones. This extensive modulating character precludes a ‘transposing’ notation, of course. Still, the structural resemblance between the simpler wooden instruments and these delicate and expensive pipes is probably not fortuitous.

The additional top note of No 52, the other instrumental fragment from the same papyrus, is apparently provided by the first extra hole of Pipe 4. Such a hole doubtless facilitated the performance of melodies in this region: presumably O’ K’ had become a typical top note. Nevertheless the same note – which is the Hyperian *néte diezeugménōn* – would also have been available on Pipe 2, in the fashion of the *proslambanómenos* aulos: by overblowing the entire tube.⁷¹ Consequently one could probably perform the Berlin aulos pieces on a combination of any one of the two longer Pompeii pipes with any one of the two shorter.

Pipes 1 and 4 include a finger hole a semitone below CC. It corresponds to the note T ♩, which modulates into Hypoian. This is essential for our investigation, since Bellerma’s Anonymus ascribes Hypoian exclusively to aulos music. In the fragments, this comparatively exotic key occurs in modulations within the Iastian triad (No 39),⁷² and once seemingly on its own (No 58). In both cases, the scales do not descend below ♩, while the highest notes are Z and A, respectively. Conceivably, therefore, these two pieces were also intended for performance to the aulos. In No 39, the specific modulating nature of the music may be taken as an additional argument in this direction, and the gamut of No 58 exceeds that of the hypothetical large lyre anyway. The melody of both could be played on the Pompeii instruments, in all possible combinations except that of Pipes 2 and 3.

⁷¹ Cf. above, p. 311.

⁷² No 18, the single line from the Berlin Papyrus, may also belong here.

Now N^o 58 seems “lyric, perhaps mythological in content”,⁷³ while N^o 39 stems from a dramatic anthology, as do so many others of the papyrus fragments. If the two might be aulodic rather than citharodic, the same possibility must be envisaged for other, similar, pieces.

The first candidate is the Yale papyrus (N^o 41), because it also makes use of the note T. Here, too, this note constitutes a modulation, although not into the Hypoastian *tónos*, but from diatonic to chromatic Iastian. T is the regular bottom note, below which the voice dives only occasionally, in leaps that are reminiscent of Hellenistic slider-aulos style.⁷⁴ The lyric impression may provide a further link to N^o 58.



All other pieces in question seem to come from anthologies of dramatic content. N^o 47 and N^o 54, Hyperastian and Iastian respectively, contain notes from T to U, once more clearly going beyond the hypothetical octave of a large lyre. The same range is probably found in the first piece of N^o 53. The other three pieces on this papyrus would fit into the picture, except that the editions print three instances of a bass note 7, a tone below T, which in turn does not appear. But these 7 are very doubtful.⁷⁵ For Pap. Louvre E10534, a range from T to A seemed most plausible.

N^o 47 presents T both as a melodic note, and as the target of downward plunges:

On the basis of an aulodic interpretation, this can be explained as the combination of the capabilities of instruments such as the Pompeii pipes with reminiscences of earlier melodic styles. Alternatively, even the leaps

⁷³ *DAGM*: 189; cf. West 1998: 99–101.

⁷⁴ *DAGM* N^o 41.4 T_W (a fourth); perhaps T₃ (a minor ninth, dropping a major sixth below T).

⁷⁵ Haslam 1976: 59; *DAGM*: 178, with reference to the one instance of “T” and the three of “7”: “If the low notes are correctly read (fr. 1. 4; 2. 7; 4. 3) ...”. Compare the papyrus: 1.4 ; 2.7 ; 4.3 .



might be rooted in contemporary instrumental practice, for instance by transferring the melody from one pipe to the other by mediation of the lowest note.

In the first piece of N^o 53, the Γ , if correctly read, also appears within a typical plunge, and what can be read of N^o 54 seems to adopt the same approach as N^o 47:

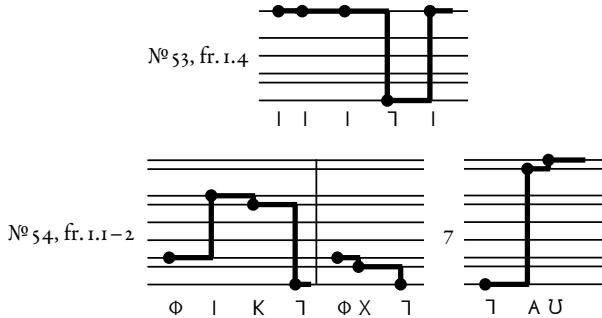

Especially interesting is N^o 45, where it seems that compositions of relatively high and low pitch appear side by side, while the identifiable keys are Lydian and Hypolydian. In any case, one Lydian piece unites notes from Γ up to E (or only Z?), while elsewhere even a *nētē* Θ is read. If the document is interpreted as citharodic repertory, a change of instrument between the single pieces seems probable, if the unity of vocal and instrumental range shall be maintained. On the other hand, if the accompanying instrument was an aulos similar to the Pompeii pipes, it could play in the range of the vocal melody throughout.⁷⁶ The overall required compass is actually identical with that of the first auletic composition on the Berlin Papyrus (N^o 51).

A combination of Lydian and Hypolydian is also found in N^o 40, which succeeds N^o 39 on the same papyrus. In spite of its range from Γ to Z, the keys made an ascription to a tall lyre problematic.⁷⁷ Now that N^o 39 has emerged as possibly aulos-accompanied, the same possibility must be acknowledged for this piece, as well. The fact that Γ appears only as a detached note might be taken as additional evidence in this direction:

⁷⁶ Note that the Lydian R L does not appear on the Pompeii Pipes 1 and 3; the lowest hole of Pipe 4, however, although positioned not much more than a quartertone above the note below according to Howard's measurements (it seems that the corresponding section of the instrument is now missing), can hardly have served another function. The pitch Howard gives as measured for this hole on an experimental replica (Howard 1893: 52: "x e^b" between "d" and "e") is a semitone higher than it is to be expected from his figures for the hole position, and thus obviously an error. Very probably the lowest section of Pipe 2 (apparently also lost now) contained a R L finger hole, too (cf. Hagel 2008a, 55; 57).

⁷⁷ Cf. above, p. 299.

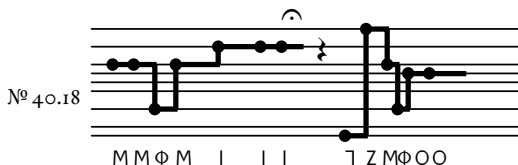
Aulos types and pitches

On balance, it appears very probable that some if not all of the pieces in question were indeed written for aulos accompaniment. The explanatory potential of this assumption would suffice to discard the hypothesis of a tall lyre entirely. After all, the archaeological credentials of the latter are not overwhelming for the time in question, whereas we have independent evidence for the crucial $\Gamma\Gamma$ as an important factor in aulos design.

The unusually low average register of Iastian pieces which we have observed is thus due to a special association of the Iastian key with some aulos types of the Roman era. Indeed the Pompeii pipes appear even better suited for Iastian and Hyperastian than for Lydian and Hypolydian.

The modality of the presumed aulos-accompanied compositions does not conflict with this interpretation. In the case of the instrumental N° 51 we have observed that the preference for a $G-D$ mode was not confined to lyre music. Even where it appears embedded in the framework of $\Gamma-C-(O-Z)$ (N° 39; N° 41), analogous to the lyre *harmonía*, the aulos offers an alternative explanation: the lower fourth $\Gamma-C$ is the old interval between lowest melodic note and (highest) bass note, and for the prominence of O and Z one can point to the fact that holes for these two notes are provided on all four Pompeii pipes.

Nevertheless, although there are substantial reasons for attributing some of the discussed fragments to the aulos, we must bear in mind that there is scarcely conclusive proof for any of the vocal compositions. On the other hand, once we have acknowledged aulos music among the musical documents of the Roman Imperial period, we must keep our minds open to the possibility that other fragments belong to this class, as well, apart from those we have selected mainly on grounds of their lowest note. A discussion of all options would be fruitless. Suffice it to point to the Schøyen Papyrus as one example (N° 60): instantiating the high range of the Iastian key, it is perhaps related to the doubtless auletic N° 52, and therefore another illustration of how the Pompeii pipes could be put to use.

In any case, it has become clear that $\Gamma\Gamma$ must be counted among the pivotal notes at least from Hellenistic times on. This is underlined by the system of theatre resonators reported by Vitruvius.⁷⁸ There we find the corre-

⁷⁸ Cf. above, pp. 249 ff.

spending jar most directly facing the solo singer, posited in the centre of the first row, which also contained a pair tuned an octave higher. In the small variant, fuller provision was only made for *mésē*, with a couple of resonators for the proper and another for the higher octave. In large theatres, both notes received equal attention, with a total of seven resonators, if we include those at the higher and (in the case of *mésē*) lower octaves.

TRANSFORMATION INTO THE ROMAN IMPERIAL SYSTEM

The modulating aulos was created in the environment of the old *tónoi*, Dorian, Phrygian and Lydian. In the documents of Roman-era music, however, only the Lydian has survived, while Dorian and Phrygian are virtually extinguished; the analysis of the Pompeii pipes confirmed this picture. How can we account for such a fundamental transformation, especially when musical documents for the time in question are lacking, particularly for the two centuries around the turn of the era? As regards the aulos, we must base our conclusions on general organological considerations. Even so, it seems possible to deduce some probable causes behind this development, if we start from the modulating aulos as it was invented in the fourth century BC, whose basic design and upper limit we know with reasonable confidence. Above all, it was a chromatic instrument, on which the archaic four finger holes per tetrachord, which were more evenly spaced, had been replaced by up to six holes, tuned to a series of semitones and sometimes tones. In short, the difference between the physical spans for the larger and those for the smaller intervals had become more prominent. As a consequence, a scale with a semitone below a tone at its lower end was now considerably more difficult to play than one with a semitone or a tone above a tone. With five heptatonic steps below the highest hole for $\Gamma N/E \sqcup$, it was obviously much more comfortable to have OK as the second lowest note than to reach down to $\text{P} \cup / \Pi \text{D}$. Diagram 87 displays the approximate finger spans and positions for all the keys from Dorian to Iastian. The 14 cm required for fingering the high fifth in the older set of keys are not impossible, but extremely hard to manage. The Hypolydian tritone, in contrast, is most comfortable; personally, I prefer it at least when improvising.

Secondly, there is the case of the thumb hole. When modulating from Lydian in the direction of the older keys, its pitch must be lowered by a

Aulos types and pitches

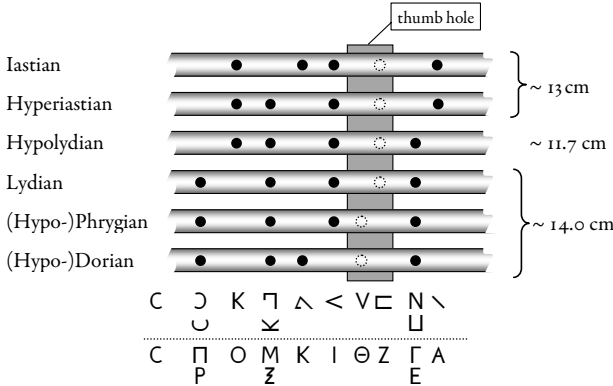

Diagram 87 Main playing position on the Hellenistic *tónoi* aulos

semitone. On the Pompeii Pipes 2 and 3 we encounter a sleeve with alternative holes at this position; but these instruments extend into a higher region, so that the pitches in question are played with other fingers. No such mechanism has hitherto come to light that would reduplicate the thumb hole. Anyway, the role of the thumb in supporting the instrument precludes that it turns an associated sleeve by itself (when moving to a position lower down the tube, the thumb hole mechanism is most conveniently operated by the index). All this, and also the high position of the thumb hole with the ensuing small hole distances, where individual sleeves for neighbouring semitones required perfected metalwork, makes it highly likely that the original auloi of this type had only one thumb hole that played both Z□ and ΘV, the latter by half-stopping. The hole would have to be comparatively large, both in order to ensure a better sound when it was half-occluded, and to enable its placement as far as possible towards the centre between the neighbouring holes, so as to increase the distance to the index hole. As a consequence, the production of ΘV was significantly more cumbersome, its pitch less stable than that of Z□. In fact, as we have seen, ΘV virtually died out after the Hellenistic period, taking with it the associated Phrygian and Dorian *tónoi*.

Finally, we have recognised the importance of the note ΓΓ (a fourth below CC) in aulos music from at least the Hellenistic period on. Once this note was firmly established in instrument design, it is no wonder that scales that included OK, a fifth above ΓΓ, were preferred to those that did not. This would also exert a significant drag in the direction of the chromatic keys. The system of theatre resonators described by Vitruvius with its em-

phasis on Γ and $Z\sqsubset$ an octave above would also support such an evolution (if it does not postdate it in fact).

All this makes Hypolydian a candidate for the chief *tónos* of post-classical aulos music.⁷⁹ Soon it must have become obvious that one could obtain additional scales with similar advantages by boring an alternative hole for the index finger, a semitone higher (cf. Diagram 87). The ensuing span of about 13 cm is not really problematic for a trained hand, especially not in the Iastian, where the ring finger can remain close to the middle finger. We have already suspected a special connection of the aulos with the Iastian key on other grounds. In order to avoid an excessive strain, the new $A \setminus$ hole might have been bored as close to the old one as possible, probably by means of a common sleeve as we still find it in this position on one of the Pompeii pipes. We have observed just such a flattened $A \setminus$ on the Pompeii instruments, and the extant melodies provided evidence for the traditional character of this specific divergence from the expected pitch. The present considerations finally contribute a material reason for this phenomenon.

In any case, such a hypothetical instrument, although differing from the original *tónoi* aulos only by a minor modification, is optimally suited for the 'modern' keys from Lydian to Iastian, with a special preference for Iastian and Hypolydian, and can thus explain one of the two big tonal changes that took place within the transition from Hellenistic to Roman Imperial music by physical causes.

The other is the rise of the *G* mode. On the aulos, such a mode is most natural in Iastian (where it focuses on CC), in which the auletic Γ , one fourth below, features most prominently (cf. Diagram 58 on p. 227 above). A highly hypothetical case might also be made for the Lydian of Hellenistic times. If the preceding considerations concerning the thumb hole of the original *tónoi* aulos are correct, the combination of ΘV and $Z\sqsubset$ within one hole makes it not unlikely that the latter, to be produced from the open hole, was bored a little too flat. This would impede the production of a pure fifth between $Z\sqsubset$ with CC , thus weakening the *E* component in the old *A–E* mode. In turn, a pure third to $M\sqsupset$ might have been readily at hand (with the implication of a pure sixth down to ΦF , and a pure tenth to low $\setminus E$, if available, which in my experiments gives a surprisingly agreeable sound), thus enforcing the alternative *G* mode. We have speculated about a similarly adjusted lyre *parypátē* above. It must however be emphasised that the present considerations concerning the aulos are not easily accommodated chronologically, since the evidence for the *G* mode postdates that for

⁷⁹ Cf. *DAGM* № 11 (Hypolydian melody with instrumental Γ) and № 15 (auletic Hypolydian).

the particular thumbhole by about two centuries. On the other hand, these are the 'dark centuries' around the turn of the era, for which we have almost no material anyway.

THE HÝDRAULIS

A word about the ancient organ is also in order, facing the widespread belief that we knew the scale of the third-century AD specimen whose metal parts were found at Aquincum in 1931. Unfortunately this is not the case, since most of its pipes were fragmented and their placement in situ was apparently not taken into accord, perhaps not even recorded. The most often accepted interpretation merely begs the question, as far as the scales are concerned; as regards the instruments' range, it may or may not have some validity.⁸⁰ If it has, the presumed ranges are in best accord with the rest of the evidence (cf. Diagram 88).⁸¹

The central octave from CC to $\ominus \mathfrak{M}$ would be available in all four registers, whose lowest pitches appear assigned to *hypátē* CC, *hyperypátē* ΦF , the important auletic bass note Γ , and \mathfrak{M} , the lowest note of some frequency in the scores, in turn. But at present all this must be regarded as highly doubtful.

⁸⁰ Walcker-Mayer 1970, arguing mainly from Roman units of measurement. Although this is in principle a laudable approach, it is of little worth if applied to pipes that are to play a given pitch, as was certainly the case with the *hydraulis*. Walcker-Mayer also overlooks the fact that, if the four intact pipes of the highest register (the only ones to which he pays regard) are forced into such a scheme (I could not verify his measurements from the tables in Kaba 1976; 2001), the other registers cannot possibly be fitted there as well. Moreover, he pays no attention to the presumed absolute pitch of the ancient *tónoi*, effectively putting them more than a tone too low (once one allows for octave transposition): his 'Lydian *mésē*' corresponds to modern *g*[#] instead of *b*^b-*b*. Interestingly, the tables of pitches (57; 78) apparently fails to reflect the octave jump that is to be expected between the open and the stopped pipes. — Szigeti 1971, among other misconceptions of ancient music, mistakes octave species for *tónoi*.

⁸¹ Justus Willberg, who built a beautifully sounding organ in accordance with the Aquincum remains, confirmed in personal communication that the lower limit for open pipes of the given diameter and design is about modern *f*, and for the stopped pipes about *B*^b.

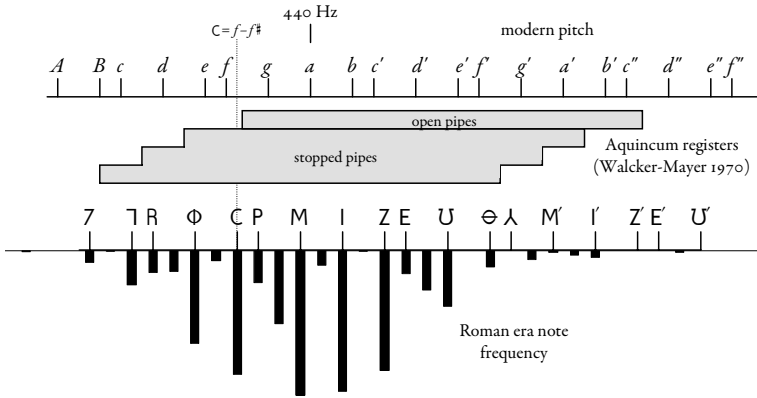

Diagram 88 The supposed range of the Aquincum organ

CHAPTER 10

Before Aristoxenus

EARLY NOTATION

At the beginning of our investigation we have surveyed the evolution of *tónoi* from a perspective as abstract as possible, starting from the notation system. Now that we have understood much about the material background of ancient music it is time to reconsider our first conclusions, qualifying and perhaps correcting them where appropriate.

The signs

Firstly, our examination of the notation was almost exclusively concerned with enharmonic scales, in accordance with what Aristoxenus reports about his predecessors. In instrumental practice, however, the diatonic was older than the enharmonic. In aulos music, at any rate, the enharmonic could not possibly replace the diatonic entirely.¹ The uneven arrangement of enharmonic notes with its ditone gaps does not correspond to a useful series of finger holes. If a tetrachord is played on four holes, these will include the *diátonos*, while the *pyknón* can be divided only by means of half-stopping holes (or, perhaps, adjusting the embouchure).² If it was played on three holes, as is conceivable in the higher range, the disposition of the hand suggests omitting rather the lower hole, while the diatonic hole stays in place.

¹ For the following, cf. Diagram 38 on p. 157.

² According to my experience, substantial pitch variations by embouchure are possible only on very high finger holes, rather above the usual range (contrary, but probably without appropriate experiment, Sachs 1924: 296).

In consequence, whenever the notation served for aulos music, the diatonic notes must have formed part of it. In the simple 'Lydian' core scale, this concerns two notes. The upper is supplied by L, the alternative *nētē* of the *synēmménon* tetrachord, and, according to the ancient view, one of the two possible *nētai* of traditional lyre tuning. The lower diatonic note is that which instrumental practice simply called '*diátonos*' (in full Perfect System nomenclature, *diátonos mesón*). The corresponding note sign is \sqcap . The structural conundrum posed by the associated sign triplet $\sqcap \triangleleft \triangle$ indicates that the original forms were different from those transmitted, and that they included at least one sharp angle.³ Presumably whatever shape stands behind \sqcap was not intended as the basis of a triplet in the first place. The assumption that it already designed the *diátonos* of the core set of notes neatly disposes of the problem. Since the *nētai* were obviously designated by the initial letter of the note name, one might consider some form of delta as the original *diátonos* note, altered only later when it became the base of a modulating triplet.⁴

By the way, the indispensability of a diatonic note at this position also provides a sufficient reason why the pitch in question was not written as \mathfrak{K} ;⁵ thus it becomes possible that the note K was introduced relatively early for other purposes.

As regards the low notes, we have found that the earliest examples of aulos music that we can identify employ a melodic scale down to CC or, in the typical modulating style, $\Upsilon \sqcup$, but in some cases make use of one or more detached bass notes. Of these, $\sqcap \Gamma$ is clearly most prominent, but $\zeta \vdash$ and $\mathbb{W} \mathbb{H}$ seem to appear, too. The probably lowest classical lyre string, on the other hand, corresponds to *hyperypátē* $\Phi \mathbb{F}$. This accords well with the sign forms. The extremely simple Γ may be an old sign, stemming from a time when some typical type of aulos played this bass note, a fourth below *hypátē* C. The similar shape \vdash for the pitch an octave below *mésē* \triangleleft might have belonged to an alternative pipe design. Conceivably, \mathbb{F} is a slightly later citharodic addition, whereas the intervening \mathfrak{M} , whose form is so unlike the early notes, was not introduced before the invention of the modulating system.

The organological perspective as well as the musical documents have also corroborated the conclusion that, whereas the scales transmitted by Aristides Quintilianus are indeed old, their notation is not. The *pyknón* above

³ Cf. above, p. 22 with n. 61.

⁴ Cf. West 1992a: 38: "It is also imaginable that the primary symbol was an alpha (\mathfrak{A} or \mathfrak{A}), or a delta modified in the interest of orientational differentiation (\triangle)." In Alypius' tables, the forms \triangleleft and \triangle are perceived as 'half-deltas'.

⁵ Cf. above, p. 27 with n. 78.

ΠΓ, which the tables employ so frequently, was not part of the early tonal standard, at least not to the degree the notated scales imply. Whoever translated the descriptive account of their intervals into notational signs followed the common practice of Roman-era handbooks, using the Lydian key for note examples where possible.

The chromatic genus in the Aristoxenian understanding was not part of the early notation. It is true, the (auletic) *pykná* written by the sign triplets were often of a size that Aristoxenian systematisation categorised as chromatic. But this was not the view of the designers of the system, who drew no such distinction. As transpires from its treatment by the ‘Pythagorean’ strand of theorists, the chromatic ‘proper’ was at home in citharodic music,⁶ where the distinctive *khrōmatiké* was tuned a 9:8 tone above *hypátē*. This string enjoyed an unbroken tradition from the fifth century down to Ptolemy and the *koiné hormasiá*. In accord with its taking part in the harmonic framework of fifths and fourths, the note we find connected with the *khrōmatiké* is not a modified shape, but a basic sign: K. As we have seen, the introduction of this note is responsible for the modern transcription of the Hypolydian instead of the Lydian as the natural scale. Considering that chromatic cithara music is almost certainly older than the seven-key stage of the notation, it seems perfectly possible that K was originally introduced for the citharodic *khrōmatiké*.⁷

The general approach

It is generally assumed that the triplet scheme roots in a kind of tablature. If so, it must have applied to the aulos, where pitch alteration from a single unit, namely the finger hole, is possible, and where the (enharmonic) *pyknón* is at home. A lyre tablature would look quite different – an example is

⁶ This is acknowledged by Aristoxenus, *ap. ps.-Plut., Mus.* 1137de: τῶ γὰρ χρωματικῶ γένοι καὶ τῶ <ποικίλῳ Lasserre> ῥυθμῶ τραγωδία μὲν οὐδέπω καὶ τήμερον κέρηται, κιθάρα δέ, πολλαῖς γενεαῖς πρεσβυτέρα τραγωδίας οὔσα, ἐξ ἀρχῆς ἐχρήσατο “tragedy makes no use of the chromatic genus and the (manifold) rhythm even today, while the *kiθάρα*, being many generations older than tragedy, employed it from the beginning”. Cf. also Philochorus, *ap. Ath.* 638a, on the citharist Lysander of Sicyon: χρώματά τε εὐχρῶα πρῶτος ἐκιθάρισε “he was the first to play well-coloured colours on the *kiθάρα*” (cf. Barker 1982b; *AGM*: 341–2).

⁷ The form of the sign is not easily accounted for. Probably it represents just another available shape that is open to the right and can be rotated and inverted without ambiguity. If a possible origin in Eastern Greek environment is admitted, it might have originated as X for χρωματική, later to be orientationally disambiguated to triplet standards.

provided by the Mesopotamian system of designations for strings and string pairs, put to notational use in the Hurrian hymns from Ras Šamra.⁸

As there were various kinds of aulos, differing in size and/or 'mode', the question arises how the original tablature was related to these. There are several possibilities:

(a) The notation might have been invented merely for one specific type of instrument. This is not a satisfactory solution, because we are told that professional players used several sets of pipes for different 'modes', and thus would have conceived of a notation that was applicable to all of these.

(b) All early Greek pipes that have come to light have five finger holes. The most practical kind of tablature, would therefore assign one note and its associated triplet to each hole, regardless of the musical function of that note on any particular pipe, so that a score would translate into a fingering without knowing about the intended melody. This would require a set of six basic signs, all but the highest of which would probably form triplets. But for all that we know, and have inferred, about the earliest stages of the notation, this seems not to have been the case. Why not? A straightforward tablature, in the sense of a real *Griffschrift*, is very useful for instruments where each fingering, or each string, or each string on each fret, yields a well-defined 'correct' sound, once the instrument is tuned properly. But nothing of that kind is the case on early auloi. Although there are indications that their finger holes were tuned cautiously,⁹ the proper pitches also depended a good deal on the performer's skill.¹⁰ This is no wonder, once the specific limitations are taken into consideration. Rivalling factors were a maximum compass versus an optimal range (often, we can be sure, corresponding to the male voice), as well as a musically proper arrangement of intervals versus a physically possible arrangement of finger holes, the latter becoming increasingly restricted with the required span. Thus, compromises had to be made, and to be compensated for in performance. As a consequence, the indication of a fingering by no means ensured the production of the proper pitches. The musicians needed to understand the scales they were to play: a level of awareness that the simple tablature approach does not convey.

⁸ Cf. Hagel 2005b. I do not hold that the hymns are necessarily lyre music – although I regard it as most probable, but the dichord harmonic system in which they are notated is ultimately abstracted from a stringed instrument, while applicable to other instruments belonging to the same tonal paradigm, i.e. (diatonic) heptatony.

⁹ Landels 1964: 395. Cf. Alex. Aphr., *Probl.* 2.63.25–30.

¹⁰ Plato, *Phlb.* 56a; Aristox., *Harm.* 2.41–3, p. 52.9–53.16. Cf. also the general pessimism about the reconstruction of the scales of (early) auloi expressed by Landels 1981.

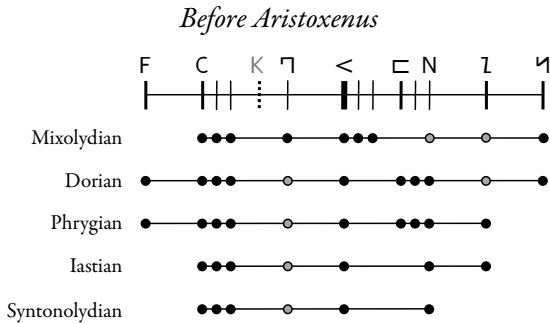

Diagram 89 The Aristides scales written with early note signs

(c) Thus we are left with the option that the notes were arranged to meaningful scales from the outset. If the system nevertheless accounted for several different types of (professional) auloi, its formation required rational analysis to a degree that deserves designation as music theory. Prerequisite was the establishment of some common scheme, onto which the individual scales could be projected. One possible option would have been the conception of a regular microtonal grid, as indeed advanced by some pre-Aristoxenian theorists.¹¹ The inventors of the notation, however, practice-oriented as they were, luckily took a more fruitful way. They implemented a functional, and thus properly musical, analysis of scales into tetrachords, thus preparing the way for the comprehension and advance of modulating structures.

How this functional stage of the notation could work can be illustrated for the scales transmitted by Aristides, which are not only the most archaic tonal systems for which we have reasonably reliable information, but refer to a date not far removed from the time in question. Their notation in Aristides' text, however, proved to be later. In Diagram 89, they are notated with the original 'Lydian' signs, including all three variants of *nētē* ΝΛ♩. Regular diatonic notes are added in grey, since the large ditone gaps of the enharmonic would hardly correspond to missing aulos finger holes.

This arrangement shows more clearly than any of the foregoing abstract reconstructions how well the early signs fulfilled the demands of the music before that 'revolution' that took place during the later fifth century. Firstly, the ninth from F to ♩, without the addition of K suffices for all known early scales. Thus the entire system does not exceed the gamut of its largest member, the Dorian;¹² nothing such as the two octaves of the later

¹¹ Cf. below, pp. 383ff.

¹² This is also the range of the later cithara. Were there non-modulating instruments with nine strings in the mid-fifth century?

Perfect System is needed. All this can be achieved by no more than six basic note signs: F C \sqcap $\langle \sqsubset \sqsupset \rangle$ N. Moreover, *pykná* are based on only half of them, and notably on those three whose forms are most obviously chosen for that purpose: C \sqcup $\langle \vee \rangle$ $\sqsubset \sqsupset$. Finally, the highest notes of each scale correspond to some form of N as the abbreviation for *nētē*.¹³ The awkward \sqcap (or whatever its original shape) is used only in its primary form, but never rotated. Aristides' enharmonic scales require it only in the Mixolydian; in all other instances it represents the *diátonos*.

In our initial reconstruction the arrangement of the forms N \sqcup $\langle \vee \rangle$ was problematical, since it made the assumption of a secondary reordering necessary. Similarly, the reduction of the early signs to the 'Dorian octave' – although with *synēmménon* modulation – suffered from a lack of practicality. The scheme of Diagram 89 overcomes these difficulties.¹⁴ It is therefore proposed as the reconstruction of the notation in its original, functional, state. Its conception required no more than an analysis of the intervallic relations of current modal *Gebrauchsskalen*, which in consequence would lead to a functional view on the tonal material, as it was ultimately expressed in the Perfect System.

HARMONIC THEORY

On the early, i.e. pre-Aristoxenian, efforts to comprehend the mutual relationships of scales we have only a handful of passing remarks.¹⁵ These, however, concern just the issues we expect. Firstly, one had set out to identify the position of the disjunctive tone in the different scales. This transpires

¹³ Note that N is distinguished from \sqsubset , a *pyknón* above \sqsubset . Perhaps this results merely from the functional viewpoint; more probably it should be related to the ill-defined size of the early aulos *pyknón*, which was bored definitely larger than a semitone.

¹⁴ If the inventor started from something like a standard 'Dorian' octave, such as C *hypátē* – Δ *diátonos* – \langle *mésē* – \sqsubset *paramésē* – N *nētē*, he would still have reordered the N triplet afterwards. But this would have occurred before the system was put to use, so that no ambiguity between 'older' and 'newer' scores could ever have arisen.

¹⁵ For the position of 'harmonikoi' in pre-Aristoxenian music theory, cf. Barker 2007: 33–104; also Barker 1978a; Barker 1982a. Although I find Barker's earlier suggestion intriguing that Aristoxenus' οἱ καλούμενοι ἁρμονικοί, "the so-called *harmonikoi*" (*Harm.* 2.40, p. 51.1), bears the scathing overtone of "merely so called" (cf. the supplement proposed for Pap. Hibeh 13.i.3–4; Avezzù 1994: 125–7), the passage hardly allows us to conclude that the author did not perceive the *harmonikoi* as one distinct movement, to which his criticism must apply as a whole (must we not otherwise expect some differentiating pronoun?).

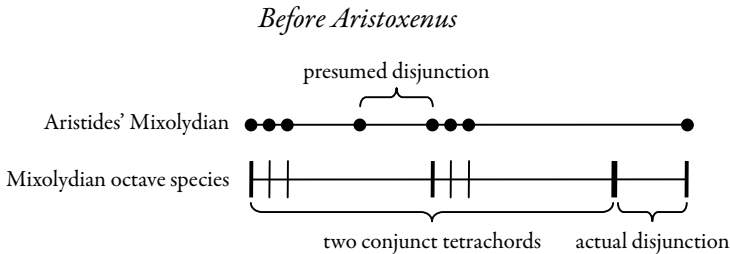

Diagram 90 The Mixolydian disjunction

from information that was seemingly excerpted from a lost work of Aristoxenus:¹⁶

ἐν δὲ † τοῖς ἱστορικοῖς τοῖς ἁρμονικοῖς † Πυθοκλείδην φασὶ τὸν αὐλητὴν εὐρετὴν αὐτῆς γεγονέναι, αὐθις¹⁷ δὲ Λαμπροκλέα τὸν Ἀθηναῖον, συνιδόντα ὅτι οὐκ ἐνταῦθα ἔχει τὴν διάζευξιν ὅπου σχεδὸν ἅπαντες ᾤοντο, ἀλλ' ἐπὶ τὸ ὄξύ, τοιοῦτον αὐτῆς ἀπεργάσασθαι τὸ σχῆμα οἷον τὸ ἀπὸ παραμέσης ἐπὶ ὑπάτην ὑπατῶν. (ps.-Plut., *Mus.* 1136de)

In † the *History of Harmonics* † they say that Pythocles the aulete was the inventor of [the Mixolydian], and again¹⁷ that Lamprocles of Athens realised that it has the disjunctive tone not there where almost everyone had been thinking, but at the top, and worked out its scheme as being such as from *paramésē* down to *hypátē hypatón*.

The latter statement is clear enough if related to Aristides' Mixolydian:¹⁸ thanks to the large gap at the top, the 'disjunctive tone' was originally identified as the tone below the upper *pyknón*. More careful analysis proved that the lower part of the irregular scale 'actually' consists of two conjunct tetrachords (with the insertion of a 'modulating' note), and that the 'disjunction' is situated at the top, albeit invisible, because the functional *mésē* is suppressed. The relationships become evident once the scale is regularised to an octave species (cf. Diagram 90).

¹⁶ The text is problematic, and it is not clear who quotes whom. Wyttchenbach restored a quotation from Aristoxenus' *Historical Commentaries* (cf. Diog. Laer. 9.40: ἐν τοῖς ἱστορικοῖς ὑπομνήμασι), which also requires changing φασὶ to φησὶ, and seems not especially suited for such musical technicalities. That ps.-Plutarch introduces another author besides Aristoxenus at this point (so Wehrli 1945: 74) appears less probable, but possibly the excerpt from Aristoxenus included a quotation (*GMW* 1: 221 translates "the *harmonikoi* in their historical works say", apparently reading ἐν δὲ τοῖς ἱστορικοῖς οἱ ἁρμονικοί). All this does not solve the problem of Pythocles' as opposed to Sappho's authorship, because Pythocles is too late to have 'invented' the Mixolydian anyway.

¹⁷ Thus Westphal's plausible emendation (αὐθις) for the manuscripts' "...and Lysis [says] that..." (Λύσις).

¹⁸ Mountford 1923: 127; Winnington-Ingram 1936: 28 n. 2; West 1981: 127; Barker 2007: 49–50.

Notably, this puts not only Aristides' Mixolydian before the last quarter of the fifth century, but also the theoretical efforts concerning the position of the disjunction:¹⁹ when Lamprocles contributed to the discussion, there was already an established view on the Mixolydian. The invention of the Mixolydian *harmonía* is here attributed to Pythocles, who apparently belongs in the earlier fifth century; but in the preceding sentence Aristoxenus is quoted with the view that the Mixolydian goes back to Sappho.²⁰ In the context of something like *History* and *Harmonics* the viewpoint was probably more technical. Perhaps Aristoxenus ascribed the invention of the mode with its typical character to Sappho, while Pythocles "the aulete" was credited with the special form of the scale (as we find it in Aristides), and thus maybe with the creation of an associated aulos. In any case, the disjunction must have been established as the major point of orientation within a scale at about the mid-fifth century.

One cannot talk about the disjunctive tone without having any idea about the items it separates. The notion of tetrachords, albeit vague, must therefore be at least as early. First echoes of it may be perceived in Aristoxenus' relation that Pythagoras of Zacynthus (fifth century?) set out for the enumeration of differences between scales.²¹ Archytas, Plato and, if the fragments are genuine, Philolaus, already presuppose the standard form of tetrachord. The recognition of the fourth as a structural unit also stands behind its ancient designation as *syllabá*, "what is taken together".²² A clear account of inter-tetrachordal relations is not attested before 'the school of Eratocles'. For this theorist a date before 422 has been proposed, although with caution, because the idea of scalar road junctions, which we find connected with his name, is exploited in lines ascribed to Ion of Chios.²³ Eratocles himself, Aristoxenus tells us, was responsible for the enumeration of the (enharmonic) octave species, which he achieved by cyclically transfer-

¹⁹ Pythocles is said to have taught Pericles as well as Agathocles, teacher of Lamprocles, teacher of Damon: Plato (?), *Alc. I* 118c with Schol.; Aristot. *ap. Plut., Pericl.* 4.1. Although such *diadochai* are likely constructed by later systematisation, there is no reason to doubt the general chronology. Cf. Wallace 2003: 73–81.

²⁰ Unnamed authorities are cited as attributing the Mixolydian to Terpander in ps.-Plut., *Mus.* 1140f.

²¹ Aristox., *Harm.* 2.36–7, p. 46.10–12. Cf. *AGM*: 226. Barker (2007: 52) speculates that this Pythagoras first described the 'Aristides scales'.

²² Cf. Aelian., *ap. Porph., in Harm.* 96.29–30. On the other hand, Porphyry's explanation "according to the *organikoi lyrikoi*" (*in Harm.* 97.2–8) seems contrived ad hoc (how likely is it that its inventors were familiar with seven-stringed lyres?). At any rate it cannot pertain to some "starting position" of the lyre player's fingers (Barker 2007: 264), since even with the fingers closed together the hand is much wider than four adjacent strings on any ancient lyre; in the most comfortable position with fingers slightly apart (as often shown in representations) it covers the entire row of seven strings.

²³ *AGM*: 227; cf. n. 96 on p. 87 above. This date would however apply not to Eratocles himself but his followers.

ring the intervals (i.e. from one end of the scale to the other).²⁴ This alone presupposes no tetrachords, but only regularised versions of the scales, such as the Mixolydian octave Lamprocles seemingly worked with. The insights laid down by Eratocles' followers are more important for our topic:

οἱ δὲ περὶ Ἐρατοκλέα τοσοῦτον εἰρήκασι μόνον ὅτι ἀπὸ τοῦ διὰ τεσσάρων ἐφ' ἑκάτερα δίχα σχίζεται τὸ μέλος, οὐδὲν οὔτ' εἰ ἀπὸ παντὸς τοῦτο γίνε-
ται διορίσαντες, οὔτε διὰ τίνα αἰτίαν εἰπόντες, οὔθ' ὑπὲρ τῶν ἄλλων δια-
στημάτων ἐπισκεψάμενοι τίνα πρὸς ἄλληλα συντίθενται τρόπον, καὶ πότε-
ρον παντὸς διαστήματος πρὸς πᾶν ὠρισμένος τις ἐστι λόγος τῆς συνθέσεως
καὶ πῶς μὲν ἐξ αὐτῶν πῶς δ' οὐ γίνεται συστήματα ἢ (εἰ) τοῦτο ἀόρι-
στόν ἐστιν.
(Aristox., *Harm.* 1.5, p. 9.16–10.2)

Those around Eratocles said only so much that from the fourth the melody divides into two in each direction, but they did not distinguish whether this happens from any [fourth], nor did they tell the reason why this is so, nor did they investigate the other intervals, in which way they are combined, and whether there is some well-defined rationale governing the combination of each interval with each, and how scales are formed out of them in certain ways but not in others, or whether this is indeterminate.

Clearly these theorists were talking about tetrachords, and the points they did not discuss are just as interesting as those they dealt with. Their main advance seems to be the insight that different scales are generated out of each other by taking a different path at either end of any tetrachord. Conjunction and disjunction of tetrachords are pinned down as governing the interrelation of scales. Thus the principle behind modulating *systemata* is at least partially understood, the same principle that underlies the more advanced stages of the notation as well as Aristoxenus' own paradigm. The image of the road-junction is amply exploited in Aristoxenus' discussion of well-formed scales, where he expounds on the points that he missed in the Eratocleans. He is right, of course: the two-ways rule does not apply to any 'species of the fourth', but only to the 'standard form' of the tetrachord, where it is bounded by the 'fixed notes' of the Perfect System. If this was not stated by the sources Aristoxenus criticises, this need however not mean that their authors were not aware of the principle: after all, they described structures of musical practice. More probably, they conceived of the 'tetrachord', or even the 'fourth', as the 'standard tetrachord' without fur-

²⁴ Aristox., *Harm.* 1.6, p. 11.3–10; p. 10.19–20; cf. also Cleonid. 9, p. 197.7 (ascribing the names of the species to οἱ ἀρχαῖοι; perhaps Aristid. Quint. 1.8, p. 15.8–15 also belongs here); cf. e.g. Barker 1982a: 186–7. Regarding the expression τῆ περιφορᾷ τῶν διαστημάτων, note the possible graphical representation on a circle, with different starting points yielding different octave species.

ther mention.²⁵ The same ‘standard tetrachords’ are indispensable ingredients of the notation, especially in its first modulating stages. The expression of *pykná* by triplets, above all, contributes to an almost inevitable conception of their lowest notes as the natural structural boundaries. Aristoxenus, in contrast, calls for nothing less than the derivation of any musical structure, simple or modulating, from a set of axioms – which is hardly a fair starting point for criticising his predecessors of the fifth and early fourth century. Eratocles’ school was apparently content to define the possible relationships between the tetrachords as recognised units. If their internal structure was accepted as given, none of the detailed demonstrations on which Aristoxenus insists are actually necessary.

Another passage from Aristoxenus, if carefully read, betrays the advanced state of the Eratocleans’ tonal system:

τούς μὲν οὖν ἔμπροσθεν (†...†) ἀρμονικούς εἶναι βούλεσθαι μόνον, αὐτῆς γὰρ τῆς ἀρμονίας ἤπτοντο μόνον, τῶν δ’ ἄλλων γενῶν οὐδεμίαν πώποτ’ ἔννοιαν εἶχον. σημεῖον δέ· τὰ γὰρ διαγράμματα αὐτοῖς τῶν ἐναρμονίων ἔκκεται μόνον συστημάτων, διατόνων δ’ ἢ χρωματικῶν οὐδεὶς πώποθ’ ἑώρακεν. καίτοι τὰ διαγράμματα γ’ αὐτῶν ἐδήλου τὴν πᾶσαν τῆς μελωδίας τάξιν, ἐν οἷς περὶ συστημάτων ὀκταχόρδων (ἐν)αρμονίων μόνον ἔλεγον.

(Aristox., *Harm.* 1.2, p. 6,6–19)

...that our predecessors wanted to be ‘harmonicists’ only; for they touched only on the enharmonic and wasted no thought on the other genera. This is indicated by the fact that all their diagrams consist of the enharmonic scales, while no one has ever seen diatonic or chromatic ones. And yet the arrangement of the entire tonal system was revealed right in their diagrams, in which they treated merely enharmonic eight-note scales.

The restriction to regular enharmonic octaves makes the identification of these unnamed ‘*harmonikoi*’ as belonging to Eratocles’ followers reasonably safe.²⁶ Musical diagrams, however, we are told, were first devised by the citharode Stratonicus. If this is true, the theorist Aristoxenus has in mind should not be earlier than the first half of the fourth century.²⁷ The stupen-

²⁵ Cf. Aristox., *Harm.* 1.22, p. 28.13–29.2: the tetrachord from *mésē* to *hypátē* enjoyed special prominence in musical discourse.

²⁶ In *Harm.* 2.36–7, p. 46.6–12, Aristoxenus contrasts those concerned with the enharmonic octaves with two other theorists. In that context, he need not differentiate between Eratocles and his followers. — When we follow Aristoxenus in talking of ‘Eratocleans’ this does not imply that those people would have defined themselves as such; the original wording need not imply much more than that Aristoxenus perceived their views as developing those of Eratocles.

²⁷ Phaenias (late fourth century BC) *ap.* Ath. 352cd, addresses Stratonicus as belonging to the ‘*harmonikoi*’. Of course, Stratonicus might have been among ‘Eratocles’ followers’, so that the diagrams referred to by Aristoxenus could be his. Cf. Wilson 2004: 290–2.

dous point in his criticism is that they failed to develop a systematic description of the melodic space although the whole thing was present right in their own diagrams.²⁸ Since Aristoxenus' reputation for bestowing undeserved praise upon his forerunners is small, we have to accept this statement in its full sense. Some pre-Aristoxenian charts, although presenting themselves as concerned solely with the enharmonic, '*harmonía*', included the notes necessary for the description of the chromatic and the diatonic. How is this possible? Whereas Eratocles merely enumerated the *harmoníai*, his followers developed the theoretical means of relating these to each other by tetrachordal conjunction and disjunction. Their diagrams necessarily reflected this progress. Thus these diagrams consisted of enharmonic scales, plausibly identical to those of Eratocles, but which were now related to each other by common tetrachords, so that the 'road junctions' at their boundaries became obvious. The details cannot be established with certainty. A comprehensive *diágramma*, as seems more than probable in the context of a school concerned with the enumeration of the seven species, would probably anticipate Ptolemy's system of *tónoi* in many respects.²⁹ Diagram 91 gives a possible reconstruction: the shapes of the octave species are virtually certain, but their relation not in all cases, and some of the corresponding names can only be guessed.³⁰ For comparison, the notes of the Aristides scales, the irregular predecessors of the species, are also indicated in the graphic.

Whatever the details of the Eratoclean diagrams, their structural basis of common tetrachords and road junctions gave rise to their inherent comprehensiveness, of which its creators, to Aristoxenus' disapproval, failed to take notice. Although every single scale is a *harmonía* not only because it comprises an octave, but also in the sense of being strictly enharmonic, the notes of the other genera are contributed by neighbouring scales: both the diatonic and the chromatic *likhanoí* are present as modulating fixed notes,

²⁸ Note that τὴν πᾶσαν τῆς μελωδίας τάξιν is echoed by τῆς ὅλης μελωδίας immediately below, where it is beyond doubt that for Aristoxenus 'the entirety of *melōidia*' includes all well-formed scales in all genera.

²⁹ We have induced a 'Pythagorean' regular eight-scale system from Ptolemy and Boethius. The designation as '*harmonikoi*', however, argues against the Eratocleans' belonging to this line of thought; similarly, their apparent preoccupation with the number seven suggests that the 'Pythagorean' system represents a somewhat later stage.

³⁰ In the two early *tónoi* systems mentioned by Aristoxenus, 'Hypodorian' is used for scales whose *mesē* is situated a tone or three quarters of a tone below the Dorian *mesē*, respectively, whereas at least from Aristoxenus on, the prefix 'Hypo-' regularly denotes the scale a fourth below. Without doubt Eratocles played a prominent role in the creation of the nomenclature that persisted throughout antiquity (*AGM*: 227); the last modification is probably due to Aristoxenus in accordance with his own system of *tónoi* (cf. below, p. 430).

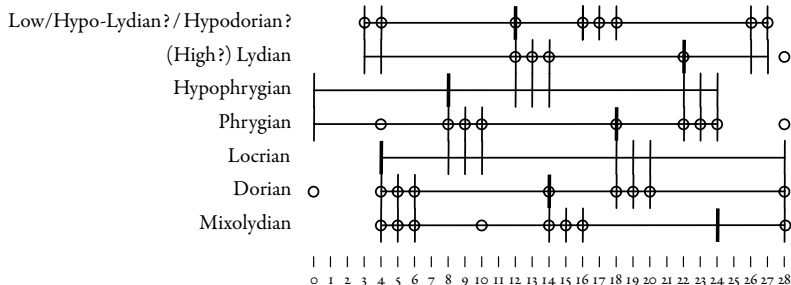

Diagram 91 *Exempli gratia* reconstruction of a full Eratoclean diagram
 Lines indicate the regular enharmonic octaves, circles the respective Aristides scales

in scales a fourth or a tone apart. How fundamental this was in musical practice, we have observed in several instances, especially when theorists were forced to define the pitches of the *khōromatikē* as well as of the diatonic *paranētē* by the framework of fourths and fifths. Aristoxenus' assertion that such diagrams revealed "the arrangement of the entire tonal system" is therefore warranted in every respect. With a knowing eye, one can read from them not only the possible relations of tetrachords, but also the possible combinations of intervals and the laws governing them (which leads to the full comprehension of *tōnoi* and modulation); not only the shapes of the octave, but also those of the fifth and the fourth; and finally the three genera in their standard form.

Several problems remain. The resort to the road junctions as governing the interrelation of scales testifies to a rather advanced mastery of the tonal space, clearly foreshadowing much of Aristoxenus' method. This would point to a date in the fourth century, in accordance with Stratoniceus as the alleged "inventor of the diagram". On the other hand, it cannot easily be accepted that all preceding attempts at relating the different scales to each other should have been accomplished without graphical illustration. Still, one might hypothesise that earlier theorists had used diagrams merely esoterically as a working (and educational) device, while Stratoniceus might have been the first to include charts in a published work.³¹

But what about Ion of Chios' "road junctions", which suggested a much earlier dating? Certainly we must beware of the pitfall of attributing the origin of such a notion to theory rather than practice. As soon as a lyre ac-

³¹ Cf. also Aristoxenus' assertion that the early *tōnoi* systems were put forth without explaining the reasons of their number or arrangement (Aristox.: *Harm.* 2.37, p. 46.18–20: περι ὧν οὐδεὶς οὐδὲν εἶρηκεν, οὔτε τίνα τρόπον ληπτέον οὔτε πρὸς τί βλέποντας τὸν ἀριθμὸν αὐτῶν ἀποδοτέον ἐστίν).

quired a modulating stringing at all, any communication concerning its melodic use inevitably leads to such a conception. When it is no longer possible to combine any sequence of notes without disrupting the presently established scale, it is necessary to define legitimate ‘paths’ along which the melody can unfold. At the same time the ‘crossroads’ are defined by the intersections of these paths, or, more technically, by notes which are common to more than one valid scale. Thus, the image of roads and road junctions may have been firmly established in the musicians’ minds for a considerable time, although only for a limited subset of harmonic relations, before it was adopted by harmonic theory and recognised as a general principle. Even so, it is tempting to associate a more systematic exploitation of the “road junctions” (*triadoi*, “Dreiwege”) with Ion, who based his cosmic system on fractures into three (*triagmoi*).³²

Finally, the Eratocleans’ diagram obviously presented a system of *tónoi*, and as such proposed a solution to a much-discussed issue, which was also of the highest importance for the development of the notation. We have shadowy accounts of several efforts to combine scales into larger structures. Perhaps the earliest is the ‘tripod’ constructed by Pythagoras of Zacynthus. This was a kind of triple cithara, incorporating three entire sets of strings, tuned to Dorian, Phrygian and Lydian. Quick rotation of the instrument enabled the player to proceed from one to another without the interruption otherwise involved in retuning.³³ That the three tunings had some important notes in common is almost beyond doubt.

The major landmark in the evolution of modulating systems is doubtless the incorporation of several scales on one instrument. The Ion fragment, in all probability dating from before 422, celebrates the eleven-stringed modulating lyre, seemingly as a novelty. The invention of the modulating aulos is ascribed to Pronomus, which gives a date rather before, and perhaps considerably before, 400 for the integration of at least Dorian, Phrygian and Lydian.³⁴ The modulating style attributed to several composers of the sec-

³² Harpocrat., s.v. ἴων; Diog. Laer. 8.8; Clem., *Strom.* 1.21.131.4.

³³ Ath. 637c–f. Although the rapidity of the shift is emphasised, the implication is not that Pythagoras played melodic modulations “with no audible interruption” (*AGM*: 226), as if on one many-stringed instrument, but that the mere listener would think to hear three citharas. One may think of a cithara complement of the *nómos trimelés* (ps.-Plut., *Mus.* 1134ab), where the aulete apparently changed his instruments between the parts.

³⁴ Paus. 9.12.5; Ath. 631e (for his unquestioned primacy in the art, cf. *Anth. Pal.* 16.28). According to Duris of Samos, *ap.* Ath. 184d, Pronomus was Alcibiades’ teacher (but Antigenidas according to Pamphila, *ap.* Gell., 15.17.1). Note that Plato, *Rep.* 399d, treats aulos music as the leading factor in the development of tonal variety. An aulos modulating between Dorian, Phrygian and Lydian is presupposed for the dithyrambs of Philoxenus, Timotheus and Telestes in Dionys. Hal., *Comp. verb.* 19.

ond half of the fifth century, and especially Phrynis, also calls for advanced instrumental capabilities not much later than 450.

Then there are the two peculiar schemes of *tónoi* (one coming in a basic and an extended form) briefly described by Aristoxenus.³⁵ For the moment I shall refer to them as the ‘first’ and the ‘second’ system in accordance with the order in which Aristoxenus gives them; but we must bear in mind that this implies nothing about their chronology. They comprise merely five or six keys. For this and other reasons none of them can be identical with the Eratocleans’ diagram; thus we have some details for at least three pre-Aristoxenian *tónoi* systems.³⁶ All of these might have influenced notation as well as instrument design at different places and times.

As regards the Eratoclean *harmoníai*, we are fairly certain about their form, but lack definite information about their mutual relations. In the case of the other two systems, the opposite is the case: Aristoxenus reports no more than the intervals between their *tónoi*. In form of the mere lists he gives, ordered according to relative pitch from low to high, they look utterly disconcerting:³⁷

‘First’ system

[Hypophrygian –?–] Hypodorian – $\frac{1}{2}$ – Mixolydian – $\frac{1}{2}$ –
Dorian – 1 – Phrygian – 1 – Lydian.

‘Second’ system

Hypophrygian – $\frac{3}{4}$ – Hypodorian – $\frac{3}{4}$ –
Dorian – 1 – Phrygian – $\frac{3}{4}$ – Lydian – $\frac{3}{4}$ – Mixolydian.

On a superficial account, the lack of agreement is alarming. Only the relation between Dorian and Phrygian seems really settled. Otherwise, only some details concerning the raw order appears fixed: Lydian stands immediately above Phrygian, and Hypophrygian and Hypodorian are found at the lower end of the series.

Fortunately, though, we have the key to the secret: the arrangements can be understood mainly with the help of the Aristides scales.³⁸ The intervallic

³⁵ Aristox., *Harm.* 2.37–8, p. 47.1–16.

³⁶ The apparent question why Aristoxenus omitted the Eratocleans in his account of conflicting *tónoi* systems is easily answered: this was the school whose principles he largely followed, and which therefore proved difficult to ridicule on this point. It was only the two others that he could blame for following erroneous principles and misrepresenting musical realities.

³⁷ Hypophrygian was added to the ‘first’ system as a later extension. — Compare the intervals between the later standard *tónoi*:

Hypodorian – 1 – Hypophrygian – 1 – Hypolydian – $\frac{1}{2}$ –
Dorian – 1 – Phrygian – 1 – Lydian – $\frac{1}{2}$ – Mixolydian.

³⁸ Hagel 2000: 168–81.

Before Aristoxenus

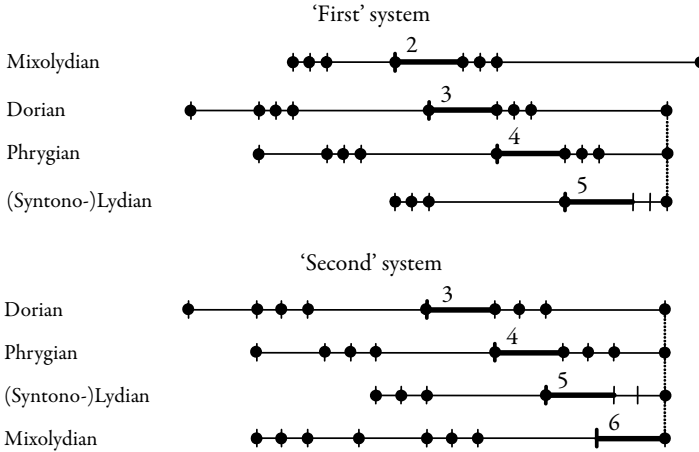
Diagram 92. The two old *tónoi* systems

distance between *tónoi* is of course defined by the distance between functionally similar notes in both; later writers refer either to the *mésē* or the *proslambanómenos*. The latter, which came into view only after all *tónoi* were envisaged as instances of the entire Perfect System, is out of the question here. But we have seen that the position of the disjunction in each scale was already determined in the fifth century. Its lower bounding note, the ‘functional *mésē*’, can therefore serve us as a safe and convenient guide.

Aristides does not transmit corresponding scales for all of the *tónoi* in question. Even so, the governing principle behind the two systems becomes immediately clear once the *mésai* (or the disjunctions) of the known scales are arranged in the reported intervals (Diagram 92). It is the principle that we have found operating in the evolution of the notation, as well, and that we have accredited to the demands of aulos design: the scales are brought into the same pitch range, and their highest notes especially are aligned.

Three points must be noted. Firstly, as always, the ‘Lydian’ *tónos* is represented by Aristides’ ‘high Lydian’ (‘Syntonolydian’), while Aristides’ ‘Lydian’ is nothing other than the Hypolydian octave species.³⁹ Secondly, the

³⁹ For a possible explanation for this ‘confusion’, see Hagel 2000: 174–7: the term ‘high Lydian’ was adopted for the old ‘Lydian’ to distinguish it from a new ‘slack Lydian’, purportedly introduced by Damon (ps.-Plut., *Mus.* 1136e), which later became ‘Hypolydian’. The fact that Plato maintained this specific nomenclature owes to the Damonian hue of the music theory reflected in the *Republic*. The Aristides scales, on the other hand, present themselves as those meant by Plato. That the ‘slack Lydian’ appears without qualification is due to the fact that Plato, in a manner typical for him, blurs the technical terminology (*Rep.* 398e: ἰαστί, ἦ δ’ ὅς, καὶ λυδιστί αὐ τινες χαλαραὶ καλοῦνται).

Mixolydian is treated differently by the two schools. The first adheres to the old view that identifies its disjunction at the top of the lower tetrachord. Consequently, the Mixolydian is listed in a relatively low position. The second school adopts Lamprocles' analysis, which recognises the Mixolydian disjunction at the top of the scale. This puts it at a high position in the list. The relative pitch of the scale, however, is barely affected. In effect, the Mixolydian of the second school sits a semitone lower, so that all known scales are perfectly aligned. However, this different analysis of the Mixolydian can barely establish even a relative dating. That the first system was worked out before Lamprocles is utterly unlikely; we have to reckon with the preservation of the older view in some tradition. Anyway the system is clearly archaic in comparison with the Eratoclean paradigm: a low Mixolydian disjunction could not be upheld once the notion of the octave species had been integrated.

Finally, the size of the *pykná* is different in the two systems. The first employs the usual quartertones, as known from the persistent standard definition of the enharmonic genus. The second makes sense only with *pykná* of three quartertones. Indeed, Aristoxenus inferred from the three-quarter-tone intervals between its scales that it was designed "with view to aulos boring" (from his inference, the auletic pattern of a fourth divided into $\frac{3}{4}$ – $\frac{3}{4}$ –1 tones was in turn derived). At first glance it may be perplexing that two systems that are both based on the enharmonic do not agree at all about the size of its intervals. But our analysis is substantiated in this respect by Aristoxenus' explicit testimony:

Τριῶν δ' ὄντων γενῶν εἰς ἃ διαίρεται τὸ ἡμοσμένον, ἴσων τοῖς τε τῶν συστημάτων μεγέθεσι καὶ ταῖς τῶν φθόγγων δυνάμεσιν, ὁμοίως δὲ καὶ ταῖς τῶν τετραχόρδων, περὶ ἑνὸς μόνου οἱ παλαιοὶ ἐπραγματεύσαντο, ἐπειδὴ περ οὔτε περὶ χρώματος οὔτε περὶ διατόνου οἱ πρὸ ἡμῶν ἐπεσκόπουσαν, ἀλλὰ περὶ μόνου τοῦ ἑναρμονίου, καὶ αὐτοῦ τούτου περὶ ἓν τι μέγεθος συστήματος, τοῦ καλουμένου διὰ πασῶν. περὶ μὲν γὰρ τῆς χροῆς διεφέροντο, περὶ δὲ τοῦ μίαν εἶναι μόνην αὐτὴν τὴν ἀρμονίαν σχεδὸν πάντες συνεφώνουν.

(Aristox. *ap. ps.*-Plut., *Mus.* 1143e)

Although there are three genera into which the musical pitch structures are classified, which are equal as regards the ambitus of the scales and the functions of the notes, and also those of the tetrachords, formerly people have concerned them-

The source behind Aristides might have commented on Plato's text, while perfectly aware that 'Hypolydian' is in fact meant (e.g., "Of what he calls the slack *harmontai*, the 'Lydian' has the following form..."). When drawn out of this context, the designation as unqualified 'Lydian' became entirely misleading. — That Plato's *harmontai* were scales, i.e. arrays (*systemata*) of pitches in intervals (*diastemata*) of recognised size and arrangement, emerges from *Phlb.* 17cd; cf. Mountford 1920: 20.

selves solely with one, since those before us have surveyed neither the chromatic nor the diatonic, but solely the enharmonic, and this in regard of merely one particular ambitus, the so-called *diá pasón*. For they disagreed as regards its shade, but were virtually unanimous that there is only one kind of enharmonic.

Indeed there can be only one kind of enharmonic in either of the two systems, and the same is true for the Eratoclean diagram: had they admitted more than one 'shade' (*khróa*), the straightforward identification of notes across different *tónoi* would have broken down.⁴⁰ It seems the common pre-Aristoxenian notion of the auletic '*harmonía*', at least, would not include conclusive evidence on *pyknón* size, such as the lyre might have imparted by a true ditone tuned 'by consonance'. This is in accord with our previous analysis of Archytas' figures for the enharmonic intervals.

Although the second system achieves a perfect alignment of upper notes, Aristoxenus' criticism as "violating the harmonic laws and useless in every respect" seems to hit the mark.⁴¹ Although some of the scales stand in harmonic relations of fifths and fourths as required for modulation, such a pattern is not implemented throughout. Consequently, modulation for instance between Phrygian and Lydian, or between Dorian and Hypodorian, is impossible. Who would invent such a scheme? Is it an entirely artificial construct, designed by 'music theorists' who understood nothing about contemporary melodic composition or instrumental practice? The focus on the highest notes with its apparent auletic background tells against such an assumption, and it is a priori unlikely that advances in such a field as *tónos* theory were proposed by people without genuinely musical interest. More plausibly, then, the system is just what it appears to be: an attempt to incorporate several scales on one aulos, probably by aligning the designs of several earlier aulos types, more or less modified. This recalls the feat attributed to Pronomus, "the first to have played in Dorian, Phrygian and Lydian on one instrument".⁴² Originally this might have meant nothing more than being able to perform a piece such as the old *nómos trimelês* without changing the instrument – but still without far-reaching modulations.⁴³ Thus the second system might have originated in precisely that first stage of fifth-

⁴⁰ The concentration on the octave also mentioned in the passage need of course not imply that before Aristoxenus all scales envisaged were octave scales, but only that those theorists who contemplated the question of how intervals can be combined to *systemata* at all restricted themselves to octaves.

⁴¹ Aristox., *Harm.* 2.38, p. 47.15–16: ἐκμελῆς καὶ πάντα τρόπον ἄχρηστος.

⁴² Cf. n. 34 on p. 378 above.

⁴³ Cf. above, p. 7, n. 26. Note that a change of instrument necessitates either always taking the pair of reeds out of one to fit them into the other, adjusting their exact positions so that the pipes are in tune both within themselves and with each other, or maintaining no less than six reeds in playable condition (i.e. suitably moistened).

century aulos evolution. We can only speculate, however, since it is hard to make out how it was implemented in manufacture and playing technique. Finger holes that could be retuned by the amount of a quartertone would have solved most problems. Alternatively, these differences might have been effected by playing skill, so that the abstract relationships would have existed merely in the performer's mind. In any case, the particular arrangement of notes is not compatible with the *tónoi* of the notation, in any conceivable stage of its evolution. If notated aulos music was based on this second system, the individual scales would still have been written separately, in 'functional notation': using the basic series of signs, regardless of the obvious pitch differences.

Both systems are incriminated by Aristoxenus as being devised not with a view to harmonic laws, but to the *katapyknōsis* of the diagrams. Whether this term refers to their constriction to as little tonal space as possible or to their arrangement in a quartertone grid, is not clear.⁴⁴ Still, Aristoxenus concedes that in some respects questions of modulation were treated adequately by some *harmonikoi*:

περὶ δὲ συστημάτων καὶ τόπων οἰκειότητος καὶ τῶν τόνων λεκτέον οὐ πρὸς τὴν καταπύκνωσιν βλέποντας καθάπερ οἱ ἀρμονικοὶ ἀλλὰ τὴν πρὸς ἄλληλα μελωδίαν τῶν συστημάτων οἷς ἐπὶ τίνων τόνων κειμένοις μελωδεῖσθαι συμβαίνει πρὸς ἄλληλα. περὶ τούτου δὲ τοῦ μέρους ἐπὶ βραχὺ τῶν ἀρμονικῶν ἐνίοις συμβέβηκεν εἰρηκέναι κατὰ τύχην, οὐ περὶ τούτου λέγουσιν ἀλλὰ καταπυκνῶσαι βουλομένοις τὸ διάγραμμα, καθόλου δὲ οὐδενὶ σχεδὸν ἐν τοῖς ἔμπροσθεν φανερόν γεγένηται τοῦθ' ἡμῖν. (Aristox., *Harm.* 1.7, p.12.8–16)

The connection of scales and their positions and the *tónoi* must be addressed not with a view to the *katapyknōsis* as the *harmonikoi* have done, but with a view to the melodic correlation of the scales, asking on which notes (*tónoi*) they lie when they happen to be melodically connected. On this topic some of the *harmonikoi* have happened to say something briefly by accident, while talking not about this matter

⁴⁴ For the first option cf. Barker 1982a: 193 (see there for criticism on Macran 1902: 229–32); for the second, Barker 1978a: 8; Hagel 2000: 181, with reference to Nicom., *Ench.* 11, p.260.4–12; cf. also Barker 2007: 41–5. Plato, *Rep.* 531a, does not help dating these schools: there πυκνώματ' ἄττα cannot belong in a similar context, but means simply a close group of notes, comparable to the technical *pyknōn*; this may just be another instance of Plato's humoristic distortion of technical terminology. A quartertone grid stands behind the classification of intervals as 'odd' or 'even' (i.e., comprising an odd or even number of quartertones respectively: Aristox. *ap. ps.-Plut., Mus.* 1145bc; Aristid. *Quint.* 1.7, p. 11.14–17; cf. also *Plut., De E ap. Delph.* 389ef; *De defectu orac.* 436a), as rational and irrational (Cleonid. 10, p.199.4–7), and also behind the recognition of the enharmonic *diēsis* as the measure of pitch space (Aristot., see n. 39 on p.152 above); it crystallises in the archaic notation quoted in Aristid. *Quint.* 1.7, p.12–13 (cf. n. 46 on p.17 above).

but aiming at the *katapyknōsis* of the diagram, but in its entirety⁴⁵ this has become clear to practically nobody among our predecessors.

The reference to *katapyknōsis* connects this passage with the description of the two old *tónoi* systems. Indeed the reconstruction of their diagrams reveals that especially the ‘first’ system prefigures much of Aristoxenus’ account on modulation: its inventors may be Aristoxenus’ “some”, as opposed to those of the ‘second’ system, whose three-quartertone steps violate the principles of modulation. Related methodological criticism is articulated in another passage, where Aristoxenus denies that the principle behind the *katapyknōsis* diagrams of the *harmonikoi* can explain the structural coherence (*synékheia*) of a tonal system.⁴⁶ In this context he mentions the number of twenty-eight quartertones, obviously as the extension of a specific diagram he has in mind. This interval of a ninth might match the compass of the ‘second *tónoi* system’, which is plausibly identical with its Dorian scale (cf. Diagram 92 on p. 380 above). In this case, we would at last be bound to assume that this system was already published with a diagram. Yet its orientation towards auletic *pykná* of the size of three quartertones produces a conflict: if these *pykná* are divided equally, the resulting notes no longer suit a quartertone grid at all.⁴⁷ Fortunately there is an alternative possibility. If the Eratocleas’ diagram was arranged as in the tentative reconstruction of Diagram 91 (above, p. 377), its seven octaves would fit into the same space, a space that is moreover still identical with the old Dorian ninth. But how plausible is this reconstruction? This depends mainly on the role of the Mixolydian. All other scales form a straightforward series linked by alternative disjunctions and conjunctions, in accordance with the underlying crossroads principle. Their mutual relations remained canonical later; those of greater importance had been anticipated in one or both of the old *tónoi* systems. But the Mixolydian stood in no canonical relation to any other scale, and could in principle be attached to either side of the diagram.⁴⁸ In the ‘first *tónoi* system’ it had found its position a tone above the Lydian (if we express it in later terminology with a ‘corrected’ *mésē*), and this was the conception Aristoxenus adopted for his ‘high Mixolydian’. In the more archaic ‘second system’, however, the Mixolydian had been put a semitone lower, becoming the neighbouring key of Dorian (a function that is suggested by the form of the two scales). Aristoxenus refers to the respec-

⁴⁵ I understand καθόλου δέ as expressing the opposition to ἐπὶ βραχύ and κατὰ τύχην.

⁴⁶ Aristox., *Harm.* 1.27, p. 36.1–6.

⁴⁷ This discrepancy is glossed over too lightly in Hagel 2000: 181–2.

⁴⁸ Cf. above, pp. 32; 41 ff.

tive *tónos* as the ‘low Mixolydian’. This duplication indicates that his theory superseded preceding schemes, where possible, by integration – after all, this was a precondition for its adoption by practising musicians.⁴⁹ As regards the Eratocleans, I do not see what would have prevented them from following the ‘second *tónoi* system’ in the case of the Mixolydian; otherwise, their diagram would have excluded Dorian *synēmménon* modulation.⁵⁰ In any case, the constructors of charts comprising “the arrangement of the entire tonal system” can hardly have fallen short of other *katapyknōsis* systems, as regards the relative position of scales. Even if they did not define the possible interrelations between the keys exhaustively according to Aristoxenian standards (namely by separating ‘melodic’ and ‘extramelodic’ kinds of modulation), the Eratocleans’ diagram must be considered the most advanced production of pre-Aristoxenian *tónos* theory.

Aristoxenus purges contemplation of the tonal system of the paraphernalia of music-making, in order to establish a science in accordance with Peripatetic principles. Earlier music theory had been much more entangled with the various aspects of practised music:

ἃ δέ τινες ποιοῦνται τέλη τῆς ἁρμονικῆς καλουμένης πραγματείας οἱ μὲν τὸ παρασημαίνεισθαι τὰ μέλη φάσκοντες πέρας εἶναι τοῦ ξυνιέναι τῶν μελωδομένων ἕκαστον, οἱ δὲ τὴν περὶ τοὺς αὐλοὺς θεωρίαν καὶ τὸ ἔχειν εἰπεῖν τίνα τρόπον ἕκαστα τῶν αὐλουμένων καὶ πῶθεν γίγνεται...

(Aristox., *Harm.* 2.39, p. 49.1–5)

But what some make the objective of the discipline called harmonics, some saying that the notation of melodies is the end of the comprehension of each piece of music, others, the study of aulos, and the faculty to explain how each piece of aulos music is effected and by which causes...

Once more, the incriminated theorists are identified as ‘*harmonikoi*’.⁵¹ The main focus on aulos construction recalls the designers of the ‘second’ *tónoi* system, whose preoccupation with this instrument is stated by Aristoxenus and confirmed by our analysis. Our considerations have also shown that no major progress in notation could be expected from this side. Of course we cannot take it for granted that the ‘schools’ to which Aristoxenus refers here can be identified with any of those he mentions in other passages.

⁴⁹ The duplication of other scale names for filling out the missing semitones may have been inspired by the double Mixolydian.

⁵⁰ In the ‘first *tónoi* system’, this kind of modulation was apparently provided for by its Hypodorian; cf. *AGM*: 183 (by a miraculous “inference from the later systematised scheme”); Hagel 2000, Abb. 23 on p. 172.

⁵¹ Aristox., *Harm.* 2.40, p. 51.1.

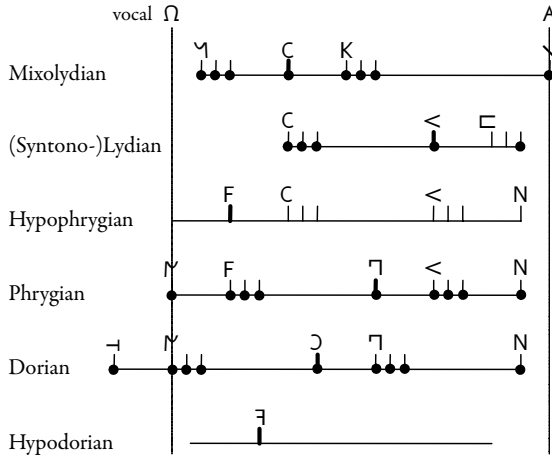
Diagram 93 Notating the 'first' *tónoi* system

Nevertheless, as long as no manifest contradictions arise, a certain economy of music theorists is probably not out of place: one should not posit more schools than necessary. Thus, for the group who regarded notating music as a main purpose there remain two candidates: the advocates of the 'first' *tónoi* system, and the Eratocleans. The former are perhaps a little more likely, because they also appear paired with the aulos-centrists elsewhere. Moreover, the fact that the 'first' system existed in a smaller and an extended form indicates that it was employed over some time, which makes an immediate connection with practised music plausible. From its internal structure, little or nothing argues against associating it with the notation. In Diagram 93, all those of its notes that can reasonably be reconstructed are supplied with their instrumental signs. Except for the Hypodorian, whose position was regularised later, probably by Aristoxenus, and about whose early form we can infer little,⁵² all relations are already those of the fully developed 'Alypian' system.

Moreover, the fact that the Mixolydian top note lies a semitone above the otherwise highest note N may be of significance for the relative chronology of the vocal signs. We have pondered the possibility that their highest triplet ABΓ originally reflected not the *pyknón* for which it stands later, but the instrumental 'nétai' ♯ΓN, which are separated by whole tones. This hypothesis required the assumption of a later re-assignment of

⁵² Cf. Hagel 2000: 174; 180; below pp. 429ff.

functions, an assumption that is not all too likely within a living score-producing tradition. If the invention of the vocal signs took place in a context that already included the high variant of the Mixolydian, the Ionian alphabet simply starts straightforwardly from the highest note.⁵³ If the Dorian scale is furthermore reduced to the Dorian octave species, the range of the reconstructed 'first' *tónoi* system is covered by the letters from A to Ω (Diagram 93).⁵⁴

All in all, the *tónoi* system mentioned first by Aristoxenus is in fact the more advanced, and probably the later. Whereas the 'second' system appears to reflect the integration of still largely independent scales into one set of auloi, the 'first' system betrays a more sophisticated approach within which true modulation was possible at various places. When the aulos was adapted to this paradigm, it necessarily became the chromatic instrument as we know it from Pompeii. The scope of music theory, however, had now been extended beyond the horizon of just one instrument. Aristoxenus' remarks on Eratocles and his followers reveal a highly abstract conception of tonal relations: scales were analysed as successions of intervals, which can be transferred from one end to the other; a procedure that cannot be executed in this form on either the lyre or the aulos.

Eratocles' seven octave species could give birth to the canonical number of seven *tónoi*. These are not attested by Aristoxenus himself (being too similar to his own approach to be ridiculed), but they are a commonplace of later handbook knowledge, and were in the end revived, although with a different musical meaning, by Ptolemy. As regards the notation, they perfected the 'enharmonic' range of keys. The Mixolydian however led the way to the conception of the 'chromatic' half, for the full exploitation of which Aristoxenus laid the theoretical ground.⁵⁵

If the Eratoclean octave species were demonstrated while assigning to similar functional notes the same pitch throughout, a structure of two octaves such as the Greater Perfect System was required (cf. Diagram 94, with the customary names).⁵⁶ The latter seems to go back to at least the early

⁵³ The intervening B stands for no note within this system; it is needed only for the Dorian *hyperboláion* tetrachord. Still, the semitone called for a *pyknón* even without consideration of the *hyperboláion*, especially in a paradigm called *katapyknōsis*.

⁵⁴ There remains, however, the question of how the lower Mixolydian enharmonic *pyknón* would have been notated, and the Hypodorian, which seems to incorporate the *synēmménon* tetrachord of the Dorian, poses similar problems.

⁵⁵ Cf. above, pp. 44ff. with Diagram 13 on p. 48.

⁵⁶ All extant accounts of the octave species are based on such a functional reference system: ps.-Plut., *Mus.* 1136e (cf. above, p. 372); Cleonid. 9, p. 197.4–199.3; Ptol., *Harm.* 2.5, p. 53.17–26; Aristid. Quint. 1.8, p. 15.11–15; Boeth., *Inst. mus.* 4.17, p. 347.21–348.2; Gaud. 19, p. 346.12–347.10; Bacchius 15, p. 296.16–297.7.

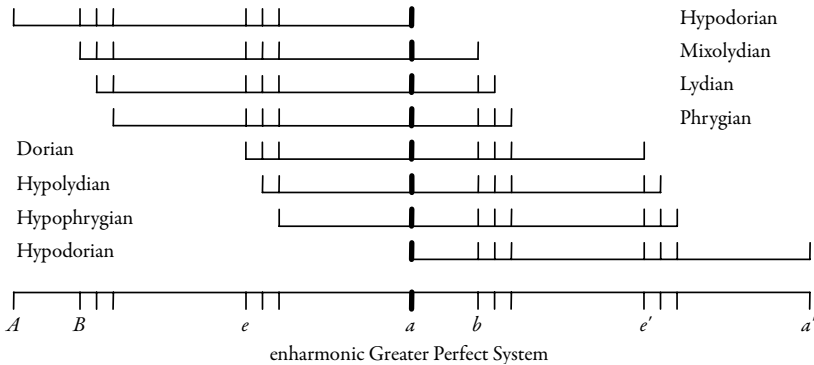

Diagram 94 Enharmonic octave species generating the Perfect System

fourth century bc. It was in all probability already known to Plato and apparently of some practical importance for the boring of single-mode auloi. Archytas might have been the first to muse over the figures reflecting its fixed notes as a set of ratios; until the middle ages these were transmitted as one of the rivalling ‘cosmic harmonies’, in which the celestial spheres were associated with notes of a scale.⁵⁷ Conceivably, this focus on the fixed notes was originally inspired by early aulos models with that slider mechanism that gave access to some prominent notes in the bass region, but produced no continuous scale there.

An absolute chronology of early Greek harmonic theory seems still out of reach. It is not even clear with which stage Stratonicus’ diagram should be associated. As an Eratoclean he might fit into the scheme most nicely; but Aristoxenus refers to diagrams of both the earlier *tónoi* systems, as well. On the other hand, should the late fifth century avant-garde composers have worked without a suitable notation, in a time when the conception of harmonic road junctions was already commonplace? The general impression we get of the music of these decades prompts us to date the necessary modifications in instrument design and notation rather earlier than later.

On one piece from a rather late stage in this musical revolution we have more detailed information. A fragment (almost certainly) from Aristoxenus enumerates the *tónoi* employed in Philoxenus’ *Mysians*, written around or in the first decades after 400.⁵⁸ This dithyramb started, we are told, in Hypodorian and concluded with Mixolydian and Dorian, while the central part was kept in Hypophrygian and Phrygian. ‘Mixolydian’ in com-

⁵⁷ Hagel 2005a.

⁵⁸ Ps.-Plut., *Mus.* 1142f; Aristot., *Pol.* 1342b; cf. *AGM*: 364–6; Hagel 2000: 81–2.

bination with Dorian obviously refers to the lower variant of this key, as incorporated in the traditional system of seven *tónoi*, (probably) in the Eratocleans' diagram, and also in the older 'second *tónoi* system'. In all these, Dorian and Mixolydian are harmonic neighbouring scales and thus natural companions, just as are Phrygian and Hypophrygian. Which one would Philoxenus have used? The isolation of the Hypodorian in the opening section of the *Mysians* might point to the 'second *tónoi* system', where this key is separated from the other four used in the piece by an uneven number of quartertones. This interpretation would pose a *terminus ante quem* for the 'second *tónoi* system' not long after 400. A date so early (or even earlier) is in accord with the functional notation found in the *Orestes* fragment, which might reflect either this same system or a more archaic approach. On the other hand, the vocal notation employed in this score might even post-date the 'first *tónoi* system'. If this is true, and if the *Orestes* fragment reproduces the notational practice of Euripides, both *tónoi* systems would be earlier than 405; thus the earlier 'second system' would comfortably fall within the productive life of Pronomus. In any case, the apparent neglect of the *tónos* approach in the *Orestes* must be explained with the comparatively less innovative character of the music of tragedy.

So much for the *Mysians* as a *terminus ante quem* for the 'second' *tónoi* system. On the other hand, is it likely that Philoxenus' music would still have employed the comparatively primitive approach exhibited by this system? Our sources give us the impression that the climax of modulation was reached in his age, and his name could serve as a shortcut for the novel style.⁵⁹ More probably, thus, Aristoxenus' analysis rests on an Eratoclean basis, in accordance with the understanding of his own age. In this case, we cannot take it for granted that his conception of the piece's *tónoi* is identical with that of the composer – although we should expect so, if some connection between modality and *tónos* had been persisting.

On balance, all that can be determined with some confidence is the fact that Philoxenus must postdate the advent of the 'second' system. His compositions, however, might have employed the more advanced 'first' *tónoi* – in this case, Aristoxenus' reference to the "Mixolydian" would be an anach-

⁵⁹ Aristox. *ap. ps.-Plut., Mus.* 1142bc (below, p. 423); Dionys. Hal., *Comp. verb.* 19: οἱ δὲ γὰρ διθυραμβοποιοὶ καὶ τοὺς τρόπους μετέβαλλον Δωρίους τε καὶ Φρυγίους καὶ Λυδίους ἐν τῷ αὐτῷ ᾄσματι ποιοῦντες, καὶ τὰς μελωδίας ἐξήλλαττον τότε μὲν ἑναρμονίους ποιοῦντες, τότε δὲ χρωματικάς, τότε δὲ διατόνους... οἱ γὰρ δὴ κατὰ Φιλόξενον καὶ Τιμόθεον καὶ Τελεστήν "the composers of dithyrambs switched between the modes (*trópoi*), composing in Dorian, Phrygian and Lydian within the same song, and varied the melodies, composing them now enharmonic, now chromatic, now diatonic... at least those following the style of Philoxenus, Timotheus and Telestes".

ronistic description of Dorian *synēmménōn* modulation – or an even later version. In any event, Stratonicus as the first to publish a diagram would be defensible only if the two early schemes were communicated by other means.

In the course of the preceding pages, the reader will have noticed that Aristoxenus' account of the two early systems has given rise to a terminological muddle: as he apparently goes back in time to achieve a climax of awkwardness, our numeration, while following his text, turns out to contradict the probable chronological order. Less confusing designations are needed. On Aristoxenus' testimony, we can safely call the second system with its three-quartertone intervals the 'old auletic *tónoi*'. Unfortunately, the other one is not similarly contextualised. Its outstanding characteristic is certainly the projection of the circle of the fifths, albeit in a rudimentary form, onto a quartertone grid; a feat that anticipated so much not only of Aristoxenus' work but also of modern music theory up until the idea of equal temperament. I will consequently term it the 'old commensurable *tónoi*'.

DATING THE ARISTIDES SCALES?

Every novice in the field of Greek music soon faces the great disappointment that almost all available genuinely musical information is post-classical, whereas the melodies of Aeschylus and Pindar are entirely inaccessible. That the Roman world already appears to have faced much the same situation is only a small consolation. In the course of this study we have tried to reconstruct the origins of the notation as well as some aspects of pre-Aristoxenian scalar theory. But we have not really broken the barrier to fifth-century music.

Aristides' set of *harmoníai* served us as a reliable guide in many respects. It is now generally accepted that in some way they reflect the musical reality from which the octave species were abstracted. In addition, we have seen how closely they are related to the arrangement of *tónoi*, a topic of similar importance for the history of notation and of harmonic theory. Now it is time to reconsider their possible origin. The *Orestes* fragment provided an argument for their close connection with musical practice; if it is genuine, it establishes a date that covers their associations with Plato's *Republic* in Aristides comfortably. As regards the *tónoi*, something very similar to the

Aristides scales is required to explain all ancient early systems we know of, with the exception of the Eratocleans, who already worked with octave species. The common assumptions that underlie the various systems show at least that they started from acknowledged forms of scales, and that these were similar to the Aristides scales at least as far as their upper parts are concerned. Still one question remains: do the scales as transmitted by Aristides ultimately derive from a source that antedates all *tónoi* systems, or are they read from the diagrams of such a system? In the latter case, a certain amount of theory-borne adaptation cannot be excluded; in the former, they can be accepted, apart from the possibility of scribal errors, as true witnesses to “classical” music.

Luckily, there are arguments for the optimistic option. As far as we see, an “Iastian” *tónos* was never introduced until long after Aristoxenus, when his thirteen keys were extended to a set of five triads. Thus, Aristides’ Iastian scale is certainly not taken from any of the about five known *tónoi* schemes up until Aristoxenus. Moreover, their similarity as regards the set of included scales makes the existence of another system with such an exotic *tónos* improbable (we can trust Aristoxenus to have cited the most dissimilar schemes he could find). And if one of the scales cannot plausibly stem from a *tónoi* diagram, the same is probable for the others as well. Consequently, little argues against the acceptance of the Aristides scales as genuine fifth-century evidence.

But if they are that old, is it plausible that their scales persisted in more or less the same form for a considerable time, as their association with the old *tónoi* systems would imply – instead of representing a mere snapshot of a passing musical reality? In fact Aristides’ reference to them, if interpreted correctly, betrays precisely the conception of stability even across an otherwise changing musical culture that we have to expect. In his text, their description is attached to the enumeration of the Aristoxenian divisions of the fourth. The transition reads as follows:

γίνονται δὲ καὶ ἄλλα τετραχορδικὰ διαίρεσεις, αἷς καὶ οἱ πάνυ παλαιότατοι πρὸς τὰς ἁρμονίας κέχρηνται. ἐνίστε μὲν οὖν αὐταὶ τέλειον ὀκτάχορδον ἐπλήρου, ἔσθ’ ὅπη δὲ καὶ μείζον ἑξατόνου σύστημα, πολλάκις δὲ καὶ ἔλαττον.

(Aristid. Quint. 1.9, p.18.5–8)

But there are also other divisions of the fourth, which were used for the *harmoníai* by the most ancient. These, now, sometimes completed a perfect octachord, but occasionally also a scale larger than six tones, often also a smaller range.

Aristides acknowledges the existence of tetrachord divisions unlike any in Aristoxenus' set, although without detailing their intervallic structure, and he points to the fact that these were typically applied to "the *harmoníai*" in an early period: as early, it seems, as musical memory reached back. In the next sentence the focus turns to these *harmoníai*, which are in the following conceived as deliberate selections from the tonal material – a conception that was exploited by Aristoxenus.⁶⁰ When describing them, however, Aristides refers to the quartertones and ditones of Aristoxenus' standard enharmonic. From all this it transpires that these "*harmoníai*" were not just those of the 'very ancient', as has often been assumed, but continued being used for a considerable period, in which the transition from one typical internal division of the fourth to another took place. This fits exactly with what we have deduced in the last chapter: sets of scales part of which were basically identical with those detailed by Aristides underlay both the 'old auletic' and the later 'commensurable' *tónoi*, although these differed in their analysis of the enharmonic tetrachord. Thus it seems highly plausible that Aristides' unnamed archaic divisions were in fact those three-quarter-tone *pykná* that our 'old auletic *tónoi*' employed, just as the regular quartertones by which he quotes the scales have their roots in the more advanced 'commensurable *tónoi*'.

The context of the strictly Aristoxenian enumeration of tetrachordal shades, the no less Aristoxenian viewpoint of musical *éthos* generated by eclectic use of notes, and finally the attribution of such a conception to the classical composers, all this confirms the suspicion that the enumeration of the scales is also taken from a lost work of Aristoxenus.⁶¹ In Aristides the indication that these are also the *harmoníai* Plato had in mind when writing his *Republic* is a mere afterthought.⁶² Obviously this connection would not have determined Aristides' selection of scales. On the other hand, the given selection conforms exactly with the *harmoníai* mentioned in Plato's dialogue. The conclusion seems inevitable that Aristides' ultimate source embarked not on providing a comprehensive list of ancient *harmoníai*, but on specifying those meant by Plato. Otherwise we would expect similar scales also for the rest of the ancient *tónoi*, such as Hypophrygian and Hypodorian. Consequently Aristoxenus (or whoever originally compiled the list) might have combined evidence from different sources. Starting from

⁶⁰ Aristox. *ap.* ps.-Plut., *Mus.* 1137a–d. In Aristides, the description of the scales is embedded within references to this conception (Aristid. Quint. 1.9, p. 18.9–10; p. 19.7–10); it forms the basis of his theory of melodic *éthos* (Aristid. Quint. 2.14, p. 79.2–81.6).

⁶¹ Cf. n. 47 on p. 18 above.

⁶² Aristid. Quint. 1.9, p. 19.2–7.

the ancient *tónoi* diagrams, which provided Dorian, Phrygian, 'high' Lydian and Mixolydian, he would have supplemented these with the 'slack' = 'Hypo-' Lydian of the Eratocleians, and with an Iastian of unknown origin. Still this last one reminds us of the possibility that the others (apart from the 'slack Lydian') might also stem from an even older tradition (going back to the original analysis of the scales in the earlier fifth century. After all, at least part of them must have evolved to comparatively stable pitch structures before being incorporated into the first *tónoi* schemes.

EARLY AULOI

Consequently one would assume some connection between the Aristides scales and the design of the classical aulos before Pronomus, when separate sets of pipes were needed for Dorian, Phrygian and Lydian music. The nature of this connection is however doubtful. Aristides' Phrygian and Dorian comprise nine notes each, distributed over an octave and a ninth, respectively. None of these scales can be managed by a single hand, at least not in their later pitch range, and also in no other pitch range that is accessible to the voice. If the aulos redoubles the song an octave above, however, the range of an octave is just controllable. But such a hypothesis is bound to assume a later transition to the 'right' register, a transition that would have left no traces in written sources. Although such an assumption cannot be strictly excluded, our survey of the iconographical evidence clearly suggested a pitch range quite in accordance with the 'citharodic octave' between CC and Θ Ν – even if its higher part often appears better represented. If all notes of the more extended Aristides scales are to be played, they must therefore be distributed between the pipes.

Let us recall the required notes. In Diagram 95 they are assembled according to old functional notation, without implication of relative or absolute pitch. The Phrygian, Iastian and Syntonolydian scales are easily transposed into sets of finger holes, according to the $\frac{3}{4} - \frac{3}{4} - 1$ tones scheme. The division of the *pykná* into enharmonic *diéseis* must be supplied by half-stopping, of course; the respective pitches are indicated by dotted circles. On the other hand, since adjacent fingers cannot normally span the highest interval of an enharmonic tetrachord, additional *diátonoi* must be bored wherever their neighbouring notes are present; they are printed grey. The lower end of the abstract 'pipes' in the diagram is generally determined by

Before Aristoxenus

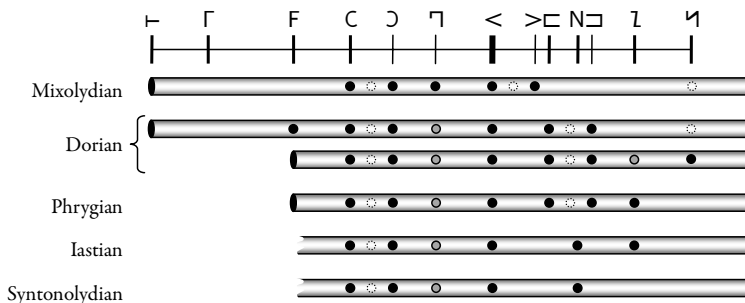

Diagram 95 Hypothetical single-mode aulos layouts for the Aristides scales (the ‘pipes’ are represented schematically: no physical measurements are intended)

the lowest required pitch. In the case of Iastian and Syntonolydian, however, the interval to the first finger hole would thus amount to a mere $\frac{3}{4}$ -tone. Since no excavated pipe of the simple type has a hole this close to the end, it is assumed in the diagram that the lowest pitch would here be supplied by a vent hole, with indeterminate pipe length below.

The Mixolydian stands out for its extremely large interval up to its highest note. If it were to be fingered in this form, at least two fingers would be useless; such an instrument design is utterly improbable. There is however a practical alternative. If the pipe is elongated to a fifth below the lowest note, the highest one can be played by overblowing, with all finger holes closed.⁶³ In the Diagram it is rendered in this way, the playable but hole-less $\ominus \uparrow$ once more rendered dotted.

The Dorian *nētē* might be played in the same way, as far as the enharmonic with its large ‘ditone’ at the upper end of the scale is concerned (cf. the long ‘Dorian pipe’ in Diagram 95). Aristoxenus, however, asserts that the ‘diatonic’ note in this tetrachord (in his analysis the *nētē synēmménōn*, which is identical with the *diátonos diezeugménōn*) had always been used in the accompaniment to Dorian melodies.⁶⁴ From this, we must expect a

⁶³ I have ascertained the possibility of playing ‘Mixolydian’ melodies in this way on an experimental instrument (unison and heterophonic, with circular breathing). The large gap greatly facilitates the transition between the registers. Thus the aulos may provide the clue to that curious scale; cf. the association of the Mixolydian with Pythoclidēs “the aulete” and Lamproclēs “the aulete”: ps.-Plut., *Mus.* 1136de; Schol. Aristoph., *Nub.* 967 (Wallace 2003: 73–5); see above, pp. 372f.

⁶⁴ Ps.-Plut., *Mus.* 1137c. The Dorian is implied by the reference to the *spondeion* (cf. 1134f–1135a), and by the following transition to examples from Phrygian music. For the intimate association between auletic *spondeion* music, Dorian and the enharmonic cf. also Dionys. Hal., *Dem.* 22 (as the maximal contrast to the Phrygian associations of *Métrōia / korybantiká*): ὅσπερ οἱ τῶν σπονδείων αὐλημάτων ἢ τῶν Δωρίων τε κἀναρμονίων μελῶν ἀκροώμενοι...; cf. also Sext. Emp., *adv. Math.* 6.8; Iambli., *v. Pythag.* 25.112; Quint., *Inst.* 1.10.32–3.

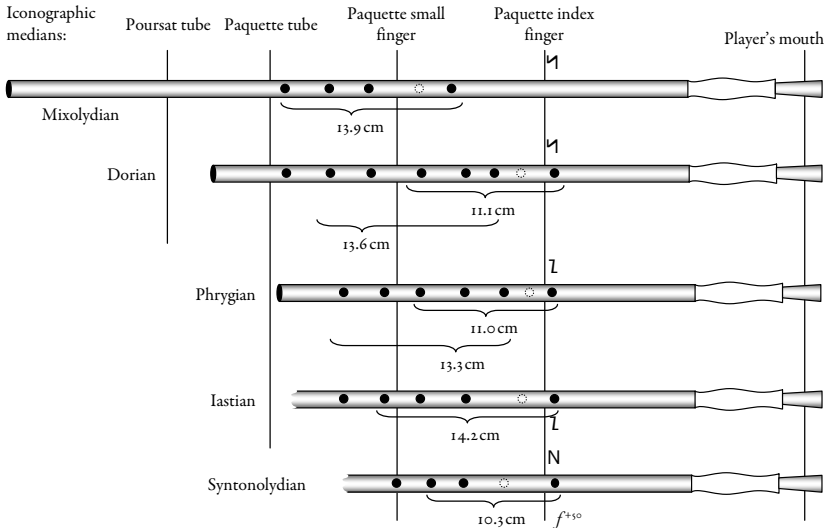

Diagram 96 Hypothetical single-mode aulos measurements for the Aristides scales

straightforward aulos design instead (cf. the short 'Dorian pipe' in the diagram).

In Diagram 96, the notes are translated into approximate physical pipe lengths and hole positions. In order to compress the finger spans as much as possible – no doubt a major concern in the making of simple one-handed pipes, the highest notes of all scales are set to the approximate pitch of the highest lyre string, between f and f^\sharp , which later remained associated with $\Theta \text{ M}$. Thus, all aulos scales are positioned within a high range of the voice. An even higher pitch is improbable, because we must assume that the general relation between instruments and voice was not entirely overturned by the development of new instrumental capabilities. In this way, we can detect the maximal playable ranges within each scale: if a particular scale was in reality taken at a lower pitch, the finger holes would have been even further apart. For comparison, the relevant iconographical means for the pipe lengths and the positions of the outermost fingers are also printed.

It emerges that one hand can manage only Aristides' 'Sytono-Lydian' with ease, all the more since it only requires four fingers.⁶⁵ The span of over fourteen centimetres necessary for Iastian is already beyond normal human

⁶⁵ For Lydian as an archaic auletic mode, cf. Aristox. *ap. ps.-Plut., Mus.* 1136c (cf. Clem., *Strom.* 1.16.76.4).

capabilities.⁶⁶ In Phrygian and Dorian, of the required notes the highest five are playable with one hand. The second hand would have to sit at least two holes lower in the case of Phrygian, but no less than four holes lower to access the Dorian *hyperypâtē*. If this note is denied such an early date in auletic music, a difference of at least two holes seems necessary (involving, however, a cruel span of about 13.5 cm on the lower pipe⁶⁷).

Unfortunately, none of the very few excavated early Greek auloi has the characteristics predicted by this model. Only on the wooden Louvre aulos, which is – as an artefact, perhaps not as a type – certainly of a much later date, is there a distance of a fourth between the highest holes of the two pipes, so that the index on the lower pipe releases the same note as the ring finger on the higher. But in the present context the ‘simple’ instruments with no more than six holes per pipe are of greater interest. On all of these, the difference corresponds to only one finger hole. On the Pydna aulos it is only about a tone. The pair of unknown provenance now residing in the Copenhagen museum is wrongly restored;⁶⁸ on any reasonable reconstruction, however, the highest notes are not more than a minor third apart. A similar relation appears between the Elgin pipes, if they belong to the same instrument at all.⁶⁹ These few examples, only one of which comes from a documented context and forms a certain pair, are all the archaeological evidence we currently have. The single pipes and numerous pipe fragments can contribute little to the present question, other than alerting us to the substantial variety of instruments produced.⁷⁰ On top of this, in the archaeological sample all pipes made of a more perishable material, such as

⁶⁶ For “playing Iastian” on the aulos, cf. Schol. Aeschyl., *Pers.* 938.

⁶⁷ I have succeeded in playing a model of such a Dorian aulos with the finger tips of thumb, index and small finger but the fleshy parts of the middle and ring finger. The small finger hole should be bored slightly out of line with the rest; a slightly lower position of the thumb hole (entailing a disjunctive tone smaller than the canonical 9:8) would definitely facilitate the playing. For comparison, spans in some excavated ‘primitive’ auloi are: Elgin pipes 13.3 cm and 12.6 cm; Pydna aulos 12.2 cm and 11.2 cm; Corinth fragment 11.9 cm; Brauron 11.9 cm; Reading: 11.2 cm. The assertion in Steinmann/Reichlin 2006: 239, that it is impossible to finger the higher four holes (without the vent hole) of such pipes at once apparently rests on an inept playing technique (cf. Baines 1962: 200).

⁶⁸ Published by Olsen 1967; cf. Psaroudakēs 2002: 364 pl. 24.

⁶⁹ With an assumed effective extension of 7.8 cm and 7.4 cm for reed insert plus reed on the shorter and longer Elgin pipe respectively, the pitches of the highest holes are calculated as about 320 cents apart.

⁷⁰ Apart from the aforementioned finds, the following publications are relevant: Furtwängler 1906; Hogarth 1908: 194 with pl. xxxvii.12; Dawkins 1929: 236–7 with clxi f; Blinkenberg 1931: 153–6; Broneer 1935: 53; Deonna 1938: 324–5 with pl. 92; Broneer 1947: 241 with pl. lxi.21; Boulter 1953: 114 with pl. 41; Stubbings 1962; Landels 1964; Bovon 1970; Bélis 1984a; Bound 1991: 232–4; Psaroudakēs 2002 (with tables and charts illustrating the variation in many parameters and new drawings of important items).

wood or cane, are necessarily underrepresented or altogether missing.⁷¹ Contrast this with the fact that λωτός (as a type of African wood) was one of the most frequent poetic expressions for the aulos since Euripides,⁷² and it becomes clear how limited our picture must remain in this respect. For instance, we have as yet no material traces of those overlong pipes that figure on some representations of dances in arms.

The literary sources are even scarcer: the question of which notes were actually played in fifth-century aulos music is touched only in two notorious, but nevertheless brief, passages that are doubtless excerpted from Aristoxenus.⁷³ The first deals with the alleged invention of the enharmonic. The story is a pre-Aristoxenian construction, but the facts it sets out to explain are genuine, and from the arguments put forth by Aristoxenus himself a (minimal) scale for this type of aulos music emerges clearly. We have built on evidence from this text earlier. Its details are so important that we must now quote it in full, with a commented translation.

Ἔσθ' Ὀλυμπος δέ, ὡς Ἄριστόξενός φησιν, ὑπολαμβάνεται ὑπὸ τῶν μουσικῶν τοῦ ἔναρμονίου γένους εὐρετῆς γεγενῆσθαι· τὰ γὰρ πρὸ ἐκείνου πάντα διάτονα καὶ χρωματικά ἦν. ὑπονοοῦσι δὲ τὴν εὐρεσίαν τοιαύτην τινὰ γενέσθαι· ἀναστροφόμενον τὸν Ἔσθ' Ὀλυμπον ἐν τῷ διατόνῳ καὶ διαβιβάζοντα τὸ μέλος πολλάκις ἐπὶ τὴν διάτονον παρυπάτην, τοτὲ μὲν ἀπὸ τῆς παραμέσης, τοτὲ δ' ἀπὸ τῆς μέσης, καὶ παραβαίνοντα τὴν διάτονον λιχανόν, καταμαθεῖν τὸ κάλλος τοῦ ἦθους· καὶ οὕτως τὸ ἐκ τῆς ἀναλογίας συνεστηκὸς σύστημα θαυμάσαντα καὶ ἀποδεξάμενον, ἐν τούτῳ ποιεῖν ἐπὶ τοῦ Δωρίου τόνου· οὔτε γὰρ τῶν τοῦ διατόνου ἰδίων οὔτε τῶν τοῦ χρώματος ἄπτεισθαι — ἀλλ' οὔδὲ τῶν τῆς ἀρμονίας. εἶναι δ' αὐτῷ τὰ πρῶτα τῶν ἔναρμονίων τοιαῦτα. τιθέασιν γὰρ τούτων πρῶτον τὸ σπονδειῶν, ἐν ᾧ οὐδεμία τῶν διαιρέσεων τὸ ἴδιον ἐμφαίνει (εἰ μὴ τις εἰς τὸν συντονώτερον σπονδειασμόν βλέπων αὐτὸ τοῦτο διάτονον εἶναι ἀπεικάζει. δηλοῦν δ' ὅτι καὶ ψεῦδος καὶ ἐκμελὲς θῆσει ὁ τοιοῦτος τιθεῖς· ψεῦδος μὲν ὅτι διέσει ἔλαττον ἐστὶ τόνου τοῦ περὶ τὸν ἡγεμόνα κειμένου· ἐκμελὲς δ' ὅτι, καὶ εἴ τις ἐν τῇ τοῦ τονιαίου δυνάμει τιθεῖ τὸ τοῦ συντονωτέρου σπονδειασμοῦ ἴδιον, συμβαίνει ἂν δύο ἐξῆς τίθεσθαι δίτονα, τὸ μὲν ἀσύνθετον, τὸ δὲ σύνθετον). τὸ γὰρ ἐν ταῖς μέσαις ἔναρμονιον πυκνὸν ᾧ νῦν χρῶνται οὐ δοκεῖ τοῦ ποιητοῦ εἶναι. ῥάδιον δ' ἐστὶ συνιδεῖν, ἕαν τις ἀρχαϊκῶς τινος αὐλοῦντος ἀκούσῃ· ἀσύνθετον γὰρ βούλεται εἶναι καὶ τὸ ἐν ταῖς μέσαις ἡμιτόνιον. τὰ μὲν οὖν πρῶτα τῶν ἐν-

⁷¹ Cf. Landels 1981: 298.

⁷² Eurip., *Heraclid.* 892; *Tr.* 544; *El.* 716; *Hel.* 171; *Phoen.* 787; *Bacchae* 160; 687; *Iph. Aul.* 438; 1036; from the numerous later instances cf. e.g. Hermesianax *ap.* Ath. 598c; *DAGM* № 20.14 (Athenaeus' Paean); *Suda*, s.v. λωτός; Pollux 4.71 (a list of aulos materials); for the tree, Pliny, *NH* 13.104–6; for its association with theatre instruments, *NH* 16.172.

⁷³ For these much-discussed texts, cf. esp. Winnington-Ingram 1928 and *GMW*: 215–18; 255–7. The following analysis, even if departing in some details, is generally based on their conclusions.

αρμονίων τοιαῦτα ὕστερον δὲ τὸ ἡμιτόνιον διηρέθη ἐν τε τοῖς Λυδίοις καὶ ἐν τοῖς Φρυγίοις. φαίνεται δ' Ὀλυμπος αὐξήσας μουσικὴν τῷ ἀγένητόν τι καὶ ἀγνωσόμενον ὑπὸ τῶν ἔμπροσθεν εἰσαγαγεῖν, καὶ ἀρχηγὸς γενέσθαι τῆς Ἑλληνικῆς καὶ καλῆς μουσικῆς. (ps.-Plut., *Mus.* 1134f–1135c)

Olympus, as Aristoxenus says, is supposed by the *mousikoi* to be the inventor of the enharmonic genus. For before him all was diatonic and chromatic. They conjecture that the invention took place about in the following way:

Throughout the passage, which seems to have been inserted in pseudo-Plutarch's dialogue almost without modification, Aristoxenus is eager to distinguish between his own views, partially corroborated by deduction or observation, and a 'historical' reconstruction which he attributes to the *mousikoi*, expressing his scepticism by words such as ὑπολαμβάνεται, ὑπονοοῦσι or τοιαῦτα. It may be significant that the priority of both the other genera to the enharmonic is not expressed in indirect speech, although embedded between information marked as quotations: the chronology is in accord with Aristoxenus' own convictions.⁷⁴ Olympus belongs to the earliest layer of Greek musical memory, which placed him immediately after the mythical origins.⁷⁵

when dwelling upon the diatonic and often carrying the melody over to the diatonic *parypátē*, sometimes from *paramésē*, sometimes from *mésē*, while stepping over the diatonic *likhanós*, he observed the beauty of the character.

As usual, and as is appropriate for aulos music anyway, Aristoxenus uses functional note names. We learn of a musician experimenting with the effects of leaving out one particular note. If we assume a standard diatonic scale, Olympus starts from a set of notes like *e-f-g-a-b* (in relative pitch), and observes the effect of its reduction to *e-f-a-b*. That the lowest note of the tetrachord (*hypátē*, *e*) is also envisaged becomes clear only below, when the "semitone in the *mésōn* tetrachord" is mentioned.

The scale that is built in this way by analogy he accepted as marvellous, and composed in it in the Dorian *tónos*.

Here we have the least plausible aspect of the *mousikoi*'s reconstruction. In order to account for the form of the entire envisaged scale (i.e. the scale of *spondeíon* music referred to below), they have to attribute to the archaic

⁷⁴ Aristox., *Harm.* 1.19, p. 24.20–25.4.

⁷⁵ Cf. *AGM*: 300–1.

aulete an entirely unlikely amount of theoretical awareness. The higher part of that scale does not contain a complete (melodic) tetrachord from which the second highest note could be omitted, but merely one (melodic) interval. This had to be explained as construed analogously to the lowest interval of the lower tetrachord ($e-f$). The choice of an appropriate *tónos* is treated as secondary to establishing the abstract scale structure.

For it touches neither the particular features of the diatonic nor of the chromatic – but also not those of the enharmonic. The beginnings of his enharmonic would be of about that kind. For they posit that its oldest instance is the *spondeion* ('libation' [tune]), in which none of the (tetrachord) divisions displays its peculiarities

Indeed a resulting 'tetrachordal' structure of $e-f-a$ is the least common denominator of all three genera in their 'standard definition'. We learn that the *mousikoí* referred not to reconstructed older stages of music, but accepted traditional cult music as surviving compositions from the earliest times. From the fact that the *spondeion* in particular was singled out as the supposed oldest instance of the enharmonic, it appears that it was in fact the only traditional music that exhibited the cited characteristics. This observation, although being far from decisive, casts doubts on the modern idea of a general 'older enharmonic' phase of Greek music; we will come back to that question.

(except if someone, with view to the higher *spondeiasmós*, would imagine that this very point is diatonic. But obviously who posits thus posits contrary both to the truth and to the laws of music. To the truth, because it is smaller by a *díesis* than the tone lying next to the guide/leader (*hēgemón*); to the laws of music, because even if one puts the particular characteristic of the higher *spondeiasmós* in the function of a tone, this would result in placing two ditones in immediate succession, one incomposite, one composite).

A possible objection, perhaps raised in a seminary of Aristoxenus', was that the higher part of the scale appeared diatonic. This higher part consisted of the usual 'disjunctive' tone between *mésē* and *paramésē* ($a-b$), and a '*spondeiasmós*', here referred to as the "higher *spondeiasmós*". The allegedly diatonic nature is based on the impression of a sequence of two tones (with no intervening note), a structure that occurs only in the diatonic. Aristoxenus counters the objection on two grounds. Firstly, he points to the fact that the higher interval is actually not a tone at all, but only of the size of three

quartertunes (*diéseis*).⁷⁶ This alone, however, would not suffice, since in Aristoxenus' own system there was an acknowledged diatonic variant in which the two 'tones' were in fact not whole tones but described as odd multiples of quartertones, including a three-quartertone interval.⁷⁷ Thus, the reference to the missing quartertone alone does not disprove a diatonic structure. On the other hand, pursuing the argument further in this direction would have resulted in asserting that the higher of the two diatonic 'tones' is never smaller than a real tone – a contention for which Aristoxenus could produce little argument.⁷⁸ To do him justice, it must be said that, as far as we know, no ancient author would have allowed for such a small highest diatonic interval.⁷⁹ Aristoxenus' assertion is therefore correct, even if he cannot easily trace it back to first causes: everybody who accepted his general laws governing the tetrachord divisions, laws which were certainly in accord with contemporary musical practice, would have conceded straight away that a three-quartertone interval above a tone is not possibly diatonic. Thus, Aristoxenus' assertion that a correct observation of the interval size disproves a diatonic interpretation is certainly legitimate. Nevertheless, he is still aware of the more general problem,⁸⁰ as emerges from the careful introduction of his final point. For the sake of the argument, he assumes for the moment, not that the interval in question were in fact a tone, but that it served the function (*dynamis*) of a tone – just as similar intervals did in existing diatonic variants.⁸¹ In this way, he also elevates the discussion above the fruitless level of questioning the opponent's musical

⁷⁶ The *spondeiasmós* is also mentioned as a three-quartertone interval in Aristid. Quint. 1.11, p. 28.1–7; for the interpretation of this passage cf. Hagel 2000: 60–4.

⁷⁷ Aristoxenus' soft diatonic of semitone – three quartertones – five quartertones (*Harm.* 2.51, p. 64.8–11). Cf. Diagram 36 on p. 153 above.

⁷⁸ On Aristox., *Harm.* 1.22–3, p. 29.7–12, cf. n. 112 on p. 420 below.

⁷⁹ Only in Ptolemy's 'tense diatonic', the highest interval of 10:9 is smaller than a 9:8 tone, but still much larger than three quartertones.

⁸⁰ Since the laws of tetrachord division are derived not from first principles but only from the observation of musical scales in use, one might have contended that the *spondeion* displays a valid diatonic division not otherwise attested.

⁸¹ Significantly, at this point Aristoxenus uses not the straightforward *tónos* but the adjectival form *toniaion*. In his *Harmonics*, too, this term can designate a diatonic interval that occupies the position of a 'tone' in the standard definition of the genus; in this way it is employed for underlining the general applicability of a rule to corresponding intervals of different shades: Aristox., *Harm.* 3.64, p. 80.11; p. 81.6; 65, p. 81.8; 9–10 (*toniaion* can of course also refer to the exact whole tone, if it is the adjective to an explicit '*diástēma*', present in the text for other reasons: 1.28, p. 36.12; 29, p. 37.8; 2.51, p. 64.13). Similar is the usage of *hēmitoniaion*: 3.65, p. 81.13–82.1. Once, *ditoniaion* is also found, again in an analogous context: 3.66, p. 82.16. For Aristoxenus' 'shorthand' terminology, cf. Barker 2007: 205 with n. 7 (although I fail to recognise the evidence claimed on p. 211 n. 9 that Aristoxenus treated his tones and semitones differently; it seems to me that his theorems are consistent if read within the boundaries of the implied genera, but regardless of their shades).

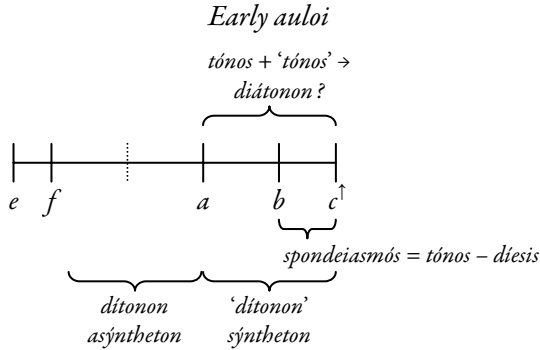

Diagram 97 Two consecutive ditones in the *spondeion* scale

ear; a mere quarrel about interval sizes could never lead to a decisive proof, but would ultimately appeal to the judgement of the reader. In contrast, the momentary concession for the sake of the argument that the interval in question could be viewed as a possible diatonic tone, perhaps even if it was only three quartertones (the καὶ εἴ signalling his actual reservations about such an assumption), prepares the way for the decisive rejection of the diatonic hypothesis. Here we experience the virtues of Aristoxenus' functional approach, which allows talking about possible scales irrespective of actual interval sizes.

Thus Aristoxenus works out that together with the disjunctive tone, the assumed (functional) tone would form a composite ditone above *mésē*. On the other hand, there is also a ditone below *mésē* (cf. Diagram 97). But this contradicts a harmonic theorem, a form of which we find developed in Aristoxenus' *Harmonics*: two ditones cannot be concatenated.⁸² At last, the diatonic hypothesis is refuted regardless of the actual size of the upper interval.⁸³

⁸² Cf. Aristox., *Harm.* 3.64, p. 80.3–10. But this is to be understood only for the enharmonic, since δύο δίτονα follows τὸ δίτονον 3.63, p. 79.1, where the definite article shows that not any interval of this size is meant ('a ditone'), but the typical enharmonic unit ('the ditone'). Barker (*GMW* 1: 256 n. 265) rightly points out that this version of the theorem cannot be applied to the present case. Above all, a proof for the enharmonic can barely refute a diatonic hypothesis. We do not know whether Aristoxenus published other sets of his theorems than those which we have in the 'third book' of his *Harmonics*; sets which may have included a general or a diatonic version. But the conclusion is warranted anyway: within a diatonic framework the lower ditone would of course have to be conceived of as implicitly composite, so that one ends up with a sequence of four tones $f - (g) - a - b - c^\sharp$. Such a structure is refuted in *Harm.* 3.65, p. 81.9–12. Possibly Aristoxenus, in his concentration on the enharmonic interpretation of the *spondeion* scale, and rightly aware that two ditones can stand in succession neither here nor there, carelessly cited the 'wrong' theorem.

⁸³ As a corollary, it follows that the three-quarter tone at the upper end of the scale cannot have the 'function' of a tone, and must therefore stand for a semitone in the standard definitions. This was of

For the enharmonic *pyknón* in the *mésai*, which they use now, does not seem to stem from this composer. This is easy to see, if one listens to somebody playing the aulos in the old fashion; for he intends that the semitone in the *mésai* is also in-composite.

After his digression on the faulty diatonic interpretation, Aristoxenus supplies the evidence for auletic *spondeíon* music as the precursor, itself of undefined genus, of the true enharmonic. As the text stands, the attitude of sceptically relating the *mousikoi's* model seems abandoned; now Aristoxenus puts forward his own views, partially based on observation. It is of the essence that he refers to music actually heard in his time, and that he is convinced that this style underwent little change during the centuries. Although many performers adopted the typical enharmonic *pyknón* ($e-e^{\uparrow}-f$), some did not; the latter was perceived as the old way. Moreover, in *spondeíon* music there was agreement on having a *pyknón*, if at all, only at the bottom of the scale: in the *mésou* tetrachord, in terms of theoretical analysis. This must be the meaning of “also” in the last translated sentence, and it is confirmed in the second passage, discussed below: the ‘semitone’ in the higher tetrachord was treated as melodically in-composite by all players.⁸⁴ The citation of features characteristic for the *spondeíon* in particular once more appears to bear the implication that there were no other commonly known instances of such non-divided enharmonic music.⁸⁵

About this, then, was the beginning of the enharmonic. Later the semitone was divided in Lydian and Phrygian music. It seems that Olympus furthered music by introducing something entirely new and previously unknown, thus becoming the founder of the Hellenic, the good music.

Aristoxenus finally accepts Olympus as the inventor of the *spondeíon*, and the *spondeíon* as the precursor of the enharmonic. Apparently his scepticism extended merely to the specific story involving some experiment with the diatonic, followed by the artificial creation of a new scale by analogy. How the mention of Lydian and Phrygian music is to be understood, is not

course already implied by the construction of the scale “by analogy”, which associates this interval with the lowest one.

⁸⁴ A different interpretation is given in *GMW* 1: 217 n. 88: “‘Also’, i.e. the semitone as well as the ditone is in-composite”. But this does not account for the specific placement of *καί* and neglects the patent parallel, where the melodic omission of *tritē* is introduced as a commonly known fact (ps.-Plut., *Mus.* 1137b).

⁸⁵ Consequently, we ought to understand ἀρχαϊκῶς τινος αὐλοῦντος not in a general way as “playing in the ancient style”, but “playing [the *spondeíon*] in the old-fashioned manner”.

immediately clear. There are mainly two options. One is to understand “later” (ὕστερον) as “only later”. In this case, the Dorian and the *spondeion* would still take precedence in the invention of the enharmonic *pyknón*, in accordance with the specific association of the Dorian with enharmonic music.⁸⁶ As a corollary, all quartertone music would be perceived as definitely post-Olympian. But there are two problematic points. Firstly, if the introduction of Lydian and Phrygian enharmonic *pykná* were merely mentioned as analogical to the Dorian, one would expect this to be signalled by an “also”. Admittedly, the expected καί is not easily accommodated within the sentence in its given form; but at any rate, if the Lydian and Phrygian evolution is a mere side thought, it is startling that we are told specifically about the division of the *pyknón*, which presupposes the introduction of a non-divided enharmonic, but not about that introduction, or simply about the adoption of the enharmonic into these forms of music as a whole. Secondly, Aristoxenus expressly ascribes enharmonic Phrygian music to Olympus, namely the so-called *nómos Athēnās*.⁸⁷ On the interpretation under discussion, those melodies could not possibly contain a *pyknón* either. But we are never told so, in spite of the detailed discussion of notes omitted by ancient musicians, which includes evidence on Phrygian aulos music.⁸⁸ Moreover, if either Aristoxenus or the *mousikoi* had had evidence of Phrygian (and Lydian) undivided enharmonic melodies, their concentration on the *spondeion*, one particular form of Dorian music, would become unintelligible. So we turn to the other possible interpretation, namely that the division of the *pyknón* is envisaged to have taken place originally in the Lydian and Phrygian. This complicates the picture, since it presupposes not only a transposition of the semitone + ditone pattern from the Dorian *spondeion* to Lydian and Phrygian music, but also a subsequent re-adoption of the quartertone *pyknón* into the *spondeion*. Thus, despite the fact that a true enharmonic *pyknón* was heard in many *spondeion* performances, no direct line would be drawn from the archaic *spondeion* to this style. As a historical model, this interpretation is clearly inferior to the first one. But

⁸⁶ Aristox. *ap. Clem.*, *Strom.* 6.11.88.1; cf. n. 98 below.

⁸⁷ Ps.-Plut., *Mus.* 11.43bc (cf. West 1992a: 33). Cf. Barker 2001: 13–14, with speculations on the kind of scales that Stesichorus might have adopted from Olympus’ music (ps.-Plut., *Mus.* 11.33f). It is true that an enharmonic with quartertones would appear problematic in lyre music (Barker 2001: 17 with n. 34). But this problem may be imaginary, since Barker’s hypothesis rests, *inter alia*, on the identification of the *nómos Athēnās* with the *nómos harmáteios*, which is only found in Schol. Eurip. *Or.* 1384 (cf. Hesych., s.v. ἀρμάτειον μέλος), as one among several conflicting explanations, none of which appears based on authentic musical knowledge. If the two *nómoi* were in fact different, nothing can be inferred about Stesichorus’ scales.

⁸⁸ Aristox. *ap. ps.-Plut.*, *Mus.* 11.37b–d.

we must not confuse the evidence from the text with the historical evolution we are ultimately interested in. Presently we are investigating the opinions of Aristoxenus and his precursors; and on this level, the latter interpretation is certainly to be preferred. To begin with, it accommodates the text nicely: on the assumption that this is what Aristoxenus wanted to say, there is nothing that we would really miss. Not even the fact that the transfer of an undivided enharmonic to Phrygian and Lydian music is not explicitly mentioned is troublesome, since it is precisely the division that is left to account for. If we start from the musical evidence available in the fourth century, as it emerges from the text, we can easily see how it forced this particularly complicated historical model upon the ancient theorist. On the one hand, there was the *spondeion*, attributed to Olympus, whose scale could neatly be taken as a structural precursor of the enharmonic. On the other, there existed Phrygian and Lydian music such as the *nómos Athēnás*, attributed to the same Olympus, but incorporating the usual truly enharmonic quartertones. Aristoxenus could not resist the proposed interpretation of the *spondeion* as the primordial form of the enharmonic, all the more as it was backed by the contrast between an old-fashioned and a modern way of performance.⁸⁹ This accepted, Olympus' employment of quartertones in other types of music necessitated the assumption (never expressed as such) that he transferred the idea of a three-note tetrachord to other types of scale before completing his invention.⁹⁰ Quite possibly, the *mousikoi* were thinking in more formalistic, less realistic terms, and hence little troubled by the implications; perhaps they would have allowed for a tradition of Olympus' original *spondeion* even though Olympus himself

⁸⁹ It appears that even the modern *spondeion* with divided semitones fell short of truly evolved enharmonic music: if it was possible to play more or less the same melody with and without the intermediate notes, the conclusion can hardly be escaped that these 'enharmonic' notes were used (almost) exclusively within transgressions through the semitone: $e \rightarrow e' \rightarrow f$ and $f \rightarrow e' \rightarrow e$, but not e.g. $a \rightarrow e' \rightarrow f$. We would expect a much freer use of the quartertones in enharmonic compositions of the classical age; the *Orestes* papyrus may be an example.

⁹⁰ Slightly problematic is the passive "was divided" (διηρέθη), which appears more idiomatic if the quartertones are attributed to an unnamed or unknown inventor rather than to Olympus. But this is not conclusive, and the argument is counterbalanced by the subsequent emphasis of Olympus introducing something new and formerly unknown, which would be a curious description of the mere exclusion of a note. Also, one might argue that Olympus' contribution is marked as concluded with the phrase τὰ μὲν οὖν πρῶτα τῶν ἐναρμονίων τοιαῦτα "about this, then, was the beginning of the enharmonic", which precedes the division of the semitone. But this phrase echoes the earlier εἶναι δ' αὐτῶ τὰ πρῶτα τῶν ἐναρμονίων τοιαῦτα "The beginnings of his enharmonic would be of about that kind", where the personal pronoun indicates that the story of Olympus' enharmonic has not come to an end (again, the adaptation of an undivided enharmonic for other kinds of music is no possible option, because it would make the focus on the *spondeion* unaccountable for).

had also invented the regular enharmonic *spondeion* in a later stage. Aristoxenus does not expressly reject this unlikely possibility, but both accounts for it and marks it out as unlikely by the tentative formulation that “the enharmonic *pyknón* ... does not seem (οὐ δοκεῖ) to stem from [Olympus]”. Obviously this particular assumption is prompted merely by the evidence of the ‘archaising’ performances of particularly the *spondeion* tune – otherwise nothing would argue against tracing the entire enharmonic, Dorian, Lydian and Phrygian, back to Olympus. But in the face of such performances, the *spondeion* with a *pyknón* is consequently envisaged by Aristoxenus as most probably a post-Olympian development.

So far, we have read the passage as referring to an auletic melodic scale of the form printed in Diagram 97 on p. 401 above. Doing so, we have passed over a number of inconsistencies in the text, which regard the relative extensions of the ‘semitone’ in the lower and the *spondeiasmós* of three quartertones in the higher tetrachord, and to which we must now pay attention. At three points, the text demands that these two intervals be of equal size. Firstly, the creation of the scale is envisaged as the analogical extension of the diatonic *mésón* tetrachord without its *likhanós*. This idea, attributed to the *mousikói*, could only be conceived if the intervals in question were in fact similar: otherwise there would be no analogy at all. Secondly, the reference to the upper interval as the ‘higher *spondeiasmós*’ demands that there be a lower *spondeiasmós*, and in consequence that there is a similar three-quarteritone interval at the lower end of the scale.⁹¹ Finally,

⁹¹ Barker (*GMW*: 255–6) interprets the expression ‘*syntonóteros spondeiasmós*’ as the ‘stretched’ three-quarteritone variant of a standard semitone *spondeiasmós* as the typical *spondeion* interval. There are several objections to this. Firstly, the semitone as such can hardly have been perceived as the “interval characteristic of *spondeia*”. The same interval at the same position of the scale was part of melodies in the “developed enharmonic” (cf. the *Orestes* fragment) as well as in diatonic and chromatic tunes. The mere fact that it was incomposite (as opposed to the “developed enharmonic”) – a theoretical conception – would barely have prompted the introduction of a specific name for the interval as such, even if this characteristic had been commonly acknowledged. Which it was not: Aristoxenus, who relied on his readers’ knowledge of what a *spondeiasmós* and even a *syntonóteros spondeiasmós* might be, has to point out the fact that the incomposite nature of the lower semitone can be detected in performances of a certain kind. This discrepancy proves beyond doubt that the characteristic of the *spondeiasmós* was something else: seemingly, its size of (approximately) three quartertones (cf. n. 76 on p. 400 above). On top of this, the semantic core of the term *syntonos* is something like “strained tight” (LSJ), which becomes ‘high pitched’ with view to the increase in tension, by which higher pitch is effected in lyre strings and vocal chords (cf. e.g. Aristot., *Gen. anim.* 787b). Consequently, tunings are called *syntonos* if they contain notes of comparatively high pitch. ‘Modes’ called ‘*syntonos*’ as opposed to ‘slack modes’ contain more high notes, or are performed in a higher register (cf. Aristot., *Pol.* 1342b). Similarly, of two intervals of similar size within one scale one may conceivably be picked out as the more *syntonos* instance. It seems less likely that the wider interval of two variants was termed the “tighter”, by transferring a notion from one boundary note to the interval as such (because in Aristoxenian theory it is the position of the *likhanós* in relation to *mésē* that is

the notion that the ‘archaising’ performance tried to keep “the semitone in the *mésai* incomposite, as well” demands that the higher (i.e. the *diezeugménon*) tetrachord contains another ‘semitone’.⁹² In short, the entire passage presupposes that the two intervals were of equal size, which excludes the specific form given in Diagram 97; but as regards this size, the text hovers between the terminology of ‘semitone’ and complementary ‘ditone’ and the explicit assertion of three quartertones. This stunning incoherence finds its explanation partly in the specific circumstances, namely the adaptation of an earlier view by Aristoxenus, partly in his typical method of dealing with propositions concerning the genera, and partly in the axe he has to grind as regards the enharmonic.

The *mousikoí* were apparently arguing directly from *spondeíon* music and the primitive types of aulos archaic music was played on. Built for large spans with no more than five finger holes per pipe, these auloi incorporated no semitones. The demand for a more even spacing, together with the musical importance of the tone had led to the typical auletic division of the fourth: after a tone was subtracted from it, the remainder was divided into approximately equal parts, each comprising an interval of about three quartertones.⁹³ At least, this was how emerging harmonic theory perceived the layout of such pipes. If the ‘diatonic *likhanós*’ is left out on such an instrument, the remaining structure provides an ‘enharmonic’ with a large three-quartertone *pyknón* (cf. Diagram 38 on p.157 above). For the *mousikoí*, the enharmonic was thus sufficiently accounted for. Yet such an old auletic scale was incompatible with Aristoxenus’ system of genera and shades, which would assign it to the chromatic. Consequently, Aristoxenus supplanted his enharmonic terminology of semitone-*pyknón* and ditone, wherever possible. We must not consider this as a matter of fraud. In the course of our discussion of the passage we have already noticed that Aristoxenus appeals to a functional description where necessary, in principle allowing the *spondeiasmós* in the place of a tone, while nevertheless referring to a ‘ditone’, although the actual interval fell short of two tones by a quartertone. Similarly, the reference to a ‘semitone’ as the precursor of the enharmonic *pyknón* is not out of place whenever not the interval sizes, but the functional structure is under investigation. Finally, we must take into

regarded as mainly characterising the tetrachordal shades, the notion of *syntonos* became associated rather with smaller intervals, in accordance with its semantic origin).

⁹² Cf. above, p. 155 with n. 48.

⁹³ Such physical considerations caution against interpreting similar scales from ancient Greek auloi, Arabic oboes and European bagpipes all too rashly in terms of historical connection (cf. Hipkins 1903: 375–6; Husmann 1937: 43–4; Baines 1960: 24; Ahrens 1987: 173–4).

account that the old three-quartertone *pykná* were at odds with the rows of semitones demanded by the modulating music of fourth-century compositions. The Delphic Paecans illustrate a *spondeion*-like structure incorporated into a Hellenistic composition precisely by putting a semitone in the place of the archaic three-quartertone interval.

The topic of the *spondeion* is taken up in another passage from pseudo-Plutarch, where it stands in a discussion of allegedly deliberate tonal self-restraint on the part of former musicians (in contrast to most of fourth-century music). There is no need to quote it in full. What it says about the melodic scale is entirely consistent with the passage discussed, although the focus is on the more familiar performances with an already divided enharmonic *pyknón* in the lower part of the scale.⁹⁴

In contrast to the former chapter, however, additional notes come into view that are used only in the accompaniment.⁹⁵ Three are listed together with the melodic notes they accompanied: the *pyknón*-dividing enharmonic note in the higher tetrachord (*tritē*), and two notes higher than any mentioned for the melody: *nētē* and *nētē synēmménōn*. Notes common to melody and accompaniment are unfortunately of no interest for the argument, nor is there reference to Dorian music other than the *spondeion* mode. For

⁹⁴ Ps.-Plut., *Mus.* 1137b–d. This passage was traditionally interpreted as describing a more advanced style, merely connected historically to the *spondeion* tune, a view based partly on the observation that it is here called the *spondeiazōn* / *spondeiakós trópos*, and especially on a misguided preconception of ancient Greek music evolving from strict homophony towards a limited amount of heterophonic accompaniment. At the same time it was understood that the ‘melodic’ scale belonged to the voice, but the accompaniment to the aulos, introducing the idea of two pipes playing in unison a heterophonic accompaniment; thus the notion of an unison aulos, which makes sense only for the strict homophonic hypothesis, was queerly maintained in a heterophonic context. Also, the underlying assumption that the vocal line adopted the exact copy of an old aulos scale, while the accompanying aulos changed to largely different notes, seems rather absurd. Cf. *AGM*: 359 n.13; Barker 1995: 50 (as opposed to *GMW*: 256–7); Hagel 2004a: 378. The terms *spondeiazōn trópos* and *spondeiakós trópos* (themselves used interchangeably) as opposed to “the *spondeion*”, if not introduced merely for stylistic variance, might refer to music of the *spondeion* style, as opposed to a more strictly defined *spondeion* tune, both however to be played on the same type of instrument. Aristoxenus deliberately cites traditional cultic music familiar to everyone (Plato, *Min.* 318b; *Symp.* 215c; Aristot., *Pol.* 1340a; cf. the *auloi spondeiakoi* in Pollux 4.81), where one could read the notes employed from the fingering: the *Métrōia* mentioned afterwards are also auletic pieces (cf. Duris *ap.* Ath. 618c; Dionys. Hal., *Ant. Rom.* 2.19.4). On the other hand, *spondeion* songs (from which the metrical term *spondeus* derives) probably followed the conventions of the auletic *spondeia*, all the more whenever they were accompanied by an aulos.

⁹⁵ The restriction of the discussion to the melody is expressly marked in the first passage: διαβιβάζοντα τὸ μέλος (ps.-Plut., *Mus.* 1134f), which is echoed in the second passage in διαβιβάζειν τὸ μέλος, here applied to the missing *mesopyknon* in the upper part of the scale (1137c). The fact that in the second instance τὸ μέλος establishes the contrast to the accompaniment (ἡ ἐν τῇ κρούσει γινόμενη χρῆσις) demonstrates the specific sense that we must attribute to it also in the first passage.

Before Aristoxenus

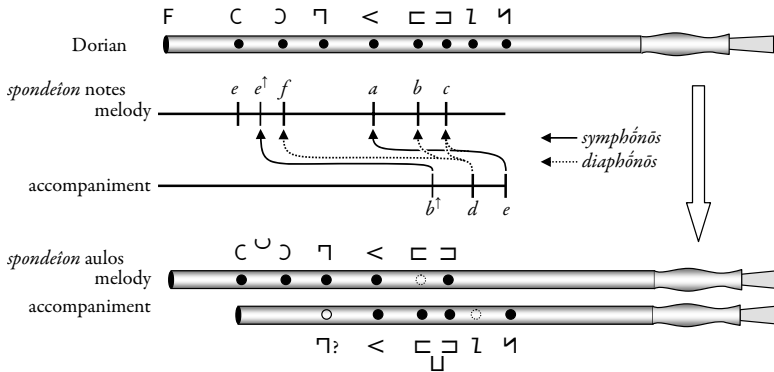
Diagram 98 Notes of *spondeion* music and the 'ancient' Dorian aulos

this musical style, at least, we can be sure that the melody went down as far as *hypátē* CC, but not higher up than enharmonic *paranété* ΔΔ. Diagram 98 produces a graphical representation of all mentioned notes and their relations.

The distribution – as far as we are told about it – is identical with that which we considered above for a Dorian pipe without *hyperypátē* on the basis of physical considerations. In the light of Aristoxenus' remarks, the two pipes we have posited there become a melodic and an accompanying pipe.⁹⁶ This perfect coincidence elevates the proposed 'Dorian aulos' above the level of mere speculation; even so, any substantiation by hard archaeological evidence would be more than welcome.⁹⁷ Fortunately, however, our reconstruction also provides a material basis for one or two musical details. Firstly, the absence of a diatonic note in the upper tetrachord adds to our understanding why Dorian was considered less adequate for diatonic music.⁹⁸ Secondly, the text emphasises that *tritē* (b^\uparrow) appeared only in the accompaniment, but not in the melody. It was played together with melodic *parypátē* (e^\uparrow), with which it builds a consonant fifth (*symphältnōs*). If

⁹⁶ If a vocal melody accompanied by such an instrument does not rise above the melodic pipe, the aulos could be pitched even a bit higher than envisaged, thus mitigating the finger span between ΠΔ and ΔΔ.

⁹⁷ Sacrificial auloi are associated with box wood in Pliny, *NH* 16.172 (but cf. Servius, *Georg.* 2.193). If this pertains to archaic Greece as well, the chances of archaeological confirmation are poor.

⁹⁸ Aristox. *ap. Clem., Strom.* 6.11.88.1: προσήκει δὲ εὖ μάλα τὸ ἐναρμόνιον γένος τῆ δωριστῆ ἀρμονίᾳ καὶ τῆ φρυγιστῆ τὸ διάτονον, ὡς φησὶν Ἀριστόξενος. "The enharmonic genus belongs nicely to the Dorian *harmonía*, and to the Phrygian the diatonic, as Aristoxenus says." An Aristoxenian judgement on appropriateness (*tò prosékton*) would rather be oriented towards the 'ancient' musical styles. The technical advancements especially of the aulos might have obscured from a late-fourth-century mind how often the cherished self-restriction of old composers was in fact mere physical necessity.

consonance is sought, the combination is natural, since the two middle notes of the *pyknón* (the *mesópykna*) establish no resonant relation with notes of a different type.⁹⁹ It is likely that *tritē* was employed only for this single purpose, since for the other two mentioned notes of the accompaniment two usages are cited. One would certainly not expect that *tritē*, which is discussed first, received less care. Aristoxenus, it appears, gives an exhaustive list both of accompanying notes not present in the melody, and of the melodic notes accompanied by these. If *tritē* could accompany only *parypátē* because of the isolated state of the *mesópykna*, it follows that a melodic *tritē* would in turn require an accompanying *parypátē*, or else a unison accompaniment. The former is physically impossible, since an accompanying pipe that is to play *nētē* and *nētē synēmménōn* cannot at the same time play such a low note, at any rate not one that requires half-stopping.¹⁰⁰ Unison, on the other hand, seems to have been typical for final notes;¹⁰¹ presumably it would have put too great an emphasis on a structurally unimportant note such as *parypátē*. So it would become understandable why “the ancients” abstained from dividing the higher *pyknón*: according to our reconstruction, there was no fitting note on the accompanying pipe.

On the other hand, the foregoing analysis started from the assumption that only a consonance would have been acceptable at that point. Yet of the five note pairings mentioned by Aristoxenus, three are deliberately used as dissonances (*diaphónōs*).¹⁰² The strive for consonance alone can therefore not sufficiently explain the apparent isolation of the two *mesópykna*. Two further reasons recommend themselves, one historical, one physical. Firstly, if the *mousikoi* and Aristoxenus are right, the division of the *pykná* came as an addition to a traditional auletic style. On the other hand, from Aristoxenus’ description of accompanying notes we get the picture of canonised

⁹⁹ This holds for wide three-quarteritone *pykná* as well as for the ‘regular’ Aristoxenian semitonal ones.

¹⁰⁰ *Parypátē*, a *mesópyknon*, cannot possibly have been bored as the lowest hole, if it did not even appear in the archaic way of playing the *spondeíon*.

¹⁰¹ ps.-Aristot. *Pr.* 19.39.

¹⁰² In spite of the modern hypothesis that the pure major third played an important role in fourth-century music, ancient theory developed no distinction between ‘minor resonance’ and ‘dissonance’. All intervals other than octave, fifth and fourth, and the combination of these intervals with the octave, were classified as *diaphóna*, with the explicit inclusion of harsh dissonances such as semitones and quartertones. Cf. Aristox., *Harm.* 2.45, p. 56.3–8; 1.20, p. 25.13–15; Cleonid. 5, p. 187.15–19; similarly, in non-Aristoxenian context, Theon, *Util. math.* 48.16–49.5. The same basic distinction also governs Ptolemy’s finer classification of *homóphōnoi* and (merely) *symphōnoi*, on the one hand, and *emmeleís* (melodically accepted intervals) as opposed to the bulk of *ekmeleís* at the other; cf. Ptol., *Harm.* 1.4, p. 10.21–8; 1.5, p. 11.10–12; 1.7, p. 15.10–17. Only Gaud. 8, p. 337.5–338.7, distinguishes a class of *pará-phōnoi*, intermediate between consonant (*symphōnoi*) and dissonant (*diaphōnoi*) intervals, which appear consonant in the accompaniment. But since the examples include (as the text stands) a tritone as well as the ditone, the notion cannot be identified with ‘minor resonance’ in our sense.

relationships between melodic and accompanying notes: not a one-to-one relation, to be sure, but a definite subset of the various possibilities, without doubt greatly contributing to the recognised character of the music. Under such conditions, it is understandable that the newcomer among the accompanying notes did not overcome established relationships, but became associated merely with its melodic colleague. This line of reasoning would explain the restricted usage of *tritē* in the accompaniment, but not its absence from the melody. Here the physics of the wind instrument may come into play. A melodic *tritē* (b^\uparrow) would be produced by half-stopping the finger hole of the *paranētē* (c^\uparrow). Other parameters being equal, a note produced by this technique has less volume and a comparatively muffled sound. On contemporary folk instruments such as the Armenian *duduk*, this effect must be counterbalanced by increased air pressure. On the aulos, however, the amount of air pressure is necessarily the same for both pipes. If one played a half-stopped note on one pipe and a note from an open hole on the other, the relationship between them is unavoidably different from that between two open holes. If the pipes are divided into a melodic and an accompanying, half-covering a hole only on the former must produce an unwanted effect: the ‘accompaniment’ would become more prominent than the ‘melody’, no matter how hard or softly the player blows. As a consequence, the ideal accompaniment to a half-stopped note can only be another half-stopped note. Only in this case can the player optimise the sound by increased blowing pressure as well. Within the given scale, all this tells strongly against a melodic *tritē*, for which there is no complement on the higher pipe, whereas an accompanying *tritē* (b^\uparrow) emerges as the natural counterpart of *parypātē* (e^\uparrow). On top of this, the high degree of resonance between these notes makes the interval sound especially strong, which also counters the adverse effect of half-stopping. On balance, what we learn from Aristoxenus about *spondeion* accompaniment evokes not the idea of a later “harmonisation”, but of a highly traditional dichordal harmony deeply rooted in archaic instrument design.

Aristoxenus’ remarks were also taken as support for the idea that ancient accompaniment was always higher than the voice. Here some caution is due. Indeed the accompanying pipe, as a whole, is higher. As a corollary, all three notes that are sounded only on this pipe are in the highest range and therefore higher than the notes they accompany. But since the text is interested only in such non-melodic notes, we cannot deduce anything about the relation of melody and accompaniment in the range common to both pipes. Even so, it must be emphasised that, thanks to the general relation between the pipes, the possible relations with the accompaniment

above the melody far outnumber those with an accompaniment below.¹⁰³ On the other hand, one must not forget that all these conclusions apply to one specific ‘Dorian’ instrument; one must not presume that the relation between melody and accompaniment was similar on other aulos types.

How a *hyperypátē* ΦF should have been played, is obscure. One might ponder the possibility of a transmission error in Aristides, the ΦF being transposed from the Phrygian.¹⁰⁴ But this merely transfers the problem, since this note is present in the *Orestes* fragment (*DAGM* №3), whose upper melodic limit of $\Delta \square$ might otherwise support our analysis. The possibility remains that early auloi were confined to the Dorian octave ‘proper’, while the inclusion of *hyperypátē* originated in citharody and was adopted on the mechanical aulos only later.

Whether the lowest playable note was CC or ΦF , the respective pipe would extend into at least the region of ΦF anyway: like in the case of the Iastian, it is for aesthetic reasons unlikely that a smaller interval than a tone was found below the lowest finger hole. Thus we must expect that Dorian auloi were rather long instruments. Compare the increased average pipe length that the vase paintings associate with dances in arms (labelled ‘Poursat tube’ in Diagram 96 on p.395 above): few other scenes suit the *éthos* with which Dorian music was associated as well as these displays of martial education.¹⁰⁵

Finally, we may wonder how the lower region of the accompanying pipe was bored. In a continuous scale, the lowest playable note would be $M \square$, the *diátonos* (cf. Diagram 98 on p.408 above). This note was however alien to enharmonic melodies; if it had been part of the accompaniment, we would expect mention of it in Aristoxenus’ discussion. The next lower note, the enharmonic *likhanós* $\Pi \square$ does not make much musical sense either. Possibly, then, the lowest playable note was in fact *hypátē*, an entire fourth below the lowest fingerable note. A similar design of five finger holes with (about) an empty fourth below is found on the Reading pipe, which is

¹⁰³ Even if the accompanying pipe extended down to *hypátē* (see below), there were only nine possible note pairs with lower against twenty-nine with higher accompaniment.

¹⁰⁴ Since the *hyperypátē* falls within the range of the *hypaton* tetrachord, the idea of its unsuitability for a Dorian scale could be supported by Aristoxenus’ remark that this tetrachord was excluded from ancient Dorian music (ps.-Plut., *Mus.* 1137d). But probably he would have analysed the note rather not as the *diátonos hypatón* (cf. his “*nētē symēménōn*” instead of “*diátonos diezeugménōn*” immediately before), but as a (disjunctive) tone below the *pyknón*. At any rate, Aristides emphasises the fact that not all of his *harmoniai* confine themselves within an octave (Aristid. Quint. 1.9, p.18.6–8; cf. p.391 above); since this holds true only for his Dorian, any transmission error would have to be assigned to the time before Aristides, while the analysis of the ranges would have to be by Aristides himself. All this is very unlikely.

¹⁰⁵ Cf. Plato, *Rep.* 399ab.

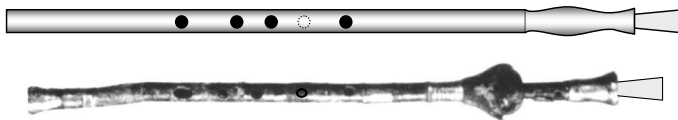

Diagram 99 The hypothetical *spondeion* accompanying pipe and the Reading pipe

pitched about a quartertone higher than the hypothetical pipes of the foregoing consideration (cf. Diagram 99).¹⁰⁶ However, this pipe with its unfamiliarly large bulb appears to have a *pyknón* immediately above the lowest finger hole, and a disjunctive tone at the top. Thus it can serve only for a general comparison.

Whereas we have found sufficient evidence in order to propose a reconstruction of the Dorian aulos, the case of the Phrygian is less hopeful.¹⁰⁷ There is no way to cover its octave with one hand, and still Aristoxenus holds that its highest note was employed both in the melody and the accompaniment from the earliest times on. This seems to preclude a neat separation into a melodic and an accompanying pipe. As a small consolation, the calculated extents of a Phrygian aulos match the iconographic average best, just as the Phrygian mode is associated with the aulos more than with any other instrument. On the other hand, we have no positive evidence for an early Phrygian melodic aulos scale such as we have for Dorian. If in the Aristides scales features of cithara tuning interfere with early aulos scales, especially in the lower range, and if the mechanism of

¹⁰⁶ Cf. Landels 1968, with pl. 55; *AGM*: 100, with pl. 26. The exact length of the instrument's second lowest section is not certain. From Landels' measurements, and assuming a perfect fourth between lowest finger hole and thumb hole as he does, I obtain a lowest interval of 462 cents; the pitch of the lowest finger hole is calculated to about 246 Hz, close to modern *b*.

¹⁰⁷ The question of the 'Phrygian aulos' is complicated by the fact that this designation is (later?) attributed to instruments one pipe of which was equipped with a horn-like bell, which are however totally absent from classical Greek iconography (cf. *AGM*: 91–2). In a study devoted entirely to this instrument, Bélis (1986) proposes to define it mainly by the narrow bore mentioned by Aelianus, *ap. Porph., in Harm.* 34.11–16, regardless of the presence of a bell (certainly the reeds that are represented very clearly in Bélis' figs. 2 and 3 do not suggest a narrow bore at all; but as usual, iconography in isolation must be met with suspicion. As regards the Phrygian connection, the presence of horned pipes in the Hallstatt culture is not unproblematic). Concerning the low pitch, I must admit that I can follow neither Bélis' physics nor Barker's (*GMW* II: 232 n. 101); cf. Plut., *Non posse suaviter vivi* 1096a (without Rasmus' 'emendation'). A surprising effect that produces low pitches ('falsset notes') from narrow pipes is however described by Byrne 2004 (who kindly let me try it out on his pipes). But since in this way mainly notes a fourth below fundamental frequency are obtained, such pipes can produce only conjunct fourths of any type at the lower end of their scales, and thus nothing that can be associated with 'Phrygian *harmonía*'. In any case, on the Greek modulating instruments that played Phrygian as well as Dorian, it was certainly not possible to change the main bore diameter: hence, the typical flavours of Dorian, Phrygian and Lydian aulos music could be produced, in the latter half of the fifth century at least, on pipes with similar diameter.

early multi-*tónos* auloi also advanced their capabilities to match the lyre in this respect, we are not in a position to disentangle the strands. At any rate, the inherent problem of the simple aulos was its restricted gamut, just as the scarcity of producible notes was that of the lyre.

THE 'ENHARMONIC' INTERVALS

The foregoing considerations contradict two widely held beliefs: that the enharmonic of the classical age incorporated true quartertones, and that it was preceded by an older style with undivided semitones. Both assumptions rest on remarks made by Aristoxenus. We have sufficiently discussed those concerning the latter; since the views proposed here are bound to be controversial, it is indispensable to investigate also the passages in favour of old quartertones. Before doing so, however, let us collect the contrary evidence.

Most importantly, there was no commonly agreed notion of a quartertone enharmonic among theorists, and even less so, the further we get back in time. Out of the three early *tónoi* systems whose outlines we are in a position to reconstruct, the two more advanced systems enable modulation within a quartertone grid, while the most archaic-looking clearly features three-quartertone *pykná*, credibly attributed to the finger holes of the simple aulos. This in turn accords with the archaeological evidence. Archytas, whose life span coincided with the invention and use of most if not all of these conceptions, saw no need for a quartertone enharmonic with its *likhanós* a true ditone below the upper note of the tetrachord (in illuminating contrast, his account of the chromatic is based on tuning in fifths and fourths). Since the Pythagorean philosopher and friend of Plato's is hardly suspicious of musical neoterism, we cannot easily escape the conclusion that his environment did not embrace the notion of a ditonic enharmonic as particularly noble or classical. Similarly, the original conception of the notation with its identification of the enharmonic and the diatonic *parypátē* contradicts a *pyknón* the size of a *lémma*. The pre-Aristoxenian derivation of the enharmonic from the *spondeíon* with its typical three-quartertone intervals similarly testifies to theorists thinking in terms of three-quartertone *pykná*. Finally, on simple auloi playing in the range of the male voice and the central range of the ancient notation, a disposition of finger holes that includes semitones in the lower part of the scale is virtually

impossible to play. On modulating chromatic instruments, on the other hand, it is the three-quartertone interval that requires special skills; thus, organological considerations suggest an evolution from archaic three-quartertone *pykná* towards semitones in the late classical period. Aristides Quintilianus' reference to the old *harmoníai* also hints at non-standard tetrachord divisions in the period 'by far most ancient'.

Against all this concurrent evidence, Aristoxenus insists on the ditonic nature of especially the old-fashioned music. The relevant passage stands within a discussion of the possible ranges for the inner notes of the tetrachord:

ὅτι δ' ἔστι τις μελοποιῖα διτόνου λιχανοῦ δεομένη – καὶ οὐχ ἡ φαυλοτάτη γε ἀλλὰ σχεδὸν ἡ καλλίστη – τοῖς μὲν πολλοῖς τῶν νῦν ἀπτομένων μουσικῆς οὐ πάνυ εὐδηλὸν ἔστι, γένοιτο μεντὰν ἐπαχθεῖσιν αὐτοῖς· τοῖς δὲ συνειθισμένοις τῶν ἀρχαϊκῶν τρόπων τοῖς τε πρώτοις καὶ τοῖς δευτέροις ἰκανῶς δῆλόν ἔστι τὸ λεγόμενον. οἱ μὲν γὰρ τῇ νῦν κατεχούσῃ μελοποιῖᾳ συνήθεις μόνον ὄντες εἰκότως τὴν δίτονον λιχανὸν ἐξορίζουσι· συντονωτέραις γὰρ χρῶνται σχεδὸν οἱ πλεῖστοι τῶν νῦν. τούτου δ' αἴτιον τὸ βούλεσθαι γλυκαίνειν αἰεὶ. σημεῖον δ' ὅτι τούτου στοχάζουσι· μάλιστα μὲν γὰρ καὶ πλεῖστον χρόνον ἐν τῷ χρώματι διατρίβουσιν, ὅταν δ' ἀφίκωνταί ποτε εἰς τὴν ἀρμονίαν, ἐγγύς τοῦ χρώματος προσάγουσι συνεπιπωμένου τοῦ μέλους.

(Aristox., *Harm.* 1.23, p. 29.14–30.8)

The fact that there is a style of composition that requires a ditonic *likhanós* – and not the most inferior but virtually the most excellent – is not easily conspicuous to most of those who concern themselves with music nowadays; but it would become so if they are guided there. But to those who are acquainted with the old-fashioned styles (*arkhaïkoí τρόποι*), both the first ones and the second ones, what has been said is sufficiently clear. For those who are familiar solely with the currently dominating music must naturally exclude the ditonic *likhanós*, since virtually the majority nowadays uses higher ones. The reason for this is the pursuit of sweetness throughout. That this is their objective is shown by the fact that above all and for the most time they employ themselves with the chromatic, and when they occasionally arrive at the enharmonic, they drive it close to the chromatic, the melody being dragged along.

Two points are most clearly stated here. Firstly, in the music that was actually heard in Aristoxenus' time, a semitone enharmonic was the exception. And secondly, Aristoxenus is convinced that earlier music had used precisely such an enharmonic, and that there are others who know this as well. Any assessment of the musical value of this statement must consequently answer two questions. Firstly, what kind of music is Aristoxenus talking about? Secondly, where did he gain the knowledge of its fine tuning, and can it rightly be supposed to have been transmitted down to the late fourth

century unaltered? Do we have to reckon with traditional music-making inside conservative circles, preserving tunes and tunings that were mostly forgotten by the public? Or is Aristoxenus talking about a more theoretical awareness, based on literary evidence?

Before we embark upon pondering these more thorny questions, we ought to be perfectly clear about the situation Aristoxenus is envisaging at the time when he composes his works. The status of the enharmonic in this period is most strikingly illuminated by the verb *ἐξορίζουσι*, 'exclude', which does not refer to the practical abolishment of a quartertone tuning, but to the dominant theoretical stance. Aristoxenus is actually opposing a majority who are by no means ready to accept his preferred enharmonic even as a theoretical possibility. The fact that later handbooks still transmit the Aristoxenian quartertone enharmonic as its exclusive variant must not blind us to the fact that it was virtually unknown to the musical environment of the adult Aristoxenus. This emerges even more unmistakably from another passage, once more found in the pseudo-Plutarchan dialogue:

οἱ δὲ νῦν τὸ μὲν κάλλιστον τῶν γενῶν, ὅπερ μάλιστα διὰ σεμνότητα παρὰ τοῖς ἀρχαίοις ἐσπουδάζετο, παντελῶς παρητήσαντο, ὥστε μηδὲ τὴν τυχοῦσαν ἀντίληψιν τῶν ἐναρμονίων διαστημάτων τοῖς πολλοῖς ὑπάρχειν. οὕτως δ' ἀργῶς διάκεινται καὶ ῥαθύμως, ὥστε μηδ' ἔμφασιν νομίζουσιν παρέχειν καθόλου τῶν ὑπὸ τὴν αἴσθησιν πιπτόντων τὴν ἐναρμόνιον δίεσιν, ἐξορίζουσιν δ' αὐτὴν ἐκ τῶν μελωδημάτων, πεφλυαρηκέναι τε τοὺς δόξαντάς τι περὶ τούτου καὶ τῷ γένει τούτῳ κεκρημένους. ἀπόδειξιν δ' ἰσχυροτάτην τοῦ τάληθῆ λέγειν φέρειν οἴονται μάλιστα μὲν τὴν αὐτῶν ἀναισθησίαν, ὡς πᾶν ὃ τι περ ἂν αὐτοὺς ἐκφύγη, τοῦτο καὶ δὴ πάντως ἀνύπαρκτον ὄν παντελῶς καὶ ἄχρηστον.
(Aristox. *ap. ps.-Plut., Mus.* 1145ab)

Our contemporaries have entirely deprecated the most beautiful of the genera, that which was most appreciated by the ancients because of its dignity, so that the majority has no longer the slightest apprehension of the enharmonic intervals. They are so idle and careless as to think the enharmonic *diēsis* does not give the impression of something falling within the realm of perception at all, but exclude it from the melodic lines and make a fool of those who attribute the issue some significance and make use of this genus. And they believe that the best proof for the truth of what they say is brought about first of all by their own lack of sensitivity, as if everything that escaped them were for that reason wholly non-existent and therefore also entirely useless.

Around 300 BC, Aristoxenus was facing a world in which not even the trained ears of professional musicians welcomed the true quartertone as a

possible melodic interval. The majority – and it would seem, the vast majority – of theorising musicians considered a harmonic theory based on melodic quartertones as ridiculous. At face value, it is not even the strict quartertone that is at stake now, but the entire enharmonic genus. Is this the sign of an ongoing evolution, an old Aristoxenus witnessing the ultimate obsolescence of an enharmonic that had still been at large when the ‘first book’ of the *Harmonics* was written, albeit, in the author’s opinion, in a distorted shape? Perhaps, but there is also another possibility: Aristoxenus might have made up his mind about classification. In the *Harmonics*, the complaint is about the common habit of playing an enharmonic that is very close to chromatic. But in the passage from pseudo-Plutarch, the line of criticism is different. The enharmonic is reduced to a single conception, crystallised in the idea of ‘the’ enharmonic *diesis*, whose absence from contemporary music Aristoxenus laments. It may be more this terminological narrowing down of the ‘enharmonic’ that accounts for the differences than an actual dying out of a musical style.¹⁰⁸ This becomes clearer if we apply the criteria of the second passage to the reality described in the first: it appears that the music portrayed here would be no more admissible as an enharmonic containing ‘the’ *diesis* than there (we must not forget in this context that the musical notation did not distinguish between enharmonic and chromatic *pykná*, and that we know the musical discourse on the corresponding terms mostly through the filter of Aristoxenus). If this analysis is correct, it does not imply anything about the relative chronology of the two passages. Possibly the older Aristoxenus developed an increasingly fossilised attitude, finally admitting as enharmonic nothing but his preferred form. Alternatively, he might have started from the dogmatic position expressed in the second quoted passage, to adopt a more nuanced viewpoint only later. The second option is more attractive also from a historical perspective. Since the quartertone *diesis* ruled at the time of Aristotle as a theoretical conception, the younger Aristoxenus is more likely to have embraced it dogmatically.¹⁰⁹

¹⁰⁸ Cf. also the phrase quoted by Plutarch, *Quaest. conviv.* 711c: ...οἱ δ’ ἄνδρες καὶ διαθεθρυμένοι τὰ ὤτα δι’ ἀμουσίαν καὶ ἀπειροκαλίαν, οὕς φησιν Ἀριστοῦ ξενος χολὴν ἐμεῖν ὅταν ἐναρμονίου ἀκούσωσιν... “...but the unmanly, whose ears are enervated through want of taste and ignorance of the beautiful, who, as Aristoxenus says, vomit bile when they come to listen to enharmonic music...” Without any context we cannot know whether the narrow conception of the ‘true’ = quartertone enharmonic is presupposed here, or any kind of music the broader public would have called enharmonic.

¹⁰⁹ Cf. above, p. 152 with n. 39. — One may wonder how Aristoxenus would admire Olympus’ ‘trichordal’ style (ps.-Plut., *Mus.* 1137b, see below, p. 436), i.e. obviously the *spondeion* tune, if its original form at least included wide *pykná*. Perhaps, because in the undivided form these were not true *pykná* anyway, and the music in question only the supposed precursor of the enharmonic; at any rate the passage in question focuses not on intervals, but on the restricted number of notes.

Be that as it may, Aristoxenus consciously counters the musical spirit of his age. And not only of his age: if our reconstruction is correct, the original enharmonic would have missed Aristoxenus' limits for the enharmonic by far, falling squarely within his chromatic. Is it not more than tempting to draw a direct line from Olympus' traditional airs and the 'old auletic *tónoi* system', based on three-quartertone *pykná* conceived as enharmonic, to the music of the late fourth century? I.e., to comprehend the true quartertone as the odd phenomenon, in terms of both ancient Greek musical history and the general musical predilections of mankind?¹¹⁰ All the more are we facing a conundrum. On the one hand, a traditional 'wide' enharmonic seems plausible both from a music-anthropological and an organological viewpoint, and it is supported by a number of sources; on the other, it cannot easily be denied that the harsh quartertones on which Aristoxenus insists, and which had gained such importance in the music-theoretical discourse of the fourth century, were also rooted in ancient musical practice. Did both exist side by side, and if so, can we circumscribe their respective spheres?

From what we know about the scale systems before Aristoxenus, a crucial point appears marked by the transition from the 'old auletic *tónoi*', with their badly modulating alignment in three-quartertone steps, to the beautifully modulating 'old commensurable system' and further to the Eratocleans. We have assumed that it was primarily the circle of the fifths that forced the latter two into the 'standard model' of tones and semitones, resulting in a new chromatic aulos design (in the modern sense of the word). A quartertone enharmonic would have been the inevitable consequence, at least in harmonic theory concerned with commensurability, but without doubt to a certain extent also in auletic practice. We have seen that the development of the musical notation is also barely comprehensible without the assumption of the same paradigm change: while its original alignment of enharmonic and diatonic notes suggests comparatively wide *pykná*, the identification of notes in the later modulating stage requires the 'standard' quartertone enharmonic. This evolution had apparently started with Pronomus in the second half of the fifth century, was of course inti-

¹¹⁰ For the artificiality of the (or specifically the ditonic?) enharmonic, cf. Aristox., *Harm.* 1.19, p. 25.2–4: τρίτον δὲ καὶ ἀνώτατον τὸ ἐναρμόνιον, τελευταίω γὰρ αὐτῷ καὶ μάλιστα μετὰ πολλοῦ πόνου συνεθίζεται ἢ αἴσθησις “the third and highest is the enharmonic; for perception gains acquaintance with it last and only with considerable effort”; Aristox. *ap.* Theon, *Util. math.* 56.1–3: ἔστι δὲ δυσμελωδητότατον καὶ [...] φιλότεχνον καὶ πολλῆς δεόμενον συνηθείας, ὅθεν οὐδ' εἰς χρῆσιν ῥαδίως ἔρχεται “[the enharmonic] is most difficult to sing, artificial, and requires long acquaintance, whence its use is also not acquired easily”.

mately connected with the transformation process termed 'New Music', and must have produced its more advanced diagrams in the first half of the fourth century.

This, now, was the music Aristoxenus heard in his youth, and it is the earliest music with which he could rightly claim direct acquaintance. Doubtless he was educated also in older music, but in this case, at least the microtonal shades of the melodies would very probably have relied on oral transmission. There was little chance of retrieving the exact size of a *pyknón* from the time of, say, Pindar, in an environment that had at its disposal neither the instruments for pitch measurement nor the means of writing down fine pitch relations. 'Period instruments' would have been of little use either: lyres bear no hint of their former tuning, and even if the *pykná* of auloi may be inferred from their make, they would hardly have supported Aristoxenus' case: as far as we see, no unearthed 'primitive' aulos from the period in question incorporated semitones. Admittedly, an explicit assertion of a tuning procedure in fifths and fourths might establish the necessary framework for a stringed instrument. But where we can determine the instrumental background of early evidence for the enharmonic, it is invariably the aulos. On top of this, the tuning procedure 'by consonance' for a true ditonic enharmonic on the old seven-stringed lyre is neither straightforward nor liable to produce good results, nor is it easy to see what musical advantage would be gained in this way.¹¹¹

For those who are not convinced by such organological considerations, here are some general thoughts, presupposing musicians who are entirely free in choosing their microtones (as are singers and, to a certain extent, lyre players). Within a living oral tradition of this kind, microtonal shadings such as the difference between a semitonal and a three-quarteritone *pyknón* would more easily change unnoticed than being preserved against a general stream. Contrasts must establish themselves in the minds before they can be handed down: consequently, an explicit assertion of a semitone *pyknón* as opposed to a wider variant is possible only once the two are used side by side. If this was the case already in archaic music, Aristoxenus might have had accurate information on fifth-century music, but would be wrong

¹¹¹ Cf. n. 34 on p. 115 above. For the enharmonic, typically one additional pitch must be established per *pyknón*. E.g., two conjunct tetrachords with numbering starting from the highest string: (1) tune 4 = *mésē* to its desired pitch: *a*; (2) tune 1 to a fourth above 4: *d*; (3) tune 7 to a fourth below 4: *e*; (4) tune 5 to a fifth below 1: *g*; (5) tune 2 to a fourth above 5: *c*; (6) retune 5 to a fifth below 2: *f*; (7) retune 2 to a fourth above 5: *b^b*; (8) tune 6 to a pitch between 5 and 7: *e¹*; (9) tune 3 to a pitch between 2 and 4: *a¹*. The overall change in string tension is here about twice as pronounced than in the diatonic example given in the cited n. 34, which involves only one retuned string.

in incriminating the higher *likhanós* as a modern depravation; more importantly, he would have to know so. On the other hand, if one of the two kinds of enharmonic was a newcomer, the evidence suggests that this was the quartertone type, for which the new preference for modulation had made the stage ripe just at the time in question, i.e. shortly before Aristoxenus was born.

All this said, we can revert to Aristoxenus' assertion of quartertones required for "virtually the most beautiful" music. On a superficial reading one might think that the notion of 'required' rests on an aesthetic judgement the author shares with other conservative minds. But this cannot be true, because Aristoxenus remarks that the fact could be made clear to everyone by some kind of guidance (ἐπαχθεῖσιν αὐτοῖς). The verb used here is the Aristotelian technical term for inductive reasoning, where a general truth is inferred from a number of examples. Of course Aristoxenus did not mean that such an inductive process would extend to the conclusion that the kind of music envisaged is "the most beautiful". This judgemental part of his sentence is no more than a side-thought; the issue at stake is not the evaluation of musical styles, but simply the existence or non-existence of a ditonic *likhanós*. How shall we interpret the apparent reference to induction? At first the sense might seem clear enough: since induction starts from experience gained from perception, one would merely have had to play some pieces from the styles in question to them. But this alone would not serve the purpose. If the size of the intervals as such was under dispute, the performance of a melody in any specific tuning would merely beg the question. Such a kind of inference would once more require original recordings. Generally a straightforward inductive method would have to rely on a consensus that the performance is 'correct'. How could Aristoxenus hope to establish such a consensus with the audience he envisions: people in principle open minded, but only accustomed to the contemporary wide *pykná*? Pure induction, it seems, would never serve the purpose. If we have a closer look at his words, however, we find a clear hint that Aristoxenus' line of reasoning would have included more than playing music. What he claims is not that people could be guided to accept the existence of music using a ditonic *likhanós*, but of music actually requiring it. Clearly such a conclusion must involve more than induction, even if it starts from known compositions. This view is corroborated by another occurrence of the same verb shortly preceding the passage under consideration. Here it stands in the context of the theorem that the highest diatonic interval is never smaller than a tone:

...παρὰ μὲν τῶν ἤδη κατανεοηκόντων τὸ διάτονον γένος [οὐχ] ὁμολογεῖται, παρὰ δὲ τῶν μήπω συνεωρακόντων συγχωροῖτ' ἂν ἐπαχθέντων αὐτῶν.
(Aristox., *Harm.* 1.22–23, p.29.10–12)

...is agreed among those who have already understood the diatonic genus, and those who do not yet have a clear view of it would concede the fact if they are guided there.

Unambiguously, the question is not about taste, but about pitch relations that can be, and are, grasped by a rational process, possibly supported by the use of diagrams. So much is made clear by the other verbs, which refer to the intellectual and even the visual sphere. Accordingly, the verb ἐπαγγεῖν denotes merely the necessary starting point for the argument: actual diatonic music.¹¹²

In short, Aristoxenus holds that one could base inescapable arguments for the necessity of a quartertone enharmonic on features of older music that were not open to dispute.¹¹³ Such arguments would typically rest on the nature of the concords and on facts such as the identification of notes in different context. More concretely, it is hard to see what could settle the case other than a reference to the requirements of modulation. Only the perfect commensurability of the 'standard' genera ensures a perfect freedom of modulation between the three and at the same time between different keys, without introducing an entirely confusing and impractical host of pitches. This fact could easily have been shown with the help of a diagram, for instance by pointing out the required identification between the Dorian *mésē* and the Lydian enharmonic *likhanós* (cf. Diagram 5 on p.24). Nevertheless, the argument would have to start from compositions that put such identifications into actual use, compositions, that is, which featured the enharmonic fully embedded in their tonal structure. It seems that such

¹¹² One might wonder which kind of rational argument Aristoxenus envisaged for determining the upper limit of the diatonic *likhanós*: I can think of none that would actually show that the highest interval in the tetrachord cannot be smaller than a whole tone (cf. *GMW* II: 141 n.88). But in fact this is not the question, as the analogy to the discussion of the other boundary shows: the problem is to push the limits as far as necessary, not to constrain them. Thus Aristoxenus does not try to show that the highest interval cannot be larger than a ditone, but only that it can be as large. Similarly, he requires no proof that it cannot be smaller than a tone, but only that it can be as small (a question that was not touched upon by earlier *harmonikoi* since these had been dealing merely with the enharmonic). Thus, arguments could be based on the fact that the diatonic can be tuned 'by consonance', and also on the relation of diatonic and modulating notes (e.g. *nētē synēmménōn* and diatonic *paranētē diezeugménōn*).

¹¹³ One must not be blinded to the notion of inescapability by the potential mood (optative with ἔν): it signals the potentiality of the protasis (it is not warranted that instruction will actually take place), while the assertion that once the protasis is given the apodosis must inevitably follow is expressed by μέντοι.

music was no longer typical for the late fourth century; probably Aristoxenus would have taken his examples from an earlier generation.

At any rate such a proof would be necessary merely for those “those who are familiar solely with the currently dominating music”: familiar, it seems the most natural interpretation, in terms of aural acquaintance rather than theoretical analysis. In contrast, no further proof is needed for “those who are acquainted with the old-fashioned *trópoi*”. Is it here also mere practical acquaintance that elevates the quarter-tonal nature of the enharmonic beyond doubt? In other words, would Aristoxenus express his confidence that everybody familiar with performances of some older kind of music would, solely on the basis of their auditory judgement, determine the true nature of its intervals? This is very doubtful; after all, he was well aware of the disagreement between older theorists as regards the nature of the enharmonic: although none of them had posited more than one enharmonic fine tuning, they had assigned different interval sizes to it.¹¹⁴ So we are once more bound to search for a more substantial background. Would familiarity with the “old-fashioned” *trópoi* imply some theoretical knowledge?¹¹⁵

But what are *trópoi*? In general, the singular *trópos* can designate a style, a way to do something, while the plural refers typically to a person's manners, the ‘ways’ through which the character expresses itself. A specific musical use is found especially in literature from the Roman era, where *trópoi* is equivalent to *tónoi*.¹¹⁶ This particular sense is not attested in the remains of Aristoxenus' work, which only refer to *tónoi*; but this does of course establish no *terminus post quem*, especially since the *Harmonics* break off before the relevant chapters are reached. After all, we find Aristoxenus' famous diagram referenced as the ‘*diáγραμμα polýtropou*’:¹¹⁷ within the compound adjective, it more likely that an original designation was preserved.

From the semantic background of the terms, *trópos* would appear the older, and at any rate the more general, less technical. While a conception

¹¹⁴ Aristox. *ap.* ps.-Plut., *Mus.* 1143e; see p. 381.

¹¹⁵ The notion of ‘familiarity’ alone does not suggest a solely practical acquaintance; in Aristoxenus, the verb *συνεθίζομαι* pertains to the theoretical sphere quite as well: for rational analysis: *Harm.* 2.35, p. 44.20–1: μήτε συνεθίσθαι περὶ τὰς τοιαύτας διαφορὰς ἀκριβολογεῖσθαι; perception: 1.19, p. 25.3–4: συνεθίζεται ἡ αἴσθησις (on the enharmonic; cf. Aristox. *ap.* Theon, *Util. math.* 56.1–3: συνήθεια) – but thrice the simplex in 2.33, p. 42.13–21; both: 2.34, p. 44.5: συνεθισθῆναι τὴν τε δianoian καὶ τὴν αἴσθησιν.

¹¹⁶ Cf. e.g. two passages from Plutarch, where the two terms are treated as exchangeable, but not quite identical to ‘*harmonía*’: *An seni* 793a: πολλῶν τόνων καὶ τρόπων ὑποκειμένων φωνῆς, οὓς ἀρμονίας οἱ μουσικοὶ καλοῦσι; *De E ap. Delph.* 389e: εἶτε τόνους ἢ τρόπους εἶθ' ἀρμονίας χρῆ καλεῖν. Besides, *trópos* maintains the general sense of ‘style’ in musical context also; cf. e.g. Aristid. *Quint.* 1.12, p. 30.1–4; so probably also in Aristox., *Harm.* 2.40, p. 50.16: τοὺς τῶν μελοποιῶν τρόπους.

¹¹⁷ Cf. n. 9 on p. 3 above.

of *tónoi* presupposes a functional analysis of scales establishing their interrelations in terms of pitch, a recognition of ‘styles’ requires no more than the existence of different types of music within the same cultural horizon. And while it is perfectly possible that a technical notion of ‘*tónoi*’ was introduced besides the non-technical ‘*trópoi*’, it is far from likely that the diffuse ‘*trópos*’ would have been adopted once the clear-cut ‘*tónoi*’ had established themselves in music-theoretical discourse. This assumption is bolstered by a number of passages dating well before Aristoxenus, above all Pindar’s reference to a ‘*lydós trópos*’.¹¹⁸ Especially noteworthy is Critias’ epigram on Alcibiades, where we find *trópoi* in the plural. Although the surface context is rhythmical, the imagery clearly evokes the connotation of pitch systems:¹¹⁹

καὶ νῦν Κλεινίου υἱὸν Ἀθηναῖον στεφανώσω
 Ἀλκιβιάδην νέοισιν ὑμνήσας τρόποις·
 οὐ γὰρ πῶς ἦν τοῦνομ’ ἐφαρμόζειν ἔλεγγείῳ·
 νῦν δ’ ἐν ἰαμβείῳ κείσεται οὐκ ἀμέτρως.
 (Critias *ap.* Heph. 2.3, p. 9.12–15)

And now I shall crown Cleinias’ son, from Athens
 Alcibiades, singing of him in new *trópoi*.
 Since it was impossible to adjust (*epharmózein*) his name to a distich,
 it will now rest in an iamb, not unmetrically.

On a more general level, the notion of a new ‘style’ of music as opposed to the traditional one had established itself before the last decade of the fifth century:

ἄγε δὴ πότερα βούλεσθε τὴν νῦν διάθεσιν
 ᾠδῆς ἀκούειν, ἢ τὸν ἀρχαῖον τρόπον; (Eupolis *ap.* *Suda*, s.v. βασιτάσας)
 Now, do you want to hear a song in the current way of composition, or
 rather the old style (*trópos*)?

About a century later, Aristoxenus draws a very similar distinction between two styles, dubbing them by the names of famous proponents. The passage is also of the highest importance for our discussion:

¹¹⁸ Pind., *Ol.* 14.17; cf. 3.4: νεοσίγαλον τρόπον; Plato, *Rep.* 424c: τρόπον ᾠδῆς νέον ... οὐδαμοῦ γὰρ κινουῦνται μουσικῆς τρόποι ἄνευ πολιτικῶν νόμων τῶν μεγίστων. In Hippocr., *De diaeta* 1.8, ‘*tónos*’ seems to mean ‘tuning’, which is much more practical than the notion of ‘key’ later associated with it, but still more technical than ‘*trópos*’.

¹¹⁹ Cf. also Aeschyl., *Prom.* 310–11: γίγνωσκε σαυτὸν καὶ μεθάρμοσαι τρόπους | νέους “know thyself, and adjust (*metharmózein*) your young manners (*trópoi*)”.

τῶν γὰρ κατὰ τὴν αὐτοῦ ἡλικίαν φησὶ Τελεσίᾳ τῷ Θηβαίῳ συμβῆναι νέῳ μὲν ὄντι τραφῆναι ἐν τῇ καλλίστῃ μουσικῇ, καὶ μαθεῖν ἄλλα τε τῶν εὐδοκιοῦντων καὶ δὴ καὶ τὰ Πινδάρου, τὰ τε Διονυσίου τοῦ Θηβαίου καὶ τὰ Λάμπρου καὶ τὰ Πρατίνου καὶ τῶν λοιπῶν ὅσοι τῶν λυρικῶν ἄνδρες ἐγένοντο ποιηταὶ κρουμάτων ἀγαθοί. ... παραλλάξαντα δὲ τὴν τῆς ἀκμῆς ἡλικίαν, οὕτω σφόδρα ἐξαπατηθῆναι ὑπὸ τῆς σκηνικῆς τε καὶ ποικίλης μουσικῆς, ὡς καταφρονῆσαι τῶν καλῶν ἐκείνων ἐν οἷς ἀνετράφη, τὰ Φιλοξένου δὲ καὶ Τιμοθέου ἐκμανθάνειν, καὶ τούτων αὐτῶν τὰ ποικιλώτατα καὶ πλείστην ἐν αὐτοῖς ἔχοντα καινοτομίαν ὀρμήσαντά τ' ἐπὶ τὸ ποιεῖν μέλη καὶ διαπειρώμενον ἀμφοτέρων τῶν τρόπων, τοῦ τε Πινδαρείου καὶ τοῦ Φιλοξενείου, μὴ δύνασθαι κατορθοῦν ἐν τῷ Φιλοξενεῖῳ γένει· γεγενῆσθαι δ' αἰτίαν τὴν ἐκ παιδὸς καλλίστην ἀγωγὴν. (Aristox. *ap. ps.-Plut., Mus.* 1142bc)

Thus [Aristoxenus] tells about what happened to a contemporary of him, Telesias of Thebes, who was in his youth educated in the most excellent music, learning, among other works of notable men, those of Pindar, Dionysius of Thebes, Lamprus, Pratinas and the rest of the lyric poets who were also composers of good instrumental parts. [...] But when he had passed the prime of his life, he was seduced by the complex music of the theatre to such a degree that he came to despise that excellent stuff on which he had been brought up, but learned that of Philoxenus and Timotheus, and particularly their most complex items, those incorporating the highest degree of innovation. And when he set out to compose music and tried in both styles (*trópoi*), that of Pindar and that of Philoxenus, he was unable to succeed in the Philoxenean kind. And the reason for this was his most excellent training from childhood on.

Philoxenus, who is here chosen as the prime representative of the later style cannot have been much older than twenty when Eupolis wrote his lines, and can hardly have been among its famous exponents already in that time. Surprisingly, the Pherocrates fragment does not mention him at all¹²⁰ – perhaps because Philoxenus' music was quite as advanced as that of Timotheus, so that it was impossible to fit both into the scheme of stepwise ruin constructed there? In any case, the perception of an ongoing musical revolution was, quite naturally, older than the figures which eventually became iconic for it: Philoxenus, Timotheus and Telestes.¹²¹

With all their emphasis on the old and the new, these passages only know about this single opposition. In the *Harmonics*, however, we found Aristoxenus citing, as evidence for his adored quartertone enharmonic, “the

¹²⁰ Pherocrates *ap. ps.-Plut., Mus.* 1141d–1142a; cf. n. 97 on p. 87 above.

¹²¹ In this sequence, the names are given in Dionys. Hal., *Comp. verb.* 19 (see above, n. 59 on p. 389). Telestes and Philoxenus appear as the classics of the dithyramb (analogous to the three major tragedians) in a list of works sent to Alexander the Great: Plut., *Alex.* 8. Crexus, Timotheus and Philoxenus are named in *ps.-Plut., Mus.* 1135d.

first and second of the old-fashioned *trópoi*”, obviously assuming that at least some of his readers would be familiar with such a conception. Does it refer to a recognised distinction within the music before the ‘New Music’?

Certainly it cannot mean the enharmonic with and without divided *pykná*, as is often assumed.¹²² Firstly, the *spondeíon*, on which the awareness of the latter is based, was particularly associated with three-quarter-tone intervals, at any rate in its higher range. Secondly, we have repeatedly emphasised that the texts do not support the theory of an ‘older enharmonic’ at all. The *Harmonics* clearly refer to some widely recognised musical reality, readily citable by the given designation as “the first of the old *trópoi*”, which demanded no further explanation. But the assumption that the Greek public was aware of such an archaic style is hopelessly at odds with the discussion of the *spondeíon*.¹²³ One of the causes we have already mentioned: there would be no motivation for singling out this particular composition if there were others of the same undivided enharmonic style and of the same assumed age (it goes without saying that, on the other hand, the *spondeíon* tune alone could not establish a notion such as ‘first *trópoi*’). Also, we would reasonably expect such a style to be referred to in a similar way as in the passage from the *Harmonics*, if it were identical with the music cited there. The contrary is the case. In fact the wording suggests, firstly that the undivided nature of the *spondeíon pyknón*, if played in an old-fashioned way, was not a commonly known fact at all, and on top of this, that the unaware listener would not necessarily notice the lack of an intermediate note, which is attributed more to the intention of the player (βούλεται εἶναι) than to the sound produced. In any case, the fact that Aristoxenus found it necessary to induce evidence for the incomposite semitone at this point sufficiently shows that he could not build on an established notion of an ‘older enharmonic’ such as modern scholarship has constructed.

Thus the two ‘*trópoi*’ must refer to music belonging to two commonly recognised classes, separate from each other as well as from the respective category in contemporary music. Yet we never get the impression that Aristoxenus drew such a distinction within the ‘old music’, let alone that it was commonly recognised. The nearest we find stands within a comparison of moderate rhythmical innovation in the archaic age with the shameless practice of Philoxenus’ time:

προτέρα μὲν γὰρ ἢ Τερπάνδρου καινοτομία καλὸν τινα τρόπον εἰς τὴν μουσικὴν εἰσήγαγε· Πολύμνηστος δὲ μετὰ τὸν Τερπάνδρειον τρόπον καινῶ

¹²² Most recently, Barker 2007: 297.

¹²³ Ps.-Plut., *Mus.* 1135b (cf. above, pp. 397ff.).

ἐχρήσατο, καὶ αὐτὸς μέντοι ἐχόμενος τοῦ καλοῦ τύπου, ὡσαύτως δὲ καὶ Θαλήτας καὶ Σακάδας ... ἔστι δὲ (καί) τις Ἀλκμανικὴ καινοτομία καὶ Στησιχόρειος, καὶ αὗται οὐκ ἀφεστῶσαι τοῦ καλοῦ. (Aristox. *ap. ps.-Plut., Mus.* 1135c)

In the beginning, the innovations of Terpander introduced a certain beautiful style into music. After Terpander, Polymnestus made use of a new style; but he also maintained the beautiful shape; similarly, Thaletas and Sacadas. ... And there is also innovation by Alcman and by Stesichorus, again without departing from the beautiful.

Here we learn of different ancient *trópoi*, but certainly not of a binary distinction: quite naturally, each composer had his own style. There is also an important grammatical difference. Whenever the texts talk about styles in this general sense, the singular *trópos* is used for the single instances. But the passage from the *Harmonics* says not 'the first and the second *trópos*', but "the first and the second *trópoi*" (τῶν ἀρχαϊκῶν τρόπων τοῖς τε πρώτοις καὶ τοῖς δευτέροις): whatever the first and the second are supposed to be, both are '*trópoi*' in the plural. Again, we never learn of such an outstanding change within the 'ancient' music as might justify such an expression. On the contrary, all its individual styles were readily subsumed under the inconspicuous singular of 'the ancient *trópos*'.¹²⁴

All this adds another enigma to Aristoxenus' assertion of the quarter-tone enharmonic: not only is it at variance with other evidence, we do not even see to what kind of evidence he is pointing. While the designation as "most excellent" (καλλίστη) can hardly refer to anything but music before the notorious innovations towards the end of the fifth century, the two groups of *trópoi* appear to contradict Aristoxenus' broadly uniform view of 'the' archaic style. On top of this, we ought to remember, Aristoxenus thinks that the necessity of true quartertones could be established by inescapable arguments. How can these riddles be solved?

The solution, I think, lies in a separation between the age of the "most excellent" music and the *trópoi*. That the latter did not belong to the times of Pindar and before is signalled by their description not as *arkhaíoi*, 'old', but as *arkhaíkoí*. In general, *arkhaíkos* does not imply a specific age,¹²⁵ but merely expresses the opposition to the 'modern' practice, frequently with a connotation of austere simplicity: it denotes the old fashioned, whether the

¹²⁴ Cf. *Ps.-Plut., Mus.* 1142c: εἰ οὖν τις βούλεται μουσικῆ καλῶς καὶ κεκριμένως χρῆσθαι, τὸν ἀρχαῖον ἀπομμεῖσθω τρόπον... "thus anyone who aims at beauty and discrimination in his treatment of music should model himself on the ancient style" (trans. Barker).

¹²⁵ Cf. also the employment of οἱ παλαιοί, 'the old ones', in *Aristox. ap. ps.-Plut., Mus.* 1143e (see p. 381): used interchangeably with οἱ πρὸ ἡμῶν, 'those before us', it designates the theorists up to Aristoxenus.

speaker is sympathetic with it or not. Apart from the passage under discussion, there are two instances of how Aristoxenus uses this term. One is the reference to the older way of playing the *spondeion* without a divided *pyknón*, i.e. in contrast to more ‘modern’ performances.¹²³ The other, following shortly after the passage quoted above, strikes a familiar chord:

τὴν γὰρ ὀλιγοχορ(δ)ίαν τε καὶ τὴν ἀπλότητα καὶ σεμνότητα τῆς μουσικῆς παντελῶς ἀρχαίκην εἶναι συμβέβηκεν. (Aristox. *ap.* ps.-Plut., *Mus.* 1135d)

But the use of only a few notes, and the simplicity and austerity in music has come to be entirely old fashioned (*arkhaiké*).

Here one could of course not insert the term ‘*arkhaios*’ instead. Certainly the ancient style is ancient, but this alone does not make it old-fashioned. In Aristoxenus’ view, the ancient style had already been old in Pindar’s time. As ‘old fashioned’, however, it was only perceived once an entirely new type of music had set itself against it. Aristoxenus, like other partisans of the ancient style, invariably refers to it by *arkhaios*, thus avoiding any notion of it having been replaced by something equally valuable (the quoted passage is only an apparent exception, since it refers to, and implicitly criticises a common perception).¹²⁶ In view of the numerous examples for this convention, it is hardly conceivable that he should have designated the mysterious two groups of *trópoi* as *arkhaikói*, had these really been styles belonging to the ancient music.

Consequently, we have to dissect Aristoxenus’ argument as follows. At first he states his theorem: the highest interval in the tetrachord can be as large as a ditone. This fact, which pertains to the ancient style, but not to contemporary musical practice, can be gleaned from two groups of *trópoi*, which have gone out of fashion, but are still known to some; for people not familiar with these, sufficient evidence could be supplied.

As already noted above, the assertion that a ditonic *likhanós* is not only required by some kinds of music, but virtually by the most excellent, is to be understood as a parenthesis. A rational argument within the scope of the harmonic science may prove its necessity, but it cannot decide about aes-

¹²⁶ Aristox. *ap.* ps.-Plut., *Mus.* 1132e: παρανομῶν εἰς τὴν ἀρχαίαν μουσικὴν; 1133d; 1137f: τὸν Πινδάρειον τε καὶ Σιμωνίδειον τρόπον καὶ καθόλου τὸ ἀρχαῖον καλούμενον ὑπὸ τῶν νῦν “the style of Pindar and Simonides, and generally that which is now called the ancient”; 1144e: τὸ σεμνὸν καὶ ἀπερίεργον τῆς ἀρχαίας μουσικῆς “the dignity and abstinence from over-elaboration inherent in the ancient music”; *ap.* Themistius, *Or.* 364b; cf. also ps.-Plut., *Mus.* 1145f. This was of course common terminology; cf. Glaucus’ work *περὶ τῶν ἀρχαίων ποιητῶν τε καὶ μουσικῶν*, “on the ancient poets and musicians” (ps.-Plut., *Mus.* 1132e; 1133f).

thetic or ethic superiority.¹²⁷ Similarly, the evidence from the *trópoi*, mentioned only afterwards, need not apply to the parenthetical judgement. Thus there is no reason to rashly associate the “old-fashioned” *trópoi* with the ‘ancient’ music; in Aristoxenus’ view, the former may contain merely an echo of the latter’s original quartertone enharmonic.

All this suggests that the *trópoi* are pitch structures, governed by comprehensible principles, conceived by Aristoxenus as belonging to a period after the start of the ‘New Music’, but already half-forgotten when he wrote; this places their origins between, say, 430 and 350 BC. It also seems it was possible to facilitate deductions within these systems by displaying their inherent relations in diagrams. We have learned that several rivalling attempts at systematising the traditional scales were devised precisely in this period: the two *tónoi* systems we have dubbed the ‘auletic’ and the ‘commensurable’ as well as the seven octaves of the Eratocleans (and perhaps even another one that comprehended eight scales). All these are arrangements of what Aristoxenus usually terms ‘*tónoi*’. But the alternative designation of *trópoi* was closer to their original modal character, and thus very probably the older; so it would be no wonder if these ‘*tónoi* systems’ were actually known as systems of ‘*trópoi*’.¹²⁸ If one superseded another, it would have been natural to distinguish ‘old’ from ‘new *trópoi*’ – always in the plural, just as Aristoxenus has it. And of course Aristoxenus would, in a passage like that, refer to them by the customary term, at least if he wanted to make himself understood without tedious explanations.¹²⁹

Overall, it appears most plausible that Aristoxenus’ “old-fashioned” *trópoi* were of such a nature. Can we identify them? Unfortunately, one of the most important factors escapes us: we do not know which arrangement of *tónoi* had won general recognition by Aristoxenus’ time. Thanks to the nature of our evidence, which builds mainly on Aristoxenus’ indulgence in his predecessors’ shortcomings, we know less of their systems, the closer these had come to his great edifice of a universal harmonic theory. From what we know, two options appear possible. If the final part of the fourth century already knew an arrangement of eight keys like that quoted by

¹²⁷ Cf. Barker 2007: 235, for enlightening comments on the crucial adjective *καλός* and Aristoxenus’ abstinence from its use in the rest of the *Harmonics*, to whose scope evaluative judgements do not pertain.

¹²⁸ A still largely modal character of the pre-Eratoclean diagrams appears suggested by their unmistakable associations with the clearly modal scales transmitted by Aristides Quintilianus.

¹²⁹ Different is the case of the passage where Aristoxenus gives his short account of the two old systems (*Harm.* 2.37–8, p. 46.17–47.16; cf. pp. 379ff.). Here the context is the enumeration of the parts of harmonic science, which at the same time lays out the structure of the following chapters. Consequently the focus is on Aristoxenus’ own conceptions, and the term *tónoi* is used throughout.

Ptolemy and Boethius, the two outdated ones might have been our ‘old commensurable *tónoi* system’ and that of the Eratocleans. Both were built on a quartertone grid, and produced modulating diagrams on which the necessity of these quartertones was readily demonstrable, just as the text appears to demand. The even older ‘auletic *tónoi* system’, in contrast, would no longer have been recognised: no one living had experienced performances in Pronomus’ original style. Naturally learned Aristoxenus could cite it as an example of a particularly weird approach, but it would not belong to the known couple of outdated *trópoi*.

There is an alternative option, although it appears less likely. If the Eratocleans’ system was prevailing, or the prevailing system perceived as the continuation of their work, the two *trópoi* might be our ‘auletic’ and ‘commensurable’ system. At least, this provides a certain symmetry, since these would always appear together. Also, the Eratocleans seem to have emphasised the conception of their octaves as *harmoníai*; this does not however preclude the use of the term ‘*trópoi*’ in the context of their arrangement of keys. But of course the older ‘auletic’ system, which is built on wide auletic *pykná*, does not support the notion of quartertones at all. Even so, one might reconcile the present interpretation with the text. If each of the two *trópoi* used quartertones, one might argue, why should Aristoxenus demand that one be familiar with both? Should he not have said, in that case: “acquainted with the old-fashioned *trópoi*, the first or the second ones”, instead of “and”? The answer is, not necessarily: since we are not dealing with formal logic, it is not problematic to understand the sentence as “what is said is clear to those acquainted with the first *trópoi* as well as to those acquainted with the second *trópoi*”. Even so, the strict interpretation is not impossible either. It would impart a quite different meaning to the passage: those who are familiar with both the ‘first’ and the ‘second’ *trópoi* will know, by comparison, that only an enharmonic with quartertones yields a meaningful tonal structure. But this reading appears less natural.

If the foregoing considerations are at least in principle right, they corroborate the suspicion that Aristoxenus could not supply evidence about the original performance of the truly ancient styles, several decades before he received his education. So from where would his personal conviction derive that it involved true quartertones, after all? Possibly, from an erroneous extrapolation. If the chromaticism that resulted from modulating instruments had brought about contracted enharmonic *pykná* the size of a semitone, it is not unlikely that musicians also used these in performances of older pieces, instead of switching to outdated instruments. Thus Aristoxenus might have learned to accept and appreciate this harsh type of

enharmonic, which occurred only occasionally in modern compositions, as typical for the ancient style. His character enabled him to stick to this view even when contradicted by the entire musical world, in which the enharmonic could eventually survive only in its less rigid form (we do not know, for how long).

A notable characteristic of this evolution was the separation of theory and practice. Almost certainly, what we know as the 'genera' was originally associated not only with scale forms and interval sizes, but also with different styles, instruments and performance contexts. Within the abstraction of his grand unified theory, Aristoxenus had to reduce all this musical variety to differences of pitch, at least for a start. As a consequence, overlapping interval sizes between different genera – as such readily recognisable in performance – had to be eliminated. What certain previous theorists had regarded as the typical enharmonic became now a form of chromatic. One motive for this was perhaps the traditional agreement that there is only one variant of the enharmonic: Aristoxenus basically maintained this theorem (although allowing for the tiniest of variations), adopting the special form of the more recent theories, which worked with quartertones. It is apparent that his viewpoint was already well prepared by his precursors; anyway, he could hardly evade following them regarding the identifications of notes between different genera and keys, which were prescribed by the ditone that ensues from the circle of fifths. After all, the requirements of theory might also have filtered his view on the music of the past.

LOST 'MODES'

When Greek authors look back on the music of the archaic era, they establish various conceptions of how the modes relate to each other. Sometimes one gets the impression that Dorian and Phrygian are the main antagonists.¹³⁰ More technical testimonies, however, group these with Lydian into

¹³⁰ Most prominently, in a model cited by Aristotle (*Pol.* 1290a): there all other '*syntágmata*' are attributed to either Dorian or Phrygian as major categories. From the context it becomes clear that the underlying musical reality need not have been more intrinsically dichotomic than the directions of the winds, which were similarly categorised into northern and southern: the passage can hardly support radical theories such as the identification of Dorian with enharmonic (Rocconi 1998: 360) or an-hemitonic pentatonic (Roch 2001) as opposed to diatonic Phrygian. The special demands of a non-musical context may contrast other modes: cf. Plut., *De prof. in virt.* 83f (Dorian and Lydian). In Telestes, *ap. Ath.* 617b, the Lydian of a Phrygian aulete is opposed to Dorian – whence Henderson (1957: 386) wanted to infer a general identity of Lydian and Phrygian.

a sort of canonical triad. This account may be suspected as a backward projection, since the same triad underlies the older part of the notation – but it is backed by references to both the aulos and the lyre, in the auletic *nómos trimelês* and Pythagoras of Zacynthus’ ‘tripod’ chordophone. Thirdly, Heraclides Ponticus promoted the construction of a purely Hellenic triad of Dorian, Aeolian and Iastian.¹³¹ The Mixolydian did not fit in anywhere, and it has ever been wondered what kind of mixture its name alludes to. Finally there are references to some Locrian, purportedly employed for some time in the early fifth century.¹³²

Iastian¹³³ and Mixolydian are discussed by Plato (and reflected in Aristides’ scales of these names), but not the then obsolete Locrian, nor an Aeolian. In fact, a mode of the latter name was also no longer recognised in the fourth century. This transpires from Heraclides, who is able to identify it only by quoting from earlier poetry. The term ‘Locrian’, in contrast, was preserved within the system of octave species – as an alternative for ‘Hypodorian’.¹³⁴

Thanks to this tradition we get a rough impression of a ‘Locrian’ scale. Octave species were the realm of Eratocles. There is little doubt that ‘Locrian’ was the older and therefore original name, deriving from the ancient modal scale that resembled the corresponding species best. The designation of the species in question as ‘Hypodorian’, on the other hand, became possible only when the primary Dorian, Phrygian and Lydian were supplied with a symmetrical set of ‘Hypo-’ keys. This is the design of Aristoxenus’ system, and probably his invention. The structural correspondence of octave species and *tónoi* inevitably brought about the renaming of the former. All the more remarkable is it that the older designation survived into the

¹³¹ Heraclid. Pont. *ap.* Ath. 62.4c–62.6a, reflected in Pollux 4.65 (cf. above p. 61 n. 22), and probably in the assignment of the tribal names to the chromatic keys of the notation (above p. 4); cf. *AGM*: 183–4. Heraclides explicitly opposes the established notion of a Phrygian and a Lydian *harmonía* (cf. the otherwise related thoughts expressed in Plato, *Lach.* 188d). Isolated random sets of *tónos* names are found in non-musical contexts: Themistius, *Or.* [περὶ τοῦ προσέχειν] 336a (Dorian, Phrygian, Iastian); Ioann. Philop., *in de An.* 1.47.18 (Lydian, Phrygian, Iastian).

¹³² Ath. 62.5c; Pollux 4.65; Schol. Pind., *Ol.* 10.18b (Locrian *harmonía* introduced by Xenocritus of Locri); cf. Pind., fr. 125.

¹³³ Especially in older literature, one encounters the assertion that Iastian is to be equated with the later Hypophrygian. It goes back to Boeckh 1814: 225–8, who assigned an octave species to every *tónos*, needlessly extending Ptolemy’s approach to the Aristoxenian systems, and mistaking the re-assigned term “Iastian” of the latest stage of the notation for the fifth-century modal scale of this name. For what truth there is in the alleged relation, in Ptolemy’s octave-species-based *tónoi* his “Hypophrygian” describes the cithara tuning that was actually notated in the Iastian key. No old Iastian is therefore reflected in the later Hypophrygian, but the late designation “Iastian” (for Aristoxenus’ “Lower Phrygian”) became applied to a tuning that incorporates the older Hypophrygian octave species.

¹³⁴ Cleonid. 9, p. 198.13; Bacchius 77, p. 309.8–0009; Gaud. 19, p. 347.10.

handbooks of late antiquity: obviously the idea of the octave species had already gained wide recognition before Aristoxenus. Now since 'Locrian' is an Eratoclean term and Eratocles' school was concerned only with the enharmonic, the archaic Locrian mode must have corresponded to a scale not entirely unlike:



The case of the Aeolian is less clear. The main example Heraclides quotes is a hymn by Lasus of Hermione, whose opening lines refer to this *harmonía*. The hymn was still sung in Heraclides' times, who takes it for granted that the melody he heard was the original. The musical reference system had however changed, and the composition was now commonly perceived as "Hypodorian".¹³⁵ In Heraclides' view, this 'double designation' is perfectly justified, because he found the Aeolians comparable to the Dorians in character (the melodies reflecting the peoples' manners). Heraclides' analysis is inspired not only by a favour for ethnic generalisation but also, it seems, by a certain contempt for technical matters, probably paired with a lack of respective expertise. Still, he may have a point: in an epinician ode, Pindar refers to "Aeolian song" after having called for the "Dorian lyre". This may indicate that the two designations were applicable to cognate or compatible types of music.¹³⁶ But there was a rival explanation for the apparent equivalence of 'Aeolian' and 'Hypodorian', based on more technical conceptions, which Heraclides may have found in a musical treatise, and which he finds he cannot pass over tacitly:

πρότερον μὲν οὖν, ὡς ἔφην, Αἰολίδα αὐτὴν ἐκάλουν, ὕστερον δ' ὑποδώριον ὡσπερ ἔνιοι φασιν, ἐν τοῖς αὐλοῖς τετάχθαι νομίσαντες αὐτὴν ὑπὸ τὴν Δωρίον ἄρμονίαν. (Ath. 625a)

Now, as I [Heraclides] said, they called it first Aeolian, but later Hypodorian: as some say, because they considered it to be placed, on the auloi, below the Dorian *harmonía*.

¹³⁵ Ath. 624f: ταῦτα δ' ἔδουσι πάντες ὑποδώρια [τὰ μέλη] "and this [composition] is sung in Hypodorian by everybody".

¹³⁶ Pind., *OL* 1.17–18: ἀλλὰ Δωρίαν ἀπὸ φόρμιγγα πασσάλου λάμβαν'; 100–3: ἐμὲ δὲ στεφανῶσαι κείνον ἱπιπῶ νόμῳ Αἰοληίδι μολπᾶ χρή. However, when taken "from its peg", a lyre is not yet tuned to any *harmonía* (Gal., *Trem.* 7.639–40 Kühn; Plut., *Lib. educ.* 9c; *Gen. Socr.* 589d; Dio Chrys. *ap. Stob.* 4.19.46 (= 62.46 Gaisford/Meineke); cf. also Plut., *Reg. et imp. apophth.* 175ab); thus "Dorian" should not rashly be understood as describing a musical mode. Note also that in the first passage the court in Dorian Syracuse is focussed. For Aeolian in Pindar cf. also *Pyth.* 2.69 (seven-stringed lyre); *Nem.* 3.79 (aulos). Cf. Henderson 1957: 383; Anderson 1994: 88–92 (discussing the ancient confusion between Αἰολ- 'Aeolian' and αἰολ- 'eluding exact perception by swift variation').

Although the conception of pitch as ‘high’ and ‘low’, i.e. as corresponding to spatial arrangement along a vertical axis, was not very developed in Greek antiquity, ‘below’ (*hypó*) can here only mean ‘lower in pitch’.¹³⁷ Taken literally, a designation as ‘below Dorian’ can apply to any scale which is perceived as lower in any respect; but it can originate only under certain conditions: either if the scale in question is the only one lower than Dorian, or if it otherwise resides immediately below Dorian in a defined series, or if it is not only lower but related to Dorian in another respect. The last is the case with Aristoxenus’ Hypodorian, which relates to Dorian just as Hypophrygian does to Phrygian, Hypolydian to Lydian. As we have seen, this results from a relatively late systematisation, and is not true for the early schemes. In principle, it is chronologically not impossible that Heraclides refers to Aristoxenus; but in the present case, he speaks of a terminological evolution that had taken place long before. Apart from that, Aristoxenus’ system is no longer based on immediate organological considerations. The first possibility, Hypodorian as the lowest and Dorian the second lowest scale, is hardly an option either, since all known schemes allocate more than one scale below the Dorian. So there remains the third alternative, that Hypodorian was the lower neighbouring scale of Dorian. This is indeed the case in the ‘old auletic *tónoi* system’. Its identification as the ultimate origin of the cited opinion is chronologically unsuspecting, since it leaves room for the source quoted by Heraclides that transmitted, or hypothesised about, the motives of the new designation (Glaucus of Rhegium?). The presumed auletic background concords with our inferences about the ‘auletic system’. On top of this, the passage offers a motivation for the otherwise intractable fact that this system’s Dorian and Hypodorian are separated by three quarters of a tone, rendering modulation between the two impossible. If ‘Hypodorian’ was incorporated as an already

¹³⁷ On the evolution of the vertical conception, cf. Rocconi 2002, where a discussion of ‘*hypó*’ and ‘*hypér*’ is however missing. Originally the latter denotes excess regardless of pitch direction: ‘*hyperypátē*’, introduced almost certainly not later than the fifth century, is a new lowest string; but the *hyperboláion* tetrachord is high-pitched: the adjective is used by Pherecrates (ps.-Plut., *Mus.* 1142a) in the fifth century. Here belongs also ‘*Hypertonidēs*’ (cf. n. 48 on p. 73 above), although with unknown implications. Aristoxenus’ ‘Hypermixolydian’ in the late fourth century still need not testify to verticality, while the Heraclides passage, together with the ‘Hypodorian’ and ‘Hypophrygian’ of the old *tónoi* systems, rather implies it for ‘*hypó*’ in the early fourth century at least. When in the final system ‘Hypo-’ and ‘Hyper-’ scales came to stand in opposition, the latter had eventually become re-interpreted in terms of the vertical conception. Possibly the analogy was encouraged by the introduction of musical diagrams (whereas mere note lists usually proceed from low to high pitch, so that the higher pitches stand at a lower position on the page, the ‘wing-shaped’ diagrams of *tónoi* started from high pitch; cf. Boeth., *Inst. mus.* 4.15, desc.ii. p. 343 add.; Varro, fr. 282, p. 304.109–12 Funaioli 1907; I know no evidence for the opposite direction (as used in *GMW* II: 428–9). The vertical conception appears fully developed in ps.-Aristot. *Pr.* 19.3; 37.

recognised scale form, we would have to expect some connection with Dorian, just as Hypophrygian always modulates with Phrygian. Only if 'Hypodorian' was a novel arrangement of notes, perhaps just another possibility of playing an agreeable scale on the polymodal aulos, becomes an artificial designation as 'the scale below Dorian' understandable. It is however surprising that no parallel between this scale and an old Aeolian was originally drawn; otherwise it would certainly have been called by this ethnic term. But this difficulty is not specific to the present hypothesis. Once it is recognised that Heraclides' source cannot have had Aristoxenus' Hypodorian in mind, the latter's terminological economy can no longer account for the apparent duplication of the terms anyway.

In the 'old commensurable *tónoi* system', the Hypodorian is made to modulate with Dorian (although apparently in a function similar to the later Hyperdorian¹³⁸). In respect to the 'old auletic' system, however, its position was shifted merely by a quartertone, so that its ambitus and general shape seem to have remained identical. Apparently Hypodorian had become an established scale by then – just as Heraclides' words imply. If this picture of a mode, born from instrumental capabilities, but soon accepted, hits near the truth, it provides another argument for dating the 'auletic' system before Philoxenus' *Mysians*. If we trust the assertion that Agathon introduced Hypodorian (and Hypophrygian) into tragedy,¹³⁹ the *terminus ante quem* is shifted backwards to about 410.

All in all, we can infer that in the first half of the fourth century a Hypodorian mode was flourishing that was defined more by its internal shape than by relation to other modes, and that was different from the Aristoxenian *tónos* of this name. If we could reconstruct its intervallic sequence, it might give us a clue to early fifth-century Aeolian, as well. Is it this Hypodorian that the pseudo-Aristotelian *Problems* describe as grand and steady, hence the most citharodic *harmonía*, not befitting tragic choruses, but the actors on the stage?¹⁴⁰ From a chronological viewpoint this appears not unlikely; but it raises a new problem: if Hypodorian originated in the poly-

¹³⁸ According to Aristoxenus, Hypodorian is here located a tone below Dorian. The establishment of such a relation demands the definition of functional *mésē* and probably the disjunction above it, so that functional Hypodorian *paramésē* must have been identical with Dorian *mésē*. The usual *pyknón* above this note implements *synēmménon* modulation from Dorian, which becomes later codified within the Hyperdorian. But in Hyperdorian, this is the *hýpaton* tetrachord of the Perfect System, not the *diezeugménon* tetrachord as here. The later key whose position corresponds precisely to the 'commensurable' system's Hypodorian is Hypoaeolian (Aristoxenus' 'Low Hypolydian').

¹³⁹ Psell. (?), *Trag.* 5.

¹⁴⁰ ps.-Aristot. *Pr.* 19.48. Cf. Hall 1999 on the social distinctions determining a tragic character's eligibility for solo song.

modal aulos, how could it become so closely associated with the lyre as well? Conceivably it was here that the Aeolian came into play. Lasus' hymn was most probably citharodic,¹⁴¹ and in Pindar the Aeolian appears connected with the seven-stringed lyre as well as with the aulos. Its auletic form was either obsolete when the new auletic 'Hypodorian' was devised, or the latter did not match the former closely enough to inherit its designation. When the Hypodorian had firmly established itself in dithyramb and tragedy, its correspondence with certain types of traditional lyre music of the Aeolian sort might have been felt. The general tendency towards a unified musical system, in combination with the preponderance of the aulos, which then was the reference instrument of *tónos* theory, would explain the intrusion of an originally auletic term into citharody. We have observed a similar phenomenon some centuries later, when a variant of the old 'Dorian' tuning became recognised as 'lydia', in accordance with its notation.

What can we know about the scalar form of the early Hypodorian? Fairly little, it seems. In relation to the other *tónoi* its *mésē* was quite low – although still about a minor third higher than it was in the Aristoxenian scheme. Above *mésē* we must posit a disjunctive tone. If the scale continued upwards in a regular enharmonic form, up to the common limit of the old *tónoi* systems, there is room for an entire tetrachord plus an additional *pyknón*, or, in the 'commensurable' system, even another (irregular) tone. In the same 'commensurable' system, a regular ditone below *mésē*, down to the enharmonic *likhanós*, transgresses the gamut of the Dorian octave, but not that of the Dorian ninth of the Aristides scale; in the 'auletic' system, the enharmonic *likhanós* would complete the octave and coincide with the lowest notes of the Phrygian and Mixolydian Aristides scales and of the Dorian octave. But one must certainly reckon with 'missing' as well as additional (i.e. 'irregular' diatonic) notes.

There is another example of an old mode transformed into a regular key: the *tónos* later called Hypolydian was attributed to the aulete Polymnestus (seventh century).¹⁴² About its original name one can only speculate. The 'slack', i.e. low-pitched, variant of the Lydian mentioned by Plato would be a natural candidate, especially because in Aristides' list of ancient scales the Hypolydian octave species appears as 'Lydian' without further qualification.¹⁴³ In another passage, however, Damon is credited with this particular

¹⁴¹ Note however the epithet βαρύβρομος, which fits aulos music better than lyre-accompanied song (Eurip., *Hel.* 1351; Aristoph., *Nub.* 113).

¹⁴² Ps.-Plut., *Mus.* 1141b: Πολυμνήστῳ δὲ τὸν θ' ὑπολύδιον νῦν ὀνομαζόμενον τόνον ἀνατιθέασι... Cf. *AGM*: 332 n. 16.

¹⁴³ Plato, *Rep.* 398e. But cf. n. 39 on p. 380 above.

'slack Lydian' octave.¹⁴⁴ But since it seems less likely that Damon designed a 'soft and sympotic' scale (as deprecated by Plato) from scratch, he might only have been responsible for giving an account of its shape within the newly evolving regular schemes. In any case, this Lydian variant did not make it into the two early *tónoi* systems; its eventual adoption by Aristoxenus was probably anticipated by Eratocles in his enumeration of octave species.

As regards the prefixes '*hypo-*' and '*hyper-*' as part of *tónos* names, they underwent an analogous evolution from a diffuse implication of relative position to a precise musical meaning. Nevertheless, the two did not develop side by side, but with an interval of about a century, '*hypo-*' taking the lead. And whereas the early 'Hypodorian' was merely 'the scale immediately below Dorian', in Hypophrygian the later technical significance of the prefix was already anticipated. Only much later did Aristoxenus introduce his 'Hypermixolydian' as 'the scale beyond Mixolydian'. At the same time, however, he took the last step in generalising '*hypo-*' as the technical term for the neighbouring key a fourth below. Finally, the unknown creator of the fully developed system of fifteen keys adopted the '*hyper-*' prefix for the key a fourth above, thus establishing a perfect symmetry of triads.

PENTATONIC PRECURSORS?

All known *systemáta* of Greek musical theory either plainly adhere to a heptatonic standard, or are, in the case of the *spondeíon* and the Aristides scales, most easily analysed within the heptatonic paradigm, as 'omitting' certain notes or 'inserting' others that belong to different, but still heptatonic, ways of dividing the pitch continuum. Nevertheless scholars have hypothesised about an early pentatonic phase of Greek music. Two entirely dissimilar types of pentatonicism have been suggested as underlying the later development of the three Greek genera: the 'anhemitonic' pentatonic without, and the 'older enharmonic' pentatonic with semitones.

The first is widespread also in recent musical cultures. It corresponds to a set of notes such as *e-g-a-b-d*, which, just as the full diatonic scale, can be construed by alternating fifths and fourths.¹⁴⁵ Its vindication for ancient Greek music originally rested on the assumption that lyres are invariably

¹⁴⁴ Ps.-Plut., *Mus.* 1136c. Cf. *AGM*: 181 n. 81.

¹⁴⁵ Cf. n. 10 on p. 106 above.

tuned so,¹⁴⁶ a wrong generalisation from recent African instrumental practice, now long refuted as regards the Greek evidence.¹⁴⁷ The accompanying supposition that diatonicism is a Greek development is now entirely confounded by the discovery of the 'Mesopotamian' musical system, perhaps resting upon Sumerian tradition, which incorporates the seven scales of a complete diatonic retuning cycle, exemplarily construed on a stringed instrument within the gamut of a ninth.¹⁴⁸ Nevertheless, the observation of recent pentatonic melodies on Greek territory led to the formulation of a new variant of the theory, according to which an anhemitonic pentatonic would stand behind the archaic 'Dorian', opposed mainly to the diatonic Phrygian.¹⁴⁹ Notably, though, the literary evidence contains no single hint to semitone-less melodies.

The 'older enharmonic' hypothesis, in contrast, focuses on the least common denominator of the later standard genera, the semitone at the bottom of the tetrachord, which is generalised and projected back as a historical precursor. This leads to a 'hemitonic pentatonic' with 'trichords' of the scheme *e-f-a*.¹⁵⁰ The existence of such a scale type is warranted by the *spondeion* and the occasional employment of respective tetrachords in the musical documents; its attribution of an ubiquitous status, however, is contradictory to both Aristoxenus' and his *mousikoí* predecessors' judgement. Here, too, the interpretation of the diatonic as having evolved from a pentatonic precursor within the Greek world is barely credible considering its usage in the Near East from times unfathomed.

A single literary passage supports the idea of pentatonicism pervading archaic Greek music; it is once more extracted from Aristoxenus by pseudo-Plutarch:

μαρτυρεῖ γοῦν τὰ Ὀλύμπου τε καὶ Τερπάνδρου ποιήματα καὶ τῶν τούτοις ὁμοιοτρόπων πάντων· τρίχορδα γὰρ ὄντα καὶ ἀπλᾶ, διαφέρει τῶν ποικίλων καὶ πολυχόρδων, ὡς μηδένα δύνασθαι μιμήσασθαι τὸν Ὀλύμπου τρόπον, ὑστερίζειν δὲ τού(του) τοὺς ἐν τῷ πολυχόρδῳ τε καὶ πολυτρόπῳ καταγιγνομένους. (ps.-Plut., *Mus.* 1137b)

¹⁴⁶ Most prominently Sachs 1924 (still upheld in Sachs 1943: 204–5; 218–21), the basis for the elaborate theory of Gombosi 1939; cf. also Husmann 1957.

¹⁴⁷ Winnington-Ingram 1956; cf. also the amusing physical considerations by Barbour 1960: 14.

¹⁴⁸ Cf. n. 8 on p. 105 above.

¹⁴⁹ Baud-Bovy 1978; 1983: 40–3; followed by Roch 2001. Whether the pentatonic stratum is ancient, but belonged to a low cultural level, or intruded from northern (non-Greek) regions at a later period seems difficult to decide.

¹⁵⁰ Most prominently, Sachs 1943: 207–10; 218–22; Chailley 1979: 28 (but cf. 54); West 1981: 118–19; *AGM*: 164.

This [the ancient musicians' deliberate abstinence from varied scales] is evinced by the compositions of Olympus and Terpander, and of all those using a similar style as these: being trichordal and simple they make such a difference from the manifold and polychordal compositions, that nobody is able to imitate Olympus' style, but those lag behind him who dwell in the polychordal multiplicity of styles.

From a passing reference of this kind one should be cautious about drawing wide-reaching conclusions. Certainly, however, the author hints at specific musical facts that made traditional pieces describable as *trikhorda*, 'three-note'. We know enough about what Greek musical writers assumed regarding the nature of Terpander's lyre and Olympus' aulos not to take the expression in the blunt sense of 'melodies consisting of three notes'. The accepted interpretation is therefore that *trikhorda* is implicitly opposed to the technical notion of the tetrachord, referring to music with three notes within the fourth,¹⁵¹ just as any pentatonic hypothesis demands. But whether this notion should be applied to all tetrachords possibly in question is doubtful. Although the trichordal quality is first allotted to both Olympus' and Terpander's tunes, the focus subsequently narrows down to the aulete, as if his music formed the key example for the raised claim. This accords with Aristoxenus' description of Olympus' original *spondeion* melody with undivided 'semitones', and therefore trichordal divisions, in both the lower and the higher 'tetrachord' (the discussion of the *spondeion* accompaniment immediately follows the above quoted text). Terpander, on the other hand, was associated with the seven-stringed lyre. Its tuning within the regular octave *harmonia* ensured that one note was missing from a regular heptatonic scale; our sources unanimously locate the gap in the higher part, resulting in a 'trichord' in the upper fourth. Philolaus' reference to the note a fourth below the highest note as *tritē*, 'third string', directly testifies to this fact.¹⁵² Thus the pseudo-Plutarch passage is entirely comprehensible without going beyond what the sources state elsewhere. Especially the narrowing down of the focus to Olympus, whose *spondeion* accords better with the assertion of a trichordal nature than does Terpander's lyre, is nicely explained by the respective characteristics of the instruments in question, so that further-reaching hypotheses become all the more unlikely.

If we nevertheless assume, for the sake of the argument, that ancient Greek music has gone through a pentatonic phase preceding classical heptatony, we would be bound to expect its traces still to be detectable in later melodies; all the more so, if the pentatonic is assumed to have survived in

¹⁵¹ E.g., Baud-Bovy 1978: 168 n. 44; *GMW* 1: 223 n. 124.

¹⁵² Philol., fr. 6a (see p. 112 above).

folklore until modern times. Any tendency towards a traditional pentatonic style would imprint itself in the preponderance of certain types of notes within the tetrachord over the others. On the anhemitonic hypothesis, the higher diatonic movable notes would appear favoured, at the expense of the lower ones.¹⁵³ The former are the *likhanoí* and *paranêtai* of the Greater Perfect System, in modern relative notation *g* and *d*; the latter, the *parypátai* and *tritai*, resembling *f* and *c*.¹⁵⁴ The inverse is to be expected for the ‘hemitonic’ hypothesis.

The actual relations found in the musical documents in different periods are set out in Diagram 100. It becomes clear at once that the statistics by no means support the assumption of early anhemitonic music. On the contrary, it is precisely in the earlier period (‘bc’) that the ‘hemitonic’ notes (*f*, *c*) prevail over the ‘anhemitonic’ ones (*g*, *d*). Admittedly, a purely statistical argument is far from conclusive in this case, because it is conceivable that for some reason – or even out of mere chance – no music survived from Hellenistic times that continues an anhemitonically imbued style. On the other hand it is easy to show that the emerging distribution is not simply due to the two Delphic Paeans, which overpower all other fragments by their mere extension: for the right-hand chart of Diagram 100, the distributions within the single fragments are added up without regard to the actual number of notes, so that the tendencies within each fragment contribute equally to the result. The Hellenistic predominance of the ‘hemitonic notes’ is nevertheless preserved, and even somewhat more accentuated.

If taken together with the literary evidence and the acknowledgement of the general antiquity of the diatonic, the statistics suffice to demolish the hypothesis of an exclusive anhemitonic pentatonic origin of Greek music, and relegate that of an anhemitonic pentatonic Dorian to the realm of barely founded speculation.

¹⁵³ Arguing along this line, Sachs (1924: 300) cites Mesomedes’ Hymn to the Sun (*DAGM* № 27) to show that “bis zum Untergang der Alten Welt die Musik in ihrem tieffsten Wesen pentatonisch geblieben ist.” Indeed mere 14.8% non-pentatonic notes (R, P and E) are found in that piece. But how many are to be expected? R and E are probably rare not because they produce semitones but because they exceed the normal range of the piece, which unfolds mainly in the sixth between Φ to Z. Within this range we encounter 13.6% of P; an entirely even distribution would demand 16.7%. P is certainly of little importance in the tonal hierarchy of the piece; nevertheless its 27 instances come very close to the 32 of C, which serves as starting, focal and final note. On balance, the Hymn is no more pentatonic than any diatonic piece in which the hierarchy of notes is somehow related to the circle of fifths.

¹⁵⁴ The *synēmmēnon* tetrachord cannot be evaluated in this context, since its diatonic *paranētē* corresponds to *tritē diezeugmēnon*. The latter is however included in the following analysis, as well as its *paranētē diezeugmēnon*, on the assumption that their function is generally primary over the modulating notes of similar notation from the *synēmmēnon* tetrachord, and because such modulation is comparatively rare anyway.

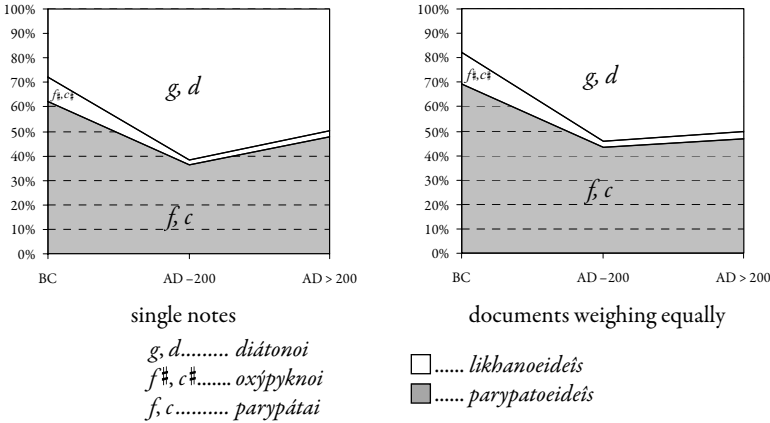

Diagram 100 Proportions of moving notes in the fragments (Greater Perfect System)

On the other hand, the relative scarcity of the higher movable notes in the Hellenistic fragments, chromatic ($f\#, c\#$) as well as diatonic (g, d), doubtless substantiates the suspicion that ‘trichordal’ structures of the shape $e-f-a$ were of considerable importance. The fact that they are above all found in the seemingly archaising initial sections of the Delphic Paeans clearly suggests that this importance is inherited from earlier music.¹⁵⁵ But as to what musical reality caused these late echoes, there are several possibilities. One is the pentatonic hypothesis, according to which trichordal music plainly reproduces scales analogous to those of archaic music.¹⁵⁶ Once more, however, such a wide-ranging assumption is unnecessary. An alternative explanation might refer directly to the so-called ‘older enharmonic’, i.e. the assumed stage without quartertones. This is a priori possible, but, as we have seen, highly problematic because the texts do not even suggest a common awareness of an entirely ‘trichordal’ *spondeion* outside the circles of auletes. Thirdly, trichordal scales in Hellenistic music might constitute the remnants of the enharmonic, a simplified way of alluding to the intellectually revered old style, in a time when its microtones were no

¹⁵⁵ Cf. above, pp. 281 ff. The argument would be circular if the recognition of the archaising character of these sections rested on this scalar feature alone. But, apart from textual considerations, there is also the abstinence from modulation except to the *synēmmēnon* tetrachord and, at least in the case of Athenaeus’ composition, a predilection for rhythmical groupings of Apollinian hue.

¹⁵⁶ The extended compass in Athenaeus’ archaising section (an eleventh) certainly does not respond to the capabilities of early lyres or auloi. That it prompts us to imagine sixth-century songs with a similar range, appears unlikely. What remains of Limenius’ first section unfolds within the seventh between *hypátē* C and *nētē synēmmēnon* L.

longer used, at least not in professional compositions for chromatic instruments.¹⁵⁷ Here the theoretical texts themselves may have played their role. The derivation of the enharmonic from the *spondeíon*, invented by the *mousikoi* and publicised by Aristoxenus, must have been widely known, and would have provided a superb model for – wrongly – archaising compositions. Finally, a combination of the latter two explanations is also conceivable: a compromise enharmonic backed by the recognition of true trichordal ‘precursors’ of classical enharmonic music.

So it seems the data can be accounted for without resorting to a general hemitonic pentatonic phase either. There are also direct objections against such a hypothesis, apart from the aforementioned problem of either having the Greeks re-inventing a diatonic long current in adjacent cultures – or introducing the *diátonoi* from there into a scale system miraculously prepared to accept them. Firstly, there is the design of the human hand, which, as discussed above, is especially ill-suited for fingering a wind instrument with greatly unequal finger hole spacing as would ensue from a hemitonic pentatonic layout.¹⁵⁸ Thus, the burden of the hemitonic pentatonic would inevitably fall on the lyre. Yet there is no doubt that at the time in question this instrument was equipped with a canonical set of seven strings.¹⁵⁹ Seven notes, however, are one too many for a non-modulating pentatonic tuning within the octave; a supposed modulating pentatonic tuning, however, could hardly be called pentatonic any more. Thus, a pentatonic seven-stringed lyre implies a range of least a ninth (e.g., *d-e-f-a-b-c'-e'*). But early Greek lyres cannot possibly have exceeded the octave, since the superlatives *hypátē* and *nētē* must originally have designated the outermost strings.¹⁶⁰ Hence, it appears that the universal pentatonic theory also lacks an appropriate instrument.

¹⁵⁷ Cf. also above, p. 160 with n. 64.

¹⁵⁸ Perhaps the specific limitations of the implied instruments stand behind the terms στενοχωρία, “restricted space”, and ὀλιγοχορδία, “paucity of notes”, in ps.-Plut., *Mus.* 1137a, which are subsequently echoed by references to the followers of Olympus and Terpander, respectively: the weak point of the simple aulos was the narrow range that one hand can play (but within which many different pitches were obtainable), that of the old lyre the fact that the number of pitches was determined to the canonical seven of the strings (which were however spread over an octave). But cf. Psell. (?), *Trag.* 5, where πολυχορδία, as opposed to former “small scales” (συστήμασι μικροῖς), applies to the aulos-accompanied songs of Euripidean tragedy.

¹⁵⁹ The earliest certain literary reference is in the Homeric Hymn to Hermes (l. 51) (sixth century), the authenticity of the famous Terpander fragment (Strab. 13.2.4; Cleonid. 12, p. 202.11–12) being doubtful; in the visual arts, seven-stringed lyres make their reappearance after Mycenaean times in the eighth or seventh century. That in reality the heptatonic stringing survived the intervening time of poor vase painting is probable (cf. Maas/Snyder 1989: 27–9).

¹⁶⁰ The only way out of this dilemma is by combining three claims, each more than unlikely: that the terms *hypátē* and *nētē* are older than the seven strings, that the designation of *hyperypátē* is as old as

Still, it must be emphasised that pentatonicism is not therefore excluded from ancient Greek musical studies. The initial sections of the Paeans, Aristoxenus' record of the *spondeíon* air, archaically performed, as well as the upper half of the seven-stringed lyre doubtless establish pentatonic structures. At least in the former cases, however, these are products of deliberate constraints. Much the same might be true for old lyre music also, if credit is given to the tradition that a *nētē* redoubling the pitch of *hypátē* at the octave was an alternative to a strictly heptatonic *nētē*, a seventh above the lowest note.¹⁶¹ This accepted, the constrained tonal variety within the octave would have been embraced as a reasonable price, probably to gain a fuller 'drone' when sweeping the plectrum across the row of strings. Thus, Aristoxenus' contention that the melodic paucity of early music rested not on ignorance, but was intentional, would bear more truth than is commonly assumed.

the seven strings, and that all memories the Greeks themselves fancied to preserve about the seven-stringed lyre were entirely misguided.

¹⁶¹ Cf. above, p. 35 n. 95; p. 94 n. 117.

CHAPTER 11

Synthesis

HISTORICAL OVERVIEW

Finally, it may be useful to combine the bits and pieces on which the foregoing chapters have hopefully thrown some light within a short historical overview, at some points developed into a model of the large strands along which ancient Greek music seems to have evolved. We start somewhere towards the end of the sixth century BC, the time from which the first dim reflexes reach us of musicians deliberating the nature of pitch structures. Of the various classes of instruments that were in use, the lyre and the aulos already dominated the musical culture, being the prime instruments of public performance in cultic and civic ritual as well as in professional competition. Later memory attributed the archaic lyre culture, commonly associated with seven-stringed tunings, to Terpander of Lesbos. The testimonies draw the picture of a variety of tunings within the range of an octave or perhaps also a seventh. Quite probably, these (or most of these) already included the basic division of the octave by fifths and fourths from its extremes, which remained unchanged until at least the second century AD. In accordance with the typical tuning procedure in fifths and fourth, there is little doubt that the diatonic division of the tonal space, similar to the scales known from the ancient Near East, was in some respect the basis of lyre music, although we must leave room for variation. Whether the pentatonically divided higher fifth was derived from a different kind of music, was due to a deliberate re-arrangement, or both, cannot be established with certainty.

Still less is known about the early aulos, which came in such a variety of materials, forms and sizes, that it is mostly the ancient nomenclature that gives us the right to subsume them under one name. The more reputed

types, however, participated in the heptatonic standard, which was ensured by the number and the spacing of the fingers. But this form of heptatony was not necessarily diatonic, in the ‘Pythagorean’ sense of tones and semitones. The rather evenly spaced (although not equidistant) finger holes gave rise to more even scales, akin to those of recent bagpipe traditions, with intervals that ancient sources interpreted as tones and three-quarter-tones. Possibly the aulos makers aimed at perfect fourths, from which they subtracted about a tone and cut the remaining distance in halves. Half-stopping produced the famous microtones of the ‘enharmonic’; it is not clear how old this technique, or at any rate its employment for melodies with undivided ditones, was. If auloi played together with diatonically tuned lyres, in any case, the semitones of the latter would have required a similar technique of half-covering finger holes.

It was within an environment of about this kind that the first invention of a melodic notation took place, perhaps not long after 500 BC. Its form presupposes the analysis of scales not necessarily into tetrachords, but into functional values of notes that possibly participated in a *pyknón*, and others that did not. The *pykná* were indicated graphically by including them within brackets, C ∩, < >, and □ □. This is all the more noteworthy because all the available evidence indicates that these two extremes of a *pyknón* were played on different holes on the aulos. It was only the intermediate microtones, ∪, ∨, and ⊔, that were produced by a half-stopping technique. Thus, the graphical triplets were not so much a tablature, but a description of the characteristics of the particular scales, based on the observation that the production of a *pyknón* involved a pair of finger holes, with the intermediate microtone involving both, somehow – which is physically correct, by the way. The diatonic semitone that was probably required when playing together with a lyre was of course equated with the same microtone, since it entailed a similar fingering (even on an ‘exact’ calculation, the difference between the two pitches amounts to mere 15 cents, entirely negligible in an instrument of such a flexible intonation; cf. Diagram 101).¹ The auletes called the interval produced thus a *diesis*, “letting through (a bit of air)”. The innate ambiguity of how the term was conceptualised gave rise to its two divergent meanings in later theoretical literature. The Pythagorean line took it over as the small interval of the diatonic, whence it became equated with the semitone and the *lémma*, while the *harmonikoi* focussed on its function of bisecting an enharmonic *pyknón*, thus effectively narrowing it down to a quartertone in the context

¹ Cf. also Hagel 2008c.

Synthesis

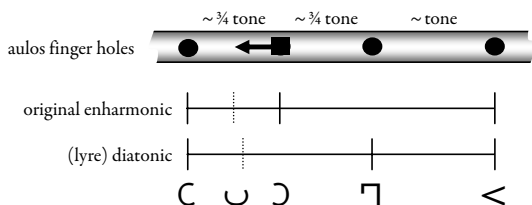
Diagram 101 The primordial *diesis*

of a new generation of auloi. Aristoxenus, finally, took an intermediate path, apparently calling a *diesis* any *pyknón*-generating interval smaller than the semitone.

The first stage of the notation sufficed for notating melodies in different modes, regardless of actual pitch. Whether, or from which time on, it was used for instrumental airs or for vocal music also, as a memory aid for personal use or also in professional education, and ultimately for transmitting and preserving newly composed melodies, we do not know.

Within the fifth century, both music theory and musical practice explored new ground. The analysis of pitch structures was perfected, and formerly barely interconnected scales were related to each other. The second half of the century saw the accelerated evolution that earned itself the modern name of a 'New Music'. It was characterised by the enrichment of the tonal material by modulation, the multiplication of cithara strings up to – probably – eleven, and the invention of mechanical auloi. The latter, above all, made it necessary to define exact relations between the old modes, which consequently started to evolve in the direction of mere pitch keys. A first attempt still focussed on evenly spaced aulos holes, resulting in three-quartertone intervals between certain scales; it seems it was useful for early polymodal auloi such as Pronomus may have used, but not yet for extensive modulation. Another system solved this by basing all interrelations on fifths and fourths, thus complementing the technical breakthrough of aulos mechanics with an adequate theory. In consequence, the virtuoso instruments became chromatic in the modern sense, i.e. large parts of the pipes, above all, were equipped with rows of semitones. In order to notate the corresponding music, it was finally necessary to forsake the functional approach, in favour of a modulating system implying more or less fixed pitches. Thus the 'enharmonic half' of the notation was elaborated, which presupposed, for the first time, enharmonic *pykná* of the size of a semitone. It necessarily transferred the Dorian key to a marginal state, while the old natural scale became associated with the Lydian and the Hypolydian. At

the same time, the overall auletic pitch – always presuming the star performers' instruments – apparently decreased, the new typical highest tone being notated a third below the old *nētē*. This had perhaps to do with technical requirements as well. It may be significant that even so the Hellenistic aulos retained the upper limit of the *spondeion* melodic pipe.

The invention of the vocal signs also falls within this period; our oldest scores already use it, not only those that belong to the heavily modulating style around the Phrygian key, but also the *Orestes* fragment with its apparently straightforward tonality. Not all instruments, however, embraced this evolution. Music for simple pipes as used in private contexts, by beginners and even by professionals of a lower social level, was better off with the old way, especially when 'transposing' instruments were involved. In consequence, we find traces of this 'transposing Lydian' approach well into late antiquity, especially in instrumental scores.

On the other side, the new chromatic instruments in turn had a considerable bearing on the musical styles. Perhaps the most significant result of their introduction was the irrevocable separation of private and professional music-making. Formerly, lyres and auloi with capabilities not very dissimilar from those of the virtuosos were commonly accessible; apart from volume and perhaps sound quality, the difference was mainly in the individual players' ability. But now the star auletes possessed incomparably more expensive instruments, which made it impossible to reproduce the music of the public performances in private settings, albeit in a reduced style. Similarly, many-stringed citharas required a technical excellence beyond the reach of the ordinary citizen. Formerly, one had been able to perform the songs of the famous lyrical poets at the symposium. The private lyre would convey the required 'harmonies' just as well as any large cithara, as long as both had seven strings, even if the accompaniment necessarily fell short of the intricacies that one appreciated in the citharodes. As a consequence, much of the newly created music necessarily remained attached to public performances by professionals, a change that cannot be overrated.

Another transformation concerns the melodies as such. On chromatic auloi, the old three-quarteritone *pykná* were no longer available; an 'enharmonic' *pyknón* could now only be played by bisecting a semitone instead. This evolution, although affecting primarily the virtuoso styles, also had enormous consequences. The true quarteritone as a melodic interval would not win public appreciation for long. No doubt it was used in the first half of the fourth century, when modulating music was based on the corresponding systems of the *harmonikoi*, and the quarteritone found wide acceptance as a practical measure of pitch space. Young Aristoxenus appar-

ently learned to be proud of appreciating this severe style, most unnatural to the human ear, as a sign of erudition; later he defended this ‘ditonic enharmonic’ against ‘sweeter’ performances with larger micro-intervals. After all, his own modulating tables inherited enough from the Eratoclean paradigm not to accommodate a non-quarteritone enharmonic, except as a ‘shade’. But all evidence points against him, when he considers the larger *pykná* as a modern depravation, close to the chromatic. On the contrary, it is those that appear to continue the original auletic microtones: for Archytas, it was still clear that the enharmonic *likhanós* was higher than the diatonic *parypátē*.

In any event, before long the enharmonic was dead, at least as a part of high-level music culture, with the instruments of which its more appealing form was not easily compatible. What remained from it was the theorists’ definition in terms of quartertones, providing for a commensurable tonal space (probably this theoretical advantage contributed to Aristoxenus’ verve in defending the most condensed enharmonic ever known).

The few musical documents that allow us some glances at the melodic techniques of the ‘New Music’ display its favour for the chromatic, in accordance with the new instrument design. The ‘chromatic’ as a genus on an equal standing with the enharmonic and the diatonic, however, was apparently a rather new conception also. A combination of enharmonic and diatonic was typical for the older notation, it stands behind Archytas’ divisions, and it is said to have dominated the aulos-accompanied songs of classical tragedy in its Halcyon times.² The chromatic, in contrast, was primarily associated with cithara music. Later sources generally emphasise its secondary status.³ Some of them derive the ‘colour’ metaphor from its intermediate position between the other two genera, just as colour is ‘intermediate’ between black and white. Such a view is clearly dependent on Aristoxenian systematisation and has no explanatory value. Others employ the idea of ‘colour’ as a modification, namely of the diatonic, which is reminiscent of Ptolemy’s ‘*trópoi*’ with its only slightly flattened *paranété*, apparently the only chromatic cithara tuning that made it into the second century AD. But the earliest references draw another picture. Apart from the

² Pap. Hibeh 13, ii.3–4: τῶν τραγωιδῶν ... [τῶν διὰ παντὸς εἰωθότων ἐφ’ ἀρμονίας αἰδειν “the singers in tragedy who are altogether accustomed to singing in the enharmonic”; Aristox., *ap. ps.-Plut., Mus.* 1137de (cf. n. 6 on p. 368 above); Psell. (?), *Trag.* 5: ἡ δὲ παλαιὰ τραγικὴ μελοποιία γένοι μὲν τῷ ἐναρμονίῳ ἐχρήσατο ἀμιγῆ καὶ μικτῷ ἐξ ἀρμονίας καὶ διατόνου “the music of old tragedy employed the enharmonic genus unmixed as well as one mixed of enharmonic and diatonic.”

³ The passages are conveniently collected in Rocconi 2004, where the relative lateness of the notion of three genera is demonstrated.

loose metaphor of “well-coloured melodies” or “dance movements”, current among musicians,⁴ in technical contexts we encounter the term *kbrōmata* associated with modulation, as characteristic of the complex style that gained ground at the end of the fifth century.⁵ While the fully developed idea of a chromatic ‘genus’, connected with the static image of a scale, is designated by the singular *kbrōma*,⁶ the plural in the texts apparently refers to qualities that recur within the unfolding of a melody in time, analogously to modulations. Such ‘colourings’ were judged adversely when transferred to inappropriate genres (e.g., to tragedy instead of citharody) or applied in a too exuberant or otherwise inappropriate way.⁷

Both the association with modulation and with the cithara as the original ‘chromatic’ instrument find its explanation in the string named *kbrōmatiké*, as an alternative to *diátonos* a semitone higher. Lying a fourth below *paramésē*, it enabled switching between what formerly had been two different tunings. Naturally enough, however, the players would not keep these strictly separated, but ‘coloured’ their melodies with interspersed notes alien to the underlying traditional scales.⁸ Within a still heptatonic framework, the lower part of the lyre octave could thus assume the following shapes: *e-f-g-a*, *e-f#-g-a*, and *e-f-f#-a*. The former two were diatonic in two different ‘keys’, and as such doubtless traditional. Only the last was novel; consequently, when the vague colour metaphor eventually crystallised into a technical term, it was this form of the tetrachord that it

⁴ Plato, *Leg.* 655a (εὐχρῶν δὲ μέλος ἢ σχῆμα ... ὥσπερ οἱ χοροδιδάσκαλοι ἀπεικάζουσιν); cf. Philochorus, as in n. 6 on p. 368 above, where the vague adjective is combined with the more technical *kbrōmata*. Plato himself employs the metaphor of music ‘colouring’ the text: *Leg.* 669c; *Rep.* 601b.

⁵ Antiphanes, *ap.* Ath. 643d, on Philoxenus: τὰ μέλη μεταβολαῖς καὶ χρώμασιν ὡς εὖ κέκραται “how well his melodies are blended with modulations and *kbrōmata*”; Aristox. *ap.* ps.-Plut., *Mus.* 1137f: ἀπεσχημένους χρώματός τε καὶ μεταβολῆς καὶ πολυχαρδίας “abstaining from *kbrōma*, modulation and multiplicity of notes”. Cf. still the musical metaphor combining *kbrōma*, pitch change and change of *harmonía* in Dionys. Hal., *Dem.* 46.

⁶ The earliest instance is probably Pap. Hibeh 13, i.16. The fact that the chromatic is here viewed as belonging together with the diatonic has caused much surprise. The problem vanishes once the original nature of the chromatic as an extension of the diatonic tuning procedure is recognised (cf. n. 9 below).

⁷ Aristot., *Pol.* 1342a: τῶν ἁρμονιῶν παρεκβάσεις εἰσὶ καὶ τῶν μελῶν τὰ σύντονα καὶ παρακεχρωσμένα “[for the public of low taste] there are deviations from the modes (*harmoniai*) and the tense and inappropriately coloured melodies”. The pejorative aspect is expressed by the preposition *para-*; cf. Plut., *Quaest. conviv.* 645d: τὰς μὲν ἐν τοῖς μέλεσι παραχρώσεις.

⁸ For a similar modern notion, cf. Gombosi’s “koloristische Auflockerung” (1939: 126) for the additional semitone step used in Athenaeus’ paean, where it is also modulation that leads to extended chromaticism. — For the nature of the transformation, cf. Abert 1924: 37; Vogel 1963b: 124–5 (“bildete sich aus der Vermischung zweier Einstimmungen ein neuartiges Tetrachord, dem ein eigenes Ethos zuerkannt wurde”).

came to designate.⁹ Archytas already recognised the chromatic by accounting for the pitch relation between *khrōmatiké* and *diátonos*. But it was only later in the fourth century that it became considered as a genus of its own, on an equal footing with the old diatonic and enharmonic.

By this time, ‘Pythagorean’ theory had evidently given up describing the increasingly complex pitch structures of concert music. Instead, it continued to focus on the basic insights gained back in the fifth century, the comprehension of resonant pitch relations as simple numeric ratios, partly refined by the theory of means and the search for additional superparticulars. By the times of Philolaus, the structure of the *harmonía* as the octave-bounded harmonic framework of the lyre had been grasped; Archytas and Plato already treated the ratios for the ‘Pythagorean’ diatonic as a given. Archytas went a step further, sacrificing a diatonic with 9:8 tones throughout on the altar of superparticularity, very probably with a view more to the aulos and the notation than to lyre tuning. Here the ways of two ‘Pythagorean’ factions parted, one faithful to Plato’s *Timaeus*, its *lémma*, and the ensuing *apotomé*, the other developing a variety of mathematically satisfying tetrachord divisions, over the centuries reflecting different aspects of musical practice.

The invention of mechanical auloi not only brought about an abundance of semitones within the range fingered, but also a set of additional low notes, controlled by sliders. The note a fourth below old *hypátē* became especially prominent, and the large intervallic jumps associated with this

⁹ Curiously, the original metaphorical meaning was thus closer to the modern sense of ‘chromatic’ than the rigidly defined Aristoxenian genus. Cf. also the remarkable passage that the manuscripts insert at the end of the second book of Aristid. Quint.: τὸ χρωματικὸν γένος διατονικὸν ἔστιν ἠϋξημένον καὶ πεπυκνωμένον ἡμιτονίοις “the chromatic genus is the diatonic augmented and densely populated with semitones” (trans. Barker). The idea of an augmentation appears to denote not the larger interval at the top of the tetrachord (this is barely compatible with the second half of the clause), but the addition of the *khrōmatiké* to the diatonic tetrachord, while the elimination of the *diátonos* in turn remains out of focus. Thus, the ‘dense population’ of semitones might refer to the series of three in *e-f-f#-g* (πεπυκνωμένον here does not refer technically to the Aristoxenian *pyknón*: cf. the subsequent *διάτονον δὲ καλεῖται διότι πεπύκνωται τοῖς τόνοις κατὰ τὰ διαστήματα*). The explanation of the name also testifies to an unusually deep insight into musical structures: *χρωματικὸν δὲ καλεῖται παρὰ τὸ χρώζειν αὐτὸ τὰ λοιπὰ διαστήματα, μὴ δεῖσθαι δὲ τινος ἑκείνων* “the chromatic is so called because it colours the other intervals, but has no need of any of them in particular”. Indeed the chromatic arises from modulation in the diatonic and the enharmonic similarly, thus adding colour to both (for the association of intervals with genera, cf. Cleonid. 5, p. 187.10–12). This holds for Archytas’ genera as well as for the standard form (which is here doubtless presupposed), where the chromatic *parhypátē* is provided either by the diatonic one or by the enharmonic *likhanós*. Thus it is true that the chromatic does not require any genus-specific interval, neither the enharmonic quartertone at the bottom, nor the diatonic tone at the top of the tetrachord, merely the unspecific semitone at the bottom which is common to both. Remarkably, the author thinks in terms of modulating *systemata*, reminiscent of Aristoxenus (cf. above, pp. 375ff.).

and other bass notes very probably contributed to the conception of a ‘fixed notes’ skeleton of the musical scale. The numeric rendition of this skeleton in Pythagorean terms makes its appearance as a cosmological scale in later sources, but may well date back to Archytas. The division of the universal soul in Plato’s *Timaeus*, at any rate, presupposes precisely such a framework. From this framework to the conception of the Perfect System it is only a minor step. The latter is reflected in the design of a particular type of ‘transposing’ auloi, whose invention might have taken place at about the same time – although the available archaeological evidence for these wooden instruments naturally dates from a later, Egyptian context. On such auloi, the *hyperbolaïon* tetrachord would be associated with overblowing. On the lyre this tetrachord also involves the production of harmonics, a technique that stands behind the octave strokes of the notation.

From the fourth century on, the notation continued being used in two distinct ways: the older, functional one, centred on the oldest set of signs, employed mainly by players of lyres and of less-sophisticated pipes, and the younger, modulating interpretation, associated with more complex styles of primarily aulos-accompanied music. The former needed not associate notation with keys, which ensured that the *tónoi* names of the latter became universally recognised. In this way, lyre players became accustomed to referring to their Dorian octave as ‘*lydia*’, i.e. about “what is notated with Lydian signs”, although the corresponding music had nothing in common with any style that earlier generations would have associated with Lydia. Still, it was felt that that citharodic ‘Lydian’ had to be set apart from a more properly ‘Lydian’ *trópos*. When describing the modes connected with the dithyramb and the *nómos*, the exemplary auletic and citharodic genres,¹⁰ one could say:

ταῖς ἁρμονίαις οἰκείαις ἐκάτερος χρῆται· ὁ μὲν γὰρ τὸν φρύγιον καὶ ὑποφρύγιον ἀρμόζεται, ὁ νόμος δὲ τῷ συστήματι τῶν τῶν κιθαρῶδων λυδίῳ.

(Procl. *soph. ap. Phot., Bibl.* 320b)

Each of them uses the *harmoníai* familiar to it: the [dithyramb] is tuned to the Phrygian and Hypophrygian, but the *nómos* to the Lydian scale of the citharodes.

Of course, a ‘Lydian’ as we know it from Plato’s discussion in the *Republic* makes no sense in this passage from a much later period, probably about contemporary with Ptolemy. As underlined by the choice of the word *sýstēma* in combination with the hint that its name is applicable to citharodic

¹⁰ On *nómos* in general, and its replacing the paean as the typical Apollinic genre, cf. Rutherford 1995.

terminology only, the reference is clearly to the tuning *lydia* as we know it from Ptolemy, and thus to a truly ‘Dorian’ *harmonía*, as we would expect it from the contrast to an auletic Phrygian.¹¹ Similarly, when Bellermann’s Anonymus lists the *tónoi* associated with each instrument, the Phrygian is still connected with the aulos, but the Lydian has long replaced ‘Dorian’ in lyre music discourse.

For the two centuries around the turn of the era we are facing an almost complete lack of extant scores. This is all the more lamentable as the music that emerges afterwards has undergone a profound change. From the first century AD we get at least dim impressions of new developments in music theory. Didymus was concerned with establishing symmetry, both between notes on the canon and within the Perfect System. Thrasyllus might have pursued the latter in terms of the Platonising ‘Pythagorean’ tuning, while Didymus worked with superparticulars. Both attempts would only work out when the enharmonic splitting of the semitone was disregarded. Thus this genus, which had been the exclusive focus of the pre-Aristoxenian *harmonikoi* about four centuries before, was expelled from the comprehensive accounts and relegated to passing references. Accordingly, the extant tables of the Perfect System mostly fail to distinguish an enharmonic *parypátē* from the common diatonic-chromatic one.¹²

What has been recovered of the melodies of the Roman Imperial era has given up the old enharmonic keys almost completely, with the exception of the natural Lydian. Instead, the neighbouring keys of the relatively new chromatic keys are now used. On the aulos, this development can be understood out of the playing conditions of the early modulating pipes, a minor modification of which would have cleared the way for such a paradigm change.

As regards the cithara, the notation in the chromatic keys might well reflect some of the older tunings, although it is difficult to establish details of a possible development. Although the Hypolydian note signs were probably available very early, it is unclear how the tunings corresponding to later Hyperastian and Iastian would originally have been notated. Still, it must be borne in mind that the development of the ‘enharmonic’ keys was in-

¹¹ Cf. also Psell. (?), *Trag.* 5: ὁ γε μὴν λύδιος τοῦ κιθαρωδικῆς τρόπου οἰκειότερός ἐστι “the Lydian [*tónos*], on the other hand, is more familiar to the citharodic style”: this is based on a similar source, but of course no longer understood. Do the ‘lyre *systemata*’ (διὰ τῶν λυρικῶν συστημάτων) of *FdD* III.1, 49.2–4 (about 160 BC), also belong here?

¹² Cf. Vogel 1963a: 105–8. The distinction is carried through for the *likhanoi*, which appear as *diátonos*, *kbrōmatiké* and *enarmónios*. The set of functional pitches described thus seems to have had a musical background in quarter-tone-less melodies, echoing the classical enharmonic only through their undivided ditone.

spired by the requirements of aulos music, so that a parallel ‘chromatic’ citharodic evolution, in some respects foreshadowing the codified ‘chromatic’ *tónoi*, cannot be entirely excluded.¹³ If such an approach existed, it would have remained so close to instrumental practice as to produce no diagrams of keys to rival those of the ‘auletic’ interpretation of the note signs.

The other apparent novelty of the later era is the establishment of a dominating *G* mode in the musical documents. Here also several factors must have cooperated in overthrowing the *A* mode that underlay at least part of the Hellenistic compositions. We have observed that the particular form of Ptolemy’s diatonic cithara tunings supports a focal status of *G* and *D*. But this cannot count as an explanation, since we cannot resolve the question of priority; a priori it appears more likely that the fine tuning was chosen to suit the focal notes and not the other way round.

One must certainly deliberate the possible long-term consequences of the introduction of *hyperypátē* in addition to the archaic lyre octave. In the Lydian key, it brought about a *D-g-d* triad to rival the old *e-a-e’* (cf. Diagram 58 on p.227 above). In Hypolydian it provided a possible focal *G*, instead of the functional *A* of *hypátē*. In both cases, we encounter novel alternatives, but no compelling reason for a change. In Hyperian and Iastian, in contrast, a modal importance of *G* is already recommended by the old octave, while the *F-C* mode possibly suggested by *hyperypátē* in Hyperian was probably beyond the scope of ancient musical appreciation anyway. If the corresponding tunings continued ancient ones, as appears probable, we would be compelled to assume the existence of old *mésē-hypátē*-centred *G-D* modes. In this case, the transfer of a similar mode to the citharodic *lydia* would be more a process of homogenisation than a revolution. For the most typical auletic key of the Roman period, the Iastian, the *G* mode is also only natural.

However difficult it is to trace the different strands through the dark period, in the second century AD we once more observe musical theory brought to a high degree of consistence with practice, although only within the limited scope of citharody. In fact, Ptolemy’s *Harmonics* outrival all extant treatises as regards clarity of argument, scientific method, and an-

¹³ Starting from the tunings to which Ptolemy testifies, such a citharodic notation would have required only two additional signs (once the existence of O K is taken for granted): one for the latter A \searrow (i.e. E \sqcup retuned) and one for the latter K \wedge (*diátonos* retuned). In practice, it would be equally feasible, wherever only one string of alternative tuning exists, to maintain the signs and state the required tuning (cf. Ptolemy’s designation *diátonos* for both M \sqcap / Z \asymp and K \wedge in *Harm.* 2.1, p.43.19–20: above, Diagram 26 on p.109; pp.116f.): in short, there are far too many unknown factors.

choring the results of abstract reasoning within the experience of concert goers and instrumentalists, amateur or professional. This work allowed us to associate extant melodies with precise intervals, thus also providing the key for an enhanced comprehension especially of the *G* mode. Accordingly, our understanding of musical documents must decrease the further these are removed in time or in cultural sphere from the music Ptolemy contemplates. Later authors draw on book theory, mostly based on a tradition that was in living contact with contemporary music only half a millennium earlier. The table of eight keys in Boethius' work, for instance, although conceptually close to Ptolemy's ideas, nevertheless reproduces a much older system, consisting mainly of the old 'enharmonic' modes. In a diagram furnished with note signs, this was scarcely avoidable, as Ptolemy's reformation of a citharodic approach was incompatible with the *tónos* nomenclature of the notation. So the single extant work from the later period that set out for a synthesis of theory and practice was bound to be misunderstood as soon as the public was no longer familiar with the specific citharodic modes on which it is based. Consequently, our knowledge of the music of the final centuries before the use of the notation system ceased altogether must rely mainly on a few melody fragments.

TRANSCRIBING ANCIENT NOTATION

The preceding study also has its bearing on the question of how to render ancient notes by modern note names and stave notation. The traditional approach, established by Bellermann and Fortlage and adopted in many publications, above all in the standard editions of the musical documents, pursues logical consistence in equating the Hypolydian key with our natural scale, assigning the modern note *a* to ancient CC. This is in perfect accord with the system inherent in the ancient notation in its developed state. It has however two serious disadvantages. The first is the well-known divergence of pitch. When ancient melodies or scales are transcribed in the usual manner, they appear about a third too high. This is not only impractical when people are playing – or the fewer people with absolute pitch, singing – from the scores, but it also frequently leads to considerable confusion even in scholarly works. The second disadvantage is less recognised, but stands out more clearly than ever in the light of this study: in ancient musical thought, the Hypolydian enjoyed no such central status as the usual

transcription attributes to it. In fact, it is the Lydian around which the ancient notation revolves, and which is the truly 'natural' scale also in historical terms.

It is therefore advisable to renounce the traditional transcription, in order to embrace the Lydian *tónos* as the native counterpart of our natural scale. This will shift everything down by a fourth and by one key in the direction of the sharp keys. The place of the pivotal 'a' becomes occupied by the Lydian *mésē* | <, which is, by the way, also the note most frequently attested in the musical documents. The sole disadvantage of such a transcription is the fact that OK , although the basic sign of a structural triplet, must now be rendered as $f\sharp$. But this is certainly tolerable in view of the significance of this note in citharody (where it not unlikely originated): it is the *khrōmatiké*, whose name preserved the memory of its non-natural identity throughout the centuries.

Is it a curious coincidence that the shift to a Lydian transcription also solves the pitch problem for most practical issues? According to the accepted estimation of the ancient standard, the structural 'a' of Lydian *mésē* will now reflect a pitch about between modern $a\sharp$ and b , so that the discrepancy shrinks to barely more than a semitone. Such a difference lies within the range of variation that modern concert pitch has undergone throughout the centuries. After all, an ancient score transcribed in this way would not appear further off the original pitch than a composition of Baroque music.

On balance, it is surprisingly easy to transcribe ancient notation in a way that is very close both to the ancient conception and to the original pitch. Should a hundred-and-fifty year old tradition, based on an incomplete understanding of ancient music, prevent us from adopting it?

Bibliography

EDITIONS QUOTED BY PAGE NUMBERS

- Ach., *Intr. Arat.: Achillis quae feruntur astronomica et in Aratum opuscula*, ed. G. Di Maria. Palermo 1996.
- Alypius: in Jan 1895.
- Append. Serv.: Appendix Serviana*, ed. H. Hagen. Leipzig 1902.
- Aristid. Quint.: *Aristidis Quintiliani De musica libri tres*, ed. R.P. Winnington-Ingram. Leipzig 1963.
- Aristox., *Harm.: Aristoxeni Elementa harmonica*, ed. R. Da Rios. Rome 1954.
Rhythm.: Aristoxenus, Elementa rhythmica, ed. L. Pearson. Oxford 1990.
- Ath.: *Athenaei Naucratis Deipnosophistarum libri xv*, ed. G. Kaibel. 3 vols, Leipzig 1887–90.
- Bacchius: in Jan 1895.
- Boeth., *Inst. mus.: Boetii De institutione arithmetica / De institutione musica*, ed. G. Friedlein. Leipzig 1867.
- Censorinus, *De die natali: Censorini De die natali liber*, ed. N. Sallmann. Leipzig 1983.
- Cleonid.: Cleonides, in Jan 1895.
- Exc. Neap.:* in Jan 1895.
- Exc. Nicom.:* in Jan 1895.
- Frag. Cens.:* ed. N. Sallmann, in *Censorini De die natali liber*. Leipzig 1983.
- Gaud.: Gaudentius, in Jan 1895.
- German.: *Germanici Caesaris Aratea, cum scholiis* ed. A. Breysig. Berlin 1867.
- Heph.: *Hephaestionis Enchiridion cum commentariis ueteribus*, ed. M. Consbruch. Leipzig 1971.
- Hdn.: *Herodiani technici reliquae*, ed. A. Lentz. Leipzig 1867–70 [reprint 1979].
- ps.-Hdn., *Epim.: Herodiani Partitiones*, ed. J.F. Boissonade. London 1819 [reprint 1963].
- Ioann. Philop., *in de An.: Ioannis Philoponi In Aristotelis De anima libros commentaria*, ed. M. Hayduck. *Commentaria in Aristotelem Graeca* 15. Berlin 1897.

- Lydus, *Mens.*: *Ioannis Laurentii Lydi De mensibus*, ed. R. Wünsch. Leipzig 1898.
- Nicom., *Ench.*: in Jan 1895.
- Phryn., *Praep. soph.*: *Phrynichi sophistae Praeparatio sophistica*, ed. J. de Borries. Leipzig 1911.
- Porph., in *Harm.*: *Porphyrios Kommentar zur Harmonielehre des Ptolemaios*, ed. I. Düring. Göteborg Högskolas Årsskrift 36.1. Göteborg 1930.
- Procl., in *Tim.*: *Procli Diadochi in Platonis Timaeum commentaria*, ed. E. Diehl. Leipzig 1903–6.
- Ptol., *Harm.*: *Die Harmonielehre des Klaudios Ptolemaios*, ed. I. Düring. Göteborg Högskolas Årsskrift 38.2. Göteborg 1932.
- Inscr. Can.*, in *Claudii Ptolemaei opera quae extant omnia*, II: *Opera astronomica minora*, ed. J. I. Heiberg. Leipzig 1907.
- Sect. can.*: in Jan 1895.
- Stob.: *Ioannis Stobaei Anthologium*, ed. C. Wachsmuth/O. Hense. Berlin 1884–1912.
- Synes., *Ep.*: *Synesii Cyrenensis Epistolae*, ed. A. Garzya. Rome 1979.
- Theon, *Util. math.*: *Theonis Smyrnaei Expositio rerum mathematicarum ad legendum Platonem utilium*, ed. E. Hiller. Leipzig 1878.
- ‘Timaeus Locrus’, ed. W. Marg, in H. Thesleff (ed.), *The Pythagorean Texts of the Hellenistic Period*. Åbo 1965: 202–25.

MODERN WORKS

For abbreviated titles, see above p. xiv.

- Abbott, D./Segerman, E. (1974) ‘Strings in the 16th and 17th centuries’, *Galpin Society Journal* 27: 48–73.
- (1975) ‘Correction to Abbott / Segerman 1974’, *Galpin Society Journal* 28: 134.
- Abert, H. (1924) ‘Antike’, in: G. Adler (ed.), *Handbuch der Musikgeschichte*. Frankfurt: 27–60.
- Ahrens, Ch. (1987) *Aulos, Touloum, Fischietti. Antike Traditionen in der Musik der Pontos-Griechen und der Graeko-Kalabrier*. Orbis Musicarum 1, Aachen.
- Anderson, W. D. (1994) *Music and Musicians in Ancient Greece*. Ithaca/London.
- Avezzù, G. (1994) ‘Papyrus Hibeh 1,13: Anonymi fragmentum de musica’, *Musica e Storia* 2: 109–37.
- Baines, A. (1960) *Bagpipes*. Oxford.
- (1962) *Woodwind Instruments and Their History*. 2nd edn, London.

- Banou, O. (1998) (Μπάνου, Ο.) 'Ο διάυλος τῆς Πύδνας [The double flute found in Pydna]', in *Αρχαία ελληνική τεχνολογία. Πρακτικά του Ιου διεθνούς συνεδρίου, Θεσσαλονίκη, 4-7 Σεπτεμβρίου 1997*. Thessalonica: 519-24.
- Barbera, A. (1977) 'Arithmetic and geometric divisions of the tetrachord', *Journal of Music Theory* 21: 294-323.
- Barbour, J.M. (1960) 'The principles of Greek notation', *Journal of the American Musicological Society* 13: 1-17.
- Barker, A. (1978a) 'Οἱ καλούμενοι ἄρμονικοί: The predecessors of Aristoxenus', *Proceedings of the Cambridge Philological Society* 24: 1-21.
- (1978b) 'Music and perception: A study in Aristoxenus', *Journal of Hellenic Studies* 98: 9-16.
- (1982a) 'Aristides Quintilianus and constructions in early music theory', *Classical Quarterly* 32: 184-97.
- (1982b) 'The innovations of Lysander the kitharist', *Classical Quarterly* 32: 266-9.
- (1989) 'Archita di Taranto e l'armonica Pitagorica', in A.C. Cassio/D. Musti (edd.), *Tra Sicilia e Magna Grecia. AION (Annali dell'Istituto Orientale di Napoli), Sezione filologico-letteraria* 11: 159-78.
- (1994) 'Greek musicologists in the Roman Empire', in T.D. Barnes (ed.), *The Sciences in Greco-Roman Antiquity*. Edmonton Alberta = *Apeiron* 27.4: 53-74.
- (1995) 'Heterophonia and poikilia: Accompaniments to Greek melody', in B. Gentili/F. Perusino (edd.), *Mousike. Metrica ritmica e musica greca*. Pisa/Rome: 41-60.
- (2000) *Scientific Method in Ptolemy's 'Harmonics'*. Cambridge.
- (2001) 'La musica di Stesicoro', *Quaderni Urbinati di Cultura Classica* 67: 7-20.
- (2002) *Euterpe. Ricerche sulla musica greca e romana*. Pisa.
- (2003) 'Early *Timaeus* commentaries and Hellenistic musicology', in R.W. Sharples/A. Sheppard (edd.), *Ancient Approaches to Plato's Timaeus = Bulletin of the Institute of Classical Studies Suppl.* 78: 73-87.
- (2007) *The Science of Harmonics in Classical Greece*. Cambridge.
- Barker, A./Creese, D. (2001) s.v. Eratosthenes, in *Die Musik in Geschichte und Gegenwart*, 2nd edn, Personenteil 5, Kassel et al.: 399-400.
- Barkóczi, L. et al. (1957) *Intercisa II. (Dunapentele.) Geschichte der Stadt in der Römerzeit. Archaeologia Hungarica (Dissertationes archaeologicae Musei Nationalis Hungarici)*, S.N. 36, Budapest.
- Bataille, A. (1961) 'Remarques sur les deux notations mélodiques de l'ancienne musique grecque', *Recherches de Papyrologie* 1: 5-20.

- Baud-Bovy, S. (1978) 'Le dorien était-il un mode pentatonique?' *Revue de musicologie* 64: 153–80.
- (1983) *Essai sur la chanson populaire grecque*. Nauplion.
- Becker, H. (1966) *Zur Entwicklungsgeschichte der antiken und mittelalterlichen Robrblattinstrumente*. Hamburg.
- Behn, F. (1954) *Musikleben im Altertum und frühen Mittelalter*. Stuttgart.
- Bélis, A. (1982) 'Les « nuances » dans le *Traité d'Harmonique* d'Aristoxène de Tarente', *Revue des Études Grecques* 95: 54–73.
- (1984a) 'Fragments d'auloi', in *L'ancre Corycien* 2. *Bulletin de Correspondance Hellénique*, Suppl. 9: 176–81.
- (1984b) 'Un nouveau document musical', *Bulletin de Correspondance Hellénique* 108: 99–109.
- (1984c) 'Auloi grecs du Louvre', *Bulletin de Correspondance Hellénique* 108: 111–22.
- (1985) 'À propos de la construction de la lyre', *Bulletin de Correspondance Hellénique* 109: 201–20.
- (1986) 'L'aulos phrygien', *Revue Archéologique*: 21–40.
- (1988) 'Interprétation du Pap.Oxy. 3705', *Zeitschrift für Papyrologie und Epigraphik* 72: 53–63.
- (1990) 'Anthologie XI, 78: fourmillements musicaux sur la tête d'un boxeur', *Études Classiques* 58: 115–28.
- (1995) 'Cithares, citharistes et citharôdes en Grèce', *Comptes rendus de l'académie des inscriptions et belles-lettres* 1995/4: 1025–65.
- (2003) 'Le « Péan de Berlin » : une relecture', *Revue des Études Grecques* 116: 537–58.
- (2004) 'Un papyrus musical inédit au Louvre', *Comptes rendus de l'académie des inscriptions et belles-lettres* 2004/3: 1305–29.
- Bélis, A./Delattre, D. (1993) 'À propos d'un contrat d'apprentissage d'aulète', in M. Capasso (ed.), *Papiri Documentari Greci. Papyrologica Lupiensia* 2: 105–62.
- Bellermann, J.F. (1847) *Die Tonleitern und Musiknoten der Griechen*. Berlin [reprint Wiesbaden 1969].
- Benade, A.H. (1960) 'On the mathematical theory of woodwind finger holes', *Journal of the Acoustical Society of America* 32/12: 1591–1608.
- (1976) *Fundamentals of Musical Acoustics*. New York et al.
- Blinkenberg, C. (1931) *Lindos. Fouilles de l'Acropole* 1902–1914, 1: *Les petits objets*. Berlin.
- Bodley, N.B. (1946) 'The auloi of Meroë', *American Journal of Archaeology* 50: 217–40; pls. I–VIII.
- Boeckh, A. (1814) *De metris Pindari*. Leipzig.

- Bonefas, S. (1989) 'The musical inscription from Epidauros', *Hesperia* 58: 51–62; pl.14.
- Borthwick, E.K. (1967) 'Some problems in musical terminology', *Classical Quarterly* 17: 145–57.
- Boshnakova, A.K. (2008) 'Reading ancient Greek music in documents, images and artifacts and the practical application of music archaeology', in A.A. Both *et al.* (edd.), *Studien zur Musikarchäologie* 6. *Orient-Archäologie* 22: 414–21.
- Boulter, C. (1953) 'Pottery of the mid-fifth century from a well in the Athenian agora', *Hesperia* 22: 59–225; pls. 21–41.
- Bound, M. (1991) 'The pre-classical wreck at Campese Bay, island of Giglio. Second interim report, 1983 season', *Studi e materiali: Scienza dell' antichità in Toscana* 6: 199–242.
- Bovon, A. (1970) 'Fragments d'auloi', in P. Bruneau *et al.* (edd.), *Délos* 27. *L'îlot de la maison des comédiens*. Paris: 233; pl. 38.
- Bower, C. (1978) 'Boethius and Nicomachus: An essay concerning the sources of *De institutione musica*', *Vivarium* 16: 1–45.
- (1984) 'The modes of Boethius', *Journal of Musicology* 3: 252–63.
- (1989) *Boethius, Fundamentals of Music*. Ed. with intr. and notes. New Haven / London.
- Brandl, R.M. (2005) 'Universale Basis-Definitionen von *Mebrstimmigkeit*, *Polyphonie* und *Heterophonie* (= multiple Abläufe) aus Sicht der vergleichenden Musikwissenschaft', in G. Gruber *et al.* (edd.), *Mebrstimmigkeit und Heterophonie*. Vienna: 9–35.
- Broneer, O. (1935) 'Excavations at Corinth, 1934', *American Journal of Archaeology* 39: 53–75; pls. 16–20.
- (1947) 'Investigations at Corinth, 1946–1947', *Hesperia* 16: 233–47.
- Browning, R. (1963) 'A Byzantine treatise on tragedy', in L. Vard/R.F. Willets, *Γέρας: Studies presented to G. Thomson*. Prague: 67–81.
- Burkert, W. (1961) 'Hellenistische Pseudopythagorica', *Philologus* 105: 16–43; 226–46.
- (1962) *Weisheit und Wissenschaft. Studien zu Pythagoras, Philolaos und Platon*. Nuremberg.
- (1972) *Lore and Science in Ancient Pythagoreanism*, trans. E.L. Minar. Cambridge.
- Busch, O. (1998) *Logos syntheseōs. Die euklidische Sectio Canonis, Aristoxenos, und die Rolle der Mathematik in der antiken Musiktheorie*. Berlin.
- Byrne, M. (1993) 'The Dardanos fragments and the 40° angular lyre', *Galpin Society Journal* 46: 3–25.

- (1994) 'The invention of tuning peg and pin in the Hellenistic age', in A. Bélis *et al.* (edd.), *La pluridisciplinarité en archéologie musicale*. Paris: 59–61.
- (1996) 'More on the Dardanos fragments and the 40° lyre', *Galpin Society Journal* 49: 197–8.
- (2000) 'Understanding the aulos', in E. Hickmann / I. Laufs / R. Eichmann (edd.), *Studien zur Musikarchäologie 2. Orient-Archäologie* 7: 279–85.
- (2002a) 'Understanding the aulos II. Extended pipes and drone', in E. Hickmann/A.D. Kilmer/R. Eichmann (edd.), *Studien zur Musikarchäologie 3. Orient-Archäologie* 10: 367–73.
- (2002b) 'The 40° lyre', in E. Hickmann/A.D. Kilmer/R. Eichmann (edd.), *Studien zur Musikarchäologie 3. Orient-Archäologie* 10: 322–33.
- (2004) 'Narrow pipes and the fourth', in E. Hickmann/R. Eichmann (edd.), *Studien zur Musikarchäologie 4. Orient-Archäologie* 15: 391–2.
- Černý, M. K. (1986) 'Druhý zhudebněný fragment z Euripida [Das zweite vertonte Fragment aus Euripides]', *Listy filologické* 109: 132–40.
- Chailley, J. (1967) 'Nouvelles remarques sur les deux notations musicales grecques', *Recherches de Papyrologie* 4: 201–16.
- (1968) 'Nicomaque, Aristote et Terpandre devant la transformation de l'heptacorde grec en octocorde', *Yuval* 1: 132–54.
- (1973) 'La notation archaïque grecque d'après Aristide Quintilien', *Revue des Études Grecques* 86: 17–34.
- (1979) *La musique grecque antique*. Paris.
- Collaer, P. (1960) 'Polyphonies de tradition populaires en Europe méditerranée', *Acta Musicologica* 32: 51–66.
- Comotti, G. (1972) 'L'endecacorde di Ione di Chio', *Quaderni Urbinati di Cultura Classica* 13: 54–61.
- (1977) 'Words, verse and music in Euripides' Iphigenia in Aulis', *Museum Philologum Londiniense* 2: 69–84.
- (1989) *Music in Greek and Roman Culture*. Baltimore/London.
- Conze, A. (1902) 'Die Kleinfunde aus Pergamon', (*Philosophische und historische*) *Abhandlungen der Königlich Preussischen Akademie der Wissenschaften* 1902. Berlin 1903.
- Cosgrove, Ch./Meyer, M.C. (2006) 'Melody and word accent relationships in ancient Greek musical documents: The Pitch Height Rule', *Journal of Hellenic Studies* 126: 66–81.
- Crusius, O. (1894) 'Zu neuentdeckten antiken Musikresten', *Philologus* 52: 160–200.

- Csapo, E. (2004) 'The politics of the New Music', in P. Murray/P. Wilson (edd.), *Music and the Muses. The Culture of Mousike in the Classical Athenian City*. Oxford: 207–48.
- Dawkins, R. M. (1929) 'Objects in carved ivory and bone', in R. M. Dawkins (ed.), *The Sanctuary of Artemis Orthia at Sparta. Journal of Hellenic Studies*, Suppl. 5: 203–48.
- Deonna, W. (1938) *Délos 18. Le mobilier délien*. Paris.
- Devine, A. M./Stephens, L. D. (1994) *The Prosody of Greek Speech*. New York/Oxford.
- D'Ooge, M. L. (1927) *Nicomachus of Gerasa, Introduction to Arithmetic*. Trans. by M. L. D'Ooge, with studies in Greek arithmetic by F. E. Robbins and L. C. Karpinski. New York.
- Duchesne-Guillemin, M. (1984) 'A Hurrian musical score from Ugarit: The discovery of Mesopotamian music', *Sources from the Ancient Near East* No. 2. Malibu: 1–32. [Here cited from: *Monumentum Marcelle Duchesne-Guillemin. Acta Iranica* 34 = 3.19. Leuven 1999.]
- Düring, I. (1934) *Ptolemaios und Porphyrios über die Musik*. Göteborg Hööskolas Årsskrift 40: 1–293.
- Duysinx, F. (1981) 'Accents, mélodie et modalité dans la musique antique', *L'Antiquité Classique* 38: 306–17.
- Eitrem, S./Amundsen, L. (1955) 'Fragments of unknown Greek tragic texts with musical notation. I. The text', *Symbolae Osloenses* 31: 1–29.
- Elschek, O. (2005) 'Begriffliche Differenzierungsmöglichkeiten der mehrstimmigen Singpraxis und Heterophonie', in G. Gruber *et al.* (edd.), *Mehrstimmigkeit und Heterophonie*. Vienna: 37–50.
- Emsheimer, E. (1980) 'Georgische Volksmusik', in *Außereuropäische Musik in Einzeldarstellungen*. Kassel.
- Flourentzos, P. (1991) 'Wind musical instruments from ancient Cyprus', in P. Åström (ed.), *Acta Cypria. Acts of an International Congress on Cypriote Archaeology held in Göteborg on 22–24 August, 1991*. Part 1. *Studies in Mediterranean Archaeology and Literature*, Pocket-book 107: 41–7; pls. 1–4.
- Forstenpointner, G./Fabrizii-Reuer, S./Scherrer, P./Trinkl, E. (2001) "'...und unter der Hand erklang es gewaltig...': Bestattung eines Lyra-spielers in Ephesos aus dem 5. Jh. v. Chr.', in *Festschrift für E. Reuer = Archaeologia Austriaca* 84–5, 2000–2001: 59–79.
- Fortlage, K. (1847) *Das musikalische System der Griechen in seiner Urgestalt aus den Tonleitern des Alypius zum ersten Male entwickelt*. Leipzig.
- Franklin, J. C. (2001) 'Terpander. The invention of music in the Orientalizing period', Diss. University College, London.

- (2002a) 'Musical syncretism in the Greek Orientalizing period', in E. Hickmann/A.D. Kilmer/R. Eichmann (edd.), *Studien zur Musikarchäologie* 3. *Orient-Archäologie* 10: 403–51.
- (2002b) 'Diatonic music in Greece: a reassessment of its antiquity', *Mnemosyne* 55: 669–702.
- (2005) 'Hearing Greek microtones', in S. Hagel/Ch. Harrauer (edd.), *Ancient Greek Music in Performance*. Vienna: 9–50.
- (2006a) 'The wisdom of the lyre: Soundings in ancient Greece, Cyprus and the Near East', in E. Hickmann/A.A. Both/R. Eichmann (edd.), *Studien zur Musikarchäologie* 5. *Orient-Archäologie* 20: 379–95.
- (2006b) 'Lyre gods of the Bronze Age musical koine', *Journal of Ancient Near Eastern Religions* 6: 39–70.
- Funaioli, G. (ed.) (1907) *Grammaticae Romanae Fragmenta*. Leipzig.
- Furtwängler, A. (1906) 'Flötenfragment aus Bein', in *Aegina. Das Heiligtum der Aphaia* 1. Munich: 429; fig. 337.
- Geus, K. (1995) 'Anmerkungen zur "Musiktheorie" des Eratosthenes', *Antike Naturwissenschaft und ihre Rezeption* 5: 49–62.
- Gevaert, F.A. (1881) *Histoire et théorie de la musique de l'antiquité*, II. Gent [reprint Hildesheim 1965].
- Gombosi, O.J. (1939) *Tonarten und Stimmungen der antiken Musik*. Copenhagen.
- Hagel, S. (2000) *Modulation in altgriechischer Musik*. Frankfurt am Main.
- (2001) 'Zur physikalischen Begründung der pythagoreischen Musikbetrachtung', *Wiener Studien* 114: 85–93.
- (2002) 'Musik zwischen Apollon und Dionysos – Der delphische Paian des Athenaios', in E. Hickmann/A.D. Kilmer/R. Eichmann (edd.), *Studien zur Musikarchäologie* 3. *Orient-Archäologie* 10: 403–11.
- (2004a) 'Calculating auloi – the Louvre aulos scale', in E. Hickmann/R. Eichmann (edd.), *Studien zur Musikarchäologie* 4. *Orient-Archäologie* 15: 373–90.
- (2004b) 'Caesura and melody', in F. Spaltenstein/O. Bianchi (edd.), *Autour de la césure*. Bern et al.: 11–22.
- (2005a) 'Twenty-four in auloi: Aristotle, Met. 1093b, the harmony of the spheres, and the formation of the Perfect System', in S. Hagel/Ch. Harrauer (edd.), *Ancient Greek Music in Performance*. Vienna: 51–91.
- (2005b) 'Is *nid qabli* Dorian? Tuning and modality in Greek and Hurrian music', *Baghdader Mitteilungen* 36: 287–348.
- (2006a) 'The context of tunings. Thirds and septimal intervals in ancient Greek music', in E. Hickmann/A.A. Both/R. Eich-

- mann (edd.), *Studien zur Musikarchäologie* 5. *Orient-Archäologie* 20: 281–304.
- (2006b) 'Didymos des Musikers epimorischer Epizentrismus', in W. Lukaseder/J. Huemer (edd.), *Ad maiorem dei gloriam*. St. Pölten: 162–9.
- (2008a) 'Re-evaluating the Pompeii auloi', *Journal of Hellenic Studies* 128: 52–71.
- (2008b) 'Ancient Greek rhythm: The Bellermand exercises', *Quaderni Urbinati di Cultura Classica* 88: 125–38.
- (2008c) 'Reversing the abstraction of ancient music theory. The case of the genera', in A. A. Both *et al.* (edd.), *Studien zur Musikarchäologie* 6. *Orient-Archäologie* 22: 461–75.
- (2009) 'Reconstructing the Hellenistic professional aulos', in M. C. Martinelli *et al.* (edd.), *La Musa dimenticata. Aspetti dell'esperienza musicale greca in età ellenistica*. Pisa: 231–50.
- Hägg, T. (1989) 'Hermes and the invention of the lyre: an unorthodox version', *Symbolae Osloenses* 64: 36–73.
- Hall, E. (1999) 'Actor's song in tragedy', in S. Goldhill/R. Osborne (edd.), *Performance Culture and Athenian Democracy*. Cambridge: 96–122.
- Haslam, M.W. (1976) 'Texts with musical notation', *Oxyrhynchus Papyri* 44: N^o 3161, pp. 58–67; pls. vi–vii.
- (1986a) 'Text with musical notation', *Oxyrhynchus Papyri* 53: N^o 3704, pp. 41–7; pls. iv; vi.
- (1986b) 'Text with musical notation', *Oxyrhynchus Papyri* 53: N^o 3705, pp. 47–8; pl. ii.
- Henderson, M.I. (1942) 'The growth of the Greek ἀρμονία', *Classical Quarterly* 36: 94–103.
- (1957) 'Ancient Greek music', in E. Wellesz (ed.), *Ancient and Oriental Music = New Oxford History of Music*, I. London: 336–403.
- Hipkins, J.A. (1903) 'Dorian and Phrygian', *Sammelbände der Internationalen Musikgesellschaft* 4 (1902/3): 371–81.
- Hogarth, D.G. (1908) *Excavations at Ephesus: The Archaic Artemisia*. London.
- Howard, A.A. (1893) 'The αὐλός or tibia', *Harvard Studies in Classical Philology* 4: 1–63.
- Huffman, C.A. (1993) *Philolaus of Croton. Pythagorean and Presocratic*. Cambridge.
- (2005) *Archytas of Tarentum. Pythagorean, Philosopher and Mathematician King*. Cambridge.
- Husmann, H. (1937) 'Olympos, die Anfänge der griechischen Enharmonik', *Jahrbuch der Musikbibliothek Peters* 44 [1938]: 29–44.

- (1957) Review of Gombosi 1939, *Göttingische Gelehrte Anzeigen* 211: 47–58.
- (1961) *Grundlagen der antiken und orientalischen Musikkultur*. Berlin.
- Jan, C. von (1894) ‘Die Harmonie der Sphären’, *Philologus* 52: 13–37.
- (ed.) (1895) *Musici scriptores Graeci*. Leipzig.
- (1897) Review of Reinach 1986, *Berliner Philologische Wochenschrift* 17: 167–9.
- Johnson, W.A. (2000a) ‘Musical evenings in the Early Empire: new evidence from a Greek papyrus with musical notation’, *Journal of Hellenic Studies* 120: 57–85.
- (2000b) ‘New instrumental music from Graeco-Roman Egypt’, *Bulletin of the American Society of Papyrologists* 37: 17–36.
- Jourdan-Hemmerdinger, D. (1973) ‘Un nouveau papyrus musical d’Euripide (Présentation provisoire)’, *Comptes rendus de l’Académie des inscriptions et belles-lettres*: 292–302.
- (1981) ‘Le nouveau papyrus d’Euripide: Qu’apporte-t-il à la théorie et à l’histoire de la musique?’, in *Les sources en musicologie*. Paris: 35–65.
- Kaba, M. (1976) *Die römische Orgel von Aquincum*. Kassel.
- (2001) *Az Aquincumi orgona* (Kr. u. 228). Budapest.
- Kilmer, A.D. (1965) ‘The strings of musical instruments: Their names, numbers, and significance’, in *Studies in Honour of Benno Landsberger. Publications of the Oriental Institute of the University of Chicago, Assyriological Studies* 16: 261–8.
- (1971) ‘The discovery of an ancient Mesopotamian theory of music’, *Proceedings of the American Philosophical Society* 115: 131–49.
- (1997) ‘Musik. A. 1. In Mesopotamien’, in *Reallexikon der Assyriologie und Vorderasiatischen Archäologie* 8. Berlin: 463–82.
- (2001) ‘Mesopotamia’, in *The New Grove Dictionary of Music and Musicians*, 2nd edn, 16. London: 480–7.
- Kostoglou, K. (1970) (Κώστογλου, Κ.) ‘Ανασκαφικαὶ Ἐργασίαι. Καρυῶτες’, *Αρχαιολογικὸν Δελτίον* 25, Χρονικά: 329–32.
- Krispijn, Th.J.H. (2002) ‘Musik in Keilschrift. Beiträge zur altorientalischen Musikforschung 2’, in E. Hickmann/A.D. Kilmer/R. Eichmann (edd.), *Studien zur Musikarchäologie* 3. *Orient-Archäologie* 10: 465–79.
- Kritzas, C.B. (1980) ‘Muses Delphiques à Argos’, *Bulletin de Correspondance Hellénique* suppl. 6: 195–209.
- Kunz, L. (1936) ‘Die Tonartenlehre des Boethius’, *Kirchenmusikalisches Jahrbuch* 31: 5–24.

- Laloy, L. (1904) *Aristoxène de Tarente*. Paris.
- Landels, J.G. (1963) 'The Brauron aulos', *Annual of the British School at Athens* 58: 116–19.
- (1964) 'Fragments of auloi found in the Athenian agora', *Hesperia* 33: 392–400; pl. 70.
- (1967) 'Assisted resonance in ancient theatres', *Greece and Rome* 14: 80–94.
- (1968) 'A newly discovered aulos', *Annual of the British School at Athens* 63: 231–8; pl. 55.
- (1981) 'The reconstruction of ancient Greek auloi', *World Archaeology* 12: 298–302.
- (1999) *Music in Ancient Greece and Rome*. London/New York.
- Lasserre, F. (1954) *Plutarque, De la musique*. Texte, traduction, commentaire précédés d'une étude sur l'éducation musicale dans la Grèce antique. Lausanne.
- (1988) 'Musica Babilonense e Musica Greca', in B. Gentili/R. Pretagostini (edd.), *La musica in Grecia*. Rome: 72–95.
- Latte, K. (1954) 'Zur Geschichte der griechischen Tragödie in der Kaiserzeit', *Eranos* 52: 125–7.
- Lawergren, B. (1984) 'The cylinder kithara in Etruria, Greece, and Anatolia', *Imago Musicae* 1: 147–74.
- (1993) 'Lyres in the West (Italy, Greece) and the East (Egypt, the Near East), ca. 2000–400 B.C.', *Opuscula Romana* 19.6: 55–76.
- (1996) 'Leier (Alttertum)', in *Die Musik in Geschichte und Gegenwart*, 2nd edn, Sachteil 5. Kassel et al.: 1011–38.
- (1998) 'Distinctions among Canaanite, Philistine, and Israelite lyres, and their global lyrical contexts', *Bulletin of the American Schools of Oriental Research* 309: 41–68.
- Lawson, G. (2005) 'Ancient European lyres: excavated finds and experimental performance today', in S. Hagel/Ch. Harrauer (edd.), *Ancient Greek Music in Performance*. Vienna: 93–119.
- (2008) 'Representation and reality in the Late Roman world. Some conflicts between excavated finds and popular images of panpipes, lyres and lutes', in A. A. Both et al. (edd.), *Studien zur Musikarchäologie* 6. *Orient-Archäologie* 22: 179–96.
- Letters, R.J. (1969) 'The scales of some surviving auloi', *Classical Quarterly* 19: 266–8.
- Levin, F. (1961) 'The hendecachord of Ion of Chios', *Transactions of the American Philological Association* 92: 295–307.
- (1995) *The Manual of Harmonics of Nicomachus the Pythagorean*. Translation and commentary. Grand Rapids.

- Litvinsky, B. A. (1999) (Литвинский, Б.А.) 'греческие флейты (авлосы) в глубинной азии'. 'Greek flutes (auloi) in Central Asia', in *Monumentum Marcelle Duchesne-Guillemin. Acta Iranica* 3.19: 517–43.
- Maas, M. (1992) 'Polychordia and the fourth century lyre', *Journal of Musicology* 10: 74–88.
- Maas, M./Snyder, J. M. (1989) *Stringed Instruments of Ancient Greece*. New Haven / London.
- Macran, H. S. (1902) *The Harmonics of Aristoxenus*. Ed. with translation, notes, and introduction. Oxford [reprint Hildesheim 1974].
- Masaraki, D. W. (1974) 'Ein Aulos der Sammlung Karapanos', *Mitteilungen des Deutschen Archäologischen Instituts (Athen. Abt.)* 89: 105–21.
- Mathiesen, T. J. (1981) 'New fragments of ancient Greek music', *Acta Musicologica* 53: 14–32.
- (1999) *Apollo's Lyre*. Lincoln / London.
- (2007) Review of S. Hagel / Ch. Harrauer (edd.), *Ancient Greek Music in Performance*. Vienna 2005, *Music & Letters* 88: 316–22.
- Meier, S. (2004) *Psalmen, Lobgesänge und geistliche Lieder. Studien zur musikalischen Exegese und biblischen Grundlegung evangelischer Kirchenmusik*. Frankfurt am Main et al.
- Monro, D. B. (1894) *The Modes of Ancient Greek Music*. Oxford.
- Mountford, J. F. (1920) 'Greek music and its relation to modern times', *Journal of Hellenic Studies* 40: 13–42.
- (1923) 'The musical scales of Plato's Republic', *Classical Quarterly* 17: 125–36.
- Najock, D. (1996) 'Aristoxenos und die Auloi', in R. Faber / B. Seidensticker (edd.), *Worte. Bilder. Töne*. Würzburg: 59–76.
- (1972) *Drei anonyme griechische Traktate über die Musik. Eine kommentierte Neuausgabe des Bellermannschen Anonymus*. Göttingen.
- Neumaier, W. (1986) *Was ist ein Tonsystem? Eine historisch-systematische Theorie der abendländischen Tonsysteme, gegründet auf die antiken Theoretiker Aristoxenos, Eukleides und Ptolemaios, dargestellt mit Mitteln der modernen Algebra*. Frankfurt am Main et al.
- Olsen, P. R. (1967) 'An aulos in the Danish National Museum', *Dansk Aarvog for Musikforskning* 1966–1967: 1–9.
- Päll, J. (2004) 'CIL IV 2305: Ein Fragment römischer Musik?' *Zeitschrift für Papyrologie und Epigraphik* 148: 313–15.
- Paquette, D. (1984) *L'instrument de musique dans la céramique de la Grèce antique*. Paris.

- Pearl, O.M./Winnington-Ingram, R.P. (1965) 'A Michigan papyrus with musical notation', *Journal of Egyptian Archaeology* 51: 179–95.
- Pizzani, U. (1965) 'Studi sulle fonti del "De Institutione Musica" di Boezio', *Sacris erudiri* 16: 5–164.
- Plommer, H. (1983) 'Scythopolis, Caesarea and Vitruvius: sounding-vessels in ancient theatres', *Levant* 15: 132–40.
- Pöhlmann, E. (1960) *Griechische Musikfragmente*. Nuremberg.
- (1966) 'Ein neues griechisches Musikfragment der Wiener Papyrussammlung', *Hermes* 94: 501–4.
- (1970) *Denkmäler Altgriechischer Musik*, Nuremberg.
- (1975) Review of Najock 1972, *Die Musikforschung* 28: 482–3.
- (1976) 'Die Notenschrift in der Überlieferung der griechischen Bühnenmusik', *Würzburger Jahrbücher* N.F. 2: 53–73. [Here cited from Pöhlmann (1988): 57–93.]
- (1986) 'Zur Frühgeschichte der Überlieferung griechischer Bühnendichtung und Bühnenmusik', in *Festschrift für Martin Ruhnke*. Erlangen: 294–306. [Here cited from Pöhlmann (1988): 23–40.]
- (1988) *Beiträge zur antiken und neueren Musikgeschichte*. Frankfurt am Main.
- (1994) 'Musiktheorie in spätantiken Sammelhandschriften', in A. Bierl/P.v. Möllendorff/S. Vogt (edd.), *Orchestra. Drama, Mythos, Bühne*. Munich: 182–94.
- (1995) 'Griechenland. A. Antike Musik', in *Die Musik in Geschichte und Gegenwart*, 2nd edn, Sachteil 3. Kassel et al.: 1627–76; 1705–9.
- (1997) 'Notation, II. Antike', in *Die Musik in Geschichte und Gegenwart*, 2nd edn, Sachteil 7. Kassel et al.: 283–9; 417.
- (2005) 'Dramatische Texte in den Fragmenten antiker Musik', in S. Hagel/Ch. Harrauer (edd.), *Ancient Greek Music in Performance*. Vienna: 131–45.
- Pöhlmann, E./Tichy, E. (1982) 'Zur Herkunft und Bedeutung von κόλλοψ', in J. Tischler (ed.), *Serta Indogermanica = Innsbrucker Beiträge zur Sprachwissenschaft* 40. Innsbruck: 287–315.
- Porter, J.I. (2007) 'Lasus of Hermione, Pindar, and the riddle of s', *Classical Quarterly* 57: 1–21.
- Poulianos, A. (1960) (Πουλιανός, Α.) 'Η προέλευση των Ελλήνων [The origin of the Greeks]', Ph.D. Moscow Institute for Anthropology [reprints Athens 1962 ... 2004].
- (1971) (Πουλιανός, Α.) *Η καταγωγή των Κρητών*. Athens [reprints 1999, 2001].

- Poursat, J.-C. (1968) 'Les représentations de danse armée dans la céramique attique', *Bulletin de Correspondance Hellénique* 92: 550–615.
- Power, T. (2007) 'Ion of Chios and the politics of *polychordia*', in V. Jennings / A. Katsaros (edd.), *The World of Ion of Chios. Mnemosyne Supplementum* 288. Leiden.
- Prauscello, L. (2006) *Singing Alexandria. Music between Practice and Textual Transmission*. Leiden/Boston.
- Psaroudakēs, S. (2002) 'The aulos of Argitheia', in E. Hickmann/A.D. Kilmer/R. Eichmann (edd.), *Studien zur Musikarchäologie* 3. *Orient-Archäologie* 10: 335–66.
- (2004) 'The Orestes Papyrus: Some thoughts on the dubious musical signs', in E. Hickmann/R. Eichmann (edd.), *Studien zur Musikarchäologie* 4. *Orient-Archäologie* 15: 471–92.
- (2008) 'The auloi of Pydna', in A.A. Both *et al.* (edd.), *Studien zur Musikarchäologie* 6. *Orient-Archäologie* 22: 197–216.
- Raffa, M. (2002) *La Scienza Armonica di Claudio Tolomeo*. Saggio critico, traduzione e commento. Messina.
- Redondo Reyes, P. (2002) *La Harmónica de Ptolomeo*. Edición crítica con introducción, traducción y comentario. Diss. Univ. Murcia [CD].
- (2003a) 'Claudio Ptolomeo y los modos musicales griegos', *Myrtia* 18: 237–59.
- (2003b) 'La medida del $\Lambda\epsilon\acute{\iota}\mu\mu\alpha$ en la música griega antigua', *Florentia Iliberritana* 14: 295–314.
- Reinach, Th. (1896) 'Deux fragments de musique grecque', *Revue des Études Grecques* 9: 186–215.
- (1897) 'Fragments musicologiques inédits', *Revue des Études Grecques* 10: 313–27.
- (1900) 'La musique des sphères', *Revue des Études Grecques* 13: 432–49.
- (1912) 'Les Hymnes delphiques à Apollon avec notes musicales', Paris = 'Hymnes avec notes musicales', *Fouilles de Delphes* 3.2 (1909–13): 147–69; 332; pl. x.
- Restani, D. (1983) 'Il *Chirone* di Ferecrate e la "nuova" musica greca', *Rivista italiana di musicologia* 18: 139–92.
- (1984) 'In margine al *Chirone* di Ferecrate', *Rivista italiana di musicologia* 19: 203–5.
- Richter, L. (1968) 'Die Neue Musik der griechischen Antike', *Archiv für Musikwissenschaft* 25: 1–18; 134–47.
- (1999) 'Struktur und Rezeption antiker Planetenskalen', *Die Musikforschung* 52: 289–306.

- (2000) *Pathos und Harmonia: melodisch-tonale Aspekte der attischen Tragödie*. Frankfurt am Main et al.
- Riemann, H. (1902) 'Die dorische Tonart als Grundskala der griechischen Notenschrift', *Sammelbände der Internationalen Musikgesellschaft* 4 (1902-3): 558-69.
- Roberts, H. (1981) 'Reconstructing the Greek tortoise-shell lyre', *World Archaeology* 12: 303-12; pls. 67-74.
- Rocconi, E. (1998) '*Harmoniai* e teoria dei *gene* musicali nella Grecia antica', *Seminari Romani di cultura greca* 1: 345-63.
- (2002) 'The development of vertical direction in the spatial representation of sound', in E. Hickmann/A.D. Kilmer/R. Eichmann (edd.), *Studien zur Musikarchäologie* 3. *Orient-Archäologie* 10: 389-92.
- (2003) *Le parole delle Muse: La formazione del lessico tecnico musicale nella Grecia antica*. *Seminari Romani di cultura greca: Quaderni* 5, Rome.
- (2004) 'Colours in music: Metaphoric musical language in Greek antiquity', in E. Hickmann/R. Eichmann (edd.), *Studien zur Musikarchäologie* 4. *Orient-Archäologie* 15: 29-34.
- Roch, E. (2001) *Chroma – Color – Farbe. Ursprung und Funktion der Farbmetapher in der antiken Musiktheorie*. *Neue Studien zur Musikwissenschaft* 7, Mainz et al.
- Ruelle, C.-E. (1875) 'Études sur l'ancienne musique grecque', *Archives des missions scientifiques et littéraires* 3/2: 497-627.
- Rutherford, I. (1995) 'Apollo's other genre: Proclus on nomos and his source', *Classical Philology* 90: 354-61.
- Sachs, C. (1921) *Die Musikinstrumente des alten Ägyptens*. *Mitteilungen aus der Ägyptischen Abteilung der Staatmuseen* 3, Berlin.
- (1924) 'Die griechische Instrumentalnotenschrift', *Zeitschrift für Musikwissenschaft* 6 (1923/24): 289-301.
- (1925) 'Die griechische Gesangsnotenschrift', *Zeitschrift für Musikwissenschaft* 7 (1924/25): 1-5.
- (1943) *The Rise of Music in the Ancient World East and West*. New York.
- (1962) *The Wellsprings of Music*. Ed. J. Kunst, The Hague.
- Sarti, S. (2003) 'La kithara greca nei documenti archeologici', *Revue belge de philologie et d'histoire* 81: 47-68.
- Scheltema, H.J. (1933) 'De antiphonia', *Mnemosyne* 60 (1932-3): 239-53.
- Schlesinger, K. (1939) *The Greek Aulos*. London [reprint Groningen 1970].
- Schröder, S. (1999) 'Zwei Überlegungen zu den Liedern vom Athenerschattenshaus in Delphi', *Zeitschrift für Papyrologie und Epigraphik* 128: 65-75.

- Schumacher, R. (2005) 'Heterophonie – ad infinitum?', in G. Gruber *et al.* (edd.), *Mehrstimmigkeit und Heterophonie*. Vienna: 51–66.
- Shehata, D. (2002) 'Contributions to the music theory system of Mesopotamia', in E. Hickmann/A.D. Kilmer/R. Eichmann (edd.), *Studien zur Musikarchäologie 3. Orient-Archäologie* 10: 487–96.
- Solomon, J. (1984) 'Towards a history of *tonoi*', *Journal of Musicology* 3: 242–51.
- (1986) 'The Seikilos inscription: a theoretical analysis', *American Journal of Philology* 107: 455–79.
- (2000) *Ptolemy Harmonics*. Translation and commentary. Leiden *et al.*
- Spyridis, Ch. (1990) (Σπυρίδης, Χ.) *Το επίγραμμα στο δαχτυλίδι του Eserovo*. Thessalonica.
- (1993) 'Ο Άβαξ του Λαυρίου', *Archaiologia* 47: 65–72.
- (1999) 'Ένα αρχαίο μουσικό επίγραμμα από τό νησί της Αερί-ας (Θάσου)', in *International Meeting on Music. Music and Ancient Greece, 5–15 August 1996, Symposium Proceedings*. Athens: 169–94.
- Steinmann, C./Reichlin, P.J. (2006) 'Instruments and their music from the 5th century BC in classical Greece', in E. Hickmann/A.A. Both/R. Eichmann (edd.), *Studien zur Musikarchäologie 5. Orient-Archäologie* 20: 237–54.
- Strauß, M. (1994) 'Instruments à cordes dans un tumulus et la musique des morts', in A. Bélis *et al.* (edd.), *La pluridisciplinarité en archéologie musicale*. Paris: 101–10.
- Stubbings, J.M. (1962) 'Ivories', in T.J. Dunbabin (ed.), *Perachora: The Sanctuaries of Hera Akraia and Limenia*, II. Oxford: 403–51.
- Swerdlow, N.M. (2009) 'Anticipations of Ptolemy's *Canobic Inscription* in Plutarch's *On the Generation of the Soul in the Timaeus*', in G. Gnoli / A. Panaino (edd.), *Kayd: Studies in history of mathematics, astronomy and astrology in memory of David Pingree*. Rome: 151–6.
- Szigeti, K. (1971) 'Die ungenlöste Probleme der römischen Orgel von Aquincum', *Studia Musicologica* 13: 3–13.
- Tannery, P. (1915) *Mémoires scientifiques*, III: *sciences exactes dans l'antiquité*. Ed. J.-L. Heiberg/H.-G. Zeuthen. Toulouse/Paris.
- Themelis, D. (1989) 'Zwei neue Funde altgriechischer Musik aus Laureotike und aus Pelion', *Die Musikforschung* 42: 307–25.
- (1994) 'Eine antike Musikinschrift aus dem Heiligtum des Herakles Pankrates', *Die Musikforschung* 47: 349–64.
- (1999) (Θέμελης, Δ.) 'Μουσική επιγραφή από τη Μεσσήνη', in *International Meeting on Music. Music and Ancient Greece, 5–15 August 1996, Symposium Proceedings*. Athens: 163–7.
- Thurn, N. (1998) 'Die siebensaitige Lyra', *Mnemosyne* 51: 411–34.

- van Akkeren, A. (1983) 'Muziek van Euripides', *Hermeneus* 55: 259–71.
- van der Waerden, B.L. (1943) 'Die Harmonielehre der Pythagoreer', *Hermes* 78: 163–99.
- Vendries, Ch. (1999) *Instruments à cordes et musiciens dans l'Empire romain*. Paris.
- Vogel, M. (1963a) *Die Enharmonik der Griechen*. 1. Teil: *Tonsystem und Notation*. Düsseldorf.
- (1963b) *Die Enharmonik der Griechen*. 2. Teil: *Der Ursprung der Enharmonik*. Düsseldorf.
- Walcker-Mayer, W. (1970) *Die römische Orgel von Aquincum*. Stuttgart.
- Wallace, R.W. (1995) 'Music theorists in fourth-century Athens', in B. Gentili / F. Perusino (edd.), *Mousike. Metrica ritmica e musica greca*. Pisa/Rome: 17–39.
- (2003) 'An early fifth-century Athenian revolution in aulos music', *Harvard Studies in Classical Philology* 101: 73–92.
- (2005) 'Performing Damon's *harmoniai*', in S. Hagel / Ch. Harrauer (edd.), *Ancient Greek Music in Performance*. Vienna: 147–57.
- Wehrli, F. (1945) *Die Schule des Aristoteles*, II: *Aristoxenos*. Basle.
- West, M.L. (1981) 'The singing of Homer and the modes of early Greek music', *Journal of Hellenic Studies* 101: 113–29.
- (1986) 'The singing of hexameters: evidence from Epidaurus', *Zeitschrift für Papyrologie und Epigraphik* 63: 39–46.
- (1992a) 'Analecta Musica', *Zeitschrift für Papyrologie und Epigraphik* 92: 1–54.
- (1992b) 'An alleged musical inscription', *Zeitschrift für Papyrologie und Epigraphik* 93: 27–8.
- (1994) 'The Babylonian musical notation and the Hurrian melodic texts', *Music & Letters* 75: 161–79.
- (1998) 'Texts with musical notation', *Oxyrhynchus Papyri* 65: № 4461–4467, pp. 81–102; pls. XII–XIV.
- (1999) 'Sophocles with music? Ptolemaic music fragments and remains of Sophocles (Junior?)', *Achilleus*, *Zeitschrift für Papyrologie und Epigraphik* 126: 43–65; pls. IX–XII.
- (2007) 'A new musical papyrus: Carcinus, *Medea*', *Zeitschrift für Papyrologie und Epigraphik* 161: 1–10.
- Westphal, R. (1886) *Griechische Harmonik und Melopoeie*. 3rd edn, Leipzig.
- Willink, C.W. (2001) 'Again the Orestes "musical papyrus"', *Quaderni Urbinati di Cultura Classica* 68: 125–33.
- Wilson, P. (1999) 'The *aulos* in Athens', in S. Goldhill / R. Osborne (edd.), *Performance Culture and Athenian Democracy*. Cambridge: 58–95.

- (2004) 'Athenian strings', in P. Murray / P. Wilson (edd.), *Music and the Muses. The Culture of Mousike in the Classical Athenian City*. Oxford: 269–306.
- Winnington-Ingram, R.P. (1928) 'The Spondeion scale', *Classical Quarterly* 22: 83–91.
- (1932) 'Aristoxenus and the intervals of Greek music', *Classical Quarterly* 26: 195–208.
- (1936) *Mode in Ancient Greek Music*. Cambridge.
- (1955) 'Fragments of unknown Greek tragic texts with musical notation: The music', *Symbolae Osloenses* 31: 29–87.
- (1956) 'The pentatonic tuning of the Greek lyre: A theory examined', *Classical Quarterly* 6: 169–86.
- (1958) Review of: E. Wellesz (ed.), *Ancient and Oriental Music = New Oxford History of Music*, 1. London 1957; H. Sanden, *Antike Polyphonie*. Heidelberg 1975, *Gnomon* 30: 243–7.
- (1973) 'The first notational diagram of Aristides Quintilianus', *Philologus* 117: 243–9.
- (1978) 'Two studies in Greek musical notation', *Philologus* 122: 237–48.
- Winnington-Ingram, R.P. / Turner, E. (1959) 'Monody with musical notation', *Oxyrhynchus Papyri* 25: № 2436, pp. 113–22; pl. XIV.
- Wulstan, D. (1968) 'The tuning of the Babylonian harp', *Iraq* 30: 215–28.
- (1971) 'The earliest musical notation', *Music & Letters* 52: 365–82.
- Yuan, J. (2005) 'Fragment with musical notation', *Oxyrhynchus Papyri* 69: № 4710, pp. 45–6; pl. I.

Indices

ANCIENT PASSAGES CITED

Bold page numbers indicate full quotations in the text.

- Ach.
Intr. Arat.
 17.2, p. 24-5 • 46
- Adrastus
ap. Theon, Util. math.
 51 • 86
 55.11-15 • 163
 64.1-4 • 3
 65.10-66.11 • 180
 66.24-67.4 (?) • 206
- Aelian.
Var. hist.
 14.14 • 199
ap. Porph., in Harm.
 34.11-16 • 412
 96.29-30 • 373
- Aeschyl.
Prom.
 310-11 • 422
 Σ *Pers.* 938 • 396
- Alex. Aphr.
Probl.
 2.63.25-30 • 369
- Alexander of Ephesus
ap. Theon, Util. math., 138-41 • 46
- Alypius • 9, 21, 30, 301, 367
 p. 384 • 51
- Anecd. Stud.
 3-7 • 167
 4-7 • 168
 5-7 • 148
 14-19 • 167
- Anon. Bell.
 § 4 • 310
- § 6-7 • 309
 § 28 • 53-4, 274
 § 64 • 94
 § 65 • 260
 § 66 • 110
 § 77+79 • 98, 166
 § 88-9 • 309
 § 91-2 • 310
 § 94 • 71
 § 96 • 98
- Anth. Pal.*
 11.78.3-4 • 269
 11.352 • 90, 254
 16.28 • 378
- Antiphanes
ap. Ath., 643d • 447
- Anton. Lib.
 22.6 • 78
- Apollod.
ap. Theocr. Σ 2.35/36b • 69
- Apul.
Flor.
 4 • 63
- Arat.
 Σ 269 • 81
- Archyt.
 fr. 1 • 176
- Aristid. Quint.
 1.7, p. 11.14-17 • 383
 1.7, p. 12-13 • 17, 383
 1.8, p. 14.24-6 • 5
 1.8, p. 15.8-15 • 374
 1.8, p. 15.11-15 • 387
 1.9, p. 18.5-8 • 391

- 1.9, p.18.6–8 • 411
 1.9, p.18.9–10 • 392
 1.9, p.18–20 • 18
 1.9, p.19.2–7 • 392
 1.9, p.19.7–10 • 392
 1.10, p.21.1–4 • 4, 63
 1.10, p.21.8–12 • 9
 1.10, p.21.13–22.10 • 69, 127
 1.11, p.22.25 • 22
 1.11, p.23.1 • 5
 1.11, p.23.18–22 • 2
 1.11, p.23.25–24.6 • 101
 1.11, p.24–7 • 4, 301
 1.11, p.26 • 45
 1.11, p.26.16–17 • 21
 1.11, p.28.1–7 • 400
 1.11, p.28.6–7 • 282
 1.12, p.30.1–4 • 421
 1.14, p.33.14–28 • 260
 1.19, p.40.1–7 • 260
 2.12, p.77.19–20 • 109
 2.14, p.79.2–81.6 • 392
 2.18, p.90.2–5 • 69
 2.19, p.92.19–25 • 448
 2.19, p.93 • 98
 3.1, p.95.19–96.17 • 186
 3.1, p.96.20–5 • 185
 3.2, p.97.17–98.21 • 126, 166
- Aristoph.
- Equ.*
 984–96 • 105
 987–96 • 9
- Nub.*
 113 • 434
 333 • 270
 969–70 • 270
- Thesm.*
 100 • 269
- ap. Pollux*
 4.64 • 270
- Σ *Nub.*
 292 • 69
 967 • 394
- Σ *Ran.* 231 • 90
- Aristot.
- An. post.*
 84b • 152, 383
- Gen. anim.*
 787b • 405
 787b • 90
- Met.*
 993b • 111, 270
 1016b • 152, 383
 1018b • 117
- 1053ab • 152, 383
 1087b • 152, 383
 1093b • 30, 333
- Pol.*
 1254a • 121
 1276b • 103
 1290a • 429
 1340a • 407
 1340b • 9
 1341a • 3
 1342a • 447
 1342ab • 9
 1342b • 388, 405
ap. Plut., Pericl. 4.1 • 373
ap. [Plut.], Mus.
 1139bc • 112
- [Aristot.]
- Aud.*
 800b • 176, 321
 804a • 74
- Pr.*
 19.3 • 93, 432
 19.3–4 • 104, 115, 120
 19.7 • 104–5, 120, 254
 19.12 • 120
 19.18–19 • 119
 19.20 • 120
 19.24 • 120
 19.25 • 120
 19.32 • 35, 104, 120
 19.33 • 119
 19.36 • 121–2
 19.37 • 432
 19.39 • 409
 19.42 • 120
 19.44 • 120–1
 19.47 • 104–5, 120
 19.48 • 433
- Aristox.
- Harm.*
 1.2, p.6.6–19 • 20, 375
 1.5, p.9.16–10.2 • 374
 1.6, p.10.19–20 • 374
 1.6, p.11.3–10 • 374
 1.7, p.12.8–16 • 383
 1.19, p.24.20–25.4 • 10, 398
 1.19, p.25.2–4 • 417
 1.19, p.25.3–4 • 421
 1.20, p.25.13–15 • 409
 1.20, p.26.2–7 • 71
 1.20, p.26.8–10 • 336
 1.20–1, p.26.8–27.1 • 292
 1.21–7, p.28.3–35.8 • 173
 1.22, p.28.13–29.2 • 375

1.22-3, p.29.7-12 • 400
 1.22-3, p.29.10-12 • 420
 1.23, p.29.14-30.5 • 24
 1.23, p.29.14-30.8 • 148, 414
 1.23, p.30.1-5 • 154
 1.24, p.31.1 • 24
 1.24, p.31.3-5 • 173
 1.25-6, p.32.7-33.15 • 183
 1.26, p.34.14-17 • 172
 1.27, p.34.19-35.3 • 172-3
 1.27, p.35.3-7 • 172
 1.27, p.36.1-6 • 384
 1.28, p.36.9-11 • 148
 1.28, p.36.12 • 400
 1.29, p.37.8 • 400
 2.32, p.41.19-42.3 • 153
 2.33, p.42.13-21 • 421
 2.34, p.44.5 • 421
 2.35, p.44.15-22 • 11, 155
 2.35, p.44.20-1 • 421
 2.36-7, p.46.6-12 • 375
 2.36-7, p.46.10-12 • 373
 2.37, p.46.18-20 • 377
 2.37, p.47.1-13 • 4
 2.37-8, p.46.17-47.16 • 427
 2.37-8, p.47.1-16 • 379
 2.37-8, p.47.7-13 • 155
 2.38, p.47.15-16 • 382
 2.38, p.47.20 • 282
 2.39, p.49.1-5 • 385
 2.39-41, p.49-51 • 3
 2.40 • 95
 2.40, p.50.4-7 • 3
 2.40, p.50.4-9 • 141
 2.40, p.50.16 • 421
 2.40, p.51.1 • 371, 385
 2.41-3, p.52.9-53.16 • 369
 2.44, p.55.10-11 • 159, 266
 2.45, p.56.3-8 • 409
 2.46, p.57.13-16 • 116
 2.46-52, p.57.13-65.20 • 173
 2.48, p.61.5-9 • 148
 2.49, p.61.5-11 • 154
 2.49, p.61.11-12 • 116
 2.49, p.62.17 • 154
 2.51, p.64.8-11 • 400
 2.51, p.64.13 • 400
 2.51, p.65.4-20 • 172
 2.51, p.65.18-20 • 174
 2.52, p.65.2-16 • 173
 2.52, p.65.12-15 • 207
 2.54, p.68.1-6 • 116
 2.54-5, p.68.7-9 • 116
 2.55, p.68.10-16 • 207
 2.55-6, p.68.15-70.6 • 24

3.58-60, p.73.4-75.10 • 116
 3.63, p.79.1 • 401
 3.63-72, p.79-90 • 153
 3.64, p.80.3-10 • 401
 3.64, p.80.11 • 400
 3.64, p.81.6 • 400
 3.65, p.81.8-10 • 400
 3.65, p.81.9-12 • 401
 3.65, p.81.13-82.1 • 400
 3.66, p.82.16 • 400
 3.68, p.85.1-8 • 153
 3.74, p.92.6-11 • 116
 3.74, p.92.12-17 • 115, 262
Rhythm.
 22-9, p.14-15 • 260
ap. Ath.
 176ef • 93, 292
 634ef • 93, 292
ap. Clem., Strom.
 6.11.88.1 • 355, 403, 408
ap. Diog. Laer. 8.82 • 175
ap. Plut., Quaest. conviv.
 711c • 416
ap. [Plut.], Mus.
 1132e • 426
 1133d • 426
 1134e • 426
 1134f • 407
 1134f-1135a • 175, 394
 1134f-1135b • 155
 1134f-1135c • 397-8
 1135a • 121, 159
 1135b • 22, 424
 1135c • 424
 1135d • 426
 1136c • 395
 1137a • 440
 1137a-d • 392
 1137b • 105, 159, 402, 416, 436
 1137bc • 155
 1137b-d • 403, 407
 1137c • 257, 394, 407
 1137d • 3, 22-3, 27, 35, 73, 411
 1137de • 368, 446
 1137f • 426, 447
 1142bc • 389, 423
 1142f • 388
 1143e • 381, 421, 425
 1145ab • 415
 1145b • 160
 1145bc • 383
 1145d • 140
ap. Themist., Or.
 364b • 426

ap. Theon, Util. math.

56.1-3 • 417, 421

Ath.

176e • 195
 176ef • 93, 292, 336
 182c • 93
 184d • 378
 184e • 176
 352cd • 375
 598e • 397
 617b • 429
 618c • 407
 624c • 4
 624c-626a • 430
 624f • 431
 625a • 431
 625d • 49, 101, 106, 187
 625e • 430
 631e • 378
 634ef • 93, 292, 336
 635c • 5
 637-8 • 12, 94
 637c-f • 378
 638a • 368, 447
 643d • 447

Bacchius

11-18, p. 293-297 • 98
 15, p. 296.16-297.7 • 387
 29-42, p. 299-302 • 98
 46, p. 303.3-6 • 5
 47, p. 303.7-9 • 42
 50, p. 304.6-7 • 260
 75, p. 308.8-10 • 116
 77, p. 309.8-9 • 430
 88, p. 312.7-11 • 260

Boeth.

Inst. mus.

1.20, p. 205.28-206.6 • 82
 1.20, p. 205-6 • 112
 1.20, p. 205-9 • 80
 1.20, p. 206.10-207.7 • 105
 1.20, p. 208.10-11 • 81
 1.20, p. 208.10-16 • 22
 1.22, p. 214-16 • 84
 1.27, p. 219.4-25 • 105
 2.30, p. 263-4 • 164
 3.4, p. 275.6-276.13 • 144
 3.5, p. 276.15-277.18 • 144-5
 3.5, p. 277.4-18 • 145
 3.7, p. 278.8-9 • 144
 3.8, p. 278.11-16 • 144
 3.9, p. 281-3 • 164
 3.10, p. 285.1-2 • 152
 3.11, p. 285-6 • 150

3.13, p. 293.7-9 • 152
 3.14-16, p. 293-300 • 144
 3.15, p. 295.20-296.29 • 165
 3.15, p. 295-6 • 164
 3.16, p. 297.10-298.6 • 145
 4.3, p. 308-14 • 98
 4.3-4, p. 310-12 • 51
 4.5-12, p. 314-35 • 164
 4.6, p. 318.4-6 • 98
 4.6, p. 320.24-321.9 • 165
 4.6, p. 321.15-322.2 • 165
 4.15, desc. II. p. 343 add. • 42, 432
 4.15, p. 341.19-21 • 99
 4.15, p. 342.12-14 • 99
 4.17, p. 343.17-19 • 99
 4.17, p. 347.21-348.2 • 387
 4.18, p. 348.2-3 • 100

Bryenn.

Harm.

1.8 • 100

Cassiod.

Var.

2.40 • 87
 2.40.4-5 • 63

Censorinus

de die natali

13, p. 22.10-24.14 • 46

Cic.

De or.

3.225 • 68

Clem.

Strom.

1.16.76.4 • 395
 1.21.131.4 • 378
 6.11.88.1 • 355, 403, 408

Cleonid.

4, p. 184-6 • 110
 5, p. 187.10-12 • 448
 5, p. 187.15-19 • 409
 5, p. 189.2-8 • 141
 9, p. 196.20-197.3 • 262
 9, p. 197.4-199.3 • 387
 9, p. 197.7 • 374
 9, p. 198.13 • 430
 10, p. 199.4-7 • 383
 10, p. 200-1 • 95
 11, p. 201.14-18 • 5
 11, p. 201.14-202.5 • 282
 11, p. 202.3-5 • 121, 122
 12, p. 202.11-12 • 440
 12, p. 202.14-17 • 61, 87, 105, 283, 373
 13, p. 204.19-206.5 • 260
 13, p. 205.10-11 • 4

- 13, p. 205.10-19 • 264
13, p. 205.10-206.2 • 44
- Didymus
ap. Porph. in Harm.
26.20-5 • 194
- Dio Chrys.
2.56 • 270
68.7 • 121
ap. Stob.
4.19.46 • 431
- Diod. Sic.
1.16.1 • 133
- Diog. Laer.
8.8 • 378
8.82 • 175
9.40 • 372
- Dion. Thrax
Σ Gramm. Gr. 1.3, 476.33 • 5
- Dionys. Hal.
Ant. Rom.
2.19.4 • 407
Comp. verb.
11.63-4 • 24
19 • 378, 423
Dem.
22 • 394
46 • 447
- Duris
ap. Ath.
184d • 378
618c • 407
- [Euclides] • v. *Sect. can.*
- Eupolis
ap. Suda, s.v. βασιτάσας • 422
- Eurip.
Bacchae
160 • 397
687 • 397
El.
716 • 397
Hel.
171 • 397
1351 • 434
Heraclid.
892 • 397
Iph. Aul.
438 • 397
1036 • 397
Phoen.
787 • 397
- Tr.*
544 • 397
Σ *Or.*
176 • 22
1384 • 403
- Exc. Neap.*
17, p. 416.2-9 • 155, 183
19, p. 416.12-417.11 • 186
24, p. 418.14-420.6 • 166
- Exc. Nicom.*
1, p. 266 • 82
2, p. 267.1-268.2 • 143
3, p. 271.16 • 82
4, p. 274.1-12 • 83
4, p. 274.3 • 81
- Favonius Eulogius
Comm. somn. Scip.
26.8 • 338
- Frag. Cens.*
12, p. 74.2-75.4 • 93
12, p. 74.11-12 • 5
12, p. 75.5-6 • 133
12, p. 76.1-9 • 81
- Gal.
Plac. Hipp. et Plat.
5.453 • 55
Trem.
7.639-40 • 431
- Gaud.
6, p. 331.27-332.3 • 39
6, p. 332.5-11 • 103
8, p. 337.5-338.7 • 409
15-16, p. 343-4 • 166
16, p. 344.17-24 • 148
19, p. 346.12-347.10 • 387
19, p. 347.10 • 430
21, p. 350.2-9 • 131
21, p. 350.5-9 • 30
21, p. 350.9-11 • 2
22, p. 350.23-352.2 • 301
22, p. 350.23-352.3 • 45
22, p. 351.4-5 • 21
22-3, p. 352-5 • 97
23, p. 352-5 • 30
- Gell.
15.17.1 • 378
- German.
Σ 83.21-84.4 • 81
- Harpocrat.
s.v. ἰων • 378

- [Hdn.]
Epim.
65.3 • 79
- Heliod.
Aeth.
3.2 • 281
- Heraclid. Pont.
ap. Ath.
624c • 4
624c-626a • 430
624f • 431
625a • 431
- Hermesianax
ap. Ath. 598c • 397
- Hesych.
s.v. ἀρμάτειον μέλος • 403
s.v. ἐνδόσιμον • 281
s.v. ἤχεϊον • 69
s.v. κάλαμος / κάλλιμος • 69
s.v. κώδων • 69
s.v. παραπλασιμός • 332
- Hippocr.
De diaeta
1.8 • 422
- Hom.
Od.
21.406-8 • 90
- Hom. Hym.*
4.51 • 113, 440
- Honorius Augustodunensis
De imagine mundi
81-3 • 46
- Iambl.
v. Pythag.
25.112 • 394
- Ioann. Philop.
in de An.
147.18 • 430
355.13-27 • 69
- Ion of Chios
ap. Cleonid. 12, p. 202.14-17 • 61, 87,
105, 283, 373
koinḗ hormasia • 30, 98, 123-32, 139, 166,
177, 211, 223, 251, 277, 304, 321, 368
- Lucian
Ind.
9 • 89
- Lydus
Mens.
2.3, p. 20 • 35
- Mart. Cap.
2.169-99 • 46
2.187 • 105
9.926 • 55
- Nicom.
Ench.
3, p. 242.4-7 • 104
5, p. 244-5 • 82
5, p. 245.14-18 • 86, 104
7, p. 249.2-6 • 160
7, p. 249.15-19 • 104
9, p. 252.16-254.2 • 104
9, p. 252.17-22 • 112, 151
9, p. 252.17-253.3 • 136, 143, 147, 437
10, p. 254.5-13 • 180
10, p. 255.4-17 • 177
11, p. 256.5-11 • 86
11, p. 257.17-20 • 82
11, p. 259.11-13 • 138
11, p. 260.4-12 • 383
11, p. 260.12-17 • 161
12, p. 262-4 • 101
12, p. 263.3-10 • 160
12, p. 263.22-4 • 160
12, p. 264 • 110
- Orib.
Coll. med.
6.10.23 • 22
- Pamphila
ap. Gell., 15.17.1 • 378
- Paus.
3.12.10 • 81
9.12.5 • 378
9.30.2 • 336
- Phaenias
ap. Ath. 352cd • 375
- Pherecrates
ap. [Plut.], Mus.
1141d-1142a • 61, 87, 423
1141ef • 270
1141f • 270
1142a • 22, 73, 269, 432
- Philo
De sacrif. Abelis et Caini
37 • 205
Leg. alleg.
1.14 • 160
3.121 • 95
Migr. Abr.
104 • 160, 281
Plant.
70 • 199

- Quis rer. div. heres*
259 • 69
- Philochorus
ap. Ath.
637–8 • 12, 94
638a • 368, 447
- Philol.
A 26 DK • 144
fr. 6a • 112, 136, 143, 147, 151, 437
fr. 6b • 144
- Philost.
v. Apoll.
5.21 • 337
- Phot.
Bibl.
320a • 81
320b • 449
- Phryn.
Praep. soph.
24.16–25.9 • 59, 199
- Pind.
Nem.
3.79 • 431
Ol.
1.17–18 • 431
1.100–3 • 431
3.4 • 422
14.17 • 422
Pyth.
2.69 • 431
fr. 125 • 430
Σ *Ol.* 10.18b • 430
- Plato
Alc. I
118c • 373
Lach.
188d • 9, 105, 430
193d • 9
Leg.
655a • 447
669c • 447
700d • 282
Min.
318b • 407
Phlb.
17cd • 381
56a • 369
Rep.
398e • 380, 434
399ab • 411
399a–c • 9
399d • 378
- 424c • 422
443d • 133
531a • 152, 383
531a–c • 138
601b • 447
- Symp.*
215c • 407
- Ti.*
35b–36b • 161
36ab • 158
Σ *Alc. I* 118c • 373
Σ *Phaed.* 108d • 138
- Pliny
NH
2.84 • 35, 46
7.56 • 81
13.104–106 • 397
16.172 • 397, 408
- Plut.
Agis
10 • 81
Alex.
8 • 423
An seni
793a • 421
Anim. procr.
1018c–1019a • 136, 144
1020c • 161
1020ef • 152
1021c–1022a • 144
Apophth. Lac.
220c • 81
238c • 35
De cobib. ira
453d • 3
456a • 68
De defectu orac.
436a • 25, 383
De E. ap. Delph.
389a–b • 282
389e • 63, 421
389ef • 24, 383
De prof. in virt.
83f • 429
84a • 81
Gen. Socr.
589d • 431
Lib. educ.
9c • 431
Non posse suaviter vivi
1096a • 412
Pericl.
4.1 • 373

- Plat. quaest.*
1008e • 5, 78, 118
- Quaest. conviv.*
645d • 447
711c • 416
744c • 133
745b • 133
- Reg. et imp. apophth.*
175ab • 431
- Tib. Gracch.*
2.6 • 68
- [Plut.]
- Mus.*
1132d • 7, 382
1132e • 426
1133b • 270
1133d • 426
1133f • 403, 426
1134ab • 5-7, 55, 378, 382
1134c • 426
1134f • 407
1134f-1135a • 175, 394
1134f-1135b • 155
1134f-1135c • 397-8
1135a • 121, 159
1135b • 22, 424
1135c • 424
1135d • 423, 426
1136c • 395
1136de • 372, 394
1136e • 380, 387, 435
1137a • 440
1137a-d • 392
1137b • 105, 159, 402, 416, 436
1137bc • 155
1137b-d • 403, 407
1137c • 257, 394, 407
1137d • 3, 22-3, 27, 35, 73, 411
1137de • 368, 446
1137f • 426, 447
1138b • xvi
1139b-1140a • 112
1140-1 • 104
1140f • 35, 373
1141b • 434
1141c • 81
1141d-1142a • 61, 87, 423
1141ef • 270
1141f • 270
1142a • 22, 73, 269, 432
1142bc • 389, 423
1142c • 425
1142f • 388
1143bc • 403
- 1143c • 381, 421, 425
1145ab • 415
1145b • 160
1145bc • 383
1145d • 140, 142
1145f • 426
- Pollux
4.64 • 270
4.65 • 4, 61, 73, 430-2
4.66 • 270
4.71 • 397
4.80 • 349
4.81 • 93, 407
- Porph.
in Harm.
5.7-15 • 187
23.24-31 • 170
26.20-5 • 194
26.27-27.7 • 11
34.11-16 • 412
56.11-57.27 • 176
63.7-11 • 176, 321
96.29-97.8 • 112, 373
136.23 • 205
152.18-21 • 206
153.16-17 • 63
154.7 • 205
154.19-20 • 63
155.31-156.3 • 207
156.8-10 • 62
157.25 • 205
166.3 • 95
167.21 • 95
- Porphyrion
in Hor. Carm.
4.15.30 • 55
in Hor. Epod.
9.5-6 • 55
- [Probus]
in Verg. Georg.
1.336-7 • 46
- Procl.
in Tim.
35b • 3
191de • 24
191e • 136
- Procl. soph.
ap. Phot., Bibl.
320a • 81
320b • 449

Psell. (?)

Trag.

5 • 270, 350, 433, 440, 446, 450

Ptol.

Harm.

1.1, p. 4.19–22 • 210
 1.4, p. 10.21–8 • 409
 1.5, p. 11.10–12 • 409
 1.6, p. 13.4–5 • 311
 1.7, p. 15.10–17 • 409
 1.8, p. 16–19 • 56
 1.9, p. 20.22–21.8 • 183
 1.10, p. 22.2–16 • 182
 1.10, p. 24.8–21 • 207
 1.10, p. 24.10–17 • 185
 1.12, p. 29–30 • 183
 1.12, p. 30 • 183
 1.13, p. 30.9–31.6 • 171
 1.13, p. 31.2–6 • 178
 1.14, p. 32.1–10 • 172
 1.14, p. 32.4–6 • 217
 1.14, p. 32.23–5 • 202
 1.14, p. 32.23–7 • 199, 204, 217
 1.15, p. 34.13–14 • 186
 1.15, p. 36.20–7 • 203
 1.15, p. 36.28–35 • 204
 1.15, p. 37.5–20 • 195, 202
 1.16, p. 38.2–6 • 202
 1.16, p. 39.3–5 • 199
 1.16, p. 39.6–14 • 77
 1.16, p. 39.7–10 • 108
 1.16, p. 39.11–14 • 58
 1.16, p. 39.12–14 • 198
 1.16, p. 39.12–17 • 212
 1.16, p. 39.12–22 • 239
 1.16, p. 39.13 • 60
 1.16, p. 39.19–22 • 185
 1.16, p. 40.1–6 • 185
 1.16, p. 40.8–13 • 198
 1.16, p. 45.1–2 • 200
 2.1, p. 42.8–10 • 195
 2.1, p. 42.10–11 • 107
 2.1, p. 42.10–12 • 108
 2.1, p. 42.10–43.8 • 207
 2.1, p. 42.11–12 • 63
 2.1, p. 42–5 • 63, 77
 2.1, p. 43.9–12 • 57
 2.1, p. 43.9–18 • 209
 2.1, p. 43.10–11 • 108
 2.1, p. 43.14 • 208
 2.1, p. 43.19–20 • 63, 108, 451
 2.1, p. 43.19–44.5 • 233
 2.1, p. 44.1–2 • 211
 2.1, p. 44.6–7 • 199

2.1, p. 44.6–12 • 239
 2.1, p. 44.13–45.10 • 213
 2.1, p. 44.15–16 • 108
 2.1, p. 45.3–5 • 185
 2.1, p. 45.11–22 • 214
 2.5, p. 51–3 • 107
 2.5, p. 53.17–26 • 387
 2.6, p. 54.7–11 • 5
 2.6, p. 56.3–17 • 5
 2.6, p. 56.4–6 • 5
 2.7, p. 58.7–13 • 70
 2.9, p. 60–2 • 85, 106
 2.10, p. 62.16–63.14 • 100
 2.10, p. 63.6 • 100
 2.10, p. 63.11 • 101
 2.10, p. 63.14–64.15 • 99
 2.11, p. 64.18–65.6 • 66, 69
 2.11, p. 65.3–6 • 72
 2.11, p. 65.10–12 • 102
 2.12, p. 66.6–11 • 190
 2.12, p. 66.11–24 • 170, 194
 2.12, p. 66.19 • 77
 2.12, p. 67.3–10 • 195
 2.12, p. 67.16–20 • 194
 2.13, p. 67.22–4 • 195
 2.13, p. 67.24–68.6 • 188
 2.13, p. 68.2–3 • 126
 2.13, p. 68.5–6 • 190
 2.13, p. 68.15–19 • 189
 2.13, p. 68.16 • 194
 2.13, p. 68.27–9 • 188
 2.13, p. 68.30 • 199, 204
 2.13, p. 68.30–2 • 218
 2.13, p. 68.32–69.8 • 170, 194
 2.13, p. 69.24–9 • 185
 2.13, p. 69.29–70.4 • 183
 2.15, p. 74–80 • 77
 2.15, p. 75.1–6 • 78
 2.15–16, p. 76–80.18 • 108
 2.16, p. 80 • 57
 2.16, p. 80.8–10 • 109
 2.16, p. 80.8–18 • 77
 2.16, p. 81.5–21 • 131
 3.1, p. 83.7–9 • 77
 3.12, p. 106–7 • 100
 3.14, p. 82.28–30 • 166

Inscr. Can.

154.1–155.2 • 166

Ptolemaïis

ap. Porph., in Harm.

23.24–31 • 170

Quint.

Inst.

1.10.1–33 • 134

- 1.10.27 • 68
1.10.32-3 • 394
12.10.68 • 133
- Sect. can.*
1, p. 149.14-16 • 143
9, p. 157.5-158.7 • 146
15, p. 161.4-16 • 145
17, p. 162.1-12 • 24
17-18, p. 162-3 • 159
17-20, p. 162-6 • 190
19, p. 163.15-165.2 • 6
19, p. 163.17-164.2 • 126
19, p. 163.18-164.2 • 333
19, p. 164.2-3 • 22
19-20, p. 163-6 • 126
20, p. 166-7 • 166
- Servius
Georg.
2.193 • 408
- Sext. Emp.
adv. Math.
6.8 • 394
6.47 • 25
6.51 • 25
- Soph.
Oedip. Col.
483-4 • 147
- St. Byz.
s.v. Πιερία • 81
- Stob.
4.19.46 • 431
4.22.101 • 69
- Strab.
13.2.4 • 440
- Suda*
s.v. βασιτάσας • 422
s.v. ἐνδόσιμον • 281
s.v. λωτός • 397
s.v. μουσουργοί • 281
s.v. Σιμωνίδης • 81
s.v. Φιλόξενος • 270
s.v. χιάζειν • 73
- Synes., *Ep.*
95, p. 161.9-13 • 80, 87
- Telestes
ap. Ath.
617b • 429
- Themistius
Or.
336a • 430
364b • 426
- Theocr.
Σ 2.35/36b • 69
- Theon
Util. math.
48.15 • 95
48.15-16 • 22
48.16-49.5 • 409
51 • 86
55.11-15 • 136, 163
56.1-3 • 417, 421
56.18-19 • 136
59.4-21 • 138
64.1-4 • 3
65.10-66.11 • 180
66.24-67.4 • 206
68.12-69.12 • 161
70.17-19 • 151
87.9-18 • 180
88.13-15 • 119
88.17-92.19 • 22
89.16-23 • 95
89.18 • 119
91.8-92.16 • 136
91.23-4 • 138
91-2 • 110, 148
91-3 • 159
92.1 • 138
92.8 • 138
92.23 • 95
92.27-93.2 • 159
138-41 • 46
- Theophr.
ap. Porph., in Harm.
63.7-11 • 176, 321
- Thrasylus
ap. Theon, Util. math.
87.9-18 • 180
88.13-15 • 119
88.17-92.19 • 22
89.18 • 119
91.23-4 • 138
91-2 • 110
91-3 • 159
92.1-2 • 138
92.8-9 • 138
92.27-93.2 • 159
- Tim. Locr.
209-13 • 161
211.5-12 • 163
211.6-12 • 163
212.7-8 • 163
213.2-15 • 163

Timoth.

*Pers.*203 • 111
229-31 • 283

Varro

Ling. lat.

10.46 • 104

fr. 282 Funaioli • 432

Vitruv.

5.3 • 69
5.5 • 69, 251-2
5.5.6 • 3

MANUSCRIPTS

KAR 158 • 106*Nabnitu*

32.1 • 106

Neap. III C 2

fol. 45 • 124

Ottob. gr. 59

fol. 31v • 132

Pal. 281

fol. 173r • 124, 132
fol. 173v • 65, 98

Pap. Berlin 13057 • 93, 203

Pap. Hibeh 13

i.3-4 • 371
i.16 • 447
ii.3-4 • 446

Vat. 192

fol. 222r • 22, 110, 139
fol. 224r • 101, 136, 169
fol. 224v • 139
fol. 225 • 98

INSCRIPTIONS

Agora, Fétiche Tzami inv. 91A • 256

CIL 4.2305 • 256

Eleusis inv. 907 • 256

FdD III

I, 49.2-4 • 450

Laurion inv. 90 • 256

Paris, Bibliothèque Nationale

cat. 272 • 256

inv. 2985 • 256

*SEG*30.382 • 133, 287
30.390 • *see* Musical Documents,
DAGM N^o 19*SIG* 648B • 303

Volos inv. E-927 • 256

MUSICAL DOCUMENTS

DAGM N^o

1 • 256

3 • 19-22, 30, 36-8, 256-7, 258, 276, 284,
325, 330, 344, 350, 356, 389-90, 404-5,
411, 445

4 • 257-8

5 • 39, 258-71, 325, 343-5, 349

6 • 39-40, 258-71, 273-5, 325, 343-5,
349, 354-6

7 • 39, 271-2, 280, 344-5, 349

- 8 • 39, 272-3, 345, 349, 354
 9 • 39-41, 75, 262, 273, 275, 325
 10 • 275, 343, 354
 11 • 276, 284, 325, 350, 356
 12 • 236, 280, 356
 14 • 343
 15 • 276, 325, 343-51
 16 • 276, 343
 17 • 72, 93, 225, 277-80, 305, 308
 18 • 72, 277-80, 308, 317, 357
 19 • 280-1, 308, 325, 355
 20 • 20, 26, 35, 40, 44, 54, 74, 159, 258-9, 263-75, 278, 281-3, 285, 294, 325, 345, 349-50, 354-5, 397, 407, 438-9, 447
 21 • 2, 20, 30, 40, 54-5, 74, 96, 198, 236, 259, 283-5, 294, 299, 325, 338, 350, 354-6, 407, 438-9
 22 • 75, 280, 344, 356
 23 • 286, 287-8, 294, 356
 24 • 236, 287-8, 325, 344
 25 • 236, 287, 288, 325, 334, 344, 356
 26 • 334
 27 • 87, 236-7, 287, 288-9, 317, 325, 344, 438
 28 • 80, 87, 236, 289-90, 325
 29-31 • 132
 32 • 337
 32-7 • 226, 290-2, 334-5
 33-7 • 325
 35 • 336
 36 • 337
 37 • 336
 38 • 200, 236, 293, 314, 325
 39 • 293-9, 300-2, 317, 357-60
 40 • 200, 236, 299-300, 314, 325, 359
 41 • 4, 74, 300-2, 305, 345, 358-60
 42 • 302-3, 314-15, 318, 325
 43 • 303-4, 325
 44 • 304-5, 318, 325
 45 • 305-6, 315-17, 325, 359
 46 • 306-7, 318, 325
 47 • 307, 358-9
 48 • 307-8, 325, 355
 49 • 308, 315
 50 • 287, 308-9, 317-18, 325, 334
 51 • 284, 287, 309-11, 325, 334, 338, 356-9
 52 • 284, 310, 311-12, 318, 338, 356-7, 360
 53 • 312-13, 325, 358-9
 54 • 313, 358-9
 55 • 236, 313-14, 325
 56 • 236, 314-16
 57 • 316-17
 58 • 317, 357-8
 59 • 318, 325
 60 • 318, 360
 61 • 96, 236, 284, 319-23, 325, 334-5, 338-42, 354
 DAM[№]
 6 • 30, 98, 123-32, 139, 166, 177, 211, 223, 251, 277, 304, 321, 368
 13-17 • 256
 Pap. Louvre E10534 • 323-4, 358
 Pap. Oxy. 4710 • 315, 324

PERSONAL NAMES

- Aeschylus 390
 Agathocles 373
 Agathon 269, 433
 Alcibiades 378, 422
 Alcman 425
 Alypius 1, 9, 21, 30, 48, 51, 97, 301, 367
 Antigenidas 378
 Archestratus 11
 Archytas 24, 28, 52, 146-51, 169-82, 188, 194, 217, 373, 382, 388, 413, 446-9
 Aristophanes 271
 Aristotle 3, 9, 112, 117-18, 121, 152, 416, 429
 Aristoxenus xvi, 3-8, 11-20, 23-5, 33, 40-1, 44-9, 57, 71, 93, 97, 101, 105-6, 115-16, 136, 139-42, 146-8, 151-9, 172-8, 182-8, 199, 202, 206-7, 212, 217, 233, 237, 258-65, 268, 279, 292, 327, 336, 346, 355, 366-8, 371-91, 394, 397-437, 440-1, 444-8
 Boethius 51, 80-7, 92, 98-101, 112-14, 143-6, 149-50, 160, 164-6, 376, 428, 452
 Carcinus 323
 Cinesias 270
 Crantor 161

- Damon 34, 373, 380, 434
- Didymus 126, 187–95, 204, 218, 221–4, 228, 450
- Diodorus of Thebes 349
- Eratocleans 373–9, 384–91, 417, 427–8, 431
- Eratocles 373–6, 387, 430, 435
- Eratosthenes 161–3, 182–8, 192, 201
- Euphranor 176
- Euripides 19, 257–8, 350, 389, 397
- Glaucus of Rhegium 426, 432
- Heraclides 4, 49, 61, 430–3
- Hippasus 138
- Hyagnis 81
- Ion of Chios 87, 283, 373, 377
- Lamprocles 372–4, 381, 394
- Lasus 138, 431, 434
- Lysander of Sicyon 368
- Marsyas 335
- Melanippides 270
- Mesomedes 80, 87, 132, 236–7, 287–9, 308, 344, 438
- mousikoi* 158, 175, 398–9, 403–6, 409, 436, 440
- Nicomachus 80–7, 100–1, 105, 114, 144, 149, 160–6
- Olympus 54, 398, 402–4, 416–17, 437, 440
- Orpheus 81–2
- Philololaus 105, 112–14, 133, 143–52, 158–60, 164, 168, 176, 236, 373, 437, 448
- Philoxenides 73
- Philoxenus 61, 270, 378, 388–9, 423–4, 433, 447
- Phrynis 81, 270, 325, 379
- Pindar 54, 390, 418, 422–6, 431, 434
- Plato 9, 18, 28, 85, 146, 158, 161–4, 175, 182, 185, 282, 373, 378–80, 383, 388–90, 413, 430, 434, 447–9
- Polymnestus 425, 434
- Porphyry 61–8, 92, 187, 205–6, 229, 298
- Pratinas 423
- Proclus 468
- Pronomus 378, 382, 389, 393, 417, 428, 444
- Ptolemy 3–6, 24, 37, 42, 56–80, 85–7, 90–6, 99–119, 122–4, 128, 131–4, 142, 146, 166–72, 177–9, 182–234, 238–51, 255, 262, 281, 286–90, 293–4, 298, 302–14, 317–18, 325–7, 335, 355, 368, 376, 387, 400, 409, 428–30, 446, 450–1
- Pythagoras 81–6, 160, 170, 373, 378, 430
- Pythagoras of Zacynthus 373, 378, 430
- Pythocles 372–3, 394
- Sacadas 425
- Sappho 372–3
- Satyros 303
- Simonides 81, 426
- Socrates 19
- Stesichorus 403, 425
- Stratoniceus 375–7, 388–90
- Synesius 80
- Telestes 378, 389, 423, 429
- Terpander 35, 54, 58, 80–3, 94, 105, 114, 287, 373, 425, 437, 440–2
- Thaletas 425
- Theoxenides 73
- Timotheus 22, 77, 81–5, 112, 269–70, 283, 325, 378, 389, 423
- Xenocritus 430